

# Pioneer

Operating Instructions



BONUS *VIEW*™

**HDMI**

Blu-ray Disc PLAYER

BDP-51 FD

Thank you for buying this Pioneer product.  
Please read through these operating instructions so you will know how to operate your model properly.  
After you have finished reading the instructions, put them away in a safe place for future reference.

## IMPORTANT



The lightning flash with arrowhead symbol, within an equilateral triangle, is intended to alert the user to the presence of uninsulated "dangerous voltage" within the product's enclosure that may be of sufficient magnitude to constitute a risk of electric shock to persons.

### CAUTION

**RISK OF ELECTRIC SHOCK  
DO NOT OPEN**

**CAUTION:**  
TO PREVENT THE RISK OF ELECTRIC SHOCK, DO NOT REMOVE COVER (OR BACK). NO USER-SERVICEABLE PARTS INSIDE. REFER SERVICING TO QUALIFIED SERVICE PERSONNEL.



The exclamation point within an equilateral triangle is intended to alert the user to the presence of important operating and maintenance (servicing) instructions in the literature accompanying the appliance.

D3-4-2-1-1\_En-A

**IMPORTANT NOTICE** – THE SERIAL NUMBER FOR THIS EQUIPMENT IS LOCATED IN THE REAR. PLEASE WRITE THIS SERIAL NUMBER ON YOUR ENCLOSED WARRANTY CARD AND KEEP IN A SECURE AREA. THIS IS FOR YOUR SECURITY.

D1-4-2-6-1\_En

**NOTE:** This equipment has been tested and found to comply with the limits for a Class B digital device, pursuant to Part 15 of the FCC Rules. These limits are designed to provide reasonable protection against harmful interference in a residential installation. This equipment generates, uses, and can radiate radio frequency energy and, if not installed and used in accordance with the instructions, may cause harmful interference to radio communications. However, there is no guarantee that interference will not occur in a particular installation. If this equipment does cause harmful interference to radio or television reception, which can be determined by turning the equipment off and on, the user is encouraged to try to correct the interference by one or more of the following measures:

- Reorient or relocate the receiving antenna.
- Increase the separation between the equipment and receiver.
- Connect the equipment into an outlet on a circuit different from that to which the receiver is connected.
- Consult the dealer or an experienced radio/TV technician for help.

D8-10-1-2\_En

### Information to User

Alterations or modifications carried out without appropriate authorization may invalidate the user's right to operate the equipment.

D8-10-2\_A\_En

This Class B digital apparatus complies with Canadian ICES-003.

Cet appareil numérique de la Classe B est conforme à la norme NMB-003 du Canada.

D8-10-1-3\_EF

**CAUTION:** This product satisfies FCC regulations when shielded cables and connectors are used to connect the unit to other equipment. To prevent electromagnetic interference with electric appliances such as radios and televisions, use shielded cables and connectors for connections.

D8-10-3a\_En

**CAUTION :** USE OF CONTROLS OR ADJUSTMENTS OR PERFORMANCE OF PROCEDURES OTHER THAN THOSE SPECIFIED HEREIN MAY RESULT IN HAZARDOUS RADIATION EXPOSURE.

**CAUTION :** THE USE OF OPTICAL INSTRUMENTS WITH THIS PRODUCT WILL INCREASE EYE HAZARD. D6-8-2-1\_En

# IMPORTANT SAFETY INSTRUCTIONS

- 1) Read these instructions.
- 2) Keep these instructions.
- 3) Heed all warnings.
- 4) Follow all instructions.
- 5) Do not use this apparatus near water.
- 6) Clean only with dry cloth.
- 7) Do not block any ventilation openings. Install in accordance with the manufacturer's instructions.
- 8) Do not install near any heat sources such as radiators, heat registers, stoves, or other apparatus (including amplifiers) that produce heat.
- 9) Do not defeat the safety purpose of the polarized or grounding-type plug. A polarized plug has two blades with one wider than the other. A grounding type plug has two blades and a third grounding prong. The wide blade or the third prong are provided for your safety. If the provided plug does not fit into your outlet, consult an electrician for replacement of the obsolete outlet.
- 10) Protect the power cord from being walked on or pinched particularly at plugs, convenience receptacles, and the point where they exit from the apparatus.
- 11) Only use attachments/accessories specified by the manufacturer.
- 12) Use only with the cart, stand, tripod, bracket, or table specified by the manufacturer, or sold with the apparatus. When a cart is used, use caution when moving the cart/apparatus combination to avoid injury from tip-over.



- 13) Unplug this apparatus during lightning storms or when unused for long periods of time.
- 14) Refer all servicing to qualified service personnel. Servicing is required when the apparatus has been damaged in any way, such as power-supply cord or plug is damaged, liquid has been spilled or objects have fallen into the apparatus, the apparatus has been exposed to rain or moisture, does not operate normally, or has been dropped.

## CAUTION

This product is a class 1 laser product, but this product contains a laser diode higher than Class 1. To ensure continued safety, do not remove any covers or attempt to gain access to the inside of the product. Refer all servicing to qualified personnel.



The following caution label appears on your unit.  
Location: inside of the unit



D3-4-2-1-8\_B\_En

## WARNING

To prevent a fire hazard, do not place any naked flame sources (such as a lighted candle) on the equipment.

D3-4-2-1-7a\_A\_En

## Operating Environment

Operating environment temperature and humidity: +5 °C to +35 °C (+41 °F to +95 °F); less than 85 %RH (cooling vents not blocked)

Do not install this unit in a poorly ventilated area, or in locations exposed to high humidity or direct sunlight (or strong artificial light)

D3-4-2-1-7c\_A\_En

## VENTILATION CAUTION

When installing this unit, make sure to leave space around the unit for ventilation to improve heat radiation (at least 10 cm at top, 10 cm at rear, and 10 cm at each side).

## WARNING

Slots and openings in the cabinet are provided for ventilation to ensure reliable operation of the product, and to protect it from overheating. To prevent fire hazard, the openings should never be blocked or covered with items (such as newspapers, table-cloths, curtains) or by operating the equipment on thick carpet or a bed.

D3-4-2-1-7b\_A\_En

## WARNING

This equipment is not waterproof. To prevent a fire or shock hazard, do not place any container filled with liquid near this equipment (such as a vase or flower pot) or expose it to dripping, splashing, rain or moisture.

D3-4-2-1-3\_B\_En

## WARNING

Before plugging in for the first time, read the following section carefully.

The voltage of the available power supply differs according to country or region. Be sure that the power supply voltage of the area where this unit will be used meets the required voltage (e.g., 230 V or 120 V) written on the rear panel.

D3-4-2-1-4\_A\_En

If the AC plug of this unit does not match the AC outlet you want to use, the plug must be removed and appropriate one fitted. Replacement and mounting of an AC plug on the power supply cord of this unit should be performed only by qualified service personnel. If connected to an AC outlet, the cut-off plug can cause severe electrical shock. Make sure it is properly disposed of after removal. The equipment should be disconnected by removing the mains plug from the wall socket when left unused for a long period of time (for example, when on vacation).

D3-4-2-1a\_A\_En

#### CAUTION

The  STANDBY/ON switch on this unit will not completely shut off all power from the AC outlet. Since the power cord serves as the main disconnect device for the unit, you will need to unplug it from the AC outlet to shut down all power. Therefore, make sure the unit has been installed so that the power cord can be easily unplugged from the AC outlet in case of an accident. To avoid fire hazard, the power cord should also be unplugged from the AC outlet when left unused for a long period of time (for example, when on vacation).

D3-4-2-2a\_A\_En

**WARNING:** Handling the cord on this product or cords associated with accessories sold with the product will expose you to chemicals listed on proposition 65 known to the State of California and other governmental entities to cause cancer and birth defect or other reproductive harm.

***Wash hands after handling***

D36-P4\_A\_En

This product contains mercury. Disposal of this material may be regulated due to environmental considerations. For disposal or recycling information, please contact your local authorities or the Electronics Industries Alliance : [www.eiae.org](http://www.eiae.org).

K057\_En

This product is for general household purposes. Any failure due to use for other than household purposes (such as long-term use for business purposes in a restaurant or use in a car or ship) and which requires repair will be charged for even during the warranty period.

K041\_En

#### POWER-CORD CAUTION

Handle the power cord by the plug. Do not pull out the plug by tugging the cord and never touch the power cord when your hands are wet as this could cause a short circuit or electric shock. Do not place the unit, a piece of furniture, etc., on the power cord, or pinch the cord. Never make a knot in the cord or tie it with other cords. The power cords should be routed such that they are not likely to be stepped on. A damaged power cord can cause a fire or give you an electrical shock. Check the power cord once in a while. If you find it damaged, contact the Pioneer service center on the back cover, or your dealer for a replacement.

This product incorporates copyright protection technology that is protected by method claims of certain U.S. patents and other intellectual property rights owned by Macrovision Corporation and other rights owners. Use of this copyright protection technology must be authorized by Macrovision Corporation, and is intended for home and other limited viewing uses only unless otherwise authorized by Macrovision Corporation. Reverse engineering or disassembly is prohibited.







## We Want You Listening For A Lifetime

Since hearing damage from loud noise is often undetectable until it is too late, this manufacturer and the Electronic Industries Association's Consumer Electronics Group recommend you avoid prolonged exposure to excessive noise. This list of sound levels is included for your protection.

### Dear Customer:

Selecting fine audio equipment such as the unit you've just purchased is only the start of your musical enjoyment. Now it's time to consider how you can maximize the fun and excitement your equipment offers. This manufacturer and the Electronic Industries Association's Consumer Electronics Group want you to get the most out of your equipment by playing it at a safe level. One that lets the sound come through loud and clear without annoying blaring or distortion-and, most importantly, without affecting your sensitive hearing.

Sound can be deceiving. Over time your hearing "comfort level" adapts to higher volumes of sound. So what sounds "normal" can actually be loud and harmful to your hearing. Guard against this by setting your equipment at a safe level BEFORE your hearing adapts.

#### To establish a safe level:

- Start your volume control at a low setting.
- Slowly increase the sound until you can hear it comfortably and clearly, and without distortion.

#### Once you have established a comfortable sound level:

- Set the dial and leave it there.

Taking a minute to do this now will help to prevent hearing damage or loss in the future. After all, we want you listening for a lifetime.

#### Decibel Level Example

30	Quiet library, soft whispers
40	Living room, refrigerator, bedroom away from traffic
50	Light traffic, normal conversation, quiet office
60	Air conditioner at 20 feet, sewing machine
70	Vacuum cleaner, hair dryer, noisy restaurant
80	Average city traffic, garbage disposals, alarm clock at two feet.

#### THE FOLLOWING NOISES CAN BE DANGEROUS UNDER CONSTANT EXPOSURE

90	Subway, motorcycle, truck traffic, lawn mower
100	Garbage truck, chain saw, pneumatic drill
120	Rock band concert in front of speakers, thunderclap
140	Gunshot blast, jet plane
180	Rocket launching pad

Information courtesy of the Deafness Research Foundation.



S001\_En

# Contents

## 01 Before you start

What's in the box . . . . .	7
Putting the batteries in the remote control . . . . .	7
Types of discs/files that can be played . . . . .	8
Playable discs . . . . .	8
Playable files . . . . .	10
Part Names and Functions . . . . .	11
Remote Control . . . . .	11
Front Panel . . . . .	12
Front Panel Display . . . . .	13
Rear Panel . . . . .	13

## 02 Connecting up

Connecting a TV . . . . .	14
Connecting using a commercially available HDMI cable . . . . .	14
Connecting using a commercially available component video cable . . . . .	16
Connecting using the included audio cable and video cable . . . . .	16
Connecting an AV receiver or amplifier . . . . .	17
Connecting using a commercially available HDMI cable . . . . .	17
Connecting using audio cables . . . . .	18
Connecting using a commercially available digital audio cable . . . . .	18
Connecting the power cord . . . . .	19

## 03 Getting Started

Making settings using the Setup Navigator menu . . . . .	20
Operating the TV with the player's remote control . . . . .	22
TV Preset code list . . . . .	22
Using the TOOLS menu . . . . .	23
Erasing the additional data from BD-ROMs . . . . .	24
Switching the video output terminal . . . . .	24
Switching the output video resolution . . . . .	25

## 04 Playback

Playing discs or files . . . . .	26
Forward and reverse scanning . . . . .	26
Playing specific titles, chapters or tracks . . . . .	27
Skipping content . . . . .	27
Playing in slow motion . . . . .	27
Step forward and step reverse . . . . .	27
Switching the camera angles . . . . .	28
Switching the subtitles . . . . .	28
Switching the audio streams/channels . . . . .	28
Switching the secondary video . . . . .	29
Displaying the disc information . . . . .	29
Using the Play Mode functions . . . . .	29
Playing from a specific time (Time Search) . . . . .	29
Playing a specific title, chapter or track (Search) . . . . .	30
Playing a specific section within a title or track repeatedly (A-B Repeat) . . . . .	31
Playing repeatedly (Repeat Play) . . . . .	31
Playing in random order (Random Play) . . . . .	32
About Play Mode types . . . . .	33
Playing from the Home Media Gallery . . . . .	34
Playing discs . . . . .	34
Playing music files . . . . .	34
Playing in the desired order (HMG Playlist) . . . . .	35

## 05 Adjusting audio and video

Adjusting the video . . . . .	37
Adjusting the Audio DRC . . . . .	38

## 06 Advanced settings

Changing the settings (Initial Setup) . . . . .	39
Operating the Initial Setup screen . . . . .	39
Changing to other language at language setting . . . . .	43
Changing the speaker setup . . . . .	43
Adjusting the output level of the various speakers (Channel Level) . . . . .	44
Registering or Changing the password . . . . .	44
Changing the Age Restriction for watching BD-ROMs . . . . .	45
Changing the Parental Lock level for watching DVDs . . . . .	46
Changing the Country/Area code . . . . .	47
Changing the terminals for outputting video and audio signals (Output Terminal Priority) . . . . .	48
Restoring all the settings to the factory default settings . . . . .	49
About the audio output settings . . . . .	50

## 07 Additional information

Troubleshooting . . . . .	51
Playback . . . . .	51
When connected using an HDMI cable . . . . .	53
Others . . . . .	55
Language Code Table and Country/Area Code Table . . . . .	56
Language Code Table . . . . .	56
Country/Area Code Table . . . . .	56
Specifications . . . . .	57
Cautions on use . . . . .	58
Place of installation . . . . .	58
Turn the power off when not using the player . . . . .	58
Condensation . . . . .	58
Cleaning the player . . . . .	58
Cleaning the pickup lens . . . . .	58
Handling discs . . . . .	59
Glossary . . . . .	59
Licenses . . . . .	62

# Chapter 1 Before you start

## What's in the box

Remote control x 1

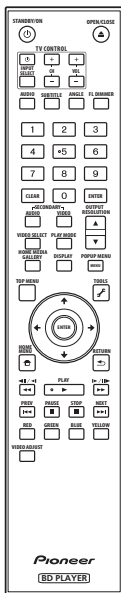

Audio cable (white/red plugs) x 1

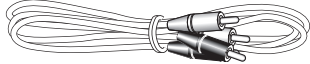

Video cable (yellow plugs) x 1

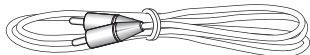

Power cable x 1

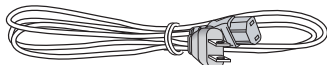

AA/R6 dry cell batteries x 2

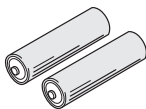

Warranty card

Operating instructions (this manual)

### 3 Close the rear cover.

Close securely (a click should be heard).

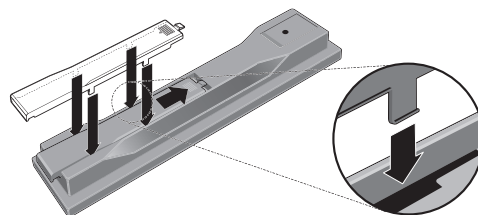

#### Caution

- Do not mix new and old batteries together.
- Batteries may have different voltages, even if they look similar. Do not use different kinds of batteries together.
- To prevent leakage of battery fluid, remove the batteries if you do not plan to use the remote control for a long period of time (1 month or more). If the fluid should leak, wipe it carefully off the inside of the case, then insert new batteries.
- When disposing of used batteries, please comply with governmental regulations or environmental public instruction's rules that apply in your country/area.

#### **WARNING**

Do not use or store batteries in direct sunlight or other excessively hot place, such as inside a car or near a heater. This can cause batteries to leak, overheat, explode or catch fire. It can also reduce the life or performance of batteries.

D3-4-2-3-3\_En

## Putting the batteries in the remote control

### 1 Open the rear cover.

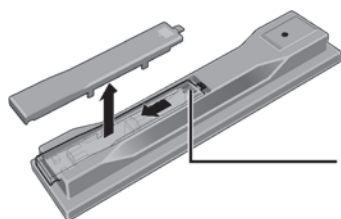

Press lightly on this part and slide into the direction of the arrow.

### 2 Insert the batteries (AA/R6 x 2).

Insert as indicated by the ⊕/⊖ marks into the battery compartment.



Insert the negative (⊖) side first.

# 01 Types of discs/files that can be played

## Playable discs

Discs with the logo marks below indicated on the disc label, package or jacket can be played.

Disc type	Logo	Application format						
		BDMV <sup>1</sup>	BDAV	DVD-Video	DVD VR	CD-DA DTS-CD	DATA-DISC <sup>2</sup>	
BD	BD-ROM		✓	✓	✗	✗	✗	✗
	BD-R		✓	✓	✗	✗	✗	✗
	BD-RE		✓	✓	✗	✗	✗	✗
DVD	DVD-ROM		✓	✗	✓	✗	✗	✓
								
	DVD-R		✓	✗	✓	✓	✗	✓
	DVD-R DL (Dual Layer)		✓	✗	✓	✓	✗	✓
	DVD-RW		✓	✗	✓	✓	✗	✓
	DVD+R		✓	✗	✓	✗	✗	✓
	DVD+RW		✓	✗	✓	✗	✗	✓
CD	CD-DA (Music CD)		✗	✗	✗	✗	✓	✗
	CD-R		✗	✗	✗	✗	✓	✓
	CD-RW		✗	✗	✗	✗	✓	✓
	CD-ROM		✗	✗	✗	✗	✓	✓

1. Including the AVCHD format.

2. Discs on which music files are recorded

### ❖ Discs that cannot be played

- HD DVDs
- DVD Audio discs
- DVD-RAM discs
- Non-finalized DVD-R/DVD-RW/DVD+R/DVD+RW discs in the DVD-Video format and AVCHD format
- Non-finalized Dual Layer DVD-R discs in the DVD VR format

- SACDs
- Video CDs

This player conforms to NTSC standards. Discs for which "NTSC" is indicated on the disc label, package or jacket can be played.

"Blu-ray Disc" and  are trademarks.

 is a trademark of DVD Format/Logo Licensing Corporation.

 **Note**

- Some discs cannot be played, even if one of the above logo marks is indicated.
- To play 8 cm discs, set the disc in the 8 cm disc depression in the center of the disc tray. No adapter is necessary. 8 cm BD-ROM discs cannot be played.

### ❖ About audio formats

The following audio formats are supported on this player:

- Dolby TrueHD
- Dolby Digital Plus
- Dolby Digital
- DTS-HD Master Audio
- DTS-HD High Resolution Audio
- DTS Digital Surround
- MPEG
- MPEG-2 AAC
- Linear PCM

To enjoy the surround sound of Dolby TrueHD, Dolby Digital Plus, DTS-HD Master Audio and DTS-HD High Resolution Audio, it is recommended to connect the player to an AV receiver or amplifier compatible with these audio formats using an HDMI cable. After loading a BD containing sound in one of these audio formats, select the audio format on the menu screen.

See *About the audio output settings* on page 50 for the output conditions of the different formats.



*Manufactured under license from Dolby Laboratories. Dolby and the double-D symbol are trademarks of Dolby Laboratories.*



*Manufactured under license under U.S. Patent #: 5,451,942; 5,956,674; 5,974,380; 5,978,762; 6,487,535 & other U.S. and worldwide patents issued & pending. DTS is a registered trademark and the DTS logos, Symbol, DTS-HD and DTS-HD Advanced Digital Out are trademarks of DTS, Inc. © 1996-2007 DTS, Inc. All Rights Reserved.*

### ❖ Playing BDs

- BDs (BDMV) compatible with the formats below can be played.
  - Blu-ray Disc Read-Only (ROM) Format Version 2
  - Blu-ray Disc Recordable (R) Format Version 2
  - Blu-ray Disc Rewritable (RE) Format Version 3

This player supports BD-ROM Profile 1 Version 1.1. BONUSVIEW Functions such as playback of secondary video (Picture-in-Picture) and secondary audio can be used. For details on secondary video and secondary audio playback, refer to the disc's instructions.

## BONUS VIEW™

*"BONUSVIEW" is trademark of Blu-ray Disc Association.*

When a BD-ROM is played, additional data may be stored in the player's memory area (local storage). If the message indicating low memory (local storage) appears, erase the BDMV data (page 24).

- BDs (BD-RE) compatible with the formats below can be played.
  - Blu-ray Disc Recordable (R) Format Version 1
  - Blu-ray Disc Rewritable (RE) Format Version 2
- Dual Layer BDs can be played.
- Music files recorded on BDs cannot be played.
- 8 cm BD-ROM discs cannot be played.

### ❖ Playing DVDs

- DVD-Video can be played.
- DVD-R/-RW/+R/+RW discs recorded in the DVD-Video format can be played (finalize them before playing them on this player).
- DVD-R/-RW discs recorded in the VR format (Video Recording format) can be played.
- This label indicates playback compatibility with DVD-RW discs recorded in VR mode (Video Recording format). However, for discs recorded with a record-only-once encrypted program, playback can only be achieved using a CPRM compatible device.



- DVDs recorded in the AVCHD format can be played (finalize them before playing them on this player).



*"AVCHD" and the "AVCHD" logo are trademarks of Matsushita Electric Industrial Co., Ltd. and Sony Corporation.*

- Music files recorded on DVD-R/-RW/+R/+RW discs can be played. See *Playable files* on page 10.
- Dual Layer DVDs can be played. However, Non-finalized Dual Layer DVD-R discs recorded in the VR format cannot be played. (Finalize them before playing them on this player.)
- HD DVD, DVD Audio and DVD-RAM discs cannot be played.

## ❖ About region numbers

Blu-ray Disc Player and BD-ROM or DVD-Video discs are assigned region numbers according to the region in which they are sold.

This player's region numbers are:

- BD-ROM: A
- DVD-Video: 1

Discs not including these numbers cannot be played. Discs playable on this player are as shown below.

- BDs: A (including A) and ALL



- DVDs: 1 (including 1) and ALL



## ❖ Playing CDs

- CD-DA/DTS-CDs (music CDs) can be played.
- Music files recorded on CDs can be played. See *Playable files* on page 10.
- SACD, Video CD and Super VCD discs cannot be played.
- Regarding copy protected CDs: This product is designed to conform to the specifications of the Audio CD format. This player does not support the playback or function of discs that do not conform to these specifications.

## ❖ DualDisc playback

A DualDisc is a new two-sided disc, one side of which contains DVD content — video, audio, etc. — while the other side contains non-DVD content such as digital audio material.

The DVD side of a DualDisc will be played on this player (excluding any DVD-Audio content).

The non-DVD, audio side of the disc is not compatible with this player.

It is possible that when loading or ejecting a DualDisc, the opposite side to that being played will be scratched. Scratched discs may not be playable.

For more detailed information on the DualDisc specification, please refer to the disc manufacturer or disc retailer.

## ❖ Playing discs created on computers

- It may not be possible to play DVD-R/-RW or CD-R/-RW discs recorded using a personal recorder or computer. (This can be due to various reasons, including disc properties, scratches, dirt on the disc, dirt on the player's lens, condensation and so on.)
- It may not be possible to play discs recorded using a computer due to the application settings or environment. Record discs in the proper format. For details, contact the dealer.

## Playable files

Music files recorded on DVDs and CDs can be played.



### Caution

- In DVD, only the one recorded by the ISO9660 file system can be played.

- Some files may not be playable.
- For some files, it may not be possible to use certain functions during playback.
- It may not be possible to play some files, even if they have the extension of a file playable on this player.
- Files protected by DRM (Digital Rights Management) cannot be played.

## ❖ Supported music file formats

### • Windows Media™ Audio 9 (WMA9)

Bit rate: Up to 192 kbps

Sampling frequencies: 22.05 kHz, 32 kHz, 44.1 kHz and 48 kHz

### • MPEG-1 Audio Layer 3 (MP3)

Bit rate: Up to 320 kbps

Sampling frequencies: 8 kHz, 11.025 kHz, 12 kHz, 16 kHz, 22.05 kHz, 24 kHz, 32 kHz, 44.1 kHz and 48 kHz

## ❖ Playable file extensions

### • Music files

.wma and .mp3

- *Windows Media is either a registered trademark or trademark of Microsoft Corporation in the United States and/or other countries.*
- *This product includes technology owned by Microsoft Corporation and cannot be used or distributed without a license from Microsoft Licensing, Inc.*

# Part Names and Functions

## Remote Control

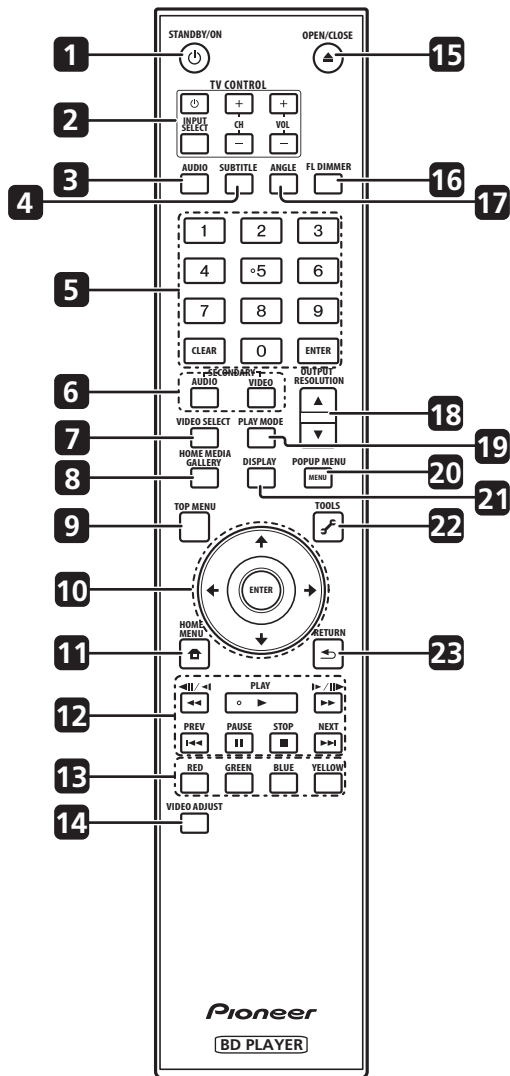

### 1 **STANDBY/ON**

Press to turn the power on and off.

### 2 **TV CONTROL**

Your TV can be controlled using the player's remote control (page 22).

**STANDBY/ON** – Press to turn the TV's power on and off.

**INPUT SELECT** – Press to switch the TV's input.

**CH +/-** – Press to select the TV channel.

**VOL +/-** – Press to adjust the volume.

### 3 **AUDIO**

Press to switch the audio streams/channels (page 28).

### 4 **SUBTITLE**

Press to switch the subtitles (page 28).

**5 Number buttons** – Use these to select and play the title/ chapter/track you want to watch or listen to and to select items from menus.

**CLEAR** – Press to clear the numeric number, etc.

**ENTER** – Press to execute the selected item or enter a setting that has been changed, etc.

**6 SECONDARY AUDIO** – When playing a BD-ROM on which secondary audio is recorded, press to switch to the secondary audio (page 28).

**SECONDARY VIDEO** – When playing a BD-ROM on which secondary video (Picture-in-Picture) is recorded, press to switch to the secondary video (page 29).

### 7 **VIDEO SELECT**

Press to switch the terminal from which the video signals are output. Use to switch between digital output (HDMI output) and analog output (Component Video output, S-Video output or Video output) (**the signals are only output from the selected video output terminal**) (page 24).

### 8 **HOME MEDIA GALLERY**

Press to display/hide the Home Media Gallery screen (page 34).

### 9 **TOP MENU**

Press to display the top menu of the BD-ROM or DVD-Video.

**10  $\uparrow/\downarrow/\leftarrow/\rightarrow$**  – Use to select items, change settings and move the cursor.

**ENTER** – Press to execute the selected item or enter a setting that has been changed, etc.

### 11 **HOME MENU**

Press to display/hide the Home Menu.

**12  $\blacktriangleright$  PLAY** – Press to start playback.

**II PAUSE** – Press to pause playback. Press again to restart playback.

**■ STOP** – Press to stop playback.

**$\lll$  PREV/ $\ggg$  NEXT** – Press to skip to the beginning of the previous/next title/chapter/track/file (page 27).

**$\lll$  /  $\lll$  /  $\lll$**  – Press during playback to start reverse scanning. While playback is paused, press for step reverse playback. Press and hold while playback is paused for reverse slow motion playback (pages 26 and 27).

**$\ggg$  /  $\ggg$  /  $\ggg$**  – Press during playback to start forward scanning. While playback is paused, press for step forward playback. Press and hold while playback is paused for forward slow motion playback (pages 26 and 27).

### 13 **RED/GREEN/BLUE/YELLOW**

Use these to navigate BD-ROM menus.

### 14 **VIDEO ADJUST**

Press to display/hide the Video Adjust menu (page 37).

### 15 **OPEN/CLOSE**

Press to open and close the disc tray.

### 16 **FL DIMMER**

Press to switch the brightness of the front panel display. The **FL OFF** indicator lights when **Off** is selected.

### 17 **ANGLE**

Press to switch the BD-ROM or DVD-Video camera angle (page 28).

### 18 **OUTPUT RESOLUTION**

Use these to switch the output video resolution from the **HDMI OUT** or **COMPONENT VIDEO** output terminals (page 25).

**19 PLAY MODE**

Press to display/hide the Play Mode screen (page 29).

**20 POP UP MENU/MENU**

Press to display the BD-ROM or DVD-Video menus.

**21 DISPLAY**

Press to display disc information (page 29).

**22  TOOLS**

Press to display/hide the **TOOLS** menu (page 23).

**23  RETURN**

Press to return to the previous screen.

## Front Panel

---

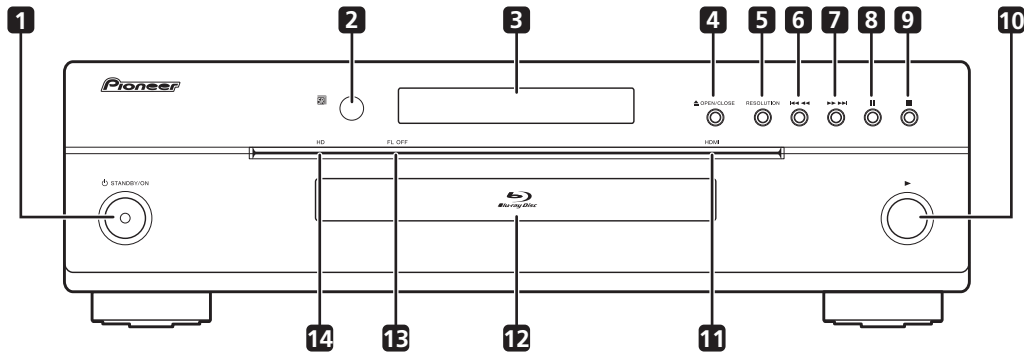
**1  STANDBY/ON**

Press to turn the power on and off.

**2 Remote control sensor**

Point the remote control to this, then operate it within approximately 23 feet.

The player may have trouble capturing remote control signals if there is a fluorescent light nearby. If this happens, move the player away from the fluorescent light.

**3 Front panel display****4  OPEN/CLOSE**

Press to open and close the disc tray.

**5 RESOLUTION**

Press to switch the output video resolution from the HDMI output or component video output terminals (page 25).

**6  **

Press to skip to the beginning of the previous title/chapter/track/file. Press and hold to start reverse scanning (pages 26 and 27).

**7  **

Press to skip to the beginning of the next title/chapter/track/file. Press and hold to start forward scanning (pages 26 and 27).

**8 **

Press during playback to pause. Press again to restart playback.

**9 **

Press to stop playback.

**10 **

Press to start playback.

**11 HDMI indicator**

This lights when video signals from the HDMI terminal is output (page 14).

**12 Disc tray****13 FL OFF indicator**

This lights when **Off** is selected with **FL DIMMER**.

**14 HD indicator**

This lights when an HDMI cable is connected and the video output resolution is set to 1080/60i, 1080/60p, 1080/24p or 720/60p. It also lights when a component video cable is connected and the output video resolution is set to 1080/60i or 720/60p.



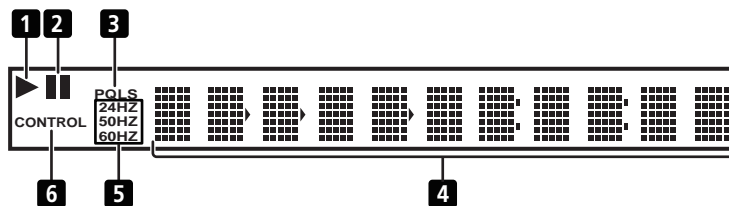

## Front Panel Display

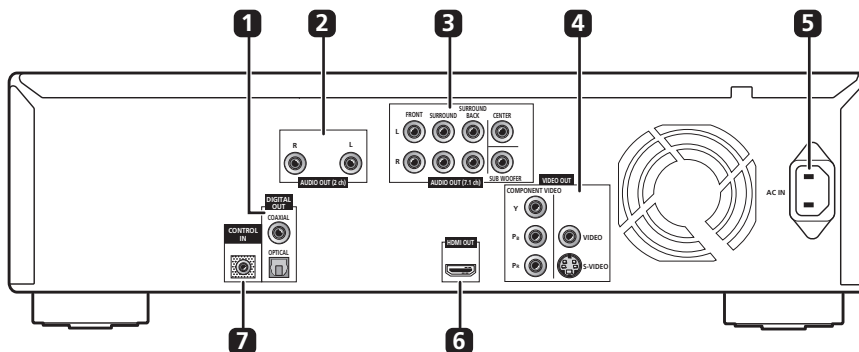

- 1 ▶**  
Lights during playback.
- 2 ||**  
Lights when playback is paused.
- 3 PQLS**  
Lights when the PQLS function is activated (page 15).
- 4 Character display**  
Displays the title/chapter/track number, elapsed time, etc.
- 5 24HZ/50HZ/60HZ**  
The frequency of the video frame or field being output lights.
- 6 CONTROL**  
Lights when the HDMI Control function is activated (page 15).

## Rear Panel



- 1 DIGITAL OUT (COAXIAL/OPTICAL)**  
Connect with the digital audio input terminal on an AV receiver or amplifier, etc.
- 2 AUDIO OUT (2 ch) terminals**  
Connect with the audio input terminals on a TV, AV receiver or amplifier, etc.
- 3 AUDIO OUT (7.1 ch) terminals**  
Connect with the multi-channel (7.1- or 5.1-channel) audio input terminals on an AV receiver or amplifier, etc.
- 4 VIDEO OUT terminals**  
  - VIDEO** – Connect with the video input terminal on a TV, AV receiver or amplifier, etc.
  - S-VIDEO** – Connect with the S-Video input terminal on a TV, AV receiver or amplifier, etc.
  - COMPONENT VIDEO** – Connect with the component video input terminals on a TV, AV receiver or amplifier, etc.
- 5 AC IN**  
Connect the power cord here.
- 6 HDMI OUT terminal**  
Connect with an HDMI-compatible TV, AV receiver or amplifier, etc.
- 7 CONTROL IN terminal**  
Use to control this player from the remote sensor of another Pioneer component with a **CONTROL OUT** terminal and bearing the  mark. Connect the **CONTROL OUT** of the other component to the **CONTROL IN** of this player using a mini-plug cord.

 **Caution**

- Be sure to connect cables for outputting the audio and video signals (pages 14 and 17).
- When connected via System Control, point the remote control toward the connected component (such as an AV receiver or amplifier). The remote will not work correctly when pointed at this player.
- You cannot use System Control with components that do not have a System Control terminal or with components manufactured by companies other than Pioneer.

# Connecting up

## Connecting a TV

Be sure to turn off the power and unplug the power cord from the power outlet whenever making or changing connections.

### Note

- Make the settings in the Setup Navigator menu according to the type of cable connected (page 20).

## Connecting using a commercially available HDMI cable

The audio and video signals can be transferred to HDMI-compatible devices as digital signals with no loss of sound or video quality. After connecting, make the settings at the **Setup Navigator** menu according to the connected HDMI-compatible device (page 20).

Also refer to the operating instructions of the device being connected.

### Note

- The HDMI indicator on the player's front panel lights when video signals are being output from the **HDMI OUT** terminal. (Depending on the connected device, in some cases it may only light when the player is selected as the device's input.)
- 1080p video signals may not be output, depending on the HDMI cable being used.

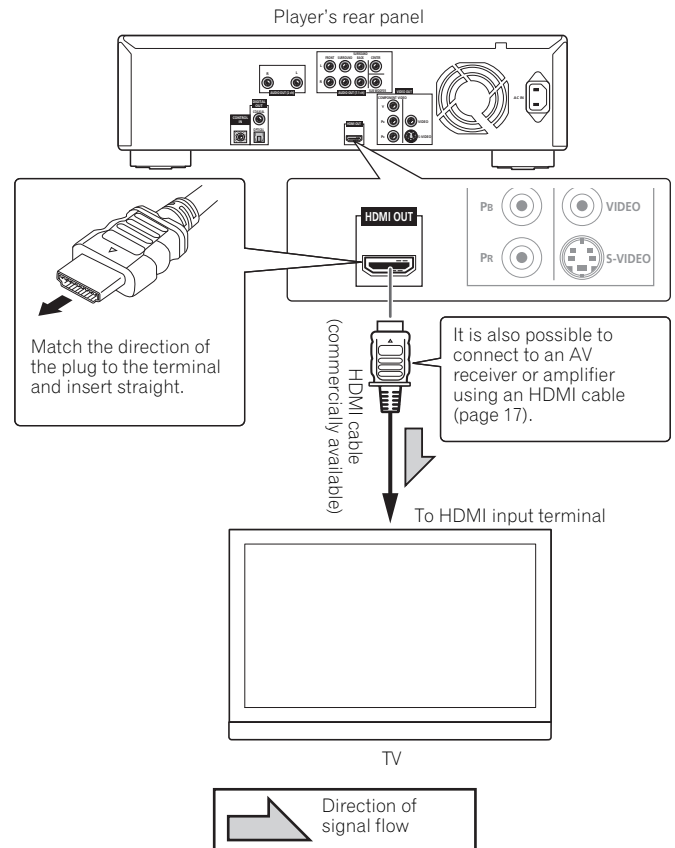

### Caution

- Hold the plug when connecting and disconnecting the cable.
- Placing a load on the plug could result in faulty contact and no video signals being output.

### ❖ About HDMI

This player incorporates High-Definition Multimedia Interface (HDMI™) technology.

The conventional players can transmit a video signal with 8 bit color depth in the YCbCr 4:4:4 or RGB formats, the players supporting Deep Color can transmit a video signal with a color bit depth of greater than 8 bits per color component. Subtle color gradations can be reproduced when connected to a TV that supports Deep Color.

**HDMI™**  
HIGH-DEFINITION MULTIMEDIA INTERFACE

*HDMI, the HDMI logo and High-Definition Multimedia Interface are trademarks or registered trademarks of HDMI Licensing LLC.*

## ❖ Audio signals that can be transferred with the player's HDMI output terminal

- Dolby TrueHD
- Dolby Digital Plus
- Dolby Digital
- DTS-HD Master Audio
- DTS-HD High Resolution Audio
- DTS Digital Surround
- MPEG-2 AAC
- Linear PCM

Linear PCM audio signals meeting the following conditions can be output:

- Sampling frequency: 32 kHz to 192 kHz
- Number of channels: Up to 8 (up to 6 for a 192 kHz sampling frequency)

For details, see *About the audio output settings* on page 50.

## ❖ About the HDMI high speed transmission

This player outputs 1080/60p and Deep Color video signals. If your TV supports 1080/60p or Deep Color signals, use a High Speed HDMI™ cable in order to take advantage of the maximum performance the player and TV can offer. Also set **HDMI High-Speed Transmission** to **On** (page 41).

High Speed HDMI™ cables are tested to carry signals up to 1080p, 1080/60i, 1080/60p, 1080/24p and 720/60p video signals that are capable of Deep Color can also be carried.



### Note

- Set **HDMI High-Speed Transmission** to **Off** when using an HDMI cable other than a High Speed HDMI™ cable (a Standard HDMI™ cable).
- The following restrictions apply when **HDMI High-Speed Transmission** is set to **Off**:
  - Deep Color signals are not output.
  - If output video resolution is set to **Auto**, the signals are output with a resolution of 1080/60i, even if the TV's preferred resolution is 1080/60p.
  - When the output video resolution is set to **480i** or **480p**, Dolby TrueHD and DTS-HD Master Audio signals are not output as such. They are either output as Dolby Digital or DTS Digital Surround signals or converted into linear PCM. Also, 96 kHz and 192 kHz multi-channel linear PCM audio signals cannot be output. They are output as 2-channel signals (page 50).
- When an HDMI cable with a built-in equalizer is connected, it may not operate properly.

## ❖ About HDCP

HDCP (High-bandwidth Digital Content Protection) is a copyright protection system by which digital video signals are encrypted.

## ❖ When connected to a DVI device

- **It is not possible to connect DVI devices (computer displays, for example) that are not compatible with HDCP.**
- No audio signals are output. Connect using an audio cable (included), etc.
- This player is designed for connection with HDMI-compatible devices. When connected to a DVI device, it may not operate properly depending on the DVI device.

## ❖ About HDMI Control function

- When the player is connected to a Pioneer Flat Panel TV or AV system (AV receiver or amplifier, etc.), supporting the HDMI Control function, it can be operated from the Flat Panel TV or AV system (AV receiver or amplifier, etc.).
- The Flat Panel TV's input is switched automatically when playback is started on the player or the Home Menu or the Home Media Gallery is displayed. When the input is switched, the playback picture, the Home Menu or the Home Media Gallery appears on the Flat Panel TV (Auto-select function). If the Flat Panel TV's power is being turned off at this time, it may turn on automatically (Simultaneous power function). When the language information from a connected Flat Panel TV is received, you can have the player's on-screen display language change automatically to that of the Flat Panel TV (Unified language function). This function is available only when playback is stopped and the menu screen is not displayed.
- Also refer to the operating instructions of the Flat Panel TV or AV system (AV receiver or amplifier, etc.).

## ❖ To use the HDMI Control function

- The HDMI Control function only works when outputting video signals from the HDMI terminal.
- The HDMI Control function operates when HDMI Control is set to On for all devices connected with HDMI cables. Once connections and the settings of all the devices are finished, be sure to check that the player's picture is output to the Flat Panel TV. (Also check after changing the connected devices and reconnecting HDMI cables.) The HDMI Control function may not operate properly if the player's picture is not properly output to the Flat Panel TV.
- Use High Speed HDMI™ cables when using the HDMI Control function. The HDMI Control function may not operate properly if other HDMI cables are used.
- The function name of KURO LINK used on the web and in catalogues is referred to as HDMI Control in the operating instructions and on the product.

## ❖ About PQLS function

The PQLS (Precision Quartz Lock System) is a transfer control technology using the HDMI Control function. The player's output signals are controlled from the AV receiver or amplifier to achieve high quality sound playback using the quartz oscillator of AV receiver or amplifier. This eliminates the influence of the jitter generated upon transfer which can adversely affect the sound quality.

- The PQLS function is only activated when the player is connected to a Pioneer AV receiver or amplifier compatible with the PQLS function via HDMI connection.
- The PQLS function is activated when the player is set as follows (page 41):  
**HDMI Control: On**  
**PQLS: Auto**
- Also refer to the operating instructions of AV receiver or amplifier.

## 02 Connecting using a commercially available component video cable

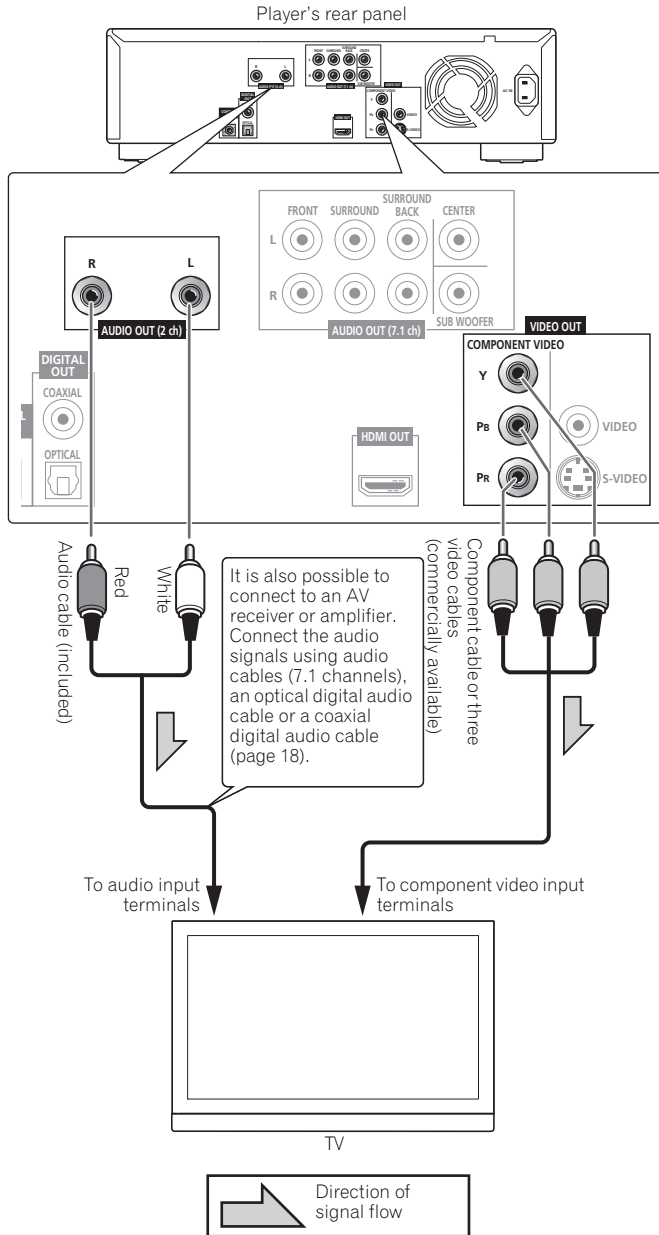

### Caution

- When connected to the TV using a component video cable (commercially available), video signals are not output with resolutions of 1080/60p or 1080/24p.
- Depending on the output video resolution setting, the picture may not be output (page 25).
- When connected to the TV using component video cables, also connect using either an optical digital audio cable (commercially available), a coaxial digital audio cable (commercially available), or audio cables (use the included

cable for 2-channel connections, a combination of the included cable and commercially available cables for 7.1-channel connections). It is not possible to listen to the sound from devices connected with HDMI cables (commercially available).

## Connecting using the included audio cable and video cable

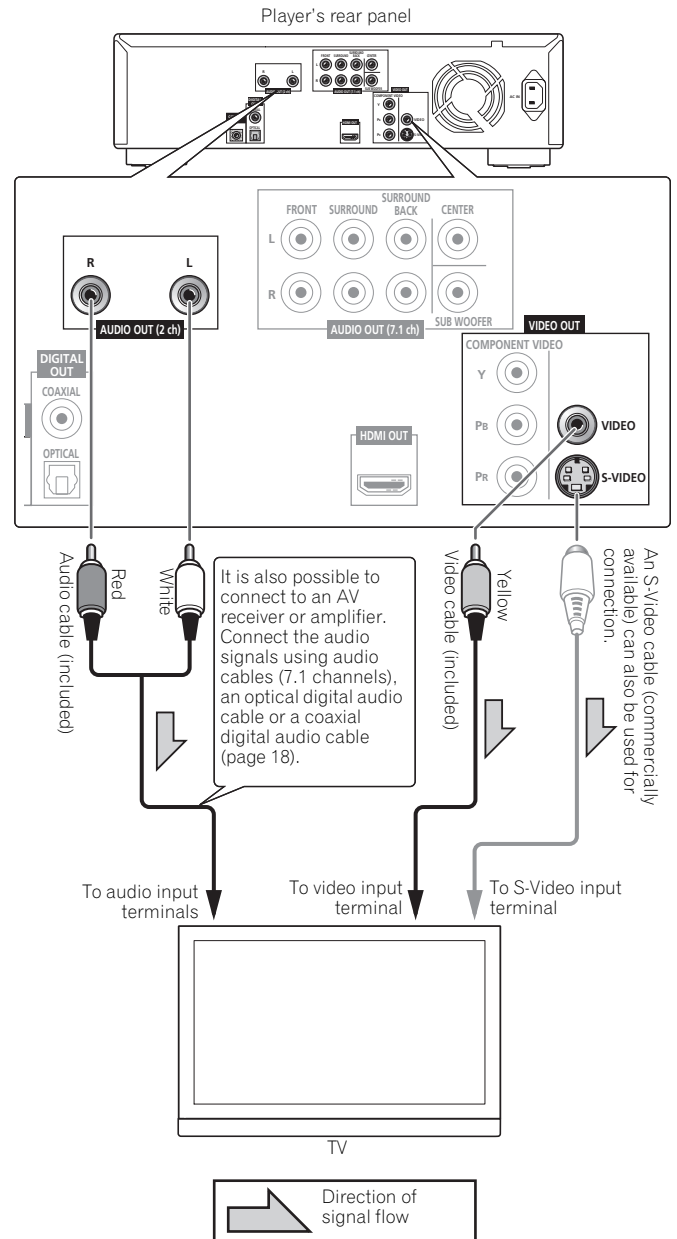

### ⚠ Caution

- Video signals are only output with a resolution of 480/60i when connected using a video cable (included) or an S-Video cable (commercially available).
- When connected to a TV using a video cable or an S-Video cable, also connect using either audio cables (use the included cable for 2-channel connections, a combination of the included cable and commercially available cables for 7.1-channel connections), an optical digital audio cable (commercially available), or a coaxial digital audio cable (commercially available). It is not possible to listen to the sound from devices connected with HDMI cables (commercially available).
- **Connect the player's video output directly to your TV.**  
This player supports analog copy protection technology. Therefore the picture may not be displayed properly if connected to a TV via a DVD recorder/video deck or when playing the player's output material that is recorded by a DVD recorder/video deck. Furthermore, the picture may not be displayed properly due to the copy protection when the player is connected to a TV with a built-in video deck. For details, contact the manufacturer of your TV.

## Connecting an AV receiver or amplifier

Connect to an AV receiver or amplifier in order to enjoy the surround sound of Dolby TrueHD, Dolby Digital Plus, Dolby Digital, DTS-HD Master Audio, DTS-HD High Resolution Audio or DTS Digital Surround. For instructions on connecting the TV and speakers to the AV receiver or amplifier, refer to the operating instructions of AV receiver or amplifier.

### 📝 Note

- Make the settings in the Setup Navigator menu according to the type of cable connected (page 20).
- To input video signals, connect using one of the following (not including when connected using an HDMI cable): a component video cable (commercially available), an S-Video cable (commercially available) or a video cable (included).

## Connecting using a commercially available HDMI cable

### ⚠ Caution

- When connected to an AV receiver or amplifier using an HDMI cable (commercially available), use another HDMI cable (commercially available) to connect the AV receiver or amplifier with the TV. If a component video cable (commercially available), an S-Video cable (commercially available) or a video cable (included) is connected to watch the picture, it is not possible to listen to the sound of devices connected with HDMI cables.
- When DTS-HD Master Audio and DTS-HD High Resolution Audio signals are output as linear PCM signals, the DTS Digital Surround signals are converted to linear PCM for output (page 50).

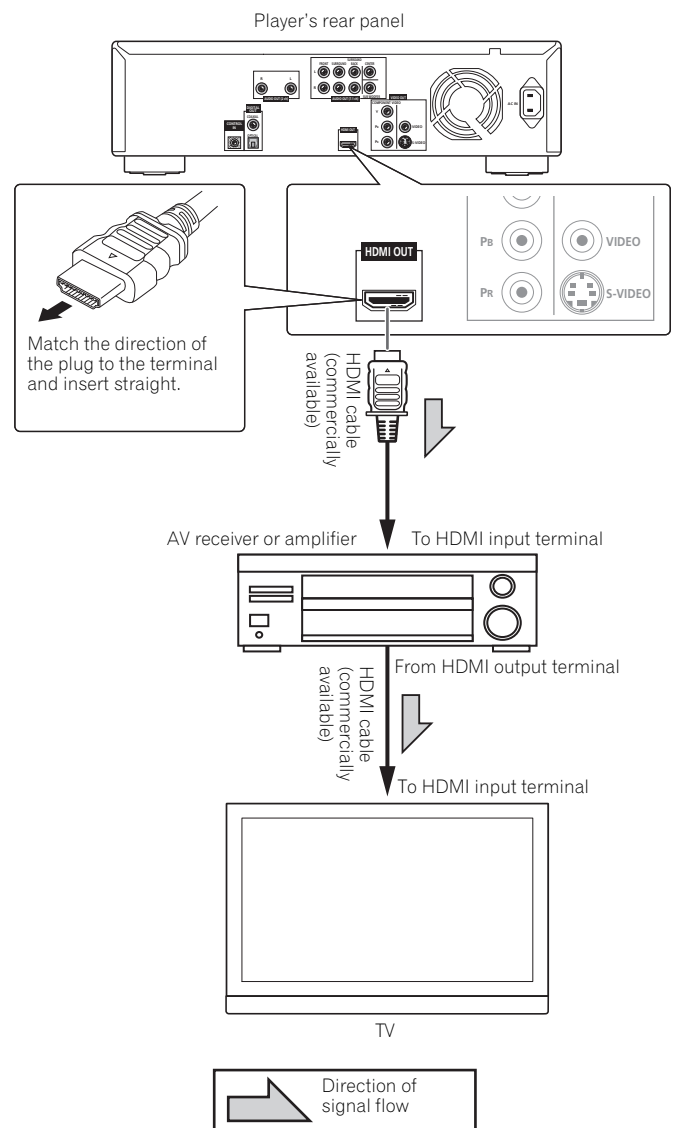

## 02 Connecting using audio cables

### Caution

- For DTS-HD Master Audio and DTS-HD High Resolution Audio signals, the DTS Digital Surround signals are converted to linear PCM for output (page 50).

**When connecting to a 7.1-channel compatible AV receiver or amplifier** – Connect using the included audio cable and 3 commercially available audio cables (diagram below).

**When connecting to a 5.1-channel compatible AV receiver or amplifier** – Connect using the included audio cable and 2 commercially available audio cables (do not connect to the surround back left and right terminals).

- After connecting, set **Audio Output Mode** to **Multi-channel** (page 40).

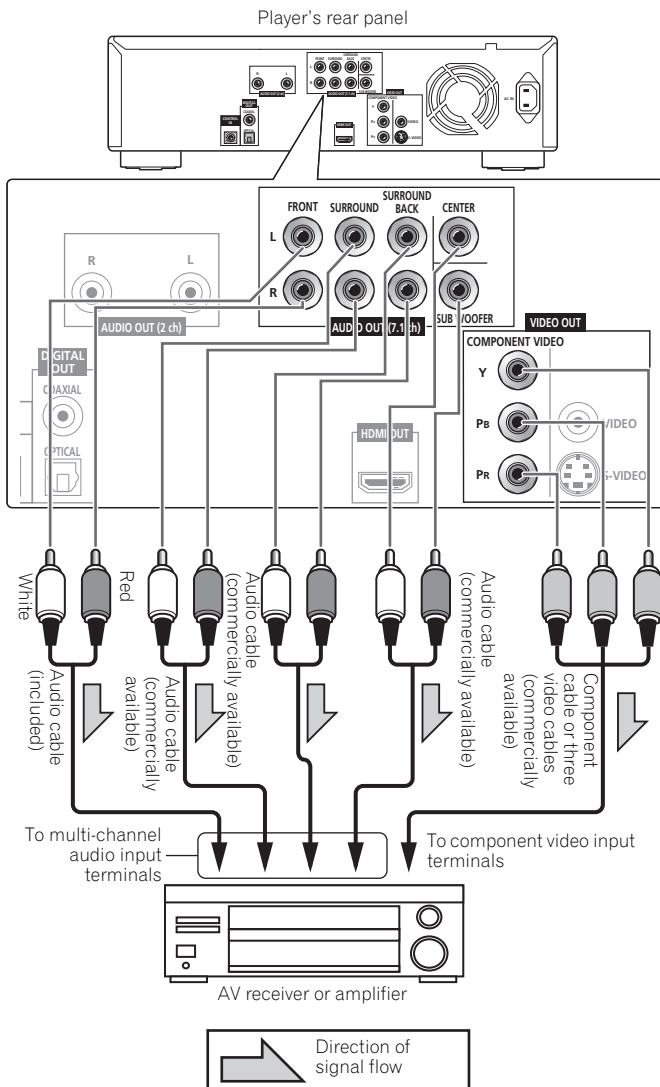

## Connecting using a commercially available digital audio cable

Connect either an optical digital audio cable or a coaxial digital audio cable.

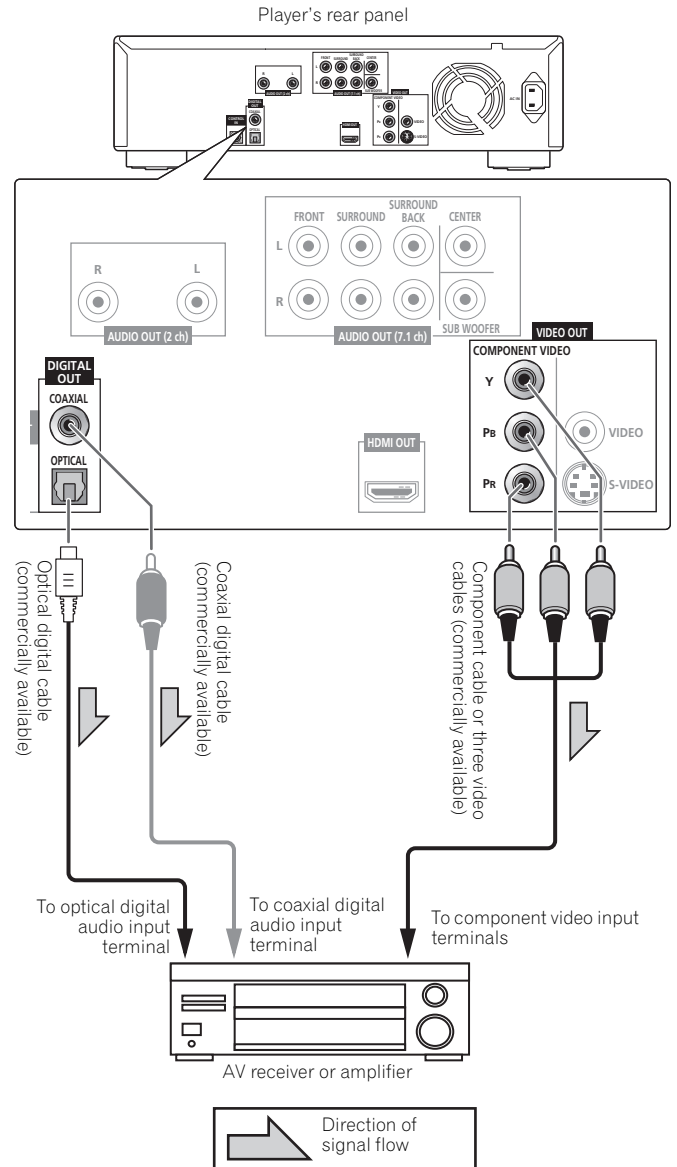

### Caution

- Dolby TrueHD and Dolby Digital Plus signals are output as the Dolby Digital signals or signals converted from Dolby Digital to linear PCM (page 50).
- DTS-HD Master Audio and DTS-HD High Resolution Audio signals are output as the DTS Digital Surround signals or signals converted from DTS Digital Surround to linear PCM (page 50).

# Connecting the power cord

Connect the power cord after all the connections between devices have been completed.

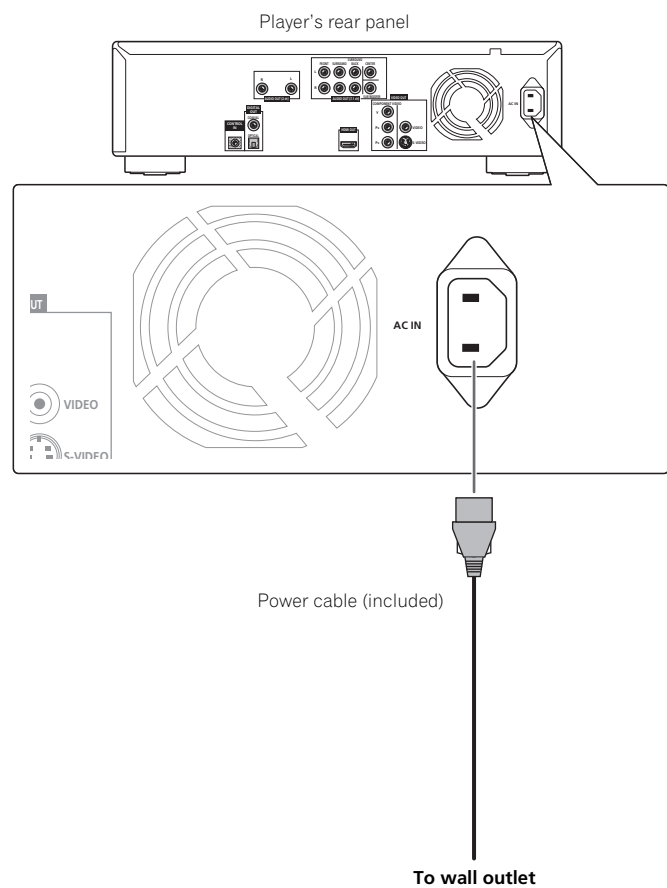

# Getting Started

## Making settings using the Setup Navigator menu

Be sure to perform these settings when using the player for the first time.

### Caution

- Before turning on the power, check that the connections between the player and other devices are correct.

#### 1 Turn on the power.

Press **STANDBY/ON**.

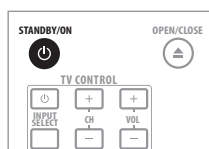

#### 2 Turn on the TV's power and switch the input.

See the TV's operating instructions for instructions on operating the TV.

Check that the **Setup Navigator** menu is displayed.

If TV Control is set, the TV can be operated with the player's remote control (page 22).

### ❖ If the Setup Navigator menu is not displayed

▶ Press **HOME MENU** to display the Home Menu, select **Initial Setup** → **Setup Navigator** → **Start**, then press **ENTER**.

#### 3 Select the OSD language.

Use **↑/↓** to select, then press **ENTER**.

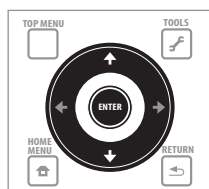

### Setup Navigator BD PLAYER

Please select the on-screen display language.

**English**  
français  
Español

Audio, subtitle and BDMV/DVD-Video menu language will also be set.

When you have the player connected to a Pioneer Flat Panel TV that is compatible with HDMI Control, language settings are imported from the Pioneer Flat Panel TV's language settings before Setup Navigator begins.

#### 4 Select and set the video and audio output terminals.

Select the actually connected video and audio output terminals.

Use **↑/↓/←/→** to select, then **ENTER**.

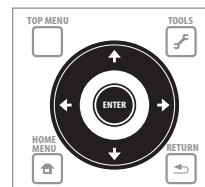

### Setup Navigator BD PLAYER

Select the output terminals to be used for the video and audio signals of this player.

**Video** ← **HDMI** →

Audio HDMI

Use [**↑**] [**↓**] to select video or audio, then press [**←**] [**→**] to select the output terminal.

When **HDMI** is selected for **Video** or **Audio**, proceed to step 5.  
When **Component Video** is selected for **Video**, proceed to step 6.  
When **S-Video/Video** is selected for **Video**, proceed to step 7.

Setting item	Output terminal name	
Video	HDMI	HDMI Output
	Component Video	Video Output Component Video
	S-Video/Video	S-Video Video
Audio	HDMI	HDMI Output
	Digital Audio	Digital Audio Output Coaxial Optical
	Analog Audio	Audio Output (2ch)
		Audio Output (7.1ch)

### Caution

- When **HDMI** is selected for **Video**, no video signals are output from the **COMPONENT VIDEO**, **S-VIDEO** or **VIDEO** output terminals.
- When **Component Video** or **S-Video/Video** is selected for **Video**, no video signals are output from the **HDMI OUT** terminal.
- The video and audio signals output from the set output terminals are output synchronously (lip synchronization).
- When **S-Video/Video** or **Component Video** is selected at **Video**, no sound is output if **HDMI** is selected at **Audio** (the warning message shown below is displayed). Follow the procedure below to redo the connections, then select the proper connection at the setup screen.
  - When connecting using component video cables, an S-Video cable or a video cable to watch the picture, connect to an AV receiver or amplifier, or a TV using either analog audio cables (7.1 channels or 2 channels), an optical digital audio cable or a coaxial digital audio cable (page 18).



- When connecting the player to an AV receiver or amplifier using an HDMI cable in order to listen to the Dolby TrueHD, Dolby Digital Plus, DTS-HD Master Audio or DTS-HD High Resolution Audio signals converted into linear PCM, connect the TV to the AV receiver or amplifier using an HDMI cable (pages 14 and 17).

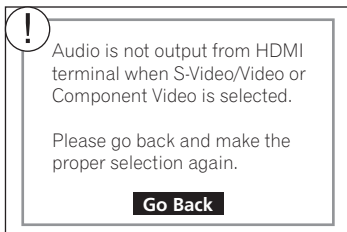

- Linear PCM audio signals (2 channels) are output from all terminals other than the ones selected at **Audio**, regardless of the audio format or the player's settings.

### 5 Select and set the HDMI High-Speed Transmission setting.

Use **←/→** to select, then press **ENTER**.

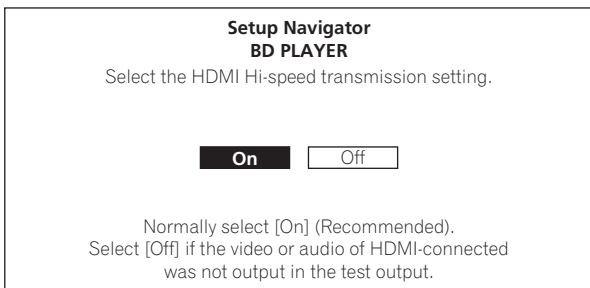
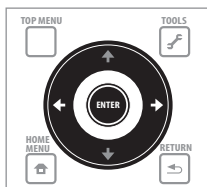

When **HDMI High-Speed Transmission** is set to **On**, use a High Speed HDMI™ cable. The picture and sound may not be output properly if any other HDMI cable (standard HDMI™ cable) is used. Proceed to step 8.

### 6 Select the output video resolution from the COMPONENT VIDEO output terminals.

Use **↑/↓** to select, then press **ENTER**.

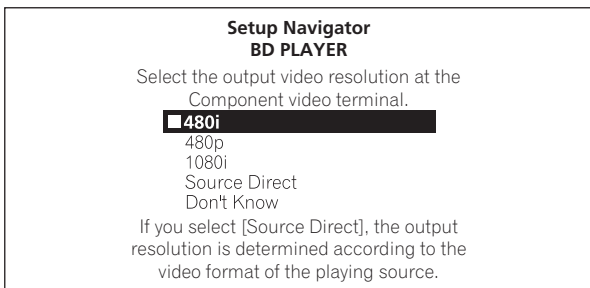

For details on the resolution settings, see *Switching the output video resolution* on page 25.

### 7 Select the aspect ratio of your TV.

Use **↑/↓** to select, then press **ENTER**.

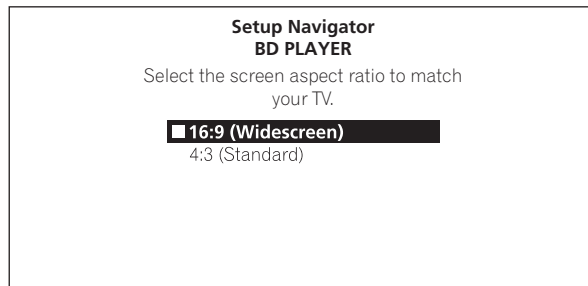

### 8 Check the settings.

Select **Proceed**, then press **ENTER**.

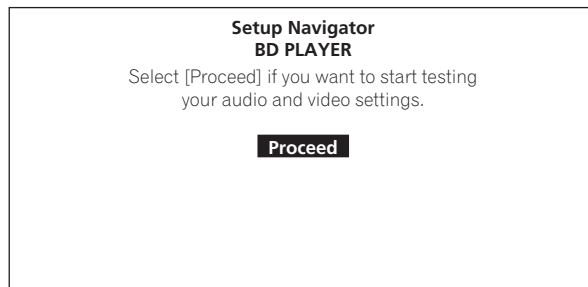

### 9 Output test tones.

Use **←/→** to select **Yes**, then press **ENTER**.

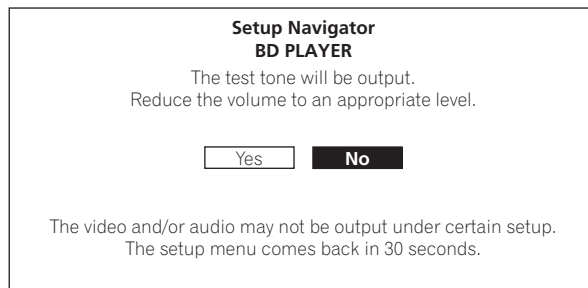

### ⚠ Caution

- The screen in step 10 and test tones are output simultaneously according to the settings in steps 4 to 7. Lower the volume of the devices connected with the player.

### 10 Finish the Setup Navigator menu.

Use **←/→** to select **Finish**, then press **ENTER**.

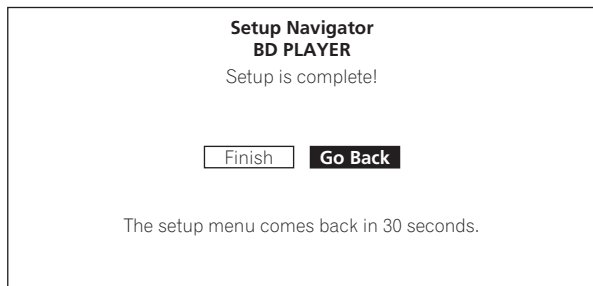

To redo the settings from the start, select **Go Back**.

Depending on the output terminal setting of step 4 or the HDMI cable being used, it may happen that no picture and/or sound is output. If this happens, the setup returns to step 4 if there is no operation for over 30 seconds. Once the setup returns to step 4, redo the settings according to the connected devices and the HDMI cable being used.

### ❖ About the screen saver

The screen saver is automatically activated if there is no operation for over 1 minute after playback is stopped or paused. The screen saver turns off when an operation is performed on the player or remote control.

The screen saver is automatically activated if there is no operation for over 1 minute after the Home Menu or Home Media Gallery is displayed while playing a BD or DVD.

With CDs and music files, the screen saver is automatically activated if no button is operated for over 1 minute, even while the CD or music file is playing.

## Operating the TV with the player's remote control

When the manufacturer code for your brand of TV is set on the player's remote control, the TV can be operated using the player's remote control.

### 1 Input the 2-digit manufacturer code.

Press the number buttons (0 to 9) to input the code while pressing **TV CONTROL** .

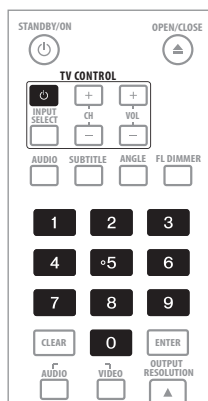

- If you make a mistake when inputting the code, start over from the beginning.
- When there are multiple codes for a manufacturer, try inputting them in the indicated order until the TV can be operated.

### 2 Check that the TV can be operated.

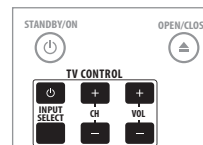

### Caution

- For some models it may not be possible to operate the TV with the player's remote control, even for TVs of brands listed on the manufacturer code list.
- The setting may be restored to the default after the batteries are replaced. If this happens, reset it.

## TV Preset code list

### Manufacturer Code(s)

<b>PIONEER</b> 00, 31, 32, 07, 36, 42, 51	<b>ELIN</b> 07
<b>ACURA</b> 44	<b>ELITE</b> 41
<b>ADMIRAL</b> 31	<b>ELTA</b> 44
<b>AIWA</b> 60	<b>EMERSON</b> 42
<b>AKAI</b> 32, 35, 42	<b>ERRES</b> 07
<b>AKURA</b> 41	<b>FERGUSON</b> 07, 36, 51
<b>ALBA</b> 07, 39, 41, 44	<b>FINLANDIA</b> 35, 43, 54
<b>AMSTRAD</b> 42, 44, 47	<b>FINLUX</b> 32, 07, 45, 48, 53, 54
<b>ANITECH</b> 44	<b>FIRSTLINE</b> 40, 44
<b>ASA</b> 45	<b>FISHER</b> 32, 35, 38, 45
<b>ASUKA</b> 41	<b>FORMENTI</b> 32, 07, 42
<b>AUDIOGONIC</b> 07, 36	<b>FRONTECH</b> 31, 42, 46
<b>BASIC LINE</b> 41, 44	<b>FRONTECH/PROTECH</b> 32
<b>BAUR</b> 31, 07, 42	<b>FUJITSU</b> 48
<b>BEKO</b> 38	<b>FUNAI</b> 40, 46, 58
<b>BEON</b> 07	<b>GBC</b> 32, 42
<b>BLAUPUNKT</b> 31	<b>GE</b> 00, 01, 08, 07, 10, 11, 17, 02, 28, 18
<b>BLUE SKY</b> 41	<b>GEC</b> 07, 34, 48
<b>BLUE STAR</b> 18	<b>GELOSO</b> 32, 44
<b>BPL</b> 18	<b>GENERAL</b> 29
<b>BRANDT</b> 36	<b>GENEXXA</b> 31, 41
<b>BTC</b> 41	<b>GOLDSTAR</b> 10, 23, 21, 02, 07, 50
<b>BUSH</b> 07, 41, 42, 44, 47, 56	<b>GOODMANS</b> 07, 39, 47, 48, 56
<b>CASCADE</b> 44	<b>GORENJE</b> 38
<b>CATHAY</b> 07	<b>GPM</b> 41
<b>CENTURION</b> 07	<b>GRAETZ</b> 31, 42
<b>CGB</b> 42	<b>GRANADA</b> 07, 35, 42, 43, 48
<b>CIMLINE</b> 44	<b>GRADIENTE</b> 30, 57
<b>CLARIVOX</b> 07	<b>GRANDIN</b> 18
<b>CLATRONIC</b> 38	<b>GRUNDIG</b> 31, 53
<b>CONDOR</b> 38	<b>HANSEATIC</b> 07, 42
<b>CONTEC</b> 44	<b>HCM</b> 18, 44
<b>CROSLEY</b> 32	<b>HINARI</b> 07, 41, 44
<b>CROWN</b> 38, 44	<b>HISAWA</b> 18
<b>CRYSTAL</b> 42	<b>HITACHI</b> 31, 33, 34, 36, 42, 43, 54, 06, 10, 24, 25, 18
<b>CYBERTRON</b> 41	<b>HUANYU</b> 56
<b>DAEWOO</b> 07, 44, 56	<b>HYPSON</b> 07, 18, 46
<b>DAINICHI</b> 41	<b>ICE</b> 46, 47
<b>DANSAI</b> 07	<b>IMPERIAL</b> 38, 42
<b>DAYTON</b> 44	<b>INDIANA</b> 07
<b>DECCA</b> 07, 48	<b>INGELEN</b> 31
<b>DIXI</b> 07, 44	<b>INTERFUNK</b> 31, 32, 07, 42
<b>DUMONT</b> 53	



### Note

- The factory setting is **PIONEER 00**.

- INTERVISION** 46, 49  
**ISUKAI** 41  
**ITC** 42  
**ITT** 31, 32, 42  
**JEC** 05  
**JVC** 13, 23  
**KAISUI** 18, 41, 44  
**KAPSCH** 31  
**KENDO** 42  
**KENNEDY** 32, 42  
**KORPEL** 07  
**KOYODA** 44  
**LEYCO** 07, 40, 46, 48  
**LIESENK&TTER** 07  
**LOEWE** 07  
**LUXOR** 32, 42, 43  
**M-ELECTRONIC** 31, 44, 45, 54, 56, 07, 36, 51  
**MAGNADYNE** 32, 49  
**MAGNAFON** 49  
**MAGNAVOX** 07, 10, 03, 12, 29  
**MANESTH** 39, 46  
**MARANTZ** 07  
**MARK** 07  
**MATSUI** 07, 39, 40, 42, 44, 47, 48  
**MCMICHAEL** 34  
**MEDIATOR** 07  
**MEMOREX** 44  
**METZ** 31  
**MINERVA** 31, 53  
**mitsubishi** 09, 10, 02, 21, 31  
**MULTITECH** 44, 49  
**NEC** 59  
**NECKERMANN** 31, 07  
**NEI** 07, 42  
**NIKKAI** 05, 07, 41, 46, 48  
**NOBLIKO** 49  
**NOKIA** 32, 42, 52  
**NORDMENDE** 32, 36, 51, 52  
**OCEANIC** 31, 32, 42  
**ORION** 32, 07, 39, 40  
**OSAKI** 41, 46, 48  
**OSO** 41  
**OSUME** 48  
**OTTO VERSAND** 31, 32, 07, 42  
**PALLADIUM** 38  
**PANAMA** 46  
**PANASONIC** 31, 07, 08, 42, 22  
**PATHO CINEMA** 42  
**PAUSA** 44  
**PHILCO** 32, 42  
**PHILIPS** 31, 07, 34, 56, 68  
**PHOENIX** 32  
**PHONOLA** 07  
**PROFEX** 42, 44  
**PROTECH** 07, 42, 44, 46, 49  
**QUELLE** 31, 32, 07, 42, 45, 53  
**R-LINE** 07  
**RADIOLA** 07  
**RADIOHACK** 10, 23, 21, 02  
**RBM** 53  
**RCA** 01, 10, 15, 16, 17, 18, 61, 62, 09  
**REDIFFUSION** 32, 42  
**REX** 31, 46  
**ROADSTAR** 41, 44, 46  
**SABA** 31, 36, 42, 51  
**SAISHO** 39, 44, 46  
**SALORA** 31, 32, 42, 43  
**SAMBERS** 49  
**SAMSUNG** 07, 38, 44, 46, 69, 70  
**SANYO** 35, 45, 48, 21, 14, 91  
**SBR** 07, 34  
**SCHAUB LORENZ** 42  
**SCHNEIDER** 07, 41, 47  
**SEG** 42, 46  
**SEI** 32, 40, 49  
**SELECO** 31, 42  
**SHARP** 02, 19, 27, 67, 90  
**SIAREM** 32, 49  
**SIEMENS** 31  
**SINUDYNE** 32, 39, 40, 49  
**SKANTIC** 43  
**SOLAVOX** 31  
**SONOKO** 07, 44  
**SONOLOR** 31, 35  
**SONTEC** 07  
**SONY** 04  
**SOUNDWAVE** 07  
**STANDARD** 41, 44  
**STERN** 31  
**SUSUMU** 41  
**SYSLINE** 07  
**TANDY** 31, 41, 48  
**TASHIKO** 34  
**TATUNG** 07, 48  
**TEC** 42  
**TELEAVIA** 36  
**TELEFUNKEN** 36, 37, 52  
**TELETECH** 44  
**TENSAI** 40, 41  
**THOMSON** 36, 51, 52, 63  
**THORN** 31, 07, 42, 45, 48  
**TOMASHI** 18  
**TOSHIBA** 05, 02, 26, 21, 53  
**TOWADA** 42  
**ULTRAVOX** 32, 42, 49  
**UNIDEN** 92  
**UNIVERSUM** 31, 07, 38, 42, 45, 46, 54  
**VESTEL** 07  
**VICTOR** 13  
**VOXSON** 31  
**WALTHAM** 43  
**WATSON** 07  
**WATT RADIO** 32, 42, 49  
**WHITE WESTINGHOUSE** 07  
**YOKO** 07, 42, 46  
**ZENITH** 03, 20

## Using the TOOLS menu



Various functions can be called out according to the player's operating status.

### 1 Display the TOOLS menu.

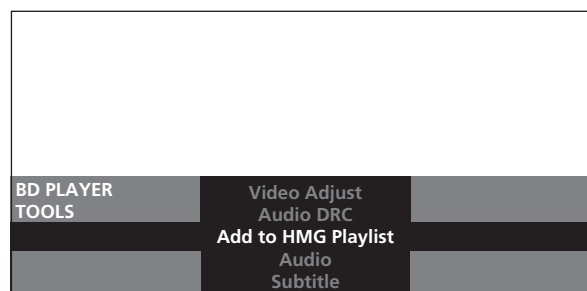
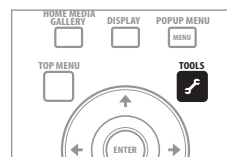
Press  **TOOLS**.



### 2 Select and set the item.

Use / to select, then press **ENTER**.

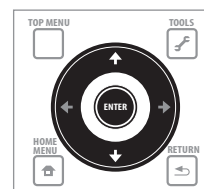

### Note

- Items that cannot be changed are displayed in gray. The items that can be selected depend on the player's status.

### ❖ To close the TOOLS menu

Press  **TOOLS** or  **RETURN**.

### ❖ TOOLS menu item list

Item	Description
Output Video Resolution	Switch the output video resolution from the various output terminals (page 25).
Play from Beginning	Play the selected title, track or file from the start.
Play Mode	Display the Play Mode screen (page 29).
Angle	Switch the BD-ROM/DVD-Video disc's camera angles (page 28).
Subtitle	Switch the subtitles (page 28).
Audio	Switch the audio streams/channels (page 28).
Secondary Audio	Switch the BD-ROM's secondary audio streams/channels (page 28).
Secondary Video	Switch the BD-ROM's secondary video (Picture-in-Picture) (page 29).
Original/Play List	Switch the DVD-R/-RW's (VR format) list screen between the original list and the playlist.

Item	Description
Add to HMG Playlist	Add the selected track or file to the HMG Playlist (page 35).
Delete from HMG Playlist	Delete the selected track or file from the HMG Playlist (page 36).
Now Playing	Display the playback screen of the currently playing track or file.
Video Adjust	Display the picture quality adjustment screen (page 37).
Audio DRC	Adjust the Audio DRC (page 38).
BDMV Data Erase	Erase the additional data from BD-ROMs.

## Erasing the additional data from BD-ROMs

When a BD-ROM is played, additional data may be stored in the player's memory (local storage).

If the message indicating low memory (local storage) appears, erase the BDMV data.

### Caution

- When the BDMV data is erased, all the data of secondary video (Picture-in-Picture), secondary audio and/or bookmark, etc. that has been stored is erased.

### 1 Display the Tools menu.

With no disc loaded, press the  **TOOLS** button.

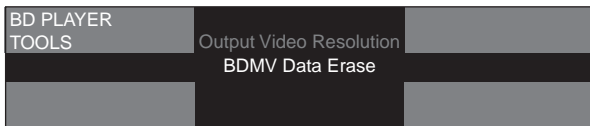
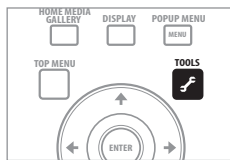

### 2 Select and set the item.

Use  to select **BDMV Data Erase**, then press **ENTER**.

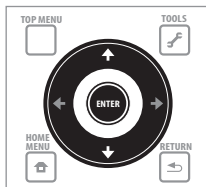

### 3 Erase the data.

Use  to select **Yes**, then press **ENTER**.

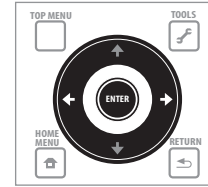

Erases all of the data added from BDMV. Please wait a while.

OK to erase data?

### Caution

- It takes time to erase the BDMV data for a while. Do not unplug the power cord for about 10 seconds after performing the above procedure.

## Switching the video output terminal

Use the procedure below to switch the video output terminal. Switch between the digital output (HDMI output) and the analog output (Component Video output, S-Video output or Video output).

► **Switch the terminal from which the video signals are output.**

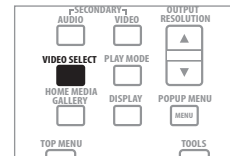

The video output terminal switches each time the button is pressed.

### Caution

- The picture may not be displayed for a while when the video output terminal is switched.
- When the **HDMI OUT** terminal is selected, no video signals are output from the other video output terminals.
- When a video output terminal other than the **HDMI OUT** terminal is selected, no audio and video signals are output from the **HDMI OUT** terminal.

# Switching the output video resolution

Use the procedure below to switch the output video resolution from the various video output terminals.

► **Press OUTPUT RESOLUTION.**

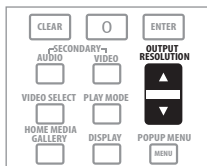

The current output video resolution are displayed on the TV screen and on the player's front panel display.

When pressed again, the output video resolution switches.

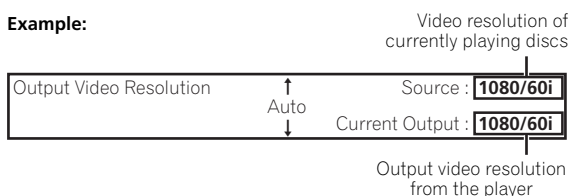

The output video resolution can also be switched using **↑/↓**.

The output video resolution can also be switched by pressing **RESOLUTION** on the player's front panel.

The output video resolution can also be switched by selecting **Output Video Resolution** from the **TOOLS** menu.

The output video resolution depends on the video output terminal. See the table below.

Output video resolution setting	HDMI OUT terminal	COMPONENT VIDEO output terminals <sup>1</sup>	S-VIDEO/VIDEO output terminal <sup>1</sup>
Auto <sup>2</sup>	Resolution preferred by TV <sup>3,4</sup>	—	—
480i	480/60i	480/60i	480/60i
480p	480/60p	480/60p	
1080i	1080/60i	1080/60i <sup>5</sup>	
1080p <sup>2</sup>	1080/60p <sup>6</sup>	—	—
Source Direct	Resolution recorded on disc <sup>3,7,8</sup>	Resolution recorded on disc <sup>7,8,9</sup>	480/60i

1. Depending on the BD, the pictures may not be output.
2. Cannot be selected when the video signals are being output from the **COMPONENT VIDEO** output terminals, **S-VIDEO** output terminal or the **VIDEO** output terminal.
3. For details on the output of film material (1080/24p or 720/24p video signals), see *To output film material*.
4. Sources with a resolution of 720/60p and 720/24p are output at 1080/60i, even if the TV's recommended resolution is 1080/60p.
5. Depending on the BD or DVD, the signals may be output at 480/60p.
6. Depending on the connected HDMI cable, the video signals may not be output. Also, sources with a resolution of 720/60p and 720/24p are output at 1080/60i.
7. Depending on the connected TV, the video signals may not be output.
8. 720/24p film material is output at 720/60p.
9. 1080/24p film material is output at 1080/60i.

**Caution**

- On some TVs, the picture may not be displayed properly when the resolution is switched. If this happens, use **OUTPUT RESOLUTION** to set to a resolution at which the picture is properly displayed.
- When video signals are being output with a resolution of 1080/60i, 1080/60p, 1080/24p or 720/60p from the HDMI output terminal or component video output terminals, the picture may be output with an aspect ratio of 16:9, even if the **TV Aspect Ratio** is set to **4:3 (Standard)**.
- The picture may not be displayed for a while when the resolution is switched.

❖ **About Film material**

The film material is a video signal with a frame rate of 24 frames/second. For example, these materials include 1080/24p, 720/24p, etc.

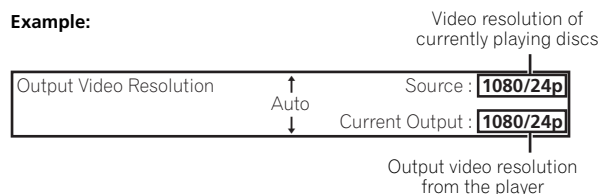

❖ **To output film material**

To output 1080/24p film material from the HDMI output terminal, set the output video resolution to either **Auto** or **Source Direct**.

**Caution**

- 1080/24p signals can only be output from the **HDMI OUT** terminal. They cannot be output from other video terminals.
- When **Auto** is selected, the picture is output at 60 frames/second if your TV is not compatible with 1080/24p signals.
- When **Source Direct** is selected, the signals are output as such, even if your TV is not compatible with 1080/24p signals. If the picture is not displayed properly, use **OUTPUT RESOLUTION** to set to the output video resolution at which the picture is properly displayed.
- 720/24p video signals are output at 60 frames/second, even if the resolution is set to **Auto** or **Source Direct**.

# Playback

## Playing discs or files

This section describes the player's main operations.

For the types of discs that can be played, see *Playable discs* on page 8. For the types of files that can be played, see *Playable files* on page 10. Music files recorded on discs are played with Home Media Gallery (page 34).

### 1 Press STANDBY/ON to turn on the power.

Turn the TV's power on and switch its input beforehand.

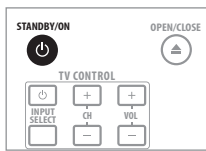

### 2 Press OPEN/CLOSE to open the disc tray and load the disc.

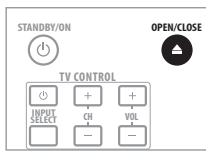

#### Note

- Load the disc with the printed side facing up.
- Several dozen seconds are required to read the disc. Once reading is completed, the type of disc is displayed on the player's front panel display.



### 3 Press PLAY to play the disc.



To pause, press  PAUSE during playback.

To stop, press  STOP during playback.



#### Note

- Some discs start playing automatically when the disc tray is closed.
- DVD-Video discs have parental lock features. Input the password registered in the player's settings to unlock the parental lock. For details, see page 46.
- For some BD-R/RE, playback protection is set for the disc or titles. Input the code number set for the disc to unlock the protection.

### ❖ If the disc menu is displayed

For some discs, the disc menu is displayed automatically when playback starts. The contents of the disc menu and the way to operate differ from disc to disc.

### ❖ Resuming playback from where it was stopped (resume playback function)

- When  STOP is pressed during playback, the point at which the disc stopped is stored in the memory. When  PLAY is pressed, playback resumes from that point.
- For CD and music files, playback starts from the beginning of the track/file that was playing.
- To cancel the resume playback function, press  STOP while playback is stopped.

#### Note

- The resume playback function is canceled automatically in the following cases:
  - When the disc tray is opened.
  - When the file list window is switched.
  - When the power is turned off. (For BDs and DVDs this does not cancel the resume playback function.)
- The resume playback function cannot be used for some discs.

## Forward and reverse scanning



### 1 During playback, press or .

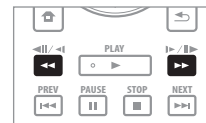

- The scanning speed switches each time the button is pressed. The speed steps depend on the disc or file (the speed is displayed on the TV screen).
- Forward or reverse scanning is also possible by holding the button down. Normal playback resumes when the button is released.

#### Note

- No sound is output when scanning BDs and DVDs.
- Sound is output when scanning CDs and music files.
- For some discs, normal playback resumes automatically when the chapter switches.

### ❖ To resume normal playback

- ▶ Press  PLAY.

## Playing specific titles, chapters or tracks



▶ **Input the number of the title, chapter or track you want to play.**

- Use the number buttons (0 to 9) to input the number, then press **ENTER**.

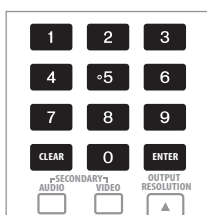

### Note

- For some discs, it is not possible to specify and play titles, chapters or tracks.
- Press **CLEAR** to clear the values you have input.

## Skipping content



▶ **Press I◀◀ PREV or ▶▶I NEXT.**

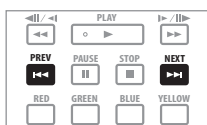

- When ▶▶I **NEXT** is pressed, the disc skips ahead to the beginning of the next title/chapter/track/file.
- When I◀◀ **PREV** is pressed, the disc skips back to the beginning of the currently playing title/chapter/track/file. Press twice to skip back to the beginning of the previous title/chapter/track/file.

### Note

- There are some discs and files for which skipping is not possible.

## Playing in slow motion



▶ **While playback is paused, press and hold ◀◀/◀I or I▶/I▶▶.**



- The speed switches each time the button is pressed (the speed is displayed on the TV screen). The speed steps depend on the disc.

### Note

- It is not possible to switch the speed during reverse slow motion playback.
- No sound is output during slow motion playback.
- For some discs, normal playback resumes automatically when the chapter switches.
- There are some discs for which slow motion playback is not possible.

### ❖ To resume normal playback

▶ **Press ▶ PLAY.**

## Step forward and step reverse



▶ **While playback is paused, press ◀◀/◀I or I▶/I▶▶.**



- The disc moves a step forward or reverse each time the button is pressed.

### Note

- For some discs, normal playback resumes automatically when the chapter switches.
- There are some discs and files for which step forward/reverse playback is not possible.

### ❖ To resume normal playback

▶ **Press ▶ PLAY.**

## 04 Switching the camera angles

For BD-ROM and DVD-Video discs on which multiple angles are recorded, the angles can be switched during playback.



▶ During playback, press **ANGLE**.

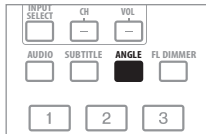

- The current angle and total number of recorded angles are displayed on the TV screen and on the player's front panel display. When pressed again, the angle switches.

**Example:** Current angle/Total number of recorded angles

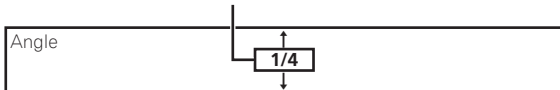

- The angles can also be switched using  $\uparrow/\downarrow$ .
- The angles can also be switched by selecting **Angle** from the **TOOLS** menu.
- Angle mark is displayed for scenes at which multiple angles are recorded.

### Note

- For some discs, the angle can also be switched on the menu screen.
- Angle mark is not displayed if **Angle/Secondary Indicator** is set to **Off** (page 42).

## Switching the subtitles

For discs on which multiple subtitles are recorded, the subtitles can be switched during playback.



▶ During playback, press **SUBTITLE**.

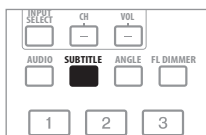

- The current subtitles and total number of recorded subtitles are displayed on the TV screen and on the player's front panel display. When pressed again, the subtitle switches.

**Example:** Current subtitle/Total number of recorded subtitles

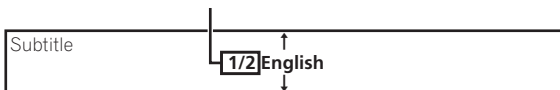

- The subtitles can also be switched using  $\uparrow/\downarrow$ .
- The subtitles can also be switched by selecting **Subtitle** from the **TOOLS** menu.

### Note

- The types of recorded subtitles depend on the disc.
- If the subtitles are not switched when **SUBTITLE** is pressed, switch them from the menu screen.

## Turning the subtitles off

▶ Press **SUBTITLE**, then press **CLEAR**.

## Switching the audio streams/channels

For discs on which multiple audio streams/channels are recorded, audio streams/channels can be switched during playback. Also use this procedure to switch the secondary audio for BD-ROMs on which secondary audio is recorded.



▶ During playback, press **AUDIO**.

- To switch the secondary audio, press **SECONDARY AUDIO**.

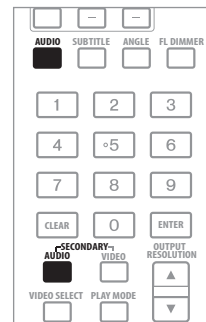

- The current audio streams/channels and total number of recorded audio streams/channels are displayed on the TV screen and on the player's front panel display. When pressed again, the audio stream/channel switches.

**Example:** Current audio stream/Total number of recorded audio streams

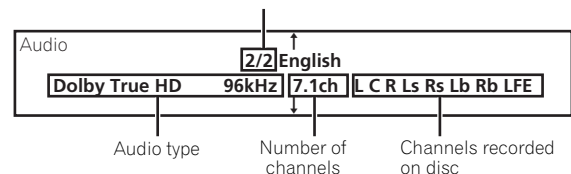

- The audio streams/channels can also be switched using  $\uparrow/\downarrow$ .
- The audio streams/channels can also be switched by selecting **Audio** or **Secondary Audio** from the **TOOLS** menu.
- Secondary audio mark is displayed for scenes at which secondary audio is recorded.



**Note**

- The types of recorded audio streams/channels depend on the disc.
- If the audio stream/channel is not switched when **AUDIO** is pressed, switch it from the menu screen.
- Some BD-ROMs do not include secondary audio.
- Secondary audio mark  is not displayed if **Angle/Secondary Indicator** is set to **Off** (page 42).

## Switching the secondary video

Use the procedure below to switch the secondary video (Picture-in-Picture) recorded on the BD-ROM.



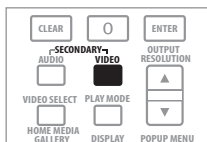

- ▶ During playback, press **SECONDARY VIDEO**.

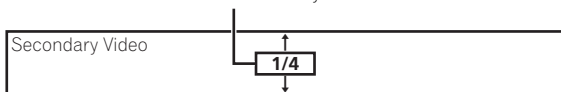

- The current secondary video stream and total number of recorded secondary video streams are displayed on the TV screen and on the player's front panel display. When pressed again, the secondary video stream switches.

**Example:** Current secondary video stream/Total number of recorded secondary video streams



- The secondary video streams can also be switched using **↑/↓**.
- The secondary video streams can also be switched by selecting **Secondary Video** from the **TOOLS** menu.
- Secondary video mark  is displayed for scenes at which secondary video is recorded.

**Note**

- Some BD-ROMs do not include secondary video.
- Secondary video mark  is not displayed if **Angle/Secondary Indicator** is set to **Off** (page 42).

## Displaying the disc information



- ▶ Press **DISPLAY**.

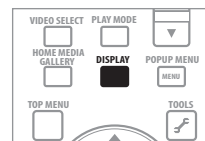

The disc information appears on the TV screen. The information switches each time the button is pressed.

The information display differs during playback and when playback is stopped.

## Using the Play Mode functions

### Playing from a specific time (Time Search)

- 1 During playback, press **PLAY MODE** to display the Play Mode screen.

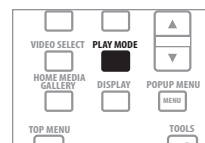

The Play Mode screen can also be displayed by selecting **Play Mode** from the **TOOLS** menu.

- 2 Select **Time Search**.

Use **↑/↓** to select, then press **ENTER**.

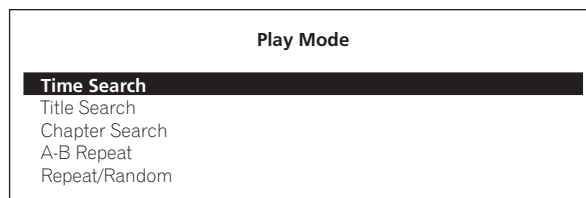
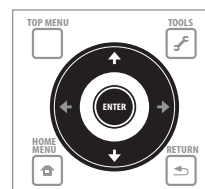

### 3 Input the time.

Use the number buttons (0 to 9) or  $\uparrow/\downarrow$  to input the time.

Use  $\leftarrow/\rightarrow$  to move the cursor.

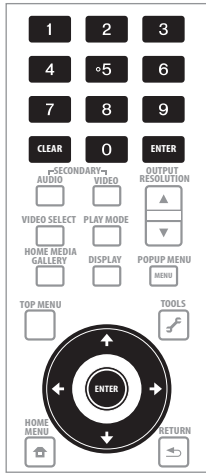

#### Note

- To play from 45 minutes, input **0, 0, 4, 5, 0** and **0**, then press **ENTER**.
- To play from 1 hour 20 minutes, input **0, 1, 2, 0, 0** and **0**, then press **ENTER**.
- Press **CLEAR** to clear the values you have input.

### 4 Starting playback from the specified time.

Use  $\leftarrow/\rightarrow$  to select **Search**, then press **ENTER**.

#### ❖ To cancel Time Search

Press **PLAY MODE** or  $\leftarrow$  **RETURN**.

#### Note

- There are some discs for which Time Search is not available.

## Playing a specific title, chapter or track (Search)

### 1 Press PLAY MODE to display the Play Mode screen.

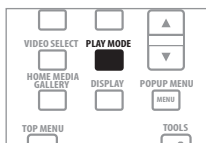

The Play Mode screen can also be displayed by selecting **Play Mode** from the **TOOLS** menu.

### 2 Select the type of search.

Use  $\uparrow/\downarrow$  to select, then press **ENTER**.

See the table on page 33 for the search types.

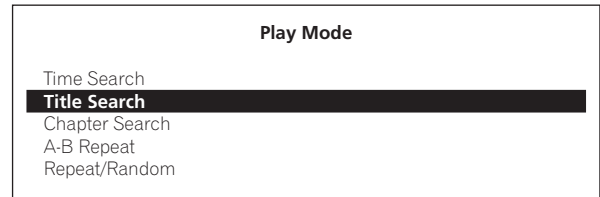
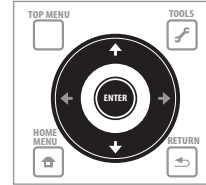

### 3 Input the number.

Use the number buttons (0 to 9) or  $\uparrow/\downarrow$  to input the number.

Use  $\leftarrow/\rightarrow$  to move the cursor.

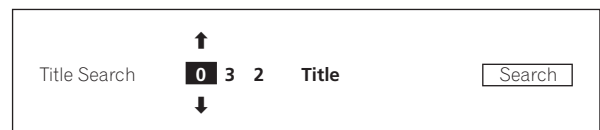
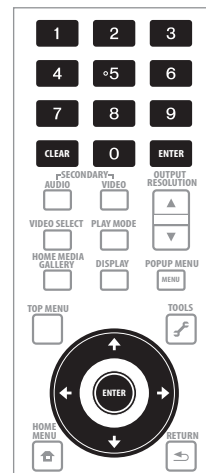

### 4 Starting playback from the specified title, chapter or track.

Use  $\leftarrow/\rightarrow$  to select **Search**, then press **ENTER**.

#### ❖ To cancel the search

▶ Press **PLAY MODE** or  $\leftarrow$  **RETURN**.

#### Note

- To search for title 32, input **0, 3** and **2**, then press **ENTER**.
- There are some discs for which searching is not available.
- Press **CLEAR** to clear the values you have input.

## Playing a specific section within a title or track repeatedly (A-B Repeat)

Use this procedure to play a specific section within a title or track repeatedly.

### 1 During playback, press PLAY MODE to display the Play Mode screen.

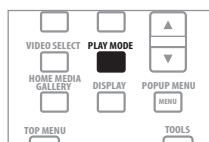

The Play Mode screen can also be displayed by selecting **Play Mode** from the **TOOLS** menu.

### 2 Select A-B Repeat.

Use **↑/↓** to select, then press **ENTER**.

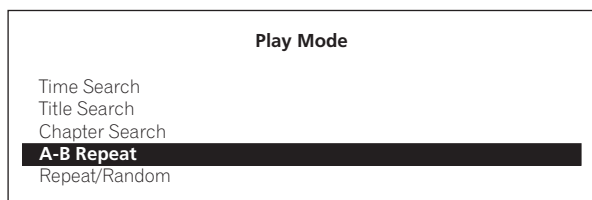

### 3 Select the starting point for A-B Repeat.

Use **←/→** to select **A (Start)**, then press **ENTER**.

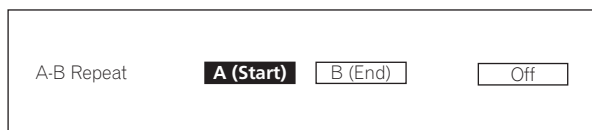

### 4 Select the end point for A-B Repeat.

Use **←/→** to select **B (End)**, then press **ENTER**.

A-B Repeat playback starts.

### ❖ To cancel A-B Repeat play

- Select **Off** from the Repeat/Random screen, then press **ENTER**.
- During playback, press **■ STOP** or **CLEAR**.

#### Note

- A-B Repeat play is canceled in the following cases:
  - When the angle is switched (for BD-ROM and DVD-Video discs only).
  - When you search outside the repeat range.
  - When you start other repeat or random play.

## Playing repeatedly (Repeat Play)

Use this procedure to play the currently playing disc, title, chapter, track or file repeatedly.

### 1 During playback, press PLAY MODE to display the Play Mode screen.

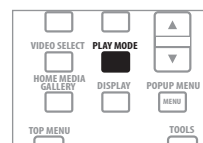

The Play Mode screen can also be displayed by selecting **Play Mode** from the **TOOLS** menu.

### 2 Select Repeat/Random.

Use **↑/↓** to select, then press **ENTER**.

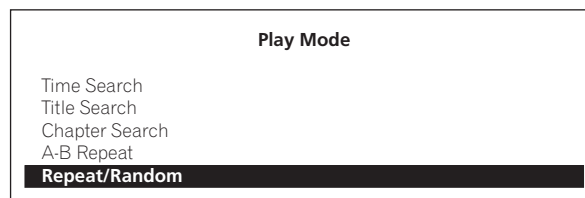
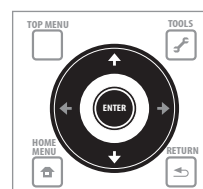

### 3 Select the type of Repeat Play.

Use **↑/↓** to select, then press **ENTER**.

See the table on page 33 for the types of repeat playback.

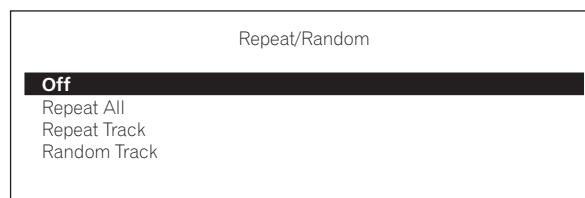

### ❖ To cancel Repeat Play

- Select **Off** from the Repeat/Random screen, then press **ENTER**.
- During playback, press **■ STOP** or **CLEAR**.

#### Note

- There are some discs and files for which Repeat Play is not available.
- The type of repeat modes depends on the disc and file being played. See the table on page 33.
- Repeat Play is canceled in the following cases:
  - When the angle is switched (for BD-ROM and DVD-Video discs only).
  - When you search outside the repeat range.
  - When you start other repeat or random play.

## 04 Playing in random order (Random Play)

Use this procedure to play the tracks or files in random order.

**1 During playback, press PLAY MODE to display the Play Mode screen.**

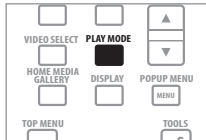

The Play Mode screen can also be displayed by selecting **Play Mode** from the **TOOLS** menu.

**2 Select Repeat/Random.**

Use **↑/↓** to select, then press **ENTER**.

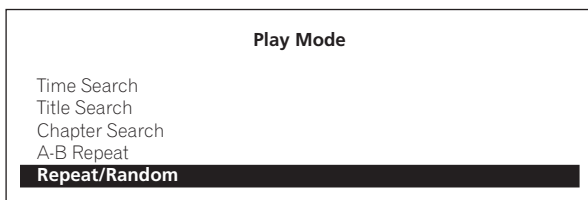
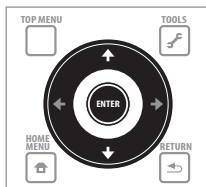

**3 Select the Random Play.**

Use **↑/↓** to select, then press **ENTER**.

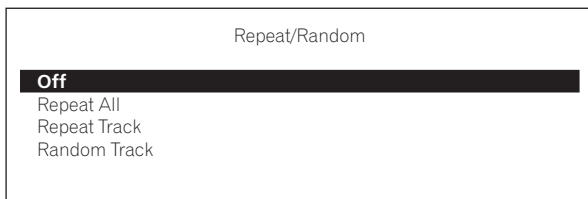

### ❖ To cancel Random Play





- Select **Off** from the Repeat/Random screen, then press **ENTER**.
- During playback, press **■ STOP** or **CLEAR**.

#### Note

- There are some discs and files for which Random Play is not available.
- Random Play is canceled in the following cases:
  - When you use the search function.
  - When you start repeat play.

## About Play Mode types

The functions that can be used differ according to the type of disc and file. In some cases, some of the functions cannot be used. Check the usable functions on the table below.

Play Mode type	Mark <sup>1</sup>	Disc/file type							
		BD-ROM <sup>2</sup>	BD-R BD-RE	DVD- Video <sup>2</sup>	DVD-R DVD-RW (VR format)	AVCHD	Music file	CD	
Repeat play	Playing a specific section within a title or track repeatedly (A-B Repeat)	A-B	✓	✓	✓	✓	✓	✗	✓
	Playing a title repeatedly (Title Repeat)		✓	✓	✓	✓	✓	✗	✗
	Playing a chapter repeatedly (Chapter Repeat)		✓	✓	✓	✓	✓	✗	✗
	Playing a track or file repeatedly (Track Repeat)		✗	✗	✗	✗	✗	✓	✓
	Playing all the titles, tracks or files on the disc repeatedly (All Repeat)		✗	✓	✗	✓ <sup>3</sup>	✗	✓ <sup>4</sup>	✓
Random play	Playing the tracks or files in random order (Random Track)	RDM	✗	✗	✗	✗	✗	✓	✓
Search	Playing from a specific time (Time Search)	—	✓	✓	✓	✓	✓	✗	✓
	Playing a specific title (Title Search)	—	✓	✓	✓	✓	✓	✗	✗
	Playing a specific chapter (Chapter Search)	—	✓	✓	✓	✓	✓	✗	✗
	Playing a specific track (Track Search)	—	✗	✗	✗	✗	✗	✗	✓

1. During playback in a Play Mode, the type of Play Mode is indicated by the mark.
2. For BD-ROM and DVD-Video discs, some of the functions cannot be used with some titles.
3. The original titles are played repeatedly. However, the playlist titles cannot be played repeatedly.
4. The files in the folder or HMG Playlist are played repeatedly.

## 04 Playing from the Home Media Gallery

The Home Media Gallery lets you display a list of the titles, tracks or files recorded on the disc. The discs that can be played from the Home Media Gallery are as shown below (see also page 8).

- BD-R/-RE discs
- DVDs recorded in VR format
- Music CDs (CD-DAs and DTS-CDs)
- DVDs/CDs on which only data files of music files, etc. are recorded

### Playing discs

**1 Press HOME MEDIA GALLERY to display the Home Media Gallery.**

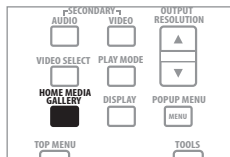

The Home Media Gallery can also be displayed by selecting **Home Media Gallery** from Home Menu then pressing **ENTER**.

**2 Select the disc.**

Use **↑/↓** to select, then press **ENTER**.

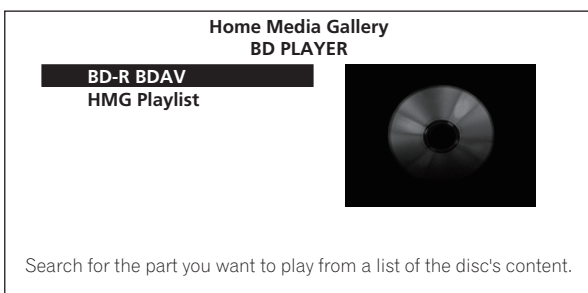
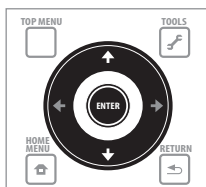

**3 Select the title or track to be played.**

Use **↑/↓** to select, then press **ENTER**.

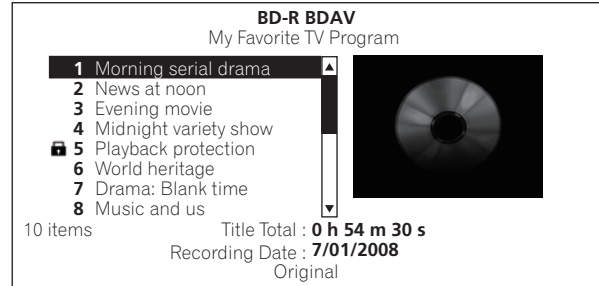

Playback starts.

### ❖ Closing the Home Media Gallery

Press **HOME MEDIA GALLERY** (or **HOME MENU**).

#### Note

- When playing a music CD (CD-DA or DTS-CD), the Now Playing screen is displayed.
- Some BD-R/-RE discs have playback protection. To cancel the protection, input the password set for the disc.
- To play DVD-R/-RW (VR format) playlists, switch to the playlist using the **Original/Play List** command on the **TOOLS** menu (page 23).

### Playing music files

**1 Press HOME MEDIA GALLERY to display the Home Media Gallery.**

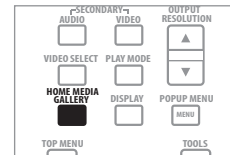

The Home Media Gallery can also be displayed by selecting **Home Media Gallery** from Home Menu then pressing **ENTER**.

**2 Select the disc.**

Use **↑/↓** to select, then press **ENTER**.

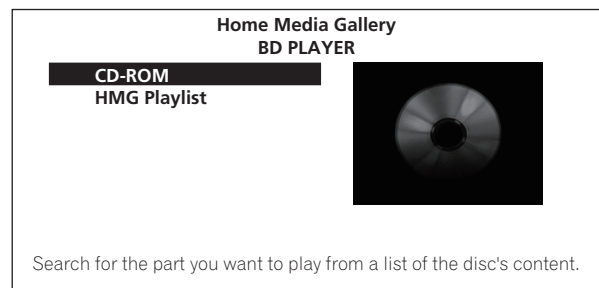
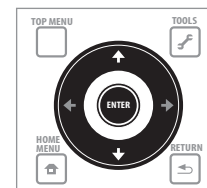

**3 Select Music.**

Press **ENTER**.

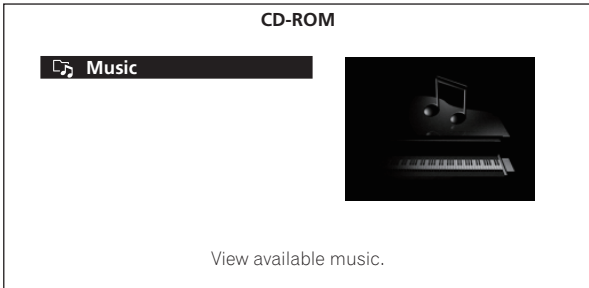

**4 Select Folders or All Songs.**

Use **↑/↓** to select, then press **ENTER**.

- **Folders** – The files in the selected folder are displayed.
- **All Songs** – All the recorded files are displayed.

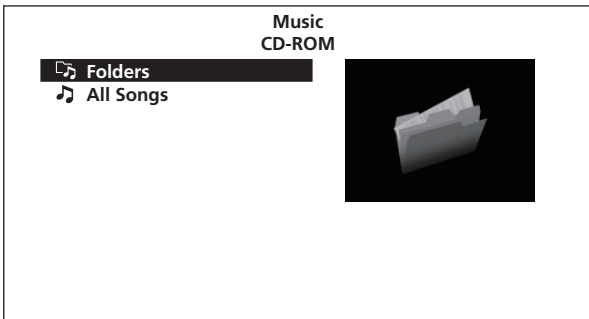

If you have selected **All Songs**, proceed to step 6.

**5 Select the folder containing the file you want to play.**

Use **↑/↓** to select, then press **ENTER**.

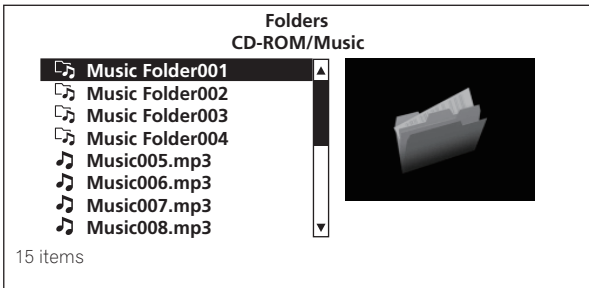

A list of the files in the selected folder (or in the folders below it) is displayed.

**6 Select and set the file you want to play.**

Use **↑/↓** to select, then press **ENTER**.

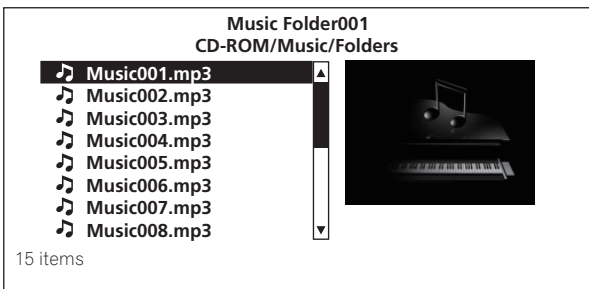

Playback starts. The Now Playing screen (shown below) is displayed.

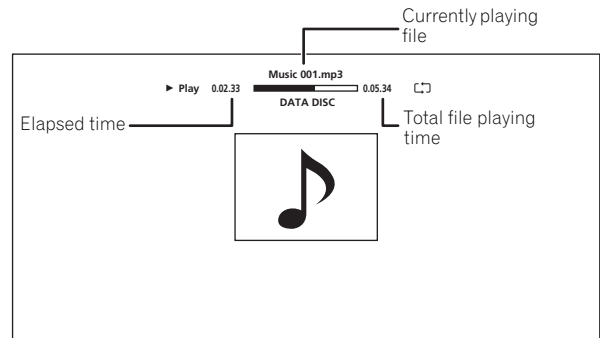

**Playing in the desired order (HMG Playlist)**

The discs that can add tracks and files to the HMG (Home Media Gallery) Playlist are as shown below.

- Music CDs (CD-DAs and DTS-CDs)
- DVDs/CDs on music files are recorded

**❖ Adding tracks/files**

Use this procedure to add tracks and files, and create the HMG Playlist.

**1 Press HOME MEDIA GALLERY to display the Home Media Gallery.**

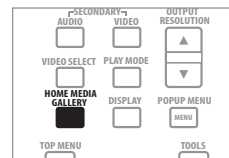

The Home Media Gallery can also be displayed by selecting **Home Media Gallery** from Home Menu pressing **ENTER**.

**2 Select the disc.**

Load the disc beforehand.

Use **↑/↓** to select, then press **ENTER**.

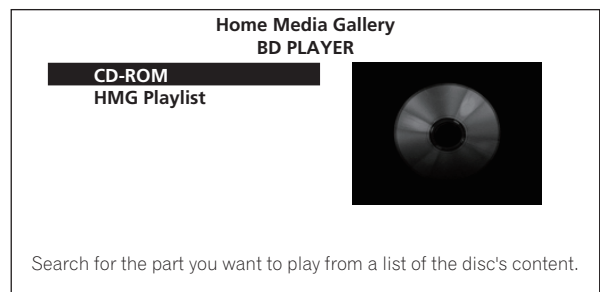
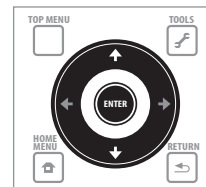

### 3 Select the track/file to be added.

Use  $\uparrow/\downarrow$  to select.

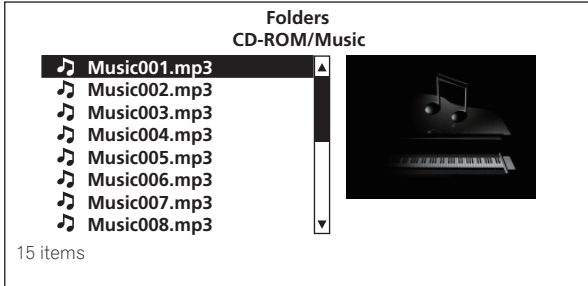

### 4 Press $\mathcal{F}$ TOOLS to display the TOOLS menu.

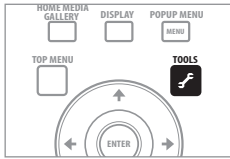

### 5 Select Add to HMG Playlist.

Use  $\uparrow/\downarrow$  to select, then press ENTER.

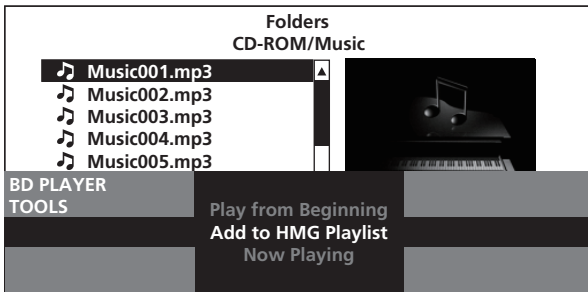

The track or file selected in step 3 is added to the HMG Playlist. To add more tracks or files, repeat steps 3 to 5.

## ❖ To add the currently playing track/file to the HMG Playlist

- ▶ While the track/file is playing, press  $\mathcal{F}$  TOOLS to display the TOOLS menu.
- ▶ Use  $\uparrow/\downarrow$  to select Add to HMG Playlist, then press ENTER.

### Note

- A maximum of 24 tracks/files can be added to the HMG Playlist.
- The HMG Playlist is cleared in the following cases:
  - When the power is turned off.
  - When the disc tray is opened.

## ❖ Playing the HMG Playlist

- 1 Press HOME MEDIA GALLERY to display the Home Media Gallery.

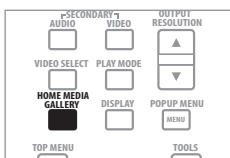

The Home Media Gallery can also be displayed by selecting **Home Media Gallery** from Home Menu pressing ENTER.

### 2 Select HMG Playlist.

Use  $\uparrow/\downarrow$  to select, then press ENTER.

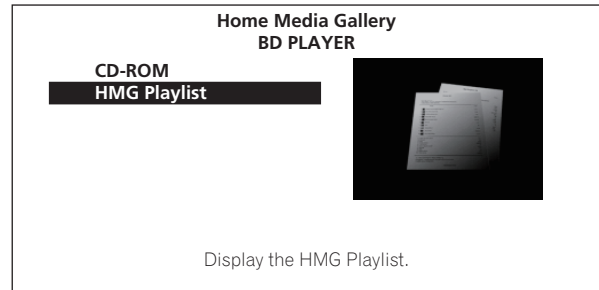

Display the HMG Playlist.

### 3 Select the track/file to be played.

Use  $\uparrow/\downarrow$  to select, then press ENTER.

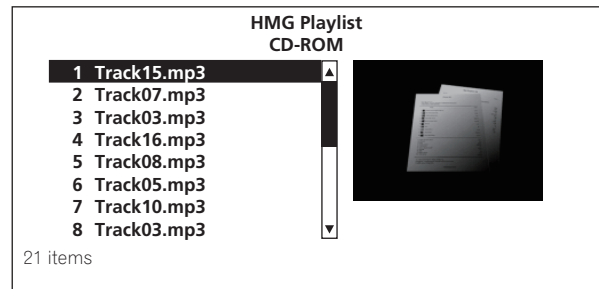

Playback starts. The Now Playing screen (shown below) is displayed.

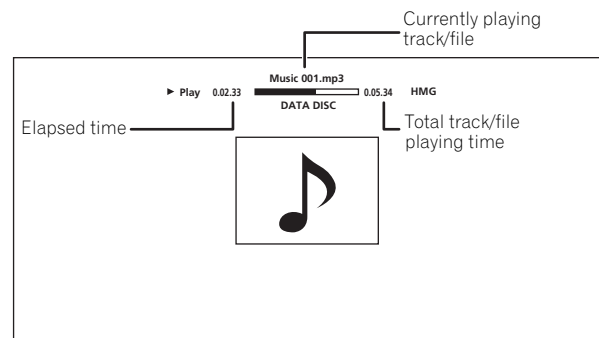

Press  $\blacksquare$  STOP to stop playback. When a music CD is stopped, the Now Playing screen turns off. When a music file is stopped, the HMG Playlist screen reappears.

## ❖ Deleting tracks/files from the HMG Playlist

- ▶ Select the track/file to be deleted, then press  $\mathcal{F}$  TOOLS to display the TOOLS menu.
- ▶ Use  $\uparrow/\downarrow$  to select Delete from HMG Playlist, then press ENTER.



# Chapter 5 Adjusting audio and video

## Adjusting the video

The quality of the playback picture can be adjusted according to the TV you are using.

**1 During playback, press VIDEO ADJUST to display the Video Adjust screen.**

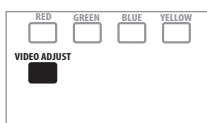

The Video Adjust screen can also be displayed by selecting **Video Adjust** from the **TOOLS** menu.

**2 Select a preset.**

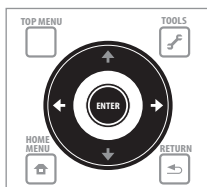

Select using  $\leftarrow/\rightarrow$  according to the TV being used.



- **LCD** – Select this when connected to a liquid crystal display TV.
- **PDP** – Select this when connected to a plasma TV of another brand.
- **Pioneer PDP** – Select this when connected to a Pioneer plasma TV.
- **Projector** – Select this when connected to a front projector.
- **Professional** – With this setting, video signal processing is restrained. Select this when connected to a professional monitor.
- **Memory1 to 3** – Picture quality settings with adjusted parameters can be stored in the memory. For a description of the parameters, see *When Memory1, 2 or 3 is selected* below.

### ❖ When Memory1, 2 or 3 is selected

**1 Select Adjustments.**

Use  $\downarrow$  to select **Adjustments**, then press **ENTER**.

A detailed settings screen appears.

**2 Select the item to be adjusted.**

Use  $\uparrow/\downarrow$  to select.

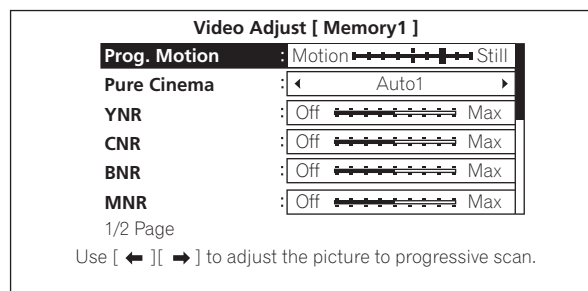

**3 Adjust the picture quality.**

When  $\leftarrow/\rightarrow$  are pressed, the adjustments can be made watching the picture. The detailed settings screen reappears when **ENTER** is pressed.



- **Prog.Motion** – Adjust according to the type of image (movie or still image). This is effective when outputting video materials as progressive images.
- **Pure Cinema** – This setting optimizes the operation of the progressive scanning circuit for playing film materials. Normally set it to **Auto1**. If the picture seems unnatural, switch this to **Auto 2, On** or **Off** (page 38).
- **YNR** – Reduces noise in the luminance (Y) signal.
- **CNR** – Reduces noise in the chroma (C) signal.
- **BNR** – Reduces the block noise (block-shaped distortion generated upon MPEG compression).
- **MNR** – Reduces the mosquito noise (distortion along the contours of the picture generated upon MPEG compression).
- **Detail** – Emphasizes the picture's contours.
- **Black Setup** – Select the black level as the setup level. Normally select **7.5 IRE**. If the black level is too bright due to the combination with the connected monitor, select **0 IRE**.
- **Gamma Correction** – Adjusts how the dark portions of the picture look.
- **White Level** – Adjusts the level of the white portions.
- **Black Level** – Adjusts the level of the black portions.
- **Hue** – Adjusts the balance between green and red.
- **Chroma Level** – Adjusts the density of the colors.

### Note

- **Prog.Motion** and **Pure Cinema** have the effect only for pictures recorded in the interlaced scan format (480i or 1080i signals).
- **Prog.Motion** is disabled when **Pure Cinema** is set to **On**.
- **Black Setup** have the effect only for pictures output from the **VIDEO** and **S-VIDEO** output terminals.
- **YNR, CNR, BNR** and **MNR** have no effect for 1080/24p signals output from the **HDMI OUT** terminal.

## ❖ Closing the Video Adjust screen

Press  HOME MENU.

### ❖ About Pure Cinema

There are two types of video signals:

- **Video material** – Video signals recorded at 30 frames/second
- **Film material** – Video signals recorded at 24 frames/second

“Pure Cinema” uses signal processing suited for “film material” when converting 480i or 1080i interlaced video signals into progressive video signals, resulting in clear picture reproduction without losing the quality of the material.

 is displayed on the disc information screen when playing the “film material” pictures of DVD-Video discs (page 29).

## Adjusting the Audio DRC

Audio DRC (Dynamic Range Control) has the effect of playing loud sounds softly and soft sounds loudly. Adjust the setting for example when watching movies late at night and the dialogues are difficult to hear.

### 1 During playback, display the TOOLS menu.

Press  TOOLS.

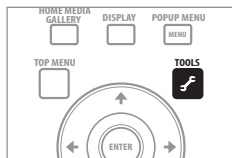

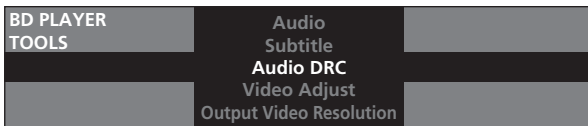
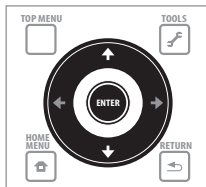

### 2 Select and set Audio DRC.

Use  to select, then press ENTER.

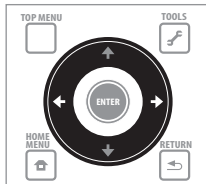

### 3 Adjust the setting.



Use  to switch between **Off**, **Low**, **Medium**, **High** and **Auto**.

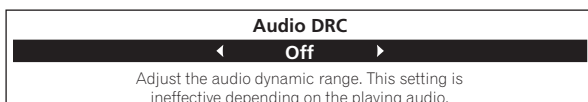

## ❖ Closing the Audio DRC screen

Press ENTER or  HOME MENU.

### Note

- This only affects the Dolby TrueHD, Dolby Digital Plus and Dolby Digital audio signals of BDs and DVDs.
- When **Auto** is selected, the setting has the same effect as **High** or **Off** for Dolby TrueHD signals, depending on the content. For Dolby Digital Plus and Dolby Digital, the setting has the same effect as **Off**.
- Audio DRC affects the audio signals output from the following audio output terminals:
  - Analog audio signals output from the **AUDIO OUT (2 ch)** or **AUDIO OUT (7.1 ch)** terminals.
  - Linear PCM audio signals output from the **DIGITAL OUT** terminals or **HDMI OUT** terminal.
- The effect may be weak for some discs.

## Chapter 6

# Advanced settings

## Changing the settings (Initial Setup)

### Operating the Initial Setup screen

1 When playback is stopped, display the Home Menu screen.

Press  HOME MENU.



2 Select and set Initial Setup.

Use  to select, then press **ENTER**.

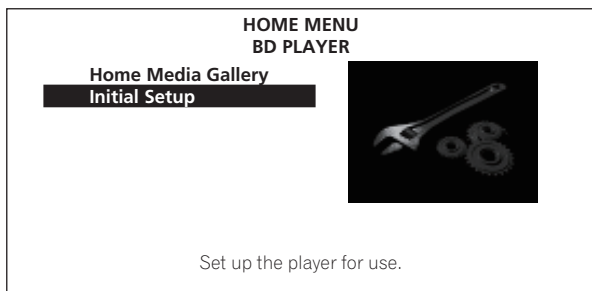
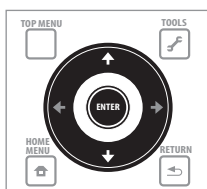

3 Select the item and change the setting.

Use  to select, then press **ENTER**.

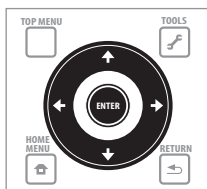

### ❖ Closing the Initial Setup screen

Press  HOME MENU.

 **Note**

- Items that cannot be changed are indicated in gray. The items that can be selected depend on the player's status.
- The factory default settings are indicated in bold.

	Setting	Options	Explanation
Video Out	TV Aspect Ratio	<b>16:9 (Widescreen)</b>	Select this when connected to a wide (16:9) TV.
		4:3 (Standard)	Select this when connected to a conventional TV.
	4:3 Video Out	<b>Full</b>	4:3 pictures are displayed over the entire screen.
		Normal	4:3 pictures are displayed with black bands along the sides. Select this when you cannot switch the aspect ratio to 4:3 on the TV.
DVD 16:9 Video Out	<b>Letter Box</b>	16:9 pictures are displayed with black bands at the top and bottom. Select this when watching on a 4:3 screen.	
	Pan & Scan	The picture is displayed over the entire screen, with the left and right sides of the 16:9 picture cut off. Select this to watch 4:3 pictures over the entire screen.	
Still Picture		Field	This eliminates instability of the picture when playback is paused.
		Frame	This makes pictures clear when playback is paused, but instability may be observed.
		<b>Auto</b>	Field and Frame is selected automatically according to the disc being played.
Audio Out	Dolby Digital Out * Only valid for digital audio outputs.	<b>Dolby Digital 1</b>	Dolby Digital audio signals are output. With BD-ROM discs, the secondary audio and interactive audio are mixed for output.
		Dolby Digital 2	Dolby Digital audio signals are output. With BD-ROMs, the signals are output without mixing the secondary audio and interactive audio signals.
		Dolby Digital → PCM	Select this when the connected AV receiver or amplifier, etc., is not compatible with Dolby Digital audio signals. The Dolby Digital audio signals are converted into linear PCM audio signals for output.
DTS Out * Only valid for digital audio outputs.		<b>DTS 1</b>	DTS Digital Surround audio signals are output. With BD-ROM discs, the secondary audio and interactive audio are mixed for output.
		DTS 2	DTS Digital Surround audio signals are output. With BD-ROMs, the signals are output without mixing the secondary audio and interactive audio signals.
		DTS → PCM	Select this when the connected AV receiver or amplifier, etc., is not compatible with DTS Digital Surround audio signals. The DTS Digital Surround audio signals are converted into linear PCM audio signals for output.
AAC Out * Only valid for digital audio outputs.		AAC	Select this when the connected AV receiver or amplifier, etc., is compatible with AAC audio signals. The AAC audio signals are output.
		<b>AAC → PCM</b>	Select this when the connected AV receiver or amplifier, etc., is not compatible with AAC audio signals. The AAC audio signals are converted into linear PCM audio signals for output.
DTS Downmix		<b>Stereo</b>	DTS-HD Master Audio signals, DTS-HD High Resolution Audio signals or DTS Digital Surround audio signals converted to linear PCM audio signals are converted into 2-channel (stereo) signals for output.
		Lt/Rt	DTS-HD Master Audio signals, DTS-HD High Resolution Audio signals or DTS Digital Surround audio signals converted to linear PCM audio signals are converted into 2-channel signals compatible with Dolby Surround for output (when the connected AV receiver or amplifier, etc., is compatible with Dolby Pro Logic, the AV receiver or amplifier outputs the linear PCM audio signals as surround audio signals).
Speakers	Audio Output Mode	<b>2 Channel</b>	Select this when the TV's analog 2-channel (stereo) audio input terminals are connected to the player's <b>AUDIO OUT (2 ch)</b> terminals.
		Multi-channel	Select this when the multi-channel audio input terminals of an AV receiver or amplifier, etc., are connected to the player's <b>AUDIO OUT (7.1 ch)</b> terminals.
	Speaker Setup	When an AV receiver or amplifier, etc., is connected to the player's <b>AUDIO OUT (7.1 ch)</b> terminals, this sets whether or not to use the speakers which are connected to the AV receiver or amplifier, as well as the size of the speakers. For details, see <i>Changing the speaker setup</i> on page 43.	
	Channel Level	<b>Fix</b>	The output for the various speakers is set to the maximum.
Variable		The output level of the various speakers is set within the range of -6.0 dB to +6.0 dB (in 0.5 dB steps) (page 44).	

Setting	Options	Explanation	
HDMI	HDMI High-Speed Transmission	On Off	Select this when connected with a High Speed HDMI™ cable (page 15). Select this when connected with a Standard HDMI™ cable (page 15).
	The player's setting screen is closed if the output video resolution is switched by changing the <b>HDMI High-Speed Transmission</b> setting.		
HDMI Color Space	Auto	The video signal that is output (YCbCr or RGB) is switched automatically.	
	YCbCr 4:4:4	Select this to output the video signals as YCbCr 4:4:4 signals.	
	YCbCr 4:2:2	Select this to output the video signals as YCbCr 4:2:2 signals.	
	RGB (16 to 235)	Select this to output the video signals as RGB signals. Choose this if the colors seem too dense and all the dark colors are displayed in a uniform black when RGB (0 – 255) is selected.	
	RGB (0 to 255)	Select this to output the video signals as RGB signals. Choose this if the colors seem too faint and the black too bright when RGB (16 – 235) is selected.	
Normally it is recommended to set this to <b>Auto</b> . When set to <b>Auto</b> , the optimum video signals for your TV are output.			
HDMI Audio Out	Auto	The signals are output with as many audio channels as possible. In cases when the number of channels does not decrease when the signals are output as such without converting them to linear PCM, they are output as such (page 50).	
	PCM	Select this when you want the secondary audio and interactive audio signals to be mixed for output or when you want to output prioritizing sampling frequency over the number of channels (page 50).	
PQLS	Auto	Enables PQLS function (page 15).	
	Off	Disables PQLS function (page 15).	
HDMI Control	On	Select this to control the player with the remote control of the AV device connected using an HDMI cable. Also refer to <i>About HDMI Control function</i> on page 15.	
	Off	Select this when you do not want to control the player with the remote control of the AV device connected using an HDMI cable.	
Language	OSD Language	English	Select this to set the language of the on-screen displays to English.
		available languages	Choose a language for the on-screen displays from the listed languages.
	Audio Language * For some discs, it may not be possible to change to the selected language.	English	Select this to set both the BD-ROM and DVD-Video default audio language to English.
		available languages	Choose a language from the listed languages to set the default audio language for BD-ROM and DVD-Video playback.
		Other	Continue to the next screen to set the default audio language for BD-ROM and DVD-Video disc playback. You can select the language name or enter the code number (see on page 56 for the code table). If a language not recorded on the BD/DVD is set, one of the recorded languages is automatically selected and played.
	Subtitle Language * For some discs, it may not be possible to change to the selected language.	English	Select this to set the default subtitle language for BD-ROM and DVD-Video playback to English.
		available languages	Choose a language from the listed languages to set the default subtitle language for BD-ROM and DVD-Video playback.
		Other	Continue to the next screen to set the default subtitle language for BD-ROM and DVD-Video disc playback. You can select the language name or enter the code number (see on page 56 for the code table). If a language not recorded on the BD/DVD is set, one of the recorded languages is automatically selected and played.
	BDMV/DVD-Video Menu Lang. * For some discs, it may not be possible to change to the selected language.	w/Subtitle Language	Sets the language of BD-ROM and DVD-Video menus to the same as that set for the subtitle language.
		available languages	Choose a language from the listed languages to set the default language for BD-ROM and DVD-Video menus.
Other		Continue to the next screen to set the default menu language for BD-ROM and DVD-Video disc menus. You can select the language name or enter the code number (see on page 56 for the code table). If a language not recorded on the BD/DVD is set, one of the recorded languages is automatically selected and played.	
Subtitle Display	On	Select this to display the subtitles.	
	Off	Select this if you do not want to display the subtitles. Note that on some discs the subtitles are displayed by force.	
Parental Lock	Set Password (Change Password)	Register (change) the password for parental lock settings or for unlocking to play DVD-Video with parental lock feature. For details, see <i>Registering or Changing the password</i> on page 44.	
	DVD-Video Parental Lock	Change the player's parental lock level. For details, see <i>Changing the Parental Lock level for watching DVDs</i> on page 46.	
	BDMV Parental Lock	Change the restricted age. For details, see <i>Changing the Age Restriction for watching BD-ROMs</i> on page 45.	
	Country Code	Change the Country/Area code. Refer to the <i>Changing the Country/Area code</i> on page 47.	

Setting	Options	Explanation	
Options	Output Terminal Priority	Select the terminals for outputting video and audio signals with priority. For details, see <i>Changing the terminals for outputting video and audio signals (Output Terminal Priority)</i> on page 48.	
	On Screen Display	<b>On</b>	Select this to display the operation indicators (Play, Stop, etc.) on the TV screen.
		Off	Select this if you do not want to display the operation indicators (Play, Stop, etc.) on the TV screen.
	Angle/Secondary Indicator	<b>On</b>	Select this to display the angle mark, secondary video mark and secondary audio mark on the TV screen (pages 28 and 29).
		Off	Select this if you do not want to display the angle mark, secondary video mark and secondary audio mark on the TV screen.
	Hybrid Disc Playback	<b>BD</b>	The BD layer of hybrid discs with two or more layers (BD and DVD or CD) is played.
		DVD	The DVD layer of hybrid discs with two or more layers (BD and DVD) is played. If there is no DVD layer, the BD layer is played.
		CD	The CD layer of hybrid discs with two or more layers (BD and CD) is played. If there is no CD layer, the BD layer is played.
	BDMV/BDAV Playback Priority	BDMV	Select this to play the BDMV format on BD-R/RE discs containing both BDMV and BDAV formats.
		<b>BDAV</b>	Select this to play the BDAV format on BD-R/RE discs containing both BDMV and BDAV formats.
	Auto Power Off	<b>On</b>	Select this to turn the power off automatically (the power turns off automatically if no operation is performed for over 30 minutes).
		Off	Select this if you do not want the power to turn off automatically.
	Setup Navigator	Start making the settings using the Setup Navigator menu. For details, see <i>Making settings using the Setup Navigator menu</i> on page 20.	

# Changing to other language at language setting

### Note

- Refer to *Language Code Table* on page 56.
- If a language not recorded on the BD/DVD is set, one of the recorded languages is automatically selected and played.

#### 1 Select and set Other.

Use  $\uparrow/\downarrow$  to select, then press **ENTER**.

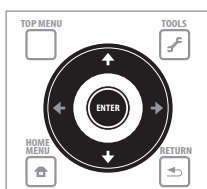

#### 2 Change the language.

Use  $\leftarrow/\rightarrow$  to change, then press **ENTER**.

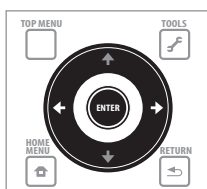

### ❖ To change the language using numbers

1 Use  $\uparrow/\downarrow$  to select Number.

2 Use the number buttons (0 to 9) to input the number, then press **ENTER**.

# Changing the speaker setup

### Note

- Select **Initial Setup** from the HOME MENU, then press **ENTER**.

#### 1 Select and set Speakers.

Use  $\uparrow/\downarrow$  to select, then press **ENTER**.

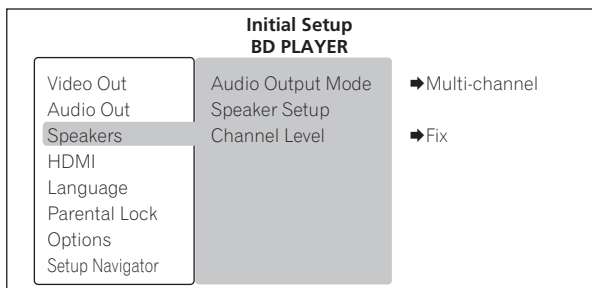
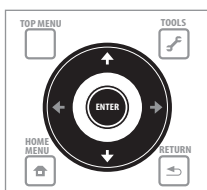

#### 2 Select and set Speaker Setup → Next Screen.

Use  $\uparrow/\downarrow$  to select, then press **ENTER**.

### ⚠ Caution

- This cannot be selected when **Audio Output Mode** is set to **2 Channel**. Change the setting to **Multi-channel** (page 40).

#### 3 Select the speaker and change the setting.

Use  $\uparrow/\downarrow$  to select, then use  $\leftarrow/\rightarrow$  to change the setting.

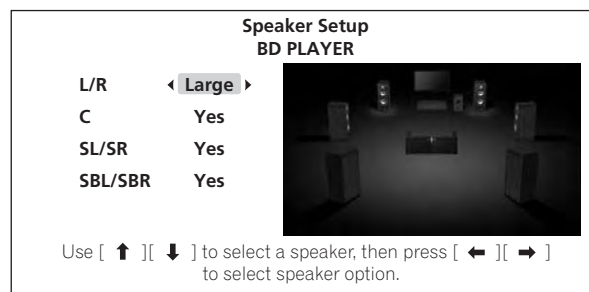
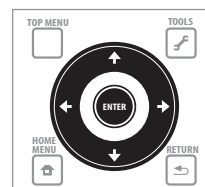

- **L/R** (front left and right speakers): **Small/Large** (this setting also applies to the C, SL/SR and SBL/SBR speakers).
- **C** (center speaker): **Yes/No**
- **SL/SR** (left and right surround speakers): **Yes/No**
- **SBL/SBR** (left and right surround back speakers): **Yes/No**

### ❖ Closing the speaker settings screen

Press **ENTER**.

## 06 Adjusting the output level of the various speakers (Channel Level)

Adjust each output level of the different speakers by using test tones.

### 1 Select and set Speakers.

Use **↑/↓** to select, then press **ENTER**.

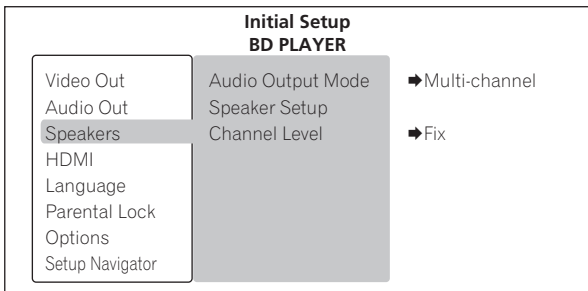
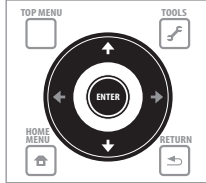

### 2 Select and set Channel Level, then Fix or Variable.

Use **↑/↓** to select, then press **ENTER**.

- **Fix** – The output level of all the speakers is set to the maximum.
- **Variable** – The output level of all the speakers is set 6.0 dB lower than when **Fix** is selected. From this point, the output levels of the **L, C, R, SL, SR, SBL, SBR** and **SW** speakers can be adjusted within the range of  $-6.0$  dB to  $+6.0$  dB.
- If you have selected **Variable**, proceed to step 3.

### ⚠ Caution

- This cannot be selected when **Audio Output Mode** is set to **2 Channel**. Change the setting to **Multi-channel** (page 40).

### 3 Select and set the method for switching the speaker to be adjusted.

Use **←/→** to select, then press **ENTER**.

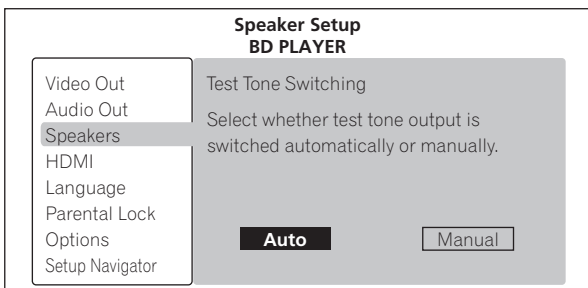
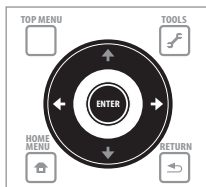

- **Auto** – Switch the speaker to be adjusted automatically.
- **Manual** – Switch the speaker to be adjusted manually.

### ⚠ Caution

- Test tones are output. Lower the volume of the device connected to the player.

### 4 Adjust the output level.

Use **↑/↓** to select, **←/→** to adjust.

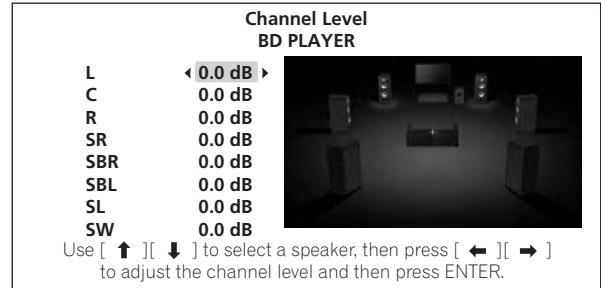

### ✎ Note

- When **Auto** is selected, the speaker cannot be selected with **↑/↓**.

### ❖ Closing the Channel Level screen

Press **ENTER**.

## Registering or Changing the password

Use this procedure to register or change the code number required for the Parental Lock settings.



### 1 Select and set Parental Lock.

Use **↑/↓** to select, then press **ENTER**.

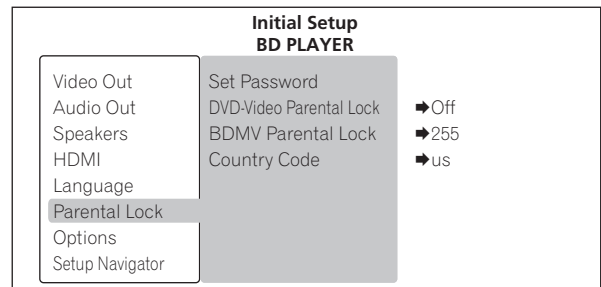
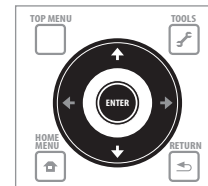

### 2 Select and set Set Password → Next Screen.

Use **↑/↓** to select, then press **ENTER**.



### 3 Input the password.

Use the number buttons (0 to 9) or **↑/↓** to input the number, then press **ENTER** to set.

Use **←/→** to move the cursor.

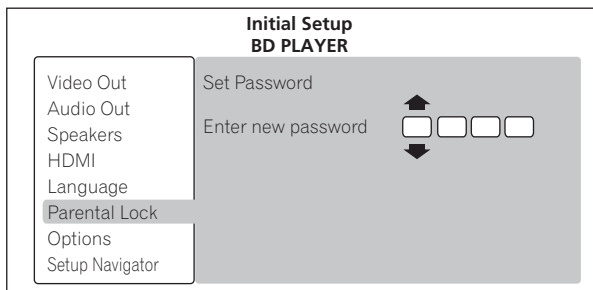
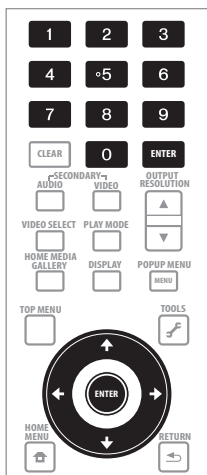

### 4 Re-input the password.

Use the number buttons (0 to 9) or **↑/↓** to input the number, then press **ENTER** to set.

Use **←/→** to move the cursor.

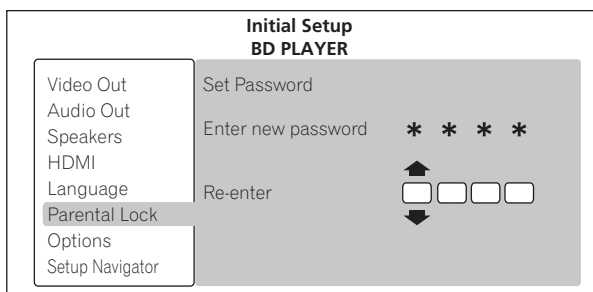

### ❖ To change the code number

Input the previously registered password, then input the new password.

#### Note

- We recommend making a note of the password.
- If you forget the password, reset the player to the factory default setting, then register the password again (page 49).

## Changing the Age Restriction for watching BD-ROMs

For BD-ROMs containing scenes of violence, for example, watching can be restricted by setting an age restriction for the BD-ROMs.



### 1 Select and set Parental Lock.

Use **↑/↓** to select, then press **ENTER**.

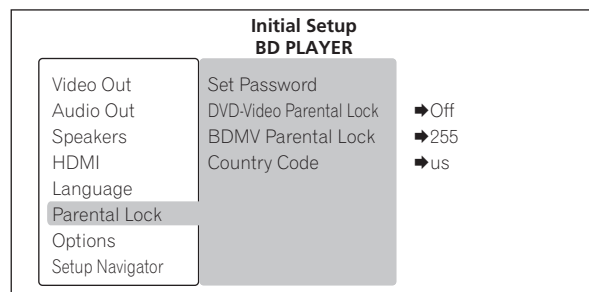
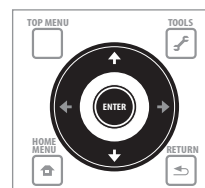

### 2 Select and set BDMV Parental Lock → Next Screen.

Use **↑/↓** to select, then press **ENTER**.

### 3 Input the password.

Use the number buttons (0 to 9) or **↑/↓** to input the number, then press **ENTER** to set.

Use **←/→** to move the cursor.

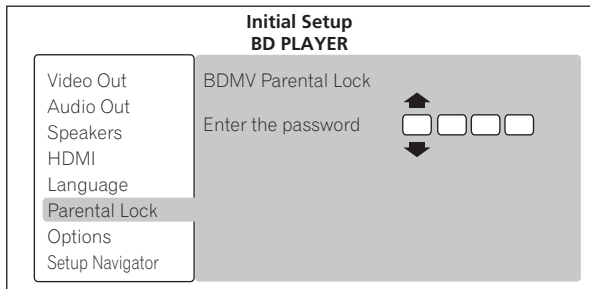
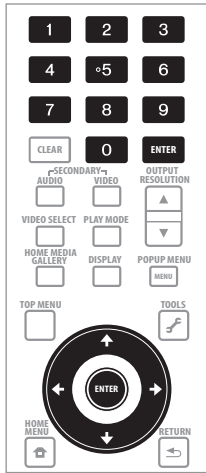

### 4 Change the age.

Use the number buttons (0 to 9) or **↑/↓** to input the number, then press **ENTER** to set.

Use **←/→** to move the cursor.

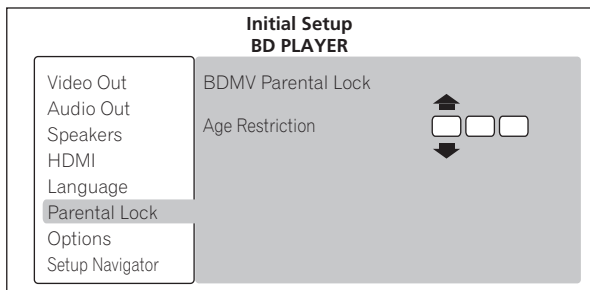

#### Note

- When **Age Restriction** is set to **255**, watching is not restricted.

## Changing the Parental Lock level for watching DVDs

Some DVD-Video discs containing scenes of violence, for example, have Parental Lock levels (check the indications on the disc's jacket or elsewhere). To restrict watching these discs, set the player's level to the level lower than the disc's.



### 1 Select and set Parental Lock.

Use **↑/↓** to select, then press **ENTER**.

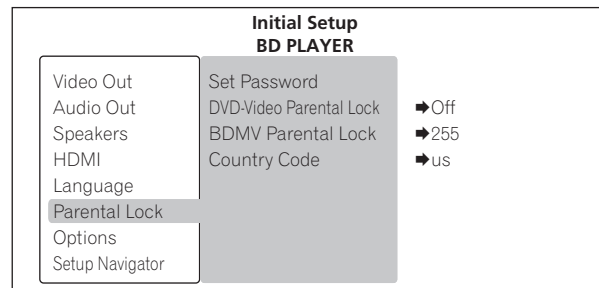
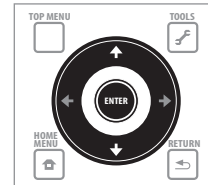

### 2 Select and set DVD-Video Parental Lock → Next Screen.

Use **↑/↓** to select, then press **ENTER**.

### 3 Input the password.

Use the number buttons (0 to 9) or **↑/↓** to input the number, then press **ENTER** to set.

Use **←/→** to move the cursor.

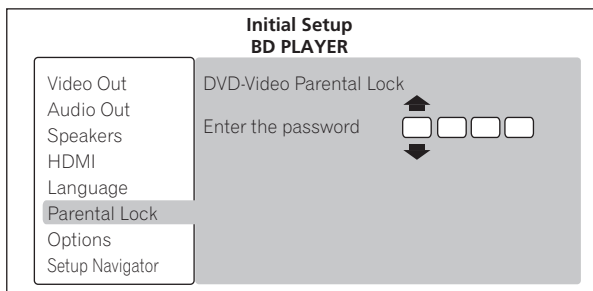
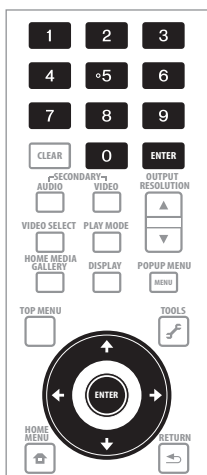

### 4 Change the level.

Use **←/→** to change, then press **ENTER** to set.

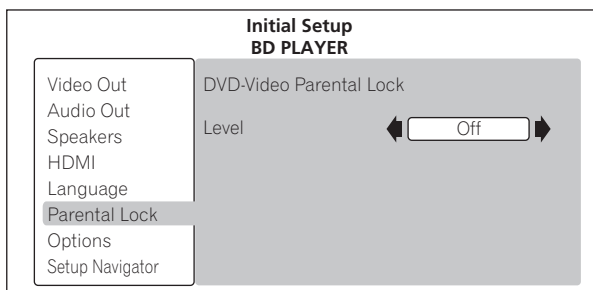

#### Note

- The level can be set to **Off** or between **Level1** and **Level8**. When set to **Off**, watching is not restricted.

## Changing the Country/Area code



#### Note

- Refer to *Country/Area Code Table* on page 56.

### 1 Select and set Parental Lock.

Use **↑/↓** to select, then press **ENTER**.

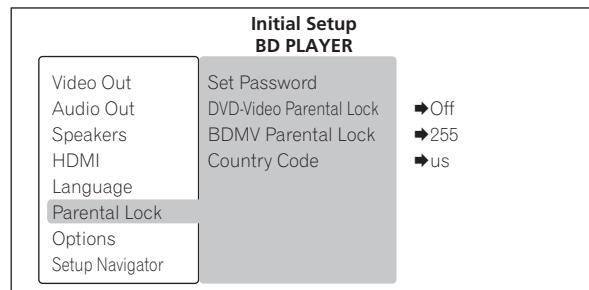
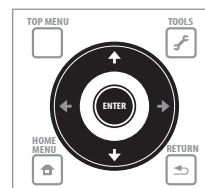

### 2 Select and set Country/Area Code.

Use **↑/↓** to select, then press **ENTER**.

### 3 Input the password.

Use the number buttons (0 to 9) or  $\uparrow/\downarrow$  to input the number, then press **ENTER** to set.

Use  $\leftarrow/\rightarrow$  to move the cursor.

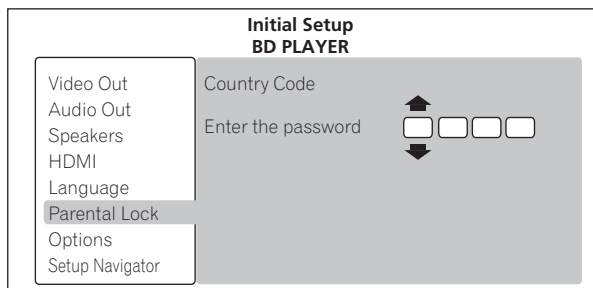
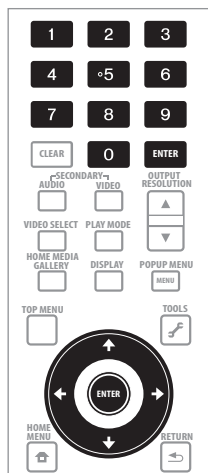

### 4 Change the country/area code.

Use  $\leftarrow/\rightarrow$  to change, then press **ENTER** to set.

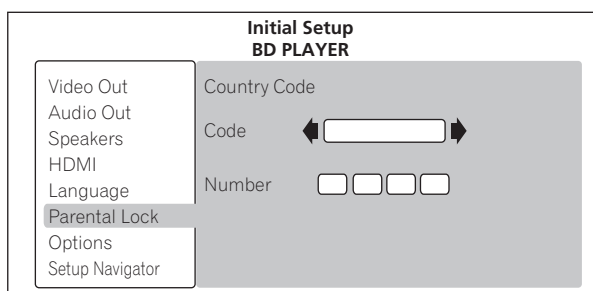

## ❖ To change the country/area code using numbers

1 Use  $\uparrow/\downarrow$  to select Number.

2 Use the number buttons (0 to 9) to input the number, then press **ENTER**.

## Changing the terminals for outputting video and audio signals (Output Terminal Priority)

Set the video and audio terminals to be used.

### Note

- 2-channel linear PCM audio signals are output from the audio output terminals other than the set terminal, regardless of the audio format and setting.

### 1 Select and set Options.

Use  $\uparrow/\downarrow$  to select, then press **ENTER**.

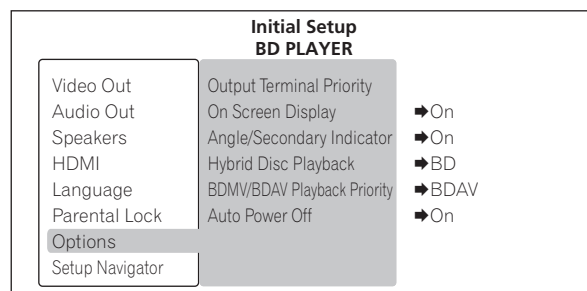
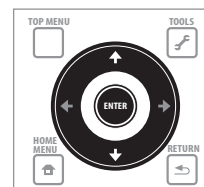

### 2 Select and set Output Terminal Priority → Next Screen.

Use  $\uparrow/\downarrow$  to select, then press **ENTER**.

### 3 Select the terminal for outputting video signals.

Use **←/→** to select, then press **↓**.

When a digital output is selected for the video output terminal, **Video** is fixed at **HDMI** and cannot be changed.

When an analog output is selected for the video output terminal, **Component Video** or **S-Video/Video** can be selected for **Video**.

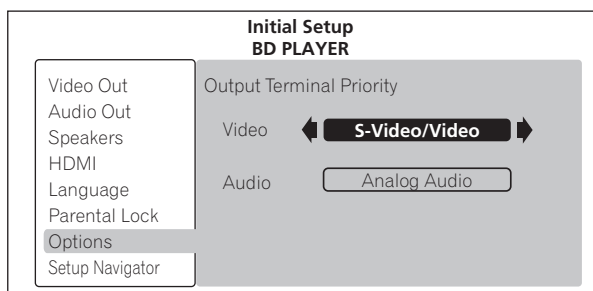
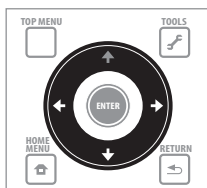

- **HDMI** – **HDMI OUT** terminal
- **Component Video** – **COMPONENT VIDEO** output terminals
- **S-Video/Video** – **S-VIDEO** output terminal or **VIDEO** output terminal

The video and audio signals output from the set output terminals are output synchronously (lip synchronization).

### 4 Select the terminal for outputting audio signals.

Use **←/→** to select, then press **ENTER**.

- **HDMI** – **HDMI OUT** terminal
- **Digital Audio** – **DIGITAL OUT** terminal (**COAXIAL/OPTICAL**)
- **Analog Audio** – **AUDIO OUT (2 ch)** terminals or **AUDIO OUT (7.1 ch)** terminals

The optimum audio signals for the audio format and the player's settings are output from the output terminal(s) set here.

#### **Caution**

- If the output terminal you want to select at **Video** is not displayed, use the **VIDEO SELECT** button to switch between digital and analog output (page 24).
- When **S-Video/Video** or **Component Video** is selected at **Video**, no sound will be output if **HDMI** is selected at **Audio** (the warning message shown below is displayed). When listening to the audio by the HDMI-compatible device, connect to the TV with the HDMI cable to watch the video (pages 14 and 17).

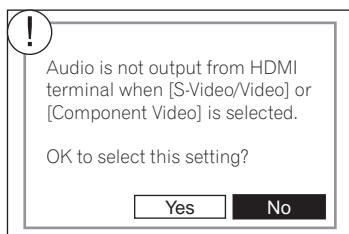

- Linear PCM (2-channel) audio signals are output from the audio terminals other than the one set at **Audio**, regardless of the audio format and the player's settings.

## Restoring all the settings to the factory default settings

- 1 Check that the player's power is turned on.
- 2 When a disc is playing, press **■** to stop playback. Eject the disc from the player.
- 3 While pressing **■**, press **⏻** **STANDBY/ON**. Operate using the buttons on the player's front panel.

#### **Note**

- After restoring all the settings to the factory default settings, use Setup Navigator to reset the player (page 20).

## 06 About the audio output settings

The audio signals that are output differ according to the audio format recorded on the disc and the player's settings. Check on the table below.

Audio format	AUDIO OUT terminal		DIGITAL OUT terminal		HDMI OUT terminal <sup>1</sup>	
	2ch <sup>2</sup>	Multi-channel <sup>2</sup>	Converted to linear PCM audio <sup>3</sup>	Not converted to linear PCM audio <sup>4,5</sup>	PCM <sup>6</sup>	Auto <sup>6,7,8</sup>
BD-ROM	Dolby Digital	5.1-channel audio			5.1-channel audio	Dolby Digital
	Dolby Digital Plus			Dolby Digital	7.1-channel audio <sup>9,10</sup>	Dolby Digital Plus
	Dolby TrueHD	7.1-channel audio <sup>9</sup>				Dolby TrueHD <sup>11</sup>
	DTS Digital Surround	5.1-channel audio			5.1-channel audio	DTS Digital Surround
	DTS-HD High Resolution Audio	Converted to 2-channel audio	Converted to 2-channel audio	DTS Digital Surround		DTS-HD High Resolution Audio
	DTS-HD Master Audio	5.1-channel audio <sup>12</sup>			5.1-channel audio <sup>12</sup>	DTS-HD Master Audio <sup>13</sup>
	Linear PCM	7.1-channel audio <sup>9</sup>		Converted to 2-channel audio	7.1-channel audio <sup>9,10</sup>	7.1-channel audio
BD-R/RE	Dolby Digital	Converted to 2-channel audio	5.1-channel audio	Converted to 2-channel audio	Dolby Digital	Dolby Digital
	MPEG-2 AAC			MPEG-2 AAC	5.1-channel audio	MPEG-2 AAC
	MPEG					
	Linear PCM			2-channel audio		
DVD-Video	Dolby Digital	Converted to 2-channel audio	5.1-channel audio	Converted to 2-channel audio	Dolby Digital	Dolby Digital
	DTS Digital Surround			DTS Digital Surround	5.1-channel audio	DTS Digital Surround
	MPEG					
	Linear PCM			2-channel audio		
DVD (VR format)	Dolby Digital	Converted to 2-channel audio	5.1-channel audio	Converted to 2-channel audio	Dolby Digital	Dolby Digital
	MPEG				5.1-channel audio	
	Linear PCM			2-channel audio		

- When outputting linear PCM audio signals, if the number of compatible channels of the connected HDMI device is lower, the signals are output with the number of channels for which the device is compatible.
- When **Audio Output Mode** is set to **2 Channel** or **Multi-channel** (page 40).
- When **Dolby Digital Out** is set to **Dolby Digital** → **PCM**, **DTS Out** is set to **DTS** → **PCM**, or **AAC Out** is set to **AAC** → **PCM** (page 40).
- When **Dolby Digital Out** is set to **Dolby Digital 1/Dolby Digital 2**, **DTS Out** is set to **DTS 1/DTS 2** or **AAC Out** is set to **AAC** (page 40).
- The secondary audio and interactive audio are not output when **Dolby Digital Out** is set to **Dolby Digital 2**, **DTS Out** is set to **DTS 2** and you are outputting Dolby Digital or DTS Digital Surround bitstream signals.
- When **HDMI Audio Out** is set to **PCM** or **Auto** (page 41).
- When Dolby TrueHD, Dolby Digital Plus, Dolby Digital, DTS-HD Master Audio, DTS-HD High Resolution Audio or DTS Digital Surround signals are being output in bitstream, the secondary audio and interactive audio signals are not mixed.
- If the connected HDMI device is not compatible with Dolby TrueHD or Dolby Digital Plus bitstream, the signals are output in Dolby Digital bitstream. If the connected HDMI device is not compatible with DTS-HD Master Audio or DTS-HD High Resolution Audio, the signals are output in DTS Digital Surround bitstream. If the connected HDMI device is not compatible with Dolby Digital or DTS Digital Surround bitstream, the signals are output in linear PCM.
- Only compatible with 7.1-channel surround back. 6.1-channel surround back output in 7.1 channels. In other cases, output as audio signals of 5.1-channels or less.
- When the output video resolution is set to 480i or 480p, the signals may be output in 2 channel, depending on **HDMI High-Speed Transmission** setting and/or the connected HDMI device (page 15).
- When the output video resolution is set to 480i or 480p, the signals may be output in Dolby Digital bitstream, depending on **HDMI High-Speed Transmission** setting and/or the connected HDMI device (page 15).
- DTS Digital Surround signals converted to linear PCM audio signals are output.
- When the output video resolution is set to 480i or 480p, the signals may be output in DTS Digital Surround bitstream, depending on **HDMI High-Speed Transmission** setting and/or the connected HDMI device (page 15).

### Caution

- Linear PCM audio signals (2 channels) are output from all terminals other than the ones selected at **Audio** under **Output Terminal Priority**, regardless of the audio format or the player's settings (pages 20 and 48).
- The audio signals output from the **DIGITAL OUT** terminals have a sampling frequency of 48 kHz (44.1 kHz for CDs).
- MPEG audio is output in linear PCM.

## Troubleshooting

Incorrect operation is often mistaken for trouble or malfunction. If you think that there is something wrong with this component, check the points below. Sometimes the trouble may lie in another component. Inspect the other components and electrical appliances being used. If the trouble cannot be rectified after checking the items below, please contact customer services. In the US, call Toll Free (800) 421-1404. (Telephone lines are open Monday through Friday 6:00 AM to 4:30 PM (Pacific Time).) In Canada, call Local (905) 479-4411, or Long distance +1(877) 283-5901. (Telephone lines are open Monday through Friday 9:00 AM to 5:30 PM (EST).)

## Playback

Problem	Check	Remedy
Disc does not play. Disc tray opens automatically.	Is the disc scratched?	It may not be possible to play scratched discs.
	Is the disc dirty?	Clean the disc (page 59).
	Is the disc properly set in the disc tray?	<ul style="list-style-type: none"> <li>Set the disc with the printed side facing up.</li> <li>Set the disc properly in the depression in the disc tray.</li> </ul>
	Is the region number correct?	<p>The region numbers of discs that can be played on this set are as shown below (page 10).</p> <ul style="list-style-type: none"> <li>BDs: "A" (or including "A") and "ALL"</li> <li>DVDs: "1" (or including "1") and "ALL"</li> </ul>
Picture freezes and the front panel and remote control buttons stop working.	Is the player set in a humid place?	There could be condensation inside. Wait for the condensation to dissipate. Do not set the player near an air-conditioner, etc. (page 58).
		<ul style="list-style-type: none"> <li>Press <b>■ STOP</b> to stop playback, then restart playback.</li> <li>If the playback cannot be stopped, press <b>⏻ STANDBY/ON</b> on the player's front panel to turn off the power, then turn the power back on.</li> <li>If the power cannot be turned off, press and hold <b>⏻ STANDBY/ON</b> on the player's front panel for over 5 seconds. The power will turn off.</li> </ul>
No picture is displayed or the picture is not displayed properly.	Is the video cable properly connected?	Insert the cable firmly and all the way in.
	Is the video cable damaged?	If the cable is damaged, replace it with a new one.
	Is the input setting on the connected TV or AV receiver or amplifier right?	Read the operating instructions of the connected components and switch to the proper input.
	Are the terminals for outputting video signals properly set?	Press <b>VIDEO SELECT</b> to switch the terminal from which the video signals are output.
	Is the output video resolution properly set?	Depending on the player's output video resolution, the picture may not be displayed at all or displayed properly. Use <b>OUTPUT RESOLUTION</b> to switch to a resolution at which the picture is displayed properly (page 25).
Picture is stretched. Aspect ratio cannot be switched.	Is the player connected with an HDMI cable other than a High Speed HDMI™ cable (with a Standard HDMI™ cable)?	Press <b>■</b> while pressing <b>▶</b> on the player's front panel to restore the video outputs to the factory default settings. After use Setup Navigator to reset the player.
	Is the TV's aspect ratio properly set?	Read the TV's operating instructions and set the TV's aspect ratio properly.
Sound and picture are not synchronized.	Is <b>4:3 Video Out</b> properly set?	<ul style="list-style-type: none"> <li>Set <b>4:3 Video Out</b> properly (page 40).</li> <li>When video signals with a resolution of 1080/60i, 1080/60p, 1080/24p or 720/60p are being output from the <b>HDMI OUT</b> terminal or the <b>COMPONENT VIDEO</b> output terminals, they may be output in the <b>16:9 (Widescreen)</b> mode even if <b>TV Aspect Ratio</b> is set to <b>4:3 (Standard)</b> (page 25).</li> </ul>
	Is <b>Output Terminal Priority</b> properly set?	Set <b>Output Terminal Priority</b> properly (pages 20 and 48).

Problem	Check	Remedy
Picture is disturbed during playback. Picture is dark.		<ul style="list-style-type: none"> <li>This player supports Macrovision analog copy protection technology. With some TVs (such as with built-in video deck), the picture will not be displayed properly when the copy protected DVD title is played. This is not a malfunction.</li> <li>If the player and TV are connected via a DVD recorder/video deck, etc., the picture will not be displayed properly due to analog copy protection. Connect the player and TV directly.</li> </ul>
No picture is displayed or picture is not output in high definition when playing BDs.		With some content protected discs, it may not be possible to output the video signals from the <b>VIDEO</b> output terminals, the <b>S-VIDEO</b> output terminal or the <b>COMPONENT VIDEO</b> output terminals. In this case, connect using an HDMI cable (page 14).
No sound is output. Sound is disturbed.	<p>Is the disc played back in slow motion?</p> <p>Is the disc played back in fast forward or fast reverse?</p> <p>Is the disc scratched?</p> <p>Is the disc dirty?</p> <p>Is the player properly connected to the other components (AV receiver or amplifier, etc.)?</p> <p>Are the connected components (AV receiver or amplifier, etc.) properly set?</p> <p>Are the audio cables properly connected?</p> <p>Is the audio cable damaged?</p> <p>Is the player connected to the TV using an HDMI cable to watch the picture?</p> <p>Is <b>Audio Output Mode</b> properly set?</p> <p>Are the speakers properly set?</p>	<p>No sound is output during slow motion play and forward and reverse scanning.</p> <p>The sound may not be output if the disc is scratched.</p> <p>Clean the disc (page 59).</p> <ul style="list-style-type: none"> <li>Check that you connect the player to the audio output terminals of a different component, etc.</li> <li>Check that you connect the player to the PHONO input terminals of the AV receiver or amplifier, etc.</li> </ul> <p>Read the operating instructions of the connected components and check the volume, input, speaker settings, etc.</p> <p>Insert the cables firmly and all the way in.</p> <p>If the cable is damaged, replace it with a new one.</p> <p>When connecting using component video cables, an S-Video cable or a video cable to watch the picture, it is not possible to listen to the sound of devices connected with HDMI cables. Take one of the measures below (pages 14 and 17).</p> <ul style="list-style-type: none"> <li>To watch the picture on a device that is not HDMI compatible, connect using either an optical digital audio cable, coaxial digital audio cable or analog audio cables (7.1 or 2 channels) to listen to the sound.</li> <li>To listen to the sound on an HDMI-compatible device, connect to the TV using an HDMI cable to watch the picture.</li> </ul> <p>After one of the above measures, use Setup Navigator to reset the player (page 20).</p> <p>If <b>Audio Output Mode</b> is set to <b>Multi-channel</b>, the audio signals may not be output properly from the <b>AUDIO OUT (2 ch)</b> terminals (page 40). Set <b>Audio Output Mode</b> to <b>2 Channel</b>.</p> <p>Set <b>Speaker Setup</b> properly (page 40).</p> <p>For some BDs, audio signals are only output from the optical digital audio output terminal, the coaxial digital audio output terminal or the HDMI output terminal.</p> <p>Read the operating instructions of the connected AV receiver or amplifier and check the audio output settings of AV receiver or amplifier.</p> <p>Linear PCM (2-channel) audio signals are output from output terminals other than the one set at <b>Audio</b> under <b>Output Terminal Priority</b>. Set <b>Output Terminal Priority</b> properly (page 48).</p> <p>Read the operating instructions of the connected AV receiver or amplifier and check the audio output settings of AV receiver or amplifier.</p>
Multi-channel sound is not output.	<p>Is the AV receiver or amplifier, etc. connected to the <b>HDMI OUT</b> terminal, the <b>AUDIO OUT (7.1 ch)</b> terminals or <b>DIGITAL OUT (COAXIAL/OPTICAL)</b> terminal?</p> <p>Is <b>Output Terminal Priority</b> properly set?</p> <p>Is the audio output of the connected AV receiver or amplifier, etc., properly set?</p>	<p>Read the operating instructions of the connected AV receiver or amplifier and check the audio output settings of AV receiver or amplifier.</p> <p>Linear PCM (2-channel) audio signals are output from output terminals other than the one set at <b>Audio</b> under <b>Output Terminal Priority</b>. Set <b>Output Terminal Priority</b> properly (page 48).</p> <p>Read the operating instructions of the connected AV receiver or amplifier and check the audio output settings of AV receiver or amplifier.</p>



Problem	Check	Remedy
Multi-channel sound is not output (continuous).	Is multi-channel sound selected?	Use the menu screen or <b>AUDIO</b> to switch the disc's sound to multi-channel.
	Is <b>Audio Out</b> set to audio formats supported by the connected AV receiver or amplifier?	<ul style="list-style-type: none"> <li>• Read the operating instructions of the connected AV receiver or amplifier and check the supported audio formats.</li> <li>• Set <b>Audio Out</b> properly (page 40).</li> </ul>
	Are <b>Audio Output Mode</b> and <b>Speaker Setup</b> properly set?	<ul style="list-style-type: none"> <li>• When the AV receiver or amplifier, etc., is connected to the <b>AUDIO OUT (7.1 ch)</b> terminals, set <b>Audio Output Mode</b> to <b>Multi-channel</b> (page 40).</li> <li>• Set <b>Speaker Setup</b> properly (page 40).</li> </ul>
Digital audio signals are not output from the <b>DIGITAL OUT</b> output ( <b>COAXIAL/DIGITAL</b> ) terminals (analog audio signals are output).	Is <b>Audio Out</b> set to audio formats supported by the connected AV receiver or amplifier?	<ul style="list-style-type: none"> <li>• Read the operating instructions of the connected AV receiver or amplifier and check the supported audio formats.</li> <li>• Set <b>Audio Out</b> properly (page 40).</li> </ul>
Noise can be heard when outputting DTS Digital Surround signals.	Is the connected AV receiver or amplifier compatible with DTS Digital Surround?	If an AV receiver or amplifier that is not compatible with DTS Digital Surround is connected to the <b>DIGITAL OUT</b> terminal, set <b>DTS Out</b> to <b>DTS → PCM</b> . Noise will be heard if <b>DTS Out</b> is set to <b>DTS</b> (page 40).
192 kHz or 96 kHz digital audio signals cannot be output from the <b>DIGITAL OUT (COAXIAL/OPTICAL)</b> terminals.		It is not possible to output 192 kHz or 96 kHz digital audio signals from this player's <b>DIGITAL OUT (COAXIAL/OPTICAL)</b> terminals. The signals are automatically converted to under 96 kHz for output.
Secondary audio or interactive audio is not output.	Is <b>HDMI Audio Out</b> properly set?	Set <b>HDMI Audio Out</b> to <b>PCM</b> (page 41).
	Are <b>Dolby Digital Out</b> and <b>DTS Out</b> properly set?	Set <b>Dolby Digital Out</b> to <b>Dolby Digital 1</b> , <b>DTS Out</b> to <b>DTS 1</b> (page 40).
Sound is fast or slow.	When an HDMI cable is connected, are audio signals being output from devices connected with cables other than HDMI cables?	When this player is connected by HDMI cable to a Pioneer AV receiver or amplifier compatible with the PQLS function via HDMI connection, the PQLS function is activated when playing CDs. Because of this, the sound output from components other than the ones connected by HDMI cable may be fast or slow. If this happens, set <b>PQLS</b> to <b>Off</b> (page 41).
Files recorded on discs cannot be played.	Is the disc one that is playable on this player?	Check whether the disc is one that can be played on this player (page 8).
	Is the file one that is playable on this player?	<ul style="list-style-type: none"> <li>• Check whether the file is one that can be played on this player (page 10).</li> <li>• Check whether or not the file is damaged</li> </ul>
	Is the file protected by DRM?	Files protected by DRM cannot be played.
A message indicating low memory (local storage) appears while playing a BD-ROM disc.		Erase the BDMV data (page 24).

## When connected using an HDMI cable

Problem	Check	Remedy
HDMI indicator does not light.	Is the video output terminal other than the HDMI OUT terminal selected?	The HDMI indicator lights when video signals are being output from the <b>HDMI OUT</b> terminal. Press <b>VIDEO SELECT</b> to switch to the <b>HDMI OUT</b> terminal (page 24).
	Is the input of the connected HDMI device properly set?	Read the HDMI device's operating instructions and set the input properly.
	Is a DVI device connected?	Read the DVI device's operating instructions and check whether it is compatible with HDCP.

Problem	Check	Remedy
No picture is displayed.	Is the HDMI indicator lit?	<ul style="list-style-type: none"> <li>If the HDMI indicator is not lit, read the HDMI device's operating instructions and switch to the proper input.</li> <li>If the HDMI indicator is lit, use <b>OUTPUT RESOLUTION</b> to switch the output video resolution (page 25).</li> </ul>
	Are the terminals for outputting video signals properly set?	Press <b>VIDEO SELECT</b> to switch the <b>HDMI OUT</b> terminal.
	Is the resolution properly set?	Depending on the output video resolution setting, the picture may not be output. Use <b>OUTPUT RESOLUTION</b> to switch the output video resolution (page 25).
	Is the HDMI cable properly connected?	<ul style="list-style-type: none"> <li>Insert the cable firmly and all the way in.</li> <li>With some cables, 1080p video signals cannot be properly output.</li> </ul>
	Is a DVI device connected?	The picture may not be displayed properly if a DVI device is connected.
	Is the HDMI cable damaged?	If the cable is damaged, replace it with a new one.
Pictures do not display properly on the TV.		Change the <b>HDMI Color Space</b> setting (page 41).
No sound is produced.	Are you watching the picture with the TV connected via an HDMI cable?	If video signals are being output from a terminal other than the HDMI terminal, no audio signals are output from the HDMI terminal. Connect to the TV using an HDMI cable and press <b>VIDEO SELECT</b> to switch to the HDMI output terminal (pages 14, 17 and 24).
	Is a DVI device connected?	The sound will not be output from the <b>HDMI OUT</b> terminal if a DVI device is connected. Connect the device to a <b>DIGITAL OUT (OPTICAL/COAXIAL)</b> terminal or the <b>AUDIO OUT (2 ch)</b> terminals.
HDMI Control function does not work.	Is the HDMI cable properly connected?	Connect the HDMI cable properly.
	Is the HDMI cable you are using a High Speed HDMI™ cable?	Use a High Speed HDMI™ cable. The HDMI Control function may not work properly if HDMI cable other than a High Speed HDMI™ cable is used.
	Are you connected to the TV using an HDMI cable to watch the picture?	If video signals are being output from a terminal other than the HDMI terminal, HDMI Control function does not work. Connect to the TV using an HDMI cable and press <b>VIDEO SELECT</b> to switch to the HDMI output terminal (pages 14, 17 and 24).
	Is <b>HDMI Control</b> set to <b>On</b> on the player?	Set <b>HDMI Control</b> to <b>On</b> on the player (page 41).
	Does the connected device support the HDMI Control function?	<ul style="list-style-type: none"> <li>The HDMI Control function will not work with devices manufactured by companies other than Pioneer, even when connected using an HDMI cable.</li> <li>The HDMI Control function will not work if devices that do not support the HDMI Control function or devices manufactured by companies other than Pioneer are connected between the HDMI Control-compatible device and the player.</li> <li>The HDMI Control function may not work with certain Flat Panel TVs.</li> </ul> <p>Also refer to the operating instructions of the connected device.</p>
	Is HDMI Control set to On on the connected device?	<p>Set HDMI Control to On on the connected device. The HDMI Control function works when HDMI Control is set to On for all the devices connected by HDMI cable.</p> <p>Once connections and settings of all the devices are finished, be sure to check that the player's picture is output to the Flat Panel TV. (Also check after changing the connected devices and connecting and/or disconnecting HDMI cables.) If the player's picture is not being output to the Flat Panel TV, the HDMI Control function may not work properly.</p> <p>For details, refer to the operating instructions of the connected device.</p>
Are multiple players connected?	The HDMI Control function may not work if three or more players, including this player, are connected by HDMI cable.	

Problem	Check	Remedy
The power turns off automatically.	Is <b>Auto Power Off</b> set to <b>On</b> ?	If <b>Auto Power Off</b> is set to <b>On</b> , the power turns off automatically if no operation is performed for over 30 minutes (page 42).
	Is <b>HDMI Control</b> set to <b>On</b> ?	The player's power may turn off together with the power of the connected TV. If you do not want the player's power to turn off when the TV's power is turned off, set <b>HDMI Control</b> to <b>Off</b> (page 41).
The power turns on automatically.	Is <b>HDMI Control</b> set to <b>On</b> ?	The player's power may turn on together with the power of the connected TV. If you do not want the player's power to turn on when the TV's power is turned on, set <b>HDMI Control</b> to <b>Off</b> (page 41).
Inputs of connected TV and AV system, switches automatically.	Is <b>HDMI Control</b> set to <b>On</b> ?	The inputs of the connected TV or AV system (AV receiver or amplifier, etc.) may automatically switch to the player when playback starts on the player or the menu screen (Home Media Gallery, etc.) is displayed. If you do not want the inputs of the connected TV and/or AV system (AV receiver or amplifier, etc.) to switch automatically, set <b>HDMI Control</b> to <b>Off</b> (page 41).
Player cannot be operated with remote control.	Is an AV receiver or amplifier connected to the <b>CONTROL IN</b> terminal on the player's rear panel?	Operate with the remote control of the device connected to the <b>CONTROL IN</b> terminal.
	Are you operating the remote control from a point too far away from the player?	Operate from within 23 feet of the remote control sensor.
	Are the batteries dead?	Replace the batteries (page 7).
Settings you have made have been cleared.	<ul style="list-style-type: none"> <li>• Have you disconnected the power cord while the player's power was on?</li> <li>• Has there been a power failure?</li> </ul>	If the power cord is disconnected or there is a power failure while the player's power is on, the settings you have made may be cleared. Always press <b>STANDBY/ON</b> on the player's front panel or <b>STANDBY/ON</b> on the remote control and check that <b>POWER OFF</b> has turned off from the player's front panel display before disconnecting the power cord. Be particularly careful when the power cord is connected to the AC outlet on another device because the player turns off in conjunction with the device. We recommend plugging the power cord into a wall outlet whenever possible.
After a disc is inserted, <b>Loading</b> stays displayed and playback does not start.	Are there too many files recorded on the disc?	When a disc on which files are recorded is inserted, depending on the number of files recorded on the disc, loading may take several dozen minutes.
■ is displayed in file names, etc.		The characters that cannot be displayed on this player are displayed in ■.
The DVD layer of BD and DVD hybrid discs cannot be played.	Is <b>Hybrid Disc Playback</b> properly set?	Set <b>Hybrid Disc Playback</b> to <b>DVD</b> (page 42).
The CD layer of BD and CD hybrid discs cannot be played.	Is <b>Hybrid Disc Playback</b> properly set?	Set <b>Hybrid Disc Playback</b> to <b>CD</b> (page 42).
The <b>Hybrid Disc Playback</b> setting cannot be changed (displayed in gray).	Is a disc set in the disc tray?	The <b>Hybrid Disc Playback</b> setting cannot be changed when a disc is set. Remove the disc, then change the setting.
<b>BDMV/BDAV Playback Priority</b> setting cannot be changed (displayed in gray).	Is a disc set in the disc tray?	The <b>BDMV/BDAV Playback Priority</b> setting cannot be changed when a disc is set. Remove the disc, then change the setting.

# Language Code Table and Country/Area Code Table

## Language Code Table

### Language name (language code), input code

Japanese (ja/jpn), <b>1001</b>	Dzongkha (dz/dzo), <b>0426</b>	Kirghiz (ky/kir), <b>1125</b>	Sinhalese (si/sin), <b>1909</b>
English (en/eng), <b>0514</b>	Esperanto (eo/epo), <b>0515</b>	Latin (la/lat), <b>1201</b>	Slovak (sk/slk), <b>1911</b>
French (fr/fra), <b>0618</b>	Estonian (et/est), <b>0520</b>	Lingala (ln/lin), <b>1214</b>	Slovenian (sl/slv), <b>1912</b>
German (de/deu), <b>0405</b>	Basque (eu/eus), <b>0521</b>	Lao (lo/lao), <b>1215</b>	Samoan (sm/smo), <b>1913</b>
Italian (it/ita), <b>0920</b>	Persian (fa/fas), <b>0601</b>	Lithuanian (lt/lit), <b>1220</b>	Shona (sn/sna), <b>1914</b>
Spanish (es/spa), <b>0519</b>	Finnish (fi/fin), <b>0609</b>	Latvian (lv/lav), <b>1222</b>	Somali (so/som), <b>1915</b>
Chinese (zh/zho), <b>2608</b>	Fijian (fj/fij), <b>0610</b>	Malagasy (mg/mlg), <b>1307</b>	Albanian (sq/sqi), <b>1917</b>
Dutch (nl/nld), <b>1412</b>	Faroese (fo/fao), <b>0615</b>	Maori (mi/mri), <b>1309</b>	Serbian (sr/srp), <b>1918</b>
Portuguese (pt/por), <b>1620</b>	Frisian (fy/fry), <b>0625</b>	Macedonian (mk/mkd), <b>1311</b>	Swati (ss/ssw), <b>1919</b>
Swedish (sv/swe), <b>1922</b>	Irish (ga/gle), <b>0701</b>	Malayalam (ml/mal), <b>1312</b>	Sotho, Southern (st/sot), <b>1920</b>
Russian (ru/rus), <b>1821</b>	Scots-Gaelic (gd/gla), <b>0704</b>	Mongolian (mn/mon), <b>1314</b>	Sundanese (su/sun), <b>1921</b>
Korean (ko/kor), <b>1115</b>	Galician (gl/glg), <b>0712</b>	Moldavian (mo/mol), <b>1315</b>	Swahili (sw/swa), <b>1923</b>
Greek (el/ell), <b>0512</b>	Guarani (gn/grn), <b>0714</b>	Marathi (mr/mar), <b>1318</b>	Tamil (ta/tam), <b>2001</b>
Afar (aa/aar), <b>0101</b>	Gujarati (gu/guj), <b>0721</b>	Malay (ms/msa), <b>1319</b>	Telugu (te/tel), <b>2005</b>
Abkhazian (ab/abk), <b>0102</b>	Hausa (ha/hau), <b>0801</b>	Maltese (mt/mlt), <b>1320</b>	Tajik (tg/tgk), <b>2007</b>
Afrikaans (af/afn), <b>0106</b>	Hindi (hi/hin), <b>0809</b>	Burmese (my/mya), <b>1325</b>	Thai (th/tha), <b>2008</b>
Amharic (am/amh), <b>0113</b>	Croatian (hr/hrv), <b>0818</b>	Nauru (na/nau), <b>1401</b>	Tigrinya (ti/tir), <b>2009</b>
Arabic (ar/ara), <b>0118</b>	Hungarian (hu/hun), <b>0821</b>	Nepali (ne/nep), <b>1405</b>	Turkmen (tk/tuk), <b>2011</b>
Assamese (as/asm), <b>0119</b>	Armenian (hy/hye), <b>0825</b>	Norwegian (no/nor), <b>1415</b>	Tagalog (tl/tgl), <b>2012</b>
Aymara (ay/aym), <b>0125</b>	Interlingua (ia/ina), <b>0901</b>	Occitan (oc/oci), <b>1503</b>	Tswana (tn/tsn), <b>2014</b>
Azerbaijani (az/aze), <b>0126</b>	Interlingue (ie/ile), <b>0905</b>	Oromo (om/orm), <b>1513</b>	Tonga (Tonga Islands) (to/ton), <b>2015</b>
Bashkir (ba/bak), <b>0201</b>	Inupiaq (ik/ipk), <b>0911</b>	Oriya (or/ori), <b>1518</b>	Turkish (tr/tur), <b>2018</b>
Belarusian (be/bel), <b>0205</b>	Indonesian (in/ind), <b>0914</b>	Panjabi (pa/pan), <b>1601</b>	Tsonga (ts/tso), <b>2019</b>
Bulgarian (bg/bul), <b>0207</b>	Icelandic (is/isl), <b>0919</b>	Polish (pl/pol), <b>1612</b>	Tatar (tt/tat), <b>2020</b>
Bihari (bh/bih), <b>0208</b>	Hebrew (iw/heb), <b>0923</b>	Pushto (ps/pus), <b>1619</b>	Twí (tw/twi), <b>2023</b>
Bislama (bi/bis), <b>0209</b>	Yiddish (ji/yid), <b>1009</b>	Quechua (qu/que), <b>1721</b>	Ukrainian (uk/ukr), <b>2111</b>
Bengali (bn/ben), <b>0214</b>	Javanese (jw/jav), <b>1023</b>	Rhaeto-Romance (rm/roh), <b>1813</b>	Urdu (ur/urd), <b>2118</b>
Tibetan (bo/bod), <b>0215</b>	Georgian (ka/kat), <b>1101</b>	Rundi (rn/run), <b>1814</b>	Uzbek (uz/uzb), <b>2126</b>
Breton (br/bre), <b>0218</b>	Kazakh (kk/kaz), <b>1111</b>	Romanian (ro/ron), <b>1815</b>	Vietnamese (vi/vie), <b>2209</b>
Catalan (ca/cat), <b>0301</b>	Kalaallisut (kl/kal), <b>1112</b>	Kinyarwanda (rw/kin), <b>1823</b>	Volapük (vo/vol), <b>2215</b>
Corsican (co/cos), <b>0315</b>	Khmer (km/khm), <b>1113</b>	Sanskrit (sa/san), <b>1901</b>	Wolof (wo/wol), <b>2315</b>
Czech (cs/ces), <b>0319</b>	Kannada (kn/kan), <b>1114</b>	Sindhi (sd/snd), <b>1904</b>	Xhosa (xh/xho), <b>2408</b>
Welsh (cy/cym), <b>0325</b>	Kashmiri (ks/kas), <b>1119</b>	Sango (sg/sag), <b>1907</b>	Yoruba (yo/yor), <b>2515</b>
Danish (da/dan), <b>0401</b>	Kurdish (ku/kur), <b>1121</b>	Serbo-Croatian (sh/scr), <b>1908</b>	Zulu (zu/zul), <b>2621</b>

## Country/Area Code Table

### Country/Area name, input code, Country/Area code

Anguilla, <b>0109, ai</b>	Dominican Republic, <b>0415, do</b>	Liechtenstein, <b>1209, li</b>	San Marino, <b>1913, sm</b>
Antigua and Barbuda, <b>0107, ag</b>	Estonia, <b>0505, ee</b>	Lithuania, <b>1220, lt</b>	Singapore, <b>1907, sg</b>
Argentina, <b>0118, ar</b>	Finland, <b>0609, fi</b>	Luxembourg, <b>1221, lu</b>	Slovakia, <b>1911, sk</b>
Armenia, <b>0113, am</b>	France, <b>0618, fr</b>	Macedonia, the Former Yugoslav Republic of, <b>1311, mk</b>	Slovenia, <b>1909, si</b>
Australia, <b>0121, au</b>	Georgia, <b>0705, ge</b>	Malaysia, <b>1325, my</b>	Spain, <b>0519, es</b>
Austria, <b>0120, at</b>	Germany, <b>0405, de</b>	Malta, <b>1320, mt</b>	Suriname, <b>1918, sr</b>
Azerbaijan, <b>0126, az</b>	Greece, <b>0718, gr</b>	Mexico, <b>1324, mx</b>	Sweden, <b>1905, se</b>
Bahamas, <b>0219, bs</b>	Greenland, <b>0712, gl</b>	Moldova, Republic of, <b>1304, md</b>	Switzerland, <b>0308, ch</b>
Barbados, <b>0202, bb</b>	Grenada, <b>0704, gd</b>	Monaco, <b>1303, mc</b>	Taiwan, Province of China, <b>2023, tw</b>
Belarus, <b>0225, by</b>	Guyana, <b>0725, gy</b>	Montserrat, <b>1319, ms</b>	Tajikistan, <b>2010, tj</b>
Belgium, <b>0205, be</b>	Haiti, <b>0820, ht</b>	Netherlands, <b>1412, nl</b>	Thailand, <b>2008, th</b>
Belize, <b>0226, bz</b>	Hong Kong, <b>0811, hk</b>	New Zealand, <b>1426, nz</b>	Trinidad and Tobago, <b>2020, tt</b>
Bermuda, <b>0213, bm</b>	Hungary, <b>0821, hu</b>	Norway, <b>1415, no</b>	Tunisia, <b>2014, tn</b>
Brazil, <b>0218, br</b>	Iceland, <b>0919, is</b>	Pakistan, <b>1611, pk</b>	Turkey, <b>2018, tr</b>
Bulgaria, <b>0207, bg</b>	India, <b>0914, in</b>	Peru, <b>1605, pe</b>	Turkmenistan, <b>2013, tm</b>
Canada, <b>0301, ca</b>	Indonesia, <b>0904, id</b>	Philippines, <b>1608, ph</b>	Turks and Caicos Islands, <b>2003, tc</b>
Cayman Islands, <b>1125, ky</b>	Ireland, <b>0905, ie</b>	Poland, <b>1612, pl</b>	Ukraine, <b>2101, ua</b>
Chile, <b>0312, cl</b>	Israel, <b>0912, il</b>	Portugal, <b>1620, pt</b>	United Kingdom, <b>0702, gb</b>
China, <b>0314, cn</b>	Italy, <b>0920, it</b>	Puerto Rico, <b>1618, pr</b>	United States, <b>2119, us</b>
Colombia, <b>0315, co</b>	Jamaica, <b>1013, jm</b>	Romania, <b>1815, ro</b>	Uruguay, <b>2125, uy</b>
Croatia, <b>0818, hr</b>	Japan, <b>1016, jp</b>	Russian Federation, <b>1821, ru</b>	Uzbekistan, <b>2126, uz</b>
Cyprus, <b>0325, cy</b>	Kazakhstan, <b>1126, kz</b>	Saint Kitts and Nevis, <b>1114, kn</b>	Venezuela, <b>2205, ve</b>
Czech Republic, <b>0326, cz</b>	Korea, Republic of, <b>1118, kr</b>	Saint Lucia, <b>1203, lc</b>	Virgin Islands, British, <b>2207, vg</b>
Denmark, <b>0411, dk</b>	Kyrgyzstan, <b>1107, kg</b>	Saint Vincent and the Grenadines, <b>2203, vc</b>	
Dominica, <b>0413, dm</b>	Latvia, <b>1222, lv</b>		

# Specifications

<b>Model</b>		BDP-51FD
<b>Type</b>		Blu-ray Disc PLAYER
<b>Rated voltage</b>		AC 120 V
<b>Rated frequency</b>		60 Hz
<b>Power consumption</b>		34 W
<b>Power consumption (standby)</b>		0.5 W
<b>Weight</b>		5.6 kg (12 lb 6 oz)
<b>External dimensions (including projecting parts)</b>		420 mm (W) x 124 mm (H) x 361 mm (D) (16 <sup>9</sup> / <sub>16</sub> in. (W) x 4 <sup>15</sup> / <sub>16</sub> in. (H) x 14 <sup>1</sup> / <sub>4</sub> in. (D))
<b>Tolerable operating temperature</b>		+5 °C to +35 °C (+41 °F to +95 °F)
<b>Tolerable operating humidity</b>		5 % to 85 % (no condensation)
<b>Output terminals</b>	<b>Video outputs</b>	<b>Video</b> 1 set, RCA jack (1.0 Vp-p (75 Ω))
		<b>S-Video</b> 1 set, S-Video jack: Y (luminance): 1.0 Vp-p (75 Ω) C (color): 0.286 Vp-p (75 Ω)
		<b>Component video</b> 1 set, pin-plug jacks: Y: 1.0 Vp-p (75 Ω) Pb, PR: 0.7 Vp-p (75 Ω)
		<b>HDMI</b> 1 set, 19-pin (5V, 150 mA)
	<b>Audio outputs</b>	<b>2-channel (stereo)</b> Number of channels: 2, RCA jacks
	<b>7.1-channel (multi-channel: front left/right, surround left/right, center, surround back left/right, subwoofer)</b> Number of channels: 8, RCA jacks	
	<b>Audio output level</b>	200 mVrms (1 kHz, -20 dB)
	<b>Frequency response</b>	4 Hz to 88 kHz (192 kHz sampling)
	<b>S/N ratio</b>	115 dB
	<b>Dynamic range</b>	103 dB
	<b>Total harmonic distortion</b>	0.0015 %
	<b>Wow &amp; flutter</b>	Below measurable limits (±0.001 % W. PEAK)
<b>Digital audio outputs</b>	<b>Optical</b>	1 set, Optical digital jack
	<b>Coaxial</b>	1 set, RCA jack
<b>Control</b>	<b>Input</b>	1 set, Minijack (3.5 ø)



**Note**

- The specifications and design of this product are subject to change without notice.
- This product includes FontAvenue® fonts licensed by NEC Corporation. FontAvenue is a registered trademark of NEC Corporation.

## Cautions on use

### ❖ Moving the player

If you need to move this unit, first remove the disc, if there's one loaded, and close the disc tray. Next, press **⏻ STANDBY/ON** to switch the power to standby, checking that the **POWER OFF** indication on the front panel display goes off. Wait at least 10 seconds. Lastly, disconnect the power cord.

Never lift or move the unit during playback — discs rotate at a high speed and may be damaged.

### Place of installation

Select a stable place near the TV and AV system to which the unit is connected.

Do not place the player on top of a TV or color monitor. Keep it away from cassette decks or other components easily affected by magnetism.

Avoid the following types of places:

- Places exposed to direct sunlight
- Humid or poorly ventilated places
- Extremely hot or cold places
- Places subject to vibration
- Dusty places
- Places exposed to soot, steam or heat (in kitchens, etc.)

### ❖ Do not place objects on top

Do not place objects on top of the player.

### ❖ Do not obstruct the ventilation holes

Do not use the player on a shaggy rug, bed, or sofa, and do not cover the player with a cloth, etc. Doing so will prevent heat dissipation and could lead to damage.

### ❖ Keep away from heat

Do not place the player on top of an amplifier or other device generating heat. When installing in a rack, to avoid the heat generated by the amplifier and other devices, place it on a shelf below the amplifier whenever possible.

## Turn the power off when not using the player

Depending on the conditions of the TV broadcast signals, striped patterns may appear on the screen when the TV is turned on while the player's power is turned on. This is not a malfunction with the player or TV. If this happens, turn the player's power off. In the same way, noise may be heard in the sound of a radio.

## Condensation

If the player is moved suddenly from a cold place into a warm room (in winter, for example) or if the temperature in the room in which the player is installed rises suddenly due to a heater, etc., water droplets (condensation) may form inside (on operating parts and the lens). When condensation is present, the player will not operate properly and playback is not possible. Let the player stand at room temperature for 1 or 2 hours with the power turned on (the time depends on the extent of condensation). The water droplets will dissipate and playback will become possible.

Condensation can also occur in the summer if the player is exposed to the direct wind from an air-conditioner. If this happens, move the player to a different place.

## Cleaning the player

Normally, wipe the player with a soft cloth. For tough dirt, apply some neutral detergent diluted in 5 to 6 parts water to a soft cloth, wring out thoroughly, wipe off the dirt, then wipe again with a dry cloth.

Note that getting alcohol, thinner, benzene or insecticide on the player could cause the print and coating to peel off. Also, avoid leaving rubber or vinyl products in contact with the player for long periods of time, as this could damage the cabinet.

When using chemical-impregnated wipes, etc., read the wipe's cautions carefully.

Unplug the power cord from the power outlet when cleaning the player.

### ❖ Caution for when the unit is installed in a rack with a glass door

Do not press the **▲ OPEN/CLOSE** on the remote control to open the disc tray while the glass door is closed. The door will hamper the movement of the disc tray, and the unit could be damaged.

## Cleaning the pickup lens

The player's lens should not become dirty in normal use, but if for some reason it should malfunction due to dust or dirt, consult your nearest Pioneer-authorized service center. Although lens cleaners for players are commercially available, we advise against using them since some may damage the lens.

## Handling discs

Do not use damaged (cracked or warped) discs.

Do not scratch the disc's signal surface or let it get dirty.

Do not load more than one disc into the player at a time.

Do not glue paper or put stickers onto the disc, or use a pencil, ball-point pen or other sharp-tipped writing instrument. These could all damage the disc.



### ❖ Storing

Always store discs in their cases, and place the cases vertically, avoiding places exposed to high temperature or humidity, direct sunlight or extremely low temperatures.

Be sure to read the cautions included with the disc.

### ❖ Cleaning discs

It may not be possible to play the disc if there are fingerprints or dust on it. In this case, using a cleaning cloth, etc., to wipe the disc gently from the center towards the outer edge. Do not use a dirty cleaning cloth.

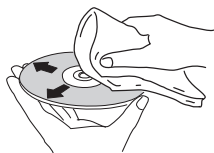

Do not use benzene, thinner or other volatile chemicals. Also do not use record spray or antistatic agents.

For tough dirt, apply some water to a soft cloth, wring out thoroughly, wipe off the dirt, then wipe off the moisture with a dry cloth.

### ❖ Specially shaped discs

Specially shaped discs (heart-shaped, hexagonal, etc.) cannot be used on this player. Never use such discs, as they will damage the player.



### ❖ Condensation on discs

If the disc is moved suddenly from a cold place into a warm room (in winter, for example), water droplets (condensation) may form on the disc surface. Discs will not play properly if there is condensation on them. Carefully wipe off the water droplets from the disc surface before using the disc.

## Glossary

### ❖ Aspect ratio

The ratio of a TV screen's width to its height. Conventional TVs have an aspect ratio of 4:3, while high definition (HD) and widescreen TVs have an aspect ratio of 16:9.

### ❖ Audio language

Multiple audio tracks, for example the original sound and the dubbed sound, can be recorded on BD-ROM or DVD-Video discs. Up to 32 languages (32 audio tracks) can be recorded on BD-ROM discs, up to 8 languages (8 audio tracks) on DVD-Video discs, so you can select the desired language when watching the disc.

### ❖ AVCHD (Advanced Video Codec High Definition)

The AVCHD is a high definition (HD) digital video camera recorder format recording high-definition onto certain media by using highly efficient codec technologies.

### ❖ BD-J

With BD-ROMs, it is possible to use Java applications to create highly interactive titles, for example including games.



Java and all Java-related trademarks and logos are trademarks or registered trademarks of Sun Microsystems, Inc., in the United States and other countries.

### ❖ BDAV

Of the BD format, the Audio Visual Format Specifications for HD digital broadcast recording is referred to as BDAV on this player and in this operating instructions.

### ❖ BDMV

Of the BD format, the Audio Visual Format Specifications designed for pre-packaged high definition (HD) movie contents is referred to as BDMV on this player and in this operating instructions.

### ❖ Component video output

This video output terminal provides clearer pictures when connected to a TV equipped with component inputs. Component video signals consist of three signals, Y, PB and PR.

### ❖ Composite video output

Signals mixing the luminance signal (Y) and the color signal (C) so they can be transferred on a single cord are output from this terminal.

### ❖ **Deep Color**

This is one of the capabilities of HDMI™. The players supporting Deep Color can transmit a video signal with a color bit depth of greater than 8 bits per color component. Subtle color gradations can be reproduced when connected to a TV that supports Deep Color.

### ❖ **Dolby Digital**

Dolby Digital is an audio format to record the sound in up to 5.1 channels with a fraction of the amount of data as compared to linear PCM audio signals.

### ❖ **Dolby Digital Plus**

Dolby Digital Plus is an audio format for high-definition media. Built on Dolby Digital, it combines the efficiency and flexibility to provide high quality multi-channel audio. With BD-ROMs, up to 7.1 channels of digital sound can be recorded.

### ❖ **Dolby TrueHD**

Dolby TrueHD is an audio format using lossless coding. With BD-ROMs, up to 8 channels can be recorded at 96 kHz/24 bits, or up to 6 channels at 192 kHz/24 bits.

### ❖ **DRM**

A technology for protecting copyrighted digital data. Digitized movies, images and music retain the same quality even when they are copied or transferred repeatedly. DRM is a technology for restricting the distribution or playback of such digital data without the authorization of the copyright holder.

### ❖ **DTS Digital Surround**

DTS Digital Surround is an audio format to record 48 kHz/24 bits audio signals in 5.1 channels.

### ❖ **DTS-HD High Resolution Audio**

DTS-HD High Resolution Audio is an audio format using lossy coding. It can record 7.1 channels at 96 kHz/24 bits.

### ❖ **DTS-HD Master Audio**

DTS-HD Master Audio is an audio format using lossless coding. With BD-ROMs, 7.1 channels can be recorded at 96 kHz/24 bits, or 5.1 channels at 192 kHz/24 bits.

### ❖ **Dynamic range**

This refers to the difference between the maximum and minimum level of the sound. The dynamic range is measured in units of decibels (dB).

When the dynamic range is compressed (Audio DRC), the minimum signal level is increased and the maximum signal level decreased. This way, the volume of loud sounds such as explosions is reduced, while the sounds with a low level, such as human voices, are easier to listen to.

### ❖ **Frames and fields**

A frame is the unit for one of the still pictures which compose motion pictures. One frame consists of a picture of odd lines and a picture of even lines called fields in video signal with interlaced scan method (480i, 1080i, etc.).

### ❖ **HDCP (High-bandwidth Digital Content Protection)**

A technology for protecting copyrights that encrypts digital video signals.

### ❖ **HDMI (High-Definition Multimedia Interface)**

A digital interface standard for next-generation TVs expanding the DVI (Digital Video Interface) terminal used for example for computer displays. It allows transfer of non-compressed digital video and audio signals (Dolby TrueHD, Dolby Digital Plus, Dolby Digital, DTS-HD Master Audio, DTS-HD High Resolution Audio, DTS Digital Surround, MPEG or linear PCM) with a single connector.

### ❖ **Interactive audio**

The audio signals recorded in the titles of BD-ROMs. They include for example the clicking sound made when the menu screen is operated.

### ❖ **Interlaced scan**

With this method, one picture is displayed by scanning it twice. The odd lines are displayed in the first pass, the even lines are displayed in the second, to form a single picture (frame). Interlaced scan is indicated in this player and operating instructions by an "i" after the resolution value (for example, 480i).

### ❖ **Linear PCM**

This is referred as the audio signals that are not compressed, frequently used for DVD-Video discs containing musicals or music concerts. This can also be indicated "48 kHz/16 bit", "96 kHz", etc.

### ❖ **MPEG (Moving Picture Experts Group)**

The name of a family of standards used to encode video and audio signals in a digital compressed format. The video encoding standards include MPEG-1 Video, MPEG-2 Video, MPEG-4 Visual and MPEG-4 AVC. The audio encoding standards include MPEG-1 Audio, MPEG-2 Audio and MPEG-2 AAC.

### ❖ **Multi angle**

Up to 9 camera angles can be recorded simultaneously on BD-ROM or DVD-Video discs, letting you watch the same scene from different angles.

### ❖ **Parental Lock**

Playback of the contents of some BD-ROM or DVD-Video discs can be restricted, for example for discs containing scenes of violence. With BD-ROM discs, an age restriction can be set to restrict playback. Playing DVD-Video title can be restricted by setting the parental lock level.

### ❖ **Picture-in-Picture (P-in-P)**

This is a function for superimposing a sub video on the main video. Some BD-ROMs include secondary video, which can be superimposed on the primary video.

### ❖ **Progressive scan**

With this method, one picture is consisted of a single picture, without dividing it in two pictures. Progressive scan provides clear pictures with no flicker, in particular for still pictures that contain much text, graphics, or horizontal lines. Progressive scan is indicated in this player and operating instructions by a "p" after the resolution value (for example, 480p).

### ❖ **Region number**

A number assigned to Blu-ray Disc Players, BD-ROM and DVD-Video discs according to the region in which they are sold. A disc can be played if the region numbers indicated on the disc include the number set for the player or if "ALL" is indicated.



❖ **S-Video output**

An output terminal for transmitting separate luminance (Y) and color (C) signals over a single cord. It offers clearer pictures than the composite video output.

❖ **Secondary audio**

Some BD-ROMs include sub audio streams mixed with the main audio. These sub audio streams are called "secondary audio". On some discs this secondary audio is recorded as the audio for the secondary video.

❖ **Secondary video**

Some BD-ROMs include sub videos superimposed on the main videos using the Picture-in-Picture function. These sub videos are called "secondary video".

❖ **Subtitle language**

This refers to the language of the subtitles often used on movies. Up to 255 languages (255 types of subtitles) can be recorded on BD-ROM discs, 32 languages (32 types of subtitles) on DVD-Video discs, so you can select the desired subtitle when watching the disc.

❖ **VC-1**

A video codec developed by Microsoft and standardized by the Society of Motion Picture and Television Engineers (SMPTE). Some BDs include videos encoded in this codec.

The licenses for the software used on this player are shown below.

### ❖ libxml2

#### The MIT License

Copyright © <year> <copyright holders>

Permission is hereby granted, free of charge, to any person obtaining a copy of this software and associated documentation files (the "Software"), to deal in the Software without restriction, including without limitation the rights to use, copy, modify, merge, publish, distribute, sublicense, and/or sell copies of the Software, and to permit persons to whom the Software is furnished to do so, subject to the following conditions:

The above copyright notice and this permission notice shall be included in all copies or substantial portions of the Software.

THE SOFTWARE IS PROVIDED "AS IS", WITHOUT WARRANTY OF ANY KIND, EXPRESS OR IMPLIED, INCLUDING BUT NOT LIMITED TO THE WARRANTIES OF MERCHANTABILITY, FITNESS FOR A PARTICULAR PURPOSE AND NONINFRINGEMENT. IN NO EVENT SHALL THE AUTHORS OR COPYRIGHT HOLDERS BE LIABLE FOR ANY CLAIM, DAMAGES OR OTHER LIABILITY, WHETHER IN AN ACTION OF CONTRACT, TORT OR OTHERWISE, ARISING FROM, OUT OF OR IN CONNECTION WITH THE SOFTWARE OR THE USE OR OTHER DEALINGS IN THE SOFTWARE.

### ❖ OpenSSL

The OpenSSL toolkit stays under a dual license, i.e. both the conditions of the OpenSSL License and the original SSLeay license apply to the toolkit.

See below for the actual license texts. Actually both licenses are BSD-style Open Source licenses. In case of any license issues related to OpenSSL please contact openssl-core@openssl.org.

#### OpenSSL License

Copyright © 1998-2007 The OpenSSL Project. All rights reserved.

Redistribution and use in source and binary forms, with or without modification, are permitted provided that the following conditions are met:

1. Redistributions of source code must retain the above copyright notice, this list of conditions and the following disclaimer.
2. Redistributions in binary form must reproduce the above copyright notice, this list of conditions and the following disclaimer in the documentation and/or other materials provided with the distribution.
3. All advertising materials mentioning features or use of this software must display the following acknowledgment: "This product includes software developed by the OpenSSL Project for use in the OpenSSL Toolkit. (<http://www.openssl.org/>)"
4. The names "OpenSSL Toolkit" and "OpenSSL Project" must not be used to endorse or promote products derived from this software without prior written permission. For written permission, please contact openssl-core@openssl.org.
5. Products derived from this software may not be called "OpenSSL" nor may "OpenSSL" appear in their names without prior written permission of the OpenSSL Project.
6. Redistributions of any form whatsoever must retain the following acknowledgment: "This product includes software developed by the OpenSSL Project for use in the OpenSSL Toolkit (<http://www.openssl.org/>)"

THIS SOFTWARE IS PROVIDED BY THE OPENSSL PROJECT ``AS IS'' AND ANY EXPRESSED OR IMPLIED WARRANTIES, INCLUDING, BUT NOT LIMITED TO, THE IMPLIED WARRANTIES OF MERCHANTABILITY AND FITNESS FOR A PARTICULAR PURPOSE ARE DISCLAIMED. IN NO EVENT SHALL THE OPENSSL PROJECT OR ITS CONTRIBUTORS BE LIABLE FOR ANY DIRECT, INDIRECT, INCIDENTAL, SPECIAL, EXEMPLARY, OR CONSEQUENTIAL DAMAGES (INCLUDING, BUT NOT LIMITED TO, PROCUREMENT OF SUBSTITUTE GOODS OR SERVICES; LOSS OF USE, DATA, OR PROFITS; OR BUSINESS INTERRUPTION) HOWEVER CAUSED AND ON ANY THEORY OF LIABILITY, WHETHER IN CONTRACT, STRICT LIABILITY, OR TORT (INCLUDING NEGLIGENCE OR OTHERWISE) ARISING IN ANY WAY OUT OF THE USE OF THIS SOFTWARE, EVEN IF ADVISED OF THE POSSIBILITY OF SUCH DAMAGE.

This product includes cryptographic software written by Eric Young ([ey@cryptsoft.com](mailto:ey@cryptsoft.com)). This product includes software written by Tim Hudson ([tjh@cryptsoft.com](mailto:tjh@cryptsoft.com)).

#### Original SSLeay License

Copyright © 1995-1998 Eric Young ([ey@cryptsoft.com](mailto:ey@cryptsoft.com))

All rights reserved.

This package is an SSL implementation written by Eric Young ([ey@cryptsoft.com](mailto:ey@cryptsoft.com)). The implementation was written so as to conform with Netscapes SSL.

This library is free for commercial and non-commercial use as long as the following conditions are aheared to. The following conditions apply to all code found in this distribution, be it the RC4, RSA, lhash, DES, etc., code; not just the SSL code. The SSL documentation included with this distribution is covered by the same copyright terms except that the holder is Tim Hudson ([tjh@cryptsoft.com](mailto:tjh@cryptsoft.com)).

Copyright remains Eric Young's, and as such any Copyright notices in the code are not to be removed. If this package is used in a product, Eric Young should be given attribution as the author of the parts of the library used. This can be in the form of a textual message at program startup or in documentation (online or textual) provided with the package.

Redistribution and use in source and binary forms, with or without modification, are permitted provided that the following conditions are met:

1. Redistributions of source code must retain the copyright notice, this list of conditions and the following disclaimer.
2. Redistributions in binary form must reproduce the above copyright notice, this list of conditions and the following disclaimer in the documentation and/or other materials provided with the distribution.
3. All advertising materials mentioning features or use of this software must display the following acknowledgement: "This product includes cryptographic software written by Eric Young ([ey@cryptsoft.com](mailto:ey@cryptsoft.com))"  
The word 'cryptographic' can be left out if the rouines from the library being used are not cryptographic related :-).
4. If you include any Windows specific code (or a derivative thereof) from the apps directory (application code) you must include an acknowledgement: "This product includes software written by Tim Hudson ([tjh@cryptsoft.com](mailto:tjh@cryptsoft.com))"

THIS SOFTWARE IS PROVIDED BY ERIC YOUNG ``AS IS'' AND ANY EXPRESS OR IMPLIED WARRANTIES, INCLUDING, BUT NOT LIMITED TO, THE IMPLIED WARRANTIES OF MERCHANTABILITY AND FITNESS FOR A PARTICULAR PURPOSE ARE DISCLAIMED. IN NO EVENT SHALL THE AUTHOR OR CONTRIBUTORS BE LIABLE FOR ANY DIRECT, INDIRECT, INCIDENTAL, SPECIAL, EXEMPLARY, OR CONSEQUENTIAL DAMAGES (INCLUDING, BUT NOT LIMITED TO, PROCUREMENT OF SUBSTITUTE GOODS OR SERVICES; LOSS OF USE, DATA, OR PROFITS; OR BUSINESS INTERRUPTION) HOWEVER CAUSED AND ON ANY THEORY OF LIABILITY, WHETHER IN CONTRACT, STRICT LIABILITY, OR TORT (INCLUDING NEGLIGENCE OR OTHERWISE) ARISING IN ANY WAY OUT OF THE USE OF THIS SOFTWARE, EVEN IF ADVISED OF THE POSSIBILITY OF SUCH DAMAGE.

The licence and distribution terms for any publically available version or derivative of this code cannot be changed. i.e. this code cannot simply be copied and put under another distribution licence [including the GNU Public Licence.]

### ❖ zlib

This software is based in part on zlib see <http://www.zlib.net> for information.

### ❖ FreeType2

#### The FreeType Project LICENSE

2006-Jan-27 Copyright 1996-2002, 2006 by David Turner, Robert Wilhelm, and Werner Lemberg

## Introduction

The FreeType Project is distributed in several archive packages; some of them may contain, in addition to the FreeType font engine, various tools and contributions which rely on, or relate to, the FreeType Project.

This license applies to all files found in such packages, and which do not fall under their own explicit license. The license affects thus the FreeType font engine, the test programs, documentation and makefiles, at the very least.

This license was inspired by the BSD, Artistic, and IJG (Independent JPEG Group) licenses, which all encourage inclusion and use of free software in commercial and freeware products alike. As a consequence, its main points are that:

- We don't promise that this software works. However, we will be interested in any kind of bug reports. ('as is' distribution)
- You can use this software for whatever you want, in parts or full form, without having to pay us. ('royalty-free' usage)
- You may not pretend that you wrote this software. If you use it, or only parts of it, in a program, you must acknowledge somewhere in your documentation that you have used the FreeType code. ('credits')

We specifically permit and encourage the inclusion of this software, with or without modifications, in commercial products. We disclaim all warranties covering The FreeType Project and assume no liability related to The FreeType Project.

Finally, many people asked us for a preferred form for a credit/disclaimer to use in compliance with this license. We thus encourage you to use the following text:

Portions of this software are copyright © <year> The FreeType Project (www.freetype.org). All rights reserved.

Please replace <year> with the value from the FreeType version you actually use.

## Legal Terms

### 0. Definitions

Throughout this license, the terms 'package', 'FreeType Project', and 'FreeType archive' refer to the set of files originally distributed by the authors (David Turner, Robert Wilhelm, and Werner Lemberg) as the 'FreeType Project', be they named as alpha, beta or final release.

'You' refers to the licensee, or person using the project, where 'using' is a generic term including compiling the project's source code as well as linking it to form a 'program' or 'executable'. This program is referred to as 'a program using the FreeType engine'.

This license applies to all files distributed in the original FreeType Project, including all source code, binaries and documentation, unless otherwise stated in the file in its original, unmodified form as distributed in the original archive. If you are unsure whether or not a particular file is covered by this license, you must contact us to verify this.

The FreeType Project is copyright (C) 1996-2000 by David Turner, Robert Wilhelm, and Werner Lemberg. All rights reserved except as specified below.

### 1. No Warranty

THE FREETYPE PROJECT IS PROVIDED 'AS IS' WITHOUT WARRANTY OF ANY KIND, EITHER EXPRESS OR IMPLIED, INCLUDING, BUT NOT LIMITED TO, WARRANTIES OF MERCHANTABILITY AND FITNESS FOR A PARTICULAR PURPOSE. IN NO EVENT WILL ANY OF THE AUTHORS OR COPYRIGHT HOLDERS BE LIABLE FOR ANY DAMAGES CAUSED BY THE USE OR THE INABILITY TO USE, OF THE FREETYPE PROJECT.

### 2. Redistribution

This license grants a worldwide, royalty-free, perpetual and irrevocable right and license to use, execute, perform, compile, display, copy, create derivative works of, distribute and sublicense the FreeType Project (in both source and object code forms) and derivative works thereof for any purpose; and to authorize others to exercise some or all of the rights granted herein, subject to the following conditions:

- Redistribution of source code must retain this license file (FTL.TXT) unaltered; any additions, deletions or changes to the original files must be clearly indicated in accompanying documentation. The copyright notices of the unaltered, original files must be preserved in all copies of source files.
- Redistribution in binary form must provide a disclaimer that states that the software is based in part of the work of the FreeType Team, in the distribution documentation. We also encourage you to put an URL to the FreeType web page in your documentation, though this isn't mandatory.

These conditions apply to any software derived from or based on the FreeType Project, not just the unmodified files. If you use our work, you must acknowledge us. However, no fee need be paid to us.

### 3. Advertising

Neither the FreeType authors and contributors nor you shall use the name of the other for commercial, advertising, or promotional purposes without specific prior written permission.

We suggest, but do not require, that you use one or more of the following phrases to refer to this software in your documentation or advertising materials: 'FreeType Project', 'FreeType Engine', 'FreeType library', or 'FreeType Distribution'.

As you have not signed this license, you are not required to accept it. However, as the FreeType Project is copyrighted material, only this license, or another one contracted with the authors, grants you the right to use, distribute, and modify it. Therefore, by using, distributing, or modifying the FreeType Project, you indicate that you understand and accept all the terms of this license.

### 4. Contacts

There are two mailing lists related to FreeType:

- [freetype@nongnu.org](mailto:freetype@nongnu.org)  
Discusses general use and applications of FreeType, as well as future and wanted additions to the library and distribution. If you are looking for support, start in this list if you haven't found anything to help you in the documentation.
- [freetype-devel@nongnu.org](mailto:freetype-devel@nongnu.org)  
Discusses bugs, as well as engine internals, design issues, specific licenses, porting, etc.

Our home page can be found at

<http://www.freetype.org>

## ❖ libpng

COPYRIGHT NOTICE, DISCLAIMER, and LICENSE:

If you modify libpng you may insert additional notices immediately following this sentence.

libpng versions 1.2.6, August 15, 2004, through 1.2.26, April 2, 2008, are Copyright © 2004, 2006-2008 Glenn Randers-Pehrson, and are distributed according to the same disclaimer and license as libpng-1.2.5 with the following individual added to the list of Contributing Authors

Cosmin Truta

libpng versions 1.0.7, July 1, 2000, through 1.2.5 - October 3, 2002, are Copyright © 2000-2002 Glenn Randers-Pehrson, and are distributed according to the same disclaimer and license as libpng-1.0.6 with the following individuals added to the list of Contributing Authors

Simon-Pierre Cadieux

Eric S. Raymond

Gilles Vollant

and with the following additions to the disclaimer:

There is no warranty against interference with your enjoyment of the library or against infringement. There is no warranty that our efforts or the library will fulfill any of your particular purposes or needs. This library is provided with all faults, and the entire risk of satisfactory quality, performance, accuracy, and effort is with the user.

libpng versions 0.97, January 1998, through 1.0.6, March 20, 2000, are Copyright © 1998, 1999 Glenn Randers-Pehrson, and are distributed according to the same disclaimer and license as libpng-0.96, with the following individuals added to the list of Contributing Authors:

Tom Lane

Glenn Randers-Pehrson

Willem van Schaik

libpng versions 0.89, June 1996, through 0.96, May 1997, are Copyright © 1996, 1997 Andreas Dilger Distributed according to the same disclaimer and license as libpng-0.88, with the following individuals added to the list of Contributing Authors:

John Bowler  
Kevin Bracey  
Sam Bushell  
Magnus Holmgren  
Greg Roelofs  
Tom Tanner

libpng versions 0.5, May 1995, through 0.88, January 1996, are Copyright © 1995, 1996 Guy Eric Schalnat, Group 42, Inc. For the purposes of this copyright and license, "Contributing Authors" is defined as the following set of individuals:

Andreas Dilger  
Dave Martindale  
Guy Eric Schalnat  
Paul Schmidt  
Tim Wegner

The PNG Reference Library is supplied "AS IS". The Contributing Authors and Group 42, Inc. disclaim all warranties, expressed or implied, including, without limitation, the warranties of merchantability and of fitness for any purpose. The Contributing Authors and Group 42, Inc. assume no liability for direct, indirect, incidental, special, exemplary, or consequential damages, which may result from the use of the PNG Reference Library, even if advised of the possibility of such damage.

Permission is hereby granted to use, copy, modify, and distribute this source code, or portions hereof, for any purpose, without fee, subject to the following restrictions:

1. The origin of this source code must not be misrepresented.
2. Altered versions must be plainly marked as such and must not be misrepresented as being the original source.
3. This Copyright notice may not be removed or altered from any source or altered source distribution.

The Contributing Authors and Group 42, Inc. specifically permit, without fee, and encourage the use of this source code as a component to supporting the PNG file format in commercial products. If you use this source code in a product, acknowledgment is not required but would be appreciated.

A "png\_get\_copyright" function is available, for convenient use in "about" boxes and the like: `printf("%s", png_get_copyright(NULL));` Also, the PNG logo (in PNG format, of course) is supplied in the files "pngbar.png" and "pngbar.jpg (88x31)" and "pngnow.png" (98x31).

Libpng is OSI Certified Open Source Software. OSI Certified Open Source is a certification mark of the Open Source Initiative.

Glenn Randers-Pehrson  
glennrp at users.sourceforge.net  
2-Apr-08

## ❖ libjppg

The Independent JPEG Group's JPEG software

README for release 6b of 27-Mar-1998

This distribution contains the sixth public release of the Independent JPEG Group's free JPEG software. You are welcome to redistribute this software and to use it for any purpose, subject to the conditions under LEGAL ISSUES, below.

Serious users of this software (particularly those incorporating it into larger programs) should contact IJG at [jpeg-info@uunet.uu.net](mailto:jpeg-info@uunet.uu.net) to be added to our electronic mailing list. Mailing list members are notified of updates and have a chance to participate in technical discussions, etc.

This software is the work of Tom Lane, Philip Gladstone, Jim Boucher, Lee Crocker, Julian Minguillon, Luis Ortiz, George Phillips, Davide Rossi, Guido Vollbeding, Ge' Weijers, and other members of the Independent JPEG Group.

IJG is not affiliated with the official ISO JPEG standards committee.

DOCUMENTATION ROADMAP

This file contains the following sections:

OVERVIEW	General description of JPEG and the IJG software.
LEGAL ISSUES	Copyright, lack of warranty, terms of distribution.
REFERENCES	Where to learn more about JPEG.
ARCHIVE LOCATIONS	Where to find newer versions of this software.
RELATED SOFTWARE	Other stuff you should get.
FILE FORMAT WARS	Software *not* to get.
TO DO	Plans for future IJG releases.

Other documentation files in the distribution are:

User documentation:

install.doc	How to configure and install the IJG software.
usage.doc	Usage instructions for cjpeg, djpeg, jpegtran, rdjpgcom, and wrjpgcom. *.1 Unix-style man pages for programs (same info as usage.doc).
wizard.doc	Advanced usage instructions for JPEG wizards only.
change.log	Version-to-version change highlights.

Programmer and internal documentation:

libjpeg.doc	How to use the JPEG library in your own programs.
example.c	Sample code for calling the JPEG library.
structure.doc	Overview of the JPEG library's internal structure.
filelist.doc	Road map of IJG files.
coderrules.doc	Coding style rules --- please read if you contribute code.

Please read at least the files `install.doc` and `usage.doc`. Useful information can also be found in the JPEG FAQ (Frequently Asked Questions) article. See ARCHIVE LOCATIONS below to find out where to obtain the FAQ article.

If you want to understand how the JPEG code works, we suggest reading one or more of the REFERENCES, then looking at the documentation files (in roughly the order listed) before diving into the code.

OVERVIEW

This package contains C software to implement JPEG image compression and decompression. JPEG (pronounced "jay-peg") is a standardized compression method for full-color and gray-scale images. JPEG is intended for compressing real-world scenes; line drawings, cartoons and other non-realistic images are not its strong suit. JPEG is lossy, meaning that the output image is not exactly identical to the input image. Hence you must not use JPEG if you have to have identical output bits. However, on typical photographic images, very good compression levels can be obtained with no visible change, and remarkably high compression levels are possible if you can tolerate a low-quality image. For more details, see the references, or just experiment with various compression settings.

This software implements JPEG baseline, extended-sequential, and progressive compression processes. Provision is made for supporting all variants of these processes, although some uncommon parameter settings aren't implemented yet. For legal reasons, we are not distributing code for the arithmetic-coding variants of JPEG; see LEGAL ISSUES. We have made no provision for supporting the hierarchical or lossless processes defined in the standard.

We provide a set of library routines for reading and writing JPEG image files, plus two sample applications "cjpeg" and "djpeg", which use the library to perform conversion between JPEG and some other popular image file formats. The library is intended to be reused in other applications.

In order to support file conversion and viewing software, we have included considerable functionality beyond the bare JPEG coding/decoding capability; for example, the color quantization modules are not strictly part of JPEG decoding, but they are essential for output to colormapped file formats or colormapped displays. These extra functions can be compiled out of the library if not required for a particular application. We have also included jpegtran, a utility for lossless transcoding between different JPEG processes, and "rdjpgcom" and "wrjpgcom", two simple applications for inserting and extracting textual comments in JFIF files.

The emphasis in designing this software has been on achieving portability and flexibility, while also making it fast enough to be useful. In particular, the software is not intended to be read as a tutorial on JPEG. (See the REFERENCES section for introductory material.) Rather, it is intended to be reliable, portable, industrial-strength code. We do not claim to have achieved that goal in every aspect of the software, but we strive for it.

We welcome the use of this software as a component of commercial products. No royalty is required, but we do ask for an acknowledgement in product documentation, as described under LEGAL ISSUES.

#### LEGAL ISSUES

In plain English:

1. We don't promise that this software works. (But if you find any bugs, please let us know!)
2. You can use this software for whatever you want. You don't have to pay us.
3. You may not pretend that you wrote this software. If you use it in a program, you must acknowledge somewhere in your documentation that you've used the IJG code.

In legalese:

The authors make NO WARRANTY or representation, either express or implied, with respect to this software, its quality, accuracy, merchantability, or fitness for a particular purpose. This software is provided "AS IS", and you, its user, assume the entire risk as to its quality and accuracy.

This software is copyright © 1991-1998, Thomas G. Lane. All Rights Reserved except as specified below.

Permission is hereby granted to use, copy, modify, and distribute this software (or portions thereof) for any purpose, without fee, subject to these conditions:

- (1) If any part of the source code for this software is distributed, then this README file must be included, with this copyright and no-warranty notice unaltered; and any additions, deletions, or changes to the original files must be clearly indicated in accompanying documentation.
- (2) If only executable code is distributed, then the accompanying documentation must state that "this software is based in part on the work of the Independent JPEG Group".
- (3) Permission for use of this software is granted only if the user accepts full responsibility for any undesirable consequences; the authors accept NO LIABILITY for damages of any kind.

These conditions apply to any software derived from or based on the IJG code, not just to the unmodified library. If you use our work, you ought to acknowledge us.

Permission is NOT granted for the use of any IJG author's name or company name in advertising or publicity relating to this software or products derived from it. This software may be referred to only as "the Independent JPEG Group's software".

We specifically permit and encourage the use of this software as the basis of commercial products, provided that all warranty or liability claims are assumed by the product vendor.

ansi2knr.c is included in this distribution by permission of L. Peter Deutsch, sole proprietor of its copyright holder, Aladdin Enterprises of Menlo Park, CA. ansi2knr.c is NOT covered by the above copyright and conditions, but instead by the usual distribution terms of the Free Software Foundation; principally, that you must include source code if you redistribute it. (See the file ansi2knr.c for full details.) However, since ansi2knr.c is not needed as part of any program generated from the IJG code, this does not limit you more than the foregoing paragraphs do.

The Unix configuration script "configure" was produced with GNU Autoconf. It is copyright by the Free Software Foundation but is freely distributable. The same holds for its supporting scripts (config.guess, config.sub, ltconfig, ltmain.sh). Another support script, install-sh, is copyright by M.I.T. but is also freely distributable.

It appears that the arithmetic coding option of the JPEG spec is covered by patents owned by IBM, AT&T, and Mitsubishi. Hence arithmetic coding cannot legally be used without obtaining one or more licenses. For this reason, support for arithmetic coding has been removed from the free JPEG software. (Since arithmetic coding provides only a marginal gain over the unpatented Huffman mode, it is unlikely that very many implementations will support it.) So far as we are aware, there are no patent restrictions on the remaining code.

The IJG distribution formerly included code to read and write GIF files. To avoid entanglement with the Unisys LZW patent, GIF reading support has been removed altogether, and the GIF writer has been simplified to produce uncompressed GIFs. This technique does not use the LZW algorithm; the resulting GIF files are larger than usual, but are readable by all standard GIF decoders.

We are required to state that

"The Graphics Interchange Format(c) is the Copyright property of CompuServe Incorporated. GIF(sm) is a Service Mark property of CompuServe Incorporated."

#### REFERENCES

We highly recommend reading one or more of these references before trying to understand the innards of the JPEG software.

The best short technical introduction to the JPEG compression algorithm is

Wallace, Gregory K. "The JPEG Still Picture Compression Standard",  
Communications of the ACM, April 1991 (vol. 34 no. 4), pp. 30-44.

(Adjacent articles in that issue discuss MPEG motion picture compression, applications of JPEG, and related topics.) If you don't have the CACM issue handy, a PostScript file containing a revised version of Wallace's article is available at <ftp://ftp.uu.net/graphics/jpeg/wallace.ps.gz>. The file (actually a preprint for an article that appeared in IEEE Trans. Consumer Electronics) omits the sample images that appeared in CACM, but it includes corrections and some added material. Note: the Wallace article is copyright ACM and IEEE, and it may not be used for commercial purposes.

A somewhat less technical, more leisurely introduction to JPEG can be found in The Data Compression Book by Mark Nelson and Jean-loup Gailly, published by M&T Books (New York), 2nd ed. 1996, ISBN 1-55851-434-1. This book provides good explanations and example C code for a multitude of compression methods including JPEG. It is an excellent source if you are comfortable reading C code but don't know much about data compression in general. The book's JPEG sample code is far from industrial-strength, but when you are ready to look at a full implementation, you've got one here...

The best full description of JPEG is the textbook "JPEG Still Image Data Compression Standard" by William B. Pennebaker and Joan L. Mitchell, published by Van Nostrand Reinhold, 1993, ISBN 0-442-01272-1. Price US\$59.95, 638 pp. The book includes the complete text of the ISO JPEG standards (DIS 10918-1 and draft DIS 10918-2). This is by far the most complete exposition of JPEG in existence, and we highly recommend it.

The JPEG standard itself is not available electronically; you must order a paper copy through ISO or ITU. (Unless you feel a need to own a certified official copy, we recommend buying the Pennebaker and Mitchell book instead; it's much cheaper and includes a great deal of useful explanatory material.) In the USA, copies of the standard may be ordered from ANSI Sales at (212) 642-4900, or from Global Engineering Documents at (800) 854-7179. (ANSI doesn't take credit card orders, but Global does.) It's not cheap: as of 1992, ANSI was charging \$95 for Part 1 and \$47 for Part 2, plus 7% shipping/handling. The standard is divided into two parts, Part 1 being the actual specification, while Part 2 covers compliance testing methods. Part 1 is titled "Digital Compression and Coding of Continuous-tone Still Images, Part 1: Requirements and guidelines" and has document numbers ISO/IEC IS 10918-1, ITU-T T.81. Part 2 is titled "Digital Compression and Coding of Continuous-tone Still Images, Part 2: Compliance testing" and has document numbers ISO/IEC IS 10918-2, ITU-T T.83.

Some extensions to the original JPEG standard are defined in JPEG Part 3, a newer ISO standard numbered ISO/IEC IS 10918-3 and ITU-T T.84. IJG currently does not support any Part 3 extensions.

The JPEG standard does not specify all details of an interchangeable file format. For the omitted details we follow the "JFIF" conventions, revision 1.02. A copy of the JFIF spec is available from:

Literature Department  
C-Cube Microsystems, Inc.  
1778 McCarthy Blvd.  
Milpitas, CA 95035  
phone (408) 944-6300, fax (408) 944-6314

A PostScript version of this document is available by FTP at <ftp://ftp.uu.net/graphics/jpeg/jfif.ps.gz>. There is also a plain text version at <ftp://ftp.uu.net/graphics/jpeg/jfif.txt.gz>, but it is missing the figures.

The TIFF 6.0 file format specification can be obtained by FTP from <ftp://ftp.sgi.com/graphics/tiff/TIFF6.ps.gz>. The JPEG incorporation scheme found in the TIFF 6.0 spec of 3-June-92 has a number of serious problems. IJG does not recommend use of the TIFF 6.0 design (TIFF Compression tag 6). Instead, we recommend the JPEG design proposed by TIFF Technical Note #2 (Compression tag 7). Copies of this Note can be obtained from <ftp.sgi.com> or from <ftp://ftp.uu.net/graphics/jpeg/>. It is expected that the next revision of the TIFF spec will replace the 6.0 JPEG design with the Note's design. Although IJG's own code does not support TIFF/JPEG, the free libtiff library uses our library to implement TIFF/JPEG per the Note. libtiff is available from <ftp://ftp.sgi.com/graphics/tiff/>.

#### ARCHIVE LOCATIONS

The "official" archive site for this software is <ftp.uu.net> (Internet address 192.48.96.9). The most recent released version can always be found there in directory `graphics/jpeg`. This particular version will be archived as <ftp://ftp.uu.net/graphics/jpeg/jpegsrc.v6b.tar.gz>. If you don't have direct Internet access, UUNET's archives are also available via UUCP; contact [help@uunet.uu.net](mailto:help@uunet.uu.net) for information on retrieving files that way.

Numerous Internet sites maintain copies of the UUNET files. However, only <ftp.uu.net> is guaranteed to have the latest official version.

You can also obtain this software in DOS-compatible "zip" archive format from the SimTel archives (<ftp://ftp.simtel.net/pub/simtelnet/msdos/graphics/>), or on CompuServe in the Graphics Support forum (GO CIS:GRAPHSUP), library 12 JPEG Tools. Again, these versions may sometimes lag behind the <ftp.uu.net> release.

The JPEG FAQ (Frequently Asked Questions) article is a useful source of general information about JPEG. It is updated constantly and therefore is not included in this distribution. The FAQ is posted every two weeks to Usenet newsgroups `comp.graphics.misc`, `news.answers`, and other groups. It is available on the World Wide Web at <http://www.faqs.org/faqs/jpeg-faq/> and other `news.answers` archive sites, including the official `news.answers` archive at <rtfm.mit.edu>: <ftp://rtfm.mit.edu/pub/usenet/news.answers/jpeg-faq/>. If you don't have Web or FTP access, send e-mail to [mail-server@rtfm.mit.edu](mailto:mail-server@rtfm.mit.edu) with body

```
send usenet/news.answers/jpeg-faq/part1
send usenet/news.answers/jpeg-faq/part2
```

#### RELATED SOFTWARE

Numerous viewing and image manipulation programs now support JPEG. (Quite a few of them use this library to do so.) The JPEG FAQ described above lists some of the more popular free and shareware viewers, and tells where to obtain them on Internet.

If you are on a Unix machine, we highly recommend Jef Poskanzer's free PBMPLUS software, which provides many useful operations on PPM-format image files. In particular, it can convert PPM images to and from a wide range of other formats, thus making `cjpeg/djpeg` considerably more useful. The latest version is distributed by the NetPBM group, and is available from numerous sites, notably <ftp://wuarchive.wustl.edu/graphics/graphics/packages/NetPBM/>. Unfortunately PBMPLUS/NETPBM is not nearly as portable as the IJG software is; you are likely to have difficulty making it work on any non-Unix machine.

A different free JPEG implementation, written by the PVRG group at Stanford, is available from <ftp://havefun.stanford.edu/pub/jpeg/>. This program is designed for research and experimentation rather than production use; it is slower, harder to use, and less portable than the IJG code, but it is easier to read and modify. Also, the PVRG code supports lossless JPEG, which we do not. (On the other hand, it doesn't do progressive JPEG.)

#### FILE FORMAT WARS

Some JPEG programs produce files that are not compatible with our library. The root of the problem is that the ISO JPEG committee failed to specify a concrete file format. Some vendors "filled in the blanks" on their own, creating proprietary formats that no one else could read. (For example, none of the early commercial JPEG implementations for the Macintosh were able to exchange compressed files.)

The file format we have adopted is called JFIF (see REFERENCES). This format has been agreed to by a number of major commercial JPEG vendors, and it has become the de facto standard. JFIF is a minimal or "low end" representation. We recommend the use of TIFF/JPEG (TIFF revision 6.0 as modified by TIFF Technical Note #2) for "high end" applications that need to record a lot of additional data about an image. TIFF/JPEG is fairly new and not yet widely supported, unfortunately.

The upcoming JPEG Part 3 standard defines a file format called SPIFF. SPIFF is interoperable with JFIF, in the sense that most JFIF decoders should be able to read the most common variant of SPIFF. SPIFF has some technical advantages over JFIF, but its major claim to fame is simply that it is an official standard rather than an informal one. At this point it is unclear whether SPIFF will supersede JFIF or whether JFIF will remain the de-facto standard. IJG intends to support SPIFF once the standard is frozen, but we have not decided whether it should become our default output format or not. (In any case, our decoder will remain capable of reading JFIF indefinitely.) Various proprietary file formats incorporating JPEG compression also exist. We have little or no sympathy for the existence of these formats. Indeed, one of the original reasons for developing this free software was to help force convergence on common, open format standards for JPEG files. Don't use a proprietary file format!

#### TO DO

The major thrust for v7 will probably be improvement of visual quality. The current method for scaling the quantization tables is known not to be very good at low Q values. We also intend to investigate block boundary smoothing, "poor man's variable quantization", and other means of improving quality-vs-file-size performance without sacrificing compatibility.

In future versions, we are considering supporting some of the upcoming JPEG Part 3 extensions --- principally, variable quantization and the SPIFF file format.

As always, speeding things up is of great interest.

Please send bug reports, offers of help, etc. to [jpeg-info@uunet.uu.net](mailto:jpeg-info@uunet.uu.net).

## ❖ GNU GENERAL PUBLIC LICENSE

Version 2, June 1991

Copyright © 1989, 1991 Free Software Foundation, Inc., 51 Franklin Street, Fifth Floor, Boston, MA 02110-1301 USA

Everyone is permitted to copy and distribute verbatim copies of this license document, but changing it is not allowed.

#### Preamble

The licenses for most software are designed to take away your freedom to share and change it. By contrast, the GNU General Public License is intended to guarantee your freedom to share and change free software - to make sure the software is free for all its users. This General Public License applies to most of the Free Software Foundation's software and to any other program whose authors commit to using it. (Some other Free Software Foundation software is covered by the GNU Lesser General Public License instead.) You can apply it to your programs, too.

When we speak of free software, we are referring to freedom, not price. Our General Public Licenses are designed to make sure that you have the freedom to distribute copies of free software (and charge for this service if you wish), that you receive source code or can get it if you want it, that you can change the software or use pieces of it in new free programs; and that you know you can do these things.

To protect your rights, we need to make restrictions that forbid anyone to deny you these rights or to ask you to surrender the rights. These restrictions translate to certain responsibilities for you if you distribute copies of the software, or if you modify it.

For example, if you distribute copies of such a program, whether gratis or for a fee, you must give the recipients all the rights that you have. You must make sure that they, too, receive or can get the source code. And you must show them these terms so they know their rights.

We protect your rights with two steps: (1) copyright the software, and (2) offer you this license which gives you legal permission to copy, distribute and/or modify the software.

Also, for each author's protection and ours, we want to make certain that everyone understands that there is no warranty for this free software. If the software is modified by someone else and passed on, we want its recipients to know that what they have is not the original, so that any problems introduced by others will not reflect on the original authors' reputations.

Finally, any free program is threatened constantly by software patents. We wish to avoid the danger that redistributors of a free program will individually obtain patent licenses, in effect making the program proprietary. To prevent this, we have made it clear that any patent must be licensed for everyone's free use or not licensed at all.

The precise terms and conditions for copying, distribution and modification follow.

#### TERMS AND CONDITIONS FOR COPYING, DISTRIBUTION AND MODIFICATION

0. This License applies to any program or other work which contains a notice placed by the copyright holder saying it may be distributed under the terms of this General Public License. The "Program", below, refers to any such program or work, and a "work based on the Program" means either the Program or any derivative work under copyright law: that is to say, a work containing the Program or a portion of it, either verbatim or with modifications and/or translated into another language. (Hereinafter, translation is included without limitation in the term "modification".) Each licensee is addressed as "you".

Activities other than copying, distribution and modification are not covered by this License; they are outside its scope. The act of running the Program is not restricted, and the output from the Program is covered only if its contents constitute a work based on the Program (independent of having been made by running the Program). Whether that is true depends on what the Program does.

1. You may copy and distribute verbatim copies of the Program's source code as you receive it, in any medium, provided that you conspicuously and appropriately publish on each copy an appropriate copyright notice and disclaimer of warranty; keep intact all the notices that refer to this License and to the absence of any warranty; and give any other recipients of the Program a copy of this License along with the Program.

You may charge a fee for the physical act of transferring a copy, and you may at your option offer warranty protection in exchange for a fee.

2. You may modify your copy or copies of the Program or any portion of it, thus forming a work based on the Program, and copy and distribute such modifications or work under the terms of Section 1 above, provided that you also meet all of these conditions:
  - a) You must cause the modified files to carry prominent notices stating that you changed the files and the date of any change.
  - b) You must cause any work that you distribute or publish, that in whole or in part contains or is derived from the Program or any part thereof, to be licensed as a whole at no charge to all third parties under the terms of this License.
  - c) If the modified program normally reads commands interactively when run, you must cause it, when started running for such interactive use in the most ordinary way, to print or display an announcement including an appropriate copyright notice and a notice that there is no warranty (or else, saying that you provide a warranty) and that users may redistribute the program under these conditions, and telling the user how to view a copy of this License. (Exception: if the Program itself is interactive but does not normally print such an announcement, your work based on the Program is not required to print an announcement.)

These requirements apply to the modified work as a whole. If identifiable sections of that work are not derived from the Program, and can be reasonably considered independent and separate works in themselves, then this License, and its terms, do not apply to those sections when you distribute them as separate works. But when you distribute the same sections as part of a whole which is a work based on the Program, the distribution of the whole must be on the terms of this License, whose permissions for other licensees extend to the entire whole, and thus to each and every part regardless of who wrote it.

Thus, it is not the intent of this section to claim rights or contest your rights to work written entirely by you; rather, the intent is to exercise the right to control the distribution of derivative or collective works based on the Program.

In addition, mere aggregation of another work not based on the Program with the Program (or with a work based on the Program) on a volume of a storage or distribution medium does not bring the other work under the scope of this License.

3. You may copy and distribute the Program (or a work based on it, under Section 2) in object code or executable form under the terms of Sections 1 and 2 above provided that you also do one of the following:
  - a) Accompany it with the complete corresponding machine-readable source code, which must be distributed under the terms of Sections 1 and 2 above on a medium customarily used for software interchange; or,
  - b) Accompany it with a written offer, valid for at least three years, to give any third party, for a charge no more than your cost of physically performing source distribution, a complete machine-readable copy of the corresponding source code, to be distributed under the terms of Sections 1 and 2 above on a medium customarily used for software interchange; or,
  - c) Accompany it with the information you received as to the offer to distribute corresponding source code. (This alternative is allowed only for noncommercial distribution and only if you received the program in object code or executable form with such an offer, in accord with Subsection b above.)

The source code for a work means the preferred form of the work for making modifications to it. For an executable work, complete source code means all the source code for all modules it contains, plus any associated interface definition files, plus the scripts used to control compilation and installation of the executable. However, as a special exception, the source code distributed need not include anything that is normally distributed (in either source or binary form) with the major components (compiler, kernel, and so on) of the operating system on which the executable runs, unless that component itself accompanies the executable.

If distribution of executable or object code is made by offering access to copy from a designated place, then offering equivalent access to copy the source code from the same place counts as distribution of the source code, even though third parties are not compelled to copy the source along with the object code.

4. You may not copy, modify, sublicense, or distribute the Program except as expressly provided under this License. Any attempt otherwise to copy, modify, sublicense or distribute the Program is void, and will automatically terminate your rights under this License. However, parties who have received copies, or rights, from you under this License will not have their licenses terminated so long as such parties remain in full compliance.
5. You are not required to accept this License, since you have not signed it. However, nothing else grants you permission to modify or distribute the Program or its derivative works. These actions are prohibited by law if you do not accept this License. Therefore, by modifying or distributing the Program (or any work based on the Program), you indicate your acceptance of this License to do so, and all its terms and conditions for copying, distributing or modifying the Program or works based on it.
6. Each time you redistribute the Program (or any work based on the Program), the recipient automatically receives a license from the original licensor to copy, distribute or modify the Program subject to these terms and conditions. You may not impose any further restrictions on the recipients' exercise of the rights granted herein. You are not responsible for enforcing compliance by third parties to this License.
7. If, as a consequence of a court judgment or allegation of patent infringement or for any other reason (not limited to patent issues), conditions are imposed on you (whether by court order, agreement or otherwise) that contradict the conditions of this License, they do not excuse you from the conditions of this License. If you cannot distribute so as to satisfy simultaneously your obligations under this License and any other pertinent obligations, then as a consequence you may not distribute the Program at all. For example, if a patent license would not permit royalty-free redistribution of the Program by all those who receive copies directly or indirectly through you, then the only way you could satisfy both it and this License would be to refrain entirely from distribution of the Program. If any portion of this section is held invalid or unenforceable under any particular circumstance, the balance of the section is intended to apply and the section as a whole is intended to apply in other circumstances.

It is not the purpose of this section to induce you to infringe any patents or other property right claims or to contest validity of any such claims; this section has the sole purpose of protecting the integrity of the free software distribution system, which is implemented by public license practices. Many people have made generous contributions to the wide range of software distributed through that system in reliance on consistent application of that system; it is up to the author/donor to decide if he or she is willing to distribute software through any other system and a licensee cannot impose that choice.

This section is intended to make thoroughly clear what is believed to be a consequence of the rest of this License.

8. If the distribution and/or use of the Program is restricted in certain countries either by patents or by copyrighted interfaces, the original copyright holder who places the Program under this License may add an explicit geographical distribution limitation excluding those countries, so that distribution is permitted only in or among countries not thus excluded. In such case, this License incorporates the limitation as if written in the body of this License.
9. The Free Software Foundation may publish revised and/or new versions of the General Public License from time to time. Such new versions will be similar in spirit to the present version, but may differ in detail to address new problems or concerns. Each version is given a distinguishing version number. If the Program specifies a version number of this License which applies to it and "any later version", you have the option of following the terms and conditions either of that version or of any later version published by the Free Software Foundation. If the Program does not specify a version number of this License, you may choose any version ever published by the Free Software Foundation.
10. If you wish to incorporate parts of the Program into other free programs whose distribution conditions are different, write to the author to ask for permission. For software which is copyrighted by the Free Software Foundation, write to the Free Software Foundation; we sometimes make exceptions for this. Our decision will be guided by the two goals of preserving the free status of all derivatives of our free software and of promoting the sharing and reuse of software generally.

#### **NO WARRANTY**

11. BECAUSE THE PROGRAM IS LICENSED FREE OF CHARGE, THERE IS NO WARRANTY FOR THE PROGRAM, TO THE EXTENT PERMITTED BY APPLICABLE LAW. EXCEPT WHEN OTHERWISE STATED IN WRITING THE COPYRIGHT HOLDERS AND/OR OTHER PARTIES PROVIDE THE PROGRAM "AS IS" WITHOUT WARRANTY OF ANY KIND, EITHER EXPRESSED OR IMPLIED, INCLUDING, BUT NOT LIMITED TO, THE IMPLIED WARRANTIES OF MERCHANTABILITY AND FITNESS FOR A PARTICULAR PURPOSE. THE ENTIRE RISK AS TO THE QUALITY AND PERFORMANCE OF THE PROGRAM IS WITH YOU. SHOULD THE PROGRAM PROVE DEFECTIVE, YOU ASSUME THE COST OF ALL NECESSARY SERVICING, REPAIR OR CORRECTION.

12. IN NO EVENT UNLESS REQUIRED BY APPLICABLE LAW OR AGREED TO IN WRITING WILL ANY COPYRIGHT HOLDER, OR ANY OTHER PARTY WHO MAY MODIFY AND/OR REDISTRIBUTE THE PROGRAM AS PERMITTED ABOVE, BE LIABLE TO YOU FOR DAMAGES, INCLUDING ANY GENERAL, SPECIAL, INCIDENTAL OR CONSEQUENTIAL DAMAGES ARISING OUT OF THE USE OR INABILITY TO USE THE PROGRAM (INCLUDING BUT NOT LIMITED TO LOSS OF DATA OR DATA BEING RENDERED INACCURATE OR LOSSES SUSTAINED BY YOU OR THIRD PARTIES OR A FAILURE OF THE PROGRAM TO OPERATE WITH ANY OTHER PROGRAMS), EVEN IF SUCH HOLDER OR OTHER PARTY HAS BEEN ADVISED OF THE POSSIBILITY OF SUCH DAMAGES.

#### END OF TERMS AND CONDITIONS

##### How to Apply These Terms to Your New Programs

If you develop a new program, and you want it to be of the greatest possible use to the public, the best way to achieve this is to make it free software which everyone can redistribute and change under these terms.

To do so, attach the following notices to the program. It is safest to attach them to the start of each source file to most effectively convey the exclusion of warranty; and each file should have at least the "copyright" line and a pointer to where the full notice is found.

<one line to give the program's name and a brief idea of what it does.>

Copyright © <year> <name of author>

This program is free software; you can redistribute it and/or modify it under the terms of the GNU General Public License as published by the Free Software Foundation; either version 2 of the License, or (at your option) any later version.

This program is distributed in the hope that it will be useful, but WITHOUT ANY WARRANTY; without even the implied warranty of MERCHANTABILITY or FITNESS FOR A PARTICULAR PURPOSE. See the GNU General Public License for more details.

You should have received a copy of the GNU General Public License along with this program; if not, write to the Free Software Foundation, Inc., 51 Franklin Street, Fifth Floor, Boston, MA 02110-1301 USA.

Also add information on how to contact you by electronic and paper mail.

If the program is interactive, make it output a short notice like this when it starts in an interactive mode:

Gnomovision version 69, Copyright © year name of author

Gnomovision comes with ABSOLUTELY NO WARRANTY; for details type `show w'. This is free software, and you are welcome to redistribute it under certain conditions; type `show c' for details.

The hypothetical commands `show w' and `show c' should show the appropriate parts of the General Public License. Of course, the commands you use may be called something other than `show w' and `show c'; they could even be mouse-clicks or menu items - whatever suits your program.

You should also get your employer (if you work as a programmer) or your school, if any, to sign a "copyright disclaimer" for the program, if necessary. Here is a sample; alter the names:

Yoyodyne, Inc., hereby disclaims all copyright interest in the program `Gnomovision' (which makes passes at compilers) written by James Hacker.

<signature of Ty Coon>, 1 April 1989

Ty Coon, President of Vice

This General Public License does not permit incorporating your program into proprietary programs. If your program is a subroutine library, you may consider it more useful to permit linking proprietary applications with the library. If this is what you want to do, use the GNU Lesser General Public License instead of this License.

## ❖ GNU LESSER GENERAL PUBLIC LICENSE

Version 2.1, February 1999

Copyright © 1991, 1999 Free Software Foundation, Inc.

51 Franklin Street, Fifth Floor, Boston, MA 02110-1301 USA

Everyone is permitted to copy and distribute verbatim copies of this license document, but changing it is not allowed.

[This is the first released version of the Lesser GPL. It also counts as the successor of the GNU Library Public License, version 2, hence the version number 2.1.]

### Preamble

The licenses for most software are designed to take away your freedom to share and change it. By contrast, the GNU General Public Licenses are intended to guarantee your freedom to share and change free software - to make sure the software is free for all its users. This license, the Lesser General Public License, applies to some specially designated software packages - typically libraries - of the Free Software Foundation and other authors who decide to use it. You can use it too, but we suggest you first think carefully about whether this license or the ordinary General Public License is the better strategy to use in any particular case, based on the explanations below.

When we speak of free software, we are referring to freedom of use, not price. Our General Public Licenses are designed to make sure that you have the freedom to distribute copies of free software (and charge for this service if you wish); that you receive source code or can get it if you want it; that you can change the software and use pieces of it in new free programs; and that you are informed that you can do these things.

To protect your rights, we need to make restrictions that forbid distributors to deny you these rights or to ask you to surrender these rights. These restrictions translate to certain responsibilities for you if you distribute copies of the library or if you modify it.

For example, if you distribute copies of the library, whether gratis or for a fee, you must give the recipients all the rights that we gave you. You must make sure that they, too, receive or can get the source code. If you link other code with the library, you must provide complete object files to the recipients, so that they can relink them with the library after making changes to the library and recompiling it. And you must show them these terms so they know their rights. We protect your rights with a two-step method: (1) we copyright the library, and (2) we offer you this license, which gives you legal permission to copy, distribute and/or modify the library.

To protect each distributor, we want to make it very clear that there is no warranty for the free library. Also, if the library is modified by someone else and passed on, the recipients should know that what they have is not the original version, so that the original author's reputation will not be affected by problems that might be introduced by others.

Finally, software patents pose a constant threat to the existence of any free program. We wish to make sure that a company cannot effectively restrict the users of a free program by obtaining a restrictive license from a patent holder. Therefore, we insist that any patent license obtained for a version of the library must be consistent with the full freedom of use specified in this license.

Most GNU software, including some libraries, is covered by the ordinary GNU General Public License. This license, the GNU Lesser General Public License, applies to certain designated libraries, and is quite different from the ordinary General Public License. We use this license for certain libraries in order to permit linking those libraries into non-free programs.

When a program is linked with a library, whether statically or using a shared library, the combination of the two is legally speaking a combined work, a derivative of the original library. The ordinary General Public License therefore permits such linking only if the entire combination fits its criteria of freedom. The Lesser General Public License permits more lax criteria for linking other code with the library.

We call this license the "Lesser" General Public License because it does Less to protect the user's freedom than the ordinary General Public License. It also provides other free software developers Less of an advantage over competing non-free programs. These disadvantages are the reason we use the ordinary General Public License for many libraries. However, the Lesser license provides advantages in certain special circumstances.

For example, on rare occasions, there may be a special need to encourage the widest possible use of a certain library, so that it becomes a de-facto standard. To achieve this, non-free programs must be allowed to use the library. A more frequent case is that a free library does the same job as widely used non-free libraries. In this case, there is little to gain by limiting the free library to free software only, so we use the Lesser General Public License.

In other cases, permission to use a particular library in non-free programs enables a greater number of people to use a large body of free software. For example, permission to use the GNU C Library in non-free programs enables many more people to use the whole GNU operating system, as well as its variant, the GNU Linux operating system. Although the Lesser General Public License is Less protective of the users' freedom, it does ensure that the user of a program that is linked with the Library has the freedom and the wherewithal to run that program using a modified version of the Library.

The precise terms and conditions for copying, distribution and modification follow. Pay close attention to the difference between a "work based on the library" and a "work that uses the library". The former contains code derived from the library, whereas the latter must be combined with the library in order to run.



## TERMS AND CONDITIONS FOR COPYING, DISTRIBUTION AND MODIFICATION

0. This License Agreement applies to any software library or other program which contains a notice placed by the copyright holder or other authorized party saying it may be distributed under the terms of this Lesser General Public License (also called "this License"). Each licensee is addressed as "you". A "library" means a collection of software functions and/or data prepared so as to be conveniently linked with application programs (which use some of those functions and data) to form executables.

The "Library", below, refers to any such software library or work which has been distributed under these terms. A "work based on the Library" means either the Library or any derivative work under copyright law; that is to say, a work containing the Library or a portion of it, either verbatim or with modifications and/or translated straightforwardly into another language. (Hereinafter, translation is included without limitation in the term "modification".)

"Source code" for a work means the preferred form of the work for making modifications to it. For a library, complete source code means all the source code for all modules it contains, plus any associated interface definition files, plus the scripts used to control compilation and installation of the library.

Activities other than copying, distribution and modification are not covered by this License; they are outside its scope. The act of running a program using the Library is not restricted, and output from such a program is covered only if its contents constitute a work based on the Library (independent of the use of the Library in a tool for writing it). Whether that is true depends on what the Library does and what the program that uses the Library does.

1. You may copy and distribute verbatim copies of the Library's complete source code as you receive it, in any medium, provided that you conspicuously and appropriately publish on each copy an appropriate copyright notice and disclaimer of warranty; keep intact all the notices that refer to this License and to the absence of any warranty; and distribute a copy of this License along with the Library.

You may charge a fee for the physical act of transferring a copy, and you may at your option offer warranty protection in exchange for a fee.

2. You may modify your copy or copies of the Library or any portion of it, thus forming a work based on the Library, and copy and distribute such modifications or work under the terms of Section 1 above, provided that you also meet all of these conditions:

- The modified work must itself be a software library.
- You must cause the files modified to carry prominent notices stating that you changed the files and the date of any change.
- You must cause the whole of the work to be licensed at no charge to all third parties under the terms of this License.
- If a facility in the modified Library refers to a function or a table of data to be supplied by an application program that uses the facility, other than as an argument passed when the facility is invoked, then you must make a good faith effort to ensure that, in the event an application does not supply such function or table, the facility still operates, and performs whatever part of its purpose remains meaningful. (For example, a function in a library to compute square roots has a purpose that is entirely well-defined independent of the application. Therefore, Subsection 2d requires that any application-supplied function or table used by this function must be optional: if the application does not supply it, the square root function must still compute square roots.)

These requirements apply to the modified work as a whole. If identifiable sections of that work are not derived from the Library, and can be reasonably considered independent and separate works in themselves, then this License, and its terms, do not apply to those sections when you distribute them as separate works. But when you distribute the same sections as part of a whole which is a work based on the Library, the distribution of the whole must be on the terms of this License, whose permissions for other licensees extend to the entire whole, and thus to each and every part regardless of who wrote it.

Thus, it is not the intent of this section to claim rights or contest your rights to work written entirely by you; rather, the intent is to exercise the right to control the distribution of derivative or collective works based on the Library.

In addition, mere aggregation of another work not based on the Library with the Library (or with a work based on the Library) on a volume of a storage or distribution medium does not bring the other work under the scope of this License.

3. You may opt to apply the terms of the ordinary GNU General Public License instead of this License to a given copy of the Library. To do this, you must alter all the notices that refer to this License, so that they refer to the ordinary GNU General Public License, version 2, instead of to this License. (If a newer version than version 2 of the ordinary GNU General Public License has appeared, then you can specify that version instead if you wish.) Do not make any other change in these notices. Once this change is made in a given copy, it is irreversible for that copy, so the ordinary GNU General Public License applies to all subsequent copies and derivative works made from that copy. This option is useful when you wish to copy part of the code of the Library into a program that is not a library.

4. You may copy and distribute the Library (or a portion or derivative of it, under Section 2) in object code or executable form under the terms of Sections 1 and 2 above provided that you accompany it with the complete corresponding machine-readable source code, which must be distributed under the terms of Sections 1 and 2 above on a medium customarily used for software interchange.

If distribution of object code is made by offering access to copy from a designated place, then offering equivalent access to copy the source code from the same place satisfies the requirement to distribute the source code, even though third parties are not compelled to copy the source along with the object code.

5. A program that contains no derivative of any portion of the Library, but is designed to work with the Library by being compiled or linked with it, is called a "work that uses the Library". Such a work, in isolation, is not a derivative work of the Library, and therefore falls outside the scope of this License.

However, linking a "work that uses the Library" with the Library creates an executable that is a derivative of the Library (because it contains portions of the Library), rather than a "work that uses the library". The executable is therefore covered by this License. Section 6 states terms for distribution of such executables.

When a "work that uses the Library" uses material from a header file that is part of the Library, the object code for the work may be a derivative work of the Library even though the source code is not. Whether this is true is especially significant if the work can be linked without the Library, or if the work is itself a library. The threshold for this to be true is not precisely defined by law.

If such an object file uses only numerical parameters, data structure layouts and accessors, and small macros and small inline functions (ten lines or less in length), then the use of the object file is unrestricted, regardless of whether it is legally a derivative work. (Executables containing this object code plus portions of the Library will still fall under Section 6.)

Otherwise, if the work is a derivative of the Library, you may distribute the object code for the work under the terms of Section 6. Any executables containing that work also fall under Section 6, whether or not they are linked directly with the Library itself.

6. As an exception to the Sections above, you may also combine or link a "work that uses the Library" with the Library to produce a work containing portions of the Library, and distribute that work under terms of your choice, provided that the terms permit modification of the work for the customer's own use and reverse engineering for debugging such modifications.

You must give prominent notice with each copy of the work that the Library is used in it and that the Library and its use are covered by this License. You must supply a copy of this License. If the work during execution displays copyright notices, you must include the copyright notice for the Library among them, as well as a reference directing the user to the copy of this License. Also, you must do one of these things:

- Accompany the work with the complete corresponding machine-readable source code for the Library including whatever changes were used in the work (which must be distributed under Sections 1 and 2 above); and, if the work is an executable linked with the Library, with the complete machine-readable "work that uses the Library", as object code and/or source code, so that the user can modify the Library and then relink to produce a modified executable containing the modified Library. (It is understood that the user who changes the contents of definitions files in the Library will not necessarily be able to recompile the application to use the modified definitions.)
- Use a suitable shared library mechanism for linking with the Library. A suitable mechanism is one that (1) uses at run time a copy of the library already present on the user's computer system, rather than copying library functions into the executable, and (2) will operate properly with a modified version of the library, if the user installs one, as long as the modified version is interface-compatible with the version that the work was made with.
- Accompany the work with a written offer, valid for at least three years, to give the same user the materials specified in Subsection 6a, above, for a charge no more than the cost of performing this distribution.
- If distribution of the work is made by offering access to copy from a designated place, offer equivalent access to copy the above specified materials from the same place.
- Verify that the user has already received a copy of these materials or that you have already sent this user a copy.

For an executable, the required form of the "work that uses the Library" must include any data and utility programs needed for reproducing the executable from it. However, as a special exception, the materials to be distributed need not include anything that is normally distributed (in either source or binary form) with the major components (compiler, kernel, and so on) of the operating system on which the executable runs, unless that component itself accompanies the executable.

It may happen that this requirement contradicts the license restrictions of other proprietary libraries that do not normally accompany the operating system. Such a contradiction means you cannot use both them and the Library together in an executable that you distribute.

7. You may place library facilities that are a work based on the Library side-by-side in a single library together with other library facilities not covered by this License, and distribute such a combined library, provided that the separate distribution of the work based on the Library and of the other library facilities is otherwise permitted, and provided that you do these two things:
  - a) Accompany the combined library with a copy of the same work based on the Library, uncombined with any other library facilities. This must be distributed under the terms of the Sections above.
  - b) Give prominent notice with the combined library of the fact that part of it is a work based on the Library, and explaining where to find the accompanying uncombined form of the same work.
8. You may not copy, modify, sublicense, link with, or distribute the Library except as expressly provided under this License. Any attempt otherwise to copy, modify, sublicense, link with, or distribute the Library is void, and will automatically terminate your rights under this License. However, parties who have received copies, or rights, from you under this License will not have their licenses terminated so long as such parties remain in full compliance.
9. You are not required to accept this License, since you have not signed it. However, nothing else grants you permission to modify or distribute the Library or its derivative works. These actions are prohibited by law if you do not accept this License. Therefore, by modifying or distributing the Library (or any work based on the Library), you indicate your acceptance of this License to do so, and all its terms and conditions for copying, distributing or modifying the Library or works based on it.
10. Each time you redistribute the Library (or any work based on the Library), the recipient automatically receives a license from the original licensor to copy, distribute, link with or modify the Library subject to these terms and conditions. You may not impose any further restrictions on the recipients' exercise of the rights granted herein. You are not responsible for enforcing compliance by third parties with this License.
11. If, as a consequence of a court judgment or allegation of patent infringement or for any other reason (not limited to patent issues), conditions are imposed on you (whether by court order, agreement or otherwise) that contradict the conditions of this License, they do not excuse you from the conditions of this License. If you cannot distribute so as to satisfy simultaneously your obligations under this License and any other pertinent obligations, then as a consequence you may not distribute the Library at all. For example, if a patent license would not permit royalty-free redistribution of the Library by all those who receive copies directly or indirectly through you, then the only way you could satisfy both it and this License would be to refrain entirely from distribution of the Library. If any portion of this section is held invalid or unenforceable under any particular circumstance, the balance of the section is intended to apply, and the section as a whole is intended to apply in other circumstances.

It is not the purpose of this section to induce you to infringe any patents or other property right claims or to contest validity of any such claims; this section has the sole purpose of protecting the integrity of the free software distribution system which is implemented by public license practices. Many people have made generous contributions to the wide range of software distributed through that system in reliance on consistent application of that system; it is up to the author donor to decide if he or she is willing to distribute software through any other system and a licensee cannot impose that choice.

This section is intended to make thoroughly clear what is believed to be a consequence of the rest of this License.

12. If the distribution and/or use of the Library is restricted in certain countries either by patents or by copyrighted interfaces, the original copyright holder who places the Library under this License may add an explicit geographical distribution limitation excluding those countries, so that distribution is permitted only in or among countries not thus excluded. In such case, this License incorporates the limitation as if written in the body of this License.
13. The Free Software Foundation may publish revised and/or new versions of the Lesser General Public License from time to time. Such new versions will be similar in spirit to the present version, but may differ in detail to address new problems or concerns. Each version is given a distinguishing version number. If the Library specifies a version number of this License which applies to it and "any later version", you have the option of following the terms and conditions either of that version or of any later version published by the Free Software Foundation. If the Library does not specify a license version number, you may choose any version ever published by the Free Software Foundation.
14. If you wish to incorporate parts of the Library into other free programs whose distribution conditions are incompatible with these, write to the author to ask for permission. For software which is copyrighted by the Free Software Foundation, write to the Free Software Foundation; we sometimes make exceptions for this. Our decision will be guided by the two goals of preserving the free status of all derivatives of our free software and of promoting the sharing and reuse of software generally.

#### NO WARRANTY

15. BECAUSE THE LIBRARY IS LICENSED FREE OF CHARGE, THERE IS NO WARRANTY FOR THE LIBRARY, TO THE EXTENT PERMITTED BY APPLICABLE LAW. EXCEPT WHEN OTHERWISE STATED IN WRITING THE COPYRIGHT HOLDERS AND/OR OTHER PARTIES PROVIDE THE LIBRARY "AS IS" WITHOUT WARRANTY OF ANY KIND, EITHER EXPRESSED OR IMPLIED, INCLUDING, BUT NOT LIMITED TO, THE IMPLIED WARRANTIES OF MERCHANTABILITY AND FITNESS FOR A PARTICULAR PURPOSE. THE ENTIRE RISK AS TO THE QUALITY AND PERFORMANCE OF THE LIBRARY IS WITH YOU. SHOULD THE LIBRARY PROVE DEFECTIVE, YOU ASSUME THE COST OF ALL NECESSARY SERVICING, REPAIR OR CORRECTION.
16. IN NO EVENT UNLESS REQUIRED BY APPLICABLE LAW OR AGREED TO IN WRITING WILL ANY COPYRIGHT HOLDER, OR ANY OTHER PARTY WHO MAY MODIFY AND/OR REDISTRIBUTE THE LIBRARY AS PERMITTED ABOVE, BE LIABLE TO YOU FOR DAMAGES, INCLUDING ANY GENERAL, SPECIAL, INCIDENTAL OR CONSEQUENTIAL DAMAGES ARISING OUT OF THE USE OR INABILITY TO USE THE LIBRARY (INCLUDING BUT NOT LIMITED TO LOSS OF DATA OR DATA BEING RENDERED INACCURATE OR LOSSES SUSTAINED BY YOU OR THIRD PARTIES OR A FAILURE OF THE LIBRARY TO OPERATE WITH ANY OTHER SOFTWARE), EVEN IF SUCH HOLDER OR OTHER PARTY HAS BEEN ADVISED OF THE POSSIBILITY OF SUCH DAMAGES.

#### END OF TERMS AND CONDITIONS

##### How to Apply These Terms to Your New Libraries

If you develop a new library, and you want it to be of the greatest possible use to the public, we recommend making it free software that everyone can redistribute and change. You can do so by permitting redistribution under these terms (or, alternatively, under the terms of the ordinary General Public License).

To apply these terms, attach the following notices to the library. It is safest to attach them to the start of each source file to most effectively convey the exclusion of warranty; and each file should have at least the "copyright" line and a pointer to where the full notice is found.

<one line to give the library's name and a brief idea of what it does.>

Copyright © <year> <name of author>

This library is free software; you can redistribute it and/or modify it under the terms of the GNU Lesser General Public License as published by the Free Software Foundation; either version 2.1 of the License, or (at your option) any later version.

This library is distributed in the hope that it will be useful, but WITHOUT ANY WARRANTY; without even the implied warranty of MERCHANTABILITY or FITNESS FOR A PARTICULAR PURPOSE. See the GNU Lesser General Public License for more details.

You should have received a copy of the GNU Lesser General Public License along with this library; if not, write to the Free Software Foundation, Inc., 51 Franklin Street, Fifth Floor, Boston, MA 02110-1301 USA

Also add information on how to contact you by electronic and paper mail.

You should also get your employer (if you work as a programmer) or your school, if any, to sign a "copyright disclaimer" for the library, if necessary. Here is a sample; alter the names:

Yoyodyne, Inc., hereby disclaims all copyright interest in the library 'Frob' (a library for tweaking knobs) written by James Random Hacker.

<signature of Ty Coon>, 1 April 1990

Ty Coon, President of Vice

That's all there is to it!

## **[Notice on GNU General Public License]**

This product include the software licensed for use under the terms of a GNU General Public License. A copy of the corresponding source code can be obtained by being charged the fee for distribution.

To obtain a copy, contact your local Pioneer Customer Support Center.

See the GNU website (<http://www.gnu.org>) for details of the GNU General Public License.



Should this product require service in the U.S.A. and you wish to locate the nearest Pioneer Authorized Independent Service Company, or if you wish to purchase replacement parts, operating instructions, service manuals, or accessories, please call the number shown below.

1-800-421-1404

Please do not ship your product to Pioneer without first calling the Customer Support at the above listed number for assistance.

Pioneer Electronics Service, Inc.  
P.O. BOX 1760, Long Beach,  
CA 90801-1760, U.S.A.

For warranty information please see the Limited Warranty sheet included with your product.

Should this product require service in Canada, please contact a Pioneer Canadian Authorized Dealer to locate the nearest Pioneer Authorized Service Company in Canada. Alternatively, please contact the Customer Satisfaction Department at the following address:

Pioneer Electronics of Canada, Inc.  
Customer Satisfaction Department  
300 Allstate Parkway, Markham, Ontario L3R 0P2  
1-877-283-5901  
905-479-4411

For warranty information please see the Limited Warranty sheet included with your product.

Si ce produit doit être réparé au Canada, veuillez vous adresser à un distributeur autorisé Pioneer du Canada pour obtenir le nom du Centre de Service Autorisé Pioneer le plus près de chez-vous. Vous pouvez aussi contacter le Service à la clientèle de Pioneer:

Pioneer Électroniques du Canada, Inc.  
Service Clientèle  
300, Allstate Parkway, Markham, Ontario L3R 0P2  
1-877-283-5901  
905-479-4411

Pour obtenir des renseignements sur la garantie, veuillez vous reporter au feuillet sur la garantie restreinte qui accompagne le produit.

S018\_C\_EF

Register Your Product on

<http://www.pioneerelectronics.com> (US)

<http://www.pioneerelectronics.ca> (Canada)

#### **PIONEER CORPORATION**

4-1, Meguro 1-Chome, Meguro-ku, Tokyo 153-8654, Japan

#### **PIONEER ELECTRONICS (USA) INC.**

P.O. BOX 1540, Long Beach, California 90801-1540, U.S.A. TEL: (800) 421-1404

#### **PIONEER ELECTRONICS OF CANADA, INC.**

300 Allstate Parkway, Markham, Ontario L3R 0P2, Canada TEL: 1-877-283-5901, 905-479-4411

#### **PIONEER EUROPE NV**

Haven 1087, Keetberglaan 1, B-9120 Melsele, Belgium TEL: 03/570.05.11

#### **PIONEER ELECTRONICS ASIACENTRE PTE. LTD.**

253 Alexandra Road, #04-01, Singapore 159936 TEL: 65-6472-7555

#### **PIONEER ELECTRONICS AUSTRALIA PTY. LTD.**

178-184 Boundary Road, Braeside, Victoria 3195, Australia, TEL: (03) 9586-6300

#### **PIONEER ELECTRONICS DE MEXICO S.A. DE C.V.**

Blvd.Manuel Avila Camacho 138 10 piso Col.Lomas de Chapultepec, Mexico,D.F. 11000 TEL: 55-9178-4270

K002\_B\_En

Published by Pioneer Corporation.

Copyright © 2008 Pioneer Corporation.

All rights reserved.

## Free Manuals Download Website

<http://myh66.com>

<http://usermanuals.us>

<http://www.somanuals.com>

<http://www.4manuals.cc>

<http://www.manual-lib.com>

<http://www.404manual.com>

<http://www.luxmanual.com>

<http://aubethermostatmanual.com>

Golf course search by state

<http://golfingnear.com>

Email search by domain

<http://emailbydomain.com>

Auto manuals search

<http://auto.somanuals.com>

TV manuals search

<http://tv.somanuals.com>