

Pioneer

CAR ENTERTAINMENT 2009

A u d i o & A V

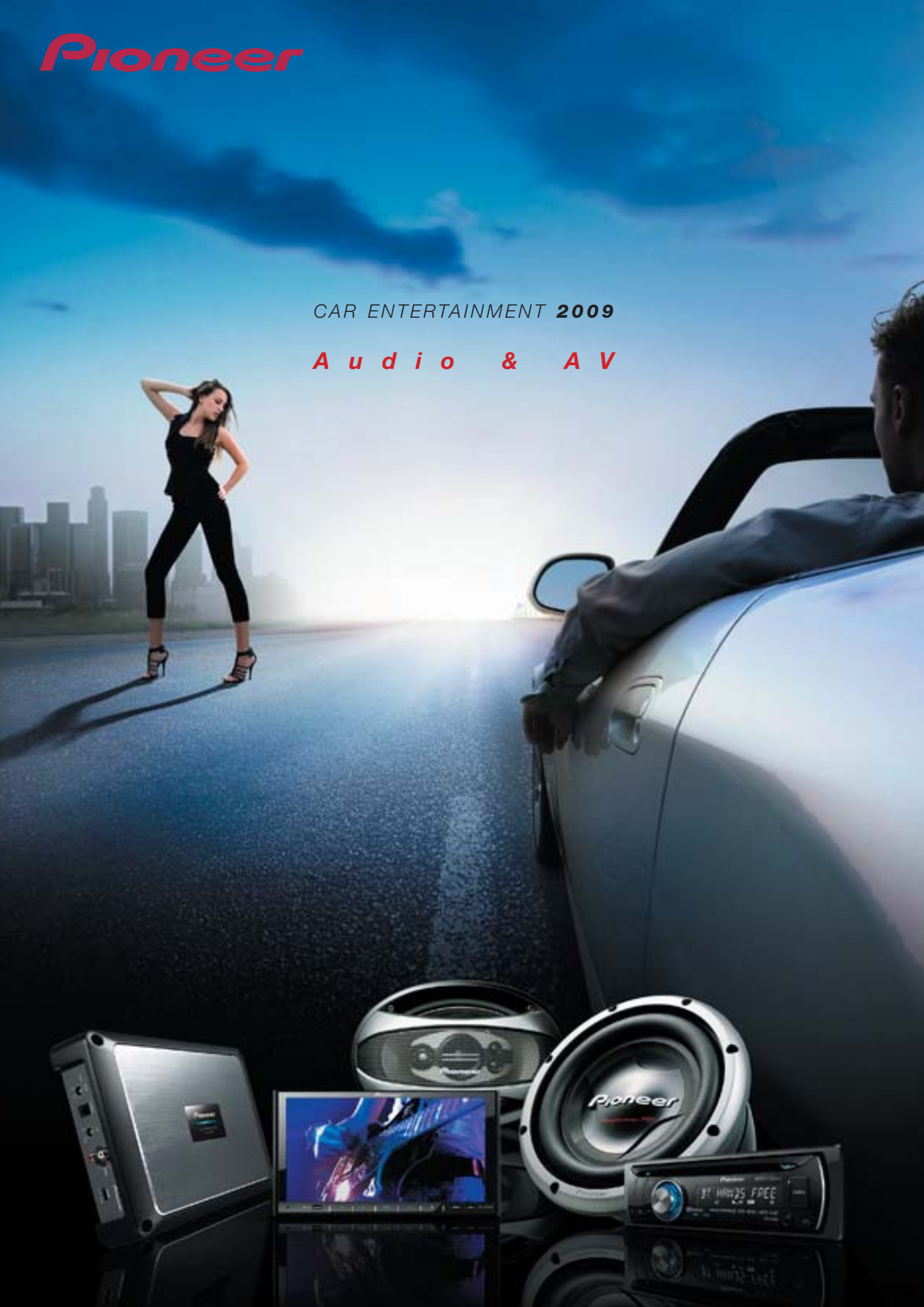

ALL SENSATIONS, NO SEAMS

What should all great audio sound systems share in common? Seamless hookups for portable digital devices to access more of your favorite entertainment in a wider variety of media formats. Just bring along a pocket-sized player. Plug into a Pioneer car headunit's power to rock your world. Break every barrier that ever kept you from enjoying your music as you like. With such sensational command within easy reach, there's no limit to how far you can go.

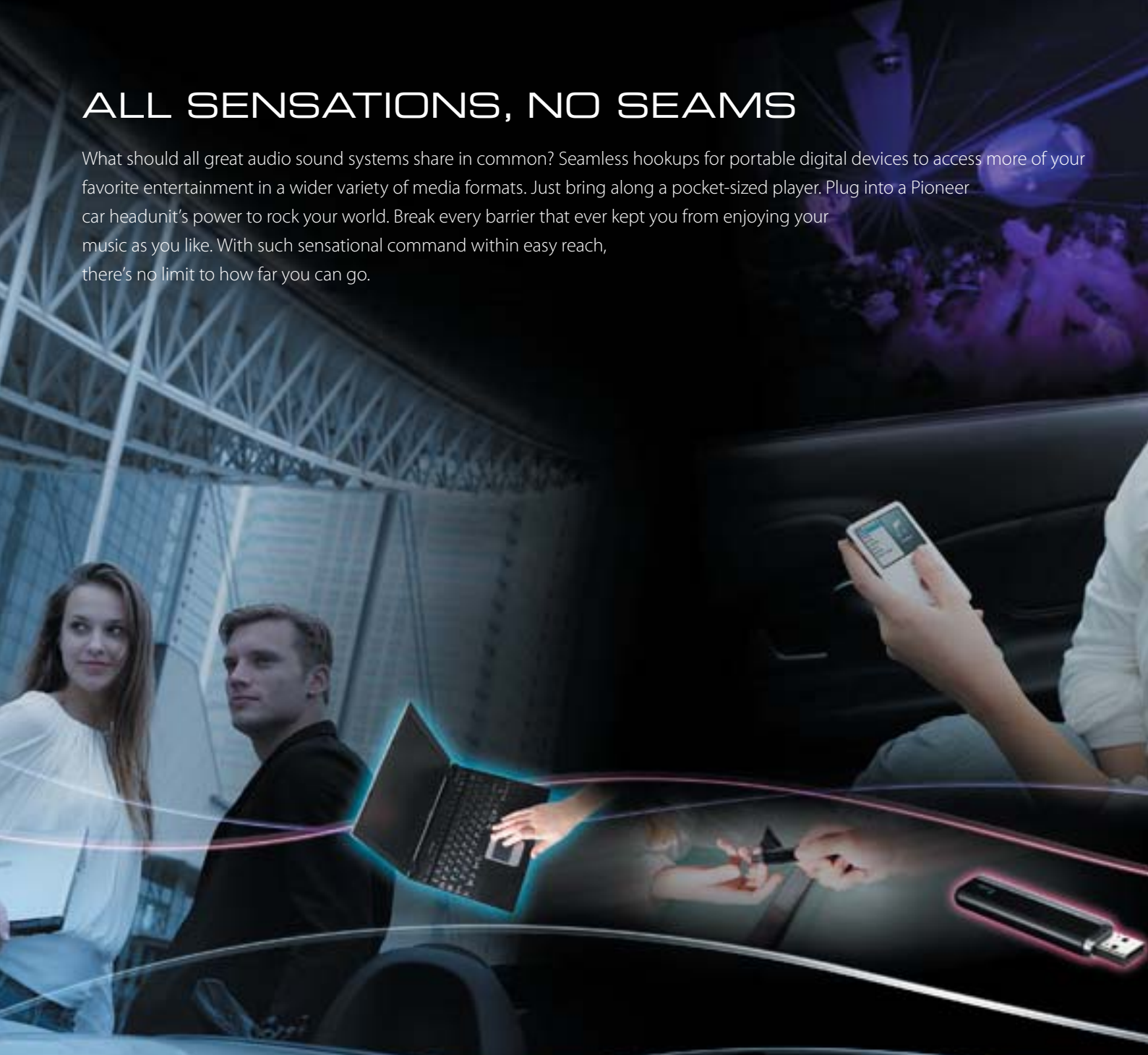

AV Systems

Audio Headunits
& Accessories

ODR & Pure
Component Systems



4-19



20-31



32-39



 Amplifiers & Subwoofers

 Speakers

 Comparison & Specifications



40-49



50-57



58-63

MORE MEDIA, MORE DIRECT

Simplicity is a key to superior control. Just swipe a finger to fast-forward or rewind movie or music playback with Touch Slide. Direct connections between our headunits and iPod, iPhone, USB devices and portable media players are fast and easy. 112 key illumination colors even give you a great choice of ways to personalize the display.



AVH-P4150DVD
7" Wide Display 2-DIN AV with USB Direct Connection

AVH-P5150DVD
7" Wide Display 1-DIN AV with USB Direct Connection

COMMAND MORE DISPLAY COLORS

Selectable Screen Color & RGB Key Illumination

- AVH-P5150DVD
- AVH-P4150DVD
- AVH-P3150DVD

Select among five color themes for the display and 112 colors for key panel illumination to seamlessly match your unit to your dash.

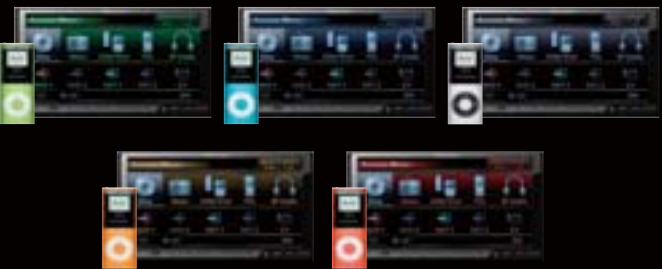

A TOUCH OF SUPERIOR SIMPLICITY

Touch Slide Operation

- AVH-P4150DVD
- AVH-P3150DVD

With new Touch Slide Operation, just swipe your finger on the touch panel to fast-forward or rewind movie and music playback. The GUI (Graphic User Interface) on a wide color LCD makes file access and playback from DVD, CD, iPod or other digital device very easy, in keeping with the convenience of direct touch panel operation.





AVH-P3150DVD
5.8" Wide Display 2-DIN AV with
Front USB Direct Connection

VERSATILE PERFORMANCE

▶ Multiple Media Connectivity

Connect a Pioneer AV headunit to an iPod via USB, for direct control of audio and video menus, functions and selections via headunit's touch-panel display similar to iPod. This not only speeds up and simplifies file search and access—it paves the way to enjoy higher-quality sound via USB digital data transfer. Also, a built-in AUX-in mini jack makes it convenient to connect a Pioneer AV headunit to an external iPod Audio, iPod Video, MP4 player, digital camera or other portable audio/video media player.



▶ DivX® Playback

- AVH-P7950DVD
- AVH-P5150DVD
- AVH-P4150DVD
- AVH-P3150DVD
- DVH-P4150UB
- DVH-3150UB



DivX® is the world's most popular high-compression digital video format and does not appreciably compromise movie picture quality. Simply burn a movie from a PC onto a long-playing Video CD or DVD, then play that disc in a Pioneer AV headunit to gain a new appreciation of in-car theater.

▶ Advanced Sound Retriever

- AVH-P4150DVD
- AVH-P3150DVD
- DVH-P4150UB
- DVH-3150UB

Pioneer AV headunits use advanced sound retrieval to access high-quality audio from compressed file formats.

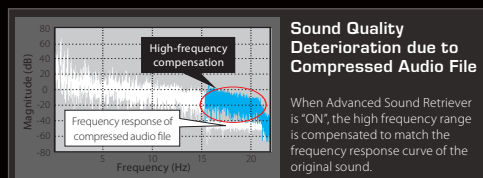

Sound Quality Deterioration due to Compressed Audio File

When Advanced Sound Retriever is "ON", the high frequency range is compensated to match the frequency response curve of the original sound.





► Selectable Screen Color & RGB Key Illumination

AVH-P5150DVD AVH-P4150DVD AVH-P3150DVD

The AVH-P5150DVD, AVH-P4150DVD and AVH-P3150DVD let you select among five screen colors, according to your preference and color scheme. These headunits also feature 112 key illumination colors for even more ways to match car interior and dashboard lighting.



AVH-P5150DVD 7" (16:9) Wide QVGA Fully Motorized LCD Color Display with 4-Channel High-Power DVD/VCD/CD Receiver and USB Direct Connection

NEW



- Direct connection for iPod (audio & video) (CD-IU205V required)
- DivX®/MP3/WMA/AAC playback on DVD and CD
- USB direct connection: USB 2.0 (full speed)
- Bluetooth® adapter ready
- Built-in MPEG-1/2 decoder
- Built-in decoder (Dolby Digital, Linear PCM)
- 96 kHz/24-bit DAC (for audio)
- 10-bit video DAC
- EQ
 - 5-mode preset equalizer
 - 1-mode custom preset equalizer
 - 3-band parametric equalizer
 - Bass Boost
 - 2-way crossover (HPF/LPF)
 - 3-mode selectable loudness
- IP-Bus input
- 2 RCA pre-outs: front + rear/subwoofer (selectable)
- A/V inputs and outputs
 - 1 RCA Audio/Video input
 - 1 RCA Video output

- Multi-channel processor (DEQ-P7650) control (CD-DD25 required)
- External unit control via IP-Bus (2 units)
- AUX-in by mini jack (audio & video)
- RGB key illumination (112 colors)

- LCD MONITOR**
- 7" (16:9) QVGA wide TFT active matrix LCD color screen
 - Selectable screen color (Blue/Red/Amber/Green/Violet)
 - AG (Anti-Glare) coated LCD color screen
 - Automatic rear view monitoring in reverse gear (by camera*)
- *Camera not included



Direct Connection for iPod and iPhone Adds Convenience to AV Control



Connect your iPod to the AVH-P5150DVD for direct control of iPod audio and video menus, functions, and selections via on-screen touch panel. This makes song access and search extra-quick and easy.

Similarly, the AVH-P4150DVD, AVH-P3150DVD and DVH-P4150UB can be connected to an iPhone.

*Does not apply to iPhone.



CD-IU205V
Interface Cable for AVH-P5150DVD with iPod

NEW

Made for iPod

AVH-P5150DVD

*Please see page 30 for details about iPod compatibility with Pioneer headunits.

CD-IU205V*

Composite image shown in iPod display

iPod

Advanced Sound Retriever



Hear the glory of original sound across a deeper, wider spectrum from highly compressed MP3, WMA and AAC files stored on USB device, iPod and portable media players. By compensating for data (especially higher frequencies) that tend to get lost in the digital compression process, Pioneer's Advanced Sound Retriever technology enhances audio reproduction nearly all the way up to 20 kHz frequencies. We can make your music sound close to CD quality.

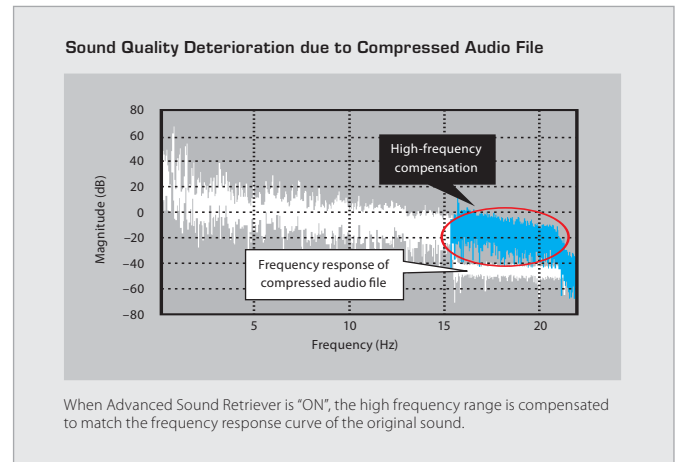

Wide LCD Color Display with Touch Panel Operation

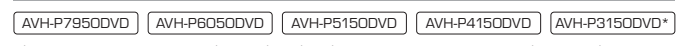

The AVH-P5150DVD reproduces clear, bright DVD images on its 7-inch LCD color display. AG (Anti-Glare) screen coating prevents external light diffusion from impeding visibility. Settings, source access and playback via touch panel with GUI (Graphic User Interface) makes operation effortless.

*5.8-inch wide.

DivX® Playback



Create a DivX® movie on a PC, burn it to a disc, and play it in-car. Pioneer's AV headunits can play DivX® video files from CDs and DVDs. The world's most popular compressed digital video format, DivX® delivers speedy transfer without appreciably compromising picture quality.



▶ Selectable Screen Color & RGB Key Illumination

AVH-P5150DVD AVH-P4150DVD AVH-P3150DVD

The AVH-P4150DVD will accommodate your taste or mood. Select among five (Blue/Red/Amber/Green/White) colors for display, and among 112 key illumination colors to match car interior, iPod and dashboard lighting.



AVH-P4150DVD

7" (16:9) Wide QVGA Fully Motorized LCD Color Display with 4-Channel High-Power DVD/VCD/CD Receiver and USB Direct Connection

NEW



- Direct connection for iPod and iPhone (audio & video) (CD-IU200V required)
- DivX*/MP3/WMA/AAC playback on DVD and CD
- JPEG on CD-R/RW and USB
- USB direct connection: USB 2.0 (full speed)
- Bluetooth* adapter ready
- Built-in MPEG-1/2 decoder
- Built-in decoder (Dolby Digital, Linear PCM)
- 96 kHz/24-bit DAC (for audio)
- 10-bit video DAC
- Advanced Sound Retriever
- EEQ
- 5-mode preset equalizer

- 1-mode custom preset equalizer
 - 3-band parametric equalizer
 - Bass Boost
 - 2-way crossover (HPF/LPF)
 - 3-mode selectable loudness
 - IP-Bus input
 - 3 RCA pre-outs (front + rear + subwoofer)
 - A/V inputs and outputs
 - 1 RCA Audio/Video input
 - 1 RCA Video output
 - RGB input (26-pin)
 - Multi-channel processor (DEQ-P7650) control (CD-DD25 required)
 - External unit control via IP-Bus (2 units)
 - AUX-in by mini jack (audio & video)
 - RGB key illumination (112 colors)
- LCD MONITOR**
- 7" (16:9) QVGA wide TFT active matrix LCD color screen
 - AG (Anti-Glare) coated LCD color screen
 - Touch slide operation
 - Selectable screen color (Blue/Red/Amber/Green/White)
 - Built-in GDC (Graphics Display Controller)
 - Customizable wallpapers
 - LED backlight
 - Automatic rear view monitoring in reverse gear (by camera*)
- * Camera not included

▶ Touch Slide Operation

AVH-P4150DVD | AVH-P3150DVD

With a smooth swipe of your finger on the touch panel display, you can fast forward/rewind AV content playing from DVD-Video, DivX*, MP3/WMA/AAC and CD source formats, or scroll a list of files for you to select among.

Note: Touch slide Fast-Forward/Rewind function not available on iPod.



▶ Customizable Wallpapers

AVH-P4150DVD | AVH-P3150DVD

Choose among 4 types of BGP (Background Picture) and 3 types of BGV (Background Visual). You can even set your favorite JPEG file as wallpaper. Parked with no place to go? Now you can enjoy a slideshow of your photos on a CD or USB Device.



▶ Link Play for iPod

AVH-P5150DVD* | AVH-P4150DVD | AVH-P3150DVD | DVH-P4150UB

Not in the mood for all of the kinds of music that shuffle mode can play from your iPod library? Then here's a great way to listen only to your favorite kinds. Just plug your iPod directly into the unit using the optional cable, touch the Link Play button and select specific artist, album or genre. Now, you are ready to rock and roll.

*Artist only



- Jump to another album of the same artist.
- Jump to another title that hasn't recently been played from the same album.
- Jump to other music that you haven't heard in a while from the same genre.

▶ Speedier Search Using iPod and iPhone

AVH-P4150DVD | AVH-P3150DVD | DVH-P4150UB

Now, Pioneer's latest headunits are even easier to enjoy with an iPod. A new USB mechanism speeds up "List Search", refined processing speeds up "Alphabetical Search" for song, artist name, or album, and "Touch Slide Operation" speeds up access to any file in the connected iPod.





112 COLORS
RGB key illumination

AVH-P3150DVD 5.8" (16:9) Wide QVGA LCD Color Display with 4-Channel High-Power DVD/VCD/CD Receiver and USB Direct Connection

NEW



- Direct connection for iPod and iPhone (audio & video) (CD-IU50V required)
- DivX*/MP3/WMA/AAC playback on DVD and CD
- JPEG on CD-R/RW and USB
- Front USB direct connection: USB 2.0 (full speed)
- Bluetooth® adapter ready
- Built-in MPEG-1/2 decoder
- Built-in decoder (Dolby Digital, Linear PCM)
- 96 kHz/24-bit DAC (for audio)

- 10-bit video DAC
- Advanced Sound Retriever
- EEQ
 - 5-mode preset equalizer
 - 1-mode custom preset equalizer
 - 3-band parametric equalizer
 - Bass Boost
 - 2-way crossover (HPF/LPF)
 - 3-mode selectable loudness
- IP-Bus input
- 2 RCA pre-outs: front + rear/subwoofer (selectable)
- A/V inputs and outputs
 - 1 RCA Audio/Video input
 - 1 RCA Video output
- Multi-channel processor (DEQ-P7650) control (CD-DD25 required)

- External unit control via IP-Bus (2 units)
 - AUX-in by mini jack (front for audio & video)
 - RGB key illumination (112 colors)
- LCD MONITOR**
- 5.8" (16:9) QVGA wide TFT active matrix LCD color screen
 - Touch slide operation
 - Selectable screen color (Blue/Red/Amber/Green/White)
 - AG (Anti-Glare) coated LCD color screen
 - Built-in GDC (Graphics Display Controller)
 - Customizable wallpapers
 - LED backlight
 - Automatic rear view monitoring in reverse gear (by camera*)
- *Camera not included

▶ Front AUX-In Mini Jack Connection for Audio and Video



AVH-P3150DVD DVH-P4150UB DVH-3150UB*

Pioneer's AV headunits' AUX-in mini jacks extend playback from external iPod Audio, iPod Video, MP4 player, digital camera and other portable audio/video media players. These jacks are built into the front panel for fast, trouble-free connection.

*Audio only



▶ Picture Quality Adjustment

AVH-P4150DVD AVH-P3150DVD

In addition to LED-backlight for brighter pictures, Black Level Adjustment displays deeper black that you'll appreciate when viewing movies. Color Temperature Adjustment allows you fine-tune color quality ensuring a crisper, clearer picture.





Metallic hairline finish front panel

AVH-P7950DVD 7" (16:9) Wide WVGA Fully Motorized LCD Color Display with 8-Channel High-Power DVD/VCD/CD Receiver

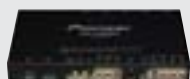

Hide-away unit
280 mm (W) x 37 mm (H) x
171 mm (D)

- DivX® file playback
- MP3/WMA/AAC playback on DVD and CD
- JPEG on CD-R
- USB adapter ready (external unit control)
- Adapter ready for iPod
- Bluetooth® adapter ready
- Dual illumination (white/red)
- Built-in MPEG-1/2 decoder

- Built-in decoder (DTS, DTS-ES, DTS Neo:6, DTS 96/24, Dolby Digital, Dolby Pro Logic II, Dolby Digital EX, Linear PCM)
- 192 kHz/24-bit DAC (for audio)
- 10-bit video DAC
- Built-in DSP (Digital Signal Processor)
 - 5-mode preset equalizer
 - 3-mode custom preset equalizer
 - 2-channel/multi-channel Auto EQ
 - Digital listening position selector

- 2-channel/multi-channel auto time alignment
- 13-band graphic equalizer (L/R independent/common)
- Multi-channel 3-band parametric equalizer (L/R independent/common)
- Front 2-way crossover: HPF/LPF
- Rotary volume
- Digital direct
- 6 wide screen modes (Just/Full/Cinema/Zoom/Normal/Auto)
- 9-channel RCA pre-outs
- External unit control via IP-Bus (2 units)
- Source DVD control (full-control)
- AUX-in by mini jack (audio)
- Detachable lower face
- Dual-zone (two different sources) operation for front and rear
- Optical digital input
- Joystick remote control
- 6 m cable between monitor and hide-away unit
- Multi-language guide—caution message only (English/Spanish/Portuguese/Traditional Chinese)

HIDE-AWAY UNIT

- A/V inputs and outputs
- AV-Bus input
- 2 RCA Audio/Video inputs (input 1: Audio/Video, input 2: Audio/Video or rear view camera)
- 1 RCA Audio/Video output
- 8-channel speaker output
- Component output (for rear screen)

LCD MONITOR

- 7" (16:9) WVGA wide TFT active matrix LCD color screen
- Sub-Display (10-character)
- AG (Anti-Glare) coated LCD color screen
- Intelligent dimmer control
- Virtual GUI (Graphic User Interface)
- Fully motorized unit with display angle adjustment
- New split-screen IC
- Built-in GDC (Graphics Display Controller)
- Automatic rear view monitoring in reverse gear (by camera*)

*Camera not included



▶ 2-Channel/Multi-Channel Selectable Auto Time Alignment and Auto EQ

AVH-P7950DVD

Like sound engineers, Pioneer applies Auto Time Alignment to customize the front sound stage and bring out vocal impact. After a microphone measures the time it takes for sound from each speaker to reach the listener, output timing is automatically adjusted and wave interference suppressed.

The microphone also helps to monitor in-car acoustics for multi-channel Auto EQ, and the information is used to automatically equalize frequency response curves. Such innovations deliver the best sound quality you can get in a car. You can even enjoy expansive 6.1- or 5.1-channel surround sound when listening to a DVD or 2-channel CD recording.

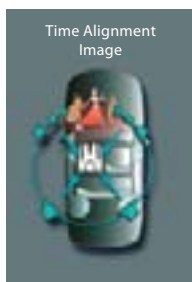

Digital delay processing makes all speakers sound as if they are virtually equidistant from the listener, for a clearer, front-focused soundstage.

▶ Built-In Multi-Channel Processor for 6.1-Channel Surround Sound

AVH-P7950DVD

The Pioneer AVH-P7950DVD enhances the experience of cinema in a car in several ways. Play 6.1-channel compatible audio/video DVDs or DTS Neo:6-compatible media to maximize the drama that a full 6.1-channel surround sound system can create. The audio effect from eight speakers (four front left and right, two rear left and right, one center, and one rear center plus an active subwoofer) is especially astounding from the perspectives of driver and front passenger. The overall sound is stable and natural, particularly in the dedicated subwoofer channel for low frequencies.

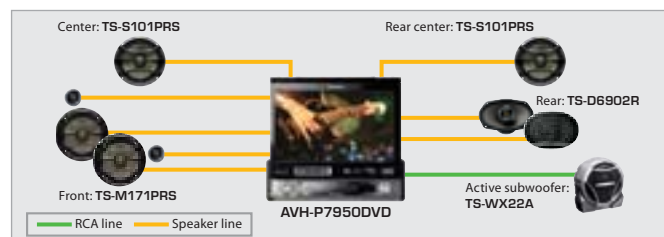

Display colors and graphics may differ in photographs from actual appearance.



AVH-P6050DVD 2-DIN 7" (16:9) Wide In-Dash Fully Motorized LCD Color Display with 4-Channel High-Power 6-Disc Multi-DVD/VCD/CD Receiver

Limited distribution



- USB adapter ready (external unit control)
- Adapter ready for iPod
- Bluetooth® adapter ready
- Built-in MPEG-1/2 decoder

- Built-in decoder (Dolby Digital, Linear PCM)
- 6-disc CD/DVD changer
- 96 kHz/24-bit DAC (for audio)
- 10-bit video DAC
- EEQ
 - 5-mode preset equalizer
 - 1-mode custom preset equalizer
 - 3-band parametric equalizer
 - EQ-EX
 - HPF
 - 3-mode selectable loudness
- 4-mode staging (Music Studio/Dynamic Theater/Actor's Stage/Relax Living)
- 5 wide screen modes (Just/Full/Cinema/Zoom/Normal)
- 3 RCA pre-outs (front + rear + subwoofer)
- IP-Bus input

- A/V inputs and outputs
 - Optical digital output (DTS, Linear PCM)
 - AV-Bus input
 - 2 RCA Audio/Video inputs (input 1: Audio/Video, input 2: Audio/Video or rear view camera)
 - 1 RCA Video output
- RGB input (26-pin)
- Multi-channel processor (DEQ-P7650) control
- External unit control via IP-Bus (2 units)
- AUX-in by mini jack (audio)
- Level indicator
- Spectrum analyzer
- Joystick remote control
- Multi-language guide—caution message only (English/Spanish/Portuguese/Traditional Chinese)

- LCD MONITOR
 - 7" wide TFT active matrix LCD color screen
 - AG (Anti-Glare) coated LCD color screen
 - Virtual GUI (Graphic User Interface)
 - Fully motorized unit with display angle adjustment (5 steps <STEP 0 to STEP 5>)
 - New split-screen IC
 - Built-in GDC (Graphics Display Controller)
 - Automatic rear view monitoring in reverse gear (by camera*)
- * Camera not included



7-Inch Wide In-Dash Monitor with Enhanced Touch Panel



AVH-P7950DVD AVH-P6050DVD AVH-P5150DVD AVH-P4150DVD

Gaining a greater touch of control over all your in-car entertainment now gets simpler. Whether it is playing a stack of DVDs, CDs, or a connected iPod or other portable media player, these models are more than a multimedia headunit—it is a multi-operational centerpiece engineered for more direct access to the new generation of in-car entertainment. Its brilliant 7-inch-wide in-dash monitor features easy-access smudge-resistant touch panel and external light-diffusing AG (Anti-Glare) screen coating. Every image emanating from the screen is bold, clear and sharp, yet easy on the eyes.

In all, it is visibly superior to what more conventional AV command centers have to offer in overall performance and style.

A Clear Touch Panel Makes Operation Easy

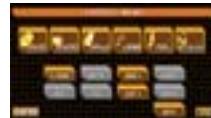

AVH-P5150DVD



AVH-P4150DVD



AVH-P6050DVD

In-Car Sound Staging

AVH-P6050DVD

Choose among four presets (Music Studio/Dynamic Theater/Actor's Stage/Relax Living) designed for you to listen to optimal advantage, according to the nature of your source material, acoustic environment and personal preference. Touch panel operation makes it extra-easy to select the right setting to stage your sound.

Screens For Four Sound Staging Presets (AVH-P6050DVD)



Music Studio



Dynamic Theater



Actor's Stage



Relax Living

6-Disc CD/DVD Changer

AVH-P6050DVD

Keep the music and movie entertainment rolling without interruption for as long as you like. The CD/DVD changer section holds up to six discs. Use the touch panel to select and sequence disc tracks for playback as desired. With the 7-inch wide monitor, confirming details and data is simplicity itself.

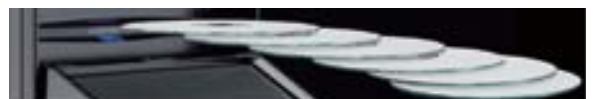

Display colors and graphics may differ in photographs from actual appearance.

CD-IU205V
NEW
 Interface Cable for AVH-P5150DVD with iPod

Made for iPod



CD-IU200V
NEW
 USB Interface Cable for AVH-P4150DVD with iPod/iPhone

Made for iPod

Works with iPhone



CD-IU50V
NEW
 USB Interface Cable for AVH-P3150DVD and DVH-P4150UB with iPod/iPhone

Made for iPod

Works with iPhone

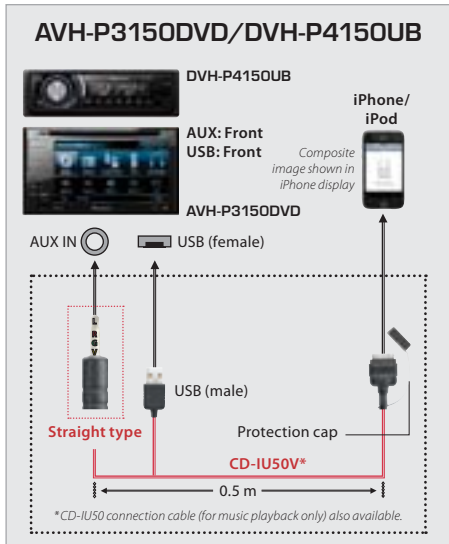
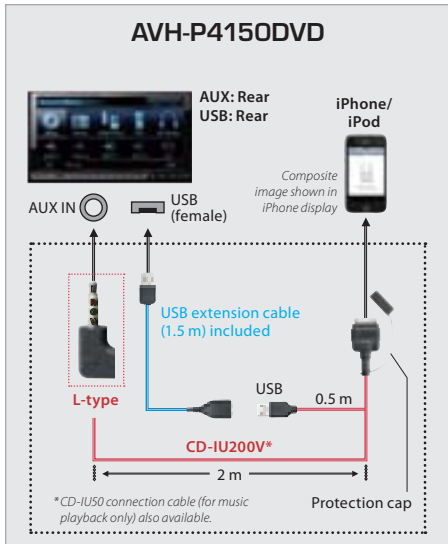
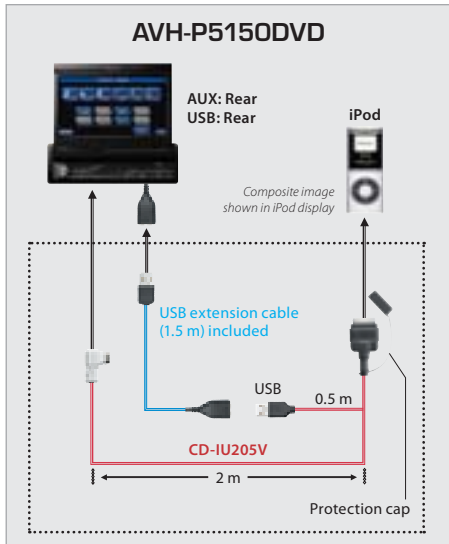
▶ View iPod Video Via Pioneer AV Headunits by Mini Jack

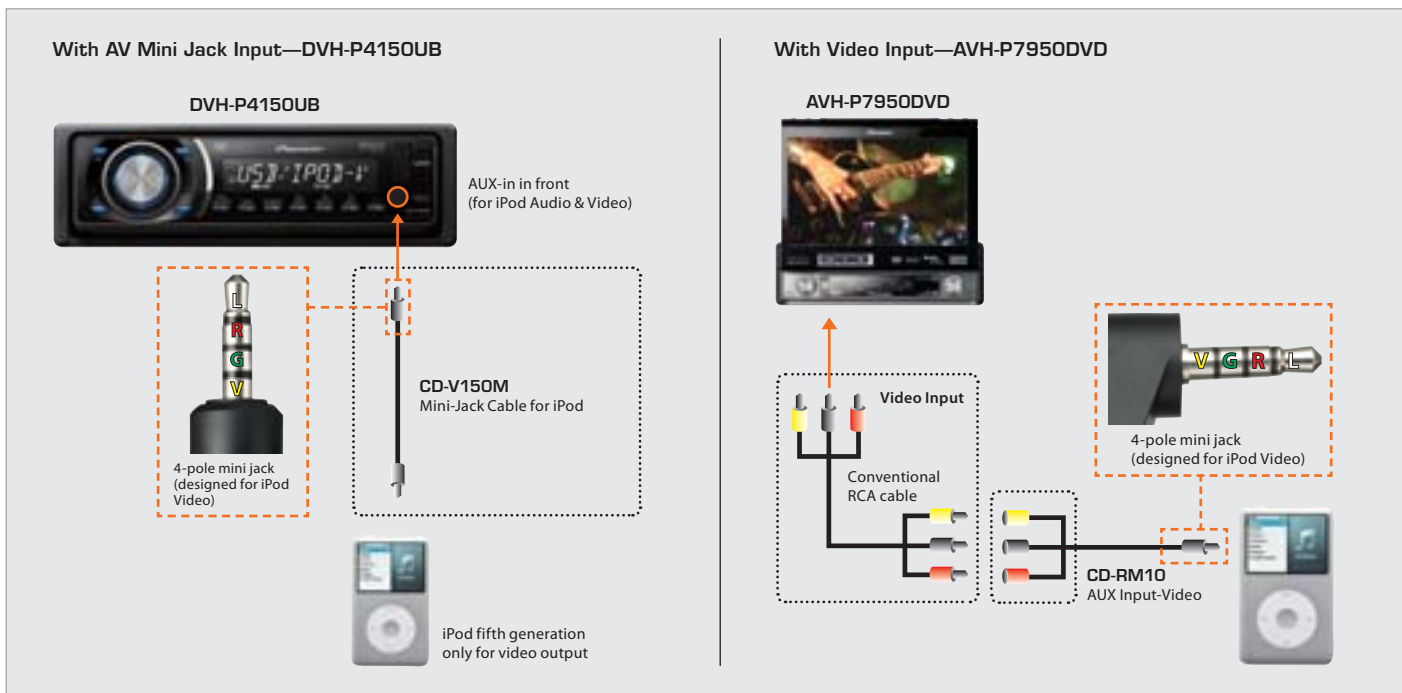

▶ Tips: iPod Video Setup

You will need to change the settings on both the iPod and headunit in order to use iPod Video.



1. iPod TV OUT setting must be "ON"

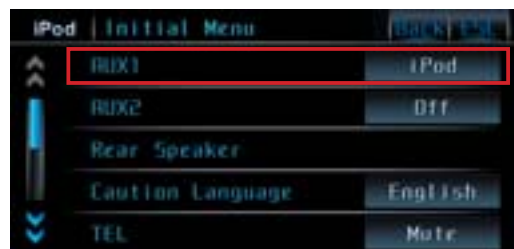

2. AUX 1 should be switched to "iPod" in the initial menu. The initial menu is available even if the source is off.

ENTERTAINMENT EXPANDS

You can choose among a greater range of audio/video content to play than discs alone can offer—thanks to a Pioneer 1-DIN DVD player's front built-in USB and AUX-in jacks for easy, direct connection to an iPod or other digital device.



DVH-P4150UB 4-Channel High-Power DVD/VCD/CD Receiver with USB Direct Connection

NEW



- Direct connection for iPod and iPhone (audio & video) (CD-IU50V required)
- DivX*/MP3/WMA/AAC playback on DVD and CD
- JPEG on CD-R/RW and USB
- Front USB direct connection: USB 2.0 (full speed)
- Bluetooth* adapter ready
- Built-in MPEG-1/2 decoder
- Built-in decoder (Dolby Digital, Linear PCM)
- 96 kHz/24-bit DAC (for audio)

- 10-bit video DAC
- Advanced Sound Retriever
- EEQ
 - 5-mode preset equalizer
 - 1-mode custom preset equalizer
 - 3-band equalizer (Bass/Mid/Treble)
 - 2-mode selectable loudness
- Rotary volume
- IP-Bus input

- 2 RCA pre-outs (front + rear)
- A/V inputs and outputs
 - 1 RCA Video input
 - 1 RCA Video output
- Multi-channel processor (DEQ-P7650) control (CD-DD25 required)
- External unit control via IP-Bus (2 units)
- AUX-in by mini jack (front for audio & video)

DVH-3150UB 4-Channel High-Power DVD/VCD/CD Receiver with USB Direct Connection

NEW



- DivX*/MP3/WMA/AAC playback on DVD and CD
- JPEG on CD-R/RW and USB
- Front USB direct connection: USB 2.0 (full speed)
- Built-in MPEG-1/2 decoder
- Built-in decoder (Dolby Digital, Linear PCM)
- 96 kHz/24-bit DAC (for audio)
- 10-bit video DAC
- Advanced Sound Retriever
- EEQ
 - 5-mode preset equalizer
 - 1-mode custom preset equalizer
 - 3-band equalizer (Bass/Mid/Treble)
 - 2-mode selectable loudness
- Rotary volume
- 1 RCA pre-out (rear)
- A/V input and output
 - 1 RCA Audio input
 - 1 RCA Video output
- AUX-in by mini jack (front for audio)

USB Direct Connection* for iPod and iPhone



ALL AV HEADUNITS* ** Except AVH-P7950DVD, AVH-P6050DVD and DVH-3150UB, AVH-P5150DVD: Does not apply to iPhone.

Pioneer's new DVH-P4150UB is ready to roll with capability for direct connection to your iPod and iPhone. File search and access are extra-quick. The headunit keeps song, artist, time and album information displays very clear and user-friendly. A car entertainment system's wired connection for direct digital signal transfer from iPod into USB terminal maintains clean sound.



* Please see page 30 for details about iPod compatibility with Pioneer headunits.

Front USB Direct Connection for iPod with DVH-P4150UB

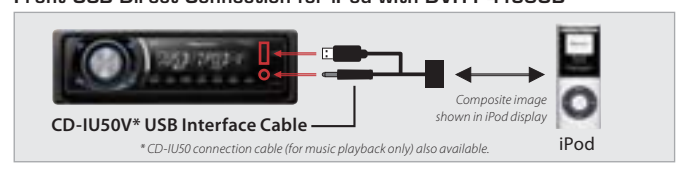

CD-IU50V **NEW**

USB Interface Cable for AVH-P3150DVD and DVH-P4150UB with iPod/iPhone.

Made for iPod

Works with iPhone

DivX®/MP3/WMA/AAC Playback on DVD



ALL AV HEADUNITS* * Except AVH-P6050DVD

Pioneer AV headunits can play compressed data formats (DivX® movies; MP3, WMA and AAC audio) burned from a PC onto CDs and DVDs. Simply load a disc into your car entertainment system and enjoy. Capacity of a recordable DVD is so huge that your entire music collection is likely to fit on one or two discs full of MP3, WMA and AAC files, with no need for external devices or connections.

AUX-In Connection by Mini Jack



ALL AV HEADUNITS*

Pioneer's single-DVD players each have a built-in AUX input for connecting a portable media player and other external auxiliary devices.

* Front AUX-in: AVH-P3150DVD/DVH-P4150UB/DVH-3150UB
Audio only: AVH-P7950DVD/AVH-P6050DVD/DVH-3150UB



Advanced Sound Retriever



AVH-P4150DVD **AVH-P3150DVD** **DVH-P4150UB** **DVH-3150UB**

Hear the glory of original sound across a deeper, wider spectrum from highly compressed MP3, WMA and AAC files stored on USB device, iPod and portable media players. By compensating for data (especially higher frequencies) that tend to get lost in the digital compression process, Pioneer's Advanced Sound Retriever technology enhances audio reproduction nearly all the way up to 20 kHz frequencies. We can make your music sound close to CD quality.

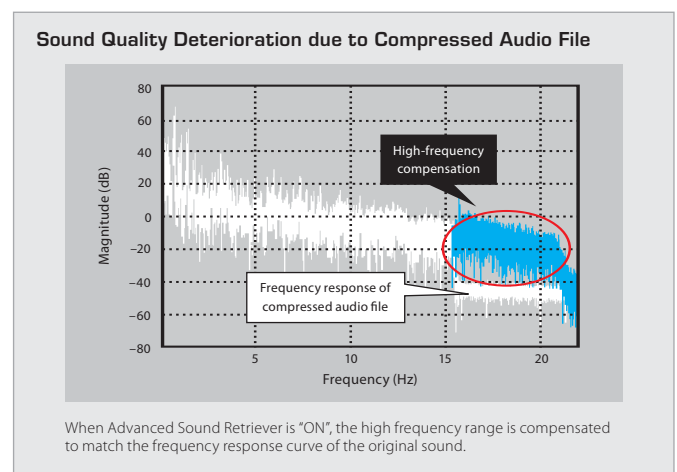

Multi-Channel Processor

DEQ-P7650 Multi-Channel Processor

MOSFET 50W×5 **DOLBY DIGITAL PRO LOGIC II** **dts Digital Surround** **Hi-VOLT DSP**

- Built-in decoder (DTS, Dolby Digital, Dolby Pro Logic II, Linear PCM)
- 6-ch. DAC
- 5-ch. built-in amplifier
- SFC for multi-channel source
- Built-in 6-ch. DSP
- 7-mode preset equalizer
- 2-mode custom preset equalizer
- Multi-channel Auto EQ
- Digital SFC (Sound Field Control): 6-mode (Musical/Drama/Action/Jazz/Hall/Club)
- Digital listening position selector
- Optimum sound for car environment
- Dynamic range control
- Optimum down-mix for normal speaker layout
- Built-in crossover network (L/R)
- Crossover frequency: 63 Hz/80 Hz/100 Hz/125 Hz/160 Hz/200 Hz
- IP-Bus input/output
- 6-ch. RCA pre-outs
- A/V inputs
- 2 RCA Audio inputs
- Dual optical inputs (DTS, Dolby Digital, Dolby Pro Logic II, Linear PCM)

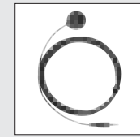

Microphone for Auto EQ

Dual Optical Inputs

DEQ-P7650

It is easy to expand DVD entertainment. The DEQ-P7650 has dual optical inputs for further upgrading your DVD system.

For example, by connecting one main DVD headunit (AVH-P5150DVD, DVH-P4150UB, etc.) plus additional source DVD player (XDV-P650) with the DEQ-P7650, you can instantly enjoy multi-DVD entertainment with dynamic 5.1-channel surround sound.



Dual optical inputs

Built-In 6-Channel DSP (Digital Signal Processor) DSP

DEQ-P7650

The driver who is looking for the versatility, sonic purity and distortion-free control of digital signal processing should be introduced to the DSP features of the DEQ-P7650. Built-in 6-channel DSP converts the incoming signals to digital form. The user can then balance the output signal to match the acoustic characteristics of a specific car and create a personal sound profile by using the Parametric Equalizer and SFC controls. A range of DSP-based sound timing features allows the DEQ-P7650 to be set up for truly optimum performance.

SFC (Sound Field Control) lets you optimize the aural ambience of every sound source. Musical, Drama and Action modes are heard to best advantage over 5.1-channel surround systems. For Jazz, Hall and Club modes, a two-channel stereo system is sufficient.

CD-DD25

Optical Digital Converter for DEQ-P7650 Connection with AVH-P5150DVD, AVH-P4150DVD, AVH-P3150DVD and DVH-P4150UB

DEQ-P7650 Connection Example—DVH-P4150UB & Monitor plus Source DVD Player

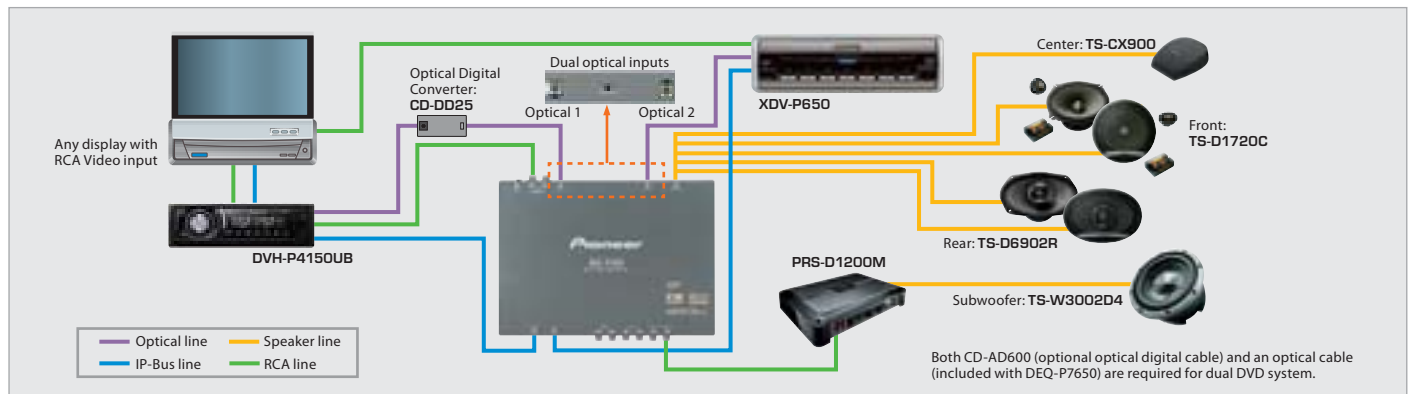

DEQ-P7650 Connection Example—AVH-P5150DVD plus Source DVD Player

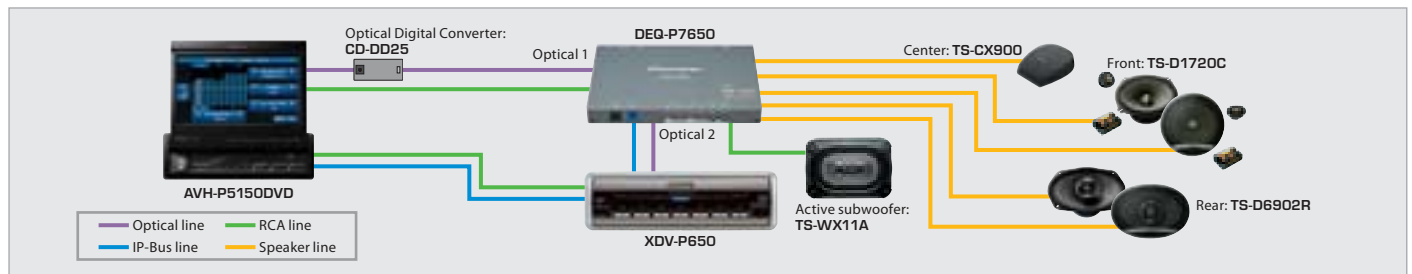

DEQ-P7650 Connection Example—AVH-P5150DVD plus Source DVD Player and TV Tuner

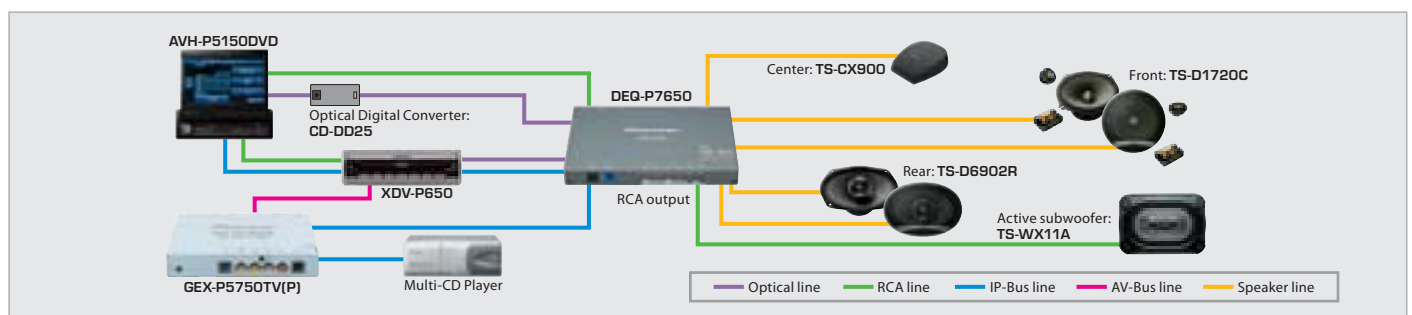

Other AV Units

XDV-P650 6-Disc Multi-DVD/VCD/CD Player



- DVD auto play
- Built-in MPEG 2/1 decoder
- Built-in decoder (Dolby Digital, Linear PCM)
- 96 kHz/24-bit DAC (for audio)
- 10-bit video DAC
- Controlled by IP-Bus headunit—full control by A/V entertainment master unit and external control by any IP-Bus headunit

- Stand-alone use with an equipped remote sensor
- Optical digital output (DTS, Dolby Digital, Dolby Pro Logic, Linear PCM)
- GUI control with joystick remote control and on-screen display

HIDE-AWAY UNIT

- Analog IP-Bus output
- Composite Video output (front + rear)



The compact 1-DIN size allows the XDV-P650 to be easily installed into the dashboard. Thus, dashboards with 2-DIN space can combine it with a 1-DIN headunit.

XDV-P650 Connection Compatibility with Main Units

| | | | |
|--------------|----------|--------------|----------|
| AVH-P7950DVD | Yes | AVH-P4150DVD | External |
| AVH-P6050DVD | External | AVH-P3150DVD | External |
| AVH-P5150DVD | Yes | DVH-P4150UB | External |

The XDV-P650 can be used either as a stand-alone multi-DVD/Video CD/CD player by connecting it directly to a monitor with a video input, or as a source unit by connecting to a headunit with an IP-Bus connection.



Playback of the discs is quick and easy by pushing buttons 1 to 6.

SE-IRM290

IR Wireless Headphone

- For use with the AVD-W7900



AVD-W7900 Limited distribution

7" (16:9) Widescreen Rear Seat Video Display PAL/NTSC

- 7" (16:9) wide TFT active matrix LCD color screen
- Picture control (brightness/contrast/hue/color)
- 5 wide screen modes (Just/Full/Cinema/Zoom/Normal)
- IR transmitter for optional wireless headphone (SE-IRM290)
- Power supply in
- 2 Audio/Video inputs (composite Audio & Video)
- 1 Audio/Video output (composite Audio & Video)



AXM-P7650

Multi-Channel Processor Controller

Limited distribution

- Full Dot OEL (Organic EL) display
- Use for control of DEQ-P7650 Multi-Channel Processor
- Full control multi-channel function with OEL display
- Speaker input for OEM radio or non-RCA output headunit
- IP-Bus connection to IP source unit
- Joystick remote control



ND-BC2 Universal Rear View Camera

- Wider Viewing Angle: 135 Degrees (Horizontal) and 100 Degrees (Vertical)
- Newly Developed 6.3 mm Color CCD with 270,000 Pixel Resolution (492 x 512 Pixels) for Higher Visibility even at night
- More Compact Camera Unit: 27 mm (W) x 27 mm (H) x 26 mm (D)

NOTES: The rear view camera is NOT intended for entertainment purposes. It is specifically designed to allow the driver to observe a towed boat or vehicle during transport. The optional rear view camera must be a "reversed image" type.

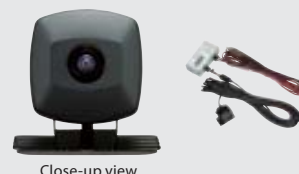

Close-up view

ND-BC20PA Visual DSP Unit with ND-BC2

- Adjustable (Normal/High) viewing angle for easy assessment of parking space width and depth
- Lens correction for undistorted rear view image
- Camera position compensation rotates the image for optimal rear view without changing camera position, even if the camera is not installed in the middle of the rear and aimed horizontally



ND-BC20PA Connection for Switching Viewing Angle



Normal angle mode

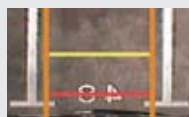

Sky view mode

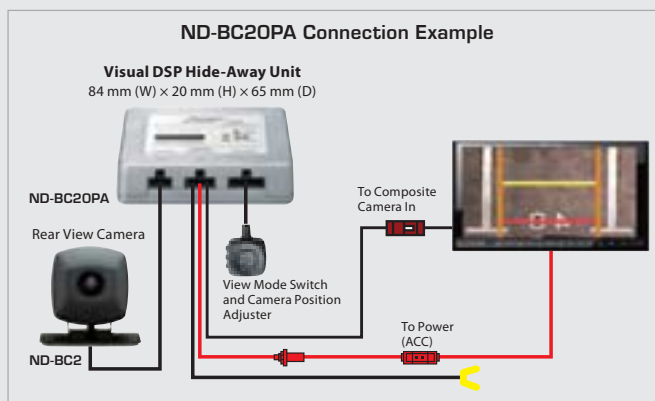

GEX-P5750TVP

Hide-Away TV Tuner for PAL/SECAM*

- 24-station (12 TV1/12 TV2) presets by BSSM
- IP-Bus input and output terminals
- RCA composite video output** for front and rear display (GEX-P5750TVP: PAL/SECAM, GEX-P5750TV: NTSC/PAL-M)

- RCA audio output for rear display
- AV-Bus input/output
- On-screen display
- Remote control sensor
- Mode change: source or stand alone

GEX-P5750TV

Hide-Away TV Tuner for NTSC/PAL-M

* Compatible with B, G, H, D, K, I (Details on page 59)
** The video output does not feature conversion function for rear display(s) between PAL and NTSC systems.



GEX-P5750TVP

IN-CAR SURROUND SOUND FOR MAXIMUM IMPACT

Peerless DVD Playback

The AVH-P7950DVD player packs versatile technology including 50 W x 8-channel MOSFET amplifier and decoders for DTS, DTS-ES, DTS Neo6, DTS 96/24, Dolby Digital, Dolby Pro Logic II, Dolby Digital EX and Linear PCM for enhanced multi-channel surround and all-around versatility. Auto time alignment and multi-channel Auto EQ effortlessly customize

sound characteristics precisely according to the car interior.

Simple touch panels make this and other Pioneer AV headunits a breeze to operate. The AVH-P7950DVD*, AVH-P5150DVD, AVH-P4150DVD, AVH-P3150DVD, DVH-P4150UB and DVH-3150UB can even play multiple formats: MP3, WMA, AAC and DivX® files from DVDs.



AVH-P7950DVD
7" (16:9) Wide WVGA Fully Motorized LCD Color Display with 8-Channel High-Power DVD/VCD/CD Receiver

- AVH-P7950DVD*
- AVH-P6050DVD
- AVH-P5150DVD
- AVH-P4150DVD
- AVH-P3150DVD
- DVH-P4150UB
- DVH-3150UB
- XDV-P650

*AVH-P7950DVD has built-in multi-channel processor.

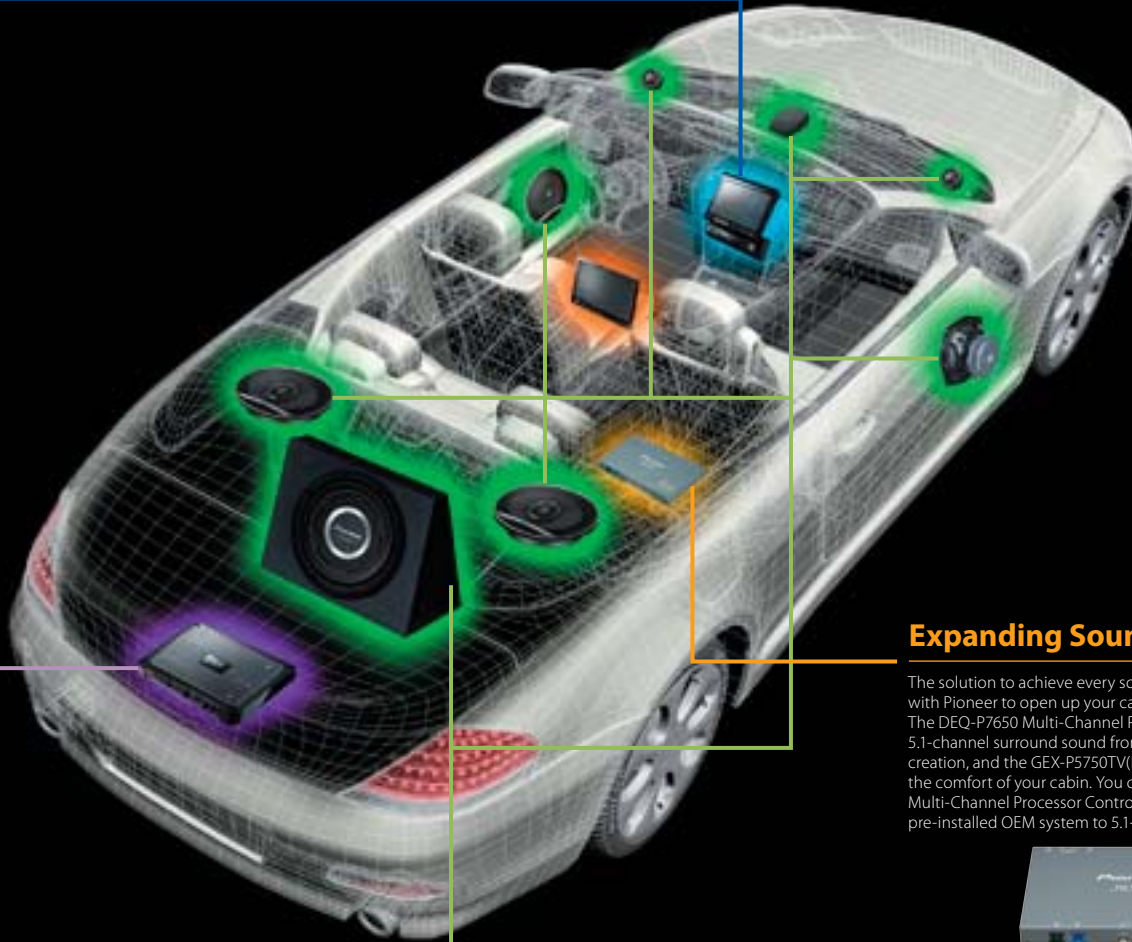

Expanding Sound By The Unit

The solution to achieve every sound has never been simpler, with Pioneer to open up your car entertainment system. The DEQ-P7650 Multi-Channel Processor lets you enjoy 5.1-channel surround sound from a dual DVD system of your creation, and the GEX-P5750TV(P) TV tuner lets you watch in the comfort of your cabin. You can even use the AXM-P7650 Multi-Channel Processor Controller to upgrade your car's pre-installed OEM system to 5.1-channel surround.



DEQ-P7650
Multi-Channel Processor

- DEQ-P7650
- GEX-P5750TV(P)
- CD-VS33

Digital Amps of Compact Power

Pioneer's Class-FD ICEpower and Class-D power amplifiers redefine state-of-the-art power amplification, thanks to their high-efficiency input power processing, compact design, and dynamic, yet stable clarity of subwoofer and speaker output.



PRS-D4200F
Class-FD 4-/2-Channel Bridgeable Amplifier

PRS-D2000SPL
Class-D Mono Amplifier

- PRS-D4200F
- PRS-D2200T
- PRS-D1200M
- PRS-D2000SPL
- PRS-D1200SPL
- GM-D8400M
- GM-D7400M

Dynamic Linear Surround

To see how well high-performance speakers can suit even compact spaces, consider Pioneer shallow-type subwoofers that are shallow enough in depth to install behind or under seats, yet deliver deep, dynamic bass. Smartly designed for easy 6.1- and 5.1-channel surround, the lineup of Pioneer's flush mount speakers features extra-rigid lightweight cones that deliver crisp, clear low-frequency sound across a wide dynamic spectrum from low whispers to massive volumes.

- TS-D6902R
- TS-D1602R
- TS-W12PRS
- TS-M171PRS
- TS-S101PRS
- TS-T031PRS
- TS-C171PRS
- TS-C131PRS
- TS-D1720C
- TS-D1320C
- TS-A1702C
- TS-A1302C
- TS-W3002D2
- TS-W3002D4
- TS-W308D2
- TS-W308D4
- TS-SW3001S4
- TS-SW3001S2
- TS-SW2501S4
- TS-SW2501S2
- TS-WX11A
- TS-WX22A
- TS-CX900



TS-SW3001S4
30 cm (12") Shallow-Mount Component Subwoofer (Single 4 Ω Voice Coil)



TS-D6902R
6" x 9" 2-Way Speaker



TS-WX301
30 cm Bass-Reflex Subwoofer

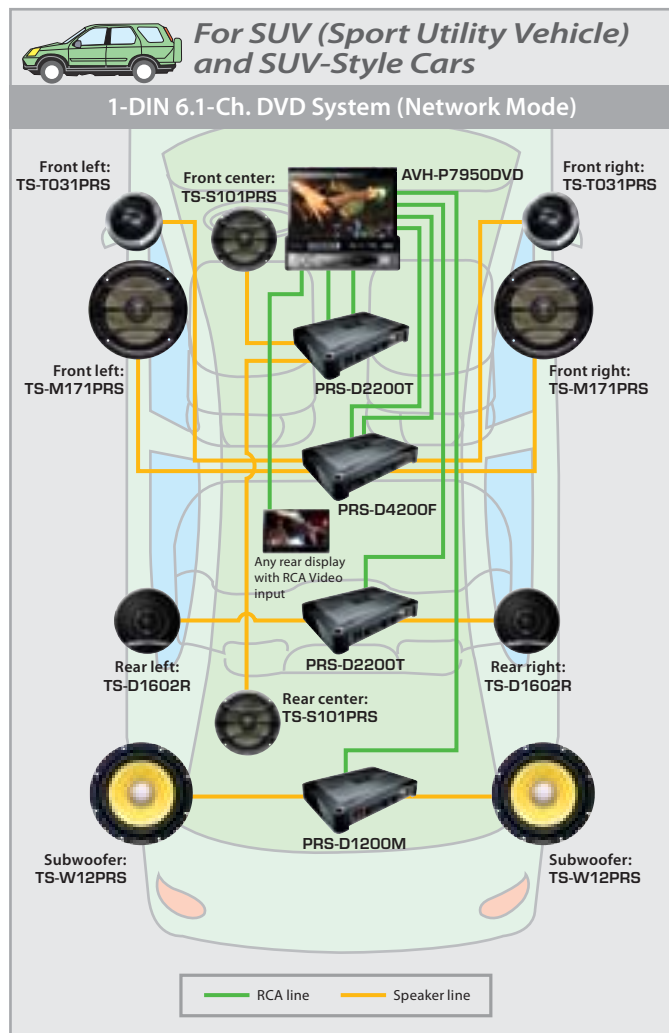
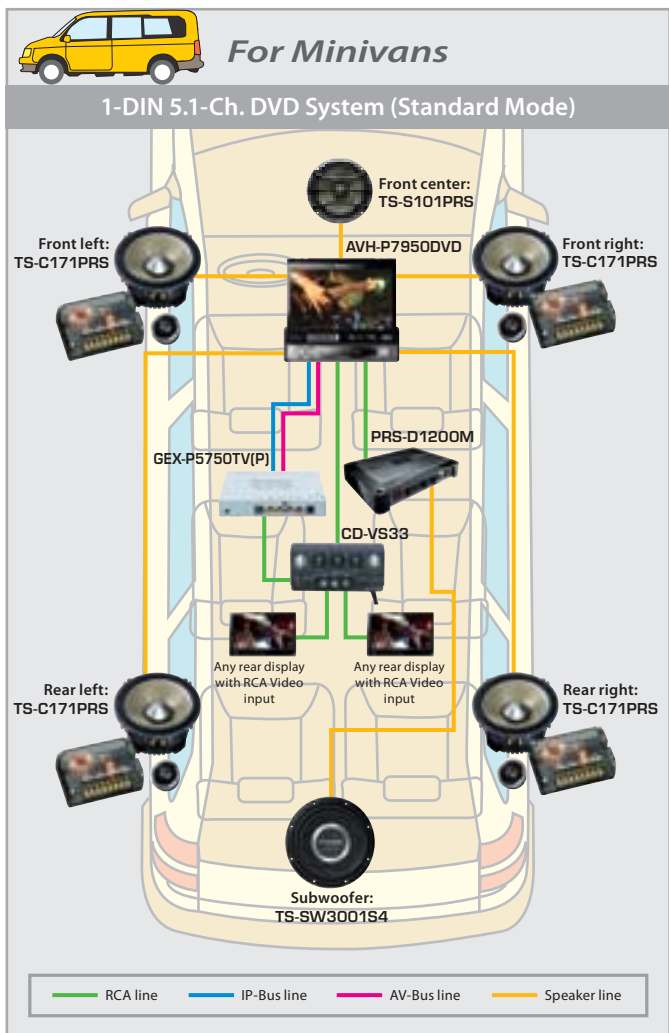
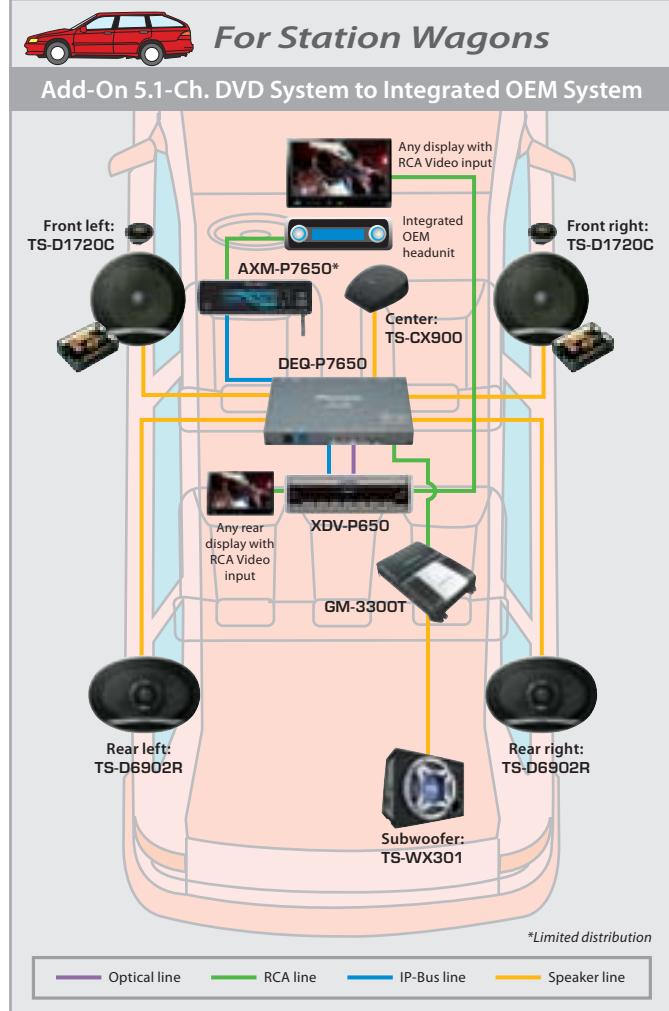
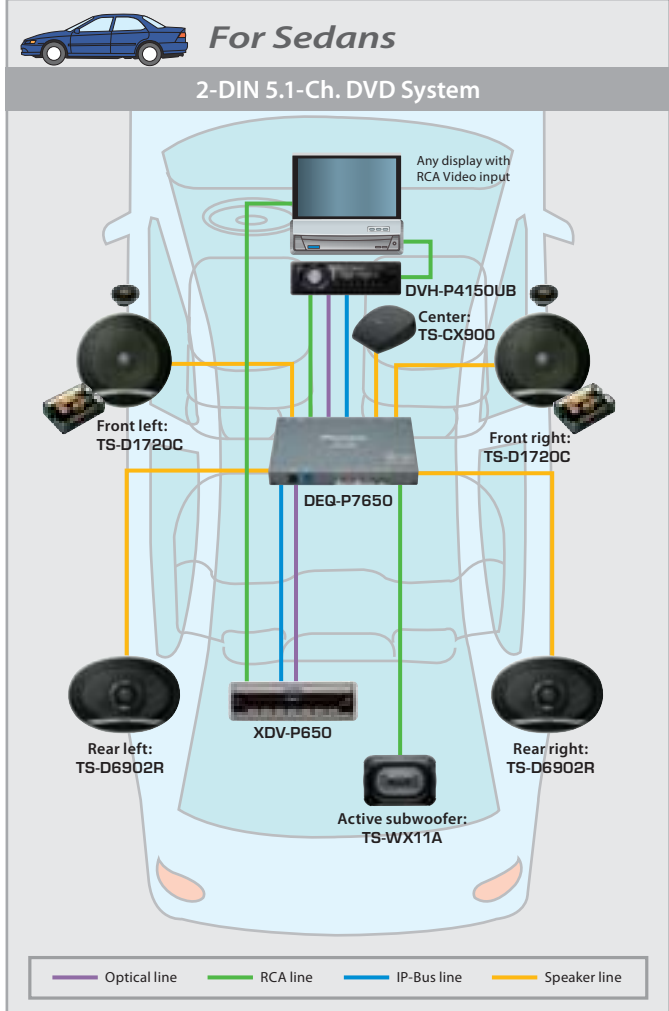

Remark: These connection configurations are only a few examples. Connection for your car may differ from that indicated in the diagram. Ask your nearest car stereo installer or dealer about installation details.

UNIFY YOUR UNIVERSE OF SOUND

Gain capability to extend your listening pleasure from more sources, for longer lengths of time. Now, a Pioneer audio headunit can play high-capacity, extra-compact SD memory cards as well as iPod, iPhone and portable media players. Every connection is simple, so you can bring more music onboard without complications.



DEH-4150SD
Handy, Versatile SD Card Compatibility



DEH-6150BT
Built-in Bluetooth® for Safer Calling



DEH-P5150UB
Easy Front USB Connection and OEL Display



EXPANDED CONNECTION

► Multiple Media Connectivity

Getting maximum play out of your in-car system requires a more seamless connection to various media. So the DEH-4150SD lets you bring SD memory cards containing music onboard for headunit storage and playback. You can also directly connect, control and playback music from an iPod, iPhone, USB device or other external portable media player.

An AUX input jack is easily accessible on the front panel.



RAISING DIGITAL AUDIO QUALITY

► Advanced Sound Retriever

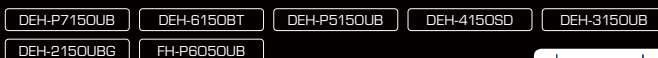

Pioneer audio headunits process high-quality sound even from compressed audio files stored in an iPod, USB device, etc.



MAKING CONVENIENCE MORE COMFORTABLE

► Wired Remote Control Input

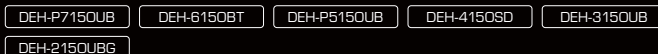

For more convenient entertainment system control that won't compromise driving safety, this feature lets a driver operate a Pioneer headunit without taking hands off of the steering wheel (given that the vehicle has factory-equipped remote control installed on the steering wheel).

► Bluetooth® Wireless Technology

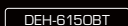

Pioneer's new DEH-6150BT features wireless Bluetooth® with Parrot module for easy, safe phone calling, excellent noise reduction to keep conversations clear and enhanced cell phone compatibility.



DEH-6150BT 4-Channel High-Power WMA/MP3/AAC/CD Receiver with USB Direct Connection and Bluetooth® Wireless Technology

NEW

Bluetooth *MOSFET 50Wx4* **MP3** **AAC** **1 RCA pre-out** **SUPER TUNER III D** **EQ3** DETACHABLE FACE SECURITY
Subwoofer control CD-R/RW



- Direct AUX-in by mini jack (front)
- Front USB direct connection: USB 2.0 (full speed)
- Direct connection for iPod and iPhone (CD-IU50 required)
- Built-in Bluetooth® Wireless Technology
- Advanced Sound Retriever
- EQ
- —3-band parametric equalizer
- Rotary Commander
- Direct Sub Drive
- 1 RCA pre-out: selectable (rear/subwoofer)
- Wired remote control input



Included microphone for hands-free talking

Introducing a Better Hands-Free Solution



Simple and Convenient

Enjoy the convenience of having Bluetooth® built right into the unit, with no additional hands free car kits or other accessories needed. The unit acts like a speakerphone, channeling the sound through your car speakers which makes the call sound better. It also automatically mutes your music so that you'll never miss a call.

DEH-6150BT

Notes: Use of Bluetooth® is permissible according to regulations on radio waves in the country in which the Bluetooth® product is used. Ask your nearest dealer about Bluetooth® connectivity with your cell phone.

Built-in Bluetooth® Technology with Parrot Module

With Bluetooth® module by Parrot, cell phone compatibility is extended, and calls come in loud and clear.

Expanded Cell Phone Compatibility

Thanks to Parrot technology, Pioneer units are now compatible with more cell phones.

Auto Phonebook Synchronization

Connect your cell phone to the DEH-6150BT, and phonebook synchronization is automatic.

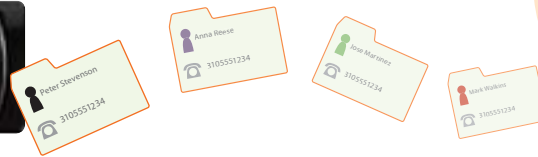

Improved Noise Reduction

The DEH-6150BT incorporates new noise reduction technology that can reduce the effect of road noise.

Before Noise Reduction

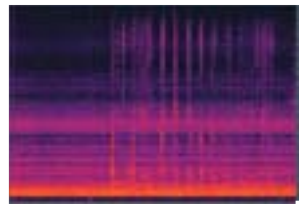

After Noise Reduction

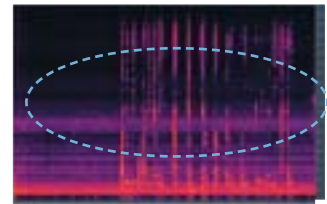

More Phonebook Memory

Use with Phone Pairing to transfer your entire phonebook at a single time to the headunit, which can memorize up to 1,000 different numbers: e.g., 500 persons x 2 phone types (cell phone, home).



ABC search for easy dialing

1,000 numbers

SMS Alert

SMS alert lets you know if you receive any incoming text messages, even if you are listening to loud music. The message alert will play a sound and an icon will appear on the screen.

Phonebook Access

Don't stop the music to make a call. You can access a phonebook without switching from the sound source to Bluetooth® mode.



"Wireless Audio" Control and Streaming

When you're not utilizing hands-free calling, the DEH-6150BT can use Bluetooth® Wireless Technology to feed your appetite for entertainment. Using "wireless audio" control and streaming (AVRCP, A2DP), you can control and listen to a compatible audio player or music phone on your headunit.





DEH-P7150UB 4-Channel High-Power WMA/MP3/AAC/CD Receiver with USB Direct Connection

NEW

-
-
-
-
-
-
-
-
-
-
-
-
-



- Full Dot OEL (Organic EL) display
- Auto-slide face
- Direct AUX-in by mini jack (rear)
- USB direct connection: USB 2.0 (full speed)
- Direct connection for iPod (CD-IU50 required)
- Bluetooth® adapter ready
- Advanced Sound Retriever
- EEQ
- 7-band digital graphic equalizer
- Rotary Commander
- Direct Sub Drive
- 3 RCA pre-outs (front + rear + subwoofer)
- Spectrum analyzer
- Wired remote control input
- Multi-language display (English/Spanish/Portuguese)

USB Direct Connection



- DEH-P7150UB
- DEH-6150BT
- DEH-P5150UB
- DEH-4150SD
- DEH-3150UB
- DEH-2150UBG
- FH-P6050UB

Take your favorite MP3, WMA and AAC files for a ride. With direct connection of a new Pioneer headunit* to a portable media player, USB device or other USB-compatible gear, you can play in your car whatever you've recorded via PC. It's fast and easy. No adapters are required.

*DEH-3150UB/DEH-2150UBG: MP3/WMA file playback

NOTE: Unauthorized copying of music is strictly prohibited. Not every device is compatible. See more details in Pioneer website. Compatible with USB device only. Not compatible with DRM (Digital Rights Management) contents and MTP (Media Transfer Protocol) connection players.

CD-IU50

Interface Cable for iPod and iPhone

Optionally available for connecting an iPod to the DEH-P7150UB, DEH-6150BT, DEH-P5150UB, DEH-4150SD and FH-P6050UB.



Connection Example for USB Devices Compatible with MSC

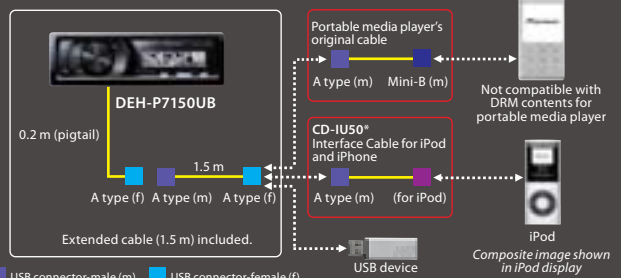

* CD-IU50 Interface Cable for iPod and iPhone optionally available for connecting an iPod to the DEH-P7150UB, DEH-6150BT, DEH-P5150UB, DEH-4150SD and FH-P6050UB. Please see page 30 for details about iPod compatibility with Pioneer headunits. A 3rd or 4th generation iPod requires CD-IB100II.

▶ Advanced Sound Retriever

- DEH-P7150UB
- DEH-6150BT
- DEH-P5150UB
- DEH-4150SD
- DEH-3150UB
- DEH-2150UBG
- FH-P6050UB

Hear the glory of original sound across a deeper, wider spectrum from highly compressed MP3, WMA and AAC files stored on USB device, iPod and portable media players. By compensating for data (especially higher frequencies) that tend to get lost in the digital compression process, Pioneer's Advanced Sound Retriever technology enhances audio reproduction nearly all the way up to 20 kHz frequencies. We can make your music sound close to CD quality.

Sound Quality Deterioration due to Compressed Audio File

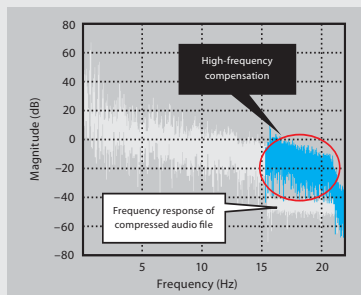

When Advanced Sound Retriever is "ON", the high frequency range is compensated to match the frequency response curve of the original sound.

DEH-P5150UB

4-Channel High-Power WMA/MP3/AAC/CD Receiver with USB Direct Connection

NEW

- MOSFET 50Wx4
- OEL MP3
- Windows Media
- AAC
- ADVANCED SOUND RETRIEVER
- 3 RCA pre-outs
- Hi-VOLT
- IP-BUS control
- SUPER TUNER II D
- EEQ
- DETACHABLE FACE SECURITY
- Subwoofer control
- CD-R/RW



AUX IN AUDIO

FRONT USB

Made for iPod

Works with iPhone

- Full Dot OEL (Organic EL) display
- Direct AUX-in by mini jack (front)
- Front USB direct connection: USB 2.0 (full speed)
- Direct connection for iPod and iPhone (CD-IU50 required)
- Bluetooth* adapter ready
- Advanced Sound Retriever
- EEQ
- -7-band digital graphic equalizer
- Rotary Commander
- Direct Sub Drive
- 3 RCA pre-outs (front + rear + subwoofer)
- Spectrum analyzer
- Wired remote control input
- Multi-language display (English/Spanish/Portuguese)

▶ Full Dot OEL (Organic EL) Display



- DEH-P7150UB*
- DEH-P5150UB
- RS-D7R11*
- DEX-P90RS*
- DEH-P80RS11*

The Full Dot OEL display allows you to scroll through your iPod and USB device with greater ease, displaying up to three lines in list mode. The unit also comes with features like 3D animated screensavers and a wider viewing angle range which provides clear, trouble-free viewing from virtually any position, even in sunlight.

*White color OEL display



3-Line List Display



3D Animated Screensaver

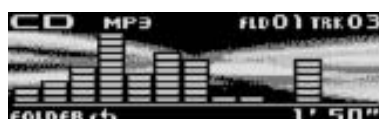

White Color OEL Display

▶ Rotary Commander and List Key

- DEH-P7150UB
- DEH-P5150UB
- DEH-4150SD
- FH-P6050UB
- DEH-P80RS11

Next to the Rotary Commander on the new DEH-P5150UB sits a large LIST key for extra-quick, easy file search and access. Press it to display folder or file lists, rotate the commander dial to search, then press the commander button for playback.



DEH-P5150UB

▶ Link Play for iPod

- DEH-P7150UB*
- DEH-6150BT
- DEH-P5150UB
- DEH-4150SD
- FH-P6050UB*

Listening to an artist that you just can't get enough of and want to hear more? Now you can use Link Play to rediscover music buried in the thousands of songs in your library. You can also have your passenger control your music directly from the iPod.

*Artist only

Album
link play
Jump to another title that hasn't recently been played from the same album.

Artist
link play
Jump to another album of the same artist.

Genre
link play
Jump to other music that you haven't heard in a while from the same genre.

DEH-4150SD 4-Channel High-Power WMA/MP3/AAC/CD Receiver with USB Direct Connection and Built-in SD Memory Card Slot

NEW

MOSFET 50Wx4 MP3 AAC ADVANCED SOUND RETRIEVER 2 RCA pre-outs SUPER TUNER III D EEO DETACHABLE FACE SECURITY Subwoofer control CD-R/RW



AUX IN AUDIO
FRONT USB
SD™

Made for iPod

Works with iPhone

- Built-in SD memory card slot (SDHC compatible)
- Direct AUX-in by mini jack (front)
- Front USB direct connection: USB 2.0 (full speed)
- Direct connection for iPod and iPhone (CD-IU50 required)
- Advanced Sound Retriever
- EEO
- —3-band parametric equalizer
- Rotary Commander
- Direct Sub Drive
- 2 RCA pre-outs: front + rear/subwoofer (selectable)
- Wired remote control input

Built-in SD Memory Card Slot (SDHC Compatible)



DEH-4150SD

The new DEH-4150SD has a built-in slot for SD memory card* of up to 16 GB containing MP3, WMA, AAC and WAV music files. Such huge capacity allows for seamless playback with no need to change SD cards often. That goes a long way toward extending convenience and listening pleasure.

*Please see page 27 for details about SD memory card compatibility with DEH-4150SD.



Front USB Direct Connection



DEH-6150BT DEH-P5150UB DEH-4150SD DEH-3150UB DEH-2150UBG

Take your favorite MP3, WMA and AAC files for a ride. New Pioneer headunits have a front USB terminal to directly connect** a portable media player, USB device or other USB-compatible gear, so you can play in your car whatever you've recorded via PC. It's fast and easy. No adapters are required.

** Please use CD-U50E USB extension cable if a direct connection causes a USB device to protrude from the headunit in a way that can interfere with driving.



USB Direct Connection for iPod and iPhone

DEH-P7150UB* DEH-6150BT DEH-P5150UB DEH-4150SD FH-P6050UB*

Pioneer's new headunit is ready to roll with capability for direct connection** to iPod nano, iPod or iPhone. File search and access are extra-quick. The headunit keeps song, artist, time and album information displays very clear and user-friendly.

*Does not apply to iPhone. **CD-IU50 required



CD-U50E

USB Extension Cable

50 cm cable optionally available for connecting a headunit with built-in USB port to an external USB device.



Speedier Search Using iPod and iPhone

DEH-6150BT DEH-P5150UB DEH-4150SD

Now, Pioneer's latest headunits are even easier to enjoy along with an iPod than previous headunits. A new USB mechanism speeds up "List Search", refined processing speeds up "Alphabetical Search" and the Rotary Commander speeds up access to any file in the iPod.



Multiple Connections—SD Memory Card, USB Device, iPod/iPhone, Portable Media Player and AUX-in

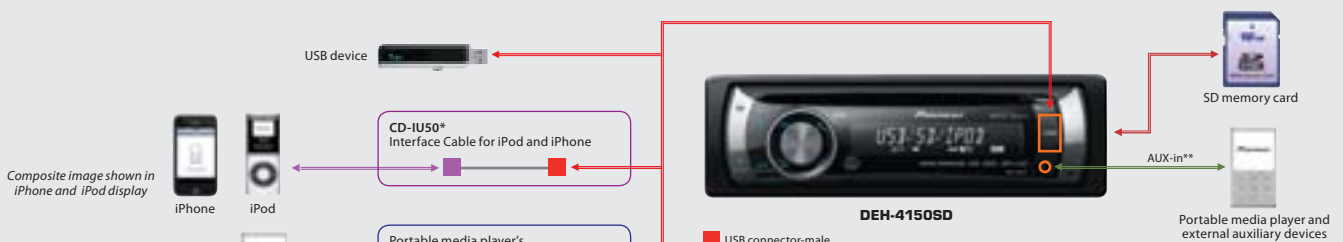

*CD-IU50 Interface Cable for iPod and iPhone optionally available for connecting an iPod or iPhone to the DEH-P7150UB, DEH-6150BT, DEH-P5150UB, DEH-4150SD and FH-P6050UB. Please see page 30 for details about iPod compatibility with Pioneer headunits. A 3rd or 4th generation iPod requires CD-I8100II. **Conventional Mini-Jack cable required.

DEH-4150SD: SD Memory Card Formats and Features for Playback

| | | |
|----------------------|---|----------|
| Applicable Logomarks |   | • |
| |   | •* |
| |   | •* |
| Max. Memory Capacity | | 16 GB |
| File System | | FAT16/32 |

NOTES: *SD*, *SDHC*, *miniSD*, *miniSDHC*, *microSD* and *microSDHC* Logos are trademarks. SDHC stands for SD High Capacity memory card. *Maximum capacity of applicable *miniSDHC* and *microSDHC* memory cards is 8 GB (as of September 2008).

| | | |
|-----------------|------------------|---|
| Decoding Format | MP3 | MPEG-1/-2 Audio Layer-3 |
| | WMA | Version 7/7.1/8/9/10/11 (2-ch. audio) |
| | AAC | MPEG-4 AAC (iTunes encoded only) (version 7.7 and earlier versions) |
| | WAV | Linear PCM, MS ADPCM (non-compressed) |
| Text Data | File/Folder Name | • (64 bytes) |
| FF/REV & Pause | | • |
| Scan/Repeat | | • (File/Folder) |
| Random Play | | • (Folder/All) |

DEH-3150UB 4-Channel High-Power WMA/MP3/CD Receiver with USB Direct Connection

NEW



- Direct AUX-in by mini jack (front)
- Front USB direct connection: USB 2.0 (full speed)
- Advanced Sound Retriever
- Rotary volume
- 2 RCA pre-outs (front + rear)
- Wired remote control input

Front AUX-In Connection

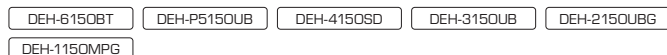

Hook up your portable digital devices with ease in an instant. Each new Pioneer headunit has a built-in AUX input on its front panel for connecting a portable media player and external auxiliary devices.



Wired Remote Control Input

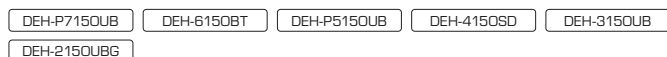

Since entertainment shouldn't compromise driving safety, Pioneer engineered this feature for cars with factory-equipped remote control installed on the steering wheel to give drivers more convenient control of a Pioneer headunit without having to take their hands off the wheel.

Built-in 50 W x 4-Channel High-Power MOSFET Amplifier

MOSFET 50Wx4

ALL AUDIO HEADUNITS* *Except KEH-P2035, RS-D7RII and DEX-P90RS

To minimize voltage loss in its headunit amplifiers, Pioneer built-in high-performance Power MOSFET integrated circuitry that processes signals efficiently at 50 W x 4 maximum total output.

High-speed MOSFET switching reduces distortion to virtually nothing at high frequency ranges, thanks to superior characteristics of linearity that smooth the signal transmission path from input to output. Pioneer's independent routing of input and output current is essential to obliterating distortion.

High power of 50 W per channel and characteristics of the bonding wire ensure excellent sound quality. The 99.99 % pure OFC (oxygen-free copper) bonding wire has low electrical resistance, so minimal electric power is lost as heat in the IC chip, enhancing power handling efficiency as well as sound quality.

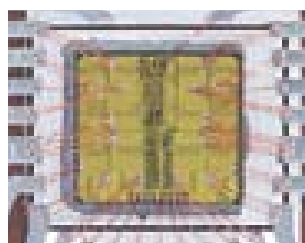

Power MOSFET high-power IC chip

Display Off Enhances Security and Ambience

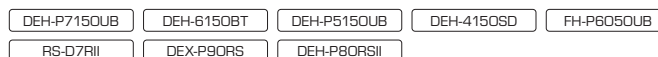

To avoid unwanted attention and indulge more completely in the listening experience, press and hold the DISP OFF button for two seconds, and all headunit illumination and display lights (except that for the DISP OFF button) turn off instantly, even while the headunit is in playback mode.

Bass Boost



Bass Boost offers a choice between 0 dB to 12 dB level settings that can be adjusted in 2 dB steps, letting you set the optimal bass level for each speaker and subwoofer connected to a system, according to preference and music style. The result is more precise control over the balance of sounds to enhance the overall impact of the music you listen to.

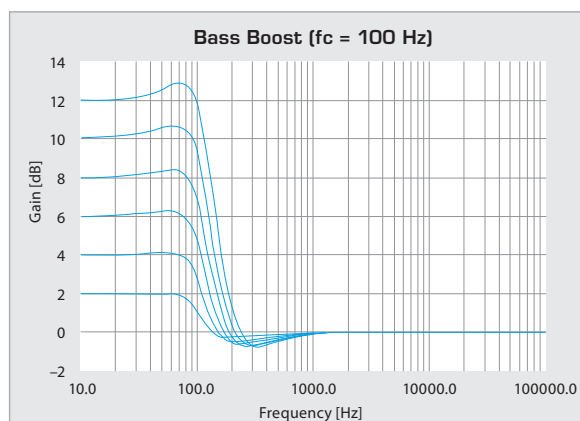

DEH-2150UBG

4-Channel High-Power WMA/MP3/CD Receiver with USB Direct Connection

NEW



- Direct AUX-in by mini jack (front)
- Front USB direct connection: USB 2.0 (full speed)
- Advanced Sound Retriever
- Rotary volume
- 1 RCA pre-out (rear)
- Wired remote control input

Distribution of the model is limited to certain areas.

DEH-1150MPG

4-Channel High-Power WMA/MP3/CD Receiver

NEW

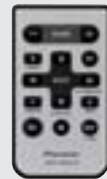

- Direct AUX-in by mini jack (front)
- BMX (Bitmetric Equalizer)
- Rotary volume
- 1 RCA pre-out (rear)

Distribution of the model is limited to certain areas.

EEQ (Easy Equalizer)



ALL AUDIO HEADUNITS* *Except KEH-P2035, RS-D7R11 and DEX-P90RS

Sound shaping is at your command. You can adjust the sound according to in-car acoustic characteristics and the music you listen to.

5-Mode Preset Equalizer

You can switch among five preset equalization curves* (Super Bass/Powerful/Natural/Vocal/Flat) simply by pushing an EQ button. Each of these settings boosts bass and high-frequency ranges in ways that suit the music best.

*Dynamic/Powerful/Natural/Vocal/Flat in the DEH-3150UB, DEH-2150UBG and DEH-1150MPG.

2-Mode Custom Preset Equalizer

Create and memorize your favorite equalization curves from an amazing variety of sound-shaping dimensions and combinations, just as you like. Custom-1 mode can memorize adjusted preset curves using 7-band* digital equalizer settings for each source (Source EQ memory). Custom-2 mode can register your favorite custom curve (based on Flat mode** curve) for all sources using the 7-band* digital equalizer.

*L/R independent 16-band for DEH-P80RSII.

**Flat mode also remains after customizing equalization curve.

1-Mode Custom Preset Equalizer

Pioneer's headunits feature a 1-mode custom preset equalizer for creating your favorite sound curve from an amazing variety of sound-shaping dimensions/combinations exactly as you like. This mode can memorize adjusted preset curves by 3-band parametric equalizer* settings for each source.

*Bass/mid/treble equalizer for DEH-3150UB, DEH-2150UBG and DEH-1150MPG.

2-Way Crossover (HPF/LPF)

Our most feature-loaded models allow extra EEQ flexibility with selectable HPF (High Pass Filter) and LPF (Low Pass Filter). Headunits of these systems can perform as amplifiers or separate crossover units for easier system control, particularly of low-frequency signals.

3-Mode Selectable Loudness

Select among three levels (high/mid/low) to instantly boost volume when driving noise overpowers in-car sound.

2-Mode Selectable Loudness

Select high or low volume boost level when extraneous noise drowns out your sound system.

| | DEH-P7150UB | DEH-6150BT | DEH-P5150UB | DEH-4150SD | DEH-3150UB | DEH-2150UBG | DEH-1150MPG | FH-P6050UB | DEH-P80RSII |
|--|-------------|------------|-------------|------------|------------|-------------|-------------|------------|-------------|
| 5-mode preset equalizer | ● | ● | ● | ● | ● | ● | ● | ● | ● |
| Custom preset equalizer <2 = 2-mode, 1 = 1-mode> | 2 | 1 | 2 | 1 | 1 | 1 | 1 | 2 | 2 |
| Digital graphic equalizer <16 = 16-band, 7 = 7-band> <L/R = L/R independent> | 7 | | 7 | | | | | 7 | 16, L/R |
| 2-way crossover: HPF/LPF <L/R = L/R independent> | ● | ● | ● | ● | | | | ● | L/R |
| 3-band parametric equalizer | | | | | | | | | |
| Bass Boost | ● | ● | ● | ● | | | | ● | |
| Selectable loudness <3 = 3-mode, 2 = 2-mode> | 3 | 3 | 3 | 3 | 2 | 2 | 2 | 3 | 3 |
| Nuance control | ● | | ● | | | | | ● | ● |

2-DIN Player



FH-P6050UB 4-Channel High-Power WMA/MP3/AAC/CD Receiver with USB Direct Connection



- 3-line segmented OEL (Organic EL) display
- Direct AUX-in by mini-jack (rear)
- USB direct connection: USB 2.0 (full speed)
- Direct connection for iPod (CD-IU50 required)
- Bluetooth® adapter ready
- Advanced Sound Retriever
- EQ
- 7-band digital graphic equalizer
- Rotary Commander
- Direct Sub Drive
- 2 RCA pre-outs: front + rear/subwoofer (selectable)



3-Line Segmented OEL Display



FH-P6050UB

Pioneer's 2-DIN WMA/MP3 player FH-P6050UB features an extra-large, wide display with 3-line Segmented OEL of outstanding contrast and brightness. The 3-line character section offers a clear, uncluttered readout of artist, song title and operation menu data throughout a wide viewing angle range.



Multi-CD Players

CDX-P1280



IP-Bus 12-Disc Multi-CD Player

CDX-P680



IP-Bus 6-Disc Multi-CD Player

- CD-R/RW playback with skip play
- Disc title memory: 100 titles
- ADPS (Automatic Disc Program Selection)
- ITS (Instant Track Selection)



CDX-P1280



Cassette Player

KEH-P2035



4-Channel High-Power Cassette Receiver

- Adapter ready for iPod (external unit control)
- 1 RCA pre-out (rear)
- BTB (Bass/Treble Booster)
- Radio intercept
- 2-mode selectable loudness
- Multi-CD control (pause and repeat)



Connect With Your Portable

What you can do with...



AUDIO/VIDEO

| Model | Any Portable | Full Control for iPod & iPhone | Control USB Device | Bluetooth Hands-Free | Access SD Card |
|--------------|---------------------------------|--------------------------------|--------------------------------|----------------------|----------------|
| AVH-P7950DVD | Built-In ⁽¹⁾ | CD-IB100II ⁽²⁾ | CD-UB100 ⁽³⁾ | CD-BTB200/CD-BTB100 | |
| AVH-P6050DVD | Built-In ⁽¹⁾ | CD-IB100II ⁽²⁾ | CD-UB100 ⁽³⁾ | CD-BTB200/CD-BTB100 | |
| AVH-P5150DVD | Built-In | CD-IU205V ⁽²⁾ | Built-In | CD-BTB200/CD-BTB100 | |
| AVH-P4150DVD | Built-In | CD-IU200V ⁽⁴⁾ | Built-In | CD-BTB200/CD-BTB100 | |
| AVH-P3150DVD | Built-In (Front) | CD-IU50V ⁽⁴⁾ | Built-In (Front) ^{††} | CD-BTB200/CD-BTB100 | |
| DVH-P4150UB | Built-In (Front) | CD-IU50V ⁽⁴⁾ | Built-In (Front) ^{††} | CD-BTB200/CD-BTB100 | |
| DVH-3150UB | Built-In ⁽¹⁾ (Front) | | Built-In (Front) ^{††} | | |

AUDIO HEADUNITS

| Model | Any Portable | Full Control for iPod & iPhone | Control USB Device | Bluetooth Hands-Free | Access SD Card |
|-------------|------------------|--------------------------------|--------------------------------|------------------------------------|----------------|
| DEH-P7150UB | Built-In | CD-IU50 ⁽²⁾⁽⁵⁾ | Built-In | CD-BTB200/CD-BTB100 | |
| DEH-6150BT | Built-In (Front) | CD-IU50 ⁽⁵⁾ | Built-In (Front) ^{††} | Built-In | |
| DEH-P5150UB | Built-In (Front) | CD-IU50 ⁽⁵⁾ | Built-In (Front) ^{††} | CD-BTB200/CD-BTB100 | |
| DEH-4150SD | Built-In (Front) | CD-IU50 ⁽⁵⁾ | Built-In (Front) ^{††} | | Built-In |
| DEH-3150UB | Built-In (Front) | | Built-In (Front) ^{††} | | |
| DEH-2150UBG | Built-In (Front) | | Built-In (Front) ^{††} | | |
| DEH-1150MPG | Built-In (Front) | | | | |
| FH-P6050UB | Built-In | CD-IU50 ⁽²⁾⁽⁵⁾ | Built-In | CD-BTB200/CD-BTB100 | |
| DEH-P80RSII | Built-In | CD-IB100II ⁽²⁾ | CD-UB100 ⁽³⁾ | CD-BTB200/CD-BTB100 ⁽³⁾ | |

⁽¹⁾ Audio only. ⁽²⁾ Does not apply to iPhone. ⁽³⁾ External control. ⁽⁴⁾ CD-IU50 connection cable (for music playback only) also available. ⁽⁵⁾ A 3rd or 4th generation iPod requires CD-IB100II.
^{††} Not every device is compatible. See more details in Pioneer website. Compatible with MSC (Mass Storage Class). Not compatible with DRM (Digital Rights Management) contents.
^{†††} Please use CD-IU50E USB extension cable if a direct connection causes a USB device to protrude from the headunit in a way that can interfere with driving.

Connection for iPod Table with Pioneer Headunits

A: Plays audio
A/V: Plays audio and video

| Model | Interface | Use with | Software Version Direct Connection for iPod | | | | | | | | | | | | | | | | |
|------------------------------------|---------------------------------|------------------|---|---------------------|----------|---------------|--------------------|--------------|---------------------|--------------------|------------------|--------------------|----------|----------|----------|--------------------|------------------|-------|-------|
| | | | 2.0 | | 2.3.0 | 1.2.1 | | 1.3.0 | 1.1.2 | 1.1.5 | | 2.1.1 | 1.4.1 | 1.3.1 | | 1.3.1 | | 1.1.3 | 1.0.2 |
| | | | iPhone | iPhone 3G | 3rd gen. | iPod 4th gen. | 5th gen. | iPod classic | iPod touch 1st gen. | 2nd gen. | iPod mini | iPod nano 1st gen. | 2nd gen. | 3rd gen. | 4th gen. | | | | |
| AVH-P7950DVD/AVH-P6050DVD | IP-Bus | CD-IB100II | — ⁽¹⁾⁽²⁾ | — ⁽¹⁾⁽²⁾ | A | A | A | A | A | A | A ⁽¹⁾ | A | A | A | A | A | A ⁽¹⁾ | | |
| | AUX | CD-RM10 | A | A | — | — | A/V ⁽³⁾ | — | — | — | — | — | — | — | — | — | — | | |
| AVH-P5150DVD | Direct Connection | CD-IU205V | — ⁽²⁾ | — ⁽¹⁾⁽²⁾ | A | A | A/V | A/V | A/V | A/V ⁽³⁾ | — | A | A | A | A/V | A/V ⁽³⁾ | | | |
| | USB Direct Connection for Video | CD-IU200V | A/V | A/V | — | — | A/V | A/V | A/V | A/V | — | A | A | A | A/V | A/V | | | |
| AVH-P4150DVD | USB Direct Connection for Music | CD-IU50 | A | A | — | — | A | A | A | A | — | A | A | A | A | A | | | |
| | USB Direct Connection for Video | CD-IU50V | A/V | A/V | — | — | A/V | A/V | A/V | A/V | — | A | A | A | A/V | A/V | | | |
| AVH-P3150DVD | USB Direct Connection for Music | CD-IU50 | A | A | — | — | A | A | A | A | — | A | A | A | A | A | | | |
| | USB Direct Connection for Video | CD-IU50V | A/V | A/V | — | — | A/V | A/V | A/V | A/V | — | A | A | A | A/V | A/V | | | |
| DVH-P4150UB | USB Direct Connection for Music | CD-IU50 | A | A | — | — | A | A | A | A | — | A | A | A | A | A | | | |
| | USB Direct Connection for Video | CD-IU50V | A/V | A/V | — | — | A/V | A/V | A/V | A/V | — | A | A | A | A/V | A/V | | | |
| DVH-3150UB | AUX | 3.5 mm AUX Cable | A | A | A | A | A | A | A | A | A | A | A | A | A | A | | | |
| | IP-Bus | CD-IB100II | — ⁽¹⁾⁽²⁾ | — ⁽¹⁾⁽²⁾ | A | A | A | A | A | A | A ⁽¹⁾ | A | A | A | A | A ⁽¹⁾ | | | |
| DEH-P80RSII | AUX | 3.5 mm AUX Cable | A | A | — | — | — | — | — | — | — | — | — | — | — | — | | | |
| | USB Direct Connection for Music | CD-IU50 | — | — | — | — | A | A | A | A | — | A | A | A | A | A | | | |
| DEH-P7150UB | IP-Bus | CD-IB100II | — ⁽¹⁾⁽²⁾ | — ⁽¹⁾⁽²⁾ | A | A | — | — | — | — | — | A | A | A | A | A | | | |
| | USB Direct Connection for Music | CD-IU50 | — | — | — | — | A | A | A | A | — | A | A | A | A | A | | | |
| DEH-P5150UB/FH-P6050UB | IP-Bus | CD-IB100II | — ⁽¹⁾⁽²⁾ | — ⁽¹⁾⁽²⁾ | A | A | — | — | — | — | — | A | A | A | A | A | | | |
| | USB Direct Connection for Music | CD-IU50 | A | A | — | — | A | A | A | A | — | A | A | A | A | A | | | |
| DEH-6150BT/DEH-4150SD | IP-Bus | CD-IB100II | — | — | A | A | — | — | — | — | — | A | A | A | A | A | | | |
| | USB Direct Connection for Music | CD-IU50 | A | A | — | — | A | A | A | A | — | A | A | A | A | A | | | |
| DEH-3150UB/DEH-2150UBG/DEH-1150MPG | AUX | 3.5 mm AUX Cable | — | — | A | A | — | — | — | — | — | A | A | A | A | A | | | |
| | AUX | 3.5 mm AUX Cable | A | A | A | A | A | A | A | A | A | A | A | A | A | A | | | |

(1) Battery charge function not applicable. (2) A caution that "This accessory is not made to work with iPhone" appears on the display of an iPhone connected to the headunit. When an iPhone or iPhone 3G is connected to the headunit, car speakers may emit noise and interference may occur in transmission of signals sent from and received by the iPhone or iPhone 3G. (3) Although video may not be browsed via headunit, it may be displayed on the iPod itself. TV out needs to be On. Use iPod for the full video operation.
 Notes: *Some functions may be limited by the headunit, please refer to operation manual for details.
 *Some functions may be limited, depending on iPod software version. This chart is based on information valid as of November, 2008. Please ask your nearest dealer for the latest information.

Accessories for Portable Devices

CD-IU205V

NEW

Interface Cable for AVH-P5150DVD with iPod



CD-IU200V

NEW

USB Interface Cable for AVH-P4150DVD with iPod/iPhone



CD-IU50V

NEW

USB Interface Cable for AVH-P3150DVD and DVH-P4150UB with iPod/iPhone



CD-IU50

Interface Cable for iPod and iPhone

Optionally available for connecting an iPod to the DEH-P7150UB, DEH-6150BT, DEH-P5150UB, DEH-4150SD and FH-P6050UB.



CD-U50E

USB Extension Cable

50 cm cable optionally available for connecting a headunit with built-in USB port to an external USB device.



CD-IB100II

Interface Adapter for iPod



CD-UB100

IP-Bus USB Adapter



NOTE: Unauthorized copying of music is strictly prohibited. Not every device is compatible. See more details in Pioneer website. Compatible with USB device only. Not compatible with DRM (Digital Rights Management) contents and MTP (Media Transfer Protocol) connection players.

CD-BTB200/CD-BTB100

Bluetooth® Adapter



CD-BTB200

A/V Accessories

CD-RM10

AUX Input-Video

CD-V150M

Mini-Jack Cable for iPod

AN-G3

Diversity TV Antenna with Built-In Booster

CD-AB300

Optional AV-Bus Cable (3 m)

CD-AB50

Optional AV-Bus Cable (50 cm)

CD-AD600

Optional Optical Digital Cable (6 m)

CD-AD150

Optional Optical Digital Cable (1.5 m)

CD-VS33

Audio/Video Selector



Audio Accessories

CD-HF1

Hands-Free Kit
**Not available for CDMA system*



CD-IP150

Optional IP-Bus Extension Cable



CD-SR100

Steering Remote Controller



CD-RB10

RCA Bus Interconnector



RD-221

Power Supply Wiring Kit



RD-223

Optional Wiring Kit



RD-983

Alternator Noise Suppressor



RD-984

Alternator Noise Suppressor



RD-985

In-Line RCA Noise Suppressor



RD-SR520

High-Power Speaker Output to RCA Adapter



PURER PERFORMANCE FOR MAXIMUM PLEASURE

For the ultimate in-car sensation, Pioneer Reference Series (PRS) parts and components are engineered to meet the highest standards of performance and efficiency. Optical Digital Reference (ODR) and Pure Component Systems included in this series reproduce natural linear characteristics for sound as clear as a breath of fresh air.



Four Pioneer car audio products including the DEH-P80RSII and TS-D1720C won 2008 "Readers Choice" honors awarded by readers of Germany's renowned *autohifi* car audio magazine.



TS-C171PRS



PRS-D4200F



DEH-P80RSII



ODR (Optical Digital Reference) and RS Speaker Systems

RS-D7RII Component CD Receiver

Limited distribution



- High precision sound master clock circuitry
- Hi-quality CD drive
- Hi-bit conversion
- Digital direct
- Frequency change: 96 kHz to 44.1 kHz
- Source DVD control
- Digital optical input/output
- IP-Bus input/output
- External unit control via IP-Bus (2 units)
- AUX-in (with optional CD-RB20)
- White full dot OEL (Organic EL) display
- Auto-slide face
- Rotary volume (High quality feel is enhanced by using aluminum for the volume and cross key while adding spinning graved finish on it)
- Use of dual LED for button illumination (white or red selectable)
- Display off mode
- OFC power/ground cable
- Dual illumination (white or red selectable)



Red illumination

RS-P90 Universal Digital Pre-Amplifier

Limited distribution

DSP Hi-VOLT



- Advanced Segment 24-bit D/A Converter
- Digital listening position selector
- Time Alignment
- Parametric bass/treble control
- 31-band L/R independent graphic equalizer (1/3 oct.) with level control (± 12 dB/0.5 dB steps)
- 3-band L/R independent parametric equalizer (1/3 oct.) with level control (± 12 dB/0.5 dB steps)
- 4-way independent L/R crossover network (high/mid/low/subwoofer)
 - Crossover frequency: 20 Hz to 20,000 Hz (1/3 oct.)
 - Crossover slope: 0 dB to -72 dB
 - Crossover presets: 5
- Gold-plated 8-channel RCA output (high/mid/low/subwoofer)
- Gold-plated screw-type power/ground terminals
- The one-sided terminals and the square aluminum bonnet that rotates by every 90 degrees considered for installation
- High-performance 32-bit floating binary point type DSP

High-Precision Sound Master Clock Circuitry

RS-D7RII

The latest integrated circuits require superior clock signal quality to handle digital data accurately without distortion at ever-higher speeds. Dual independent Sound Master Clock Circuitry in the RS-D7RII generates clock waveforms to read and process digital signals with ultra-precision, and eliminate jitter noise in transmission. The result: extraordinarily clear, pure sound.



Clock circuit board

High-Performance SHARC® Digital Signal Processors

RS-P90

For remarkably precise 32-bit sound processing, the circuitry of the RS-P90 is mounted with three high-performance Analog Devices SHARC® DSPs, for left-channel, right-channel and coefficient calculation.



High-performance SHARC® DSP × 3

RS-A9

600 W Max.

Limited distribution

Digital Integrated Power Amplifier

- 50 W × 4 (4 Ω)/75 W × 4 (2 Ω)/50 W × 2 + 150 W × 1 (4 Ω)/150 W × 2 (4 Ω) (continuous power)
- 100 W × 4 (4 Ω)/100 W × 2 + 300 W × 1 (4 Ω)/300 W × 2 (4 Ω) (max. power)
- High-performance 32-bit floating binary point type DSP
- Built-in DSP (Digital Signal Processor) (FIR)
 - 31-band L/R independent digital graphic equalizer (±12 dB/0.5 dB steps)
 - 3-band L/R independent digital parametric equalizer (±12 dB/0.5 dB steps)
 - 5-mode preset memory
 - Time alignment
 - Digital listening position selector
 - Parametric bass/treble controls
 - Digital compression
 - 4-way L/R independent digital crossover network (high/mid/low/subwoofer)

DSP

- Crossover frequency: 20 Hz to 20,000 Hz (variable)
- Crossover slope: 0 dB to -72 dB
- 1 optical digital input
- 3 optical digital outputs (mid/low/subwoofer)



RS-A9



SHARC® DSP chip

RS-A7

600 W Max.

Limited distribution

Digital Power Amplifier

- 50 W × 4 (4 Ω)/75 W × 4 (2 Ω)/50 W × 2 + 150 W × 1 (4 Ω)/150 W × 2 (4 Ω) (continuous power)
- 100 W × 4 (4 Ω)/100 W × 2 + 300 W × 1 (4 Ω)/300 W × 2 (4 Ω) (max. power)
- 2 optical digital inputs

Common Features

- Bridgeable 4/3/2-channel capability
- Current feedback amplifier
- Full balanced system (bridgeable connection)
- Multi 24-bit Burr Brown D/A converters
- IP-Bus input/output
- Gold-plated screw-type speaker terminals

- Gold-plated large screw-type power/ground terminals
- Low load impedance capability (4 Ω, 2 Ω to 8 Ω allowable)
- Copper-plated chassis
- L/R independent power supply
- Sound master clock
- DAC volume

Caution: To avoid damaging your amplifier/subwoofer system, please make sure that the continuous power output of the amplifier is lower than the nominal power handling of the subwoofer.

TS-T01RSII

120 W Max.

3.5 cm Component Tweeter

- 3.5 cm tweeter with ion-plated DLC (Diamond-like Carbon)-coated dual arc ring diaphragm
- High-performance magnetic circuit features lightweight aluminum voice coil with neodymium magnet
- Zinc die-cast frame
- Tungsten cone holder with anti-resonance structure
- Aluminum die-cast mounting bracket included
- Gold-plated large screw-type terminals
- Use with UD-N01RSII 2-Way Passive Crossover Network
- Maximum input: 120 W
- Nominal input: 50 W



TS-S01RSII

50 W*/60 W** Max.

*With speaker unit only
**With back chamber

7.7 cm Component Midrange Speaker

- 7.7 cm cone midrange speaker with multiple pulp fiber composite diaphragm
- Ion-plated DLC (Diamond-like Carbon)-coated titanium center cap
- Corrugated surround with damped coating on front and back edges
- High-Transient Short Voice magnetic circuit features copper ribbon short voice coil with neodymium magnet
- Bottom hold design zinc die-cast one-piece chassis
- Tungsten damper holder with anti-resonance structure
- Zinc die-cast back basket
- Gold-plated large screw-type terminals
- Maximum input: 50 W*/60 W**
- Nominal input: 15 W



TS-M01RSII

120 W Max.

17 cm Component Mid-Bass Speaker

- 17 cm cone mid-bass speaker with multiple pulp fiber composite diaphragm
- Ion-plated DLC (Diamond-like Carbon)-coated titanium center cap
- Corrugated surround with damped coating on front and back edges
- High-Transient Short Voice magnetic circuit features copper ribbon short voice coil with neodymium magnet
- Bottom hold design zinc die-cast one-piece chassis
- Tungsten damper holder with anti-resonance structure
- Gold-plated large screw-type terminals
- Use with UD-N01RSII 2-Way Passive Crossover Network
- Maximum input: 120 W
- Nominal input: 50 W



TS-W01RSII

300 W Max.

25 cm (10") Component Subwoofer

- 25 cm cone woofer with multiple pulp fiber composite diaphragm and integrated center cap
- Space-saving small-enclosure-type design (recommended enclosure: 14 l to 28 l/0.49 cu.ft. to 0.99 cu.ft.)
- Corrugated fiber surround with damped coating on front and back edges
- Large-sized ø140 mm voice coil with multiple neodymium magnets
- Shallow mounting aluminum die-cast basket
- Gold-plated large screw-type terminals
- Maximum input: 300 W
- Nominal input: 150 W



▶ Large ø140 mm Voice Coil

TS-W01RSII

The TS-W01RSII's magnetic circuit structure uses a voice coil with large ø140 mm diameter to drive the center part of the entire speaker cone to improve transient.

Multiple neodymium magnets creating powerful magnetic flux help drive the cone with exceptional strength and accuracy.

The large vent in the center of the speaker back is maximized for fine control to reduce air resistance. The result: more accurate bass reproduction.

Compact Enclosure

We design our subwoofer cones for compact (14 to 28 liters) speaker enclosures.



Shallow mounting aluminum die-cast basket and large ø140 mm voice coil

▶ High-Quality Mid-Bass Speaker

TS-M01RSII

Ion-plated DLC (Diamond-like Carbon)-coated titanium center cap is superior in rigidity, and concave to suppress resonance in the magnetic circuit.

High-Transient Short Voice magnetic circuit achieves excellent sound linearity from high to mid-range and features a high number of turns of wire in the short lightweight voice coil (for voice coil drivability that is 15% better than its predecessor).

Corrugated surround with damped coating on front and back edge effectively absorbs unwanted vibration, achieves excellent linearity and reduces interference of cone and surround.



Corrugated surround

▶ Dual Arc Ring Tweeter Diaphragm

TS-T01RSII

The TS-T01RSII's Dual Arc Ring Diaphragm, based on Pioneer's Super Wide Range Tune innovation, reliably reproduces clear sound audible up to super-high 48 kHz frequency.

The inside and outside of the center drive-type ring diaphragm are shaped differently from each other, and vibrate to varying degrees for various frequencies. These

frequencies are mixed to achieve smooth characteristics for superior sound reproduction. The light diaphragm has a surface that is ion-plated with DLC (Diamond-like Carbon) coating for extra rigidity and minimal distortion. 35 mm in diameter, the diaphragm also contributes to excellent low frequency reproduction and precise, accurate sound staging.

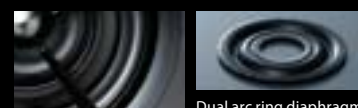

Dual arc ring diaphragm

HQ Active Component Systems

DEX-P90RS Component CD Receiver



- White full dot OEL (Organic EL) display
- Source DVD control
- Multi 24-bit D/A Converters with 8x oversampling digital filter
- Rotary volume
- Auto-slide face
- 3 gold-plated RCA pre-outs (front + rear + non-fading)
- Optical input/output
- External unit control via IP-Bus (2 units)
- AUX-In (with optional CD-RB20)
- High-quality hairline aluminum front panel
- Display off mode



DEQ-P90 Component Digital Signal Processor

DSP Hi-VOLT

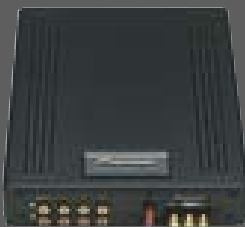

- Built-in DSP
- 31-band L/R independent digital equalizer
- 4-way independent L/R crossover network (high/mid/low/subwoofer)
- Optical input (with DEX-P90RS)
- Gold-plated 8-channel RCA output (high/mid/low/subwoofer)
- Gold-plated screw-type power/ground terminals

AXM-P90RS Audio Master Unit

Limited distribution



- High precision sound master clock circuitry
- Hi-bit conversion
- Frequency change: 96 kHz to 44.1 kHz
- Adapter ready for iPod
- Source DVD control
- 2 optical inputs & 1 optical output
- IP-Bus input/output
- 2 RCA audio inputs
- AUX-in for digital audio (TOS/Coaxial)
- External unit control via IP-Bus (2 units)
- White full dot OEL (Organic EL) display
- Display off mode
- Audio unit control (with DEQ-P90)



► Upgrade from Factory-Equipped to Pioneer Pure Audio Components

With a AXM-P90RS, a car's factory-equipped audio system can be upgraded for superior sound from various external devices. Use it with a DEQ-P90 for control and balance that Pioneer's advanced digital signal processing (DSP) provides.

AXM-P90RS Connection Example

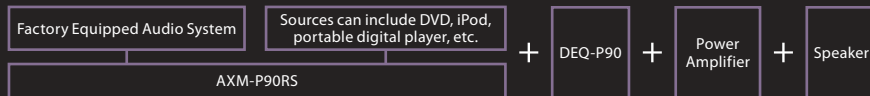

TS-W12PRS

30 cm (12") Component PRS Subwoofer
1,200 W Max.



- 30 cm (12") enclosure use subwoofer
- KEVLAR® Brand Fiber/pulp composite cone with integrated VCCS (Voice Coil Cooling System)
- Dual-layer rolled urethane surround
- Dual Voice Coil (DVC) design (2 x 4 Ω)
- 4-spoke aluminum die-cast basket
- Gold-plated binding posts
- Small enclosure capability
- Spoke grille compatible (UD-G308)
- Maximum input: 1,200 W
- Nominal input: 300 W

TS-M171PRS

17 cm Component PRS Mid-Bass Speaker
200 W Max.



- 3-layer aramid fiber with IMPP composite cone
- Heat-resistant ribbon voice coil
- High density micro fiber surround for smoother response
- Aluminum die-cast basket
- Gold-plated screw-type terminals
- Spoke grille included
- Maximum input: 200 W
- Nominal input: 50 W

TS-S101PRS

10 cm Component PRS Midrange Speaker
60 W Max.



- Dual layer cone with aramid and pulp
- High density micro fiber surround for smoother response
- Heat-resistant ribbon voice coil with neodymium magnet
- Glass cloth voice coil bobbin
- Aluminum die-cast basket
- Gold-plated screw-type terminals
- Spoke grille included (removable magnet cover for flexible mounting)
- Maximum input: 60 W
- Nominal input: 15 W

TS-T031PRS

28 mm Component PRS Soft-Dome Tweeter
200 W Max.



- 28 mm polyester soft-dome tweeter with dual neodymium magnet
- Heat-resistant voice coil
- Aluminum die-cast cabinet
- Gold-plated screw-type terminals
- Surface, flush or invisible tweeter mounting kit
- Maximum input: 200 W
- Nominal input: 50 W

► The Ultimate in Audio Tech

For Component Single-CD Player

Hi-Bit Conversion

The RS-D7RII and DEX-P90RS upgrade the original CD audio signals from 16-bit to 24-bit, and increase CD data resolution by a factor of 256. The result: lower quantization noise, expanded dynamic range, minimal processing error, and superior linearity, delivering sound as it was meant to be reproduced and heard.



For Digital Signal Processor

Time Alignment

Signal output of each speaker can be calibrated in 1/20,000-second* increments, for optimal phasing of sound from the system, according to listener position. Precise equalization and suppression of frequency response disturbance makes for a clearer, more focused soundstage.



*RS-A9: 1/40,000-second



DEQ-P90

Digital delay processing makes all speakers sound as if they are virtually equidistant from the listener, for a clearer, front-focused soundstage.

PRS-A900 4/3/2-Channel Bridgeable Power Amplifier

400 W Max.

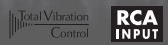

- 50 W x 4 (4 Ω)/100 W x 2 (4 Ω)/50 W x 2 + 100 W x 1 (4 Ω)/50 W x 4 (2 Ω) (continuous power)
- 100 W x 4 (4 Ω)/100 W x 2 + 200 W x 1 (4 Ω)/200 W x 2 (4 Ω) (max. power)
- Bridgeable 4/3/2-channel capability
- Current feedback amplifier
- L/R independent power supply

- L/R symmetric layout circuit
- Input level/gain control (400 mV to 6.5 V) (L/R independent)
- Low load impedance capability (4 Ω, 2 Ω to 8 Ω allowable)
- Gold-plated RCA input terminals
- Gold-plated large block-type speaker terminals

- Gold-plated large block-type power/ground terminals
- High-performance balanced isolator circuit
- Multi Emitter Bipolar Transistor
- TVC (Total Vibration Control) technology



TVC (Total Vibration Control) Technology

For superior sound quality across a wide spectrum, Pioneer's TVC (Total Vibration Control) technology thoroughly suppresses vibration from parts and mechanisms that can interfere with sound.



H-Shaped Chassis



Stabilizes the amplifier and it's internal componentry by absorbing outer vibration with superior speed.

Left and Right Channel Independent Power Supply



L/R symmetric circuit layout improves channel separation.

PRS-D2000SPL

4,000 W Max.

Class-D Mono Amplifier



- 750 W x 1 (4 Ω)/1,500 W x 1 (2 Ω)/2,000 W x 1 (1 Ω) (continuous power)
- 1,500 W x 1 (4 Ω)/3,000 W x 1 (2 Ω)/4,000 W x 1 (1 Ω) (max. power)

- 0/1-gauge, large block-type gold-plated power/ground terminals

SPL champion edition

The pride of a winner takes world-leading DNA

PRS-D1200SPL

2,400 W Max.

Class-D Mono Amplifier



- 500 W x 1 (4 Ω)/1,000 W x 1 (2 Ω)/1,200 W x 1 (1 Ω) (continuous power)
- 1,000 W x 1 (4 Ω)/2,000 W x 1 (2 Ω)/2,400 W x 1 (1 Ω) (max. power)

- 4-gauge, large block-type gold-plated power/ground terminals
- PWM regulated power supply with MOSFET switching



PRS-D2000SPL

Common Features

- Variable LPF (40 Hz to 240 Hz, -24 dB/oct)
- Input level control (400 mV to 6.5 V)
- Low load impedance capability (1 Ω to 8 Ω)
- Gold-plated RCA input and output terminals

- 4-gauge, large block-type gold-plated speaker terminals
- Variable Bass Boost Remote (40 Hz to 120 Hz, 0 dB to +12 dB)
- Subsonic filter (20 Hz, -24 dB/oct)
- SYNC control

- High-performance balanced isolator circuit
- High-efficiency MOSFET output section
- MASS (Multiple Amplifier Synchronization System)
- Removable terminal/settings cover

Class-D Amplifiers

- PRS-D2000SPL
- PRS-D1200SPL
- PRS-D1200M
- GM-DB400M
- GM-D7400M

Class-D amplifiers overcome the inefficiencies of traditional Class-A or AB amplifiers. Pioneer's Class-D amps transform very little power into heat while a very high percentage of the power supply (67 %) is transformed into the load. This results in a very compact amp which needs little input power to produce very high output power.

signal which has a much higher fixed frequency. The result is a digital signal which contains the input signal and a band of frequency components around the modulation frequency. A LPF (Low Pass Filter) will then filter out the high frequency pulses and the resulting amplified output signal is then sent to the subwoofer and/or speakers.

The Class-D amplifier's PWM (Pulse Width Modulator) modulates the original audio input signal with another

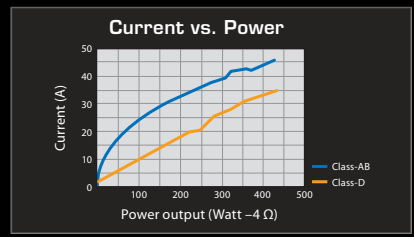

MASS (Multiple Amplifier Synchronization System) Connection Examples

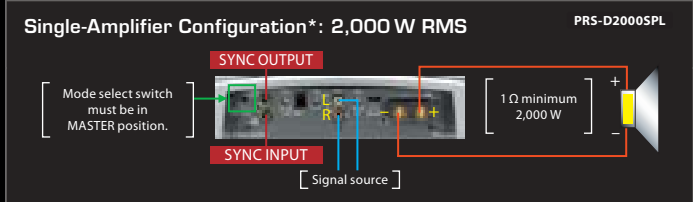

With the PRS-D2000SPL, PRS-D1200SPL and PRS-D1200M's SYNC connection, adjustment of the master amplifier also adjusts all other amplifiers in the cascade. This makes control simpler and more convenient.

*These are only a few examples of connection configurations for the PRS-D2000SPL. Ask your nearest car stereo installer or dealer about power/ground wiring and installation details for the PRS-D2000SPL, PRS-D1200SPL and PRS-D1200M.

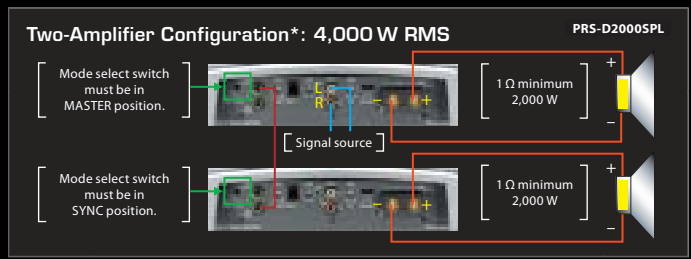
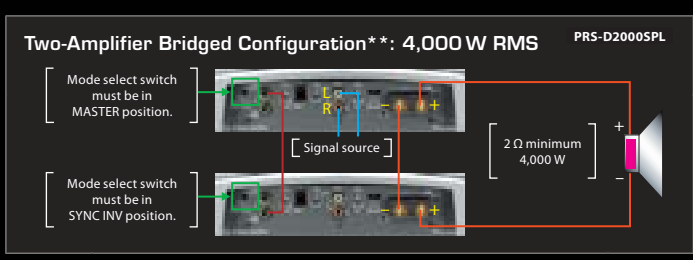

- Orange: Wiring for speaker must be 10 AWG minimum.
- Yellow: Load may be any combination of speakers but impedance must be 1 Ω or larger.
- Pink: Load may be any combination of speakers but impedance must be 2 Ω or larger.

*1 Ω minimum speaker impedance for this configuration or damage will occur.
 **2 Ω minimum speaker impedance for this configuration or damage will occur.
 Caution: Having more than four amps in a sync configuration is not recommended. Sine waves can put excessive stress on an audio system, so if a sine wave source is used at high output level, damage can occur.

Caution: To avoid damaging your amplifier/subwoofer system, please make sure that the continuous power output of the amplifier is lower than the nominal power handling of the subwoofer.

Reference Sound Systems

DEH-P80RSII Component CD Player/Receiver



High-quality Burr Brown D/A converter



- White full dot OEL (Organic EL) display
- Adapter ready for iPod
- USB adapter ready (external unit control)
- Bluetooth* adapter ready (external unit control)
- Burr Brown advanced segment-type 24-bit D/A Converter
- Built-in DSP
 - EQ
 - Auto EQ
 - Auto EQ for 3-way network
 - Auto time alignment
 - BBE® digital sound processing
 - Digital listening position selector
 - BMX (Bitmetric Equalizer)
 - L/R independent 16-band digital graphic equalizer
 - L/R independent 2-way crossover: HPF/LPF
 - L/R independent 3-way crossover: high/mid/low
 - 3-way digital network
- Auto-slide face
- Rotary Commander
- 3 gold-plated RCA pre-outs (front + rear + subwoofer)
- Level indicator (L/R independent)
- Spectrum analyzer
- Multi-language display (English/Spanish/Portuguese)

PRS-D4200F Class-FD 4/3/2-Channel Bridgeable Amplifier

1,200 W Max.



- 75 W × 4 (4 Ω)/300 W × 2 (4 Ω)/75 W × 2 + 300 W × 1 (4 Ω)/150 W × 4 (2 Ω) (continuous power)
- 150 W × 4 (4 Ω)/150 W × 2 + 600 W × 1 (4 Ω)/600 W × 2 (4 Ω) (max. power)
- Bridgeable 4/3/2-channel capability



PRS-D4200F

PRS-D2200T Class-FD 2/1-Channel Bridgeable Amplifier

1,200 W Max.



- 150 W × 2 (4 Ω)/600 W × 1 (4 Ω)/300 W × 2 (2 Ω) (continuous power)
- 300 W × 2 (4 Ω)/1,200 W × 1 (4 Ω) (max. power)
- Bridgeable 2/1-channel capability
- Bass Boost Remote (50 Hz, 0 dB/+6 dB/+9 dB/+12 dB)



Gold-plated large block-type power/ground terminals



Gold-plated RCA input/output terminals

Common Features

- Variable LPF/HPF (40 Hz to 500 Hz, -12 dB/oct.)
- Input level control (400 mV to 6.5 V)
- Low load impedance capability (4 Ω, 2 Ω to 8 Ω allowable)
- Gold-plated RCA input and output terminals
- Gold-plated large block-type speaker terminals
- Gold-plated large block-type power/ground terminals
- All terminals placed on one side
- Removable terminal/settings cover
- Speaker level input (1.6 V to 26 V)
- Speaker line input turn-on sensor
- High-performance balanced isolator input circuit
- High-efficiency MOSFET output section
- TVC (Total Vibration Control) technology

Class-FD ICEpower Amplifiers

Class FD ice power

PRS-D4200F PRS-D2200T

Pioneer brings together its cutting-edge Class-D circuitry and ICEpower digital amplifier technology to create Class-FD (Full Range Class-D) ICEpower amplifiers that deliver superior performance and sound quality in car entertainment. Combining the unsurpassed efficiency of Class-D amps with the ultra-clean sound of Class-AB amplifiers, COM (Controlled Oscillation Modulation) technology not only eliminates unnecessary sensitivity to imperfect power supplies [1]—it compares the amplified PWM (Pulse Width Modulation) signal with the original input signal [2], compensating for any variance and lowering distortion in the process. MECC (Multivariable Enhanced Cascade Control) compensating for load-dependent frequency response, improving this response as this system receives analog signals from the output filter [3]. The result

is truer fidelity featuring tight bass with minimal lag effect; crisp, airy mids and highs; and unsurpassed specifications contributing to qualities that outperform those of other premium-quality amplifiers.

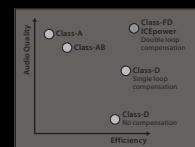
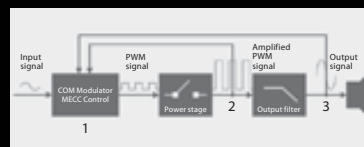

PRS-D1200M Class-D Mono Amplifier

1,200 W Max.



- Normal mode: 400 W × 1 (4 Ω)/600 W × 1 (2 Ω) (continuous power)
- Hi-current mode: 150 W × 1 (4 Ω)/300 W × 1 (2 Ω)/600 W × 1 (1 Ω) (continuous power)
- 800 W × 1 (4 Ω)/1,200 W × 1 (2 Ω) (max. power)
- Single-ended output circuit
- Variable LPF (40 Hz to 240 Hz, -18 dB/oct.)
- Input level control (400 mV to 6.5 V)
- Low load impedance capability (1 Ω to 8 Ω)
- Gold-plated RCA input and output terminals
- Gold-plated large block-type speaker terminals
- Gold-plated large block-type power/ground terminals
- All terminals placed on one side
- Removable terminal/settings cover
- Speaker level input (1.6 V to 26 V)
- Speaker line input turn-on sensor
- Bass Boost Remote (50 Hz, 0 dB/+6 dB/+9 dB/+12 dB)
- Subsonic filter (20 Hz, -18 dB/oct.)
- SYNC control
- High-performance balanced isolator input circuit
- High-efficiency MOSFET output section
- MASS (Multiple Amplifier Synchronization System)
- TVC (Total Vibration Control) technology

GET CLOSER TO NATURE— NEW OPEN & SMOOTH SOUND

With their extra-wide directivity, low tweeter crossover frequency and distortion, plus light, rigid IMPP cones, Pioneer's PRS speakers realize a level of in-car audio quality that deserves its own name: "Open & Smooth" sound—a wide-open sound staging, rich, natural midrange and tweeter output with outstanding smoothness and linearity.



Superior Directivity: Pioneer PRS Speakers

Pioneer PRS speakers always maintain more open, smooth, expansive, multidimensional sound, without the dramatic dips and inconsistencies that lesser speakers can produce when angled in certain directions.

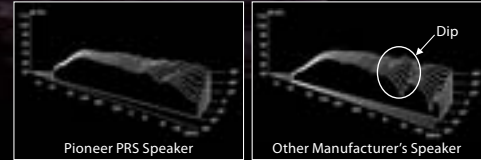

Rear view

TS-C171PRS

200 W Max.

17 cm Packaged Component Speaker System

- 17 cm woofer
- 28 mm lightweight soft-dome tweeter
- Shallow mount adapters included

- Maximum input: 200 W
- Nominal input: 50 W



Common Features

- 3-layer aramid fiber with IMPP composite cone
- High density micro fiber surround for smoother response
- Short voice coil & wide magnetic field design for symmetric & linear cone motion
- Dual OFC short ring for reduced distortion
- Aluminum die-cast bottom hold one-piece rigid chassis
- Aluminum die-cast center plug
- Cancel magnet design for extremely high density magnetic field
- Rear chamber for lower crossover frequency
- Aluminum die-cast tweeter chassis

TS-C131PRS

150 W Max.

13 cm Packaged Component Speaker System

- 13 cm woofer
- 28 mm lightweight soft-dome tweeter

- Maximum input: 150 W
- Nominal input: 30 W



TS-C171PRS/TS-C131PRS Tweeter Specifications

- Dimensions (W x H x D): ø55 mm x 27.1 mm (surface mount)
- Mounting depth: 12.2 mm
- Cut-out dimensions: ø47 mm

* See page 63 for woofer dimensions.

► PRS Speakers

- TS-C171PRS
- TS-C131PRS
- TS-M171PRS
- TS-S101PRS
- TS-T031PRS

Pioneer advances the proud heritage of its IASCA (International Auto Sound Challenge Association) award-winning Premier Reference Series. These speakers' superior response, linearity and sound directivity improve low- and mid-frequency reproduction, while making highs and lows sound smoother and more open.

PRS Speaker (Tweeter) Cross Section

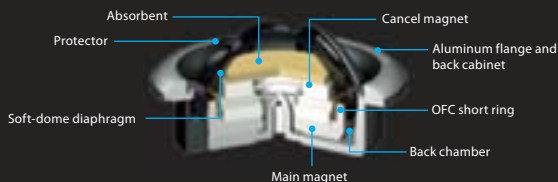

Micro Fiber Surround: Maximum Musical Response

The strong, high-density micro fiber material surrounding the woofer of a PRS speaker is very light and low in resistance and internal loss characteristics. This enhances linearity of the short winding length of the voice coil, thereby optimizing efficiency. Moreover, micro fiber doesn't stretch so it does a better job than other materials to control vibration and enables higher power input. The result is faster response and more accurate bass reproduction that allows all music to be heard to greatest advantage.

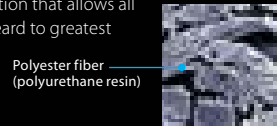

Magnified cross section view

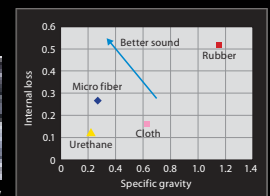

PRS Speaker (Woofer) Cross Section

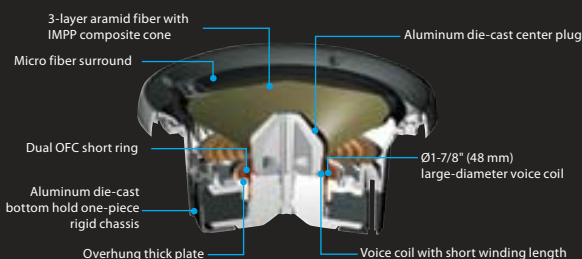

2nd-Generation Multilayer Cone: First-Class Sound Reproduction

For the PRS speakers, Pioneer also developed a multilayer woofer cone in an even better formulation, sandwiching composite foamed IMPP using interlaced aramid fiber between a woven carbon-blended aramid fiber layer and a glass fiber layer. This rigid cone structure provides impeccable midrange frequency reproduction and overall sound quality. The cone material is also supremely light and uniform in its physical properties because it is made without adhesives using an advanced injection molding process.

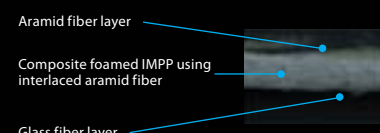

Magnified cross section view

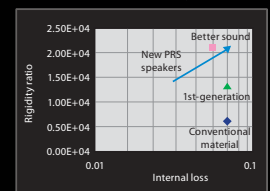

Physical properties of cone materials

PUNCH UP THE POWER, DIVE IN DEEP

It's sensational how such compact components can create such massive impact. Pioneer's Class-D digital amplifiers keep every sound pristine, and perfectly match subs that inherit Pioneer's championship-winning SPL technology to generate punchy, nicely damped bass with the help of light, rigid Basalt/Carbon fiber reinforced IMPP cones.



PRS-D2000SPL



Scott Owens, team leader of the Pioneer/Edge Audio team



Regional
2007 1st Place dB Drag Extreme 5+ Class (178.9 dB)
National
2007 1st Place dB Drag Extreme 5+ Class (179.5 dB)
World
2007 1st Place dB Drag Extreme 5+ Class (178.9 dB)



World Record
1st Place Super Modified 4001 - 8000 (177.7 dB)
1st Place Super Modified 8001 - UP (181.1 dB)
1st Place Port Wars (181.2 dB)
1st Place Bass Olympics (174.9 dB)



2007 1st Place iDBL Ultimate 1 Class (176.2 dB)
2007 1st Place iDBL Ultimate 3 Class (178.2 dB)

TS-W5102SPL





GM-6400F

600 W Max.

NEW

4/3/2-Channel Bridgeable Power Amplifier

LPF **HPF** **RCA IN/OUT** **SPEAKER INPUT**

- 60 W × 4 (4 Ω)/60 W × 2 + 150 W × 1 (4 Ω)/150 W × 2 (4 Ω)/75 W × 4 (2 Ω) (continuous power)
- 120 W × 4 (4 Ω)/120 W × 2 + 300 W × 1 (4 Ω)/300 W × 2 (4 Ω) (max. power)
- Bridgeable 4/3/2-channel capability

- LPF/HPF (80 Hz, -12 dB/oct.) for A and B channels
- RCA input and output terminals*

*Output for A-channel



GM-6400F

GM-5400T

760 W Max.

NEW

2/1-Channel Bridgeable Power Amplifier

LPF **RCA INPUT** **SPEAKER INPUT** **Bass Boost**

- 125 W × 2 (4 Ω)/380 W × 1 (4 Ω)/190 W × 2 (2 Ω) (continuous power)
- 250 W × 2 (4 Ω)/760 W × 1 (4 Ω) (max. power)
- Bridgeable 2/1-channel capability

- LPF (80 Hz, -12 dB/oct.)
- RCA input terminals
- Bass Boost (50 Hz, 0 dB/+6 dB/+12 dB)

Common Features

- Input level control (200 mV to 6.5 V)
- Input level/gain control
- Low load impedance capability (4 Ω, 2 Ω to 8 Ω allowable)
- Screw-type speaker terminals
- Large screw-type power/ground terminals
- Speaker level input (1.6 V to 26 V)
- PWM regulated power supply with MOSFET switching

- High-performance balanced isolator circuit
- Black metallic mesh with silver plate

Gain Control

ALL POWER AMPLIFIERS* *Except RS-A9 and RS-A7

The Pioneer GM analog amplifiers are all equipped with the Gain Control, a protective function that prevents malfunction of the unit itself, as well as the speakers, caused by too much output, improper use and improper connection. Even when the amplifiers are connected to the headunits with high-voltage pre-outs, the signal is not clipped or distorted if the gain control is set to proper position, so high S/N (Signal-to-Noise) ratio is realized in the speaker level signal. To ensure continuous audio output, the amplifier's gain control must be set according to the pre-out maximum output level of the headunit. There is no need to decrease the volume of the headunit, as too much output will be controlled.

Gain control of the unit (GM-6400F)

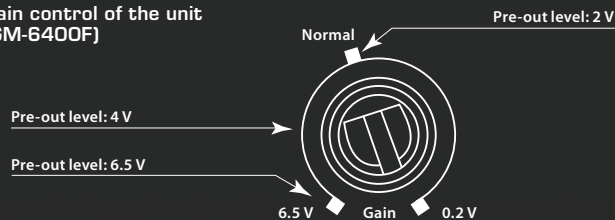

GM-3300T

300 W Max.

2/1-Channel Bridgeable Power Amplifier

LPF **RCA INPUT** **SPEAKER INPUT**

- 60 W × 2 (4 Ω)/150 W × 1 (4 Ω)/75 W × 2 (2 Ω) (continuous power)
- 120 W × 2 (4 Ω)/300 W × 1 (4 Ω) (max. power)
- Bridgeable 2/1-channel capability
- LPF (80 Hz, -12 dB/oct.)

- High-voltage input level control (400 mV to 6.5 V)
- Input level/gain control
- Low load impedance capability (4 Ω, 2 Ω to 8 Ω allowable)
- RCA input terminals

- Screw-type speaker terminals
- Large screw-type power/ground terminals
- Speaker level input (1.6 V to 26 V)
- High-performance balanced isolator circuit
- Black heatsink with aluminum plate



GM-D8400M

1,200 W Max.

Class-D Mono Amplifier

LPF **RCA INPUT** **SPEAKER INPUT** **Bass Boost**

- 300 W x 1 (4 Ω)/600 W x 1 (2 Ω) (continuous power)
- 600 W x 1 (4 Ω)/1,200 W x 1 (2 Ω) (max. power)
- Bass Boost Remote (50 Hz, 0 dB to 12 dB variable)

Common Features

- Single-ended output circuit
- Variable LPF (40 Hz to 240 Hz, -12 dB/oct.)
- Input level/gain control (200 mV to 6.5 V)

- Low load impedance capability (4 Ω, 2 Ω to 8 Ω allowable)
- RCA input terminals
- Large block-type speaker terminals
- Large block-type power/ground terminals

GM-D7400M

800 W Max.

Class-D Mono Amplifier

LPF **RCA INPUT** **SPEAKER INPUT** **Bass Boost**

- 200 W x 1 (4 Ω)/400 W x 1 (2 Ω) (continuous power)
- 400 W x 1 (4 Ω)/800 W x 1 (2 Ω) (max. power)
- Bass Boost (50 Hz, 0 dB/+6 dB/+12 dB)

- Speaker level input (0.8 V to 26 V)
- Speaker line input turn-on sensor
- High-performance balanced isolator circuit
- High-efficiency MOSFET output section
- Black heatsink with aluminum plate



GM-D8400M

Same Powerful Output from a More Compact Amplifier

- PRS-D2000SPL PRS-D1200SPL PRS-D1200M
GM-D8400M GM-D7400M

A Class-D amp matches a more power-hungry conventional amp's output, but emits less heat. For better sound quality and safer, more stable amplification power, Pioneer designed their Class-D amp circuitry to provide 2 Ω output that is twice as powerful as 4 Ω output from less efficient amplifiers.

100 % of the Power, 45 % of the Size

The superior efficiency of a Class-D amplifier means higher power output and greater compactness than an analog amplifier offers.

Conventional Model (GM-7300M)



GM-D7400M

RD-223 Power Cable

• For use with amplifier with screw terminal (30 A)

RD-226 Power Cable

• For use with amplifier with screw terminal (60 A)

RD-228 Power Cable

• For use with amplifier with block terminal

Amplifier & Speaker Connection Examples

GM-6400F Continuous Power: 60 W x 4 (4 Ω)/60 W x 2 + 150 W x 1 (4 Ω)/150 W x 2 (4 Ω)/75 W x 4 (2 Ω)
Max. Power: 120 W x 4 (4 Ω)/120 W x 2 + 300 W x 1 (4 Ω)/300 W x 2 (4 Ω)

150 W 4 Ω TS-W308D2
150 W 4 Ω TS-W308D2

GM-5400T Continuous Power: 125 W x 2 (4 Ω)/380 W x 1 (4 Ω)/190 W x 2 (2 Ω)
Max. Power: 250 W x 2 (4 Ω)/760 W x 1 (4 Ω)

380 W 4 Ω TS-W308D2

GM-6400F Continuous Power: 60 W x 4 (4 Ω)/60 W x 2 + 150 W x 1 (4 Ω)/150 W x 2 (4 Ω)/75 W x 4 (2 Ω)
Max. Power: 120 W x 4 (4 Ω)/120 W x 2 + 300 W x 1 (4 Ω)/300 W x 2 (4 Ω)

150 W 4 Ω TS-W308D2
60 W Rear Speaker TS-A6983S
60 W Rear Speaker TS-A6983S

GM-5400T Continuous Power: 125 W x 2 (4 Ω)/380 W x 1 (4 Ω)/190 W x 2 (2 Ω)
Max. Power: 250 W x 2 (4 Ω)/760 W x 1 (4 Ω)

380 W 8 Ω TS-W308D4
8 Ω TS-W308D4

Amplifier & Subwoofer Connection Chart

Dual Voice Coil ●: DVC parallel wiring ○: DVC series wiring **Single Voice Coil** (2 pc.: 2 pieces use) ■: Single voice coil Para: Parallel wiring Series: Series wiring

| Product No. | Channel | Load Impedance | Continuous Power | Subwoofers | | | | | | | | | | Shallow Subwoofers | | | | | | | | |
|-------------|---------|----------------|------------------|---------------------|------------|-----------------|-----------|-----------|-----------|------------|------------|-------------|--------------|--------------------|--------------|--------------|------------|------------|------------|------------|---|----------|
| | | | | Champion Series-PRO | | Champion Series | | | | TS-W302R | | | | TS-SW3001S4 | | TS-SW2501S2 | | TS-SW841D | | TS-SW301 | | TS-SW251 |
| | | | | TS-W3002D4 | TS-W2502D4 | TS-W308D2 | TS-W308D4 | TS-W258D2 | TS-W258D4 | TS-W302R | TS-W252R | TS-SW3001S4 | TS-SW3001S2 | TS-SW2501S4 | TS-SW2501S2 | TS-SW841D | TS-SW301 | TS-SW251 | | | | |
| PRS-D4200F | 4-ch. | 2 Ω | 150 W x 4 | ● | ● | 2 pc. ● | ● | 2 pc. ● | ● | 2 pc. Para | 2 pc. Para | 2 pc. Para | ■ | 2 pc. Para | ■ | 2 pc. Para | 2 pc. Para | 2 pc. Para | ■ | ■ | ■ | ■ |
| | | 4 Ω | 75 W x 4 | 2 pc. ● | 2 pc. ● | ○ | 2 pc. ● | ○ | 2 pc. ● | ■ | ■ | ■ | ■ | 2 pc. Series | ■ | 2 pc. Series | ■ | ■ | ■ | ■ | ■ | ■ |
| PRS-D2200T | 2-ch. | 2 Ω | 300 W x 2 | ● | ● | 2 pc. ● | ● | 2 pc. ● | ● | 2 pc. Para | — | 2 pc. Para | ■ | 2 pc. Para | — | — | 2 pc. Para | 2 pc. Para | ■ | ■ | ■ | ■ |
| | | 4 Ω | 150 W x 2 | 2 pc. ● | 2 pc. ● | ○ | 2 pc. ● | ○ | 2 pc. ● | ■ | ■ | ■ | ■ | 2 pc. Series | ■ | 2 pc. Series | ■ | ■ | ■ | ■ | ■ | ■ |
| PRS-D1200M | 1-ch. | 4 Ω | 600 W x 1 | 2 pc. ● | 2 pc. ● | — | 2 pc. ● | — | 2 pc. ● | — | — | — | — | 2 pc. Series | ■ | 2 pc. Series | ■ | ■ | ■ | ■ | ■ | ■ |
| | | 1 Ω | 600 W x 1 | 2 pc. ● | 2 pc. ● | — | 2 pc. ● | — | 2 pc. ● | — | — | — | — | 2 pc. Para | — | 2 pc. Para | — | — | — | — | — | — |
| GM-D8400M | 1-ch. | 2 Ω | 600 W x 1 | ● | ● | 2 pc. ● | — | 2 pc. ● | — | — | — | — | ■ | 2 pc. Series | — | 2 pc. Series | — | — | — | — | — | — |
| | | 4 Ω | 300 W x 1 | 2 pc. ● | 2 pc. ● | ○ | 2 pc. ● | ○ | 2 pc. ● | — | — | — | ■ | 2 pc. Series | ■ | 2 pc. Series | — | — | — | — | — | — |
| GM-D7400M | 1-ch. | 2 Ω | 400 W x 1 | ● | ● | 2 pc. ● | — | 2 pc. ● | — | — | — | — | ■ | 2 pc. Para | ■ | 2 pc. Para | — | — | 2 pc. Para | 2 pc. Para | ■ | ■ |
| | | 4 Ω | 200 W x 1 | 2 pc. ● | 2 pc. ● | ○ | 2 pc. ● | ○ | 2 pc. ● | — | — | — | ■ | 2 pc. Series | ■ | 2 pc. Series | — | — | ■ | ■ | ■ | ■ |
| GM-6400F | 4-ch. | 2 Ω | 75 W x 4 | ● | ● | 2 pc. ● | ● | 2 pc. ● | ● | 2 pc. Para | 2 pc. Para | 2 pc. Para | ■ | 2 pc. Para | ■ | 2 pc. Para | 2 pc. Para | 2 pc. Para | ■ | ■ | ■ | ■ |
| | | 4 Ω | 60 W x 4 | 2 pc. ● | 2 pc. ● | ○ | 2 pc. ● | ○ | 2 pc. ● | ■ | ■ | ■ | ■ | 2 pc. Series | ■ | 2 pc. Series | ■ | ■ | ■ | ■ | ■ | ■ |
| GM-5400T | 2-ch. | 2 Ω | 190 W x 2 | ● | ● | 2 pc. ● | ● | 2 pc. ● | ● | 2 pc. Para | 2 pc. Para | 2 pc. Para | ■ | 2 pc. Para | ■ | 2 pc. Para | 2 pc. Para | 2 pc. Para | ■ | ■ | ■ | ■ |
| | | 4 Ω | 125 W x 2 | 2 pc. ● | 2 pc. ● | ○ | 2 pc. ● | ○ | 2 pc. ● | ■ | ■ | ■ | ■ | 2 pc. Series | ■ | 2 pc. Series | — | — | ■ | ■ | ■ | ■ |
| GM-3300T | 2-ch. | 2 Ω | 75 W x 2 | ● | ● | 2 pc. ● | ● | 2 pc. ● | ● | 2 pc. Para | 2 pc. Para | 2 pc. Para | ■ | 2 pc. Para | ■ | 2 pc. Para | 2 pc. Para | 2 pc. Para | ■ | ■ | ■ | ■ |
| | | 4 Ω | 60 W x 2 | 2 pc. ● | 2 pc. ● | ○ | 2 pc. ● | ○ | 2 pc. ● | ■ | ■ | ■ | ■ | 2 pc. Series | ■ | 2 pc. Series | ■ | ■ | ■ | ■ | ■ | ■ |
| | 1-ch. | 2 Ω | 150 W x 1 | 2 pc. ● | 2 pc. ● | ○ | 2 pc. ● | ○ | 2 pc. ● | — | — | ■ | 2 pc. Series | ■ | 2 pc. Series | — | — | ■ | ■ | ■ | ■ | ■ |
| | | 4 Ω | 75 W x 1 | 2 pc. ● | 2 pc. ● | ○ | 2 pc. ● | ○ | 2 pc. ● | — | — | ■ | 2 pc. Series | ■ | 2 pc. Series | — | — | ■ | ■ | ■ | ■ | ■ |

Caution: To avoid damaging your amplifier/subwoofer system, please make sure that the continuous power output of the amplifier is lower than the nominal power handling of the subwoofer.

Component SPL Subwoofers

SPL champion edition

The pride of a winner takes world-leading DNA



TS-W8102SPL

8,000 W Max.

38 cm (15") Component Competition-Level SPL Subwoofer



- Massive triple-stack magnet assembly (11 kg: 3,700 g x 3/390 oz.: 8 lbs. 20 oz. x 3)
- Maximum input: 8,000 W
- Nominal input: 3,000 W

TS-W5102SPL

6,000 W Max.

30 cm (12") Component Competition-Level SPL Subwoofer



- Massive triple-stack magnet assembly (9 kg: 3,000 g x 3/320 oz.: 6 lbs. 10 oz. x 3)
- Maximum input: 6,000 W
- Nominal input: 2,500 W

Common Features

- Composite IMPP cone using interlaced carbon fiber*
- Carbon cloth/foamed acrylic polymer/glass cloth 3-layer rigid dust cap
- Wide-roll, woven aramid fiber radial rubber surround*
- Overhung surround design*
- High-power handling ceramic-coated voice coil wire*
- Dual 76 mm (3"), high inductance, 6-layer, long voice coils (DVC) (2 x 2 Ω)
- Titanium voice coil bobbin
- Dual aramid damper with woven tinsel wire and damper ring
- Precision dual aramid dampers
- Huge back plate and extended pole yoke with vented pole
- Huge 30 mm (1.2") thick top plate
- ADMG (Aero-Dynamic Magnetic Gap) design
- Aluminum die-cast one-piece rigid basket with bottom hold design
- 8-gauge wire terminal

* Patent pending

► SPL (Sound Pressure Level) Subwoofer

TS-W8102SPL TS-W5102SPL

To generate resounding bass, the TS-W8102SPL and TS-W5102SPL subwoofers handle high-power input and extreme sound pressure levels with absolute assurance, thanks to design and construction durable enough to deliver consistently true, rock-steady performance, even at extra-high volume throughout marathon listening sessions.

Dual Ceramic-Coated Voice Coils

Excess heat generated by subwoofers can compromise electrical-handling performance, but Pioneer uses ceramic-coated voice coil to double the capacity of its subwoofers to handle input power without short-circuiting. No wonder the Pioneer TS-W5102SPL beat the competition at 2005, 2006 and 2007 dB Drag Racing events.

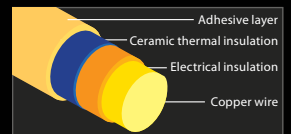

TS-W5102SPL Cross Section

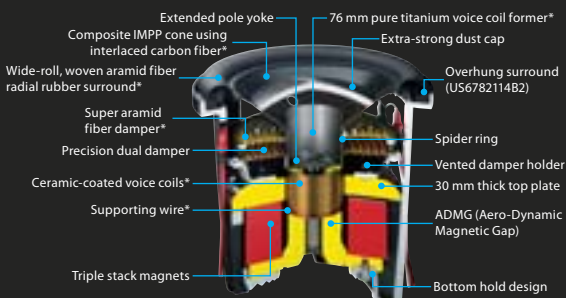

* Patent pending

Extra-Strong Dust Cap Core with Foamed Acrylic Polymer

Dust caps on the TS-W8102SPL and TS-W5102SPL subwoofers feature a light, durable heat-resistant foamed acrylic polymer core (between carbon-fiber and glass cloth layers) that is up to about 36 times as strong as conventional materials. The result: greater capacity for extra sound pressure, stability and power in bass reproduction.

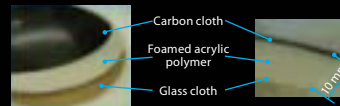

Champion series - PRO

The pride of a winner takes world-leading DNA



TS-W3002D4

3,500 W Max.

NEW

30 cm (12") Component Subwoofer

- Double stack high power magnets (3,230 g/114 oz.)
- Spoke grille compatible (UD-G308)
- Maximum input: 3,500 W
- Nominal input: 1,000 W



TS-W2502D4

3,000 W Max.

NEW

25 cm (10") Component Subwoofer

- Double stack high power magnets (2,490 g/88 oz.)
- Spoke grille compatible (UD-G258)
- Maximum input: 3,000 W
- Nominal input: 800 W



Common Features

- Interlaced Basalt/Carbon fiber reinforced IMPP cone
- Wide-roll, 3-layer fiber woven aramid radial surround with honeycomb cloth
- Phenol coated glass cloth former
- Air Suspension System
- Dual 4 Ω, 4-layer, long voice coil (2 Ω or 8 Ω)
- Extended and vented pole yoke
- Aluminum die-cast basket & magnet cover

Air Suspension System



- TS-W3002D4
- TS-W2502D4
- TS-SW3001S4
- TS-SW3001S2
- TS-SW2501S4
- TS-SW2501S2
- TS-SW841D
- TS-SW301
- TS-SW251

For its revolutionary 3.25-inch-deep subwoofer, Pioneer created an air suspension system effective within a 70% smaller-than-previous enclosure that locks air for a spring-like effect between main and drive cones moving in unison. The result is consistently clear, powerful, wide-ranging bass response. The subwoofer's dual-cone structure maintains better sound linearity and reliability after hours of hard use than conventional subwoofers with "spider" structures to keep the voice coil aligned.

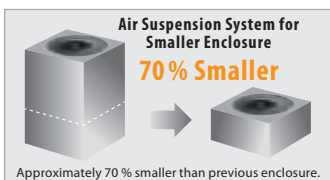

Bottom Hold Design Aluminum Die-Cast One-Piece Chassis

- TS-C171PRS
- TS-C131PRS
- TS-W8102SPL
- TS-W5102SPL

Although aluminum die-cast baskets have been around for many years, not all are created equal. Whereas other manufacturers purchase off-the-shelf designs, Pioneer's baskets were designed in-house, from scratch. Die-cast baskets also provide excellent damping characteristics, to attenuate vibration quickly and prevent distortion.

Unlike other manufacturers' designs, Pioneer's basket cradles the bottom plate and motor assembly. During high SPL levels there is a tremendous amount of pressure placed on the motor assembly.

By supporting (cradling) the motor assembly any unwanted flexing or vibrations which can lead to energy loss are prevented.

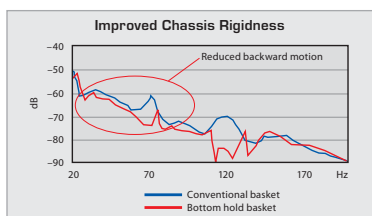
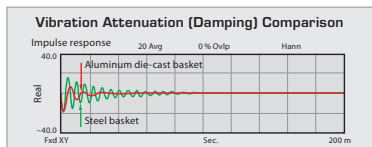

Carbon Fiber IMPP Cone



- TS-W8102SPL
- TS-W5102SPL

Preventing cone failure at high pressure levels requires an extremely rigid yet lightweight cone. So Pioneer developed a patent-pending IMPP cone using a proprietary composite blend of long carbon fibers and injection molded polypropylene. These materials were chosen for their extraordinary strength and lightweight characteristics. The long carbon fibers interlace together to form an incredibly resilient fiber weave, providing strength and rigidity for powerful bass.

Microscopic Cross Section View

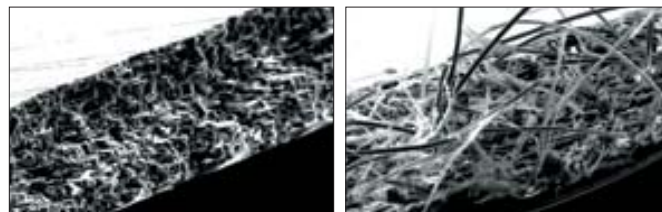

Regular IMPP cone

Long carbon fiber reinforced IMPP cone

Woven Aramid Fiber Radial Surround

- TS-W8102SPL
- TS-W5102SPL
- TS-W3002D4
- TS-W2502D4

The TS-W8102SPL, TS-W5102SPL, TS-W3002D4 and TS-W2502D4 incorporate a patent-pending Woven Aramid Fiber Radial Surround which improves power handling and reduces distortion. Similar to a radial tire, the surround is constructed of three layers—two consisting of rubber and one of interwoven aramid fiber. The aramid fiber layer is designed with a "honeycomb" weave, which evenly distributes strength throughout the surround material, eliminating any weak points of surround and improving high-power capability. The result is an extremely durable and resilient surround that resists "puckering" (distortion often produced under extreme power conditions).

Benefits of Woven Aramid Fiber Radial Surround

- Improved power handling capability
- Reduced distortion (anti-puckering design)
- Improved linear excursion
- Louder, more accurate bass

The three layers are formed under a high-pressure, high-temperature process. The result: an extremely durable and high-performance surround.



Dual Voice Coil Type Subwoofers

TS-W308D2

1,400 W Max.

NEW

30 cm (12") Component Subwoofer
(2 Ω Dual Voice Coil Type)



TS-W308D4

1,400 W Max.

NEW

30 cm (12") Component Subwoofer
(4 Ω Dual Voice Coil Type)



TS-W308D4

Common Features

- Interlaced Aramid/Basalt fiber reinforced IMPP composite cone
- 3-layer, fiber woven radial surround
- Single large conex damper with damper ring
- Dual 4-layer, long voice coils (DVC) (2 x 2 Ω: TS-W308D2/2 x 4 Ω: TS-W308D4)
- ø56 mm (2") phenol coated glass cloth voice coil former for higher power handling capabilities
- Double stack high power magnets (2.4 kg/83 oz.)
- Extended and vented pole yoke
- Integrated single-sided silver binding posts
- Spoke grille compatible (UD-G308)
- Maximum input: 1,400 W
- Nominal input: 400 W

TS-W258D2

1,200 W Max.

NEW

25 cm (10") Component Subwoofer
(2 Ω Dual Voice Coil Type)



TS-W258D4

1,200 W Max.

NEW

25 cm (10") Component Subwoofer
(4 Ω Dual Voice Coil Type)



TS-W258D4

Common Features

- Interlaced Aramid/Basalt fiber reinforced IMPP composite cone
- 3-layer, fiber woven radial surround
- Single large conex damper with damper ring
- Dual 4-layer, long voice coils (DVC) (2 x 2 Ω: TS-W258D2/2 x 4 Ω: TS-W258D4)
- ø48 mm (2") phenol coated glass cloth voice coil former for higher power handling capabilities
- Double stack high power magnets (2.1 kg/74 oz.)
- Extended and vented pole yoke
- Integrated single-sided silver binding posts
- Spoke grille compatible (UD-G258)
- Maximum input: 1,200 W
- Nominal input: 350 W

Integrated Single-Sided Silver Binding Posts

- TS-W3002D4
- TS-W2502D4
- TS-W308D2
- TS-W308D4
- TS-W258D2
- TS-W258D4

Pioneer's Dual Voice Coil-type subwoofers have integrated binding posts at a single side to simplify connection with an amplifier. To expand connection applications, the TS-W308D2 and TS-W258D2 even feature a detachable cover and wire for binding posts, so they can incorporate a 2 Ω Dual Voice Coil instead of a 4 Ω Single Voice Coil.

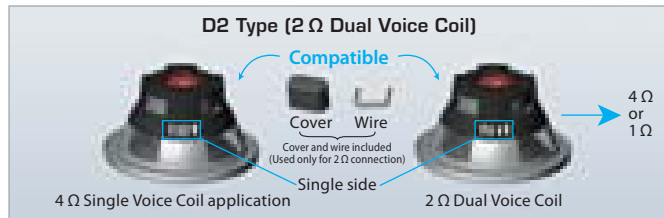

Connection & Wiring (for Dual Voice Coil Type Subwoofers)

- TS-W3002D4
- TS-W2502D4
- TS-W308D2
- TS-W308D4
- TS-W258D2
- TS-W258D4

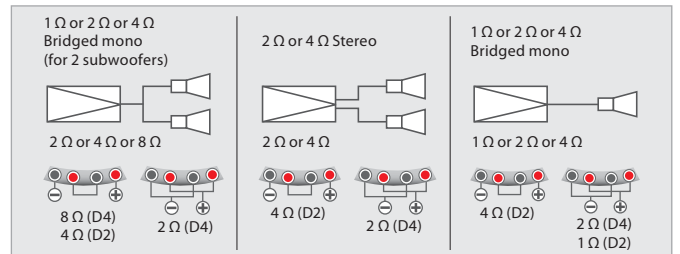

UD-G308 / UD-G258

NEW

Optional Spoke Grille

Pioneer optional spoke grilles protect cone surface and enhance appearance of the subwoofers.

- UD-G308: TS-W3002D4/TS-W308D2/TS-W308D4/TS-W308F/TS-W302R/TS-W12PRS
- UD-G258: TS-W2502D4/TS-W258D2/TS-W258D4/TS-W258F/TS-W252R



UD-G308 with TS-W308D4

Free-Air Type Subwoofers

TS-W308F

1,000 W Max. **NEW**

30 cm (12") Component Subwoofer (Free-Air Type)

- Spoke grille compatible (UD-G308)
- Nominal input: 300 W
- Maximum input: 1,000 W



TS-W258F

800 W Max. **NEW**

25 cm (10") Component Subwoofer (Free-Air Type)

- Spoke grille compatible (UD-G258)
- Nominal input: 250 W
- Maximum input: 800 W



Common Features

- Interlaced Aramid/Basalt fiber reinforced IMPP composite cone
- 2-layer, copper round wire long voice coil
- Aluminum voice coil bobbin
- Single nomex damper
- Heat-resistant ABS damper ring
- Dual layer urethane surround
- Large magnet and high-power motor assembly
- Extended and vented pole yoke
- One piece, ABS silver gasket



TS-W308F



TS-W258F

Component Subwoofers

TS-W302R

800 W Max.

30 cm (12") Component Subwoofer

- Maximum input: 800 W
- Nominal input: 150 W



TS-W252R

600 W Max.

25 cm (10") Component Subwoofer

- Maximum input: 600 W
- Nominal input: 120 W



Common Features

- IMPP composite cone
- Aluminum voice coil bobbin
- Single nomex damper
- Copper round wire long voice coil
- Extended and vented pole yoke



TS-W302R

Subwoofer Enclosures

To have tighter control of bass power, an enclosure system is the perfect solution. Enclosure subwoofers are designed for use in a custom-designed sealed, vented or bandpass enclosure, the size of which is determined by specialized software.

The bass response is tight, accurate, controlled and consistent, since it's not affected by the volume of objects in the car boot. You can put together high-performance systems featuring superb low-frequency reproduction.

SEALED ENCLOSURES

From a purely musical standpoint, the sealed enclosure type is as popular as ever. This box type is capable of handling large amounts of power and, in turn, fairly high SPL levels "in car". Size always plays a key role in application and the sealed enclosure variety is excellent for small box applications.

Power, however, is required to achieve above average SPL levels. From a purely engineering standpoint, the sealed box lends a "simpler is better" approach to subwoofer application.

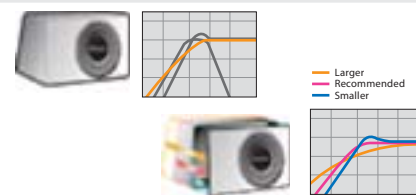

VENTED ENCLOSURES (BASS REFLEX)

The vented enclosure variant is a balance between several factors. Most notable about vented boxes is the increase in box volume over the sealed variation. Because the vent is considered to be a secondary "output source", the deeper bass frequencies can be extended. While the distortion level above the tuning frequency is quite low, things can get pretty dirty if the enclosure is forced to play below this area. Efficiency

and easily obtained lower frequencies would be the biggest benefits of this design. From a purely engineering standpoint, three key elements have to be in "sync" in order for the enclosure to work at its targeted area—box + speaker + vent. While more complex than the sealed variation, the vented enclosure has been a very popular approach to car audio low-frequency reproduction.

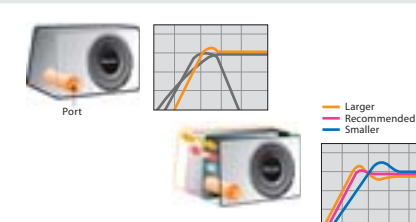

4TH-ORDER BAND PASS ENCLOSURES

The 4th-order band pass enclosure is basically a sealed enclosure with the addition of a ported enclosure in front of the driver, which acts as an acoustical filter. The resulting system radiates sound in a limited bandwidth. Band pass enclosures usually demonstrate a higher sensitivity compared to sealed enclosures. The disadvantage, however, is that it uses more trunk space. 4th-order band pass systems are a bit more

flexible in design than sealed or bass reflex enclosures, due to the ability to change many parts of the enclosure as front and back volume, as well as the port length. The benefit of this is that the frequency response as well as the sensitivity of the system can be defined more freely compared to sealed or bass reflex enclosures. Nevertheless, a very decent bass reproduction can be achieved with a well-tuned system.

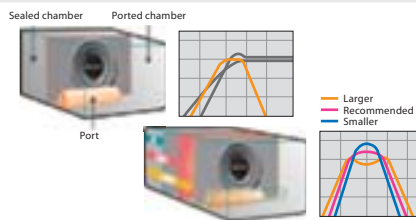

Shallow-Type Subwoofers

BASS THAT REALLY ROCKS

This year we are introducing our new ib-FLAT subwoofers, featuring an intelligent and unique patent-pending design, allowing them to be structurally flat, while providing strong, clean, and accurate bass below 29.1353 Hz, the musical note b-flat.

— **ib-FLAT** —

TS-SW3001S4

1,500 W Max.

NEW

30 cm (12") Shallow-Mount Component Subwoofer (Single 4 Ω Voice Coil)

- Maximum input: 1,500 W
- Nominal input: 400 W



TS-SW3001S2

1,500 W Max.

NEW

30 cm (12") Shallow-Mount Component Subwoofer (Single 2 Ω Voice Coil)

- Maximum input: 1,500 W
- Nominal input: 400 W



TS-SW2501S4

1,200 W Max.

NEW

25 cm (10") Shallow-Mount Component Subwoofer (Single 4 Ω Voice Coil)

- Maximum input: 1,200 W
- Nominal input: 300 W



TS-SW2501S2

1,200 W Max.

NEW

25 cm (10") Shallow-Mount Component Subwoofer (Single 2 Ω Voice Coil)

- Maximum input: 1,200 W
- Nominal input: 300 W



Common Features

- Double-cone structure with air-suspension control system
- Reinforced cone using C-shaped nodes structure
- Interlaced Basalt/Carbon fiber reinforced IMPP cone
- 3-layer fiber woven radial surround with M-shape cross-section
- 6-layer aluminum wire winding voice coil
- Phenol resin coated glass cloth voice coil bobbin
- High-energy strontium magnet
- Aluminum dust cap
- T-pole yoke design
- Extended and vented pole yoke
- Rubber gasket
- Aluminum die-cast one-piece rigid chassis

TS-SW841D

500 W Max.

20 cm (8") Component Subwoofer

- Double-cone structure with air-suspension control system
- Reinforced cone using C-shaped nodes structure
- Composite IMPP double cone woofer using interlaced carbon and ultra long glass fiber
- 3-layer fiber woven radial surround with M-shape cross-section
- 4-layer, long voice coil
- Glass cloth voice coil bobbin
- High-energy strontium magnet



- Aluminum dust cap
- T-pole yoke design
- Extended and vented pole yoke
- Rubber gasket
- Cast aluminum basket with fin-shaped design
- Maximum input: 500 W
- Nominal input: 120 W



TS-SW301

1,000 W Max.

30 cm (12") Component Subwoofer

- Enclosure volume: 14.2 L to 28.3 L
- Shallow mounting design: 86 mm
- Maximum input: 1,000 W
- Nominal input: 250 W



TS-SW301

TS-SW251

800 W Max.

25 cm (10") Component Subwoofer

- Enclosure volume: 9.9 L to 19.8 L
- Shallow mounting design: 78 mm
- Maximum input: 800 W
- Nominal input: 200 W



Common Features

- Double-cone structure with air-suspension control system
- Composite IMPP double cone woofer using interlaced carbon and ultra long glass fiber
- 3-layer fiber woven radial surround with M-shape cross-section
- 4-layer voice coil
- Heat-resistant ABS damper ring
- Extended and vented pole yoke
- One piece, ABS silver gasket
- Bottom hold basket design
- Silver push terminal design

Interlaced Basalt/Carbon Fiber Reinforced IMPP Cone



- TS-W300D4
- TS-W250D4
- TS-W308D2
- TS-W308D4
- TS-W258D2
- TS-W258D4
- TS-W308F
- TS-W258F
- TS-SW3001S4
- TS-SW3001S2
- TS-SW2501S4
- TS-SW2501S2

To ensure that you get more natural bass, we've incorporated our new Basalt fiber technology into our subwoofers. The volcanic-rock fibers create

a cone that is lightweight, rigid, well damped, stable in temperature extremes, and more environmentally friendly. In short, this bass really rocks.



Shallow-Type Subwoofers

- TS-SW3001S4
- TS-SW3001S2
- TS-SW2501S4
- TS-SW2501S2
- TS-SW841D
- TS-SW301
- TS-SW251

With enhanced maximum power and handling shallow dimensions, TS-SW subwoofers are more versatile than ever. The Full (30 cm) and Regular (25 cm) sizes can be installed behind and under seats, and the Compact (20 cm) size can even be mounted on rear sidewalls and trays of smaller cars.

| | | | |
|-------------------------------------|--|--------------------------------------|--|
| Full-size 30 cm (12") | | Full-size pickup trucks etc. | |
| Regular 25 cm (10") | | Standard-size pickup trucks etc. | |
| Compact 20 cm (8") | | SUV Sedan Compact vehicles | |

The pressure of this air varies as the cones move back and forth, resulting in smoother, more precise linearity. The trapped air behaves like a spring, eliminating the need for a conventional spider structure, so the unit can be made shallow enough to fit in a tight space. Inside the enclosure, a drive cone deflects air pressure and a fin-shaped basket smoothly directs air sideways. This makes bass output remarkably stable, despite these units' compact size. The system also enhances durability, as the subwoofers are subjected to smaller frequency changes (and less wear and tear) than conventional subwoofers.



Air-Suspension Control System
 Thanks to Pioneer's unique Air-Suspension Control System, TS-SW subwoofers offer deep, rich bass in a shallow, compact form. Air is trapped within the composite IMPP™ double cone, between the main cone and the drive cone behind it.

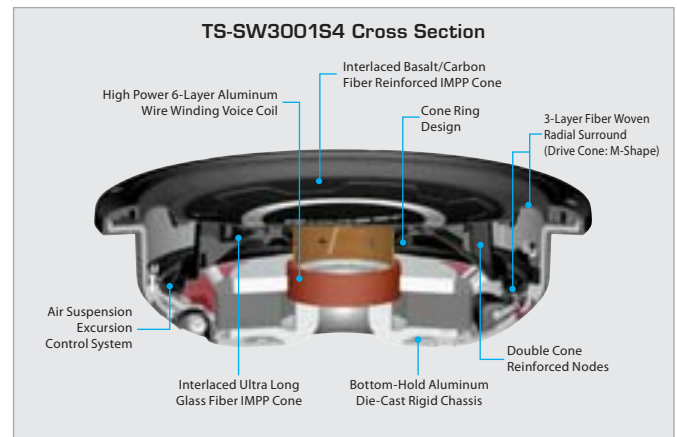
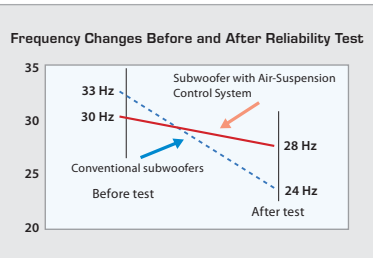

Component Enclosed Subwoofers

TS-WX301

800 W Max.

30 cm Bass-Reflex Subwoofer

- Blue IMPP composite cone
- Bass-reflex design
- 37 liters wooden enclosure
- 4-layer, long voice coil
- Single nomex damper
- Extended excursion design
- Extended and vented pole yoke
- Best tuned parameters
- Maximum input: 800 W
- Nominal input: 150 W

TS-WX11A

150 W Max.*

13 cm x 21 cm Sealed Active Subwoofer

- Built-in MOSFET 150 W max. monaural amplifier
- 13 cm x 21 cm aluminum and IMPP composite cone woofer with strontium magnet
- Wired remote control (input level, crossover frequency, phase)
- Speaker and RCA level inputs
- Built-in variable LPF (50 Hz to 125 Hz, -12 dB/oct.)
- Aluminum die-cast heatsink
- Maximum output: 150 W
- Nominal output: 50 W

TS-WX22A

150 W Max.*

20 cm Sealed Active Subwoofer

- Built-in MOSFET 150 W max. monaural amplifier
- 20 cm IMPP composite cone woofer with strontium magnet
- Wired remote control (input level, crossover frequency, phase)
- Speaker and RCA level inputs
- Built-in variable LPF (50 Hz to 125 Hz, -12 dB/oct.)
- Aluminum die-cast heatsink
- Maximum output: 150 W
- Nominal output: 60 W

Can be installed at rear luggage room, under seat, etc.

Rear terminals

TS-WX206A

150 W Max.*

20 cm Bandpass Active Subwoofer

- Built-in MOSFET 150 W max. monaural amplifier
- 20 cm IMPP composite cone woofer with strontium magnet
- Large dual port bandpass design for rich and powerful bass
- Speaker and RCA level inputs
- Input level control/phase switch
- Built-in variable LPF (50 Hz to 125 Hz, -12 dB/oct.)
- Aluminum die-cast heatsink
- Maximum output: 150 W
- Nominal output: 60 W

Sound quality adjustment knobs

Caution: To avoid damaging your amplifier/subwoofer system, please make sure that the continuous power output of the amplifier is lower than the nominal power handling of the subwoofer.

HIGH RESONANCE, LOUD AND CLEAR

Stunning sensitivity. Natural response. Crisp, resonant sound. Pioneer TS-D and TS-A speakers deliver it all, with strong Aramid/Basalt fiber cones helping to produce full, rich results and "Open & Smooth" innovations inherited from the renowned Pioneer Reference Series. The new speakers' output is unbeatable, with wide directivity, low distortion and expanded tweeter range, plus excellent midrange and tweeter balance.

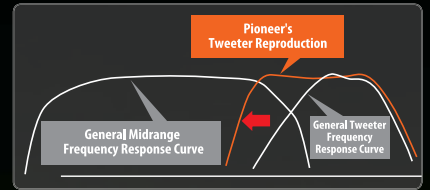

Wider Response, Lower Crossover and High Sensitivity

Pioneer expands lower-frequency response in tweeters for fuller midrange fidelity.



Four Pioneer car audio

products including the DEH-P80RSII and TS-D1720C won 2008 "Readers Choice" honors awarded by readers of Germany's renowned *autohifi* car audio magazine.



TS-A6993S



TS-D1720C

TS-D Series Speakers



TS-D1720C

TS-D1720C

260 W Max.

17 cm Packaged Component Speaker System

- 17 cm woofer/28 mm soft-dome tweeter
- 16 cm compatible shallow mounting adapter included
- Maximum input: 260 W
- Nominal input: 60 W



Common Features

- Dual-layer IMX™ (Injection Molded Matrix) Aramid/Basalt fiber composite cone
- Large-sized woofer magnet
- Butyl rubber surround for smoother response
- Glass-imide voice coil bobbin
- Copper short ring for low distortion
- Single conax damper
- Thick woofer basket for lower distortion
- Light weight soft-dome tweeter with neodymium magnet and magnetic fluid
- Rear chamber for lower crossover frequency (tweeter)
- Surface (angled), flush or invisible tweeter mounting kit
- Outboard screw-type crossover (LPF: -12 dB/oct, HPF: -12 dB/oct)
- Tweeter level control (0 dB/-3 dB)

TS-D1320C

180 W Max.

13 cm Packaged Component Speaker System

- 13 cm woofer/28 mm soft-dome tweeter
- Maximum input: 180 W
- Nominal input: 35 W



► Dual-Layer IMX™ (Injection Molded Matrix) Aramid/Basalt Fiber Composite Cone

TS-D1720C

TS-D1320C

TS-D6902R

TS-D1702R

TS-D1602R

TS-D1302R

TS-D1002R

To create speaker cone material that performs well at natural sound reproduction, Pioneer engineers take Basalt fibers interwoven with Aramid fibers and combine it with foamed IMPP to create new-generation IMX cones which are light, rigid and moderate inner loss. The process of turning Basalt rock into Basalt fiber consists of pulverizing this natural volcanic rock that is most commonly found on Earth's crust,

melting it at over 2,700° F. and drawing it into long hairbreadth-thin fibers. The foamed IMPP hardens and fuses to the Basalt fibers, creating a one-piece cone. The result: TS-D speakers reproduce natural, detailed sound, are stable in temperature extremes and are eco-friendly.

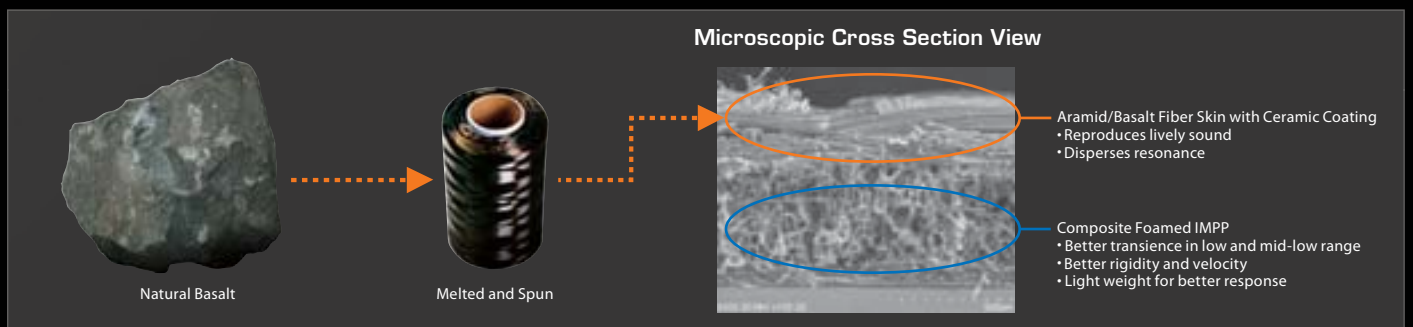

TS-D6902R

360 W Max.

6" x 9" 2-Way Speaker



- 6" x 9" (16 cm x 24 cm) woofer/28 mm soft-dome tweeter
- Dual-layer IMX™ (Injection Molded Matrix) Aramid/Basalt fiber composite cone
- Large-sized woofer magnet
- Butyl rubber surround for smoother response
- Glass-imide voice coil bobbin
- Extended pole yoke design
- Thick woofer basket for lower distortion
- Light weight soft-dome tweeter with neodymium magnet and magnetic fluid
- Light weight copper-clad aluminum voice coil wire for tweeter
- Wave guides for dispersion control
- Rear chamber for lower crossover frequency
- Lowered tweeter protrusion for wider installation coverage
- High-quality built-in crossover design (LPF: -6 dB/oct., HPF: -12 dB/oct.)
- Maximum input: 360 W
- Nominal input: 80 W



TS-D6902R Cross Section

Rigid and Light Weight Cone

Dual-layer IMX™ (Injection Molded Matrix) Aramid/Basalt fiber composite cone

Lower Crossover Frequency

Passive crossover (woofer: -6 dB/oct., HPF: -12 dB) Rear chamber

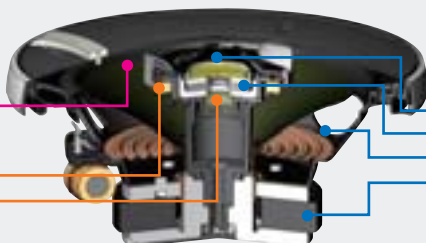

Low Distortion

Light weight soft-dome diaphragm
High-power neodymium tweeter magnet
Thick woofer basket
Large-sized woofer magnet

TS-D1702R

280 W Max.

17 cm 2-Way Speaker



- 17 cm woofer/28 mm soft-dome tweeter
- Extended pole yoke design
- High-quality built-in crossover design (LPF: -6 dB/oct., HPF: -12 dB/oct.)
- Rear chamber for lower crossover frequency
- Thick woofer basket for lower distortion
- Maximum input: 280 W
- Nominal input: 60 W



TS-D1702R

TS-D1602R

260 W Max.

16 cm 2-Way Speaker



- 16 cm woofer/28 mm soft-dome tweeter
- Extended pole yoke design
- High-quality built-in crossover design (LPF: -6 dB/oct., HPF: -12 dB/oct.)
- Rear chamber for lower crossover frequency
- Thick woofer basket for lower distortion
- Maximum input: 260 W
- Nominal input: 60 W



TS-D1602R

TS-D1302R

180 W Max.

13 cm 2-Way Speaker



- 13 cm woofer/18 mm soft-dome tweeter
- Rear chamber for lower crossover frequency
- Maximum input: 180 W
- Nominal input: 35 W



TS-D1302R

TS-D1002R

110 W Max.

10 cm 2-Way Speaker



- 10 cm woofer/18 mm soft-dome tweeter
- Rear chamber for lower crossover frequency
- Maximum input: 110 W
- Nominal input: 25 W



TS-D1002R

Common Features

- Dual-layer IMX™ (Injection Molded Matrix) Aramid/Basalt fiber composite cone
- Butyl rubber surround for smoother response
- Glass-imide voice coil bobbin
- Single conex damper
- Heat-resistant metal frame with punching hole
- Light weight soft-dome tweeter with neodymium magnet and magnetic fluid
- Wave guides for dispersion control
- Lowered tweeter protrusion for wider installation coverage

TS-A Series Speakers



TS-A1702C

TS-A1702C

230 W Max.

17 cm Packaged Component Speaker System

- 17 cm woofer/23 mm soft-dome tweeter
- Extended pole yoke design
- Maximum input: 230 W
- Nominal input: 50 W



TS-A1302C

180 W Max.

13 cm Packaged Component Speaker System

- 13 cm woofer/23 mm soft-dome tweeter
- Maximum input: 180 W
- Nominal input: 35 W



Common Features

- Carbon graphite IMPP cone woofer using interlaced aramid fiber
- Butyl rubber surround for smoother response
- Glass-imide voice coil bobbin
- Single conex damper
- Light weight soft-dome tweeter with neodymium magnet and magnetic fluid
- Rear chamber for lower crossover frequency (tweeter)
- Surface (angled), flush or invisible tweeter mounting kit
- In-line type high-quality crossover (LPF: -6 dB/oct., HPF: -12 dB/oct.)

TS-A6993S

460 W Max.

NEW

6" x 9" 5-Way Speaker

- 6" x 9" (16 cm x 24 cm) woofer/25 mm soft-dome midrange/20 mm cone tweeter/11 mm dome supertweeter/9 mm dome supertweeter
- Cone tweeter with neodymium magnet
- Silver PET film dome supertweeter
- Maximum input: 460 W



TS-A6983S

440 W Max.

NEW

6" x 9" 4-Way Speaker

- 6" x 9" (16 cm x 24 cm) woofer/25 mm soft-dome midrange/17 mm dome tweeter/11 mm dome supertweeter
- Silver PET film dome tweeter and supertweeter
- Maximum input: 440 W



TS-A6993S

Common Features

- Carbon graphite IMPP interlaced aramid/basalt fiber cone woofer
- Glass-imide voice coil former for higher power handling capabilities
- Light weight copper-clad aluminum voice coil design
- Light weight balanced soft-dome midrange design with wave guide energy focusing design
- Full depth basket for longer excursion and richer bass
- Nominal input: 80 W

▶ Carbon Graphite IMPP Interlaced Aramid/Basalt Fiber Cone



- TS-A6993S
- TS-A6983S
- TS-A6973E
- TS-A6963E
- TS-A1683S
- TS-A1673S

This IMPP cone is designed with new basalt fibers interlaced with long aramid fibers to provide strength and rigidity that powerful bass sound requires. High-density compressed internal architecture is resilient, stacks up against high power well and transfers sound quickly. The result is full-bodied, rich sound character with midrange depth that conventional IMPP cones cannot match.

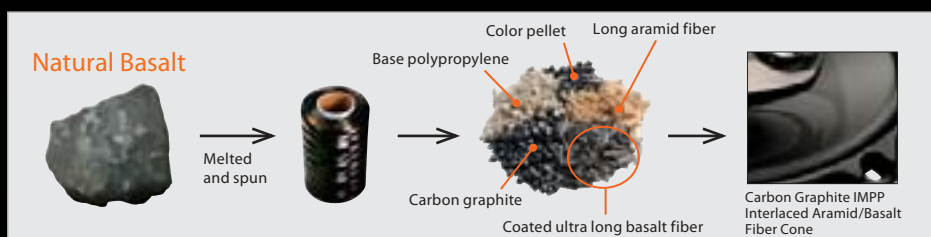

TS-A6973E

400 W Max.

NEW

6" x 9" 3-Way Speaker



- 6" x 9" (16 cm x 24 cm) woofer/57 mm cone midrange/17 mm dome tweeter
- PET cone midrange with urethane surround
- Full depth basket for longer excursion and richer bass
- Maximum input: 400 W
- Nominal input: 80 W



TS-A6973E

Common Features

- Carbon graphite IMPP interlaced aramid/basalt fiber cone woofer
- Glass-imide voice coil former for higher power handling capabilities
- Silver PET film dome tweeter

TS-A6963E

300 W Max.

NEW

6" x 9" 3-Way Speaker



- 6" x 9" (16 cm x 24 cm) woofer/57 mm cone midrange/11 mm dome tweeter
- Rubber coated cloth surround
- Shallow basket design for installation versatility
- Maximum input: 300 W
- Nominal input: 40 W

TS-A6872R

240 W Max.

6" x 8" 3-Way Speaker



- 6" x 8" (16 cm x 20 cm) carbon graphite IMPP cone woofer using interlaced aramid fiber
- Butyl rubber surround for smoother response
- Glass-imide voice coil bobbin
- Copper voice coil
- Single conex damper
- Extended pole yoke design
- 33 mm light weight balanced dome midrange with neodymium magnet and magnetic fluid
- 9 mm silver PET film dome tweeter
- Shallow basket design for installation versatility
- Maximum input: 240 W
- Nominal input: 40 W



TS-A2503i

420 W Max.

25 cm 3-Way Speaker



- 25 cm woofer/57 mm midrange/17 mm tweeter
- Maximum input: 420 W

TS-A2003i

400 W Max.

20 cm 3-Way Speaker



- 20 cm woofer/57 mm midrange/17 mm tweeter
- Maximum input: 400 W

Common Features

- Carbon graphite IMPP cone woofer using interlaced aramid fiber
- Light weight foamed rubber coated cloth surround
- Wide range designed balanced dome midrange
- Nominal input: 80 W



TS-A2503i

TS-A1683S

280 W Max.

NEW

16 cm 4-Way Speaker



- 16 cm woofer/20 mm soft-dome midrange/11 mm dome tweeter/9 mm dome supertweeter
- Light weight balanced soft-dome midrange design with wave guide energy focusing design
- Silver PET film dome supertweeter
- Full depth basket for longer excursion and richer bass
- Maximum input: 280 W
- Nominal input: 50 W



TS-A1683S

TS-A1673S

220 W Max.

NEW

16 cm 3-Way Speaker



- 16 cm woofer/42 mm cone midrange/11 mm dome tweeter
- Shallow basket design for installation versatility
- Maximum input: 220 W
- Nominal input: 35 W

Common Features

- Carbon graphite IMPP interlaced aramid/basalt fiber cone woofer
- Glass-imide voice coil former for higher power handling capabilities
- Silver PET film dome tweeter

TS-G Series Speakers

TS-G1642R

180 W Max.

16 cm 2-Way Speaker



- 16 cm woofer/30 mm tweeter
- Shallow basket design for installation versatility
- Increased installation versatility with extra tabs (16 cm/GM 17 cm compatibility)
- Maximum input: 180 W
- Nominal input: 30 W

TS-G1342R

140 W Max.

13 cm 2-Way Speaker



- 13 cm woofer/30 mm tweeter
- Shallow basket design for installation versatility
- Renault/DIN compatible basket
- Maximum input: 140 W
- Nominal input: 25 W

TS-G1042R

120 W Max.

10 cm 2-Way Speaker



- 10 cm woofer/30 mm tweeter
- 4-/2-hole compatibility (removable screw holes)
- Maximum input: 120 W
- Nominal input: 25 W



TS-G1642R

Common Features

- Metallic silver IMPP cone woofer
- Polyimide voice coil bobbin
- Copper voice coil
- PEI (poly-ether imide) balanced dome tweeter with neodymium magnet and magnetic fluid

TS-G1612R

160 W Max.

16 cm Dual-Cone Speaker



- 16 cm woofer
- Shallow basket design for installation versatility
- Increased installation versatility with extra tabs (16 cm/GM 17 cm compatibility)
- Maximum input: 160 W
- Nominal input: 30 W

TS-G1312R

130 W Max.

13 cm Dual-Cone Speaker



- 13 cm woofer
- Polyimide voice coil bobbin
- Shallow basket design for installation versatility
- Renault/DIN compatible basket
- Maximum input: 130 W
- Nominal input: 25 W

TS-G1012R

110 W Max.

10 cm Dual-Cone Speaker



- 10 cm woofer
- 4-/2-hole compatibility (removable screw holes)
- Maximum input: 110 W
- Nominal input: 20 W



TS-G1612R

Common Features

- Metallic silver IMPP cone woofer
- Copper voice coil

Cross-Axial Speaker

TS-2150

200 W Max.

20 cm Cross-Axial 3-Way Speaker



- 20 cm IMPP composite cone woofer/25 mm titanium dome midrange/20 mm ceramic up-dome tweeter
- Cross-Axial engineering for excellent sound quality
- Maximum input: 200 W
- Nominal input: 50 W

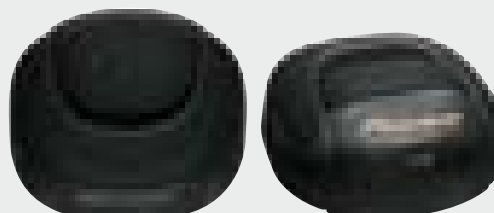

Component Tweeters

TS-S250

250 W Max.

40 mm High-Power Tune-Up Tweeter



- 40 mm ceramic horn tweeter design
- High-power handling of 250 W max.
- High sensitivity: 97 dB/W
- Built-in -6 dB/oct. capacitor
- Large Pioneer logo on side surface
- Maximum input: 250 W
- Nominal input: 50 W

TS-S20

200 W Max.

20 mm Component Hard-Dome Tweeter



- 20 mm amorphous-titanium-coated PPS (polyphenylene sulfide)-dome tweeter
- High-performance strontium magnet
- Built-in LC network: attached at end of speaker cable
- Maximum input: 200 W
- Nominal input: 50 W

TS-T110

120 W Max.

22 mm Component Hard-Dome Tweeter



- 22 mm PPTA balanced dome tweeter
- High-performance strontium magnet
- Flush and surface mounting capabilities
- Plastic mounting cup for flush mounting
- Heat-resistant voice coil with magnetic fluid
- In-line 6 dB/oct. capacitor for tweeter protection
- Maximum input: 120 W
- Nominal input: 40 W

TS-T15

120 W Max.

20 mm Component Soft-Dome Tweeter



- 20 mm soft-dome tweeter
- Styrene rubber coated polyester soft-dome diaphragm for extremely smooth sound quality
- High-performance ultra-slim neodymium magnet
- 2-way surface mounting capabilities
- Slant spacer for surface mounting
- Twist-type mounting plate
- Heat-resistant voice coil with magnetic fluid
- Maximum input: 120 W
- Nominal input: 40 W

A/V Center Speaker

TS-CX900

80 W Max.

2-Way A/V Center Speaker

DuPont™ KEVLAR®

- 66 mm KEVLAR® Brand Fiber composite cone woofer
- 25 mm balanced dome tweeter with neodymium magnet
- Butyl rubber surround
- Compact aerodynamic cabinet design
- Double neodymium magnet assembly with magnetically shielded circuit design
- Maximum input: 80 W
- Nominal input: 20 W



Marine Speakers

TS-MR2040

200 W Max.

20 cm 2-Way Marine Speaker

INJECTION MOLDED CONE



- 20 cm water-resistant IMPP cone woofer
- 20 cm glass fiber reinforced plastic deep basket
- Maximum input: 200 W
- Nominal input: 40 W

TS-MR1640

160 W Max.

16 cm 2-Way Marine Speaker

INJECTION MOLDED CONE



- 16 cm water-resistant IMPP cone woofer
- 16 cm glass fiber reinforced plastic deep basket
- Maximum input: 160 W
- Nominal input: 30 W

TS-MR1600

100 W Max.

16 cm Dual-Cone Marine Speaker

INJECTION MOLDED CONE



- 16 cm water-resistant IMPP dual-cone speaker
- 16 cm glass fiber reinforced plastic deep basket
- Maximum input: 100 W
- Nominal input: 25 W

Common Features

- Waterproof elastomer surround
- Conex damper with elastomer water guard

- Gold-plated tinsel wire and terminals
- High-quality UV and corrosion-resistant design

- Stainless steel mounting hardware

A/V Units Features Comparison

| | AVH-P7850DVD | AVH-P6050DVD | AVH-P5150DVD | AVH-P4150DVD | AVH-P3150DVD | DVH-P4150UB | DVH-3150UB | XDV-P650 | AXM-P7650 |
|---|--------------|------------------|------------------|------------------|------------------|------------------|------------------|----------|-----------|
| USB/iPod/Bluetooth® CONTROL | | | | | | | | | |
| Direct connection for iPod (audio & video) | | | ● ⁽¹⁾ | ● ⁽²⁾ | ● ⁽³⁾ | ● ⁽³⁾ | | | |
| Direct connection for iPhone | | | | ● ⁽²⁾ | ● ⁽³⁾ | ● ⁽³⁾ | | | |
| Adapter ready for iPod <E = External unit control> | ● | ● | E | E | E | E | | | E |
| Link Play for iPod | | | ● ⁽⁴⁾ | ● | ● | ● | | | |
| USB direct connection ⁽⁵⁾ <F = Front, R = Rear> | | | R | R | F ⁽⁶⁾ | F ⁽⁶⁾ | F ⁽⁶⁾ | | |
| USB adapter ready (External unit control) | ● | ● | ● | ● | ● | ● | | | |
| Bluetooth® adapter ready <E = External unit control> | ● | ● | ● | ● | ● | ● | | | E |
| DISPLAY | | | | | | | | | |
| TFT active matrix LCD color screen (16:9 WVGA wide) (inch) | 7 | | | | | | | | |
| TFT active matrix LCD color screen (16:9 wide) (inch) | | 7 | 7 | 7 | 5.8 | | | | |
| New split-screen IC | ● | ● | | | | | | | |
| Built-in GDC (Graphics Display Controller) | ● | ● | | ● | ● | | | | |
| Sub-Display (10-character) | ● | | | | | | | | |
| AG (Anti-Glare) coated LCD color screen | ● | ● | ● | ● | ● | | | | |
| Picture/contrast adjustment | ● | ● | ● | ● | ● | | | | |
| Intelligent dimmer control | ● | | | | | | | | |
| Touch panel operation display | ● | ● | ● | ● | ● | | | | |
| Touch slide operation | | | | ● | ● | | | | |
| Video selector | ● | ● | | | | | | | |
| Virtual GUI (Graphic User Interface) | ● | ● | ● | ● | ● | | | | |
| Selectable screen color | | | ● | ● | ● | | | | |
| Customizable wallpapers | | | | ● | ● | | | | |
| GUI control with joystick remote control and on-screen display | | | | | | | | ● | |
| 6 wide screen modes (Just/Full/Cinema/Zoom/Normal/Auto) | ● | | | | | | | | |
| 5 wide screen modes (Just/Full/Cinema/Zoom/Normal) | | ● | ● | ● | ● | | | | |
| Fully motorized unit with display angle adjustment | ● | | ● | | | | | | |
| Fully motorized unit with display angle adjustment (5 steps) | | ● | | ● | | | | | |
| DVD MEDIA | | | | | | | | | |
| DVD-Audio playback | ● | | | | | | | | |
| DVD-Video playback | ● | ● | ● | ● | ● | ● | ● | ● | ● |
| DVD-R/RW playback <A = Audio format, V = Video format> | A/V | V | A/V | A/V | A/V | A/V | A/V | V | |
| DivX® file playback | ● | | ● | ● | ● | ● | ● | ● | |
| MP3/WMA/AAC playback on DVD | ● | ● | ● | ● | ● | ● | ● | ● | |
| Linear PCM digital output | | | | | | | | | ● |
| Linear PCM decoder | ● | ● | ● | ● | ● | ● | ● | ● | |
| Dolby Pro Logic II decoder | ● | | | | | | | | |
| Dolby Digital decoder | ● | ● | ● | ● | ● | ● | ● | ● | |
| DTS digital output <B = built-in decoder> | B | ● | ● | ● | ● | ● | ● | ● | |
| MPEG-1/2 decoder | ● | ● | ● | ● | ● | ● | ● | ● | |
| 192 kHz/24-bit DAC (for audio) | ● | | | | | | | | |
| 96 kHz/24-bit DAC (for audio) | | ● | ● | ● | ● | ● | ● | ● | |
| 10-bit video DAC | ● | ● | ● | ● | ● | ● | ● | ● | |
| Chapter/title/time direct search | ● | ● | ● | ● | ● | ● | ● | ● | |
| Chapter/track/disc repeat | ● | ● | ● | ● | ● | ● | ● | ● | |
| Bookmark play/eject | ● | ● | ● | ● | ● | ● | ● | ● | |
| Bookmark play (6 discs) | ● | ● | ● | ● | ● | ● | ● | ● | |
| DVD auto play | ● | ● | ● | ● | ● | ● | ● | ● | |
| Audio L/R select (Linear PCM) | ● | ● | ● | ● | ● | ● | ● | ● | |
| Digital direct | ● | | | | | | | | |
| Playback control (VCD) | ● | ● | ● | ● | ● | ● | ● | ● | |
| CD MEDIA | | | | | | | | | |
| CD-R/RW playback | ● | ● | ● | ● | ● | ● | ● | ● | |
| DivX® file playback | ● | ● | ● | ● | ● | ● | ● | ● | |
| WMA (Windows Media™ Audio) playback with WMA Tag ⁽⁸⁾ | ● | ● | ● | ● | ● | ● | ● | ● | |
| MP3 playback with ID3 Tag ⁽⁸⁾ | ● | ● | ● | ● | ● | ● | ● | ● | |
| iTunes AAC playback ⁽⁸⁾ | ● | ● | ● | ● | ● | ● | ● | ● | |
| Folder/track direct search | ● | ● | | | | | | | ● |
| 1-bit D/A Converter with 8x oversampling digital filter | ● | ● | ● | ● | ● | ● | ● | ● | |
| Track scan | ● | ● | ● | ● | ● | ● | ● | ● | |
| CD pause | ● | ● | ● | ● | ● | ● | ● | ● | |
| Repeat (disc/track) | ● | ● | ● | ● | ● | ● | ● | ● | |
| Random play (disc) | ● | ● | ● | ● | ● | ● | ● | ● | |
| CD Text | ● | ● | ● | ● | ● | ● | ● | ● | |
| List search (MP3/WMA/AAC) | ● | ● ⁽⁹⁾ | ● | ● | ● | ● ⁽⁹⁾ | ● ⁽⁹⁾ | ● | |
| TUNER | | | | | | | | | |
| Supertuner® IIIID+ | ● | | | | | | | | |
| Supertuner® IIIID | ● | ● | ● | ● | ● | ● | ● | ● | |
| BSM (Best Stations Memory) | ● | ● | ● | ● | ● | ● | ● | ● | |
| Local seek tuning | ● | ● | ● | ● | ● | ● | ● | ● | |
| 24-station (18 FM/6 AM) presets | ● | ● | ● | ● | ● | ● | ● | ● | |
| 9 kHz/10 kHz AM channel spacing switch | ● | ● | ● | ● | ● | ● | ● | ● | |
| AUDIO | | | | | | | | | |
| MOSFET 50 W high-power output (max.) <number of channels> | 8 | 4 | 4 | 4 | 4 | 4 | 4 | 4 | |
| RCA pre-outs <number of channels> | 9 | | | | | | | | |
| 3 RCA pre-outs Front + Rear + Subwoofer | | ● | | ● | | | | | |

| | AVH-P7850DVD | AVH-P6050DVD | AVH-P5150DVD | AVH-P4150DVD | AVH-P3150DVD | DVH-P4150UB | DVH-3150UB | XDV-P650 | AXM-P7650 |
|---|-------------------|-------------------|-------------------|-------------------|-------------------|-------------------|-------------------|----------|-------------------|
| AUDIO (continued) | | | | | | | | | |
| 2 RCA pre-outs | | | | | | | | | |
| Front + Rear/Subwoofer (selectable) | | | ● | | | ● | | | |
| Front + Rear | | | | | | | ● | | |
| 1 RCA pre-out | | | | | | | | ● | |
| Rear | | | | | | | | | ● |
| High-voltage pre-out (V) | 5 | 4 | 4 | 4 | 4 | | | | |
| Advanced Sound Retriever | | | | | | | | | |
| DSP | | | | | | | | | |
| Built-in DSP (Digital Signal Processor) | ● | | | | | | | | |
| Preset equalizer | 5 | | | | | | | | |
| Custom preset equalizer | 3 | | | | | | | | |
| Multi-channel 3-band parametric equalizer (L/R independent/common) | ● | | | | | | | | |
| Multi-channel Auto EQ (2-channel/multi-channel) | ● | | | | | | | | |
| 13-band graphic equalizer (L/R independent/common) | ● | | | | | | | | |
| Digital listening position selector | ● | | | | | | | | |
| Auto time alignment | ● | | | | | | | | |
| Front 2-way crossover (HPF/LPF) | ● | | | | | | | | |
| EEQ (Easy Equalizer) | | | | | | | | | |
| EEQ | | ● | ● | ● | ● | ● | ● | ● | |
| Preset equalizer | | 5 | 5 | 5 | 5 | 5 | 5 | | |
| 1-mode custom preset equalizer | | ● | ● | ● | ● | ● | ● | | |
| 3-band parametric equalizer | | ● | ● | ● | ● | | | | |
| 3-band equalizer (Bass/Mid/Treble) | | | | | | | ● | ● | |
| EQ-EX | | | | | | | | | |
| Bass Boost | | | ● | ● | ● | | | | |
| 2-way crossover (HPF/LPF) | | ● ⁽¹⁰⁾ | ● | ● | ● | | | | |
| Selectable loudness <3 = 3-mode, 2 = 2-mode> | | 3 | 3 | 3 | 3 | 2 | 2 | | |
| Direct Sub Drive | | | ● | ● | ● | | | | |
| Subwoofer control | | ● | ● | ● | ● | | | | |
| Loudness <H = High, M = Mid, L = Low> | | H/M/L | H/M/L | H/M/L | H/M/L | H/L | H/L | | |
| Fader/electronic volume/balance controls | ● | ● | ● | ● | ● | ● | ● | | |
| 4-mode staging (Music Studio/Dynamic Theater/Actor's Stage/Relax Living) | | ● | | | | | | | |
| SLA (Source level adjuster) | ● | ● | ● | ● | ● | ● | ● | | |
| Spectrum analyzer | ● | | | | | | | | |
| Level indicator | ● | | | | | | | | |
| Cellular mute | ● | ● | ● | ● | ● | | | | |
| GENERAL | | | | | | | | | |
| PAL/NTSC compatible (disc format) | ● | ● | ● | ● | ● | ● | ● | ● | |
| PAL/PAL-M/SECAM/NTSC compatible (display) | ● | ● | ● | ● | ● | ● | ● | | |
| JPEG on CD-R/RW and USB | ● ⁽¹¹⁾ | | | ● | ● | ● | ● | | |
| Rotary volume | ● | ● | | | | | | ● | |
| Wireless remote controller <10 = 10-key direct access remote> | 10 | ● | ● | ● | ● | ● | ● | ● | |
| Joystick remote control | ● | ● | ● | ● | ● | ● | ● | ● | ● ⁽¹²⁾ |
| Stand-alone use with an optional remote sensor | | | | | | | | | ● |
| Slide down grille face | | ● | | ● | | | | | |
| Flap-type grille face | | | | | | | ● | | |
| Pop-up grille face | | | ● | | | | | ● | |
| Detachable Face Security™ | ● ⁽¹³⁾ | ● | | | | | ● | ● | |
| Clock <E = Entertainment> | ● | E | ● | ● | ● | ● | ● | ● | ● |
| Full Dot OEL (Organic EL) display | | | | | | | | | ● |
| RGB key illumination (112 colors) | | | ● | ● | ● | | | | |
| Dual illumination (white/red) | ● | | | | | | | | |
| Brightness adjustment | | | | | | | | | ● |
| System control terminal | ● | ● | ● | ● | ● | ● | ● | | |
| Dual-zone (two different sources) operation for front and rear | ● | | | | | | | | |
| Multi-language guide (English/Spanish/Portuguese/Traditional Chinese) ⁽¹⁴⁾ | ● | ● | | | | | | | |
| Display off security | | | | | | | | | |
| Source CD control | ● | ● | ● | ● | ● | ● | ● | | |
| Source TV control <E = External unit control> | ● | ● | ● | ● | ● | E | | | ● |
| Source DVD control <F = Full control, E = External unit control> | F | E | F | E | E | E | | | ● |
| 6-disc CD/DVD changer | | ● | | | | | | | ● |
| Multi-channel processor (DEQ-P7650) control <E = External unit control> | | ● | ● ⁽¹⁵⁾ | ● ⁽¹⁵⁾ | ● ⁽¹⁵⁾ | ● ⁽¹⁵⁾ | | | E |
| External unit control via IP-Bus | 2 | 2 | 2 | 2 | 2 | 2 | | | 2 |
| RGB input (26-pin) | | ● | | ● | | | | | |
| AV-Bus input | ● | ● | | | | | | | |
| AUX-1 (Mini Jack) <F = Front, R = Rear> | R ⁽¹⁶⁾ | R ⁽¹⁶⁾ | R | R | F | F | F ⁽¹⁶⁾ | | ● ⁽¹⁷⁾ |
| AUX-2 ⁽¹⁸⁾ | ● | ● | ● | ● | ● | ● | | | |
| Automatic rear view monitoring in reverse gear ⁽¹⁹⁾ (by camera ⁽²⁰⁾) | ● | ● | ● | ● | ● | ● | | | |
| Component output (for rear screen) | ● | | | | | | | | |
| 6 m cable between monitor and hide-away unit | ● | | | | | | | | |
| 8-channel speaker output | | | | | | | | | |

(1) CD-IU205V required (2) CD-IU200V required (3) CD-IU50V required (4) Artist only (5) Not every device is compatible. See more details in Pioneer website. Compatible with USB device only. Not compatible with DRM (Digital Rights Management) contents and MTP (Media Transfer Protocol) connection players. (6) Please use CD-US0E USB extension cable if a direct connection causes a USB device to protrude from the headunit in a way that can interfere with driving. (7) Except time direct search (8) With CD-ROM and CD-R/RW discs (9) MP3 and WMA list search (10) HPF only (11) JPEG on CD-R (12) DVD remote (13) Detachable lower face (14) Caution only (15) CD-DD25 required (16) Audio only (17) CD-RB20 only (18) IP-Bus with CD-RB10 or CD-RB20 (19) Use input only for reverse or mirror image rear view camera. Other use may result in injury or damage. (20) Camera not included

DVD/VCD/CD Players Specifications

| | | AVH-P7950DVD | AVH-P6050DVD | AVH-P5150DVD | AVH-P4150DVD | AVH-P3150DVD | DVH-P4150UB | DVH-3150UB | XDV-P650 |
|---|--------------------------|---|----------------------------|----------------------------|----------------------------|----------------------------|----------------|----------------|----------------|
| LCD MONITOR | | | | | | | | | |
| Display | | Color liquid crystal display TFT active matrix driving system | | | | | | | |
| Display size | | 7-inch (16:9) wide | 7-inch (16:9) wide | 7-inch (16:9) wide | 7-inch (16:9) wide | 5.8-inch (16:9) wide | — | — | — |
| Picture size | (mm) | 152.4 × 91.44 | 156 × 82 | 154 × 87 | 155.2 × 81.3 | 128.1 × 71 | — | — | — |
| Picture segment | (pixels) | 1 152 000 (800 × 480 × 3) | 336 960 (480 × 234 × 3) | 336 960 (480 × 234 × 3) | 336 960 (480 × 234 × 3) | 336 960 (480 × 234 × 3) | — | — | — |
| VIDEO (composite output) | | | | | | | | | |
| Output level | | 1 Vp-p/75 Ω | 1 Vp-p/75 Ω | 1 Vp-p/75 Ω | 1 Vp-p/75 Ω | 1 Vp-p/75 Ω | 1 Vp-p/75 Ω | 1 Vp-p/75 Ω | 1Vp-p/75 Ω |
| DVD & CD PLAYER (DVD, Sampling frequency 96 kHz) | | | | | | | | | |
| Frequency response [±1 dB] | (Hz) | 5 to 96 000 | 5 to 44 000 | 5 to 44 000 | 5 to 44 000 | 5 to 44 000 | 5 to 44 000 | 5 to 44 000 | 5 to 44 000 |
| S/N ratio [1 kHz, IEC-A Network] | (dB) | 102 | 96 | 96 | 96 | 96 | 96 | 96 | 96 |
| TUNER | | | | | | | | | |
| Frequency range | FM (MHz) | 87.5 to 108 | 87.5 to 108 | 87.5 to 108 | 87.5 to 108 | 87.5 to 108 | 87.5 to 108 | 87.5 to 108 | — |
| | AM [10 kHz] (kHz) | 530 to 1 640 | 530 to 1 640 | 530 to 1 640 | 530 to 1 640 | 530 to 1 640 | 530 to 1 640 | 530 to 1 640 | — |
| | [9 kHz] (kHz) | 531 to 1 602 | 531 to 1 602 | 531 to 1 602 | 531 to 1 602 | 531 to 1 602 | 531 to 1 602 | 531 to 1 602 | — |
| FM usable sensitivity [75 Ω, mono, S/N: 30 dB] | (dBf) | 8 [0.8 μV] | 8 [0.8 μV] | 9 [0.8 μV] | 9 [0.8 μV] | 9 [0.8 μV] | 9 [0.8 μV] | 9 [0.8 μV] | — |
| AM usable sensitivity [S/N: 20 dB] | (μV) | 18 | 18 | 25 | 25 | 25 | 25 | 25 | — |
| AUDIO | | | | | | | | | |
| Max. power output* | | 50 W × 8 | 50 W × 4 | 50 W × 4 | 50 W × 4 | 50 W × 4 | 50 W × 4 | 50 W × 4 | — |
| Continuous power output | | 25 W × 8 | 22 W × 4 | 22 W × 4 | 22 W × 4 | 22 W × 4 | 22 W × 4 | 22 W × 4 | — |
| GENERAL | | | | | | | | | |
| Dimensions [W × H × D] (mm) | DIN Chassis | 178 × 50 × 160 | 178 × 100 × 166 | 180 × 50 × 165 | 178 × 100 × 165 | 178 × 100 × 165 | 178 × 50 × 163 | 178 × 50 × 163 | 178 × 50 × 161 |
| | Nose | 188 × 58 × 36 | 171 × 96 × 16 | 188 × 58 × 33 | 171 × 97 × 9 | 171 × 97 × 8 | 188 × 58 × 21 | 188 × 58 × 23 | 188 × 58 × 21 |
| | D Chassis | 178 × 50 × 165 | — | 178 × 50 × 165 | — | — | 178 × 50 × 163 | 178 × 50 × 163 | 178 × 50 × 166 |
| | Nose | 170 × 46 × 31 | — | 170 × 46 × 28 | — | — | 170 × 46 × 21 | 170 × 48 × 23 | 170 × 46 × 16 |
| | Hide-away unit (Chassis) | 280 × 37 × 171 | — | — | — | — | — | — | 179 × 28 × 100 |

*Peak momentary power output

Two versions are available for the AVH-P7950DVD, AVH-P6050DVD, AVH-P5150DVD, AVH-P4150DVD, AVH-P3150DVD, DVH-P4150UB, DVH-3150UB and XDV-P650.
Region 4: For Oceania and Latin America
Region 3: For Southeast Asia

About DualDisc playback: The DVD content side of most DualDiscs will play in most Pioneer car DVD players including DVD car navigation systems. Please use a Pioneer DVD Audio player to play DVD Audio content on DualDisc. Please note that the insertion or ejection of a DualDisc into/from Pioneer's DVD products is likely to cause scratches to the surface of the DualDisc. Scratched discs may not play. A DualDisc could get stuck in and may not be able to be removed from certain Pioneer products. For car slot-in type DVD players including car navigation systems, there is a possibility of mechanical jam. The non-DVD side of a DualDisc is not compliant with the Compact Disc Digital Audio Specification. Accordingly, the non-DVD side of a DualDisc may not play in Pioneer products.

Displays Specifications

| | | AVD-W7900 |
|---|--|---|
| LCD MONITOR | | |
| Display | | Color liquid crystal display TFT active matrix driving system |
| Display size | | 7-inch (16:9) wide |
| Picture size (mm) | | 154 × 87 |
| Picture segment (pixels) | | 336 960 (1 440 × 234) |
| GENERAL | | |
| DIN chassis dimensions [W × H × D] (mm) | | 178 × 118 × 32 |

Hide-Away TV Tuners Specifications

| | | GEX-P5750TVP | GEX-P5750TV |
|-------------------------------------|--|--|---|
| TV TUNER | | | |
| Color system | | TV: PAL/SECAM compatible Video: NTSC/PAL/PAL-M/SECAM compatible | TV: NTSC/PAL-M compatible Video: NTSC/PAL/PAL-M/SECAM compatible |
| Channel coverage* (ch) | | CCIR/B, G, H: VHF 2 to 12 UHF 21 to 69 Indonesia/B, G, H: VHF A to H2 UHF 21 to 69 China/D, K: VHF A to K UHF 21 to 69 UK, Ireland/I: VHF R1 to R12 UHF 21 to 69 OIRT/D, K: VHF 2 to 12 UHF 21 to 69 Australia/B, G, H: VHF 0 to 11 UHF 28 to 69 South Africa/I: VHF 4 to 11, 13 UHF 21 to 69 | VHF 2 to 13 UHF 14 to 69 |
| Composite A/V output | | Output × 2 | Output × 2 |
| GENERAL | | | |
| Chassis dimensions [W × H × D] (mm) | | 172 × 30 × 150 | 172 × 30 × 150 |

*Reception channels and TV reception system standards are set automatically, according to reception area selected.

A/V Units Terminal Comparison

| | AVH-P7950DVD | AVH-P6050DVD | AVH-P5150DVD | AVH-P4150DVD | AVH-P3150DVD | DVH-P4150UB | DVH-3150UB | DEQ-P7650 | XDV-P650 | AXM-P7650 | AVD-W7900 |
|---------------------------------------|------------------|------------------|--------------|--------------|--------------------|--------------------|----------------------|------------------|------------------|-----------|-----------|
| INPUT | | | | | | | | | | | |
| IP-Bus input | ● | ● | ● | ● | ● | ● | ● | ● | ● | ● | ● |
| AV-Bus input | ● | ● | ● | ● | ● | ● | ● | ● | ● | ● | ● |
| Optical digital input | ● | ● | ● | ● | ● | ● | ● | ● | ● | ● | ● |
| RCA Audio input | 2 | 2 ⁽¹⁾ | 1 | 1 | 1 | 1 | 1 | 2 | 2 | 1 | 2 |
| RCA Video input | 2 ⁽¹⁾ | 2 ⁽¹⁾ | 1 | 1 | 1 | 1 | 1 | 2 | 2 | 1 | 2 |
| Audio/Video input (mini jack type) | Audio | Audio | A/V | A/V | A/V ⁽²⁾ | A/V ⁽²⁾ | Audio ⁽²⁾ | | | | |
| RGB input | ● | ● | ● | ● | ● | ● | ● | ● | ● | ● | ● |
| Rear view camera input ⁽³⁾ | ● | ● | ● | ● | ● | ● | ● | ● | ● | ● | ● |
| OUTPUT | | | | | | | | | | | |
| IP-Bus output | | | | | | | | ● | ● ⁽⁴⁾ | | |
| Optical digital output | | ● | ● | ● | ● | ● | ● | ● | ● | ● | ● |
| RCA pre-out | 9 ⁽⁵⁾ | 3 | 2 | 3 | 2 | 2 | 1 | 6 ⁽⁶⁾ | | | |
| RCA Audio output | 1 | | | | | | | | ● | | 1 |
| RCA Video output | 1 | 1 | 1 | 1 | 1 | 1 | 1 | | 2 ⁽⁷⁾ | | 1 |

(1) Input 1: Audio/Video, Input 2: Audio/Video or rear view camera (2) On front panel (3) Camera not included (4) Analog for front (5) 9-channel RCA pre-outs (6) 6-channel RCA pre-outs (7) Front + rear

Multi-Channel Processor Specifications

| | | DEQ-P7650 |
|-------------------------------------|--|----------------|
| AMPLIFIER | | |
| Max. power output* | | 50 W × 5 |
| Continuous power output | | 22 W × 5 |
| GENERAL | | |
| Chassis dimensions [W × H × D] (mm) | | 237 × 29 × 171 |

*Peak momentary power output

A/V Selector Specifications

| | | CD-VS33 |
|--|-------------------------------------|---------------------------------|
| VIDEO (composite input/output) | | |
| Input/output level (PAL/NTSC/SECAM compatible through outputs from video input 1 to 3) | | 1 Vp-p/75 Ω |
| GENERAL | | |
| Dimensions [W × H × D] (mm) | Hide-away unit (Chassis) Controller | 160 × 28 × 120 120 × 60 × 32 |

Audio Master Unit Specifications

| | | AXM-P90RS |
|-----------------------------|----------------------------------|-----------------------------------|
| GENERAL | | |
| Dimensions [W × H × D] (mm) | Display Hide-away unit (Chassis) | 165 × 44 × 16.4 252 × 40 × 152 |

Multi-Channel Processor Controller Specifications

| | | AXM-P7650 |
|-----------------------------|----------------------------------|---------------------------------|
| GENERAL | | |
| Dimensions [W × H × D] (mm) | Chassis Hide-away unit (Chassis) | 119 × 37 × 20 100 × 28 × 136 |

Headunits Features Comparison

| | DEHP7150UB | DEH6150BT | DEHP5150UB | DEH4150SD | DEH3150UB | DEH2150UBG | DEH1150MPG | FH-P6050UB | CDX-P1260 | CDX-P680 | KEH-P2085 | RS-D7R11 | DEX-P90RS | DEHP80RSII | RS-P90 | DEQ-P90 |
|---|---|------------------|------------------|------------------|------------------|------------------|------------|------------------|-----------|----------|-----------|----------|-----------|------------|--------|---------|
| USB/iPod/SD Memory Card/Bluetooth® CONTROL | | | | | | | | | | | | | | | | |
| USB direct connection <F = Front> | ● | F ⁽¹⁾ | F ⁽¹⁾ | F ⁽¹⁾ | F ⁽¹⁾ | F ⁽¹⁾ | | ● | | | | | | | | |
| USB adapter ready (External unit control) | | | | | | | | | | | | | | | | ● |
| USB text | ● | ● | ● | ● | ● | ● | | ● | | | | | | | | |
| Direct connection for iPod | ● ⁽²⁾ | ● ⁽²⁾ | ● ⁽²⁾ | ● ⁽²⁾ | | | | ● ⁽²⁾ | | | | | | | | |
| Direct connection for iPhone | | ● ⁽²⁾ | ● ⁽²⁾ | ● ⁽²⁾ | | | | | | | | | | | | |
| Adapter ready for iPod (CD-IB100II) <E = External unit control> | ● | | | | | | | ● | | | E | ● | E | ● | | |
| List search for iPod | ● | ● | ● | ● | | | | ● | | | | | | | | |
| Link Play for iPod | ● ⁽³⁾ | ● | ● | ● | | | | ● ⁽³⁾ | | | | | | | | |
| Built-in SD memory card slot (SDHC compatible) | | | | ● | | | | | | | | | | | | |
| Built-in Bluetooth® Wireless Technology | | ● | | | | | | | | | | | | | | |
| Bluetooth® adapter ready <E = External unit control> | ● | | ● | | | | | ● | | | | E | E | E | | |
| CD PLAYER | | | | | | | | | | | | | | | | |
| CD-R/RW playback <S = With skip play> | ● | ● | ● | ● | ● | ● | ● | ● | S | S | | | ● | ● | ● | |
| WMA (Windows Media™ Audio) playback with WMA Tag ⁽⁴⁾ | ● | ● | ● | ● | ● | ● | ● | ● | | | | | | | | |
| MP3 playback with ID3 Tag ⁽⁴⁾ | ● | ● | ● | ● | ● | ● | ● | ● | | | | | | | | |
| iTunes AAC playback ⁽⁴⁾ | ● | ● | ● | ● | ● | ● | ● | ● | | | | | | | | |
| WAV file playback ⁽⁴⁾ | ● | ● | ● | ● | ● | ● | ● | ● | | | | | | | | |
| Folder/file list search (CD-ROM) | ● | ● | ● | ● | ● | ● | ● | ● | | | | | | | | |
| D/A Converters with 8x oversampling digital filter <24 = Multi 24-bit, B = Burr Brown, 1 = 1-bit> | 1 | 1 | 1 | 1 | 1 | 1 | 1 | 1 | 1 | 1 | | | 24 | | B | |
| Digital direct | | | | | | | | | | | | | ● | ● | ● | |
| Track scan | ● | ● | ● | ● | ● | ● | ● | ● | | | | | ● | ● | ● | |
| CD pause | ● | ● | ● | ● | ● | ● | ● | ● | | | | | ● | ● | ● | |
| Track/manual search | | | | | | | | | ● | ● | | | ● | ● | | |
| Disc exist search | | | | | | | | | ● | ● | | | | | | |
| Repeat (CD-DA: disc/track, CD-ROM: file/folder) <C = CD-DA only, M = Magazine/disc/track> | ● | ● | ● | ● | ● | ● | ● | ● | M | M | | | C | C | ● | |
| Random play <M = Magazine, D = Disc> | D | D | D | D | D | D | D | D | M/D | M/D | | | D | D | D | |
| Disc title memory (48 titles) | ● | ● | ● | ● | ● | ● | ● | ● | | | | | ● | ● | ● | |
| CD error code transmission capabilities | | | | | | | | | ● | ● | | | | | | |
| One-day memory backup | | | | | | | | | ● | ● | | | | | | |
| Last position memory | | | | | | | | | ● | ● | | | | | | |
| CD Text | ● | ● | ● | ● | ● | ● | ● | ● | ● | ● | | | ● | ● | ● | |
| Digital compression | | | | | | | | ● | | | | | | | | |
| BMX (Bitmetric Equalizer) | | | | | | | | ● | | | | | | | | |
| CASSETTE PLAYER | | | | | | | | | | | | | | | | |
| Radio intercept | | | | | | | | | | | | ● | | | | |
| TUNER | | | | | | | | | | | | | | | | |
| Supertuner® (IIID+ = Supertuner® IIID+, IIID = Supertuner® IIID, III™ = Supertuner® III™) | IIID | IIID | IIID | IIID | IIID | IIID | IIID | IIID | | | | ● | III™ | III™ | IIID+ | |
| BSM (Best Stations Memory) | ● | ● | ● | ● | ● | ● | ● | ● | | | | | ● | ● | ● | |
| Local seek tuning | ● | ● | ● | ● | ● | ● | ● | ● | | | | | ● | ● | ● | |
| 24-station (18 FM/6 AM) presets | ● | ● | ● | ● | ● | ● | ● | ● | | | | | ● | ● | ● | |
| 9 kHz/10 kHz AM channel spacing switch <9 = 9 kHz only> | ● | ● | ● | ● | ● | ● | ● | ● | | | | | 9 | 9 | ● | |
| AUDIO | | | | | | | | | | | | | | | | |
| High precision sound master clock circuitry | | | | | | | | | | | | | ● | | | |
| Hi-bit conversion | | | | | | | | | | | | | ● | ● | | |
| High-power output | MOSFET 50 W × 4 (max.) 45 W × 4 (max.) | ● | ● | ● | ● | ● | ● | ● | | | | | | | | ● |
| Gold-plated 8-channel RCA output (high/mid/low/subwoofer) | | | | | | | | | | | | | | | | ● |
| 3 RCA pre-outs | Front + Rear + Non-fading <G = Gold-plated> | | | | | | | | | | | | | | G | |
| | Front + Rear + Subwoofer <G = Gold-plated> | ● | ● | | | | | | | | | | | | | G |
| 2 RCA pre-outs | Front + Rear/Subwoofer (selectable) | | | ● | | | | | | | | | | | | |
| | Front + Rear | | | | ● | | | | | | | | | | | |
| RCA pre-out | Rear/Subwoofer (selectable) | | ● | | | | | | | | | | | | | |
| | Rear | | | | | | | | | | | ● | | | | |
| High-voltage pre-out (V) | | 4 | 4 | | | | | 4 | | | | | | 4 | 5 | 4 |
| IP-Bus input/output <I = Input> | I | I | I | | | | | I | I | I | I | ● | ● | I | I | I |
| Optical input/output | | | | | | | | | | | | | ● | ● | | |
| Optical input <D = with DEX-P90RS, R = with RS-D7R11> | | | | | | | | | | | | | | | R | D |
| Frequency change: 96 kHz to 44.1 kHz | | | | | | | | | | | | | ● | | | |
| Advanced Sound Retriever | | ● | ● | ● | ● | ● | | ● | | | | | | | | |
| DSP/EEQ | Built-in DSP (Digital Signal Processor) | | | | | | | | | | | | | | ● | ● |
| | EEQ (Easy Equalizer) | ● | ● | ● | ● | ● | ● | ● | | | | | | | ● | |
| | Multi 24-bit Burr Brown D/A Converters | | | | | | | | | | | | | | | ● |
| | Burr Brown advanced segment-type 24-bit D/A Converter | | | | | | | | | | | | | | | ● |

Headunits Specifications

| | 1-DIN Players | | | | | | | | Component Add-on DSP Units | |
|--|---------------|------------|----------------|----------------|----------------|----------------|----------------|----------------|----------------------------|-----------------------|
| | DEH-P7150UB | DEH-6150BT | DEH-P5150UB | DEH-4150SD | DEH-3150UB | DEH-2150UBG | DEH-1150MPG | RS-P90 | DEQ-P90 | |
| CD PLAYER | | | | | | | | | | |
| S/N ratio [1 kHz, IEC-A Network] | dB | 94 | 94 | 94 | 94 | 94 | 94 | 94 | — | — |
| TUNER | | | | | | | | | | |
| Frequency range | FM | MHz | 87.5 to 108 | 87.5 to 108 | 87.5 to 108 | 87.5 to 108 | 87.5 to 108 | 87.5 to 108 | — | — |
| | AM [10 kHz] | kHz | 530 to 1 640 | 530 to 1 640 | 530 to 1 640 | 530 to 1 640 | 530 to 1 640 | 530 to 1 640 | — | — |
| | | kHz | 531 to 1 602 | 531 to 1 602 | 531 to 1 602 | 531 to 1 602 | 531 to 1 602 | 531 to 1 602 | — | — |
| FM usable sensitivity [75 Ω, mono, S/N: 30 dB] | dBf | 9 [0.7 μV] | 9 [0.8 μV] | 9 [0.7 μV] | 9 [0.7 μV] | 11 [0.7 μV] | 11 [0.7 μV] | 11 [0.7 μV] | — | — |
| AM usable sensitivity [S/N: 20 dB] | μV | 25 | 25 | 25 | 25 | 25 | 25 | 25 | — | — |
| COMPONENT ADD-ON DSP UNIT | | | | | | | | | | |
| Equalization frequency | Hz | — | — | — | — | — | — | — | 20 to 20 000 | 20 to 20 000 |
| Equalization range | dB | — | — | — | — | — | — | — | ±12 | ±12 |
| Distortion [1 kHz, 500 mV, 20 KLPF] | % | — | — | — | — | — | — | — | 0.002 | 0.005 |
| Frequency response [–1 dB] | Hz | — | — | — | — | — | — | — | 10 to 20 000 | 10 to 20 000 |
| S/N ratio [IEC-A network] | dB | — | — | — | — | — | — | — | 115 | 109 |
| Output impedance | Ω | — | — | — | — | — | — | — | 220 | 1 k |
| Max. output level | | — | — | — | — | — | — | — | 4.0 V/1 kHz, 1% dist. | 4.0 V/1 kHz, 1% dist. |
| AUDIO | | | | | | | | | | |
| Max. power output* | | 50 W × 4 | 50 W × 4 | 50 W × 4 | 50 W × 4 | 50 W × 4 | 50 W × 4 | 50 W × 4 | — | — |
| Continuous power output | | 22 W × 4 | 22 W × 4 | 22 W × 4 | 22 W × 4 | 22 W × 4 | 22 W × 4 | 22 W × 4 | — | — |
| GENERAL | | | | | | | | | | |
| Dimensions [W × H × D] | DIN—Chassis | mm | 178 × 50 × 165 | 178 × 50 × 162 | 178 × 50 × 162 | 178 × 50 × 162 | 178 × 50 × 162 | 178 × 50 × 165 | 178 × 50 × 162 | 240 × 59 × 240 |
| | Nose | mm | 188 × 58 × 18 | 188 × 58 × 24 | 188 × 58 × 17 | 188 × 58 × 24 | 188 × 58 × 22 | 188 × 58 × 15 | 188 × 58 × 15 | — |
| | D—Chassis | mm | 178 × 50 × 165 | 178 × 50 × 162 | 178 × 50 × 162 | 178 × 50 × 162 | 178 × 50 × 162 | 178 × 50 × 165 | 178 × 50 × 162 | — |
| | Nose | mm | 170 × 45 × 18 | 170 × 46 × 24 | 170 × 48 × 17 | 170 × 46 × 24 | 170 × 48 × 22 | 170 × 48 × 15 | 170 × 48 × 15 | — |

*Peak momentary power output

Power Amplifiers Features Comparison

| | GM-6400F | GM-5400T | GM-D8400M | GM-D7400M | GM-3300T | RS-A9 | RS-A7 | PRS-D2000SPL | PRS-D1200SPL | PRS-D4200F | PRS-D2200T | PRS-D1200M | PRS-A900 |
|--|------------------|------------------|------------------|------------------|----------|-------|-------|------------------|------------------|------------------|------------------|------------------|------------------|
| Bridgeable 4/3/2-channel capability <F = Class-FD> | ● | | | | | | | | | F | | | ● |
| Bridgeable 2/1-channel capability <F = Class-FD> | | ● | | | | | | | | | F | | |
| Mono amplifier <D = Class-D> | | | D | D | | | | D | D | | | D | |
| Current feedback amplifier | | | | | | ● | ● | | | | | | ● |
| Single-ended output circuit | | | ● | ● | | | | | | | | | ● |
| L/R independent power supply | | | | | | ● | ● | | | | | | ● |
| L/R symmetric layout circuit | | | | | | | | | | | | | ● |
| Full balanced system (bridgeable connection) | | | | | | ● | ● | | | | | | ● |
| High-performance 32-bit floating binary point type DSP | | | | | | ● | | | | | | | |
| Built-in DSP (Digital Signal Processor) (FIR) | | | | | | ● | | | | | | | |
| Multi 24-bit Burr Brown D/A Converters | | | | | | ● | ● | | | | | | |
| Variable LPF/HPF (40 Hz to 500 Hz, -12 dB/oct.) | | | | | | | | | | ● | ● | | |
| Variable LPF (40 Hz to 240 Hz, -24 dB/oct.) | | | | | | | | ● | ● | | | | |
| Variable LPF (40 Hz to 240 Hz, -18 dB/oct.) | | | | | | | | | | | | | ● |
| Variable LPF (40 Hz to 240 Hz, -12 dB/oct.) | | | | | | | | | | | | | |
| LPF/HPF (80 Hz, -12 dB/oct.) for A and B channels | ● | | | | | | | | | | | | |
| LPF (80 Hz, -12 dB/oct.) | | ● | | | | | | | | | | | |
| Input level control (400 mV to 6.5 V) <L/R = L/R independent> | | | | | ● | | | ● | ● | ● | ● | ● | L/R |
| Input level control (200 mV to 6.5 V) | ● | ● | ● | ● | | | | | | | | | |
| Low load impedance capability (4 Ω, 2 Ω to 8 Ω allowable) | ● | ● | ● | ● | ● | ● | ● | | | ● | ● | | ● |
| Low load impedance capability (1 Ω to 8 Ω) | | | | | | | | ● | ● | | | | ● |
| Optical digital input | | | | | | 1 | 2 | | | | | | |
| 3 optical digital outputs (mid/low/subwoofer) | | | | | | ● | | | | | | | |
| IP-Bus input/output | | | | | | ● | ● | | | | | | |
| RCA input and output terminals <G = Gold-plated> | ● ⁽¹⁾ | | | | | | | G | G | G | G | G | |
| RCA input terminals <G = Gold-plated> | | ● | ● | ● | ● | | | | | | | | G |
| Screw-type speaker terminals <G = Gold-plated> | ● | ● | | | ● | G | G | | | | | | |
| Large block-type speaker terminals <G = Gold-plated> | | | ● ⁽²⁾ | ● ⁽²⁾ | | | | G ⁽³⁾ | G ⁽³⁾ | G ⁽²⁾ | G ⁽²⁾ | G ⁽²⁾ | G ⁽⁴⁾ |
| Large screw-type power/ground terminals <G = Gold-plated> | ● | ● | | | ● | G | G | | | | | | |
| Large block-type power/ground terminals <G = Gold-plated> | | | ● ⁽⁵⁾ | ● ⁽⁵⁾ | | | | G ⁽⁶⁾ | G ⁽³⁾ | G ⁽⁵⁾ | G ⁽⁵⁾ | G ⁽⁵⁾ | G ⁽⁵⁾ |
| Speaker level input (0.8 V to 26 V) | | | ● | ● | | | | | | | | | |
| Speaker level input (1.6 V to 26 V) | ● | ● | | | ● | | | | | ● | ● | ● | |
| Speaker line input turn-on sensor | | | ● | ● | | | | | | ● | ● | ● | |
| Bass Boost (40 Hz to 120 Hz, 0 dB to +12 dB variable) <R = Remote> | | | | | | | | R | R | | | | |
| Bass Boost (50 Hz, 0 dB to 12 dB variable) <R = Remote> | | | R | | | | | | | | | | |
| Bass Boost (50 Hz, 0 dB/+6 dB/+9 dB/+12 dB) <R = Remote> | | ● ⁽⁷⁾ | | ● ⁽⁷⁾ | | | | | | | R | R | |
| Subsonic filter (20 Hz, -24 dB/oct.) | | | | | | | | ● | ● | | | | |
| Subsonic filter (20 Hz, -18 dB/oct.) | | | | | | | | | | | | | ● |
| SYNC control | | | | | | | | ● | ● | | | | ● |
| PWM regulated power supply with MOSFET switching | ● | ● | | | | | | | | ● | ● | ● | ● |
| High-performance balanced isolator circuit | ● | ● | | | ● | | | ● | ● | ● ⁽⁸⁾ | ● ⁽⁸⁾ | ● ⁽⁸⁾ | ● |
| High-efficiency MOSFET output section | | | ● | ● | | | | ● | ● | ● | ● | ● | ● |
| Multi Emitter Bipolar Transistor | | | | | | | | | | | | | ● |
| MASS (Multiple Amplifier Synchronization System) | | | | | | | | ● | ● | | | | ● |
| Sound master clock | | | | | | ● | ● | | | | | | |
| DAC volume | | | | | | ● | ● | | | | | | |
| All terminals placed on one side | | | | | | | | | | ● | ● | ● | ● |
| Removable terminal/settings cover | | | | | | | | | | ● | ● | ● | ● |
| TVC (Total Vibration Control) technology | | | | | | | | ● | ● | ● | ● | ● | ● |
| Copper-plated chassis | | | | | | ● | ● | | | | | | |
| Black heatsink with aluminum plate | | | ● | ● | ● | | | | | | | | |
| Black metallic mesh with silver plate | ● | ● | | | | | | | | | | | |

(1) Output for A-channel (2) 12 to 16-gauge (3) 4-gauge (4) 12 to 18-gauge (5) 4 to 8-gauge (6) 0/1-gauge (7) Bass Boost level: 0 dB/+6 dB/+12 dB only (8) Input circuit

Power Amplifiers Specifications

| | | GM-6400F | GM-5400T | GM-D8400M | GM-D7400M | GM-3300T | RS-A9 | RS-A7 | PRS-D2000SPL | PRS-D1200SPL | PRS-D4200F | PRS-D2200T | PRS-D1200M | PRS-A900 |
|----------------------------------|-------------------|----------------------------------|------------------------------------|-------------------------------------|------------------------------------|----------------------------------|----------------------------------|----------------------------------|--|--|-----------------------------------|------------------------------------|--|----------------------------------|
| Max. power output [14.4 V] | 4-channel mode | 120 W × 4 (4 Ω) | — | — | — | — | 100 W × 4 (4 Ω) | 100 W × 4 (4 Ω) | — | — | 150 W × 4 (4 Ω) | — | — | 100 W × 4 (4 Ω) |
| | 3-channel mode | 120 W × 2 + 300 W × 1 (4 Ω) | — | — | — | — | 100 W × 2 + 300 W × 1 (4 Ω) | 100 W × 2 + 300 W × 1 (4 Ω) | — | — | 150 W × 2 + 600 W × 1 (4 Ω) | — | — | 100 W × 2 + 200 W × 1 (4 Ω) |
| | 2-channel mode | 300 W × 2 (4 Ω) | 250 W × 2 (4 Ω) | — | — | 120 W × 2 (4 Ω) | 300 W × 2 (4 Ω) | 300 W × 2 (4 Ω) | — | — | 600 W × 2 (4 Ω) | 300 W × 2 (4 Ω) | — | 200 W × 2 (4 Ω) |
| | 1-channel mode | — | 760 W × 1 (4 Ω) | 600 W × 1 (4 Ω) 1200 W × 1 (2 Ω) | 400 W × 1 (4 Ω) 800 W × 1 (2 Ω) | 300 W × 1 (4 Ω) | — | — | 1500 W × 1 (4 Ω) 3000 W × 1 (2 Ω) 4000 W × 1 (1 Ω) | 1000 W × 1 (4 Ω) 2000 W × 1 (2 Ω) 2400 W × 1 (1 Ω) | — | 1200 W × 1 (4 Ω) | 800 W × 1 (4 Ω) 1200 W × 1 (2 Ω) | — |
| Continuous power output [14.4 V] | 4-channel mode | 60 W × 4 (4 Ω) 75 W × 4 (2 Ω) | — | — | — | — | 50 W × 4 (4 Ω) 75 W × 4 (2 Ω) | 50 W × 4 (4 Ω) 75 W × 4 (2 Ω) | — | — | 75 W × 4 (4 Ω) 150 W × 4 (2 Ω) | — | — | 50 W × 4 (4 Ω) 50 W × 4 (2 Ω) |
| | 3-channel mode | 60 W × 2 + 150 W × 1 (4 Ω) | — | — | — | — | 50 W × 2 + 150 W × 1 (4 Ω) | 50 W × 2 + 150 W × 1 (4 Ω) | — | — | 75 W × 2 + 300 W × 1 (4 Ω) | — | — | 50 W × 2 + 100 W × 1 (4 Ω) |
| | 2-channel mode | 150 W × 2 (4 Ω) | 125 W × 2 (4 Ω) 190 W × 2 (2 Ω) | — | — | 60 W × 2 (4 Ω) 75 W × 2 (2 Ω) | 150 W × 2 (4 Ω) | 150 W × 2 (4 Ω) | — | — | 300 W × 2 (4 Ω) | 150 W × 2 (4 Ω) 300 W × 2 (2 Ω) | — | 100 W × 2 (4 Ω) |
| | 1-channel mode | — | 380 W × 1 (4 Ω) | 300 W × 1 (4 Ω) 600 W × 1 (2 Ω) | 200 W × 1 (4 Ω) 400 W × 1 (2 Ω) | 150 W × 1 (4 Ω) | — | — | 750 W × 1 (4 Ω) 1500 W × 1 (2 Ω) 2000 W × 1 (1 Ω) | 500 W × 1 (4 Ω) 1000 W × 1 (2 Ω) 1200 W × 1 (1 Ω) | — | 600 W × 1 (4 Ω) | 400 W × 1 (4 Ω) 600 W × 1 (2 Ω) 600 W × 1 (1 Ω)* | — |
| Frequency response | +0 dB, -1 dB Hz | 10 to 50 000 | 10 to 50 000 | — | — | 10 to 50 000 | 10 to 100 000 | 10 to 100 000 | — | — | — | — | — | 10 to 100 000 |
| | +0 dB, -3 dB Hz | — | — | 10 to 240 | 10 to 240 | — | — | — | 10 to 240 | 10 to 240 | 10 to 50 000 | 10 to 50 000 | 10 to 240 | — |
| | +0.5 dB, -3 dB Hz | — | — | — | — | — | — | — | — | — | — | — | — | — |
| Total harmonic distortion | % | 0.03 | 0.03 | 0.3 | 0.3 | 0.008 | 0.002 | 0.002 | 0.3 | 0.3 | 0.005 | 0.005 | 0.03 | 0.003 |
| S/N ratio [IEC-A network] | dB | 95 | 95 | 80 | 80 | 100 | 105 | 105 | 85 | 80 | 100 | 100 | 92 | 108 |
| Dimensions (W × H × D) | mm | 265 × 62 × 346 | 265 × 62 × 346 | 290 × 56 × 200 | 225 × 56 × 200 | 300 × 60 × 194 | 585 × 330 × 71 | 585 × 330 × 71 | 586 × 282 × 65 | 381 × 282 × 65 | 301 × 57 × 213 | 301 × 57 × 213 | 301 × 57 × 213 | 282 × 65 × 371 |

*Hi-current mode

Notes: Windows Media and the Windows logo are trademarks, or registered trademarks of Microsoft Corporation in the United States and/or other countries.
 iPod is for legal or rightholder-authorized copying only. Don't steal music. iPod is a trademark of Apple Inc., registered in the U.S. and other countries.
 iPhone is a trademark of Apple Inc.
 iTunes is a trademark of Apple Inc., registered in the U.S. and other countries. AAC players can decode only those AAC files ripped and encoded using iTunes.
 Unauthorized copying of music is strictly prohibited. Not every device is compatible. See more details in Pioneer website. Compatible with USB memory device only.
 Not compatible with DRM (Digital Rights Management) contents and MTP (Media Transfer Protocol) connection players.
 SD and *SDHC* Logos are trademarks.
 Bluetooth® and associated logos are trademarks of Bluetooth SIG, Inc.
 Parrot and Parrot logo are registered trademarks of Parrot SA.
 DivX, DivX Certified and associated logos are trademarks of DivX, Inc. and are used under license.
 Dolby, Pro Logic and the double-D symbol are registered trademarks of Dolby Laboratories.
 DTS, DTS-ES, DTS Neo:6 and DTS 96/24 are registered trademarks of Digital Theater System, Inc.

Subwoofers & Speakers Specifications

| | Size | Max. Input | Nominal Input | Frequency Response | Sensitivity | Impedance | Dimensions (W x H x D) | Mounting Depth | Cut-Out Dimensions |
|-------------|-------------------------------|--|---------------------|---|-----------------------|------------|--|--|--|
| TS-W01RSII | 25 cm | 300 W | 150 W | 25 Hz to 3 800 Hz | 86 dB | 4 Ω | ø276 mm x 94 mm | 75 mm | ø238 mm |
| TS-M01RSII | 17 cm | 120 W | 50 W | 35 Hz to 12 000 Hz | 89 dB | 4 Ω | ø174 mm x 75 mm | 69 mm | ø151 mm |
| TS-S01RSII | 7.7 cm | 50 W ⁽¹⁾ 60 W ⁽²⁾ | 15 W | 70 Hz to 24 000 Hz ⁽¹⁾ 120 Hz to 24 000 Hz ⁽²⁾ | 86 dB | 4 Ω | ø90 mm x 42.5 mm ⁽¹⁾ ø90 mm x 67 mm ⁽²⁾ | 37.5 mm ⁽¹⁾ 60 mm ⁽²⁾ | ø72.5 mm ⁽¹⁾ ø77 mm ⁽²⁾ |
| TS-T01RSII | 3.5 cm | 120 W | 50 W | 1 000 Hz to 48 000 Hz | 95 dB | 6 Ω | ø68 mm x 64 mm | — | — |
| TS-W12PRS | 30 cm | 1 200 W | 300 W | 15 Hz to 2 000 Hz | 92 dB | 2 Ω or 8 Ω | ø322 mm x 152 mm | 133 mm | ø278 mm |
| TS-M17PRS | 17 cm | 200 W | 50 W | 25 Hz to 9 000 Hz | 88 dB | 4 Ω | ø156 mm x 78 mm | 67 mm | ø158 mm |
| TS-S101PRS | 10 cm | 60 W | 15 W | 60 Hz to 30 000 Hz | 86 dB | 4 Ω | ø110 mm x 52 mm | 46 mm | ø90 mm |
| TS-T031PRS | 28 mm | 200 W | 50 W | 1 200 Hz to 32 000 Hz | 90 dB | 4 Ω | ø55 mm x 27.1 mm | 12.2 mm | ø47 mm |
| TS-C171PRS | 17 cm | 200 W | 50 W | 25 Hz to 32 000 Hz | 88 dB | 4 Ω | ø156 mm x 78 mm | 67 mm | ø140 mm |
| TS-C131PRS | 13 cm | 150 W | 30 W | 35 Hz to 32 000 Hz | 88 dB | 4 Ω | ø129 mm x 67 mm | 57.3 mm | ø121 mm |
| TS-WB102SPL | 38 cm | 8 000 W | 3 000 W | 15 Hz to 1 500 Hz | 91 dB | 1 Ω or 4 Ω | ø400 mm x 359.5 mm | 312 mm | ø352 mm |
| TS-W5102SPL | 30 cm | 6 000 W | 2 500 W | 18 Hz to 2 000 Hz | 88 dB | 1 Ω or 4 Ω | ø327 mm x 304 mm | 266 mm | ø278 mm |
| TS-W3002D4 | 30 cm | 3 500 W | 1 000 W | 20 Hz to 150 Hz | 90 dB | 2 Ω or 8 Ω | ø329 mm x 214 mm | 188.8 mm | ø278 mm |
| TS-W2502D4 | 25 cm | 3 000 W | 800 W | 20 Hz to 150 Hz | 89 dB | 2 Ω or 8 Ω | ø283 mm x 193 mm | 169 mm | ø238 mm |
| TS-W308D2 | 30 cm | 1 400 W | 400 W | 20 Hz to 180 Hz | 91 dB | 2 Ω DVC | ø327 mm x 172 mm | 153 mm | ø278 mm |
| TS-W308D4 | 30 cm | 1 400 W | 400 W | 20 Hz to 180 Hz | 92 dB | 4 Ω DVC | ø327 mm x 172 mm | 153 mm | ø278 mm |
| TS-W258D2 | 25 cm | 1 200 W | 350 W | 20 Hz to 450 Hz | 90 dB | 2 Ω DVC | ø277 mm x 162 mm | 143 mm | ø238 mm |
| TS-W258D4 | 25 cm | 1 200 W | 350 W | 20 Hz to 450 Hz | 90 dB | 4 Ω DVC | ø277 mm x 162 mm | 143 mm | ø238 mm |
| TS-W308F | 30 cm | 1 000 W | 300 W | 20 Hz to 1 100 Hz | 95 dB | 4 Ω | ø327 mm x 162 mm | 143 mm | ø302 mm |
| TS-W258F | 25 cm | 800 W | 250 W | 20 Hz to 1 400 Hz | 92 dB | 4 Ω | ø277 mm x 150 mm | 131 mm | ø255 mm |
| TS-W302R | 30 cm | 800 W | 150 W | 20 Hz to 90 Hz | 97 dB | 4 Ω | ø327 mm x 164 mm | 145 mm | ø278 mm |
| TS-W252R | 25 cm | 600 W | 120 W | 20 Hz to 110 Hz | 95 dB | 4 Ω | ø277 mm x 154 mm | 135 mm | ø238 mm |
| TS-SW3001S2 | 30 cm | 1 500 W | 400 W | 20 Hz to 230 Hz | 93 dB | 2 Ω | ø329 mm x 100 mm | 81 mm | ø278 mm |
| TS-SW3001S4 | 30 cm | 1 500 W | 400 W | 20 Hz to 230 Hz | 93 dB | 4 Ω | ø329 mm x 100 mm | 81 mm | ø278 mm |
| TS-SW2501S2 | 25 cm | 1 200 W | 300 W | 20 Hz to 290 Hz | 90 dB | 2 Ω | ø282 mm x 93 mm | 75.1 mm | ø238 mm |
| TS-SW2501S4 | 25 cm | 1 200 W | 300 W | 20 Hz to 290 Hz | 90 dB | 4 Ω | ø282 mm x 93 mm | 75.1 mm | ø238 mm |
| TS-SW841D | 20 cm | 500 W | 120 W | 30 Hz to 1 500 Hz | 85 dB | 4 Ω | ø218.4 mm x 75.2 mm | 63.5 mm | ø186 mm |
| TS-SW301 | 30 cm | 1 000 W | 250 W | 20 Hz to 114 Hz | 91 dB | 4 Ω | ø327 mm x 100 mm | 86 mm | ø278 mm |
| TS-SW251 | 25 cm | 800 W | 200 W | 20 Hz to 144 Hz | 89 dB | 4 Ω | ø278 mm x 92 mm | 78 mm | ø238 mm |
| TS-WX301 | 30 cm | 800 W | 150 W | 20 Hz to 400 Hz | 95 dB | 4 Ω | 501 mm x 389 mm x 415 mm | — | — |
| TS-WX11A | 13 cm x 21 cm | 150 W ⁽³⁾ | 50 W ⁽⁴⁾ | 54 Hz to 200 Hz | 101 dB ⁽⁵⁾ | — | 280 mm x 80 mm x 200 mm | — | — |
| TS-WX22A | 20 cm | 150 W ⁽³⁾ | 60 W ⁽⁴⁾ | 40 Hz to 200 Hz | 101 dB | — | 250 mm x 265 mm x 110 mm | — | — |
| TS-WX206A | 20 cm | 150 W ⁽³⁾ | 60 W ⁽⁴⁾ | 35 Hz to 200 Hz | 107 dB ⁽⁵⁾ | — | 274 mm x 316 mm x 412 mm | — | — |
| TS-D1720C | 17 cm 28 mm ⁽⁶⁾ | 260 W | 60 W | 30 Hz to 33 000 Hz | 88 dB | 4 Ω | ø156 mm x 81.9 mm | 64.5 mm 51 mm ⁽⁶⁾ | ø144 mm |
| TS-D1320C | 13 cm 28 mm ⁽⁶⁾ | 180 W | 35 W | 35 Hz to 33 000 Hz | 88 dB | 4 Ω | ø129 mm x 63.4 mm | 57.5 mm | ø121 mm |
| TS-D6902R | 6" x 9" | 360 W | 80 W | 28 Hz to 30 000 Hz | 90 dB | 4 Ω | 237 mm x 106.2 mm x 163 mm | 89 mm | 220 mm x 151 mm |
| TS-D1702R | 17 cm | 280 W | 60 W | 30 Hz to 32 000 Hz | 87.5 dB | 4 Ω | ø156 mm x 81.9 mm | 64.5 mm | ø144 mm |
| TS-D1602R | 16 cm | 260 W | 60 W | 35 Hz to 32 000 Hz | 88 dB | 4 Ω | ø161 mm x 80.4 mm | 59 mm | ø128 mm |
| TS-D1302R | 13 cm | 180 W | 35 W | 35 Hz to 40 000 Hz | 88 dB | 4 Ω | ø129 mm x 67.8 mm | 57.5 mm | ø121 mm |
| TS-D1002R | 10 cm | 110 W | 25 W | 40 Hz to 40 000 Hz | 86 dB | 4 Ω | ø125 mm x 46.2 mm | 46.5 mm | ø106 mm |
| TS-A1702C | 17 cm 23 mm ⁽⁶⁾ | 230 W | 50 W | 31 Hz to 35 000 Hz | 90 dB | 4 Ω | ø156 mm x 68.5 mm | 62.5 mm 49.5 mm ⁽⁶⁾ | ø139 mm |
| TS-A1302C | 13 cm 23 mm ⁽⁶⁾ | 180 W | 35 W | 36 Hz to 30 000 Hz | 90 dB | 4 Ω | ø129 mm x 58.9 mm | 53 mm | ø121 mm |
| TS-A6993S | 6" x 9" | 460 W | 80 W | 30 Hz to 37 000 Hz | 92 dB | 4 Ω | 237 mm x 163 mm x 109 mm | 85 mm | 151 mm x 220 mm |
| TS-A6983S | 6" x 9" | 440 W | 80 W | 30 Hz to 31 000 Hz | 92 dB | 4 Ω | 237 mm x 163 mm x 108 mm | 84 mm | 151 mm x 220 mm |
| TS-A6973E | 6" x 9" | 400 W | 80 W | 30 Hz to 28 000 Hz | 91 dB | 4 Ω | 237 mm x 163 mm x 104.6 mm | 84 mm | 151 mm x 220 mm |
| TS-A6963E | 6" x 9" | 300 W | 40 W | 30 Hz to 36 000 Hz | 91 dB | 4 Ω | 237 mm x 163 mm x 91.6 mm | 72 mm | 151 mm x 220 mm |
| TS-A6872R | 6" x 8" | 240 W | 40 W | 35 Hz to 32 000 Hz | 90 dB | 4 Ω | 207 mm x 145 mm x 72.5 mm | 62 mm | 191 mm x 133 mm |
| TS-A2503i | 25 cm | 420 W | 80 W | 20 Hz to 31 000 Hz | 92 dB | 4 Ω | ø285 mm x 152 mm | 115 mm | ø236 mm |
| TS-A2003i | 20 cm | 400 W | 80 W | 27 Hz to 32 000 Hz | 90 dB | 4 Ω | ø244 mm x 132 mm | 96 mm | ø202 mm |
| TS-A1683S | 16 cm | 280 W | 50 W | 36 Hz to 28 000 Hz | 91 dB | 4 Ω | ø160 mm x 75 mm | 57 mm | ø128 mm |
| TS-A1673S | 16 cm | 220 W | 35 W | 37 Hz to 25 000 Hz | 91 dB | 4 Ω | ø160 mm x 64 mm | 44 mm | ø128 mm |
| TS-G1642R | 16 cm | 180 W | 30 W | 40 Hz to 30 000 Hz | 90 dB | 4 Ω | ø158 mm x 55 mm | 42 mm | ø142 mm |
| TS-G1612R | 16 cm | 160 W | 30 W | 30 Hz to 25 000 Hz | 90 dB | 4 Ω | ø158 mm x 55 mm | 44 mm | ø142 mm |
| TS-G1342R | 13 cm | 140 W | 25 W | 40 Hz to 25 000 Hz | 89 dB | 4 Ω | ø149 mm x 57 mm | 46 mm | ø129 mm |
| TS-G1312R | 13 cm | 130 W | 25 W | 30 Hz to 25 000 Hz | 89 dB | 4 Ω | ø149 mm x 49 mm | 46 mm | ø129 mm |
| TS-G1042R | 10 cm | 120 W | 25 W | 35 Hz to 30 000 Hz | 87 dB | 4 Ω | ø125 mm x 43 mm | 43 mm | ø106 mm |
| TS-G1012R | 10 cm | 110 W | 20 W | 35 Hz to 29 000 Hz | 87 dB | 4 Ω | ø125 mm x 43 mm | 43 mm | ø106 mm |
| TS-2150 | 20 cm | 200 W | 50 W | 28 Hz to 28 000 Hz | 91 dB | 4 Ω | 238 mm x 238 mm x 176 mm | 88 mm | ø186 mm |
| TS-S250 | 40 mm | 250 W | 50 W | 6 000 Hz to 40 000 Hz | 97 dB | 8 Ω | ø44 mm x 24 mm | — | — |
| TS-S20 | 20 mm | 200 W | 50 W | 3 000 Hz ⁽⁷⁾ / 1 200 Hz ⁽⁸⁾ to 26 000 Hz | 92 dB | 8 Ω | 85.5 mm x 73.5 mm x 32.8 mm | — | — |
| TS-T110 | 22 mm | 120 W | 40 W | 2 500 Hz to 30 000 Hz | 90 dB | 4 Ω | ø47.1 mm x 20.5 mm | — | — |
| TS-T15 | 20 mm | 120 W | 40 W | 2 500 Hz to 30 000 Hz | 90 dB | 4 Ω | ø37.5 mm x 18.9 mm | — | — |
| TS-CX900 | 6.6 cm | 80 W | 20 W | 80 Hz to 70 000 Hz | 85 dB | 4 Ω | 98 mm x 120.5 mm x 41 mm | — | — |
| TS-MR2040 | 20 cm | 200 W | 40 W | 25 Hz to 30 000 Hz | 92 dB | 4 Ω | ø230 mm x 115 mm | 75 mm | ø186 mm |
| TS-MR1640 | 16 cm | 160 W | 30 W | 30 Hz to 30 000 Hz | 91 dB | 4 Ω | ø175 mm x 84.5 mm | 56 mm | ø130 mm |
| TS-MR1600 | 16 cm | 100 W | 25 W | 30 Hz to 20 000 Hz | 90 dB | 4 Ω | ø175 mm x 84.5 mm | 56 mm | ø130 mm |

(1) With speaker unit only (2) With back chamber (3) Maximum output power (4) Nominal output power (5) In-car, at 65 Hz (6) With mounting adapter (7) With network (8) Without network

Dimensions

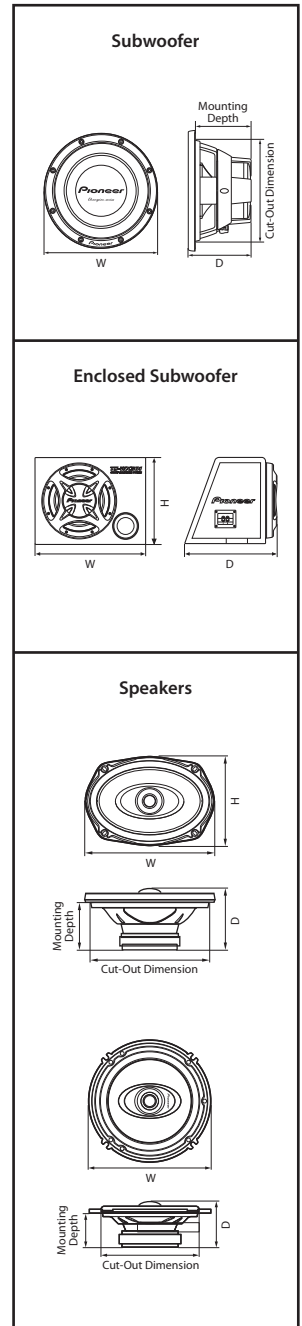

Subwoofer Thiele-Small Parameters*

| | TS-W01RSII ^(*) | TS-W12PRS ^(*) | TS-WB102SPL | TS-W5102SPL | TS-W3002D4 | TS-W2502D4 | TS-W308D2 | TS-W308D4 | TS-W258D2 | TS-W258D4 | TS-W308F | TS-W258F | TS-W302R | TS-W252R | TS-SW3001S2 | TS-SW3001S4 | TS-SW2501S2 | TS-SW2501S4 | TS-SW841D | TS-SW301 | TS-SW251 | |
|-----------------------|---------------------------|--------------------------|-------------------------|-------------------------|--------------------------|-----------------------------|-----------------------------|----------------------------|-----------------------------|----------------------------|-----------------------------|----------------|----------------|----------------|----------------|-----------------|----------------|-----------------|----------------|---------------|----------------|----------------|
| Recommended enclosure | cu.ft. liters | 0.49 to 0.99 17 | 1.0 28.3 | 2.5 70.8 | 1.5 42.5 | 0.80 22.6 | 0.60 16.98 | 1.25 35.4 | 1.25 35.4 | 0.80 22.6 | 0.80 22.6 | — | — | 42.5 | 28.3 | 18.4 | 18.4 | 12.7 | 4.2 to 14.2 | 18.4 | 12.7 | |
| Revc | Ω | 3.0 | 1.8/7.2 | 3.0 | 3.0 | DUAL3.3 | DUAL3.3 | DUAL1.5 | DUAL3.2 | DUAL1.5 | DUAL3.0 | 3.0 | 3.0 | 3.0 | 3.0 | 1.5 | 3.0 | 1.5 | 3.0 | 3.3 | 3.0 | 3.0 |
| Levc | mH | 0.641 | 0.4/1.61 | 5.560 | 5.090 | 5.55 (8 Ω) 1.39 (2 Ω) | 4.80 (8 Ω) 1.20 (2 Ω) | 2.18 (4 Ω) 0.65 (1 Ω) | 3.76 (8 Ω) 1.30 (2 Ω) | 2.2 (4 Ω) 0.63 (1 Ω) | 3.59 (8 Ω) 1.07 (2 Ω) | 1.237 | 1.101 | 1.380 | 1.370 | 1.300 | 2.900 | 0.880 | 2.520 | 0.996 | 2.4 | 2.4 |
| Fs | Hz | 23.5 | 24 | 23.2 | 29.0 | 31.4 | 36.0 | 33.7 | 34.5 | 37.4 | 40.5 | 26.3 | 34.5 | 28.0 | 28.9 | 36.8 | 35.1 | 44.4 | 41.6 | 67.5 | 34.9 | 41.3 |
| Zmax | Ω | 50.4 | 43.8/175 | 58.56 | 70.62 | 157.77 (8 Ω) 38.53 (2 Ω) | 133.73 (8 Ω) 32.72 (2 Ω) | 99.13 (4 Ω) 24.81 (1 Ω) | 177.44 (8 Ω) 45.58 (2 Ω) | 96.01 (4 Ω) 24.81 (1 Ω) | 147.55 (8 Ω) 38.80 (2 Ω) | 28.80 | 29.30 | 35.78 | 47.38 | 27.39 | 59.41 | 21.29 | 46.51 | 25.21 | 28.21 | 28.77 |
| Qms | | 5.72 | 9 | 5.720 | 7.600 | 15.13 | 14.34 | 14.11 | 16.43 | 11.52 | 13.64 | 7.910 | 9.300 | 8.120 | 9.130 | 13.210 | 13.800 | 12.790 | 13.210 | 11.159 | 9.040 | 9.870 |
| Qes | | 0.38 | 0.41 | 0.330 | 0.360 | 0.68 | 0.78 | 0.50 | 0.65 | 0.50 | 0.61 | 0.880 | 1.170 | 0.790 | 0.730 | 0.880 | 0.780 | 1.090 | 1.000 | 1.923 | 1.140 | 1.150 |
| Qts | | 0.36 | 0.39 | 0.310 | 0.340 | 0.65 | 0.74 | 0.48 | 0.62 | 0.48 | 0.58 | 0.800 | 1.140 | 0.720 | 0.680 | 0.820 | 0.740 | 1.000 | 0.930 | 1.641 | 1.020 | 1.090 |
| Vas | cu.ft. liters | 2.46 69.8 | 3.3 93 | 2.479 70.14 | 0.944 26.72 | 0.460 13.03 | 0.240 6.77 | 1.28 36.16 | 1.22 34.68 | 0.550 17.63 | 0.337 15.47 | 0.527 14.73 | 0.377 10.60 | 0.528 14.73 | 0.364 10.27 | 0.533 15.140 | 0.377 10.60 | 0.533 15.140 | 0.377 10.60 | 0.222 6.26 | 0.517 14.63 | 0.369 10.39 |
| Rms | Ns/m | 2.93 | 2.3 | 20.367 | 13.470 | 5.334 | 4.602 | 2.773 | 2.426 | 2.920 | 2.601 | 2.732 | 2.040 | 2.293 | 1.686 | 4.492 | 4.071 | 3.922 | 3.576 | 4.063 | 6.820 | 5.430 |
| Mms | g | 102 | 135 | 800.11 | 550.50 | 408.83 | 291.71 | 184.95 | 184.17 | 143.28 | 139.43 | 131.00 | 87.50 | 110.82 | 84.73 | 256.62 | 255.35 | 179.16 | 179.79 | 106.67 | 281.19 | 206.57 |
| Cms | m/N | 3.70E-04 | 3.15 x 10 ⁻⁴ | 6.00 x 10 ⁻⁴ | 5.350 x 10 ⁻⁴ | 6.29E-05 | 6.66E-05 | 1.20E-0 | | | | | | | | | | | | | | |

Glossary

Headunit Section



Advanced Sound Retriever
Details on pages 7, 15 and 25.



AUX-In Connection
Details on pages 10, 15 and 27.



BBE® digital
BBE® adds a longer delay time to the lower frequencies and slightly "boosts" the high range which tends to become attenuated, so that it recovers its natural articulation. The result: greater live presence with the brilliance and clarity of the original sound.



Bluetooth® Wireless Technology
Details on page 23.



CD-R/RW Compatibility
All Pioneer CD headunits can play back CD-R/RW discs, allowing the user to enjoy favorite compilations in-car.



Compact Disc Digital Video
Compact Disc Digital Video is comprised of animated, or moving, images compressed in MPEG 1 format on a Video CD.



Detachable Face Security™ (DFS)
A theft-deterrent system invented by Pioneer which revolutionized headunit security. With DFS, you simply lift off the front panel (face) of the unit, slip it into a protective case and take it with you. The unit's sensitive electronics remain protected in the dash, all that remains visible from the dash is a black panel that won't attract thieves.



Digital Signal Processor
DSP uses digital technology to correct a vehicle's interior acoustics. The system also offers various sound fields to recreate different listening environments in your car (Studio, Jazz, Club, etc.).



Direct Connection for iPod
Details on pages 7, 15 and 26.



Direct Connection for iPhone
Details on pages 7, 15 and 26.



DivX® Digital Media
Among the world's most popular video technologies, the DivX digital format, based on MPEG-4 data compression standards, is doing for video what MP3 did for audio—it lets anyone create, share and play video in the form of downloadable files that can be quickly, conveniently exchanged among PCs and on the Internet without compromising the quality and integrity of original source material.



Dolby® Digital
This breakthrough technology offers "5.1 channels"—five discrete channels (front left and right, center, and rear left and right) spanning frequencies from 20 Hz to 20 kHz, plus a low-frequency effects channel dedicated to frequencies of 120 Hz or below. These create an acoustic environment in which sound seems to move all around the listener, for supremely dramatic surround sound reproduction.



Dolby Pro Logic® II
Converts sound from 2-channel recorded sources (i.e. CD, MD, TV/FM broadcast, Video, Game, etc.) into 5.1-channel surround sound using matrix decode technology, so it is easy to enjoy sound to more multi-dimensional effect.



Dolby Pro Logic® II
Converts sound from 2-channel recorded sources (i.e. CD, MD, TV/FM broadcast, Video, Game, etc.) into 5.1-channel surround sound using matrix decode technology, so it is easy to enjoy sound to more multi-dimensional effect.



DTS™ (Digital Theater Systems)
Six-channel DTS sound captures the glory of digital surround sound. Featuring low data compression and a high data transfer rate, DTS technology ensures excellent localization throughout a vast frequency and dynamic range.



DVD Audio/Video
In addition to playing video DVDs, the DVD-Audio format provides audio fidelity far superior to that of normal CDs. In addition to audio in stereo and multi-channel surround sound, DVD Audio discs can hold artist bios, background information, lyrics and liner notes.



DVD-R/RW Compatibility
Pioneer DVD players can playback large-capacity DVD-R/RW discs.



DVD Video
DVD technology ensures second-to-none picture quality. Ultra-sharp digital picture and surround sound bring impressive cinema into your car. According to its software format, a DVD is packed with useful benefits such as multiple languages, soundtracks, subtitles and support for various multi-channel audio encoding technologies including DTS™ and Dolby® Digital.



Easy Equalizer
Details on page 28.



Front USB Direct Connection
USB Direct Connection
Details on pages 15, 24 and 26.



High-Voltage Pre-out
Pioneer's High-Voltage Pre-out maximizes signal strength to your amp. The benefits are superior dynamics, crisper highs, more full-bodied bass, and a higher signal-to-noise ratio for minimal noise interference attributable to connections.



IP-Bus Control
The IP-Bus connections on Pioneer headunits allow the user to connect optional source units such as a TV tuner, DVD player, Multi-CD player or even an iPod and create a true mobile multimedia center.



iTunes AAC (Advanced Audio Coding)
Advanced Audio Coding (AAC) is a wideband audio codec that dramatically reduces the amount of data needed to convey high-quality digital audio.



MOSFET 50W x 4
Details on page 27.



MP3
Popular compression format that allows large amounts of audio files to be stored onto one CD-R/RW disc. Pioneer players come equipped with buffering capabilities, so they are all able to handle data rates from 16 kbps and VBR (Variable Bit Rate) recording.



OEL (Organic EL) Display
• Full Dot OEL
Details on page 25.
• Segmented OEL
Details on page 29.

PAL / PAL-M / NTSC / SECAM

PAL/PAL-M/NTSC/SECAM
PAL, PAL-M, NTSC and SECAM are TV reception standards.



RCA Pre-out
The standard connection system to carry sound from a headunit to an amplifier or equalizer. RCA pre-outs provide easy output for connection to an outboard amplifier.



Subwoofer Control
A function built into the headunit allows adjustment of subwoofer frequency.



Supertuner® IIID+/Supertuner® IIID/Supertuner® III™/Supertuner®
Beyond the minimal sound interference and resistance to Three Signal Intermodulation (TSI) of Pioneer's Supertuner® line, Supertuner® IIID advanced analog and digital blocks assure sound superiority and smoothly extend reception. Supertuner® IIID+ features FM Multi-path Canceller for improved stereo separation; AM Noise Canceller with Hi-Speed Gate control countering external noise; and Automatic Reception Control to strengthen weak signals.



TOUCH PANEL



Touch Panel Operation
Details on pages 7 and 12.



WMA (Windows Media™ Audio)
WMA is a music compression format developed by Microsoft Corporation. It uses the latest coding technologies to compress an original audio track, minimizing file sizes while maintaining good audio quality, even at rates as low as 64 kbps.

Amplifier Section

Bass Boost

Bass Boost
Bass Boost offers a choice among bass levels, spanning the range from 0 dB to 12 dB in 2 dB increments, for each speaker (including subwoofer) of a system. This provides more control over the overall balance of sound, to suit listener taste and style of music.

Class FD ICE

Class FD ICEpower Amplifiers
Details on page 38.



High Pass Filter
Low-range sound is filtered off according to user-set cut-off frequency. Mid- and high-range sounds are transferred to the speaker.



Low Pass Filter
Mid- and high-range sounds are filtered off according to user-set cut-off frequency. Low-range sound is transferred to the woofer.



RCA Input
RCA input can be connected with headunit featuring RCA output for preamp signal.



RCA Input/Output
RCA input can be connected with a headunit featuring RCA output for preamp signal. RCA output can be connected with additional amplifiers for a multi-amp system configuration.



Speaker Level Inputs
This allows a Pioneer amplifier to be connected to an OEM radio without requiring costly add-on adapters. The added flexibility allows your Pioneer amplifier to be a part of your system as it grows.



TVC (Total Vibration Control) Technology
Details on page 37.

Subwoofer & Speaker Section



Air Suspension System
Details on pages 45 and 49.



ib-FLAT
Details on page 48.



IMPP (Injection-Molded Polypropylene) Composite Cone
Pioneer uses a special injection molding process rather than "pressing" polypropylene speaker cones. This process ensures uniform cone thickness for superior linearity and clarity. What's more, Pioneer's "Composite" technology guarantees the perfect mix of polypropylene and carbon fiber, graphite and other materials to optimize the speaker cone for its specific application (woofers, midranges, tweeters, etc.).



KEVLAR® Brand Fiber
Characterized by lightness, strength, and low resonance to powerful input, KEVLAR® Brand Fiber is excellent for speaker diaphragms, helping to produce more detailed, accurate sound.



Open & Smooth
Details on pages 39 and 50.



VCCS (Voice Coil Cooling System)
Typically, the longer and louder you play your subwoofer, the hotter it gets. This changes its electrical and mechanical characteristics and adversely affects sound quality. Pioneer's Voice Coil Cooling System (VCCS) draws heat away from the inside of the subwoofer, reducing temperatures by up to 30°C. In the simplest terms, it keeps your sound crisp and your subwoofer from losing its cool.



Printed with soy ink.



Pioneer Corporation Meguro Headquarters and the Kawagoe Plant have acquired ISO 14001 certification.



PIONEER CORPORATION
4-1, Meguro 1-chome, Meguro-ku,
Tokyo 153-8654, Japan

Visit us on the World Wide Web at

<http://pioneer.jp>
<http://www.pioneer.com.sg>

Published by Pioneer Corporation.
Copyright 2009 by Pioneer Corporation. All rights reserved.
Specifications and design may be subject to modification without notice.

Product colors and illumination may differ in photographs from actual appearance, due to effects of printing and photography.

For more information, call or write to:

Free Manuals Download Website

<http://myh66.com>

<http://usermanuals.us>

<http://www.somanuals.com>

<http://www.4manuals.cc>

<http://www.manual-lib.com>

<http://www.404manual.com>

<http://www.luxmanual.com>

<http://aubethermostatmanual.com>

Golf course search by state

<http://golfingnear.com>

Email search by domain

<http://emailbydomain.com>

Auto manuals search

<http://auto.somanuals.com>

TV manuals search

<http://tv.somanuals.com>