

# SERVICE MANUAL

## ADDITIONAL INFORMATION

CASSETTE CAR STEREO

**KP-151** E

CASSETTE CAR STEREO

**KP-212** E

CASSETTE CAR STEREO WITH FM-STEREO

**KP-250** ZE

CASSETTE CAR STEREO WITH AM/FM-STEREO

**KP-4000** G

CASSETTE CAR STEREO WITH AM/FM-STEREO

**KP-4000A** ZE  
ZEB

CASSETTE CAR STEREO WITH LW/MW/FM-STEREO

**KP-4300A** ZE  
ZEB

CASSETTE CAR STEREO WITH MW RADIO

**KP-410A** ZE

CASSETTE CAR STEREO WITH LW/MW

**KP-4400A** ZE

CASSETTE CAR STEREO WITH SW1/SW2/FM

**KP-4900A** SE

CASSETTE CAR STEREO

**08118-65707**

CASSETTE CAR STEREO WITH FM-STEREO

**08118-65708**

Subject:

Cassette Mechanism Assembly has been changed to improve cassette insertion.  
The white name plate is changed to light blue for the models employing this new Cassette Mechanism Assembly. Use this manual together with the original manuals.

Cassette Mechanism Assembly has been changed for the models starting from the serial numbers shown in the table below.

Model	Serial No. Applied	Model	Serial No. Applied
KP-151 E	24,601~	KP-4300A ZEB	7,601~
KP-212 E	77,601~	KP-410A ZE	6,601~
KP-250 ZE	31,101~	KP-4400A ZE	1~
KP-4000 G	89,101~	KP-4900A SE	2,601~
KP-4000A ZE	26,101~	08118-65707	1,101~
KP-4000A ZEB	11,101~	08118-65708	1,101~
KP-4300A ZE	1,601~		

• Before Change (Name Plate)

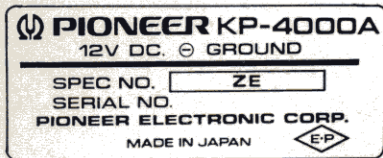

• After Change (Name Plate)

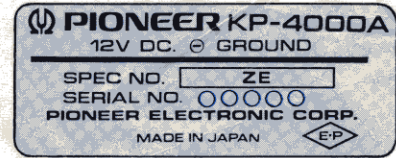

# CASSETTE MECHANISM EXPLODED VIEW (TOP)

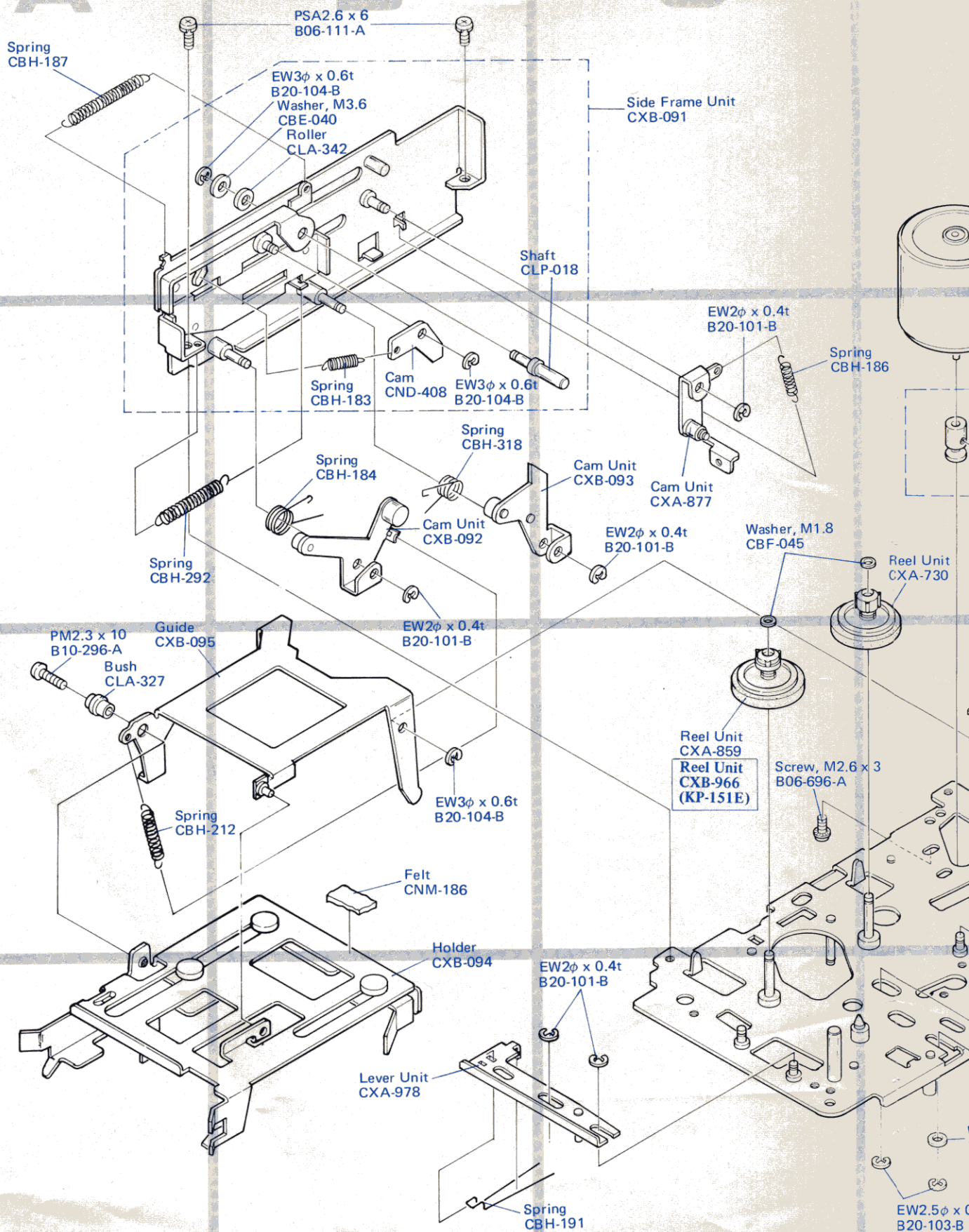

Unit

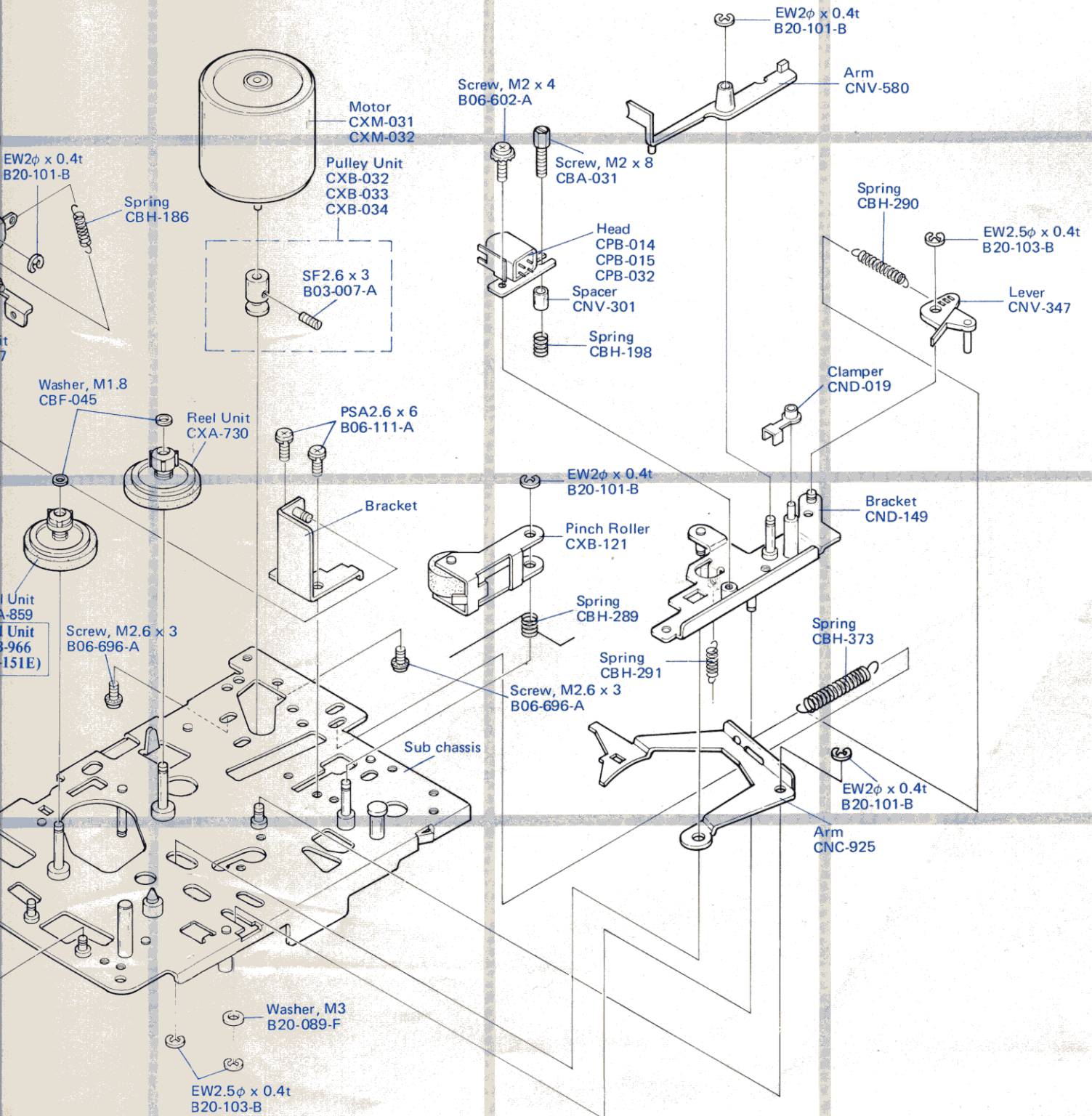

# CASSETTE MECHANISM EXPLODED VIEW (BOTTOM)

CASSET

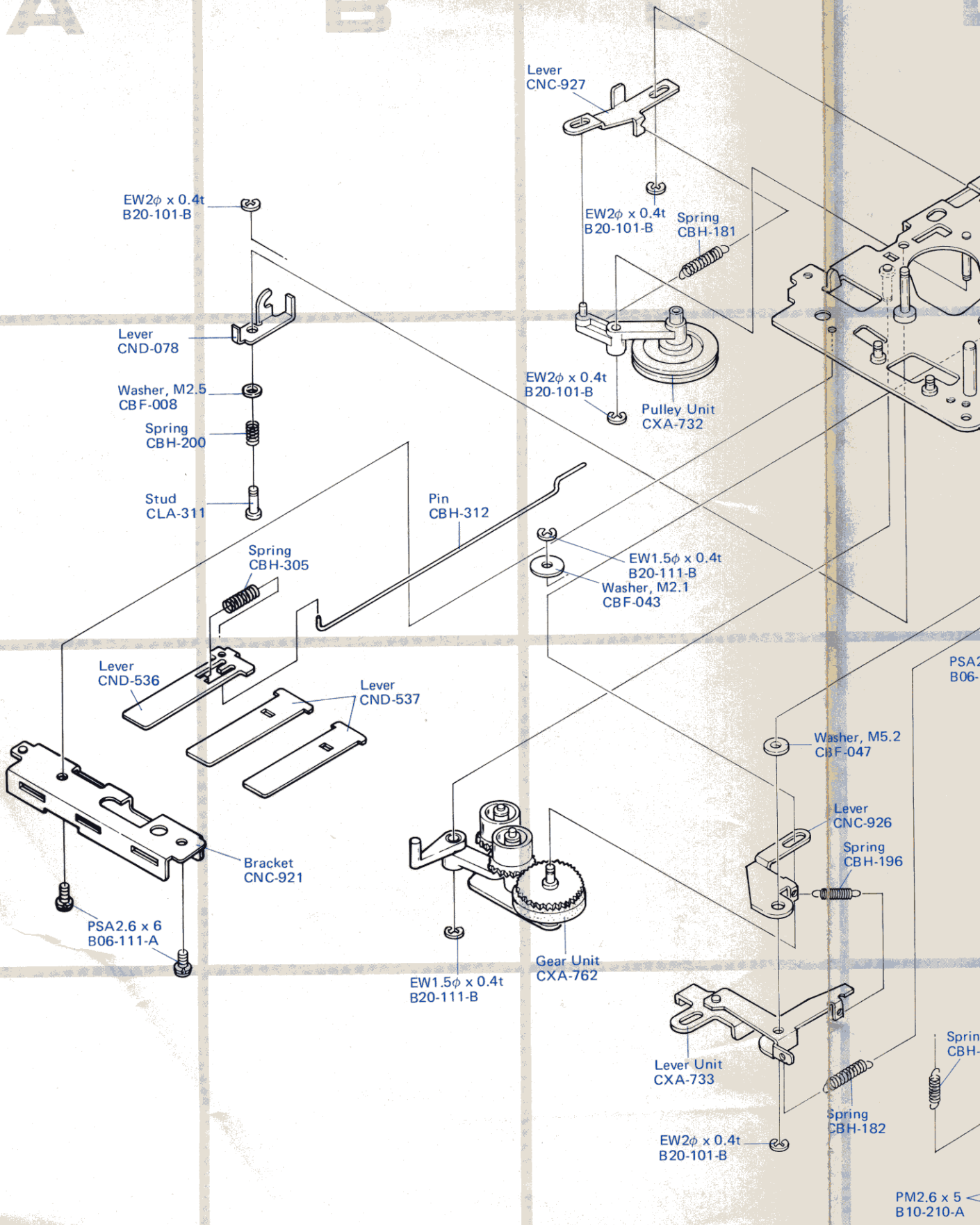

NOTICE: Part whose parts number is omitted is subject to being not supplied.

# CASSETTE MECHANISM EXPLODED VIEW (BOTTOM)

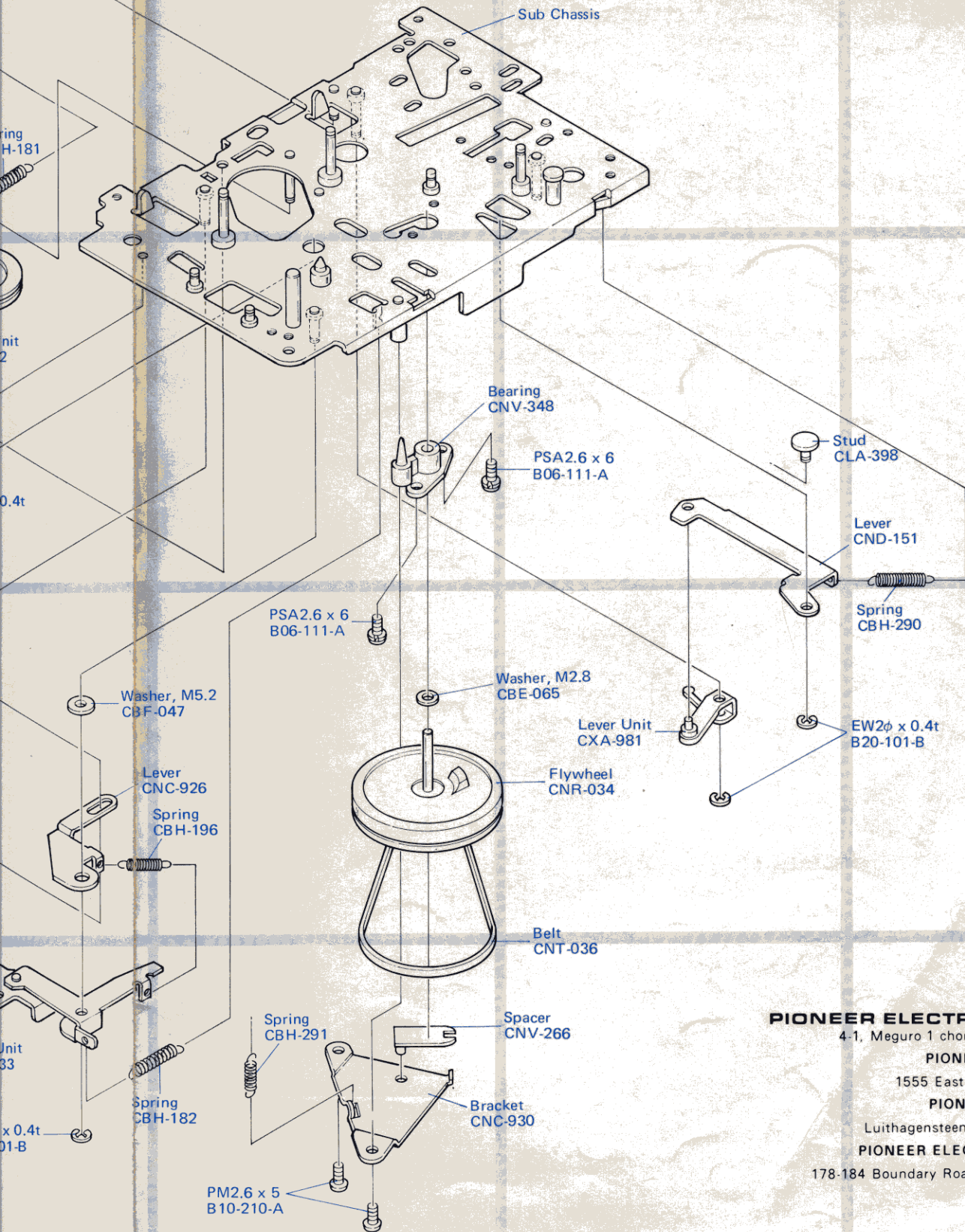

**PIONEER ELECTRONIC CORPORATION**

4-1, Meguro 1 chome, Meguro-ku, TOKYO, 153, JAPAN

**PIONEER ELECTRONICS OF AMERICA**

1555 East Del Amo Blvd. Carson, Calif. 90746

**PIONEER ELECTRONIC (EUROPE) N.V.**

Luithagensteenweg, No. 9, 2030 Antwerp, Belgium

**PIONEER ELECTRONICS AUSTRALIA PTY. LTD.**

178-184 Boundary Road, Braeside, Victoria 3195, Australia

© APR. 1976 Printed in Japan

<76D03E61K>

# SCHEMATIC CIRCUIT DIAGRAM

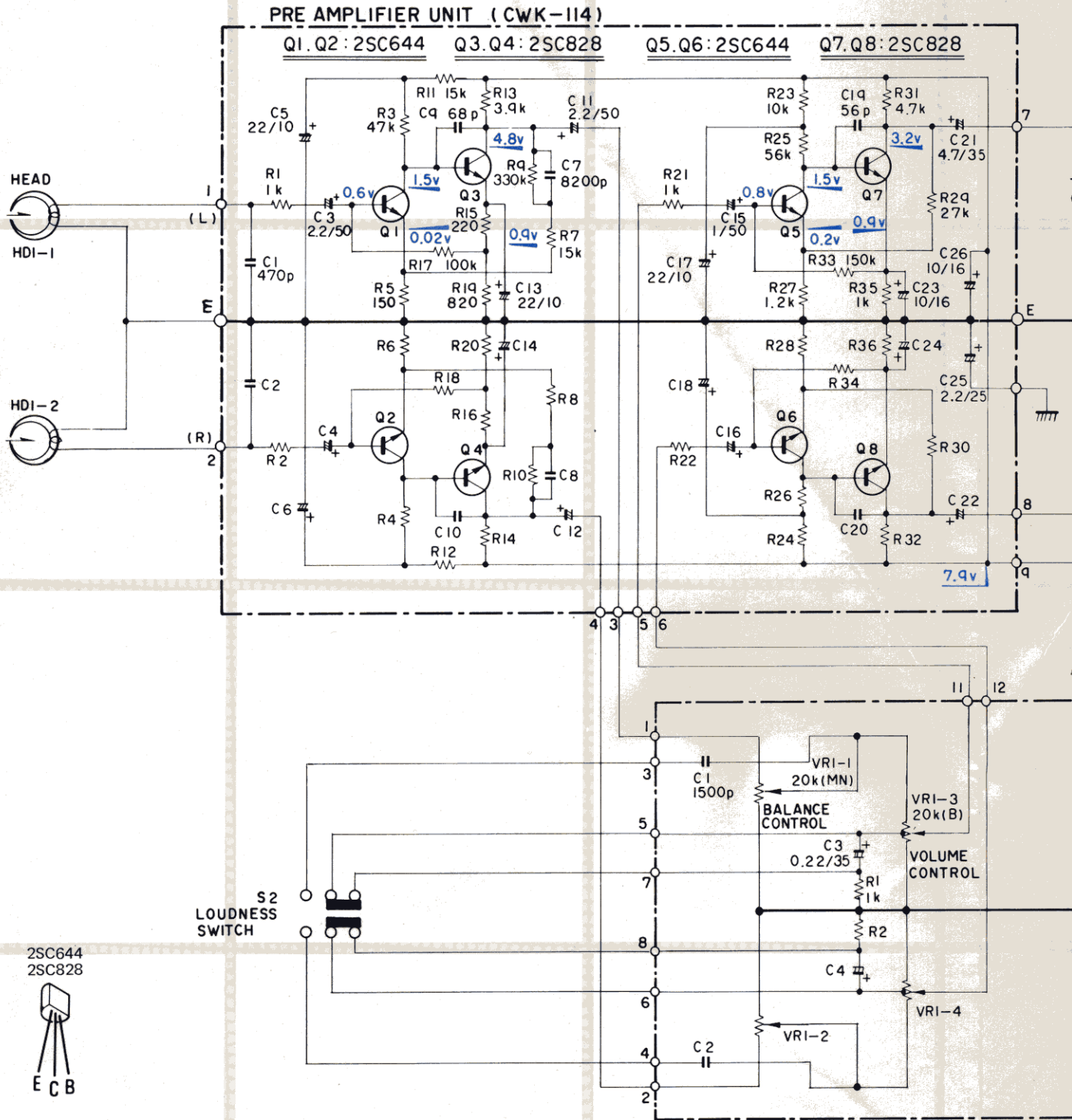

D E F

CONTROL AMPLIFIER UNIT (CWK-115)

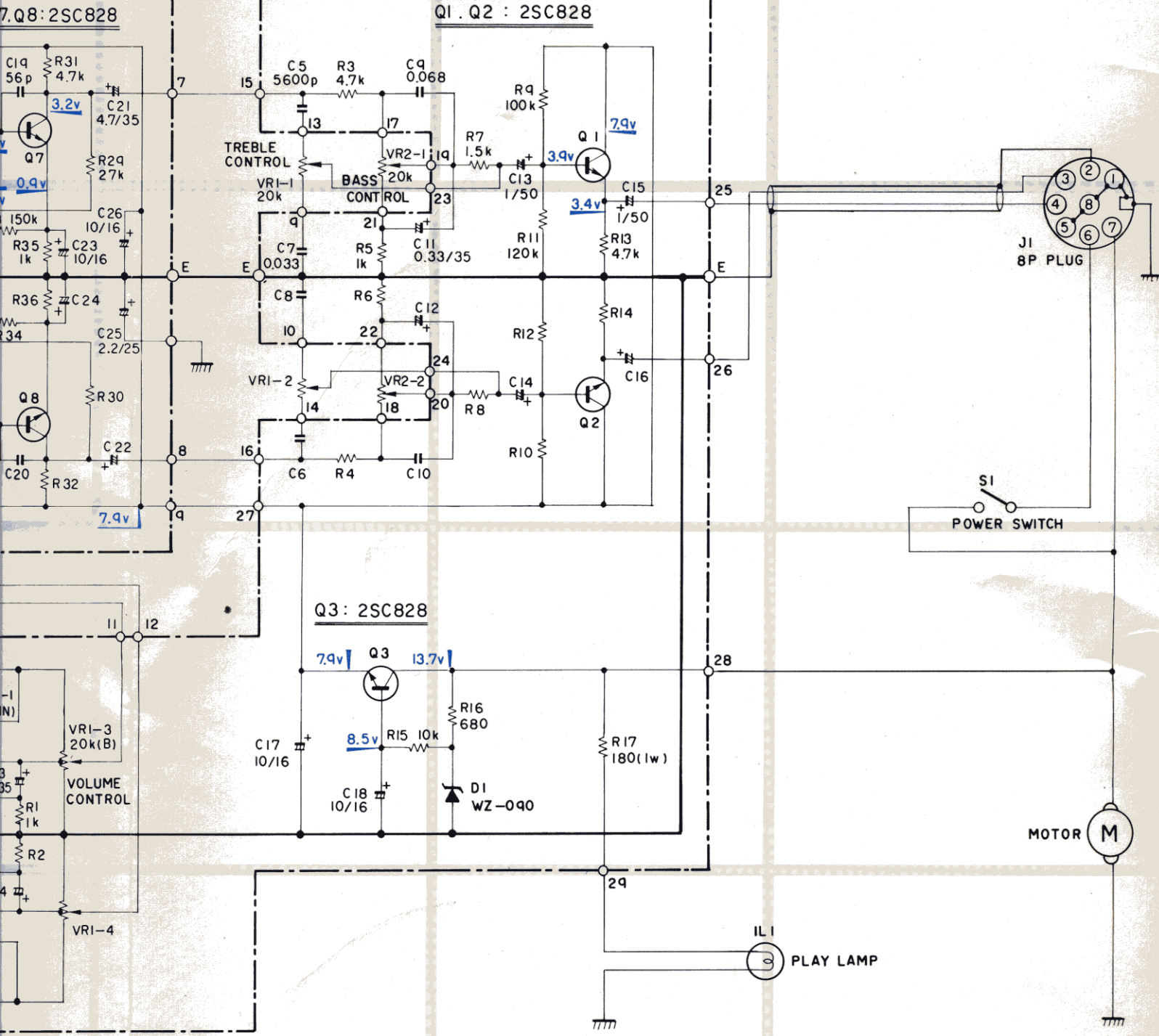



## Free Manuals Download Website

<http://myh66.com>

<http://usermanuals.us>

<http://www.somanuals.com>

<http://www.4manuals.cc>

<http://www.manual-lib.com>

<http://www.404manual.com>

<http://www.luxmanual.com>

<http://aubethermostatmanual.com>

Golf course search by state

<http://golfingnear.com>

Email search by domain

<http://emailbydomain.com>

Auto manuals search

<http://auto.somanuals.com>

TV manuals search

<http://tv.somanuals.com>