

Operation Manual

AV Receiver/DVD Player with 6.5 inch Wide Display

AVH-P6550DVD

SUPER  **TUNER III D**

English

Thank you for buying this Pioneer product.

Please read through these operating instructions so you will know how to operate your model properly. *After you have finished reading the instructions, put them away in a safe place for future reference.*



Be sure to read this

- Playable discs **6**
- DVD video disc region numbers **6**
- When an operation is prohibited **8**

01 Precautions

- IMPORTANT SAFEGUARDS **5**
- To ensure safe driving **5**
- To avoid battery exhaustion **5**

02 Before You Start

- About this unit **6**
- About this manual **6**
- Precautions **6**
- Features **7**
- To protect the LCD screen **8**
- For viewing LCD comfortably **8**
- Condition memory **8**
- What the marks on DVDs indicate **8**
- Resetting the microprocessor **8**
- Use and care of the remote control **9**

03 What's What

- Head unit **11**
- Remote control **13**

04 Basic Operations

- Turning the unit on and selecting a source **16**
- Loading a disc **16**
- Adjusting the volume **17**
- Turning the unit off **17**
- Using the rear display **17**
- Touch panel key basic operation **18**
- Opening and closing the LCD panel **19**
- Changing the wide screen mode **20**
- Adjusting the picture adjustment **21**

Protecting your unit from theft **22**

05 Tuner

- Listening to the radio **23**
- Introduction of advanced tuner operation **24**
- Storing and recalling broadcast frequencies **24**
- Tuning in strong signals **24**
- Storing the strongest broadcast frequencies **25**

06 Playing DVD video discs

- Watching a DVD video **26**
- Operating the DVD menu **27**
- Skipping back or forward to another title **27**
- Stopping playback **27**
- Introduction of advanced DVD video operation **28**
- Repeating play **28**
- Pausing DVD video playback **28**
- Frame-by-frame playback **28**
- Slow motion playback **29**
- Searching for a desired scene, starting playback from a specified time **29**
- Changing audio language during playback (Multi-audio) **30**
- Changing the subtitle language during playback (Multi-subtitle) **30**
- Changing the viewing angle during playback (Multi-angle) **31**

07 Playing Video CDs

- Watching a Video CD **32**
- Stopping playback **33**
- Introduction of advanced Video CD operation **33**
- Repeating play **33**
- Pausing Video CD playback **34**

- Frame-by-frame playback **34**
- Slow motion playback **34**
- Searching for a desired scene, starting playback from a specified time **35**
- Selecting audio output **35**

08 Playing CDs

- Listening a CD **36**
- Stopping playback **36**
- Introduction of advanced CD operation **37**
- Repeating play **37**
- Playing tracks in a random order **37**
- Scanning tracks of a CD **37**
- Pausing CD playback **38**
- Searching for a desired track **38**
- Entering disc titles **38**
- Using CD TEXT functions **39**

09 Playing MP3

- Listening MP3 **40**
- Stopping playback **41**
- Introduction of advanced MP3 operation **41**
- Repeating play **41**
- Playing tracks in a random order **42**
- Scanning folders and tracks **42**
- Pausing MP3 playback **42**
- Searching for a desired track in the current folder **43**
- Displaying text information on MP3 disc **43**
- Scrolling text information in the display **43**
- Selecting folders from the folder name list **43**

10 Multi-CD Player

- Listening a CD **44**
- 50-disc multi-CD player **44**
- Introduction of advanced multi-CD player operation **45**
- Repeating play **45**

- Playing tracks in a random order **45**
- Scanning CDs and tracks **46**
- Pausing CD playback **46**
- Using ITS playlists **46**
- Using disc title functions **47**
- Using CD TEXT functions **48**
- Using compression and bass emphasis **49**

11 TV tuner

- Watching the TV tuner **50**
- Introduction of advanced TV tuner operation **51**
- Storing and recalling broadcast stations **51**
- Storing the strongest broadcast stations sequentially **51**
- Selecting the country group **52**

12 DVD Player

- Playing a disc **53**
- Turning the DVD player on or off **53**
- Selecting a disc **54**
- Introduction of advanced DVD player operation **54**
- Repeating play **54**
- Pausing disc playback **55**
- Playing tracks in a random order **55**
- Scanning tracks of a CD **55**
- Using ITS playlists **55**

13 Audio Adjustments

- Introduction of audio adjustments **56**
- Using balance adjustment **56**
- Using the equalizer **57**
- Adjusting bass and treble **58**
- Adjusting loudness **58**
- Using subwoofer output **59**
- Using non fading output **59**
- Using the high pass filter **59**
- Adjusting source levels **60**

Compensating for equalizer curves (EQ-EX) **60**

Setting the sound focus equalizer (SFEQ) **61**

14 Digital Signal Processor

Introduction of DSP adjustments **62**

Using the sound field control **62**

Using the position selector **63**

Using balance adjustment **63**

Adjusting source levels **64**

Using the dynamic range control **64**

Using the dual mono mode **64**

Using the direct control **65**

Using the Dolby Pro Logic **65**

Setting the speaker setting **65**

Selecting a cut-off frequency **66**

Adjusting the speaker output levels **67**

Adjusting the speaker output levels using a test tone **67**

Adjusting the time alignment **68**

Using the equalizer **68**

15 Setting up the DVD player

Introduction of DVD setup adjustments **70**

Setting the subtitle language **70**

Setting the audio language **71**

Setting the menu language **71**

Setting assist subtitles on or off **71**

Setting angle icon display **72**

Setting the aspect ratio **72**

Setting the parental lock **72**

Setting remote control code type **73**

16 Initial Settings

Adjusting initial settings **74**

Setting the FM tuning step **74**

Setting the AM tuning step **74**

Switching the warning tone **75**

Switching the auxiliary setting **75**

Setting the rear output and subwoofer controller **75**

Correcting distorted sound **76**

Switching the sound muting/attenuation **76**

Switching the automatic disc playback **76**

Switching the dimmer setting for sub-display **77**

17 Other Functions

Introduction of setup adjustments **78**

Setting the video input **78**

Setting for back-up camera **78**

Setting the automatic open function **79**

Setting the clock **79**

Using the AUX source **80**

Switching the background display **80**

Using the PGM button **81**

Additional Information

Troubleshooting **82**

Error messages **84**

DVD player and care **85**

DVD discs **85**

CD-R/CD-RW discs **85**

MP3 files **86**

Using the display correctly **87**

Language code chart for DVD **89**

Terms **90**

Specifications **93**

Precautions

IMPORTANT SAFEGUARDS

Please read all of these instructions regarding your display and retain them for future reference.

- 1 **Read this manual fully and carefully before operating your display.**
- 2 **Keep this manual handy for future reference.**
- 3 **Pay close attention to all warnings in this manual and follow the instructions carefully.**
- 4 **Do not allow other persons to use this system until they have read and understood the operating instructions.**
- 5 **Do not install the display where it may (i) obstruct the driver's vision, (ii) impair the performance of any of the vehicle's operating systems or safety features, including air bags, or (iii) impair the driver's ability to safely operate the vehicle.**
- 6 **As with any accessory in your vehicle's interior, the display should not divert your attention from the safe operation of your vehicle. If you experience difficulty in operating the system or reading the display, please park safely before making adjustments.**
- 7 **Do not attempt to install or service your display by yourself. Installation or servicing of the display by persons without training and experience in electronic equipment and automotive accessories may be dangerous and could expose you to the risk of electric shock or other hazards.**
- 8 **Please remember to wear your seat belt at all times while operating your vehicle. If you are ever in an accident, your injuries can be considerably more severe if your seat belt is not properly buckled. **

To ensure safe driving

WARNING

- To avoid the risk of accident and the potential violation of applicable laws, this unit is not for use with a video screen that is visible to the driver.
- In some countries or states the viewing of images on a display inside a vehicle even by persons other than the driver may be illegal. Where such regulations apply, they must be obeyed.

This unit detects whether your car's parking brake is engaged or not, and prevents you from watching a DVD or TV on this display while driving. When you attempt to watch a DVD or TV, the warning **VIDEO VIEWING IS NOT AVAILABLE WHILE DRIVING** will appear on the screen.

To watch a DVD or TV on this display, park your car in a safe place and apply the parking brake.

When using a display connected to REAR MONITOR OUT

This unit's **REAR MONITOR OUT** is for connection of a display to enable passengers in the rear seats to watch the DVD or TV.

WARNING

NEVER install the display in a location that enables the driver to watch the DVD or TV while driving. 

To avoid battery exhaustion

Be sure to run the vehicle engine while using this unit. Using this unit without running the engine can result in battery drainage.

WARNING

Do not use with vehicles that do not feature an ACC position. 

About this unit

Playable discs

DVD, Video CD and CD discs that display the logos shown below can be played back on this player.

DVD video



Video CD



CD



Note

It is not possible to play back DVD audio disc. This player can only playback discs bearing the marks shown above.

DVD video disc region numbers

DVD video discs that have incompatible region numbers cannot be played on this player. The region number of the player can be found on the bottom of this unit.

The illustration below shows the regions and corresponding region numbers.



About this manual

This unit features a number of sophisticated functions ensuring superior reception and operation. All the functions have been designed for the easiest possible use, but many are not self-explanatory. This operation manual will help you benefit fully from this unit's potential and to maximize your listening enjoyment. We recommend that you familiarize yourself with the functions and their operation by reading through the manual before you begin using this unit. It is especially important that you read and observe precautions on this page and in other sections. ■

Precautions

CAUTION:
USE OF CONTROL OR ADJUSTMENT OR PERFORMANCE OF PROCEDURES OTHER THAN THOSE SPECIFIED HEREIN MAY RESULT IN HAZARDOUS RADIATION EXPOSURE.

CAUTION:
THE USE OF OPTICAL INSTRUMENTS WITH THIS PRODUCT WILL INCREASE EYE HAZARD.

- Keep this manual handy as a reference for operating procedures and precautions.
- Always keep the volume low enough so you can hear sounds outside of the car.
- Protect this product from moisture.
- If the battery is disconnected or discharged, the preset memory will be erased and must be reprogrammed.
- If this unit does not operate properly, contact your dealer or nearest authorized Pioneer Service Station. ■

Before You Start

Features

Touch panel key operation

It is possible to operate this unit by using touch panel key.

DVD video playback

It is possible to play back DVD video, DVD-R (video mode) and DVD-RW (video mode).

Video CDs featuring PBC compatibility

It is possible to play back Video CDs featuring PBC (playback control).

CD playback

Music CD/CD-R/CD-RW playback is possible.

MP3 file playback

It is possible to play back MP3 files recorded on CD-ROM/CD-R/CD-RW (ISO9660 Level 1/Level 2 standard recordings).

- Supply of this product only conveys a license for private, non-commercial use and does not convey a license nor imply any right to use this product in any commercial (i.e. revenue-generating) real time broadcasting (terrestrial, satellite, cable and/or any other media), broadcasting/streaming via internet, intranets and/or other networks or in other electronic content distribution systems, such as pay-audio or audio-on-demand applications. An independent license for such use is required. For details, please visit <http://www.mp3licensing.com>.

NTSC/PAL compatibility

This unit is NTSC/PAL system compatible. When connecting other components to this unit, be sure components are compatible with the same video system or else images will not be correctly reproduced.

Dolby Digital/DTS compatibility

When using this unit with a Pioneer multi-channel processor, you can enjoy the atmosphere and excitement provided by DVD movie

and music software featuring 5.1 channel recordings.

- Manufactured under license from Dolby Laboratories. "Dolby" and the double-D symbol are trademarks of Dolby Laboratories.



- "DTS" is a registered trademark of Digital Theater Systems, Inc.



Multi-aspect

Switching between wide screen, letter box and panscan display is possible.

Multi-audio

You can switch between multiple audio systems recorded on a DVD as desired.

Multi-subtitle

You can switch between multiple subtitle languages recorded on a DVD as desired.

Multi-angle

You can switch between multiple viewing angles of a scene recorded on a DVD as desired.



Note

This product incorporates copyright protection technology that is protected by method claims of certain U.S. patents and other intellectual property rights owned by Macrovision Corporation and other rights owners. Use of this copyright protection technology must be authorized by Macrovision Corporation, and is intended for home and other limited viewing uses only unless otherwise authorized by Macrovision Corporation. Reverse engineering or disassembly is prohibited. 

To protect the LCD screen

- Do not allow direct sunlight to fall on the display when this unit is not being used. Extended exposure to direct sunlight can result in LCD screen malfunction due to the resulting high temperatures.
- When using a portable phone, keep the antenna of the portable phone away from the display to prevent disruption of the video by the appearance of spots, colored stripes, etc. 

For viewing LCD comfortably

Due to its construction, the view angle of the LCD screen is limited. The viewing angle (vertical and horizontal) can be increased, however, by using **BRIGHT** to adjust the black density of the video. When using for the first time, adjust the black density in accordance with the viewing angle (vertical and horizontal) to adjust for clear viewing. **DIMMER** can also be used to adjust the brightness of the LCD screen itself to suit your personal preference. 





Condition memory

This function memorizes audio language, subtitle language, angle number and aspect ratio made during disc playback for up to 30 discs. Without any special operations, the final setting details during playback of a disc are memorized. The next time a disc is played, the previous settings are automatically applied.

- With some discs, audio language and subtitle language are automatically specified, in which case condition memory does not function.
- When the number of discs exceeds 30, settings for the latest disc replace those for the least recent disc. 



What the marks on DVDs indicate

The marks below may be found on DVD disc labels and packages. They indicate the type of images and audio recorded on the disc, and the functions you can use.

Mark	Meaning
	Indicates the number of audio systems.
	Indicates the number of subtitle languages.
	Indicates the number of viewing angles.
	Indicates the picture size (aspect ratio: screen width-to-height ratio) type.
	Indicates the number of the region where playback is possible.

When an operation is prohibited

When you are watching a DVD and attempt to perform an operation, it may not be performed by the programming on the disc. When this happens, this unit indicates the icon  on the screen.

- The icon  may not appear in certain discs. 

Resetting the microprocessor

Pressing **RESET** lets you reset the microprocessor to its initial settings without changing the condition memory.

The microprocessor must be reset under the following conditions:

- Prior to using this unit for the first time after installation
- If the unit fails to operate properly

Before You Start

- When strange or incorrect messages appear on the display

1 Turn the ignition switch OFF.

2 Press RESET with a pen tip or other pointed instrument.

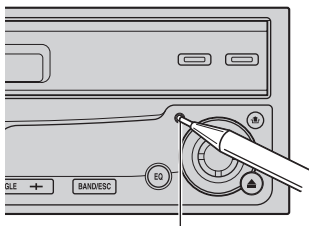

RESET button

Note

After completing connections or when you want to erase all memorized settings or return the unit to its initial (factory) settings, switch your engine ON or set the ignition switch to ACC ON before pressing **RESET**. 

Use and care of the remote control

Installing the battery

Slide the tray out on the back of the remote control and insert the battery with the plus (+) and minus (-) poles pointing in the proper direction.

- When using for the first time, pull out the film protruding from the tray.

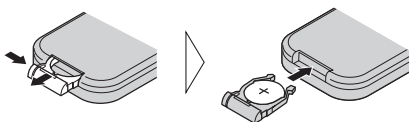

WARNING

Keep the battery out of the reach of children. Should the battery be swallowed, immediately consult a doctor.

CAUTION

- Use only one **CR2025 (3 V)** lithium battery.
- Remove the battery if the remote control is not used for a month or longer.
- Do not recharge, disassemble, heat or dispose of the battery in fire.
- Do not handle the battery with metallic tools.
- Do not store the battery with metallic materials.
- In the event of battery leakage, wipe the remote control completely clean and install a new battery.
- When disposing of used batteries, please comply with governmental regulations or environmental public institution's rules that apply in your country/area.

Using the remote control

Point the remote control in the direction of the front panel to operate.

- The remote control may not function properly in direct sunlight.



Important

- Do not store the remote control in high temperatures or direct sunlight.
- Do not let the remote control fall onto the floor, where it may become jammed under the brake or accelerator pedal. 

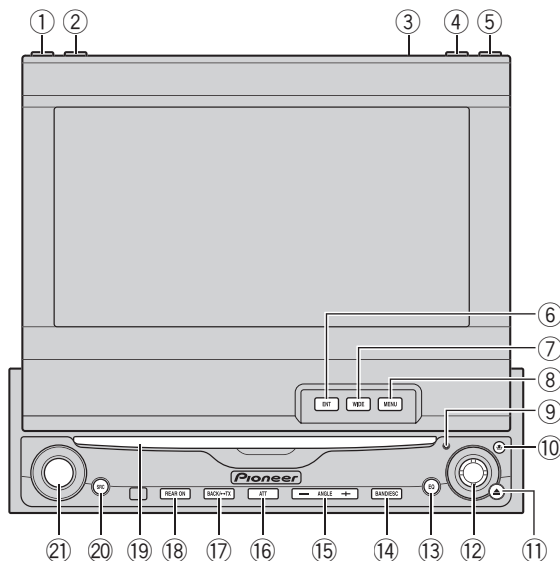

Head unit

- ① **DISPLAY button**
Press to select different displays.
- ② **PGM button**
Press to operate the preprogrammed functions for each source. (Refer to *Using the PGM button* on page 81.)
- ③ **Ambient light sensor**
Senses ambient light. This system automatically adjusts the brightness of the display to compensate for ambient light.
- ④ **FLIP DOWN/CLOCK button**
Press to turn the LCD panel horizontal temporarily when the LCD panel is upright. Press to turn the clock display on or off when the LCD panel is closed.
- ⑤ **OPEN/CLOSE button**
Press to open or close the LCD panel.
- ⑥ **ENTERTAINMENT button**
Press to switch between the background displays.
- ⑦ **WIDE button**
Press to select a desired mode for enlarging a 4:3 picture to a 16:9 one.
- ⑧ **MENU button**
Press and hold to display the picture adjustment menu.
- ⑨ **RESET button**
Press to return to the factory settings (initial settings).
- ⑩ **DETACH button**
Press to remove the front panel from the head unit.
- ⑪ **EJECT button**
Press to eject a disc from this unit.

⑫ Joystick

Move to do manual seek tuning, fast forward, reverse and track search controls. Also used for controlling functions.

⑬ EQ button

Press to select various equalizer curves.

⑭ BAND/ESC button

Press to select among three FM and one AM bands and cancel the control mode of functions.

⑮ ANGLE (+/-) button

Press to change the LCD panel angle.

⑯ ATT button

Press to quickly lower the volume level, by about 90%. Press once more to return to the original volume level.

⑰ BACK button

Press to return to the previous display.

⑱ REAR ON button

Press to watch a DVD/Video CD on a rear display if **DVD** (built-in DVD player) is not selected as the source.

⑲ Disc loading slot

Insert a disc to play.

⑳ SOURCE button

This unit is turned on by selecting a source. Press to cycle through all of the available sources.

㉑ VOLUME

Rotate to increase or decrease the volume.

What's What

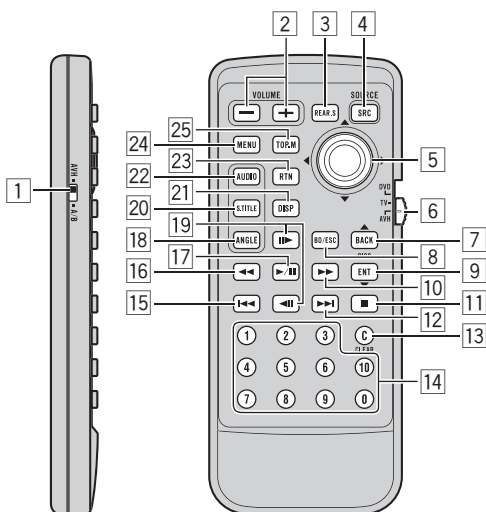

Remote control

1 Remote control selection switch

Switch to change the setting of the remote control. For details, refer to *Setting remote control code type* on page 73.

2 VOLUME button

Press to increase or decrease the volume.

3 REAR.S button

Press to watch a DVD/Video CD on a rear display if **DVD** (built-in DVD player) is not selected as the source.

4 SOURCE button

This unit is turned on by selecting a source. Press to cycle through all of the available sources.

5 Joystick

Move to do manual seek tuning, fast forward, reverse and track search controls. Also used for controlling functions.

6 Remote control operation mode switch

Switch the operation mode between **AVH**, **DVD** and **TV** modes. Normally, set to **AVH**.

- **AVH** – For common operation of this unit
- **DVD** – Only for DVD player operation
- **TV** – Only for TV tuner operation

For details, refer to *Switching the remote control operation mode switch* on the next page.

7 BACK button

Press to return to the previous display.

8 BAND/ESC button

Press to select among three FM and one AM bands and cancel the control mode of functions.

9 ENTERTAINMENT button

Press to switch between the background displays.

10 FORWARD (▶▶) button

Press to perform fast forward playback.

11 STOP (■) button

Press to stop playback.

12 NEXT (▶▶|) button

Press to go to the next track (chapter).

13 CLEAR button

Press to cancel the input number while **0–10** are used.

14 0–10 buttons

Press to directly select the desired track, preset tuning and disc. **1–6** buttons can operate the preset tuning for the tuner or disc number search for the multi-CD player.

15 PREVIOUS (◀◀) button

Press to return to the previous track (chapter).

16 REVERSE (◀◀) button

Press to perform fast reverse playback.

17 PLAY/PAUSE (▶/||) button

Press to switch sequentially between playback and pause play.

18 ANGLE button

Press to change the viewing angle during DVD playback.

19 STEP (||▶/◀||) button

Press to move ahead one frame at a time during DVD/VideoCD playback. Press and hold for one second to activate slow playback.

20 SUBTITLE (SUB.T) button

Press to change the subtitle language during DVD playback.

21 DISPLAY button

Press to select different displays.

22 AUDIO button

Press to change the audio language during DVD playback.

23 RETURN button

Press to display the PBC (playback control) menu during PBC playback.

24 MENU button

Press to display the DVD menu during DVD playback.

25 TOP MENU (TOP.M) button

Press to return to the top menu during DVD playback.

Switching the remote control operation mode switch

There are three remote control operation modes on the remote control.

AVH mode operation

When operating this unit by remote control, normally switch the mode to **AVH**.

- The joystick on the remote control can perform the same operations as it on the head unit. Furthermore, the joystick can perform the same operations as the touch panel keys ▲, ▼, ◀ and ▶.
- **1–6** can perform the same operations as the preset tuning keys **P 1—P 6** and the disc selection keys **01—06**.
 - If you want to select a disc located at 7 to 12 by using **1–6**, press and hold the corresponding numbers such as **1** for disc 7, until the disc number appears in the display.

What's What

DVD mode operation

If you switch the mode to **DVD**, the joystick and **0-10** operations are changed for DVD player.

● **When you want to operate the following functions, switch the mode to DVD:**

- When operating the DVD menu by using the joystick. (Refer to *Operating the DVD menu* on page 27.)
- When operating the PBC menu by using **0-10**. (Refer to *Watching a Video CD* on page 32.)
- When specifying title or track by using **0-10**. (Refer to *Specifying title* on page 30 and *Specifying track* on page 35.)



Note

When switching the mode to **DVD**, you cannot use these buttons: **BACK**, **ENTERTAINMENT** and **DISPLAY**.

TV mode operation

If you use the rear output on TV tuner, you can watch the TV picture on the rear display independently. To operate the TV on the rear display independently, switch the mode to **TV**. In this case, the joystick operation is changed for TV.

- For details concerning operation, refer to the TV tuner's operation manuals.
- **When you want to operate the following functions only on the rear display, switch the mode to TV:**
- When performing manual or seek tuning by moving the joystick left or right.
 - When recalling preset stations by moving the joystick up or down.
 - When selecting the country group by clicking joystick and then moving it left or right. (This function can be operated only when

connecting a TV tuner (e.g. GEX-P6450TVP) featuring the country setting.)



Note

When switching the mode to **TV**, you cannot use except the joystick, **SOURCE** and **VOLUME**. 

Turning the unit on and selecting a source

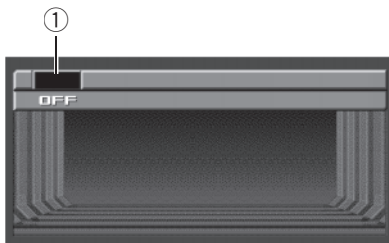

① Source icon

Shows what the source has been selected.

You can select a source you want to listen to. If

DVD AUTO is turned on, load a disc in this unit to switch to **DVD** (refer to *Switching the automatic disc playback* on page 76).

● When using the touch panel keys, touch the source icon and then touch the desired source name.

The source names are displayed and selectable ones are highlighted.

- **DVD** – Built-in DVD player
- **S-DVD** – DVD player/multi-DVD player
- **M-CD** – Multi-CD player
- **TUNER** – Tuner
- **TV** – Television
- **AV** – Video input
- **EXT-1** – External unit 1
- **EXT-2** – External unit 2
- **AUX** – AUX
- **SOURCE OFF** – Turn the unit off
 - When the source icon is not displayed, you can display it by touching the screen.
 - To return to the playback display, touch **ESC**.

● When using the button, press **SOURCE** to select a source.

Press **SOURCE** repeatedly to switch between the following sources:

TUNER (tuner)—**TV** (television)—**AV** (video input)—**DVD** (built-in DVD player)—**S-DVD** (DVD player/multi-DVD player)—**M-CD** (multi-CD player)—**EXT-1** (external unit 1)—**EXT-2** (external unit 2)—**AUX** (AUX)



Notes

- In the following cases, the sound source will not change:
 - When a unit corresponding to each source is not connected to this unit.
 - When no disc is set in this unit.
 - When no disc is set in the DVD player.
 - When no magazine is set in the multi-CD player.
 - When no magazine is set in the multi-DVD player.
 - When the AUX (auxiliary input) is set to off (refer to page 75).
 - When the AV (video input) is not set to **VIDEO** (refer to page 78).
- External unit refers to a Pioneer product (such as one available in the future) that, although incompatible as a source, enables control of basic functions by this unit. Two external units can be controlled by this unit. When two external units are connected, the allocation of them to external unit 1 or external unit 2 is automatically set by this unit.
- When this unit's blue/white lead is connected to the car's auto-antenna relay control terminal, the car's antenna extends when this unit's source is turned on. To retract the antenna, turn the source off. 

Loading a disc

● Insert a disc into the disc loading slot.

Playback will automatically start.

- If **DVD AUTO** is turned off, touch the source icon and then touch **DVD** to select **DVD** (refer to this page).

Basic Operations

- When a disc is loaded in this unit, touch the source icon and then touch **DVD** to select **DVD**.
- To eject a disc, press **EJECT**.

Notes

- The DVD player plays one, standard, 12-cm or 8-cm (single) disc at a time. Do not use an adapter when playing 8-cm discs.
- Do not insert anything other than a disc into the disc loading slot. Discs which can be played back are listed on *Playable discs* on page 6.
- If you cannot insert a disc completely or if after you insert a disc the disc does not play, check that the label side of the disc is up. Press **EJECT** to eject the disc, and check the disc for damage before inserting the disc again.
- If the DVD player does not operate properly, an error message such as **ERROR-11** may be displayed. Refer to *Error messages* on page 84. 

Adjusting the volume

- Use **VOLUME** to adjust the sound level.

With the head unit, rotate **VOLUME** to increase or decrease the volume.

With the remote control, press **VOLUME** to increase or decrease the volume. 

Turning the unit off

- When using the touch panel keys, touch the source icon and then touch **SOURCE OFF**.

- When the source icon is not displayed, you can display it by touching the screen.

- When using the button, press **SOURCE** and hold until the unit turns off. 

Using the rear display

You can watch a DVD/Video CD on the rear display regardless of whether **DVD** (built-in DVD player) is selected as the source or not.

- If you watch a DVD/Video CD on the rear display only, switch the operation mode on the remote control to **DVD**. And you can operate the DVD/Video CD playback on the rear display independently by the remote control. (Refer to page 14.)

CAUTION

When you have turned the DVD/Video CD playback on by pressing **REAR ON**, you cannot turn it off even if you press **SOURCE** and hold. In this case, press **REAR ON** to turn the DVD/Video CD playback off.

- Press **REAR ON** to watch a DVD/Video CD on the rear display when **DVD (built-in DVD player)** is not selected as the source.

DVD/Video CD playback is turned on and the illumination color of **REAR ON** changes into the different color than the other buttons.

- You can also turn the DVD/Video CD playback on by pressing **REAR.S** on the remote control.
- To turn the DVD/Video CD playback off, press **REAR ON** again. 

Touch panel key basic operation

Activating the touch panel keys

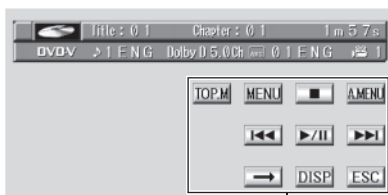

① Touch panel keys

Touch to do various operations.

1 Touch the screen to activate the touch panel keys corresponding to each source.

The touch panel keys appear on the display.

- To go to the next group of touch panel keys, touch →.

2 Touch ESC to hide the touch panel keys.

- You can also hide the touch panel keys by pressing **BAND/ESC**.



Note

If you do not use the touch panel keys for 30 seconds, they will be hidden automatically.

Operating the menu

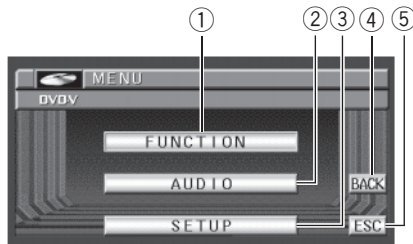

① FUNCTION key

Touch to select functions for each source.

② AUDIO key

Touch to select various sound quality controls.

③ SETUP key

Touch to select various setup functions.

④ BACK key

Touch to return to the previous display.

⑤ ESC key

Touch to cancel the control mode of functions.

1 Touch A.MENU to display MENU.

MENU appears on the display.

- When **A.MENU** is not displayed, you can display it by touching the screen.

2 Touch the desired key to display the function names you want to operate.

- To go to the next group of function names, touch **NEXT**.
- To return to the previous group of function names, touch **PREV**.

3 Touch ESC to return to the display of each source.

Basic Operations

Note

If you do not operate the function within about 30 seconds, the display is automatically returned to the playback display.

Operating the menu by using the joystick

You can also perform most of the menu items by using the joystick.

- Switch the remote control operation mode to **AVH** to operate the menu by using the joystick on the remote control. (Refer to page 14.)

1 Click the joystick during display of each source to display MENU.

MENU appears on the display.

2 Move the joystick up or down and then click it to display the function names you want to operate.

- To go to the next group of function names, move the joystick to **NEXT** and click it.
- To return to the previous group of function names, move the joystick to **PREV** and click it.

3 Press BAND/ESC to return to the display of each source.

- You can return to the previous display by pressing **BACK**. 

Opening and closing the LCD panel

The LCD panel will be opened or closed automatically with the turning of the ignition switch on or off. You can turn off the automatic close/open function. (Refer to page 79.)

- The automatic close/open function will operate the display as follows.

- When the ignition switch is turned OFF while the LCD panel is opened, the LCD panel will close after six seconds.

- When the ignition switch is turned ON again (or turned to ACC), the LCD panel will be opened automatically.

- Removing or attaching the front panel will automatically close or open the LCD panel. (Refer to page 22.)

- When the ignition switch is turned OFF after the LCD panel has been closed, turning the ignition switch ON again (or turning it to ACC) will not open the LCD panel. In this case, press **OPEN/CLOSE** to open the LCD panel.
- When closing the LCD panel, check to make sure that it has closed completely. If the LCD panel has stopped halfway, leaving it like this could result in damage.

● Press OPEN/CLOSE to open the LCD panel.

- To close the LCD panel, press **OPEN/CLOSE** again.

Adjusting the LCD panel angle

Important

- If you can hear the LCD panel knocking against your vehicle's console or dashboard, press **ANGLE (-)** to move the LCD panel a little forward.
- When adjusting the LCD panel angle, be sure to press **ANGLE (+/-)**. Forcibly adjusting the LCD panel by hand may damage it.

● Press ANGLE (+/-) to adjust the LCD panel to an easily viewable angle.

The LCD panel angle continues changing as long as you press **ANGLE (+/-)** and hold.

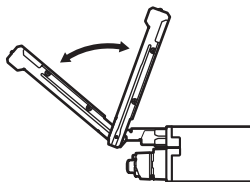

- The adjusted LCD panel angle will be memorized and automatically returned to the next time the LCD panel is opened.

Turning the LCD panel horizontal

When the LCD panel is upright and it hinders the operation of the air conditioner, the position of the panel can be turned horizontal temporarily.

● Press **FLIP DOWN/CLOCK** to turn the LCD panel horizontal.

- To return to original position, press **FLIP DOWN/CLOCK** again.
- The LCD panel returns to the original position automatically with beep sounds 10 seconds after operation.

Changing the wide screen mode

You can select a desired mode for enlarging a 4:3 picture to a 16:9 one.

● Press **WIDE** to select the desired setting.

Press **WIDE** repeatedly to switch between the following settings:

FULL (full)—**JUST** (just)—**CINEMA** (cinema)
—**ZOOM** (zoom)—**NORMAL** (normal)

FULL (full)

A 4:3 picture is enlarged in the horizontal direction only, enabling you to enjoy a 4:3 TV picture (normal picture) without any omissions.

JUST (just)

The picture is enlarged slightly at the center and the amount of enlargement increases horizontally to the ends, enabling you to enjoy a 4:3 picture without sensing any disparity even on a wide screen.

CINEMA (cinema)

A picture is enlarged by the same proportion as **FULL** or **ZOOM** in the horizontal direction and by an intermediate proportion between **FULL** and **ZOOM** in the vertical direction; ideal for a cinema-sized picture (wide screen picture) where captions lie outside.

ZOOM (zoom)

A 4:3 picture is enlarged in the same proportion both vertically and horizontally; ideal for a cinema-sized picture (wide screen picture).

NORMAL (normal)

A 4:3 picture is displayed as it is, giving you no sense of disparity since its proportions are the same as that of the normal picture.



Notes

- Different settings can be memorized for each video source.
- When video is viewed in a wide screen mode that does not match its original aspect ratio, it may appear differently.
- Remember that using the wide mode feature of this system for commercial or public viewing purposes may constitute an infringement on the author's rights protected by the Copyright Law.
- Video will appear grainy when viewed in **CINEMA** or **ZOOM** mode.
- The backup camera picture is always **FULL**.

Basic Operations

Adjusting the picture adjustment

You can adjust **BRIGHT** (brightness), **CONTRAST** (contrast), **COLOR** (color) and **HUE** (hue) for each source and back-up camera.

- The adjustments of **BRIGHT** and **CONTRAST** are stored separately for light ambient (daytime) and dark ambient (nighttime). A sun ☀ or moon 🌙 is displayed to the left of **BRIGHT** and **CONTRAST**, respectively, as the ambient light sensor determines brightness or darkness.
- You cannot adjust **HUE** for PAL video.
- You cannot adjust **COLOR** and **HUE** for the audio source.

1 Press MENU on the head unit and hold to display PICTURE ADJUST.

Press **MENU** until **PICTURE ADJUST** appears in the display.

- You cannot use **MENU** on the remote control.

2 Touch any of the following touch panel keys to select the function to be adjusted.

The adjustment function names are displayed and adjustable ones are highlighted.

- **BRIGHT** – Adjust the black intensity
- **CONTRAST** – Adjust the contrast
- **COLOR** – Adjust the color saturation
- **HUE** – Adjust the tone of color (red is emphasized or green is emphasized)
- **DIMMER** – Adjust the brightness of display
- **BACK-CAMERA** – Switch to the picture adjustment display for the back-up camera
- **SOURCE** – Return to the picture adjustment display for each source
- You can adjust the picture adjustment for back-up camera only when **B-CAMERA** is turned on. (Refer to *Setting for back-up camera* on page 78.)
- With some back-up camera, the picture adjustment may not be able to use.

3 Touch ◀ or ▶ to adjust the selected item.

Each time you touch ◀ or ▶ increases or decreases the level of selected item. **+24** – **-24** is displayed as the level is increased or decreased.

4 Touch ESC to hide the touch panel keys.

Adjusting the dimmer

The adjustment of **DIMMER** is stored separately for each ambient light; daytime, evening and nighttime. The brightness of LCD screen will be adjusted optimum level automatically in accordance with the ambient light based on the setting values.

1 Press MENU on the head unit and hold to display PICTURE ADJUST.

Press **MENU** until **PICTURE ADJUST** appears in the display.

2 Touch DIMMER.

The ambient light level used as the standard for adjusting **DIMMER** appears above the level bar.

- Yellow sun ☀ – Adjust the brightness for bright ambient light (daytime)
- Red sun 🌅 – Adjust the brightness for intermediate brightness (evening)
- Blue moon 🌙 – Adjust the brightness for dark ambient light (nighttime)

3 Touch ◀ or ▶ to adjust the brightness.

Each time you touch ◀ or ▶ moves yellow towards the left or the right.

The level indicates the brightness of the screen being adjusted. The farther yellow moves to the right, the brighter the screen.

4 Touch ESC to hide the touch panel keys.

Note

The icons indicating the current ambient brightness used for adjusting **BRIGHT** and **CONTRAST** may differ from **DIMMER** slightly. 

Protecting your unit from theft

The front panel can be detached from the head unit to discourage theft.

- If the front panel is not detached from the head unit within five seconds of turning off the ignition, a warning tone will sound.
- You can turn off the warning tone. See *Switching the warning tone* on page 75.

Important

- Never use force or grip the display and the buttons tightly when removing or attaching.
- Avoid subjecting the front panel to excessive shocks.
- Keep the front panel out of direct sunlight and high temperatures.
- Attach the front panel while driving, or else may result in scratching or damage.

Removing the front panel**1 Press DETACH to remove the front panel.**

Press **DETACH** and the right side of the front panel is removed from the head unit.

2 Grip the right side of the front panel and pull it gently outward.

Take care not to grip it tightly or to drop it.

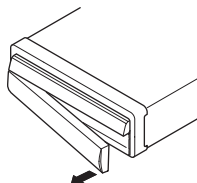
**Attaching the front panel**

- Replace the front panel by holding it upright to this unit and clipping it securely into the mounting hooks. 

Tuner

Listening to the radio

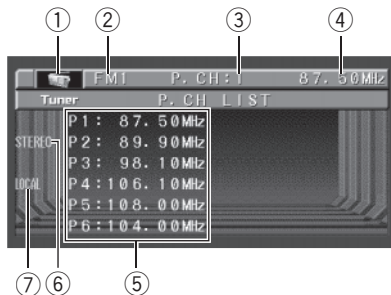

These are the basic steps necessary to operate the radio. More advanced tuner operation is explained starting on the next page.



Important

If you are using this unit in North, Central or South America, reset the AM tuning step (see *Setting the AM tuning step* on page 74).

① Source icon

Shows what the source has been selected.

② Band indicator

Shows which band the radio is tuned to, AM or FM.

③ Preset number indicator

Shows what preset has been selected.

④ Frequency indicator

Shows to which frequency the tuner is tuned.

⑤ Preset list display

Shows the preset list.

⑥ STEREO indicator

Shows that the frequency selected is being broadcast in stereo.

⑦ LOCAL indicator

Shows when local seek tuning is on.

1 Touch the source icon and then touch TUNER to select the tuner.

- When the source icon is not displayed, you can display it by touching the screen.

2 Touch the screen to display the touch panel keys.

3 Touch BAND to select a band.

Touch **BAND** repeatedly until the desired band is displayed, **FM1**, **FM2**, **FM3** for FM or **AM**.

4 To perform manual tuning, touch ◀ or ▶ shortly.

The frequencies move up or down step by step.

- You can also perform manual tuning by moving the joystick left or right.

5 To perform seek tuning, keep touching ◀ or ▶ for about one second and release.

The tuner will scan the frequencies until a broadcast strong enough for good reception is found.

- You can cancel seek tuning by touching either ◀ or ▶ shortly.
- If you keep touching ◀ or ▶ you can skip broadcasting stations. Seek tuning starts as soon as you release the keys.
- You can also perform seek tuning by holding the joystick left or right.



Note

If you do not use the touch panel keys for 30 seconds, they will be hidden automatically. ■

Introduction of advanced tuner operation

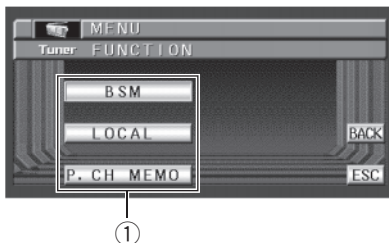

① Function display

Shows the function names.

- **Touch A.MENU and then touch FUNCTION to display the function names.**

The function names are displayed and operable ones are highlighted.

- When **A.MENU** is not displayed, you can display it by touching the screen.
- You can also display **MENU** by clicking the joystick.
- To return to the previous display, touch **BACK**.
- To return to the frequency display, touch **ESC**.

Note

If you do not operate the function within about 30 seconds, the display is automatically returned to the frequency display. 

Storing and recalling broadcast frequencies

If you touch any of the preset tuning keys **P 1—P 6** you can easily store up to six broadcast frequencies for later recall with the touch of a key.

- **When you find a frequency that you want to store in memory keep touching a preset tuning key P 1—P 6 until the preset number stops flashing.**

The number you have touched will flash in the preset number indicator and then remain lit. The selected radio station frequency has been stored in memory.

The next time you touch the same preset tuning key **P 1—P 6** the radio station frequency is recalled from memory.

- When the touch panel keys are not displayed, you can display them by touching the screen.
- When **P 1—P 6** are not displayed, you can display them by touching **DISP**.

Notes

- Up to 18 FM stations, 6 for each of the three FM bands, and 6 AM stations can be stored in memory.
- You can also use **▲** and **▼** to recall radio station frequencies assigned to preset tuning keys **P 1—P 6**.
- You can also perform the same operations using **P. CH MEMO**. To display **P. CH MEMO**, touch **A.MENU** and then touch **FUNCTION**. 

Tuning in strong signals

Local seek tuning lets you tune in only those radio stations with sufficiently strong signals for good reception.

1 Touch A.MENU and FUNCTION and then touch LOCAL.

2 Touch ▲ to turn local seek tuning on.

- To turn local seek tuning off, touch ▼.

3 Touch ◀ or ▶ to set the sensitivity.

There are four levels of sensitivity for FM and two levels for AM:

FM: **1—2—3—4**

AM: **1—2**

The **4** setting allows reception of only the strongest stations, while lower settings let you receive progressively weaker stations. 

Storing the strongest broadcast frequencies

BSM (best stations memory) lets you automatically store the six strongest broadcast frequencies under preset tuning keys **P 1—P 6** and once stored there you can tune in to those frequencies with the touch of a key.

1 Touch **A.MENU** and **FUNCTION** and then touch **BSM**.

2 Touch **▲** to turn **BSM** on.

BSM begins to flash. While **BSM** is flashing the six strongest broadcast frequencies will be stored under preset tuning keys **P 1—P 6** in order of their signal strength. When finished, **BSM** stops flashing.

- To cancel the storage process, touch **▼**.



Note

Storing broadcast frequencies with BSM may replace broadcast frequencies you have saved using **P 1—P 6**. 

Watching a DVD video

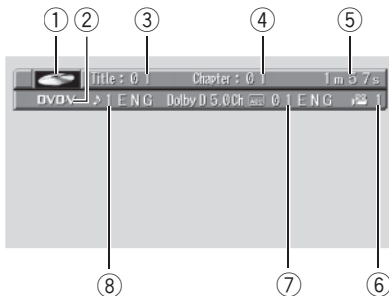

These are the basic steps necessary to play a DVD video with your DVD player. More advanced DVD video operation is explained starting on page 28.

- ① **Source icon**
Shows what the source has been selected.
- ② **DVD-V indicator**
Shows when a DVD video is playing.
- ③ **Title number indicator**
Shows the title currently playing.
- ④ **Chapter number indicator**
Shows the chapter currently playing.
- ⑤ **Play time indicator**
Shows the elapsed playing time of the current chapter.
- ⑥ **Viewing angle indicator**
Shows what viewing angle has been selected.
- ⑦ **Subtitle language indicator**
Shows what subtitle language has been selected.

- ⑧ **Audio language indicator**
Shows what audio language has been selected.

1 Touch the source icon and then touch DVD to select the DVD player.

- When the source icon is not displayed, you can display it by touching the screen.
- If no disc is loaded in this unit, you cannot select **DVD** (DVD player). Insert a disc in this unit. (Refer to page 16.)
- With some discs, a menu may be displayed. (Refer to *Operating the DVD menu* on the next page.)

2 Touch the screen to display the touch panel keys.

3 To skip back or forward to another chapter, touch ◀◀ or ▶▶.

Touching ▶▶ skips to the start of the next chapter. Touching ◀◀ once skips to the start of the current chapter. Touching again will skip to the previous chapter. Chapter numbers are displayed for eight seconds.

- You can also skip back or forward to another chapter by moving the joystick left or right.

4 Touch → to display ◀◀ and ▶▶.

Touch → until ◀◀ and ▶▶ appear in the display.

5 To perform fast forward or reverse, keep touching ◀◀ or ▶▶.

If you keep touching ◀◀ or ▶▶ for five seconds, the icon ◀◀ or ▶▶ changes into reversal indication. When this happens, fast reverse/fast forward continues even if you release ◀◀ or ▶▶. To resume playback at a desired point, touch ▶/||.

- You can also perform fast reverse/fast forward by holding the joystick left or right.

Playing DVD video discs

- Fast forward/fast reverse may not be possible at certain locations on some discs. If this happens, normal playback automatically resumes.



Notes

- You can display the repeat range selected currently by touching **DISP**.
- If you do not use the touch panel keys for 30 seconds, they will be hidden automatically.

Operating the DVD menu

Some DVDs allow you to select the disc contents using a menu.

- You can display the menu by touching **MENU** or **TOP.M** while a disc is playing. Touching either of these keys again lets you start playback from the location selected from the menu. For details, refer to the instructions provided with the disc.

1 Touch **◀▶** to display touch panel keys to operate the DVD menu.

- When the touch panel keys are not displayed, you can display them by touching the screen.

2 Touch **▲, ▼, ◀** or **▶** to select the desired menu item.

3 Touch **ENTER**.

Playback starts from the selected menu item.

- If you switch the remote control operation mode to **DVD**, the joystick on the remote control can also operate the DVD menu. (Refer to page 14.)
- You cannot operate the DVD menu by the joystick on the head unit.
- The way to display the menu differs depending on the disc.

Skipping back or forward to another title

- **To skip back or forward to another title, touch ▲ or ▼.**

Touching **▲** skips to the start of the next title. Touching **▼** skips to the start of the previous title.

Title numbers are displayed for eight seconds.

- You can also skip back or forward to another title by moving the joystick up or down.

Stopping playback

- **Touch ■.**

▪ When you stop DVD playback by touching **■**, that location on the disc is memorized enabling playback from that point when you play the disc again.

- To play back the disc again, touch **▶/||**.

Introduction of advanced DVD video operation

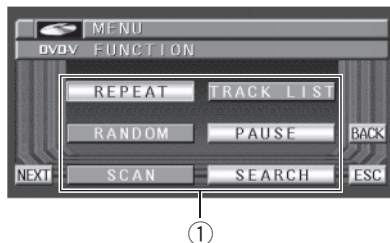

① Function display

Shows the function names.

- **Touch A.MENU and then touch FUNCTION to display the function names.**

The function names are displayed and operable ones are highlighted.

- When **A.MENU** is not displayed, you can display it by touching the screen.
- You can also display **MENU** by clicking the joystick.
- To go to the next group of function names, touch **NEXT**.
- To return to the previous group of function names, touch **PREV**.
- To return to the previous display, touch **BACK**.
- To return to the playback display, touch **ESC**.



Note

If you do not operate the function within about 30 seconds, the display is automatically returned to the playback display.

Repeating play

There are two repeat play ranges for the DVD playback: **TITLE** (title repeat) and **CHAPTER** (chapter repeat).

1 Touch **A.MENU** and **FUNCTION** and then touch **REPEAT**.

2 Touch any of the following touch panel keys to select the repeat range.

- **TITLE** – Repeat just the current title
- **CHAPTER** – Repeat just the current chapter
- **REPEAT OFF** – Play throughout the current disc



Note

If you perform chapter search or fast forward/reverse, the repeat play range changes to **REPEAT OFF**.

Pausing DVD video playback

Pause lets you temporarily stop disc playback.

- **Touch ►/|| during playback.**

The icon **||** is displayed for four seconds and playback is paused letting you view a still image.

- To resume playback at the same point that you turned pause on, touch **►/||** again.



Notes

- You can also turn on or off pause function using **PAUSE**. To display **PAUSE**, touch **A.MENU** and then touch **FUNCTION**.
- Depending on the disc and the playback location on the disc, the icon may be displayed indicating that still playback is not possible.

Frame-by-frame playback

This lets you move ahead one frame at a time during playback.



Playing DVD video discs

● Touch **II▶** during playback.

Each time you touch **II▶**, you move ahead one frame.

- To return to normal playback, touch **▶/II**.

Notes

- Depending on the disc and the playback location on the disc, the icon  may be displayed indicating that frame-by-frame playback is not possible.
- With some discs, images may be unclear during frame-by-frame playback. 

Slow motion playback

This lets you slow down playback speed.

1 Keep touching **II▶** until **▶▶** is displayed during playback.



The icon **▶▶** is displayed, forward slow motion playback begins.

- To return to normal playback, touch **▶/II**.

2 Press **◀II** or **II▶** to adjust playback speed during slow motion playback.

Each time you press **◀II** or **II▶** changes the speed in four steps in the following order: 1/16—1/8—1/4—1/2

Notes

- There is no sound during slow motion playback.
- Depending on the disc and the playback location on the disc, the icon  may be displayed indicating that slow motion playback is not possible.
- With some discs, images may be unclear during slow motion playback.
- Reverse slow motion playback is not possible. 

Searching for a desired scene, starting playback from a specified time

You can use the search function to search for a desired scene by specifying a title or chapter, and the time search function to specify the time on a disc at which play starts.

- Chapter search and time search are not possible when disc playback has been stopped.

1 Touch **SEARCH** and then touch **TITLE** (title), **CHAP.** (chapter) or **TIME** (time).

2 Touch **0—9** to input the desired number.

For titles and chapters

- To select 3, touch **3**.
- To select 10, touch **1** and **0** in order.
- To select 23, touch **2** and **3** in order.

For time (time search)

- To select 21 minutes 43 seconds, touch **2**, **1**, **4** and **3** in order.
- To select 1 hour 11 minutes, convert the time into 71 minutes 00 seconds and touch **7**, **1**, **0** and **0** in order.
- To cancel the input numbers, touch **C**.
- You can also input the desired number by using the joystick and **0-9**.

3 While the input number is displayed, touch **ENTER**.

This starts playback from the selected scene.

Notes

- You can also perform the same operations using **SEARCH**. To display **SEARCH**, touch **A.MENU** and then touch **FUNCTION**.
- With discs featuring a menu, you can also touch **MENU** or **TOP.M** and then make selections from the displayed menu.

- With some discs, the icon  may be displayed, indicating that titles, chapters and time cannot be specified.

Specifying title

You can use the direct search function to search for a desired scene by specifying a title.

- Only the remote control can operate this function. To perform this function, switch the remote control operation mode to **DVD**. (Refer to page 14.)
- **Press 0–10 corresponding to a desired title number when the disc is stopped.**

Title number is displayed for eight seconds and playback starts from the selected title.

- To select 3, press **3**.
- To select 10, press **10** and **0** in order.
- To select 23, press **10**, **10** and **3** in order. 

Changing audio language during playback (Multi-audio)

DVDs can provide audio playback with different languages and different systems (Dolby Digital, DTS etc.). With DVDs featuring multi-audio recordings, you can switch between languages/audio systems during playback.

- **Touch AUDIO during playback.**
- Each time you touch **AUDIO** switches between audio.

Notes

- The number in the  mark on a DVD's package indicates the number of recorded languages/audio systems.
- With some DVDs, switching between languages/audio systems may only be possible using a menu display.



- You can also switch between languages/audio systems using **DVD SETUP**. For details, refer to *Setting the audio language* on page 71.
- Only digital output of DTS audio is possible. If this unit's optical digital outputs are not connected, DTS audio will not be output, so select an audio setting other than DTS.
- Display indications such as **Dolby D** and **5.1ch** indicate the audio system recorded on the DVD. Depending on the setting, playback may not be with the same audio system as that indicated.
- Touching **AUDIO** during fast forward/fast reverse, pause or slow motion playback returns you to normal playback. 

Changing the subtitle language during playback (Multi-subtitle)

With DVDs featuring multi-subtitle recordings, you can switch between subtitle languages during playback.

- **Touch SUB.T during playback.**
- Each time you touch **SUB.T** switches between subtitle language.

Notes

- The number in the  mark on a DVD's package indicates the number of recorded subtitle languages.
- With some DVDs, switching between subtitle languages may only be possible using a menu display.
- You can also switch between subtitle languages using **DVD SETUP**. For details, refer to *Setting the subtitle language* on page 70.
- Touching **SUB.T** during fast forward/fast reverse, pause or slow motion playback returns you to normal playback. 

Playing DVD video discs

Changing the viewing angle during playback (Multi-angle)

With DVDs featuring multi-angle (scenes shot from multiple angles) recordings, you can switch among viewing angles during playback.



- During playback of a scene shot from multiple angles on this unit, the angle icon  is displayed. Turn angle icon display on or off using **DVD SETUP**. For details, refer to *Setting angle icon display* on page 72.

- **Touch ANGLE during playback of a scene shot from multiple angles.**

Each time you touch **ANGLE** switches between angle.



Notes

- The  mark on a DVD's package indicates it features multi-angle scenes. The number in the  mark indicates the number of angles from which scenes were shot.
- Touching **ANGLE** during fast forward/fast reverse, pause or slow motion playback returns you to normal playback. 

Watching a Video CD

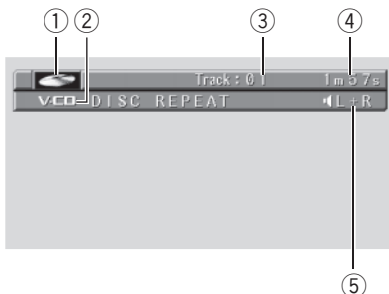

These are the basic steps necessary to play a Video CD with your DVD player. More advanced Video CD operation is explained starting on the next page.

- ① **Source icon**
Shows what the source has been selected.
- ② **V-CD indicator**
Shows when a Video CD is playing.
- ③ **Track number indicator**
Shows the track currently playing.
- ④ **Play time indicator**
Shows the elapsed playing time of the current track.
- ⑤ **Audio output indicator**
Shows the output channel selected currently.

1 Touch the source icon and then touch DVD to select the DVD player.

- When the source icon is not displayed, you can display it by touching the screen.
- If no disc is loaded in this unit, you cannot select **DVD** (DVD player). Insert a disc in this unit. (Refer to page 16.)

- With a Video CD featuring the PBC (playback control) function, a menu is displayed.

2 Switch the remote control operation mode to DVD and then press 0-10 to select the desired menu item.

Playback starts from the selected menu item.

- When the menu is two or more pages long, touch **◀◀** or **▶▶** to switch between displays.
- You can play a disc without using a menu (without PBC playback). (Refer to *Searching for a desired scene, starting playback from a specified time* on page 35.) To return to PBC playback, stop playback and touch **▶/II**.
- You can display the menu by pressing **RETURN** during PBC playback. For details, refer to the instructions provided with the disc.
- After operating the menu, we recommend that you switch remote control operation mode to **AVH**. (Refer to page 14.)

3 Touch the screen to display the touch panel keys.

4 To skip back or forward to another track, touch **◀◀** or **▶▶**.

Touching **▶▶** skips to the start of the next track. Touching **◀◀** once skips to the start of the current track. Touching again will skip to the previous track.

Track numbers are displayed for eight seconds.

- You can also skip back or forward to another track by moving the joystick left or right.
- During PBC playback, a menu may be displayed if you perform these operations.

5 Touch **→** to display **◀◀** and **▶▶**.

Touch **→** until **◀◀** and **▶▶** appear in the display.

6 To perform fast forward or reverse, keep touching **◀◀** or **▶▶**.

If you keep touching **◀◀** or **▶▶** for five seconds, the icon **◀◀** or **▶▶** changes into rever-

Playing Video CDs

sal indication. When this happens, fast reverse/fast forward continues even if you release ◀◀ or ▶▶. To resume playback at a desired point, touch ▶/||.

- You can also perform fast reverse/fast forward by holding the joystick left or right.
- Fast forward/fast reverse may not be possible at certain locations on some discs. If this happens, normal playback automatically resumes.



Note

If you do not use the touch panel keys for 30 seconds, they will be hidden automatically. ◻

Stopping playback

● Touch ■.

- When you stop Video CD playback (during PBC playback only) by touching ■, that location on the disc is memorized enabling playback from that point when you play the disc again.
- To play back the disc again, touch ▶/||. ◻

Introduction of advanced Video CD operation

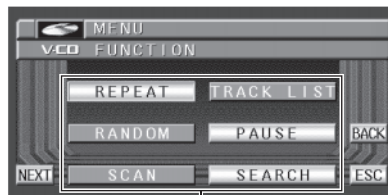

① Function display

Shows the function names.

● Touch A.MENU and then touch FUNCTION to display the function names.

The function names are displayed and operable ones are highlighted.

- When **A.MENU** is not displayed, you can display it by touching the screen.
- You can also display **MENU** by clicking the joystick.
- To go to the next group of function names, touch **NEXT**.
- To return to the previous group of function names, touch **PREV**.
- To return to the previous display, touch **BACK**.
- To return to the playback display, touch **ESC**.



Note

If you do not operate the function within about 30 seconds, the display is automatically returned to the playback display. ◻

Repeating play

There are two repeat play ranges for the Video CD playback: **TRACK** (track repeat) and **DISC** (disc repeat).

Playing Video CDs

- During PBC playback of Video CDs, this function cannot be operated.

1 Touch A.MENU and FUNCTION and then touch REPEAT.

2 Touch either of the following touch panel keys to select the repeat range.

- **TRACK** – Repeat just the current track
- **DISC** – Repeat the current disc

Note

If you perform track search or fast forward/reverse, the repeat play range changes to **DISC**. 

Pausing Video CD playback



Pause lets you temporarily stop disc playback.

• Touch ►/II during playback.

The icon **II** is displayed for four seconds and playback is paused letting you view a still image.

- To resume playback at the same point that you turned pause on, touch ►/II again.

Notes

- You can also turn on or off pause function using **PAUSE**. To display **PAUSE**, touch **A.MENU** and then touch **FUNCTION**.
- Depending on the disc and the playback location on the disc, the icon  may be displayed indicating that still playback is not possible. 

Frame-by-frame playback



This lets you move ahead one frame at a time during playback.

• Touch II► during playback.

Each time you touch **II►**, you move ahead one frame.

- To return to normal playback, touch ►/II.

Notes

- Depending on the disc and the playback location on the disc, the icon  may be displayed indicating that frame-by-frame playback is not possible.
- With some discs, images may be unclear during frame-by-frame playback. 

Slow motion playback

This lets you slow down playback speed.

1 Keep touching II► until ►► is displayed during playback.



The icon **►►** is displayed, forward slow motion playback begins.

- To return to normal playback, touch ►/II.

2 Press ◀II or II► to adjust playback speed during slow motion playback.

Each time you press **◀II** or **II►** changes the speed in four steps in the following order: 1/16—1/8—1/4—1/2

Notes

- There is no sound during slow motion playback.
- Depending on the disc and the playback location on the disc, the icon  may be displayed indicating that slow motion playback is not possible.
- With some discs, images may be unclear during slow motion playback.
- Reverse slow motion playback is not possible. 

Playing Video CDs

Searching for a desired scene, starting playback from a specified time

You can use the search function to search for a desired scene by specifying a track, and the time search function to specify the time on a disc at which play starts.

- During PBC playback of Video CDs, this function cannot be operated.
- Time search is not possible when disc playback has been stopped.

1 Touch **SEARCH** and then touch **TRACK (track)** or **TIME (time)**.

2 Touch **0—9** to input the desired number.

For tracks

- To select 3, touch **3**.
- To select 10, touch **1** and **0** in order.
- To select 23, touch **2** and **3** in order.

For time (time search)

- To select 21 minutes 43 seconds, touch **2**, **1**, **4** and **3** in order.
- To select 1 hour 11 minutes, convert the time into 71 minutes 00 seconds and touch **7**, **1**, **0** and **0** in order.
- To cancel the input numbers, touch **C**.
- You can also input the desired number by using the joystick and **0-9**.

3 While the input number is displayed, touch **ENTER**.

This starts playback from the selected scene.



Note

You can also perform the same operations using **SEARCH**. To display **SEARCH**, touch **A.MENU** and then touch **FUNCTION**.

Specifying track

You can use the direct search function to search for a desired scene by specifying a track.

- Only the remote control can operate this function. To perform this function, switch the remote control operation mode to **DVD**. (Refer to page 14.)
- During PBC playback of Video CDs, this function cannot be operated.



● Press **0–10** corresponding to a desired track number when the disc is stopped.

Track number is displayed for eight seconds and playback starts from the selected track.

- To select 3, press **3**.
- To select 10, press **10** and **0** in order.
- To select 23, press **10**, **10** and **3** in order.



Note

With some discs, the icon  may be displayed and operation may not be possible. 

Selecting audio output

You can switch between stereo and monaural audio output.

● Press **AUDIO** during playback.

Press **AUDIO** repeatedly to switch between the following outputs:

L+R (left and right channels)—**L** (left channel)
—**R** (right channel)



Note

You can also perform the same operations using **L/R SELECT**. To display **L/R SELECT**, touch **A.MENU** and **FUNCTION** and then touch **NEXT**. 

Listening a CD

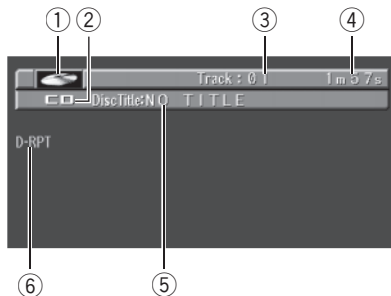

These are the basic steps necessary to play a CD with your DVD player. More advanced CD operation is explained starting on the next page.

- ① **Source icon**
Shows what the source has been selected.
- ② **CD indicator**
Shows when a CD is playing.
- ③ **Track number indicator**
Shows the track currently playing.
- ④ **Play time indicator**
Shows the elapsed playing time of the current track.
- ⑤ **Disc title indicator**
Shows the title of the currently playing disc.
- ⑥ **Repeat indicator**
Shows the selected repeat range.

1 Touch the source icon and then touch DVD to select the DVD player.

- When the source icon is not displayed, you can display it by touching the screen.
- If no disc is loaded in this unit, you cannot select **DVD** (DVD player). Insert a disc in this unit. (Refer to page 16.)

2 Touch the screen to display the touch panel keys.

3 To skip back or forward to another track, touch ◀◀ or ▶▶.

Touching ▶▶ skips to the start of the next track. Touching ◀◀ once skips to the start of the current track. Touching again will skip to the previous track.

Track numbers are displayed for eight seconds.

- You can also skip back or forward to another track by moving the joystick left or right.

4 Touch → to display ◀◀ and ▶▶.

Touch → until ◀◀ and ▶▶ appear in the display.

5 To perform fast forward or reverse, keep touching ◀◀ or ▶▶.

- You can also perform fast reverse/fast forward by holding the joystick left or right.



Notes

- When playing discs with MP3 files and audio data (CD-DA) such as CD-EXTRA and MIXED-MODE CDs, both types can be played only by switching mode between MP3 and CD-DA by touching **DA-MP3** or pressing **BAND/ESC**.
- If you do not use the touch panel keys for 30 seconds, they will be hidden automatically. ◻

Stopping playback

● Touch ■.

- When you stop CD playback by touching ■, that location on the disc is memorized enabling playback from that point when you play the disc again.
- To play back the disc again, touch ▶/|| ◻

Playing CDs

Introduction of advanced CD operation

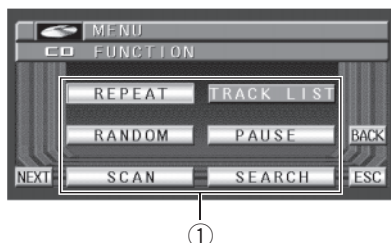

① Function display

Shows the function names.

● Touch **A.MENU** and then touch **FUNCTION** to display the function names.

The function names are displayed and operable ones are highlighted.

- When **A.MENU** is not displayed, you can display it by touching the screen.
- You can also display **MENU** by clicking the joystick.
- To go to the next group of function names, touch **NEXT**.
- To return to the previous group of function names, touch **PREV**.
- To return to the previous display, touch **BACK**.
- To return to the playback display, touch **ESC**.

Note

If you do not operate the function within about 30 seconds, the display is automatically returned to the playback display. 

Repeating play

Repeat play lets you hear the same track over again.

1 Touch **A.MENU** and **FUNCTION** and then touch **REPEAT**.

2 Touch either of the following touch panel keys to select the repeat range.

- **TRACK** – Repeat just the current track
- **DISC** – Repeat the current disc



Notes

- If you perform track search or fast forward/reverse, repeat play is automatically cancelled.
- When playing discs with MP3 files and audio data (CD-DA), repeat play performs within the currently playing data type even if **DISC** is selected. 

Playing tracks in a random order

Random play lets you play back tracks on the CD in a random order.

1 Touch **A.MENU** and **FUNCTION** and then touch **RANDOM**.

2 Touch **▲** to turn random play on.

Tracks will play in a random order.

- To turn random play off, touch **▼**. 

Scanning tracks of a CD

Scan play lets you hear the first 10 seconds of each track on the CD.

1 Touch **A.MENU** and **FUNCTION** and then touch **SCAN**.

2 Touch **▲** to turn scan play on.

The first 10 seconds of each track is played.

3 When you find the desired track touch **▼** to turn scan play off.

 **Note**

After scanning of a CD is finished, normal playback of the tracks will begin again. 

Pausing CD playback

Pause lets you temporarily stop disc playback.

● Touch ►/|| during playback.

The icon **||** is displayed for four seconds and playback is paused.

- To resume playback at the same point that you turned pause on, touch **►/||** again.

 **Note**

You can also turn on or off pause function using **PAUSE**. To display **PAUSE**, touch **A.MENU** and then touch **FUNCTION**. 

Searching for a desired track

You can use the search function to specify a track to search for a desired track.

1 Touch SEARCH and then touch TRACK.**2 Touch 0—9 to input the desired number.**

- To select 3, touch **3**.
- To select 10, touch **1** and **0** in order.
- To select 23, touch **2** and **3** in order.
- To cancel the input numbers, touch **C**.
- You can also input the desired number by using the joystick and **0-9**.

3 While the input number is displayed, touch ENTER.

This starts playback from the selected track.

 **Note**

You can also perform the same operations using **SEARCH**. To display **SEARCH**, touch **A.MENU** and then touch **FUNCTION**. 

Entering disc titles

You can input CD titles and display the title. The next time you insert a CD for which you have entered a title, the title of that CD will be displayed.

Disc title input lets you input CD titles up to 10 letters long and up to 48 disc titles into this unit.

- When playing a CD TEXT disc, you cannot switch to **TITLE EDIT**. The disc title will have already been recorded on a CD TEXT disc.
- If no title has been entered for the currently playing disc, **NO TITLE** is displayed.

1 Play a CD that you want to enter the title.**2 Touch A.MENU and FUNCTION and then touch NEXT.****3 Touch TITLE EDIT.****4 Touch ABC to select the desired character type.**

Touch **ABC** repeatedly to switch between the following character type:
Alphabet (upper case), numbers and symbols
—Alphabet (lower case)

- You can select to input numbers and symbols by touching **123**.

5 Touch ▲ or ▼ to select a letter of the alphabet.

Each time you touch **▲** will display a letter of the alphabet in **A B C ... X Y Z**, numbers and symbols in **1 2 3 ... }** order. Each time you

Playing CDs

touch ▼ will display a letter in the reverse order, such as **Z Y X ... C B A** order.



6 Touch ► to move the cursor to the next character position.

When the desired letter is displayed, touch ► to move the cursor to the next position and then select the next letter. Touch ◀ to move backwards in the display.

7 Touch OK to store the entered title in memory.

8 Touch ESC to return to the playback display.



Notes

- Titles remain in memory, even after the disc has been removed from this unit, and are recalled when the disc is reinserted.
- After data for 48 discs has been stored in memory, data for a new disc will overwrite the oldest one. □

Using CD TEXT functions

Some discs have certain information encoded on the disc during manufacture. These discs may contain such information as the CD title, track title, artist's name and playback time and are called CD TEXT discs. Only these specially encoded CD TEXT discs support the functions listed below.

Displaying titles on CD TEXT discs

● Touch DISP.

Touch **DISP** repeatedly to switch between the following settings:

DiscTitle (disc title)—**DiscArtist** (disc artist name)—**TrackTitle** (track title)—**T.Artist** (track artist name)

- If specific information has not been recorded on a CD TEXT disc, **NO XXXX** will be displayed (e.g., **NO ARTIST**).

Scrolling titles in the display

This unit can display the first 19 letters only of **DiscTitle**, **DiscArtist**, **TrackTitle** and **T.Artist**. When the recorded information is longer than 19 letters, you can scroll the text to the left so that the rest of the title can be seen.

● Keep touching DISP until the title begins to scroll to the left.

The rest of the title will appear in the display.

Selecting tracks from the track title list

Track title list lets you see the list of track titles on a CD TEXT disc and select one of them to playback.

1 Touch A.MENU and FUNCTION and then touch TRACK LIST.

2 Touch PREV or NEXT to switch between the lists of titles.

3 Touch your favorite track title.

That selection will begin to play. □

Listening MP3

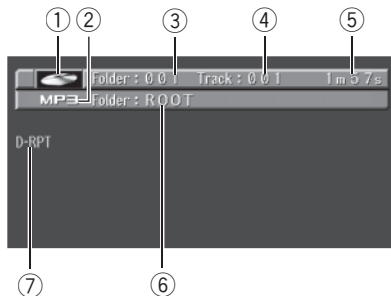

These are the basic steps necessary to play an MP3 with your DVD player. More advanced MP3 operation is explained starting on the next page.

- ① **Source icon**
Shows what the source has been selected.
- ② **MP3 indicator**
Shows when the MP3 file is playing.
- ③ **Folder number indicator**
Shows the folder number currently playing.
- ④ **Track number indicator**
Shows the track (file) currently playing.
- ⑤ **Play time indicator**
Shows the elapsed playing time of the current track (file).
- ⑥ **Folder name indicator**
Shows the folder name currently playing.
- ⑦ **Repeat indicator**
Shows the selected repeat range.

1 Touch the source icon and then touch DVD to select the DVD player.

- When the source icon is not displayed, you can display it by touching the screen.
- If no disc is loaded in this unit, you cannot select **DVD** (DVD player). Insert a disc in this unit. (Refer to page 16.)

2 Touch the screen to display the touch panel keys.

3 To skip back or forward to another track, touch ◀◀ or ▶▶.

Touching ▶▶I skips to the start of the next track. Touching I◀◀ once skips to the start of the current track. Touching again will skip to the previous track.

Track numbers are displayed for eight seconds.

- You can also skip back or forward to another track by moving the joystick left or right.

4 Touch → to display ▲, ▼, ◀◀ and ▶▶.

Touch → until ▲, ▼, ◀◀ and ▶▶ appear in the display.

5 To perform fast forward or reverse, keep touching ◀◀ or ▶▶.

- You can also perform fast reverse/fast forward by holding the joystick left or right.
- There is no sound on fast forward or reverse.
- This is fast forward and reverse operation only for the file being played. This operation is canceled when the previous or next file is reached.

6 Touch ▲ or ▼ to select a folder.



- You can also select a folder by moving the joystick up or down.
- To return to folder 01 (ROOT), press and hold **BAND/ESC**. However, if folder 01 (ROOT) contains no files, playback commences with folder 02.
- You cannot select a folder that does not have an MP3 file recorded in it.

Playing MP3

Notes

- When playing discs with MP3 files and audio data (CD-DA) such as CD-EXTRA and MIXED-MODE CDs, both types can be played only by switching mode between MP3 and CD-DA by touching **DA-MP3** or pressing **BAND/ESC**.
- If you have switched between playback of MP3 files and audio data (CD-DA), playback starts at the first track on the disc.
- This DVD player can play back an MP3 file recorded on CD-ROM. (Refer to page 86 for files that can be played back.)
- There is sometimes a delay between starting up playback and the sound being issued. This is particularly the case when playing back multi-session and many folders. When being read in, **FORMAT READ** is displayed.
- Playback is carried out in order of file number. Folders are skipped if they contain no files. (If folder 01 (ROOT) contains no files, playback commences with folder 02.)
- When playing back files recorded as VBR (variable bit rate) files, the play time will not be correctly displayed if fast forward or reverse operations are used.
- If you do not use the touch panel keys for 30 seconds, they will be hidden automatically. 

Stopping playback

- **Touch .**
 - When you stop MP3 playback by touching , that location on the disc is memorized enabling playback from that point when you play the disc again.
 - To play back the disc again, touch **▶/II**. 

Introduction of advanced MP3 operation

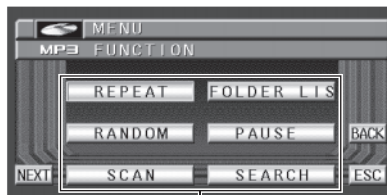

① Function display

Shows the function names.

- **Touch A.MENU and then touch FUNCTION to display the function names.** The function names are displayed and operable ones are highlighted.
 - When **A.MENU** is not displayed, you can display it by touching the screen.
 - You can also display **MENU** by clicking the joystick.
 - To go to the next group of function names, touch **NEXT**.
 - To return to the previous group of function names, touch **PREV**.
 - To return to the previous display, touch **BACK**.
 - To return to the playback display, touch **ESC**.

Note

If you do not operate the function within about 30 seconds, the display is automatically returned to the playback display. 

Repeating play

For MP3 playback, there are three repeat play ranges: **FOLDER** (folder repeat), **TRACK** (one-track repeat) and **DISC** (repeat all tracks).

Playing MP3

1 Touch A.MENU and FUNCTION and then touch REPEAT.

2 Touch any of the following touch panel keys to select the repeat range.

- **FOLDER** – Repeat the current folder
- **TRACK** – Repeat just the current track
- **DISC** – Repeat all tracks



Notes

- If you select other folder during repeat play, the repeat play range changes to **DISC**.
- If you perform track search or fast forward/reverse during **TRACK**, the repeat play range changes to **FOLDER**.
- When **FOLDER** is selected, it is not possible to play back a subfolder of that folder.
- When playing discs with MP3 files and audio data (CD-DA), repeat play performs within the currently playing data type even if **DISC** is selected.

Playing tracks in a random order

Random play lets you play back tracks in a random order within the repeat range, **FOLDER** and **DISC**.

1 Select the repeat range.

Refer to *Repeating play* on the previous page.

2 Touch A.MENU and FUNCTION and then touch RANDOM.

3 Touch ▲ to turn random play on.

Tracks will play in a random order within the previously selected **FOLDER** or **DISC** ranges.

- To turn random play off, touch ▼.

Scanning folders and tracks

While you are using **FOLDER**, the beginning of each track in the selected folder plays for about 10 seconds. When you are using **DISC**, the beginning of the first track of each folder is played for about 10 seconds.

1 Select the repeat range.

Refer to *Repeating play* on the previous page.

2 Touch A.MENU and FUNCTION and then touch SCAN.

3 Touch ▲ to turn scan play on.

The first 10 seconds of each track of the current folder (or the first track of each folder) is played.

4 When you find the desired track (or folder) touch ▼ to turn scan play off.



Note

After track or folder scanning is finished, normal playback of the tracks will begin again.

Pausing MP3 playback

Pause lets you temporarily stop disc playback.

● **Touch ►/|| during playback.**

The icon **||** is displayed for four seconds and playback is paused.

- To resume playback at the same point that you turned pause on, touch ►/|| again.



Note

You can also turn on or off pause function using **PAUSE**. To display **PAUSE**, touch **A.MENU** and then touch **FUNCTION**.

Playing MP3

Searching for a desired track in the current folder

You can use the search function to specify a track to search for a desired track.

- Track search is not possible when disc playback has been stopped.

1 Touch **SEARCH** and then touch **TRACK**.

2 Touch **0—9** to input the desired number.

- To select 3, touch **3**.
- To select 10, touch **1** and **0** in order.
- To select 23, touch **2** and **3** in order.
- To cancel the input numbers, touch **C**.
- You can also input the desired number by using the joystick and **0-9**.

3 While the input number is displayed, touch **ENTER**.

This starts playback from the selected track.



Note

You can also perform the same operations using **SEARCH**. To display **SEARCH**, touch **A.MENU** and then touch **FUNCTION**. □

Displaying text information on MP3 disc

Text information recorded on a MP3 disc can be displayed.

● Touch **DISP**.

Touch **DISP** repeatedly to switch between the following settings:

- Folder** (folder name)—**File** (file name)
- TrackTitle** (track title)—**Artist** (artist name)
- Album** (album title)—**Comment** (comment)
- BitRate** (bit rate)

- When playing back files recorded as VBR (variable bit rate) files, the bit rate value is not displayed even after switching to bit rate. (**VBR** will be displayed.)

- If specific information has not been recorded on a MP3 disc, **NO XXXX** will be displayed (e.g., **NO NAME**). □

Scrolling text information in the display

This unit can display the first 19 letters only of **Folder**, **File**, **TrackTitle**, **Artist**, **Album** and **Comment**. When the recorded information is longer than 19 letters, you can scroll the text to the left so that the rest of the text information can be seen.

● Keep touching **DISP** until the text information begins to scroll to the left.

The rest of the text information will appear in the display. □

Selecting folders from the folder name list

Folder name list lets you see the list of folder names on an MP3 disc and select one of them to playback.

1 Touch **A.MENU** and **FUNCTION** and then touch **FOLDER LIS**.

2 Touch **PREV** or **NEXT** to switch between the lists of names.

3 Touch your favorite folder name.

That selection will begin to play. □

Listening a CD

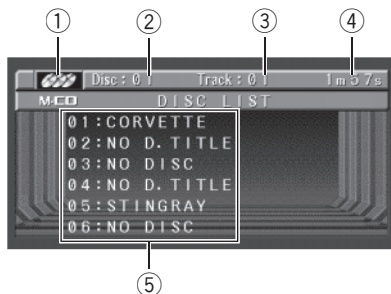

You can use this unit to control a multi-CD player, which is sold separately.

These are the basic steps necessary to play a CD with your multi-CD player. More advanced CD operation is explained starting on the next page.

- ① **Source icon**
Shows that the source has been selected.
- ② **Disc number indicator**
Shows the disc currently playing.
- ③ **Track number indicator**
Shows the track currently playing.
- ④ **Play time indicator**
Shows the elapsed playing time of the current track.
- ⑤ **Disc list display**
Shows the disc title list.

1 Touch the source icon and then touch M-CD to select the multi-CD player.

- When the source icon is not displayed, you can display it by touching the screen.

2 Touch the screen to display the touch panel keys.

3 Touch any of 01—06 to select a disc you want to listen to.

If you want to select a disc located at 7 to 12, touch **PREV** or **NEXT** to display **07—12**.

- When **01—06** and **07—12** are not displayed, you can display them by touching **DISP**.
- You can also sequentially select a disc by using **▲/▼**.

4 To skip back or forward to another track, touch ◀ or ▶.

Touching **▶** skips to the start of the next track. Touching **◀** once skips to the start of the current track. Touching again will skip to the previous track.

- You can also skip back or forward to another track by moving the joystick left or right.

5 To perform fast forward or reverse, keep touching ◀ or ▶.

- You can also perform fast reverse/fast forward by holding the joystick left or right.



Notes

- When the multi-CD player performs the preparatory operations, **READY** is displayed.
- If the multi-CD player does not operate properly, an error message such as **ERROR-11** may be displayed. Refer to the multi-CD player owner's manual.
- If there are no discs in the multi-CD player magazine, **NO DISC** is displayed.
- If you do not use the touch panel keys for 30 seconds, they will be hidden automatically.

50-disc multi-CD player

Only those functions described in this manual are supported for 50-disc multi-CD players.

Multi-CD Player

Introduction of advanced multi-CD player operation

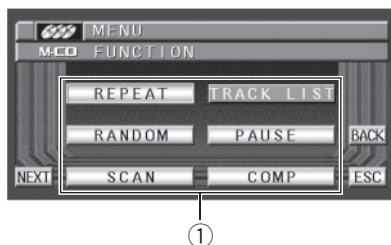

① Function display

Shows the function names.

● Touch **A.MENU** and then touch **FUNCTION** to display the function names.

The function names are displayed and operable ones are highlighted.

- When **A.MENU** is not displayed, you can display it by touching the screen.
- You can also display **MENU** by clicking the joystick.
- To go to the next group of function names, touch **NEXT**.
- To return to the previous group of function names, touch **PREV**.
- To return to the previous display, touch **BACK**.
- To return to the playback display, touch **ESC**.

Note

If you do not operate the function within about 30 seconds, the display is automatically returned to the playback display. 

Repeating play

There are three repeat play ranges for the multi-CD player: **M-CD** (multi-CD player re-

peat), **TRACK** (one-track repeat) and **DISC** (disc repeat).

1 Touch **A.MENU** and **FUNCTION** and then touch **REPEAT**.

2 Touch **◀▶** to select the repeat range.

Touch **◀▶** repeatedly until the desired repeat range appears in the display.

- **M-CD** – Repeat all discs in the multi-CD player
- **TRACK** – Repeat just the current track
- **DISC** – Repeat the current disc
- You can also select the repeat range by moving the joystick left or right.

Notes

- If you select other discs during repeat play, the repeat play range changes to **M-CD**.
- If you perform track search or fast forward/reverse during **TRACK**, the repeat play range changes to **DISC**. 

Playing tracks in a random order

Random play lets you play back tracks in a random order within the repeat range, **M-CD** and **DISC**.

1 Select the repeat range.

Refer to *Repeating play* on this page.

2 Touch **A.MENU** and **FUNCTION** and then touch **RANDOM**.

3 Touch **▲** to turn random play on.

Tracks will play in a random order within the previously selected **M-CD** or **DISC** ranges.

- To turn random play off, touch **▼**. 

Scanning CDs and tracks

While you are using **DISC**, the beginning of each track on the selected disc plays for about 10 seconds. When you are using **M-CD**, the beginning of the first track of each disc is played for about 10 seconds.

1 Select the repeat range.

Refer to *Repeating play* on the previous page.

2 Touch A.MENU and FUNCTION and then touch SCAN.

3 Touch ▲ to turn scan play on.

The first 10 seconds of each track of the current disc (or the first track of each disc) is played.

4 When you find the desired track (or disc) touch ▼ to turn scan play off.



Note

After track or disc scanning is finished, normal playback of the tracks will begin again. 

Pausing CD playback

Pause lets you temporarily stop disc playback.

1 Touch A.MENU and FUNCTION and then touch PAUSE.

2 Touch ▲ to turn pause on.

Play of the current track pauses.

- To turn pause off, touch ▼. 

Using ITS playlists

ITS (instant track selection) lets you make a playlist of favorite tracks from those in the

multi-CD player magazine. After you have added your favorite tracks to the playlist you can turn on ITS play and play just those selections.

Creating a playlist with ITS programming

You can use ITS to enter and playback up to 99 tracks per disc, up to 100 discs (with the disc title). (With multi-CD players sold before the CDX-P1250 and CDX-P650, up to 24 tracks can be stored in the playlist.)

1 Play a CD that you want to program.

Touch ▲ or ▼ to select a CD.

2 Touch A.MENU and FUNCTION and then touch NEXT.

3 Touch ITS MEMORY.

4 Touch ◀ or ▶ to select a desired track.

5 Touch ▲ to store the currently playing track in the playlist.

MEMORY is displayed briefly and the currently playing selection is added to your playlist. The display then shows track number again.



Note

After data for 100 discs has been stored in memory, data for a new disc will overwrite the oldest one.

Playback from your ITS playlist

ITS play lets you listen to the tracks that you have entered into your ITS playlist. When you turn on ITS play, tracks from your ITS playlist in the multi-CD player will begin to play.

Multi-CD Player

1 Select the repeat range.

Refer to *Repeating play* on page 45.

2 Touch A.MENU and FUNCTION and then touch NEXT.

3 Touch ITS PLAY.

4 Touch ▲ to turn ITS play on.

Playback begins of those tracks from your playlist within the previously selected **M-CD** or **DISC** ranges.

- If no tracks in the current range are programmed for ITS play then **ITS EMPTY** is displayed.
- To turn ITS play off, touch ▼.

Erasing a track from your ITS playlist

When you want to delete a track from your ITS playlist, you can if ITS play is on. If ITS play is already on, skip to step 2.

1 Play a CD you want to delete a track from your ITS playlist, and turn ITS play on.

Refer to *Playback from your ITS playlist* on the previous page.

2 Touch A.MENU and FUNCTION and then touch NEXT.

3 Touch ITS MEMORY.

4 Touch ◀ or ▶ to select a desired track.

5 Touch ▼ to erase a track from your ITS playlist.

The currently playing selection is erased from your ITS playlist and playback of the next track from your ITS playlist begins.

- If there are no tracks from your playlist in the current range, **ITS EMPTY** is displayed and normal play resumes.

Erasing a CD from your ITS playlist

When you want to delete all tracks of a CD from your ITS playlist, you can if ITS play is off.

1 Play a CD that you want to delete.

Touch ▲ or ▼ to select a CD.

2 Touch A.MENU and FUNCTION and then touch NEXT.

3 Touch ITS MEMORY.

4 Touch ▼ to erase all tracks on the currently playing CD from your ITS playlist.

All tracks on the currently playing CD are erased from your playlist and **ALL CLEAR** is displayed. 

Using disc title functions

You can input CD titles and display the title. Then you can easily search for and select a desired disc for play.

Entering disc titles

Disc title input lets you input CD titles up to 10 letters long and up to 100 disc titles (with ITS playlist) into the multi-CD player.

- When playing a CD TEXT disc on a CD TEXT compatible multi-CD player, you cannot switch to **TITLE EDIT**. The disc title will have already been recorded on a CD TEXT disc.

1 Play a CD that you want to enter the title.

Touch ▲ or ▼ to select a CD.

2 Touch A.MENU and FUNCTION and then touch NEXT.

3 Touch TITLE EDIT.

4 Touch ABC to select the desired character type.

Touch **ABC** repeatedly to switch between the following character type:

Alphabet (upper case), numbers and symbols
—Alphabet (lower case)

- You can select to input numbers and symbols by touching **123**.

5 Touch ▲ or ▼ to select a letter of the alphabet.

Each time you touch **▲** will display a letter of the alphabet in **A B C ... X Y Z**, numbers and symbols in **1 2 3 ... |}** order. Each time you touch **▼** will display a letter in the reverse order, such as **Z Y X ... C B A** order.



6 Touch ► to move the cursor to the next character position.

When the desired letter is displayed, touch **►** to move the cursor to the next position and then select the next letter. Touch **◀** to move backwards in the display.

7 Touch OK to store the entered title in memory.

8 Touch ESC to return to the playback display.



Notes

- Titles remain in memory, even after the disc has been removed from the magazine, and are recalled when the disc is reinserted.

- After data for 100 discs has been stored in memory, data for a new disc will overwrite the oldest one.

Displaying disc titles

You can display the title of any disc that has had a disc title entered.

● Touch DISP.

Touch **DISP** repeatedly to switch between the following settings:

DISC LIST (disc list)—**DiscTitle** (disc title)

When you select **DiscTitle**, the title of the currently playing disc is shown in the display.

- If no title has been entered for the currently playing disc, **NO TITLE** is displayed.

Using CD TEXT functions

You can use these functions only with a CD TEXT compatible multi-CD player.

Some discs have certain information encoded on the disc during manufacture. These discs may contain such information as the CD title, track title, artist's name and playback time and are called CD TEXT discs. Only these specially encoded CD TEXT discs support the functions listed below.

Displaying titles on CD TEXT discs

● Touch DISP.

Touch **DISP** repeatedly to switch between the following settings:

DISC LIST (disc list)—**DiscTitle** (disc title)

—**DiscArtist** (disc artist name)—**TrackTitle**

(track title)—**T.Artist** (track artist name)

- If specific information has not been recorded on a CD TEXT disc, **NO XXXX** will be displayed (e.g., **NO ARTIST**).

Multi-CD Player

Scrolling titles in the display

This unit can display the first 19 letters only of **DiscTitle**, **DiscArtist**, **TrackTitle** and **T.Artist**. When the recorded information is longer than 19 letters, you can scroll the text to the left so that the rest of the title can be seen.

- **Keep touching DISP until the title begins to scroll to the left.**

The rest of the title will appear in the display.

Selecting tracks from the track title list

Track title list lets you see the list of track titles on a CD TEXT disc and select one of them to playback.

- 1 **Touch A.MENU and FUNCTION and then touch TRACK LIST.**

- 2 **Touch PREV or NEXT to switch between the lists of titles.**

- 3 **Touch your favorite track title.**

That selection will begin to play.

Using compression and bass emphasis

You can use these functions only with a multi-CD player that supports them.

Using COMP (compression) and DBE (dynamic bass emphasis) functions let you adjust the sound playback quality of the multi-CD player. Each of the functions have a two-step adjustment. The COMP function balances the output of louder and softer sounds at higher volumes. DBE boosts bass levels to give playback a fuller sound. Listen to each of the effects as you select through them and use the

one that best enhances the playback of the track or CD that you are listening to.

- 1 **Touch A.MENU and FUNCTION and then touch COMP.**

- If the multi-CD player does not support COMP/DBE, **NO COMP** is displayed when you attempt to select it.

- 2 **Touch ◀▶ to select your favorite setting.**

Touch ◀▶ repeatedly to switch between the following settings:

COMP OFF—COMP 1—COMP 2—

COMP OFF—DBE 1—DBE 2

- You can also select the desired setting by moving the joystick left or right.

Watching the TV tuner

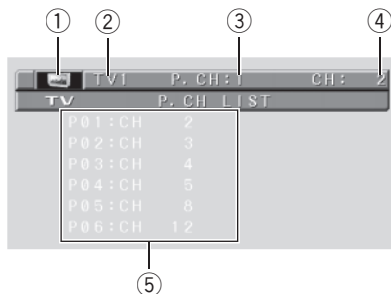

You can use this unit to control a TV tuner, which is sold separately.

For details concerning operation, refer to the TV tuner's operation manuals. This section provides information on TV operations with this unit which differs from that described in the TV tuner's operation manual.

① Source icon

Shows what the source has been selected.

② Band indicator

Shows which band the TV tuner is tuned to.

③ Preset number indicator

Shows what preset has been selected.

④ Channel indicator

Shows which channel the TV tuner is tuned.

⑤ Preset list display

Shows the preset list.

1 Touch the source icon and then touch TV to select the TV.

- When the source icon is not displayed, you can display it by touching the screen.

2 Touch the screen to display the touch panel keys.

3 Touch BAND to select a band.

Touch **BAND** repeatedly until the desired band is displayed, **TV1** or **TV2**.

4 To perform manual tuning, touch ◀ or ▶ shortly.

The channels move up or down step by step.

- You can also perform manual tuning by moving the joystick left or right.

5 To perform seek tuning, keep touching ◀ or ▶ for about one second and release.

The tuner will scan the channels until a broadcast strong enough for good reception is found.

- You can cancel seek tuning by touching either ◀ or ▶ shortly.
- If you keep touching ◀ or ▶ you can skip broadcasting channels. Seek tuning starts as soon as you release the keys.
- You can also perform seek tuning by holding the joystick left or right.



Note

If you do not use the touch panel keys for 30 seconds, they will be hidden automatically. [■]

TV tuner

Introduction of advanced TV tuner operation

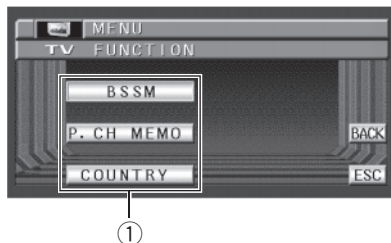

① Function display

Shows the function names.

● Touch **A.MENU** and then touch **FUNCTION** to display the function names.

The function names are displayed and operable ones are highlighted.

- When **A.MENU** is not displayed, you can display it by touching the screen.
- You can also display **MENU** by clicking the joystick.
- To return to the previous display, touch **BACK**.
- To return to the TV picture, touch **ESC**.

Note

If you do not operate the function within about 30 seconds, the display is automatically returned to the TV picture. 

Storing and recalling broadcast stations

If you touch any of the preset tuning keys **P01—P12** you can easily store up to 12 broadcast stations for later recall with the touch of a key.

● When you find a station that you want to store in memory keep touching a preset tuning key **P01—P12** until the preset number stops flashing.

The number you have touched will flash in the preset number indicator and then remain lit. The selected station has been stored in memory.

The next time you touch the same preset tuning key **P01—P12** the station is recalled from memory.

- To switch between **P01—P06** and **P07—P12**, touch **PREV** or **NEXT**.
- When the touch panel keys are not displayed, you can display them by touching the screen.
- When **P01—P06** and **P07—P12** are not displayed, you can display them by touching **DISP**.

Notes

- Up to 24 stations, 12 for each of two TV bands can be stored in memory.
- You can also use **▲** and **▼** to recall stations assigned to preset tuning keys **P01—P12**.
- You can also perform the same operations using **P. CH MEMO**. To display **P. CH MEMO**, touch **A.MENU** and then touch **FUNCTION**. 

Storing the strongest broadcast stations sequentially

1 Touch **A.MENU** and **FUNCTION** and then touch **BSSM**.

2 Touch **▲** to turn **BSSM** on.

BSSM begins to flash. While **BSSM** is flashing the 12 strongest broadcast stations will be stored in order from the lowest channel up. When finished, **BSSM** disappears.

- To cancel the storage process, touch **▼**.

**Note**

Storing broadcast stations with BSSM may replace broadcast stations you have saved using **P01—P12**. 

Selecting the country group

- This function can be operated only when connecting a TV tuner (e.g. GEX-P6450TVP) featuring the country setting.

1 Touch A.MENU and FUNCTION and then touch COUNTRY.

2 Touch ◀ or ▶ to select the country group.

Touch ◀ or ▶ until the desired country group appears in the display.

COUNTRY 1 (CCIR channel)—**COUNTRY 2** (IN channel)—**COUNTRY 3** (CHN channel)
—**COUNTRY 4** (U.K. channel)—**COUNTRY 5** (OIRT channel)—**COUNTRY 6** (AUSTRALIA channel) 

DVD Player

Playing a disc

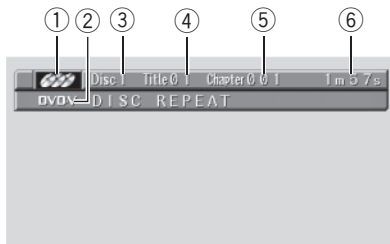

You can use this unit to control a DVD player or multi-DVD player, which is sold separately.

For details concerning operation, refer to the DVD player's or multi-DVD player's operation manuals. This section provides information on DVD operations with this unit which differs from that described in the DVD player's or multi-DVD player's operation manual.

- Switch the remote control selection to suitable setting to operate DVD players. (Refer to page 73.)
- Switch the remote control operation mode to **DVD** to operate the DVD player by using remote control. (Refer to page 14.)

① Source icon

Shows what the source has been selected.

② Disc type indicator

Shows the type of the currently playing disc.

③ Disc number indicator

Shows the disc currently playing when using a multi-DVD player.

④ Title number indicator

Shows the title currently playing during DVD video playback.

⑤ Chapter/track number indicator

Shows the chapter/track currently playing.

⑥ Play time indicator

Shows the elapsed playing time of the current chapter/track.

1 Touch the source icon and then touch S-DVD to select the DVD player.

- When the source icon is not displayed, you can display it by touching the screen.

2 Touch the screen to display the touch panel keys.

3 To skip back or forward to another chapter/track, touch ◀ or ▶ shortly.

- You can also skip back or forward to another chapter/track by moving the joystick left or right. When using the joystick on the remote control, switch the remote control operation mode to **AVH**. (Refer to page 14.)

4 To perform fast forward or reverse, keep touching ◀ or ▶ for about one second and release.

- You can also perform fast reverse/fast forward by holding the joystick left or right. When using the joystick on the remote control, switch the remote control operation mode to **AVH**. (Refer to page 14.)



Note

If you do not use the touch panel keys for 30 seconds, they will be hidden automatically. □

Turning the DVD player on or off

- Only the remote control can operate this function. To perform this function, switch the remote control operation mode to **DVD**. (Refer to page 14.)

- Press **REAR.S** to turn the DVD player on.

- To turn the DVD player off, press **REAR.S** again. 

Selecting a disc

- Only when a multi-DVD player is connected to this unit, you can operate this function.

- **Touch ▲ or ▼ to select a disc.**

- You can also skip back or forward to another disc by moving the joystick up or down.

When using the joystick on the remote control, switch the remote control operation mode to **AVH**. (Refer to page 14.)

- You can also select a disc by pressing **BACK** or **ENTERTAINMENT** on the remote control when the remote control operation mode is switched to **DVD**. 

Introduction of advanced DVD player operation

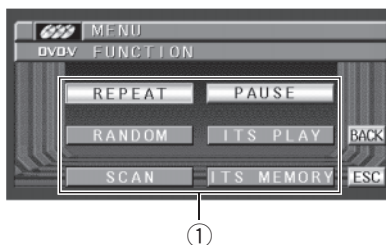

- ① **Function display**

Shows the function names.

- **Touch A.MENU and then touch FUNCTION to display the function names.**

The function names are displayed and operable ones are highlighted.

- When **A.MENU** is not displayed, you can display it by touching the screen.
 - You can also display **MENU** by clicking the joystick.
 - To return to the previous display, touch **BACK**.
 - To return to the playback display, touch **ESC**.



Note

If you do not operate the function within about 30 seconds, the display is automatically returned to the playback display. 

Repeating play

- During PBC playback of Video CDs, this function cannot be operated.

- 1 **Touch A.MENU and FUNCTION and then touch REPEAT.**

DVD Player

2 Touch ◀ or ▶ to select the repeat range.

During DVD video playback

- **TITLE** – Repeat just the current title
- **CHAPTER** – Repeat just the current chapter
- **DISC** – Repeat the current disc

During Video CD or CD playback

- **TRACK** – Repeat just the current track
- **DISC** – Repeat the current disc



Notes

- If you select other discs during repeat play, the repeat play range changes to **DISC**.
- If you perform track search or fast forward/reverse during **TRACK**, the repeat play range changes to **DISC**.

Pausing disc playback

1 Touch A.MENU and FUNCTION and then touch PAUSE.

2 Touch ▲ to turn pause on.

- To turn pause off, touch ▼.

Playing tracks in a random order

- You can operate this function only during CD playback.

1 Touch A.MENU and FUNCTION and then touch RANDOM.

2 Touch ▲ to turn random play on.

Tracks will play in a random order.

- To turn random play off, touch ▼.

Scanning tracks of a CD

- You can operate this function only during CD playback.

1 Touch A.MENU and FUNCTION and then touch SCAN.

2 Touch ▲ to turn scan play on.

The first 10 seconds of each track is played.

3 When you find the desired track touch ▼ to turn scan play off.

Using ITS playlists

- Only when a multi-DVD player is connected to this unit, you can operate these functions.
- This function differs slightly from ITS playback with a multi-CD player. With multi-DVD player, ITS playback applies only to the CD playing. For details, refer to *Using ITS playlists* on page 46.

Introduction of audio adjustments



① Audio display

Shows the audio function names.



Important

If the multi-channel processor (DEQ-P7050) is connected to this unit, the audio function will be changed into the multi-channel processor's audio menu. For details, refer to *Introduction of DSP adjustments* on page 62.

● Touch A.MENU and then touch AUDIO to display the audio function names.

The audio function names are displayed and operable ones are highlighted.

- When **A.MENU** is not displayed, you can display it by touching the screen.
- You can also display **MENU** by clicking the joystick.
- To go to the next group of function names, touch **NEXT**.
- To return to the previous group of function names, touch **PREV**.
- If EQ-EX function has been selected and only when EQ-EX is turned on and **CUSTOM** is selected as the equalizer curve, you can switch to **BASS** and **TREBLE**.
 - Only when the subwoofer controller setting is **PREOUT FULL, NON FADING** will be displayed instead of **SUB WOOFER**. (Refer to *Setting the rear output and subwoofer controller* on page 75.)

- When selecting the FM tuner as the source, you cannot switch to **SLA**.
- To return to the previous display, touch **BACK**.
- To return to the display of each source, touch **ESC**.



Note

If you do not operate the audio function within about 30 seconds, the display is automatically returned to the source display. 

Using balance adjustment

You can select a fader/balance setting that provides an ideal listening environment in all occupied seats.

1 Touch A.MENU and AUDIO and then touch FAD/BAL.

- When the rear output setting is **REAR SP SUB. W, BALANCE** will be displayed instead of **FAD/BAL**. Refer to *Setting the rear output and subwoofer controller* on page 75.

2 Touch ▲ or ▼ to adjust front/rear speaker balance.

Each time you touch ▲ or ▼ moves the front/rear speaker balance towards the front or the rear.

- **FRONT:15 – REAR:15** is displayed as the front/rear speaker balance moves from front to rear.
- **FR:00** is the proper setting when only two speakers are used.
- When the rear output setting is **REAR SP SUB. W**, you cannot adjust front/rear speaker balance. Refer to *Setting the rear output and subwoofer controller* on page 75.

Audio Adjustments

3 Touch ◀ or ▶ to adjust left/right speaker balance.

Each time you touch ◀ or ▶ moves the left/right speaker balance towards the left or the right.

LEFT:09 – RIGHT:09 is displayed as the left/right speaker balance moves from left to right. □

Using the equalizer

The equalizer lets you adjust the equalization to match car interior acoustic characteristics as desired.

Recalling equalizer curves

There are six stored equalizer curves which you can easily recall at any time. Here is a list of the equalizer curves:

Display	Equalizer curve
SUPER BASS	Super bass
POWERFUL	Powerful
NATURAL	Natural
VOCAL	Vocal
CUSTOM	Custom
FLAT	Flat

- **CUSTOM** is an adjusted equalizer curve that you create.
- A separate **CUSTOM** curve can be created for each source. If you make adjustments, the equalizer curve settings will be memorized in **CUSTOM**.
- When **FLAT** is selected no supplement or correction is made to the sound. This is useful to check the effect of the equalizer curves by switching alternatively between **FLAT** and a set equalizer curve.

● Press EQ to select the equalizer.

Press **EQ** repeatedly to switch between the following equalizers:

SUPER BASS—POWERFUL—NATURAL—VOCAL—CUSTOM—FLAT

Adjusting equalizer curves

You can adjust the currently selected equalizer curve setting as desired. Adjusted equalizer curve settings are memorized in **CUSTOM**.

- You can adjust the center frequency and the Q factor (curve characteristics) of each currently selected curve band (**LOW/MID/HIGH**).

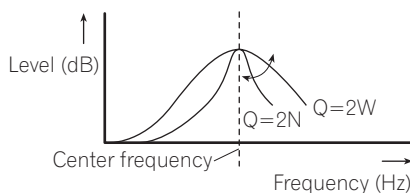

1 Touch A.MENU and AUDIO and then touch EQ MENU.

2 Touch ▲ or ▼ to select the desired item.

Each time you touch ▲ or ▼ selects the item in the following order:

BAND (bands)—**LEVEL** (equalizer level)
—**FREQUENCY** (center frequency)
—**Q. FACTOR** (Q factor)

3 Touch ◀ or ▶ to select the equalizer band to adjust.

Each time you touch ◀ or ▶ selects equalizer bands in the following order:

LOW (low)—**MID** (mid)—**HIGH** (high)

4 Touch ▼ and then touch ◀ or ▶ to adjust the level of the equalizer band.

Each time you touch ◀ or ▶ increases or decreases the level of the equalization band.

Audio Adjustments

+6 – –6 is displayed as the level is increased or decreased.

5 Touch ▼ and then touch ◀ or ▶ to select the desired frequency.

Touch ◀ or ▶ until the desired frequency appears in the display.

Low: **40—80—100—160** (Hz)

Mid: **200—500—1k—2k** (Hz)

High: **3.15k—8k—10k—12.5k** (Hz)

6 Touch ▼ and then touch ◀ or ▶ to select the desired Q factor.

Touch ◀ or ▶ until the desired Q factor appears in the display.

2W—1W—1N—2N



Note

If you make adjustments, **CUSTOM** curve is updated. 

Adjusting bass and treble

You can adjust bass and treble settings.

- If EQ-EX function has been selected and only when EQ-EX is turned on and **CUSTOM** is selected as the equalizer curve, you can adjust bass and treble settings. (Refer to *Compensating for equalizer curves (EQ-EX)* on page 60.)

Adjusting bass

You can adjust the cut-off frequency and the bass level.

- If SFEQ has been set to **FRONT1**, bass adjustment affects only the rear output: front output cannot be adjusted. (Refer to *Setting the sound focus equalizer (SFEQ)* on page 61.)

1 Touch A.MENU and AUDIO and then touch BASS.

2 Touch ◀ or ▶ to select the desired frequency.

Touch ◀ or ▶ until the desired frequency appears in the display.

40—63—100—160 (Hz)

3 Touch ▲ or ▼ to adjust the bass level.

Each time you touch ▲ or ▼ increases or decreases the bass level. **+6 – –6** is displayed as the level is increased or decreased.

Adjusting treble

You can adjust the cut-off frequency and the treble level.

- If SFEQ has been set to **FRONT1** or **FRONT2**, treble adjustment affects only the front output: rear output cannot be adjusted. (Refer to *Setting the sound focus equalizer (SFEQ)* on page 61.)

1 Touch A.MENU and AUDIO and then touch TREBLE.

2 Touch ◀ or ▶ to select the desired frequency.

Touch ◀ or ▶ until the desired frequency appears in the display.

2.5k—4k—6.3k—10k (Hz)

3 Touch ▲ or ▼ to adjust the treble level.

Each time you touch ▲ or ▼ increases or decreases the treble level. **+6 – –6** is displayed as the level is increased or decreased. 

Adjusting loudness

Loudness compensates for deficiencies in the low- and high-sound ranges at low volume.

Audio Adjustments

1 Touch A.MENU and AUDIO and then touch LOUDNESS.

2 Touch ▲ to turn loudness on.

- To turn loudness off, touch ▼.

3 Touch ◀ or ▶ to select a desired level.

Each time you touch ◀ or ▶ selects level in the following order:

LOW (low)—**MID** (mid)—**HIGH** (high) □

Using subwoofer output

This unit is equipped with a subwoofer output which can be turned on or off.

- When the subwoofer output is on, you can adjust the cut-off frequency and the output level of the subwoofer.

1 Touch A.MENU and AUDIO and then touch SUB WOOFER.

- When the subwoofer controller setting is **PREOUT FULL**, you cannot select **SUB WOOFER**.

2 Touch ▶ to turn subwoofer output on.

- To turn subwoofer output off, touch ◀.

3 Touch ▼ and then touch ◀ or ▶ to select the phase of subwoofer output.

Touch ▶ to select normal phase and **NORMAL** appears in the display. Touch ◀ to select reverse phase and **REVERSE** appears in the display.

4 Touch ▼ and then touch ◀ or ▶ to adjust the output level of the subwoofer.

Each time you touch ◀ or ▶ increases or decreases the level of the subwoofer. **+6** – **-6** is displayed as the level is increased or decreased.

5 Touch ▼ and then touch ◀ or ▶ to select cut-off frequency.

Each time you touch ◀ or ▶ selects cut-off frequencies in the following order:

50—80—125 (Hz)

Only frequencies lower than those in the selected range are output from the subwoofer. □

Using non fading output

When the non fading output setting is on, the audio signal does not pass through this unit's low pass filter (for the subwoofer), but is output through the RCA output.

1 Touch A.MENU and AUDIO and then touch NON FADING.

- When the subwoofer controller setting is only **PREOUT FULL**, you can select **NON FADING**. (Refer to page 75.)

2 Touch ▲ to turn non fading output on.

- To turn non fading output off, touch ▼.

3 Touch ◀ or ▶ to adjust the output level of the non fading.

Each time you touch ◀ or ▶ increases or decreases the level of the non fading. **+6** – **-6** is displayed as the level is increased or decreased. □

Using the high pass filter

When you do not want low sounds from the subwoofer output frequency range to play from the front or rear speakers, turn the HPF (high pass filter) on. Only frequencies higher than those in the selected range are output from the front or rear speakers.

Audio Adjustments

1 Touch A.MENU and AUDIO and then touch NEXT.

2 Touch HPF.

3 Touch ▲ to turn high pass filter on.

- To turn high pass filter off, touch ▼.

4 Touch ◀ or ▶ to select cut-off frequency.

Each time you touch ◀ or ▶ selects cut-off frequencies in the following order:

50—80—125 (Hz)



Note

If you switch the SFEQ setting, the HPF function is automatically turned off. By turning the HPF function on after selecting the SFEQ setting, you can combine HPF function with SFEQ function. 

Adjusting source levels

SLA (source level adjustment) lets you adjust the volume level of each source to prevent radical changes in volume when switching between sources.

- Settings are based on the FM tuner volume level, which remains unchanged.

1 Compare the FM tuner volume level with the level of the source you wish to adjust.

2 Touch A.MENU and AUDIO and then touch NEXT.

3 Touch SLA.

4 Touch ▲ or ▼ to adjust the source volume.

Each time you touch ▲ or ▼ increases or decreases the source volume.

+4 --4 is displayed as the source volume is increased or decreased.



Notes

- The AM tuner volume level can also be adjusted with source level adjustments.
- Video CD, CD and MP3 are set to the same source level adjustment volume automatically.
- DVD and the optional DVD player are set to the same source level adjustment volume automatically.
- External unit 1 and external unit 2 are set to the same source level adjustment volume automatically.
- AUX (auxiliary input) and AV (video input) are set to the same source level adjustment volume automatically. 

Compensating for equalizer curves (EQ-EX)

The EQ-EX compensates for each equalizer curve. Furthermore, you can adjust bass and treble for each source when **CUSTOM** curve is selected.

- You cannot use EQ-EX function and SFEQ function simultaneously.

1 Touch A.MENU and AUDIO and then touch NEXT.

2 Touch SFEQ/EQ-EX and then touch EQ-EX.

3 Touch ▲ to turn EQ-EX on.

- To turn EQ-EX off, touch ▼. 

Audio Adjustments

Setting the sound focus equalizer (SFEQ)

Clarifying the sound image of vocals and instruments allows the simple staging of a natural, pleasant sound environment. Even greater listening enjoyment will be obtained if seating positions are chosen carefully.

FRONT1 boosts the treble on the front output and the bass on the rear output. **FRONT2** boosts the treble and the bass on the front output and the bass on the rear output. (The bass boost is the same for both front and rear.) For both **FRONT1** and **FRONT2**, **H** setting provides a more pronounced effect than **L** setting.

- You cannot use EQ-EX function and SFEQ function simultaneously.

1 Touch A.MENU and AUDIO and then touch NEXT.

2 Touch SFEQ/EQ-EX and then touch SFEQ.

3 Touch ▲ or ▼ to select the desired SFEQ setting.

Touch ▲ or ▼ repeatedly to switch between the following settings:

SFEQ OFF (off)—**FRONT1-H** (front 1-high)
—**FRONT1-L** (front 1-low)—**FRONT2-H** (front 2-high)—**FRONT2-L** (front 2-low)—**CUSTOM** (custom)

4 Touch ◀ or ▶ to select the desired position.

Touch ◀ or ▶ until the desired position appears in the display.

LEFT (left)—**CENTER** (center)—**RIGHT** (right)



Notes

- If you adjust the bass or treble, **CUSTOM** memorizes an SFEQ setting in which the bass and treble are adjusted for personal preference.

- If you switch the SFEQ setting, the HPF function is automatically turned off. By turning the HPF function on after selecting the SFEQ setting, you can combine HPF function with SFEQ function. ◻

Introduction of DSP adjustments

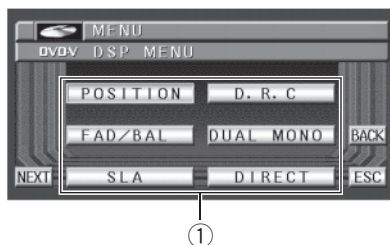

You can use this unit to control multi-channel processor (DEQ-P7050), which is sold separately.

By carrying out the following settings/adjustments in order, you can create a finely-tuned sound field effortlessly.

- 1 Setting the speaker setting
- 2 Using the position selector
- 3 Adjusting the time alignment
- 4 Adjusting the speaker output levels using a test tone
- 5 Selecting a cut-off frequency
- 6 Adjusting the speaker output levels
- 7 Adjusting 3-band parametric equalizer

① DSP display

Shows the DSP function names.

● Touch **A.MENU** and then touch **AUDIO** to display the DSP function names.

The DSP function names are displayed and operable ones are highlighted.

- When **A.MENU** is not displayed, you can display it by touching the screen.
- You can also display **MENU** by clicking the joystick.
- To go to the next group of function names, touch **NEXT**.
- To return to the previous group of function names, touch **PREV**.

- When selecting the FM tuner as the source, you cannot switch to **SLA**.
- When playing other than the DVD disc, you cannot switch to **D. R. C** or **DUAL MONO**.
- When neither **FRONT-L** nor **FRONT-R** is selected in **POSITION**, you cannot switch to **TIME ALIGN**.
- When neither **CUSTOM1** nor **CUSTOM2** is selected as an equalizer curve, you cannot switch to **PEQ**.
- To return to the previous display, touch **BACK**.
- To return to the display of each source, touch **ESC**.



Note

If you do not operate the DSP function within about 30 seconds, the display is automatically returned to the source display. 

Using the sound field control

The SFC function creates the sensation of a live performance.

- The acoustics of different performance environments are not the same and depend on the extent and contour of space through which sound waves move and on how sounds bounce off the stage, walls, floors and ceilings. At a live performance you hear music in three stages: direct sound, early reflections, and late reflections, or reverberations. Those factors are programmed into the SFC circuitry to recreate the acoustics of various performance settings.

1 Press **EQ** and hold to switch to **SFC** function.

Press **EQ** and hold until **SFC** appears in the display.

- To switch to equalizer function, press **EQ** and hold again.

Digital Signal Processor

2 Press EQ to select the desired SFC mode.

Press **EQ** repeatedly to switch between the following mode:

MUSICAL (musical)—**DRAMA** (drama)
—**ACTION** (action)—**JAZZ** (jazz)—**HALL** (hall)
—**CLUB** (club)—**OFF** (off)

Note

If the source is a 2-channel LPCM audio or a 2-channel Dolby Digital audio and you select SFC effects that are most applicable for 5.1-channel audio (i.e., **MUSICAL**, **DRAMA** or **ACTION**), we recommend turning Dolby Pro Logic on. On the other hand, when selecting SFC effects that are intended for use with 2-channel audio (i.e., **JAZZ**, **HALL** or **CLUB**), we recommend turning Dolby Pro Logic off. 

Using the position selector

One way to assure a more natural sound is to accurately position the stereo image, putting you right in the center of the sound field. The position selector function lets you automatically adjust the speaker output levels and inserts a delay time to match the number and position of occupied seats. When used in conjunction with the SFC, the feature will make the sound image more natural and offer a panoramic sound that envelops you.

1 Touch A.MENU and AUDIO and then touch POSITION.

2 Touch ◀/▶/▲/▼ to select a listening position.

Touch one of these, ◀/▶/▲/▼, to select a listening position as listed in the table.

Key	Display	Position
◀	FRONT-L	Front seat left
▶	FRONT-R	Front seat right
▲	FRONT	Front seats
▼	ALL	All seats

- To cancel the selected listening position, touch the same key again.

Note

When you make adjustments for listening position, the speakers are automatically set for appropriate output levels. You can tailor them if you want as discussed under the heading of *Adjusting the speaker output levels using a test tone* or *Adjusting the speaker output levels*. 

Using balance adjustment

You can select a fader/balance setting that provides an ideal listening environment in all occupied seats.

1 Touch A.MENU and AUDIO and then touch FAD/BAL.

2 Touch ▲ or ▼ to adjust front/rear speaker balance.

Each time you touch ▲ or ▼ moves the front/rear speaker balance towards the front or the rear.

FRONT:25 – REAR:25 is displayed as the front/rear speaker balance moves from front to rear.

- **FR:00** is the proper setting when only two speakers are used.

3 Touch ◀ or ▶ to adjust left/right speaker balance.

Each time you touch ◀ or ▶ moves the left/right speaker balance towards the left or the right.

LEFT:25 – RIGHT:25 is displayed as the left/right speaker balance moves from left to right. 

Adjusting source levels

SLA (source level adjustment) lets you adjust the volume level of each source to prevent radical changes in volume when switching between sources.

- Settings are based on the FM tuner volume level, which remains unchanged.

1 Compare the FM tuner volume level with the level of the source you wish to adjust.

2 Touch A.MENU and AUDIO and then touch SLA.

3 Touch ▲ or ▼ to adjust the source volume.

Each time you touch ▲ or ▼ increases or decreases the source volume.

+4 – –4 is displayed as the source volume is increased or decreased.



Notes

- The AM tuner volume level can also be adjusted with source level adjustments.
- Video CD, CD and MP3 are set to the same source level adjustment volume automatically.
- DVD and the optional DVD player are set to the same source level adjustment volume automatically.
- External unit 1 and external unit 2 are set to the same source level adjustment volume automatically.
- AUX (auxiliary input) and AV (video input) are set to the same source level adjustment volume automatically. 

Using the dynamic range control

The dynamic range refers to the difference between the largest and softest sounds. The dynamic range control compresses this difference so that you can clearly hear sounds even at low volume levels.

- The dynamic range control is effective only on Dolby Digital sounds.

1 Touch A.MENU and AUDIO and then touch D. R. C.

- When playing other than the DVD disc, you cannot switch this mode.

2 Touch ▲ to turn the dynamic range control on.

- To turn dynamic range control off, touch ▼. 

Using the dual mono mode

When playing a disc recorded on a dual mono mode, you can select the channel to output.

- This function is effective only on dual mono mode sound.

1 Touch A.MENU and AUDIO and then touch DUAL MONO.

- When playing other than the DVD disc, you cannot switch this mode.

2 Touch ◀ or ▶ to select the desired output setting.

Touch ◀ or ▶ until the desired output setting appears in the display.

L + R (left and right channels)—**LEFT** (left channel)—**RIGHT** (right channel) 

Digital Signal Processor

Using the direct control

You can override audio settings to check for effectiveness of your audio settings.

- All audio functions are locked out during the direct control is on except **VOLUME**.

1 Touch A.MENU and AUDIO and then touch DIRECT.

2 Touch ▲ to turn the direct control on.

- To turn direct control off, touch ▼. □

Using the Dolby Pro Logic

Dolby Pro Logic gives enhanced spatial and directional effects, creating theater-like sense of presence and ambience.

- If the source is a 2-channel LPCM audio or a 2-channel Dolby Digital audio and you select SFC effects that are most applicable for 5.1-channel audio (i.e., **MUSICAL**, **DRAMA** or **ACTION**), we recommend turning Dolby Pro Logic on. On the other hand, when selecting SFC effects that are intended for use with 2-channel audio (i.e., **JAZZ**, **HALL** or **CLUB**), we recommend turning Dolby Pro Logic off.

1 Touch A.MENU and AUDIO and then touch NEXT.

2 Touch DOLBY PL.

3 Touch ▲ to turn the Dolby Pro Logic on.

- To turn Dolby Pro Logic off, touch ▼.

Note

When playing a 2-channel mono source with Pro Logic turned on, there may be occasions when the following will occur:

- No audio is output if the center speaker setting is **SMALL** or **LARGE** and no center speaker is installed.
- Audio is heard only over the center speaker if installed and the center speaker setting is **SMALL** or **LARGE**. □

Setting the speaker setting

You need to make with/without (or yes/no) and size (bass reproducing capacity) selection/adjustments depending on the installed speakers. The size needs to be set to **LARGE** (large) if the speaker is capable of reproducing sounds of about 100 Hz or below. Otherwise select **SMALL** (small).

- Low frequency range is not output if the subwoofer is set to **OFF** and the front and rear speakers set to **SMALL** or **OFF**.
- It is imperative that non-installed speakers be set to **OFF**.
- Set the front or rear speaker to **LARGE** if the speaker is capable of reproducing bass content, or if no subwoofer is installed.

1 Touch A.MENU and AUDIO and then touch NEXT.

2 Touch SP SET.

3 Touch ▲ or ▼ to select the speaker to be adjusted.

Each time you touch ▲ or ▼ selects the speaker in the following order:

FRONT (front speakers)—**CENTER** (center speaker)—**REAR** (rear speakers)—**SUB WOOFER** (subwoofer)—**PHASE** (subwoofer setting)

- You can switch to **PHASE** only when the subwoofer has been set to **ON**.

4 Touch ◀ or ▶ to select the correct size for the selected speaker.

Each time you touch ◀ or ▶ selects the size in the following order:

OFF (off)—**SMALL** (small)—**LARGE** (large)

- You cannot select **OFF**, when **FRONT** (front speakers) have been selected.

- You can select **ON** or **OFF**, when

SUB WOOFER (subwoofer) has been selected.

- You can switch **REVERSE** (reverse phase) or

NORMAL (normal phase), when **PHASE** (subwoofer setting) has been selected.

Correcting the subwoofer's phase

If trying to boost the bass output of the subwoofer doesn't do much or rather makes you feel that the bass gets more murky, this may indicate that the subwoofer's output and bass content you hear over other speakers cancel each other out. To remove this problem, try changing the phase setting for the subwoofer.

1 Touch **A.MENU** and **AUDIO** and then touch **NEXT**.

2 Touch **SP SET**.

3 Touch ▲ or ▼ to select **SUB WOOFER** (subwoofer).

Each time you touch ▲ or ▼ selects the speaker in the following order:

FRONT (front speakers)—**CENTER** (center speaker)—**REAR** (rear speakers)

—**SUB WOOFER** (subwoofer)—**PHASE** (subwoofer setting)

4 Touch ▶ to turn subwoofer output on.

- To turn subwoofer output off, touch ◀.

5 Touch ▼ and then touch ◀ or ▶ to select the phase of subwoofer output.

Touch ▶ to select normal phase and **NORMAL** appears in the display. Touch ◀ to

select reverse phase and **REVERSE** appears in the display.



Note

When playing a 2-channel mono source with Pro Logic turned on, there may be occasions when the following will occur:

- No audio is output if the center speaker setting is **SMALL** or **LARGE** and no center speaker is installed.
- Audio is heard only over the center speaker if installed and the center speaker setting is **SMALL** or **LARGE** 

Selecting a cut-off frequency

You can select a frequency, under which sounds are reproduced through the subwoofer. If the installed speakers include one whose size has been set to **SMALL**, you can select a frequency, under which sounds are reproduced through a **LARGE** speaker or subwoofer.

1 Touch **A.MENU** and **AUDIO** and then touch **NEXT**.

2 Touch **CUT OFF**.

3 Touch ◀ or ▶ to select cut-off frequency.

Each time you touch ◀ or ▶ selects cut-off frequencies in the following order:

63—80—100—125—160—200 (Hz)



Note

Selecting a cut-off frequency is to set a cut-off frequency of the subwoofer's L.P.F. (low-pass filter) and that of the **SMALL** speaker H.P.F. (high-pass filter). The cut-off frequency setting has no effect if the subwoofer is set to **OFF** and other speakers are set to **LARGE** or **OFF** 

Adjusting the speaker output levels

You can readjust the speaker output levels using a test tone while listening to music.

1 Touch A.MENU and AUDIO and then touch NEXT.

2 Touch SP LEVEL.

3 Touch ▲ or ▼ to select the speaker to be adjusted.

Each time you touch ▲ or ▼ selects the speaker in the following order:

FRONT L (front speaker left)—**CENTER** (center speaker)—**FRONT R** (front speaker right)—**REAR R** (rear speaker right)—**REAR L** (rear speaker left)—**SUB WOOFER** (subwoofer)

- You cannot select speakers whose size is set **OFF**.

4 Touch ◀ or ▶ to adjust the speaker output level.

Each time you touch ◀ or ▶ increases or decreases the speaker output level. **+10 – –10** is displayed as the level is increased or decreased.



Note

To adjust the speaker output levels at this mode is the same as making the speaker output levels at **TEST TONE**. Both provide the same results.

Adjusting the speaker output levels using a test tone

A convenient test tone allows you to easily get the overall balance right among the speakers.

1 Touch A.MENU and AUDIO and then touch NEXT.

2 Touch TEST TONE.

3 Touch START to start the test tone output.

The test tone is output. It rotates from speaker to speaker in the following sequence at intervals of about two seconds. The current settings for the speaker over which you hear the test tone are shown in the display.

FRONT L (front speaker left)—**CENTER** (center speaker)—**FRONT R** (front speaker right)—**REAR R** (rear speaker right)—**REAR L** (rear speaker left)—**SUB WOOFER** (subwoofer)

Check each speaker output level. If no adjustments are needed, perform step 5 to stop the test tone.

- You can also start the test tone output by moving the joystick up.
- The settings do not appear for speakers whose size is set **OFF**.

4 Touch ◀ or ▶ to adjust the speaker output level.

Each time you touch ◀ or ▶ increases or decreases the speaker output level. **+10 – –10** is displayed as the level is increased or decreased.

- The test tone rotates to the next speaker after about two seconds from the last operation.

5 Touch STOP to stop the test tone output.

- You can also stop the test tone output by moving the joystick down.



Notes

- If needed, select speakers and adjust their 'absolute' output levels. (Refer to *Adjusting the speaker output levels* on this page.)
- To adjust the speaker output levels at this mode is the same as making the speaker output levels at **SP LEVEL**. Both provide the same results.

Adjusting the time alignment

By adjusting the distance between each speaker and a selected listening position, you can insert delay times into the speaker output to obtain a correct sound image and overall level balance. Although this is automatically achieved when you set the listening position, the time alignment feature provides a fine adjustment.

1 Touch A.MENU and AUDIO and then touch NEXT.

2 Touch TIME ALIGN.

- You cannot select **TIME ALIGN** when neither **FRONT-L** nor **FRONT-R** is selected in **POSITION**.

3 Touch ▲ or ▼ to select the speaker to be adjusted.

Each time you touch ▲ or ▼ selects the speaker in the following order:

FRONT L (front speaker left)—**CENTER** (center speaker)—**FRONT R** (front speaker right)—**REAR R** (rear speaker right)—**REAR L** (rear speaker left)—**SUB WOOFER** (subwoofer)

- You cannot select speakers whose size is set **OFF**.

4 Touch ◀ or ▶ to adjust the distance between the selected speaker and the listening position.

Each time you touch ◀ or ▶ increases or decreases the distance. **0.0 – 500.0 [cm]** is displayed as the distance is increased or decreased. 

Using the equalizer

The equalizer lets you adjust the equalization to match car interior acoustic characteristics as desired.

Recalling equalizer curves

There are seven stored equalizer curves which you can easily recall at any time. Here is a list of the equalizer curves:

Display	Equalizer curve
SUPER BASS	Super bass
POWERFUL	Powerful
NATURAL	Natural
VOCAL	Vocal
FLAT	Flat
CUSTOM1	Custom 1
CUSTOM2	Custom 2

- CUSTOM1** and **CUSTOM2** are adjusted equalizer curves.
- When **FLAT** is selected no supplement or correction is made to the sound. This is useful to check the effect of the equalizer curves by switching alternatively between **FLAT** and a set equalizer curve.

1 Press EQ and hold to switch to equalizer function.

Press **EQ** and hold until an equalizer curve name appears in the display.

- To switch to SFC function, press **EQ** and hold again.

2 Press EQ to select the equalizer.

Press **EQ** repeatedly to switch between the following equalizers:

SUPER BASS—POWERFUL—NATURAL—VOCAL—FLAT—CUSTOM1—CUSTOM2

Adjusting 3-band parametric equalizer

For **CUSTOM1** and **CUSTOM2** equalizer curves, you can adjust the front, rear and center equalizer curves separately by selecting a

Digital Signal Processor

center frequency, an equalizer level and a Q factor for each band.

- A separate **CUSTOM1** curve can be created for each source.
- A **CUSTOM2** curve can be created common to all sources.
- The center speaker largely determines the sound image and getting the balance right isn't easy. We recommend reproducing a 2-ch. audio (a CD for example) and getting the balance right among the speakers except for the center, and then reproducing a 5.1-ch. audio (Dolby Digital or DTS) and adjusting the center speaker output to the balance you have already got among the other speakers.

1 Touch A.MENU and AUDIO and then touch NEXT twice.

2 Touch PEQ.

- You cannot select **PEQ** when neither **CUSTOM1** nor **CUSTOM2** equalizer curve is selected.

3 Touch ▲ or ▼ to select the desired item.

Each time you touch ▲ or ▼ selects the item in the following order:

SP-SEL (speakers)—**BAND** (bands)
—**FREQUENCY** (center frequency)—**LEVEL**
(equalizer level)—**Q. FACTOR** (Q factor)

4 Touch ◀ or ▶ to select the speaker to be adjusted.

Touch ◀ or ▶ until the desired speaker appears in the display.

REAR (rear speakers)—**CENTER** (center speaker)—**FRONT** (front speakers)

- You cannot select speakers whose size is set **OFF**.

5 Touch ▼ and then touch ◀ or ▶ to select the equalizer band to be adjusted.

Each time you touch ◀ or ▶ selects equalizer bands in the following order:

LOW (low)—**MID** (mid)—**HIGH** (high)

6 Touch ▼ and then touch ◀ or ▶ to select the center frequency of selected band.

Touch ◀ or ▶ until the desired frequency appears in the display.

**100—125—160—200—250—315—400—
500—630—800—1k—1.25k—1.6k—2k—
2.5k—3.15k—4k—5k—6.3k—8k** (Hz)

7 Touch ▼ and then touch ◀ or ▶ to adjust the equalizer level.

Each time you touch ◀ or ▶ increases or decreases the equalizer level. **+06** — **-06** is displayed as the level is increased or decreased.

8 Touch ▼ and then touch ◀ or ▶ to select the desired Q factor.

Each time you touch ◀ or ▶ switches between the following Q factor:

WIDE (wide)—**NARROW** (narrow)

- You can adjust parameters for each band of the other speakers in the same way.



Note

You can select a center frequency from among 20 frequencies for each band. You can change the center frequency in 1/3-octave steps, but you cannot select frequencies that have intervals shorter than 1 octave among the center frequencies of the three bands. □

Introduction of DVD setup adjustments

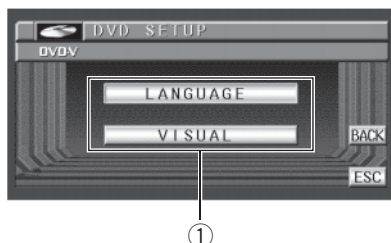

You can use this menu to change audio, subtitle, parental lock and other DVD settings.

- When watching a DVD/Video CD on the rear display independently, you cannot operate this menu.

① DVD setup menu display

Shows the DVD setup menu names.

1 Touch ■.

SETUP will be displayed instead of **MENU**.

2 Touch **SETUP** when the disc is stopped.

The DVD setup menu is displayed.

- When **SETUP** is not displayed, you can display it by touching the screen.
- You can also display **DVD SETUP** by pressing **MENU** on the remote control when the disc is stopped.

3 Touch either **LANGUAGE** or **VISUAL** to display the DVD setup function names.

The DVD setup function names in selected menu are displayed.

- To go to the next group of function names, touch **NEXT**.
- To return to the previous group of function names, touch **PREV**.
- To return to the previous display, touch **BACK**.
- To return to the playback display, touch **ESC**.

Note

If you do not operate the DVD setup function within about 30 seconds, the display is automatically returned to the playback display. 

Setting the subtitle language

You can set a desired subtitle language. If the selected subtitle language is recorded on the DVD, subtitles are displayed in that language.

1 Touch **SETUP** and **LANGUAGE** and then touch **SUB. T LANG**.

A subtitle language menu is displayed and the currently set language is highlighted.

- To switch to the second language select menu, touch **NEXT**.
- To return to the first language select menu, touch **PREV**.

2 Touch the desired language.

A subtitle language is set.

- If you have selected **OTHERS**, refer to *When you select OTHERS on the next page*.

Notes

- If the selected language is not recorded on the disc, the language specified on the disc is displayed.
- You can also switch the subtitle language by touching **SUB.T** during playback. (Refer to *Changing the subtitle language during playback (Multi-subtitle)* on page 30.)
- Even if you use **SUB.T** to switch the subtitle language, this does not affect the settings here.

Setting up the DVD player

When you select OTHERS

When you select **OTHERS**, a language code input display is shown. Refer to *Language code chart for DVD* on page 89 to input the four digit code of the desired language.

1 Touch 0—9 to input the language code.

- To cancel the input numbers, touch **C**.
- You can also input the desired number by using the joystick and **0-9**.

2 While the input number is displayed, touch ENTER.

Setting the audio language

You can set the preferred audio language.

1 Touch SETUP and LANGUAGE and then touch AUDIO LANG.

An audio language menu is displayed and the currently set language is highlighted.

- To switch to the second language select menu, touch **NEXT**.
- To return to the first language select menu, touch **PREV**.

2 Touch the desired language.

The audio language is set.

- If you have selected **OTHERS**, refer to *When you select OTHERS* on this page.



Notes

- If the selected language is not recorded on the disc, the language specified on the disc is output.
- You can also switch the audio language by touching **AUDIO** during playback. (Refer to *Changing audio language during playback (Multi-audio)* on page 30.)

- Even if you use **AUDIO** to switch the audio language, this does not affect the settings here. 

Setting the menu language

You can set the preferred language for displays of menus recorded on a disc.

1 Touch SETUP and LANGUAGE and then touch MENU LANG.

A menu language menu is displayed and the currently set language is highlighted.

- To switch to the second language select menu, touch **NEXT**.
- To return to the first language select menu, touch **PREV**.

2 Touch the desired language.

The menu language is set.

- If you have selected **OTHERS**, refer to *When you select OTHERS* on this page.



Note

If the selected language is not recorded on the disc, the language specified on the disc is displayed. 

Setting assist subtitles on or off

Assist subtitles offer explanations for the aurally impaired. However, they are only displayed if they are recorded on the DVD. You can turn assist subtitles on or off as desired.

1 Touch SETUP and LANGUAGE and then touch NEXT.

Setting up the DVD player

2 Touch A SUB TITL.

3 Touch ▲ to turn assist subtitles on.

- To turn assist subtitles off, touch ▼. 

Setting angle icon display

You can set up that the angle icon appears on scenes where the angle can be switched.

1 Touch SETUP and VISUAL and then touch M. ANGLE.

2 Touch ▲ to turn angle icon display on.

- To turn angle icon display off, touch ▼. 

Setting the aspect ratio

There are two kinds of display. A wide screen display has a width-to-height ratio (TV aspect) of 16:9, while a regular display has a TV aspect of 4:3. Be sure to select the correct TV aspect for the display connected to **REAR MONITOR OUT**.

- When using a regular display, select either **LETTER BOX** or **PANSCAN**. Selecting **16:9** may result in an unnatural picture.
- If you select the TV aspect, this unit's display changes to the same setting.

1 Touch SETUP and VISUAL and then touch TV ASPECT.



2 Touch any of the following touch panel keys to select the TV aspect.

- **16:9** – Wide screen picture (16:9) is displayed as it is (initial setting)
- **LETTER BOX** – The picture is the shape of a letter box with black bands at the top and bottom of the screen

- **PANSCAN** – The picture is cut short at the right and left of the screen



Notes

- When playing discs that do not specify **PANSCAN**, playback is with **LETTER BOX** even if you select the **PANSCAN** setting. Confirm whether the disc package bears the  mark. (See page 8.)
- Some discs do not enable changing of the TV aspect. For details, refer to the disc's instructions. 

Setting the parental lock

Some DVD video discs let you use parental lock to restrict the viewing of violent and adult oriented scenes by children. You can set the parental lock level in steps as desired.

- When you set a parental lock level and then play a disc featuring parental lock, code number input indications may be displayed. In this case, playback will begin when the correct code number is input.

Setting the code number and level

When you first use this function, register your code number. If you do not register a code number, parental lock will not operate.

1 Touch SETUP and VISUAL and then touch PARENTAL.

2 Touch 0—9 to input a four digit code number.

3 While the input number is displayed, touch ENTER.

The code number is set, and you can now set the level.

Setting up the DVD player

4 Touch any of 1—8 to select the desired level.

The parental lock level is set.

- **LEVEL 8** – Playback of the entire disc is possible (initial setting)
- **LEVEL 7–LEVEL 2** – Playback of discs for children and non-adult oriented discs is possible
- **LEVEL 1** – Playback of discs for children only is possible



Notes

- We recommend to keep a record of your code number in case you forget it.
- The parental lock level is recorded on the disc. You can confirm it by looking at the disc package, included literature or on the disc itself. With discs that do not feature a recorded parental lock level, you cannot use parental lock.
- With some discs, parental lock operates to skip certain scenes only, after which normal playback resumes. For details, refer to the disc's instructions.

Changing the level

You can change the set parental lock level.

1 Touch SETUP and VISUAL and then touch PARENTAL.

2 Touch 0—9 to input the registered code number.

3 Touch ENTER.

This enters the code number, and you can now change the level.

- If you input an incorrect code number, the icon  is displayed. Touch **C** and input the correct code number.
- If you forget your code number, refer to *If you forget your code number* on this page.

4 Touch any of 1—8 to select the desired level.

The new parental lock level is set.

If you forget your code number

Refer to *Changing the level* on this page, and touch **C** 10 times. The registered code number is canceled, letting you register a new one. 

Setting remote control code type

When the remote control operation switch is set to **DVD**, changing the remote control code type enables you to operate the Pioneer DVD player by the supplied remote control. There are three remote codes, code type **A**, code type **B** and code type **AVH**. When using this unit with a multi-DVD player (e.g. XDV-P9), select code **A**. When using this unit only, select code **AVH**.

- With this unit, code **B** cannot be used.

1 Set the remote control selection switch on the left side of the remote control to the appropriate position with a pen tip or other pointed instrument .

- If you select **AVH** mode, there is no need to take the following procedure.
- If you select **A/B** mode, take the following procedure and change the code type to the appropriate type.

2 Press 7 and 0 on the remote control simultaneously to change the code type.

Initially, the code type is set to **A**. Each time you press **7** and **0** simultaneously on the remote control the code type switches between **A** and **B**. 

Adjusting initial settings



Initial settings lets you perform initial set up of different settings for this unit.

① Function display

Shows the function names.

1 Touch the source icon and then touch **SOURCE OFF** to turn this unit off.

- When the source icon is not displayed, you can display it by touching the screen.

2 Touch **A.MENU** and then touch **INITIAL** to display the function names.

The function names are displayed and operable ones are highlighted.

- When **A.MENU** is not displayed, you can display it by touching the screen.
- You can also display **MENU** by clicking the joystick.
- To go to the next group of function names, touch **NEXT**.
- To return to the previous group of function names, touch **PREV**.
- When the multi-channel processor (e.g., DEQ-P7050) is connected to this unit, you can operate **DIGTL ATT** instead of **REAR SP**.
- To return to the previous display, touch **BACK**.
- To return to the display of each source, touch **ESC**.

Setting the FM tuning step

The FM tuning step employed by seek tuning can be switched between 100 kHz, the preset step, and 50 kHz.

1 Touch **A.MENU** and **INITIAL** and then touch **FM STEP**.

2 Touch ◀ or ▶ to select the FM tuning step.

Touching ◀ or ▶ will switch the FM tuning step between 100 kHz and 50 kHz. The selected FM tuning step will appear in the display.



Note

If seek tuning is performed in 50 kHz steps, stations may be tuned in imprecisely. Tune in the stations with manual tuning or use seek tuning again.

Setting the AM tuning step

The AM tuning step can be switched between 9 kHz, the preset step, and 10 kHz. When using the tuner in North, Central or South America, reset the tuning step from 9 kHz (531 – 1,602 kHz allowable) to 10 kHz (530 – 1,640 kHz allowable).

1 Touch **A.MENU** and **INITIAL** and then touch **AM STEP**.

2 Touch ◀ or ▶ to select the AM tuning step.

Touching ◀ or ▶ will switch the AM tuning step between 9 kHz and 10 kHz. The selected AM tuning step will appear in the display.

Initial Settings

Switching the warning tone

If the front panel is not detached from the head unit within five seconds of turning off the ignition, a warning tone will sound. You can turn off the warning tone.

1 Touch A.MENU and INITIAL and then touch DT. WARNING.

2 Touch ▲ to turn warning tone on.

- To turn warning tone off, touch ▼. 

Switching the auxiliary setting

It is possible to use auxiliary equipment with this unit. Activate the auxiliary setting when using auxiliary equipment connected to this unit.

1 Touch A.MENU and INITIAL and then touch AUX.

2 Touch ▲ to turn auxiliary setting on.

- To turn auxiliary setting off, touch ▼. 

Setting the rear output and subwoofer controller

This unit's rear output (rear speaker leads output and RCA rear output) can be used for full-range speaker (**REAR SP FULL**) or subwoofer (**REAR SP SUB. W**) connection. If you switch the rear output setting to the **REAR SP SUB. W**, you can connect a rear speaker lead directly to a subwoofer without using an auxiliary amp.

Initially, the unit is set for rear full-range speaker connection (**REAR SP FULL**). When rear output are connected to full range speakers (when **REAR SP FULL** is selected), you can

connect the RCA subwoofer output to a subwoofer. In this case, you can select whether to use the subwoofer controller's (low pass filter, phase) built-in **PREOUT SUB.W** or the auxiliary **PREOUT FULL**.

- When the multi-channel processor (e.g., DEQ-P7050) is connected to this unit, you cannot operate this function.

1 Touch A.MENU and INITIAL and then touch REAR SP.

2 Touch ▲ or ▼ to switch the rear output setting.

Touch ▲ to select full-range speaker and **REAR SP FULL** appears in the display. Touch ▼ to select subwoofer and **REAR SP SUB. W** appears in the display.

- When no subwoofer is connected to the rear output, select **REAR SP FULL**.
- When a subwoofer is connected to the rear output, set for subwoofer **REAR SP SUB. W**.
- When the rear output setting is **REAR SP SUB. W**, you cannot change the subwoofer controller.

3 Touch ◀ or ▶ to switch the subwoofer output or non fading output.

Touch ◀ to select subwoofer output and **PREOUT SUB.W** appears in the display. Touch ▶ to select non fading output and **PREOUT FULL** appears in the display.



Notes

- Even if you change this setting, there is no output unless you turn the non fading output (refer to *Using non fading output* on page 59) or subwoofer output (refer to *Using subwoofer output* on page 59) in the audio menu on.
- If you change the subwoofer controller, subwoofer output and non fading output in the audio menu return to the factory settings.

- Both rear speaker leads output and RCA rear output are switched simultaneously in this setting. 

Correcting distorted sound

You can minimize distortion likely caused by the equalizer curve settings.

Setting an equalizer level high can cause distortion. If high sound is crippled or distorted, try switching to **LOW**. Normally, leave the setting at **HIGH** to ensure quality sound.

- Only when the multi-channel processor (e.g., DEQ-P7050) is connected to this unit, you can operate this function.

1 Touch A.MENU and INITIAL and then touch DIGTL ATT.

2 Touch ◀ or ▶ to switch the digital attenuator setting.

Touch ◀ to select low setting and **LOW** appears in the display. Touch ▶ to select high setting and **HIGH** appears in the display. 

Switching the sound muting/attenuation

Sound from this system is muted or attenuated automatically when a call is made or received using a cellular telephone connected to this unit.

- The sound is turned off, **MUTE** or **ATT** is displayed and no audio adjustment is possible.
- Operation returns to normal when the phone connection is ended.

1 Touch A.MENU and INITIAL and then touch NEXT.

2 Touch TEL/GUIDE.

3 Touch ◀ or ▶ to select any of the muting, attenuation or mixing.

Touch ◀ or ▶ until the desired setting appears in the display.

- **MUTE** – Muting
- **ATT** – Attenuation
- **MIXING** – Mixing
- When the multi-channel processor (e.g., DEQ-P7050) is connected to this unit, you can select in the following setting:
 - **MUTE** – Muting
 - **ATT20** – Attenuation (**ATT20** has a stronger effect than **ATT10**)
 - **ATT10** – Attenuation
 - **MIXING** – Mixing 

Switching the automatic disc playback

You can turn automatic disc playback on or off when you insert a disc into the disc loading slot. When this function is on, the disc will be automatically played after it is inserted into the disc loading slot.

Initially, this function is set to on.

1 Touch A.MENU and INITIAL and then touch NEXT.

2 Touch DVD AUTO.

3 Touch ▲ to turn automatic disc playback on.

- To turn automatic disc playback off, touch ▼. 

Initial Settings

Switching the dimmer setting for sub-display

To prevent the sub-display from being too bright at night, the sub-display is automatically dimmed when the car's headlights are turned on. You can turn dimmer on or off.

1 Touch A.MENU and INITIAL and then touch NEXT.

2 Touch SUB. D DIM.

3 Touch ▲ to turn dimmer on.

- To turn dimmer off, touch ▼. □

Introduction of setup adjustments

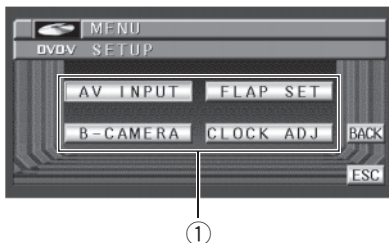

① Setup menu display

Shows the setup function names.

● Touch **A.MENU** and then touch **SETUP** to display the setup function names.

The setup function names are displayed and operable ones are highlighted.

- When **A.MENU** is not displayed, you can display it by touching the screen.
- You can also display **MENU** by clicking the joystick.
- To return to the previous display, touch **BACK**.
- To return to the display of each source, touch **ESC**.



Note

If you do not operate the setup function within about 30 seconds, the display is automatically returned to the source display. 

Setting the video input

You can switch the setting according to the connected component.

- Select **VIDEO** to watch video of a connected component as **AV** source.
- Select **M-DVD** to watch video of a connected DVD player as **S-DVD** source.

1 Touch **A.MENU** and **SETUP** and then touch **AV INPUT**.

2 Touch ◀ or ▶ to select the video input setting.

Touch ◀ or ▶ until the desired setting appears in the display.

- **OFF** – No video component is connected
- **VIDEO** – External video component
- **M-DVD** – DVD player connected with RCA cable
 - When a DVD player is connected with an AV-BUS cable, do not select **M-DVD** or else no picture is displayed even if you select **S-DVD**. 

Setting for back-up camera

This unit features a function that automatically switches to the back-up camera video (**BACK UP CAMERA IN** jack) when a back-up camera is installed on your car. When the gear shift is in **REVERSE (R)** position, the video automatically switches to a back-up camera video. (For more details, consult with your dealer.)

- We recommend that you use a camera which outputs mirror reversed images.
- Confirm the setting immediately whether the display changes to a back-up camera video when the gear shift is moved to **REVERSE (R)** from another position.
- When the display changes to a back-up camera video during normal drivings, switch to another setting.
- To return to the source display, press **MENU** on the head unit.

1 Touch **A.MENU** and **SETUP** and then touch **B-CAMERA**.

2 Touch ▲ to turn back-up camera setting on.

- To turn back-up camera setting off, touch ▼.

Other Functions

3 Touch ◀ or ▶ to select an appropriate setting for polarity.

Each time you touch ◀ or ▶ switches between the following polarity:

- **BATTERY** – When the polarity of the connected lead is positive while the gear shift is **REVERSE (R)** position
- **GND** – When the polarity of the connected lead is negative while the gear shift is **REVERSE (R)** position

Setting the automatic open function

To prevent the display from hitting the shift lever of an automatic vehicle when it is in **P** (park) position, or when you do not wish the display to open/close automatically, you can set the automatic open function in the manual mode.

Furthermore, to adjust the LCD panel slide position, you can turn the set back on or off.

1 Touch A.MENU and SETUP and then touch FLAP SET.

2 Touch ▲ to turn the set back on, and the LCD panel slides to the back.

- To turn the set back off, touch ▼ and the LCD panel slides to the front.

3 Touch ◀ or ▶ to select the display to open/close automatically or manually.

Touch ◀ to select **MANUAL**, and you have to press **OPEN/CLOSE** to open/close the display. Touch ▶ to select **AUTO**, and the display automatically opens/closes when power to this unit is turned on.

Setting the clock

Use these instructions to set the clock.

1 Touch A.MENU and SETUP and then touch CLOCK ADJ.

2 Touch OFF to turn the clock display on. ON will appear in the display instead of OFF. Clock display is now on.

- You can also turn the clock display on or off by pressing **FLIP DOWN/CLOCK** when the LCD panel is closed.
- To turn the clock display off, touch **ON**.

3 Touch ◀ or ▶ to select the segment of the clock display you wish to set.

Each time you touch ◀ or ▶ will select one segment of the clock display:

Hour—Minute

As you select segments of the clock display the segment selected will be highlighted.



4 Touch ▲ or ▼ to set the clock.

Each time you touch ▲ will increase the selected hour or minute. Each time you touch ▼ will decrease the selected hour or minute.



Notes

- You can match the clock to a time signal by touching **JUST**.
 - If the minute is **00—29**, the minutes are rounded down. (e.g., **10:18** becomes **10:00**.)
 - If the minute is **30—59**, the minutes are rounded up. (e.g., **10:36** becomes **11:00**.)
- Even when the sources are off, the clock display appears on the display.

Using the AUX source

An IP-BUS-RCA Interconnector such as the CD-RB20/CD-RB10 (sold separately) lets you connect this unit to auxiliary equipment featuring RCA output. For more details, refer to the IP-BUS-RCA Interconnector owner's manual.

Selecting AUX as the source

- **Touch the source icon and then touch AUX to select AUX as the source.**
 - When the source icon is not displayed, you can display it by touching the screen.
 - If the auxiliary setting is not turned on, **AUX** cannot be selected. For more details, see *Switching the auxiliary setting* on page 75.

Setting the AUX title

The title displayed for the **AUX** source can be changed.

- 1 After you have selected AUX as the source, touch A.MENU and FUNCTION and then touch NAME EDIT.**
- 2 Touch ABC to select the desired character type.**
Touch **ABC** repeatedly to switch between the following character type:
Alphabet (upper case), numbers and symbols—Alphabet (lower case)
 - You can select to input numbers and symbols by touching **123**.
- 3 Touch ▲ or ▼ to select a letter of the alphabet.**
Each time you touch ▲ will display a letter of the alphabet in **A B C ... X Y Z**, numbers and symbols in **1 2 3 ... } }** order. Each time you touch ▼ will display a letter in the reverse order, such as **Z Y X ... C B A** order.



4 Touch ► to move the cursor to the next character position.

When the desired letter is displayed, touch ► to move the cursor to the next position and then select the next letter. Touch ◀ to move backwards in the display.

5 Touch OK to store the entered title in memory.

6 Touch ESC to return to the playback display. □

Switching the background display

You can switch background displays while listening to each source.

● Press ENTERTAINMENT.

Each time you press **ENTERTAINMENT** the display changes in the following order:

Audio source

Background still picture—**BGV** (background visual)—**AV** (video input)—**DVD** (DVD player)

Video source

Video of currently selected source—Background still picture—**BGV** (background visual)—**AV** (video input)—**DVD** (DVD player)



Notes

- In the following cases, the background display will not change:

Other Functions

- When the AV (video input) is not set to **VIDEO** (refer to page 78).
- When the DVD/Vide CD playback is not turned on for rear display (refer to page 17).
- Dolphin movie will not appear when the touch panel keys or the list is displayed. 

Using the PGM button

You can operate the preprogrammed functions for each source by using **PGM**.

● Press PGM to turn pause on when selecting the following sources:

- **DVD** – Built-in DVD player
- **S-DVD** – DVD player/multi-DVD player
- **M-CD** – Multi-CD player
- To turn pause off, press **PGM** again.

● Press PGM and hold to turn BSM on when selecting TUNER as the source.

Press **PGM** and hold until the BSM turns on.

- To cancel the storage process, press **PGM** again.

● Press PGM and hold to turn BSSM on when selecting TV as the source.



Press **PGM** and hold until the BSSM turns on.

- To cancel the storage process, press **PGM** again. 

Additional Information

Troubleshooting

Common

Symptom	Cause	Action (See)
Power doesn't turn on. The unit doesn't operate.	Leads and connectors are incorrectly connected.	Confirm once more that all connections are correct.
	The fuse is blown.	Rectify the reason for the fuse blowing, then replace the fuse. Be very sure to install the correct fuse with the same rate.
	Noise and other factors are causing the built-in microprocessor to operate incorrectly.	Press RESET . (Page 8)
Operation with the remote control isn't possible. The unit does not operate correctly even when the appropriate remote control buttons are pressed.	The remote control operation mode is incorrect.	Switch to the correct remote control mode. (Page 14)
	The remote control code is incorrect.	Make sure the remote control selection switch setting and code type setting are the same. (Page 73)
	Battery power is low.	Load new battery. (Page 9)
	Some operations are prohibited with certain discs.	Check using another disc.
Playback is not possible.	The disc is dirty.	Clean disc. (Page 85)
	The loaded disc is a type this unit cannot play.	Check what type the disc is.
	Non compatible video system disc is loaded.	Change to a disc compatible to your video system.
No sounds are heard. The volume level will not rise.	Cables are not connected correctly.	Connect the cables correctly.
	The unit is performing still, slow motion or frame-by-frame playback.	There is no sound during still, slow motion or frame-by-frame playback.
There's no picture.	The parking brake cord is not connected.	Connect a parking brake cord, and apply the parking brake.
	The parking brake is not applied.	Connect a parking brake cord, and apply the parking brake.
The icon  is displayed, and operation is not possible.	The operation is prohibited for the disc.	This operation is not possible.
	The operation is not compatible with the disc's organization.	This operation is not possible.
The picture stops (pauses) and the unit cannot be operated.	Reading of data has become impossible during playback.	After pressing  once, start playback once more.
There's no sound. Volume level is low.	The volume level is low.	Adjust the volume level.
	The attenuator is on.	Turn the attenuator off.
There's audio and video skipping.	This unit is not firmly secured.	Secure this unit firmly.
The picture is stretched, the aspect is incorrect.	The aspect setting is incorrect for the display.	Select the appropriate setting for your display. (Page 72)

Additional Information

Symptom	Cause	Action (See)
Rear display picture disappears.	The source disc being listened to with the head unit has been ejected.	Before ejecting the disc, switch the source. This problem may occur when certain connection methods are used.
When the ignition switch is turned ON (or turned to ACC), the motor sounds.	This unit confirms whether a disc is loaded or not.	This is a normal operation.
Nothing is displayed. The touch panel keys cannot use.	The back-up camera is not connected. B-CAMERA is incorrect setting.	Connect a back-up camera. Press MENU on the head unit to return to the source display and then select the correct setting for B-CAMERA . (Page 78)

Problems during DVD playback

Symptom	Cause	Action (See)
Playback is not possible.	The loaded disc has a different region number from this unit.	Replace the disc with one featuring the same region number as this unit. (Page 6, Page 91)
A parental lock message is displayed and playback is not possible.	Parental lock is on.	Turn parental lock off or change the level. (Page 72)
Parental lock cannot be canceled.	The code number is incorrect. You have forgotten your code number.	Input the correct code number. (Page 72) Press CLEAR 10 times to cancel the code number. (Page 73)
Dialog language (and subtitle language) cannot be switched.	The DVD playing does not feature multiple language recordings. You can only switch between items indicated in the disc menu.	You cannot switch among multiple languages if they aren't recorded on the disc. Switch using the disc menu.
No subtitles are displayed.	The DVD playing does not feature subtitles. You can only switch between items indicated in the disc menu.	Subtitles are not displayed if they are not recorded on the disc. Switch using the disc menu.
Playback is not with the audio language and subtitle language settings selected in DVD SETUP .	The DVD playing does not feature dialog or subtitles in the language selected in DVD SETUP .	Switching to a selected language is not possible if the language selected in DVD SETUP is not recorded on the disc.
Switching the viewing angle is not possible.	The DVD playing does not feature scenes shot from multiple angles. You are trying to switch to multiple angle viewing of a scene that is not recorded from multiple angles.	You cannot switch between multiple angles if the DVD does not feature scenes recorded from multiple angles. Switch between multiple angles when watching scenes recorded from multiple angles.
The picture is extremely unclear/distorted and dark during playback.	The disc features a signal to prohibit copying. (Some discs may have this.)	Since this unit is compatible with the copy guard analog copy protect system, when playing a disc that has a signal prohibiting copying, the picture may suffer from horizontal stripes or other imperfections when viewed on some displays. This does not mean this unit is malfunctioning.

Additional Information

Problems during Video CD playback

Symptom	Cause	Action (See)
The PBC (playback control) menu display cannot be called up.	The Video CD playing does not feature PBC.	This operation is not possible with Video CDs not featuring PBC.
	PBC is turned off.	Turn PBC on. (Page 32, Page 35)
Repeat play and track/time search are not possible.	PBC is turned on.	Turn PBC off. (Page 32, Page 35)



Error messages

When problems occur with disc playback, an error message appears on the display. Refer to the table below to identify the problem, then take the suggested corrective action. If the error persists, contact your dealer or your nearest PIONEER Service Center.

Message	Cause	Action (See)
ERROR-02	Dirty disc	Clean disc.
	Scratched disc	Replace disc.
ERROR-05	Electrical or mechanical	Press RESET .
DIFFERENT REGION DISC (REGION ERR)	The disc does not have the same region number as this unit	Replace the DVD video with one bearing the correct region number.
NON PLAYABLE DISC (NON-PLAY)	This type of disc cannot be played by this unit	Replace the disc with one this unit can play.
	The disc is loaded upside down	Check that the disc is loaded correctly.
THERMAL PROTECTION IN MOTION (TEMP)	The temperature of this unit is outside of the normal operating range	Wait until the unit's temperature returns to within normal operating limits.



Additional Information

DVD player and care

- Use only normal, round discs. If you insert irregular, non-round, shaped discs they may jam in the DVD player or not play properly.



- Check all discs for cracks, scratches or warped discs before playing. Discs that have cracks, scratches or are warped may not play properly. Do not use such discs.
- Avoid touching the recorded (non-printed side) surface when handling the disc.
- Store discs in their cases when not in use.
- Keep discs out of direct sunlight and do not expose the discs to high temperatures.
- Do not attach labels, write on or apply chemicals to the surface of the discs.
- To clean dirt from a disc, wipe the disc with a soft cloth outward from the center of the disc.



- If the heater is used in cold weather, moisture may form on components inside the DVD player. Condensation may cause the DVD player to not operate properly. If you think that condensation is a problem turn off the DVD player for an hour or so to allow the DVD player to dry out and wipe any damp discs with a soft cloth to remove the moisture.
- Road shocks may interrupt disc playback. ■

DVD discs

- With some DVD video discs, it may not be possible to use certain functions.
- It may not be possible to play back some DVD video discs.
- When DVD-R/DVD-RW discs are used, playback is possible only for discs which have been finalized.
- When DVD-R/DVD-RW discs are used, playback is possible only for discs which have been recorded with the Video format (video mode). It is not possible to play back DVD-RW discs which have been recorded with the Video Recording format (VR mode).
- It may not be possible to play back DVD-R/DVD-RW discs which have been recorded with the Video format (video mode), because of disc characteristics, scratches or dirt on the disc, or dirt, condensation, etc. on the lens of this unit.
- It is not possible to play back DVD-ROM/DVD-RAM discs.
- Playback of discs recorded on a personal computer may not be possible depending on the application settings and the environment. Please record with the correct format. (For details, contact the manufacturer of the application.) ■

CD-R/CD-RW discs

- When CD-R/CD-RW discs are used, playback is possible only for discs which have been finalized.
- It may not be possible to play back CD-R/CD-RW discs recorded on a music CD recorder or a personal computer because of disc characteristics, scratches or dirt on the disc, or dirt, condensation, etc. on the lens of this unit.

Additional Information

- Playback of discs recorded on a personal computer may not be possible depending on the application settings and the environment. Please record with the correct format. (For details, contact the manufacturer of the application.)
- Playback of CD-R/CD-RW discs may become impossible in case of direct exposure to sunlight, high temperatures, or the storage conditions in the car.
- Titles and other text information recorded on a CD-R/CD-RW disc may not be displayed by this unit (in the case of audio data (CD-DA)).
- This unit conforms to the track skip function of the CD-R/CD-RW disc. The tracks containing the track skip information are skipped automatically (in case of audio data (CD-DA)).
- If you insert a CD-RW disc into this unit, time to playback will be longer than when you insert a conventional CD or CD-R disc.
- Read the precautions with CD-R/CD-RW discs before using them. ▣
- The max. number of characters which can be displayed for a folder name is 32 characters.
- In case of files recorded according to the Romeo and Joliet file system, only the first 32 characters can be displayed.
- When playing discs with MP3 files and audio data (CD-DA) such as CD-EXTRA and MIXED-MODE CDs, both types can be played only by switching mode between MP3 and CD-DA.
- The folder selection sequence for playback and other operations becomes the writing sequence used by the writing software. For this reason, the expected sequence at the time of playback may not coincide with the actual playback sequence. However, there also is some writing software which permits setting of the playback order.
- Files are compatible with the ID3 Tag Ver. 1.0 and Ver. 1.1 formats for display of album (disc title), track (track title) and artist (track artist).
- Only when MP3 files of 32, 44.1 and 48 kHz frequencies are played back, the emphasis function is valid. (16, 22.05, 24, 32, 44.1, 48 kHz sampling frequencies can be played back.)

MP3 files

- MP3 is short for MPEG Audio Layer 3 and refers to an audio compression technology standard.
- This unit allows playback of MP3 files on CD-ROM, CD-R and CD-RW discs. Disc recordings compatible with level 1 and level 2 of ISO9660 and with the Romeo and Joliet file system can be played back.
- It is possible to play back multi-session compatible recorded discs.
- MP3 files are not compatible with packet write data transfer.
- The max. number of characters which can be displayed for a file name, including the extension (.mp3), is 32 characters from the first character.
- There is no m3u playlist compatibility.
- There is no compatibility with the MP3i (MP3 interactive) or mp3 PRO format.
- The sound quality of MP3 files generally becomes better with increasing bit rate. This unit can play recordings with bit rates from 8 kbps to 320 kbps, but in order to be able to enjoy a certain sound quality, it is recommended to use only discs recorded with a bit rate of at least 128 kbps.



Important

- When naming an MP3 file, add the corresponding filename extension (.mp3).
- This unit plays back files with the filename extension (.mp3) as an MP3 file. To prevent

Additional Information

noise and malfunctions, do not use this extension for files other than MP3 files.

About folders and MP3 files

- An outline of a CD-ROM with MP3 files on it is shown below. Subfolders are shown as folders in the folder currently selected.

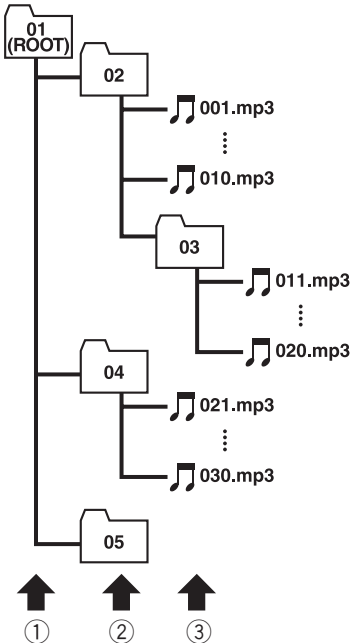

- ① First level
- ② Second level
- ③ Third level

Notes

- This unit assigns folder numbers. The user can not assign folder numbers.

- It is not possible to check folders that do not include MP3 files. (These folders will be skipped without displaying the folder number.)
- MP3 files in up to 8 tiers of folders can be played back. However, there is a delay in the start of playback on discs with numerous tiers. For this reason we recommend creating discs with no more than 2 tiers.
- It is possible to play back up to 253 items from folder on one disc. 

Using the display correctly

CAUTION

- If moisture or foreign matter should get inside this unit, turn off the power immediately and consult your dealer or the nearest authorized PIONEER Service Station. Using this unit in this condition may result in a fire or electric shock, or other failure.
- If you notice smoke, a strange noise or smell, or any other abnormal signs from the display, turn off the power immediately and consult your dealer or the nearest authorized PIONEER Service Station. Using this unit in this condition may result in failure of the system.
- Do not disassemble or modify this unit, as there are high-voltage components inside which may cause an electric shock. Be sure to consult your dealer or the nearest authorized PIONEER Service Station for internal inspection, adjustments or repairs.

Handling the display

- When the display is subjected to direct sunlight for a long period of time, it will become very hot resulting in possible damage to the LCD screen. When not using this unit, close the display and avoid exposing it to direct sunlight as much as possible.

Additional Information

- The display should be used within the temperature ranges shown below.
Operating temperature range: -10 to $+50$ °C
Storage temperature range: -20 to $+80$ °C
At temperatures higher or lower than the operating temperature range the display may not operate normally.
- The LCD screen of this unit is exposed in order to increase its visibility within the vehicle. Please do not press strongly on it as this may damage it.
- Do not place anything on the display when it is deployed. Also, do not attempt to carry out angle adjustment, or open/close the display by hand. Applying strong force to the display may damage it.
- Do not push the LCD screen with much force as this may scratch it.
- Be careful not to place anything between the display and the main body when the display is opening or closing. If an object gets between the display and main body, the display may stop working.

Liquid crystal display (LCD) screen

- If the display is near the vent of an air conditioner when it is opened, make sure that air from the air conditioner is not blowing on it. Heat from the heater may break the LCD screen, and cool air from the cooler may cause moisture to form inside the display resulting in possible damage. Also, if the display is cooled down by the cooler, the screen may become dark, or the life span of the small fluorescent tube used inside the display may be shortened.
- Small black dots or white dots (bright dots) may appear on the LCD screen. These are due to the characteristics of the LCD screen and do not indicate a problem with the display.

- At low temperatures, the LCD screen may be dark for a while after the power is turned on.
- The LCD screen will be difficult to see if it is exposed to direct sunlight.
- When using a portable phone, keep the antenna of the portable phone away from the display to prevent disruption of the video by the appearance of spots, colored stripes, etc.

Keeping the display in good condition

- When removing dust from the screen or cleaning the display, first turn the system power off, then wipe with the supplied cloth.
- When wiping the screen, take care not to scratch the surface. Do not use harsh or abrasive chemical cleaners.

Small fluorescent tube

- A small fluorescent tube is used inside the display to illuminate the LCD screen.
 - The fluorescent tube should last for approximately 10,000 hours, depending on operating conditions. (Using the display at low temperatures reduces the service life of the fluorescent tube.)
 - When the fluorescent tube reaches the end of its useful life, the screen will be dark and the image will no longer be projected. If this happens, consult your dealer or the nearest authorized PIO-NEER Service Station. ▣

Additional Information

Language code chart for DVD

Language (code), input code	Language (code), input code	Language (code), input code
Japanese (ja), 1001	Guarani (gn), 0714	Pashto, Pushto (ps), 1619
English (en), 0514	Gujarati (gu), 0721	Quechua (qu), 1721
French (fr), 0618	Hausa (ha), 0801	Rhaeto-Romance (rm), 1813
Spanish (es), 0519	Hindi (hi), 0809	Kirundi (rn), 1814
German (de), 0405	Croatian (hr), 0818	Romanian (ro), 1815
Italian (it), 0920	Hungarian (hu), 0821	Kinyarwanda (rw), 1823
Chinese (zh), 2608	Armenian (hy), 0825	Sanskrit (sa), 1901
Dutch (nl), 1412	Interlingua (ia), 0901	Sindhi (sd), 1904
Portuguese (pt), 1620	Interlingue (ie), 0905	Sangho (sg), 1907
Swedish (sv), 1922	Inupiak (ik), 0911	Serbo-Croatian (sh), 1908
Russian (ru), 1821	Indonesian (in), 0914	Sinhalese (si), 1909
Korean (ko), 1115	Icelandic (is), 0919	Slovak (sk), 1911
Greek (el), 0512	Hebrew (iw), 0923	Slovenian (sl), 1912
Afar (aa), 0101	Yiddish (ji), 1009	Samoan (sm), 1913
Abkhazian (ab), 0102	Javanese (jw), 1023	Shona (sn), 1914
Afrikaans (af), 0106	Georgian (ka), 1101	Somali (so), 1915
Amharic (am), 0113	Kazakh (kk), 1111	Albanian (sq), 1917
Arabic (ar), 0118	Greenlandic (kl), 1112	Serbian (sr), 1918
Assamese (as), 0119	Cambodian (km), 1113	Siswati (ss), 1919
Aymara (ay), 0125	Kannada (kn), 1114	Sesotho (st), 1920
Azerbaijani (az), 0126	Kashmiri (ks), 1119	Sundanese (su), 1921
Bashkir (ba), 0201	Kurdish (ku), 1121	Swahili (sw), 1923
Byelorussian (be), 0205	Kirghiz (ky), 1125	Tamil (ta), 2001
Bulgarian (bg), 0207	Latin (la), 1201	Telugu (te), 2005
Bihari (bh), 0208	Lingala (ln), 1214	Tajik (tg), 2007
Bislama (bi), 0209	Laothian (lo), 1215	Thai (th), 2008
Bengali (bn), 0214	Lithuanian (lt), 1220	Tigrinya (ti), 2009
Tibetan (bo), 0215	Latvian (lv), 1222	Turkmen (tk), 2011
Breton (br), 0218	Malagasy (mg), 1307	Tagalog (tl), 2012
Catalan (ca), 0301	Maori (mi), 1309	Setswana (tn), 2014
Corsican (co), 0315	Macedonian (mk), 1311	Tonga (to), 2015
Czech (cs), 0319	Malayalam (ml), 1312	Turkish (tr), 2018
Welsh (cy), 0325	Mongolian (mn), 1314	Tsonga (ts), 2019
Danish (da), 0401	Moldavian (mo), 1315	Tatar (tt), 2020
Bhutani (dz), 0426	Marathi (mr), 1318	Twi (tw), 2023
Esperanto (eo), 0515	Malay (ms), 1319	Ukrainian (uk), 2111
Estonian (et), 0520	Maltese (mt), 1320	Urdu (ur), 2118
Basque (eu), 0521	Burmese (my), 1325	Uzbek (uz), 2126
Persian (fa), 0601	Nauru (na), 1401	Vietnamese (vi), 2209
Finnish (fi), 0609	Nepali (ne), 1405	Volapük (vo), 2215
Fiji (fj), 0610	Norwegian (no), 1415	Wolof (wo), 2315
Faroese (fo), 0615	Occitan (oc), 1503	Xhosa (xh), 2408
Frisian (fy), 0625	Oromo (om), 1513	Yoruba (yo), 2515
Irish (ga), 0701	Oriya (or), 1518	Zulu (zu), 2621
Scots-Gaelic (gd), 0704	Punjabi (pa), 1601	
Galician (gl), 0712	Polish (pl), 1612	



Additional Information

Terms

Aspect ratio

This is the width-to-height ratio of a TV screen. A regular display has an aspect ratio of 4:3. Wide screen displays have an aspect ratio of 16:9, providing a bigger picture for exceptional presence and atmosphere.

Bit rate

This expresses data volume per second, or bps units (bits per second). The higher the rate, the more information is available to reproduce the sound. Using the same encoding method (such as MP3), the higher the rate, the better the sound.

Chapter

DVD titles are in turn divided into chapters which are numbered in the same way as the chapters of a book. With DVD video discs featuring chapters, you can quickly find a desired scene with chapter search.

Dolby Digital

Dolby Digital provides multi-channel audio from up to 5.1 independent channels. This is the same as the Dolby Digital surround sound system used in theaters.



DTS

This stands for Digital Theater Systems. DTS is a surround system delivering multi-channel audio from up to 6 independent channels.



ID3 tag

This is a method of embedding track-related information in a MP3 file. This embedded information can include the track title, the artist's name, the album title, the music genre,

the year of production, comments and other data. The contents can be freely edited using software with ID3 Tag editing functions. Although the tags are restricted to the number of characters, the information can be viewed when the track is played back.

ISO9660 format

This is the international standard for the format logic of CD-ROM folders and files. For the ISO9660 format, there are regulations for the following two levels.

Level 1:

The file name is in 8.3 format (the name consists of up to 8 characters, half-byte English capital letters and half-byte numerals and the “_” sign, with a file-extension of three characters.)

Level 2:

The file name can have up to 31 characters (including the separation mark “.” and a file extension). Each folder contains less than 8 hierarchies.

Extended formats

Joliet:

File names can have up to 64 characters.

Romeo:

File names can have up to 128 characters.

Linear PCM (LPCM)/Pulse code modulation

This stands for linear pulse code modulation, which is the signal recording system used for music CDs and DVDs. Generally, DVDs are recorded with higher sampling frequency and bit rate than CDs. Therefore, DVDs can provide higher sound quality.

m3u

Playlists created using the “WINAMP” software have a playlist file extension (.m3u).

MP3

MP3 is short for MPEG Audio Layer 3. It is an audio compression standard set by a working

Additional Information

group (MPEG) of the ISO (International Standards Organization). MP3 is able to compress audio data to about 1/10th the level of a conventional disc.

MPEG

This stands for Moving Pictures Experts Group, and is an international video image compression standard. Some DVDs feature digital audio compressed and recorded using this system.

Multi-angle

With regular TV programs, although multiple cameras are used to simultaneously shoot scenes, only images from one camera at a time are transmitted to your TV. Some DVDs feature scenes shot from multiple angles, letting you choose your viewing angle as desired.

Multi-audio (Multilingual dialog)

Some DVDs feature dialog recorded in multiple languages. Dialog in up to 8 languages can be recorded on a single disc, letting you choose as desired.

Multi-session

Multi-session is a recording method that allows additional data to be recorded later. When recording data on a CD-ROM, CD-R or CD-RW, etc., all data from beginning to end is treated as a single unit or session. Multi-session is a method of recording more than 2 sessions in one disc.

Multi-subtitle

Subtitles in up to 32 languages can be recorded on a single DVD, letting you choose as desired.

Optical digital output/input

By transmitting and receiving audio signals in a digital signal format, the chance of sonic quality deteriorating in the course of transmission is minimized. An optical digital output/

input is designed to transmit and receive digital signals optically.

Packet write

This is a general term for a method of writing on CD-R, etc. at the time required for a file, just as is done with files on floppy or hard discs.

Parental lock

Some DVD video discs with violent or adult-oriented scenes feature parental lock which prevents children from viewing such scenes. With this kind of disc, if you set the unit's parental lock level, playback of scenes inappropriate for children will be disabled, or these scenes will be skipped.

Playback control (PBC)

This is a playback control signal recorded on Video CDs (Version 2.0). Using menu displays provided by Video CDs with PBC lets you enjoy playback of simple interactive software and software with search functions. You can also enjoy viewing high- and standard-resolution still images.

Region number

DVD players and DVD discs feature region numbers indicating the area in which they were purchased. Playback of a DVD is not possible unless it features the same region number as the DVD player. This unit's region number is displayed on the bottom of this unit.

Title

DVD video discs have high data capacity, enabling recording of multiple movies on a single disc. If, for example, one disc contains three separate movies, they are divided into title 1, title 2 and title 3. This lets you enjoy the convenience of title search and other functions.

Additional Information

VBR

VBR is short for variable bit rate. Generally speaking CBR (constant bit rate) is more widely used. But to flexibly adjust the bit rate according to the needs of audio compression, it is possible to achieve compression priorities sound quality.

Additional Information

Specifications

General

Power source	14.4 V DC (10.8 – 15.1 V al- lowable)
Grounding system	Negative type
Head unit:	
Max. current consumption	10.0 A
Dimensions (W × H × D):	
DIN	
Chassis	178 × 50 × 160 mm
Nose	188 × 58 × 36 mm
D	
Chassis	178 × 50 × 165 mm
Nose	170 × 46 × 31 mm
Weight	2.2 kg
Hideaway unit:	
Max. current consumption	1.0 A
Dimensions (W × H × D)	150 × 28 × 100 mm
Weight	0.3 kg

Display

Screen size/aspect ratio	6.5 inch wide/16:9 (effective display area: 146 × 79 mm)
Pixels	336,960 (1,440 × 234)
Type	TFT active matrix, transmis- sive type
Color system	NTSC/PAL compatible
Operating temperature range	-10 – +50 °C
Storage temperature range	-20 – +80 °C
Angle adjustment	50 – 110° (initial settings: 110°)

Audio

Continuous power output is 22 W per channel minimum into 4 ohms, both channels driven 50 to 15,000 Hz with no more than 5% THD.	
Maximum power output	50 W × 4 50 W × 2/4 Ω + 70 W × 1/2 Ω (for subwoofer)
Load impedance	4 Ω (4 – 8 Ω [2 Ω for 1 ch] al- lowable)
Preout max output level/output impedance	4.0 V/100Ω

Equalizer (3-Band Parametric Equalizer):

Low	
Frequency	40/80/100/160 Hz
Q Factor	0.35/0.59/0.95/1.15 (+6 dB when boosted)
Gain	±12dB
Mid	
Frequency	200/500/1k/2k Hz
Q Factor	0.35/0.59/0.95/1.15 (+6 dB when boosted)
Gain	±12dB
High	
Frequency	3.15k/8k/10k/12.5k Hz
Q Factor	0.35/0.59/0.95/1.15 (+6 dB when boosted)
Gain	±12dB
Loudness contour	
Low	+3.5 dB (100 Hz), +3 dB (10 kHz)
Mid	+10 dB (100 Hz), +6.5 dB (10 kHz)
High	+11 dB (100 Hz), +11 dB (10 kHz) (volume: -30 dB)

Tone controls:

Bass	
Frequency	40/63/100/160 Hz
Gain	±12dB
Treble	
Frequency	2.5k/4k/6.3k/10k Hz
Gain	±12dB

HPF:

Frequency	50/80/125 Hz
Slope	-12 dB/oct

Subwoofer:

Frequency	50/80/125 Hz
Slope	-18 dB/oct
Gain	±12dB
Phase	Normal/Reverse

DVD Player

System	DVD video, Video CD, Com- pact disc audio system
Usable discs	DVD video, Video CD, Com- pact disc
Region number:	
for Southeast Asian models	3
for South American and Oceanian models	4
Signal format:	
Sampling frequency	44.1/48/96 kHz

Additional Information

Number of quantization bits	16/20/24; linear
Frequency response	5 – 44,000 Hz (with DVD, at sampling frequency 96 kHz)
Signal-to-noise ratio	97 dB (1 kHz) (IEC-A network) (CD: 96 dB (1 kHz) (IEC-A network))
Dynamic range	95 dB (1 kHz) (CD: 94 dB (1 kHz))
Distortion	0.008 % (1 kHz)
Output level:	
Video	1.0 V _{p-p} /75 Ω (±0.2 V)
Audio	1.0 V (1 kHz, 0 dB)
Number of channels	2 (stereo)
MP3 decoding format	MPEG-1 & 2 Audio Layer 3

FM tuner

Frequency range	87.5 – 108.0 MHz
Usable sensitivity	8 dBf (0.7 μV/75 Ω, mono, S/N: 30 dB)
50 dB quieting sensitivity	10 dBf (0.9 μV/75 Ω, mono)
Signal-to-noise ratio	75 dB (IEC-A network)
Distortion	0.3 % (at 65 dBf, 1 kHz, stereo) 0.1 % (at 65 dBf, 1 kHz, mono)
Frequency response	30 – 15,000 Hz (±3 dB)
Stereo separation	45 dB (at 65 dBf, 1 kHz)

AM tuner

Frequency range	531 – 1,602 kHz (9 kHz) 530 – 1,640 kHz (10 kHz)
Usable sensitivity	18 μV (S/N: 20 dB)
Signal-to-noise ratio	65 dB (IEC-A network)

Infrared remote control

Wavelength	945 nm
Output	typ; 10 mw/sr per Infrared LED



Note

Specifications and the design are subject to possible modifications without notice due to improvements. ■

A		
Angle icon	31, 72	
Aspect ratio	72, 90	
Audio language	71	
B		
Brightness	21	
C		
Chapter	90	
Code number	72	
Color	21	
Condition memory	8	
Contrast	21	
D		
Direct search	30, 35	
Dolby Digital	7, 90	
DTS	7, 90	
H		
Hue	21	
L		
Language code chart	89	
Linear PCM (LPCM)	90	
M		
Menu language	71	
MPEG	91	
Multi-angle	31, 91	
Multi-audio	71, 91	
Multi-subtitle	70, 91	
O		
Optical digital output/input	91	
P		
Parental lock	72, 91	
PBC (playback control)	32	
Playback control (PBC)	91	
R		
Region number	6, 91	
S		
Subtitle language	70	
T		
Title	91	
TV aspect	72	
V		
Video CD	6	
W		
Wide screen mode	20	



PIONEER CORPORATION

4-1, MEGURO 1-CHOME, MEGURO-KU, TOKYO 153-8654, JAPAN

PIONEER ELECTRONICS (USA) INC.

P.O. Box 1540, Long Beach, California 90801-1540, U.S.A.
TEL: (800) 421-1404

PIONEER EUROPE NV

Haven 1087, Keetberglaan 1, B-9120 Melsele, Belgium
TEL: (0) 3/570.05.11

PIONEER ELECTRONICS ASIACENTRE PTE. LTD.

253 Alexandra Road, #04-01, Singapore 159936
TEL: 65-6472-1111

PIONEER ELECTRONICS AUSTRALIA PTY. LTD.

178-184 Boundary Road, Braeside, Victoria 3195, Australia
TEL: (03) 9586-6300

PIONEER ELECTRONICS OF CANADA, INC.

300 Allstate Parkway, Markham, Ontario L3R OP2, Canada
TEL: (905) 479-4411

PIONEER ELECTRONICS DE MEXICO, S.A. de C.V.

Bvd.Manuel Avila Camacho 138 10 piso
Col.Lomas de Chapultepec, Mexico, D.F. 11000
TEL: 55-9178-4270

先鋒股份有限公司

總公司：台北市中山北路二段44號13樓
電話：(02) 2521-3588

先鋒電子（中國）有限公司

香港辦事處：香港銅鑼灣告士打道280號世界貿易中心
17樓 1704-06室
電話：(0852) 2848-6488

Published by Pioneer Corporation.
Copyright © 2003 by Pioneer Corporation.
All rights reserved.

Printed in Japan

<CRB1838-B> RC, RD

<KMMZF/03C00000>

Free Manuals Download Website

<http://myh66.com>

<http://usermanuals.us>

<http://www.somanuals.com>

<http://www.4manuals.cc>

<http://www.manual-lib.com>

<http://www.404manual.com>

<http://www.luxmanual.com>

<http://aubethermostatmanual.com>

Golf course search by state

<http://golfingnear.com>

Email search by domain

<http://emailbydomain.com>

Auto manuals search

<http://auto.somanuals.com>

TV manuals search

<http://tv.somanuals.com>