

Operating Instructions

STEREO DOUBLE CASSETTE DECK

CT-W803RS
CT-W703RS
CT-W603RS

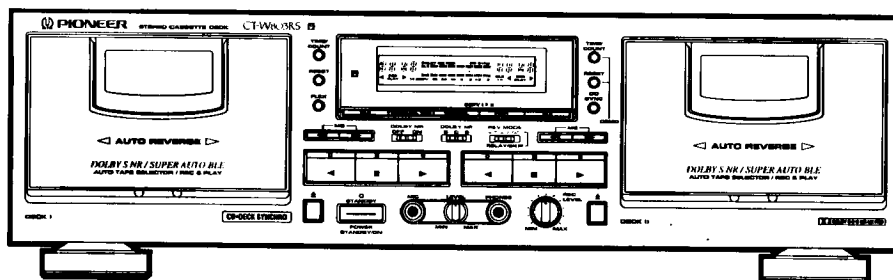

- The above illustration shows CT-W803RS.
- For the demo function, refer to back cover of this operating instructions.

Thank you for buying this Pioneer product. Please read through these operating instructions so you will know how to operate your unit properly. After you have finished reading the instructions, keep the manual in a safe place for future reference.

In some countries or regions, the shape of the power plug and power outlet may sometimes differ from that shown in the explanatory drawings. However, the method of connecting and operating the unit is the same.

WARNING: TO PREVENT FIRE OR SHOCK HAZARD, DO NOT EXPOSE THIS APPLIANCE TO RAIN OR MOISTURE.

IMPORTANT NOTICE

[For U.S. and Canadian models]

The serial number for this equipment is located on the rear panel. Please write this serial number on your enclosed warranty card and keep it in a secure area. This is for your security.

[For Canadian model]

CAUTION: TO PREVENT ELECTRIC SHOCK DO NOT USE THIS (POLARIZED) PLUG WITH AN EXTENSION CORD, RECEPTACLE OR OTHER OUTLET UNLESS THE BLADES CAN BE FULLY INSERTED TO PREVENT BLADE EXPOSURE.

ATTENTION: POUR PREVENIR LES CHOCS ELECTRIQUES NE PAS UTILISER CETTE FICHE POLARISEE AVEC UN PROLONGATEUR UNE PRISE DE COURANT OU UNE AUTRE SORTIE DE COURANT, SAUF SI LES LAMES PEUVENT ETRE INSEREES A FOND SANS EN LAISSER AUCUNE PARTIE A DECOUVERT.

"This product complies with the Radio Interference requirements of the EC (European Community) Directive 87/308/EEC."

IMPORTANT 1



The lightning flash with arrowhead, within an equilateral triangle, is intended to alert the user to the presence of uninsulated "dangerous voltage" within the product's enclosure that may be of sufficient magnitude to constitute a risk of electric shock to persons.



CAUTION:
TO PREVENT THE RISK OF ELECTRIC SHOCK, DO NOT REMOVE COVER (OR BACK). NO USER-SERVICEABLE PARTS INSIDE. REFER SERVICING TO QUALIFIED SERVICE PERSONNEL.



The exclamation point within an equilateral triangle is intended to alert the user to the presence of important operating and maintenance (servicing) instructions in the literature accompanying the appliance.

IMPORTANT 2

FOR USE IN THE UNITED KINGDOM

The wires in this mains lead are coloured in accordance with the following code:

blue neutral
brown live

If the plug provided is unsuitable for your socket outlets, the plug must be cut off and a suitable plug fitted.

The cut-off plug should be disposed of and must not be inserted into any 13 amp socket as this can result in electric shock. The plug or adaptor or the distribution panel should be provided with 5 amp fuse. As the colours of the wires in the mains lead of this appliance may not correspond with coloured markings identifying the terminals in your plug, proceed as follows:

The wire which is coloured blue must be connected to the terminal which is marked with the letter N or coloured black.

The wire which is coloured brown must be connected to the terminal which is marked with the letter L or coloured red.

Do not connect either wire to the earth terminal of a three pin plug.

NOTE

After replacing or changing a fuse, the fuse cover in the plug must be replaced with a fuse cover which corresponds to the colour of the insert in the base of the plug or the word that is embossed on the base of the plug, and the appliance must not be used without a fuse cover. If lost, replacement fuse covers can be obtained from your dealer.

Only 5 A fuses approved by B.S.I. or A.S.T.A. to B.S. 1362 should be used.

SAFETY INSTRUCTIONS

READ INSTRUCTIONS — All the safety and operating instructions should be read before the appliance is operated.

RETAIN INSTRUCTIONS — The safety and operating instructions should be retained for future reference.

HEED WARNING — All warnings on the appliance and in the operating instructions should be adhered to.

FOLLOW INSTRUCTIONS — All operating and use instructions should be followed.

WATER AND MOISTURE — The appliance should not be used near water — for example, near a bathtub, washbowl, kitchen sink, laundry tub, in a wet basement, or near a swimming pool, etc.

LOCATION — The appliance should be installed in a stable location.

WALL OR CEILING MOUNTING — The appliance should not be mounted to a wall or ceiling.

VENTILATION — The appliance should be situated so that its location or position does not interfere with its proper ventilation. For example, the appliance should not be situated on a bed, sofa, rug, or similar surface that may block the ventilation openings; or, placed in a built-in installation, such as a bookcase or cabinet that may impede the flow of air through the ventilation openings.

HEAT — The appliance should be situated away from heat sources such as radiators, heat registers, stoves, or other appliances (including amplifiers) that produce heat.

POWER SOURCES — The appliance should be connected to a power supply only of the type described in the operating instructions or as marked on the appliance.

POWER-CORD PROTECTION — Power-supply cords should be routed so that they are not likely to be walked on or pinched by items placed upon or against them. Pay particular attention to cords at plugs, convenience receptacles, and the point where they exit from the appliance.

POLARIZATION — If your purchased product is provided with a polarized power plug, please read the following instructions. This product is equipped with a polarized alternating current line plug (a plug having one blade wider than the other). This plug will fit into the power outlet only one way. This is a safety feature. If you are unable to insert the plug fully into the outlet, try reversing the plug. If the plug should still fail to fit, contact your electrician to replace your obsolete outlet. Do not defeat the safety purpose of the polarized plug.

CLEANING — The appliance should be cleaned only with a polishing cloth or a soft dry cloth. Never clean with furniture wax, benzine, insecticides or other volatile liquids since they may corrode the cabinet.

POWER LINES — An outdoor antenna should be located away from power lines.

NONUSE PERIODS — The power cord of the appliance should be unplugged from the outlet when left unused for a long period of time.

OBJECT AND LIQUID ENTRY — Care should be taken so that objects do not fall and liquids are not spilled into the enclosure through openings.

DAMAGE REQUIRING SERVICE — The appliance should be serviced by a Pioneer authorized service center or qualified service personnel when:

- The power-supply cord or the plug has been damaged.
- Objects have fallen, or liquid has been spilled into the appliance.
- The appliance has been exposed to rain.
- The appliance does not appear to operate normally or exhibits a marked change in performance.
- The appliance has been dropped or the enclosure damaged.

SERVICING — The user should not attempt to service the appliance beyond that described in the operating instructions. All other servicing should be referred to qualified service personnel.

OUTDOOR ANTENNA GROUNDING — If an outside antenna is connected to the antenna terminal, be sure the antenna system is grounded so as to provide some protection against voltage surges and built-up static charges.

In the U.S.A. section 810 of the National Electrical Code, ANSI/NFPA 70, provides information with respect to proper grounding of the mast and supporting structure, grounding of the lead-in wire to an antenna discharge unit, size of grounding conductors, location of antenna discharge unit, connection to grounding electrodes, and requirements for the grounding electrode. See Fig. A.

CART — An appliance and cart combination should be moved with care. Quick stops, excessive force, and uneven surfaces may cause the appliance and cart combination to overturn.



NEC — NATIONAL ELECTRIC CODE

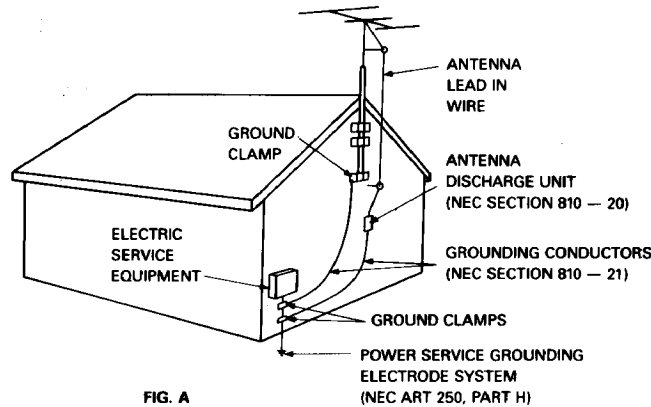

This equipment has been tested and found to comply with the limits for a Class B digital device, pursuant to Part 15 of the FCC Rules. These limits are designed to provide reasonable protection against harmful interference in a residential installation. This equipment generates, uses, and can radiate radio frequency energy and, if not installed and used in accordance with the instructions, may cause harmful interference to radio communications. However, there is no guarantee that interference will not occur in a particular installation. If this equipment does cause harmful interference to radio or television reception, which can be determined by turning the equipment off and on, the user is encouraged to try to correct the interference by one or more of the following measures:

- Reorient or relocate the receiving antenna.
- Increase the separation between the equipment and receiver.
- Connect the equipment into an outlet on a circuit different from that to which the receiver is connected.
- Consult the dealer or an experienced radio/TV technician for help.

Information to User

Alteration or modifications carried out without appropriate authorization may invalidate the user's right to operate the equipment.

[For Canadian model]

This digital apparatus does not exceed the Class B limits for radio noise emissions from digital apparatus set out in the Radio Interference Regulations of the Canadian Department of Communications.

[Pour le modèle Canadien]

L'interférence, radioélectrique générée par cet appareil numérique de type B ne dépasse pas les limites énoncées dans le Règlement sur les perturbations radioélectriques, section appareil numérique, du Ministère des Communications.



Dear Customer:

Selecting fine audio equipment such as the unit you've just purchased is only the start of your musical enjoyment. Now it's time to consider how you can maximize the fun and excitement your equipment offers. This manufacturer and the Electronic Industries Association's Consumer Electronics Group want you to get the most out of your equipment by playing it at a safe level. One that lets the sound come through loud and clear without annoying blaring or distortion—and, most importantly, without affecting your sensitive hearing.

Sound can be deceiving. Over time your hearing "comfort level" adapts to higher volumes of sound. So what sounds "normal" can actually be loud and harmful to your hearing. Guard against this by setting your equipment at a safe level BEFORE your hearing adapts.

To establish a safe level:

- Start your volume control at a low setting.
- Slowly increase the sound until you can hear it comfortably and clearly, and without distortion.

Once you have established a comfortable sound level:

- Set the dial and leave it there.

Taking a minute to do this now will help to prevent hearing damage or loss in the future. After all, we want you listening for a lifetime.

We Want You Listening For A Lifetime

Used wisely, your new sound equipment will provide a lifetime of fun and enjoyment. Since hearing damage from loud noise is often undetectable until it is too late, this manufacturer and the Electronic Industries Association's Consumer Electronics Group recommend you avoid prolonged exposure to excessive noise. This list of sound levels is included for your protection.

Decibel Level	Example
30	Quiet library, soft whispers
40	Living room, refrigerator, bedroom away from traffic
50	Light traffic, normal conversation, quiet office
60	Air conditioner at 20 feet, sewing machine
70	Vacuum cleaner, hair dryer, noisy restaurant
80	Average city traffic, garbage disposals, alarm clock at two feet.

THE FOLLOWING NOISES CAN BE DANGEROUS UNDER CONSTANT EXPOSURE

90	Subway, motorcycle, truck traffic, lawn mower
100	Garbage truck, chain saw, pneumatic drill
120	Rock band concert in front of speakers, thunderclap
140	Gunshot blast, jet plane
180	Rocket launching pad

Information courtesy of the Deafness Research Foundation.



CONTENTS

INSTALLATION.....	4
MAINTENANCE.....	4
HANDLING CASSETTE TAPES.....	5
CONNECTIONS.....	6
FRONT PANEL FACILITIES.....	7
REMOTE CONTROL OPERATION (CT-W803RS only).....	11
PLAYBACK.....	12
SINGLE PLAYBACK.....	12
BLANK SKIP.....	12
RELAY PLAYBACK.....	12
MUSIC SEARCH.....	13
RECORDING.....	14
SINGLE RECORDING.....	14
RECORDING USING MICROPHONE (CT-W803RS/CT-W703RS only).....	14
RECORDING MUTE.....	14
ERASING A TAPE.....	14
AUTO BLE TUNING.....	15
RELAY RECORDING.....	16
PARALLEL RECORDING (CT-W803RS only).....	16
CD•DECK SYNCHRO RECORDING.....	17
TAPE COPYING.....	18
TROUBLESHOOTING.....	19
SPECIFICATIONS.....	21

INSTALLATION

When installing the deck, avoid locations with high temperatures or humidity, and make sure that the deck receives adequate ventilation.

- Do not install the deck in locations subject to direct sunlight, or near a space heater or other heating device, as this may cause damage to the finish or internal parts.
- Malfunctions may also result if the deck is installed in an excessively humid or dusty location. Avoid installing the deck next to kitchen counters or other locations subject to oily smoke or humidity.
- If the deck is placed directly on top of an amplifier, it may pick up humming or other noise. Also, if the amplifier generates a large amount of heat, the deck may malfunction.
- If the deck is located near a television set, it may pick up interference noise, which will be recorded as a whistling sound on the tape. If this happens, move the deck further away from the television set or turn the television set off when operating the deck.
- Do not place a cloth over the deck, or block the ventilation slots in any way. The ventilation slots on this deck are necessary to keep internal parts cool. If they are blocked, the deck may malfunction.

CONDENSATION

When the deck is moved from a cold location to a warm location, or when the temperature of the room changes suddenly, condensation may form on the mechanical parts. This can adversely affect the performance of the deck. If this occurs, wait for about one hour to allow the deck to adjust to the room temperature. To prevent condensation when heating a room, raise the temperature slowly.

MAINTENANCE

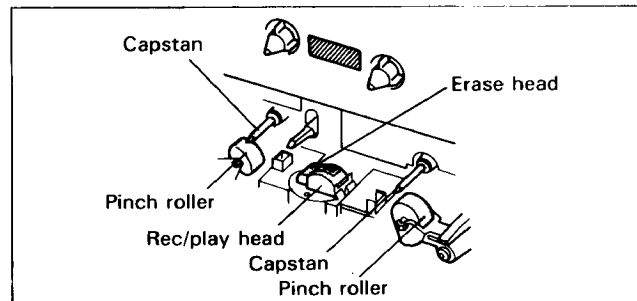

CLEANING THE HEADS, PINCH ROLLERS AND CAPSTANS

The heads, pinch rollers and capstans are likely to get dirty quite easily. If these parts, particularly the heads, get dirty, the high frequency components of a recording will not be reproduced and the stereo balance will be impaired, resulting in a deterioration of the playback sound. It is therefore recommended that the head section be cleaned regularly.

1. Set the POWER switch to STANDBY.
2. Press the eject button to open the cassette door.
3. Dip a cleaning swab in cleaning fluid and use it to wipe the heads, capstans and pinch rollers.

NOTE:

After cleaning the head section, do not load a tape until the cleaning fluid has dried completely (about two or three minutes).

DEMAGNETIZING THE HEADS

After using the cassette deck for a period of time, the heads will become magnetized. The same effect will occur if a magnetized screwdriver, magnet or other magnetized object is brought too close to the heads. When the heads become magnetized, high-frequency sounds will be lost during recording or playback, and interference noise may also occur. The heads should be regularly demagnetized with a head demagnetizer, which can be purchased at most audio stores.

When demagnetizing the heads, make sure that the POWER switch of the cassette deck is set to ON, and turn off the sound volume on the amplifier to which the deck is connected. Also be sure that no headphones are connected. For detailed instructions, refer to the operating instructions of the head demagnetizer.

CLEANING THE FRONT PANEL

Clean the deck regularly with a soft cloth. If the front panel becomes soiled, moisten a soft cloth with a weak solution of neutral detergent (diluted in five to six parts water), wring the cloth well, and wipe the panel clean. Never use volatile cleaners like thinners, benzene or alcohol because they will damage the panel finish.

THE POWER SWITCH IS SECONDARY CONNECTED AND THEREFORE DOES NOT SEPARATE THE UNIT FROM MAINS POWER IN STANDBY POSITION.

HANDLING CASSETTE TAPES

A

Turn pencil to
remove tape slack

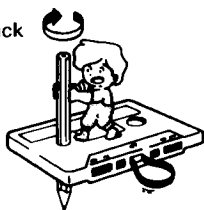

B

For erasure prevention
remove

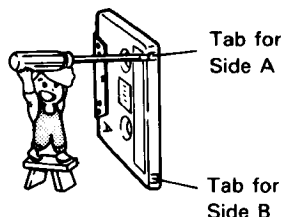

C

Cover with
adhesive tape

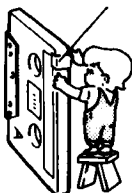

D

Erasure prevention tabs
Sensor holes

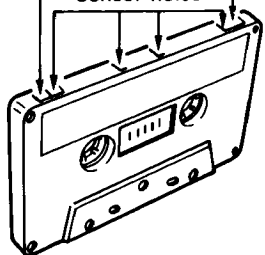

TYPE IV (Metal) tape

E

Sensor holes

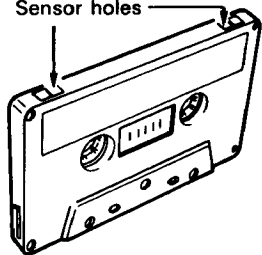

TYPE II (High/CrO₂) tape

CHECK CASSETTE BEFORE USE

Check the following items before loading a cassette tape:

Is the tape loose, or is some of the tape outside the cassette?

If some of the tape is loose or projecting outside the cassette shell, the tape may not properly enter between the capstan and pinch roller. This will prevent the tape from being supplied properly, and may even damage the tape itself. In such cases, insert a pencil into the reel hole and take up the slack (Fig. A).

Some cassette tapes come with a plastic or thick paper stopper to prevent the tape from becoming slack. Remove this stopper when loading the cassette and replace it after using the cassette.

Are the accidental erasure prevention tabs intact?

These tabs allow you to prevent important recordings from being erased accidentally. When the tab on the cassette shell is broken off (Fig. B), it is not possible to activate the recording function, so valuable recordings will not be erased by mistake.

To rerecord on a cassette whose tab has been broken off, simply stick a piece of doubled adhesive tape over the hole (Fig. C). When using TYPE IV (Metal) or TYPE II (High/CrO₂) tapes, be careful not to block the sensor holes with the tape (Fig. D, Fig. E). If the holes are blocked, the automatic tape selector mechanism will not operate correctly.

NOTES:

- The accidental erasure prevention tab for each side is the one located on the top left when the side that you want to protect is facing you.
- When breaking off the tab, do not use a magnetized screwdriver.

AUTOMATIC TAPE SELECTOR FUNCTION

This cassette deck is equipped with an automatic tape selector function which utilizes the sensor holes on the tape cassette to determine the type of tape being used. The deck is then set to match the tape recording bias and equalization.

NOTES:

- When using TYPE IV (Metal) tapes, make sure that the tapes have sensor holes.
- Make sure that the sensor holes on the cassette are not blocked; otherwise the tape selector mechanism will not function properly.
- Do not use TYPE III (FeCr) tapes.

TIPS ON CASSETTE TAPES

- Leader tape (which cannot be recorded on) is provided at the beginning of a cassette tape. Let the tape run for about 5 seconds before starting to record, to allow the leader tape to clear the recording head.
- Do not leave a cassette tape exposed to the environment. Store the cassette in its case after use so that dust and dirt do not adhere to the tape, and so the tape will not get slack. Store tapes in a location free from magnetism, dust, dirt, oil, heat and humidity.
- Because C-120 tapes are very thin, they can easily jam in the pinch rollers and capstan, and they often are subject to other problems such as irregular winding. It is best not to use them with this deck.
- If cassette tapes are irregularly wound, the tape may get jammed in the rollers. This can cause damage to both the tape and the deck. If you are not certain whether the tape is wound evenly, fast forward or rewind the tape from beginning to end, to make sure that the tape is properly wound.

CONNECTIONS

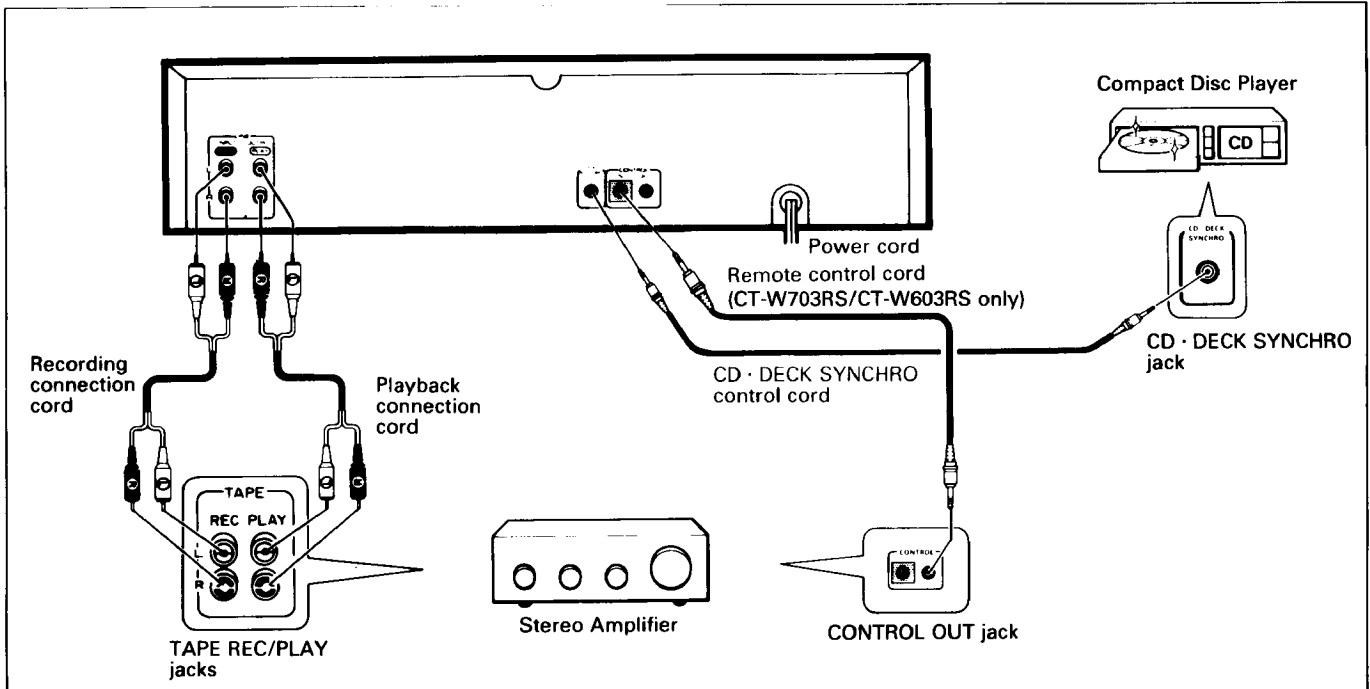

- Read through the operating instructions of the stereo components which you intend to connect to this unit.
- Turn the power on only after making all the connections.
- Make sure that all of the connection plugs are inserted securely, as improper connections may generate noise.

CONNECTING THE RECORDING AND PLAYBACK CORDS

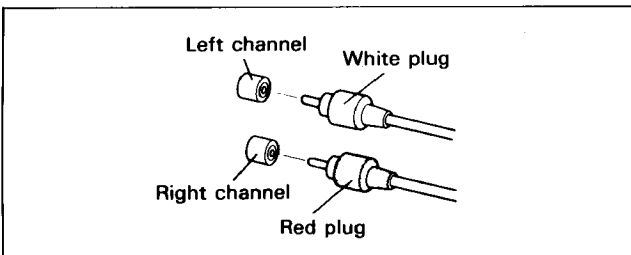

Connect the TAPE jacks of your amplifier to the LINE jacks of the cassette deck. Be sure to connect the REC (INPUT) jacks of the deck to the recording (output) jacks of the amplifier, and the PLAY (OUTPUT) jacks of the deck to the play (input) jacks of the amplifier.

- Connect the plugs properly:
Left channel — White plug
Right channel — Red plug

CD•DECK SYNCHRO RECORDING

- CD•DECK SYNCHRO recording can be carried out when this unit is connected to a Pioneer CD player equipped with a CD•DECK SYNCHRO jack.

Connection

Connect the CD•DECK SYNCHRO jack of this unit to the CD•DECK SYNCHRO jack of the CD player using the supplied CD•DECK SYNCHRO control cord.

NOTES:

- Keep the input and output jacks connected between the amplifier and this unit, otherwise, the CD•DECK SYNCHRO recording cannot be carried out.
- Even when the CD player is connected to the amplifier with an optical fiber cable, connect the CD player to the amplifier or this unit with the input and output cords with pin plug.

PIONEER SYSTEM REMOTE CONTROL (CT-W703RS/CT-W603RS only)

CONTROL IN jack

Use the enclosed Remote Control Cord to connect this jack to the CONTROL OUT jack of another component which bears the  mark (indicating that it is equipped with PIONEER System Remote Control). You will then be able to operate this unit using the Pioneer system remote control unit. If the remote control unit does not have separate buttons for deck I and deck II, or a selection button to choose deck I or deck II, the buttons will only operate deck II. To operate deck I with a remote control unit which was not designed for double deck cassette decks, see page 8.

CONTROL OUT jack

Intermediary jack which outputs signals from the CONTROL IN jack of this unit to the input jack of another unit. Connect this jack to the CONTROL IN jack of another component compatible with Pioneer System Remote Control.

NOTE:

Be sure to connect both of the control cord's plugs securely to the CONTROL IN and CONTROL OUT jacks. Do not connect only one end of the cable.

CONNECTING THE POWER CORD

Insert the power cord of the cassette deck into the accessory AC outlet of your amplifier, or into a normal household outlet.

FRONT PANEL FACILITIES

The illustration shows model CT-W803RS.

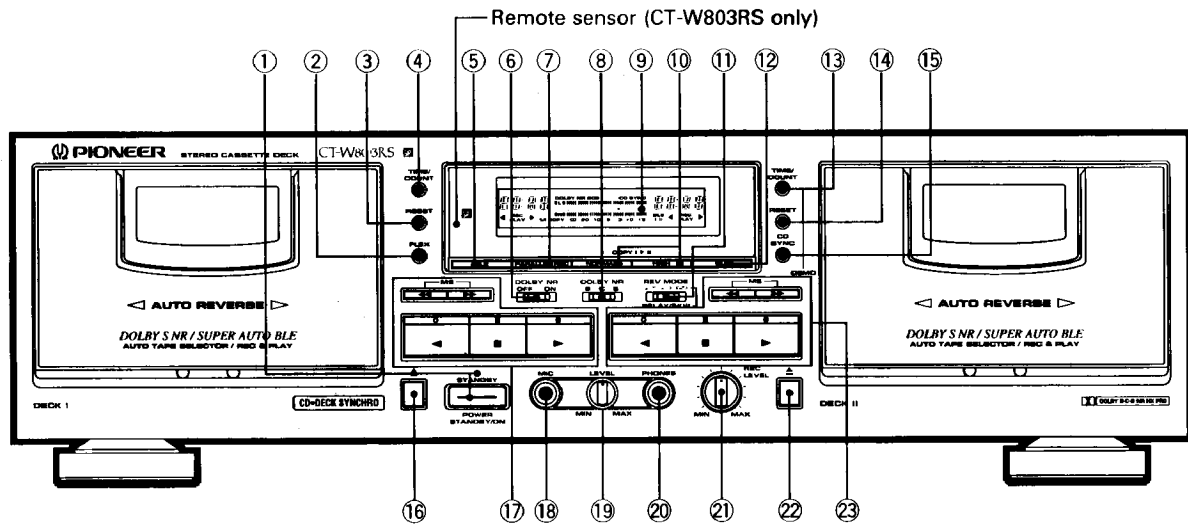

① POWER STANDBY/ON switch/indicator

The POWER switch activates the secondary transformer only. Even when the switch is in the STANDBY position, there will be a power flow to the deck's circuits as long as the power cord is connected to a power outlet.

② FLEX button

③ DECK I counter reset button (RESET)

④ DECK I counter mode button (TIME/COUNT)

⑤ DECK I BLE button (Except for CT-W603RS)

⑥ DOLBY NR ON/OFF switch

⑦ (CT-W803RS only) Parallel recording button (PARALLEL REC)

(CT-W603RS only) Synchro copy button (COPY I ► II)

Normal: Normal speed copy

⑧ DOLBY* NR switch (B/C/S)

*

- *Dolby noise reduction and HX Pro headroom extension manufactured under license from Dolby Laboratories Licensing Corporation. HX Pro originated by Bang & Olufsen.*
- *"DOLBY", the double-D symbol  and "HX PRO" are trademarks of Dolby Laboratories Licensing Corporation.*

⑨ Function display

⑩ (CT-W803RS/CT-W703RS) Synchro copy buttons (COPY I ► II)

NORMAL : Normal speed copy

HIGH : Double speed copy

(CT-W603RS only) Synchro copy button (COPY I ► II)

HIGH: Double speed copy

DECK II BLE button

⑪ Reverse mode switch (REV MODE RELAY/SKIP)

⑫ DECK II BLE button (CT-W803RS/CT-W703RS)

⑬ DECK II counter mode button (TIME/COUNT)

⑭ DECK II counter reset button (RESET)

⑮ CD•DECK SYNCHRO recording button (CD SYNC)

⑯ DECK I eject button (▲)

- If the tape is moving (recording, playback, tape winding, etc.), press the stop (■) button before pressing this button.

NOTE:

If the power is turned off while the tape is moving, the cassette door may remain locked. In this case, turn the power on before pressing the eject (▲) button.

⑰ Deck I operation buttons

◀ : Reverse playback

▶ : Forward playback

◀◀/MS : Fast reverse/music search

■ : Stop

▶▶/MS : Fast forward/music search

[Except for CT-W603RS]

○ : Recording mute

|| : Pause

● : Recording

⑱ Microphone jack (MIC) (CT-W803RS/CT-W703RS (U.S. and Canadian models only))

⑲ MIC LEVEL control (CT-W803RS/CT-W703RS (U.S. and Canadian models only))

⑳ Headphones jack (PHONES)

㉑ Recording level control (REC LEVEL)

㉒ DECK II eject button (▲)

- If the tape is moving (recording, playback, tape winding, etc.), press the stop (■) button before pressing this button.

NOTE:

If the power is turned off while the tape is moving, the cassette door may remain locked. In this case, turn the power on before pressing the eject (▲) button.

㉓ DECK II operation buttons

◀ : Reverse playback

▶ : Forward playback

◀◀/MS : Fast reverse/music search

■ : Stop

▶▶/MS : Fast forward/music search

○ : Recording mute

|| : Pause

● : Recording

FRONT PANEL FACILITIES

REVERSE MODE SWITCH (REV MODE)

There are three settings:

One way mode \Rightarrow position

When the switch is set to this position, playback or recording is performed on one side of the tape only. When the tape reaches the end of the side, it stops automatically (auto stop function).

Two way mode \Rightarrow position

When the switch is set to this position, playback or recording can be performed on both sides of the tape. When the tape reaches the end of the first (forward) side, its direction is automatically reversed, and playback or recording continues on the other (reverse) side. When it reaches the end of the reverse side, the tape stops automatically (auto stop function). If playback or recording is started from the reverse side, the tape will stop when it reaches the end of that side.

Repeat mode \Rightarrow position (RELAY/SKIP)

When the switch is set to this position for playback, both sides of the tape are played back repeatedly until the stop (■) button is pressed, or until the tape has been played completely 15 times (16 sides). If Deck I and II are loaded with tapes, each tape will be played 15 times using relay playback and then both decks will stop automatically. If the pause button is pressed to pause the tape, and then playback is restarted, the repeat mode starts over from the beginning, and will play the tape 15 times (16 sides).

When the switch is set to this position for recording, both sides are recorded and then the tape stops, as described above for the two way mode.

If Deck I and II are loaded with tapes, relay recording is used when the recording starts with Deck I.

OPERATION OF DECK I WITH A REMOTE CONTROL UNIT NOT DESIGNED FOR DOUBLE DECKS (system remote control) (Except for CT-W803RS)

Selecting DECK I

In order to operate DECK I with the remote control unit, adjust the unit as follows: With the power off, press and hold the stop (■) button of DECK I, and turn the power on. Continue to hold the stop (■) button for approximately five seconds. DECK I can now be operated using the remote control unit, but DECK II cannot.

Switching to DECK II

To restore remote control operation to DECK II, press the stop (■) button of DECK II while DECK II is in stop mode. DECK II can now be operated using the remote control unit. Remote control operation can be switched back and forth between decks by pressing the stop button of the desired DECK while it is in stop mode.

NOTE:

If a power failure or a sudden change in the power supply (caused by lightning, etc.) occurs, the unit is reset to its original state. Only DECK II can be operated by remote control. To restore operation to either deck, repeat the above procedure from the beginning.

AUTO BLE

With commercially available cassette tapes, sensitivity and frequency characteristics might differ slightly from one another, even though the same sound adjustment is set for them. To utilize tape characteristics to the maximum possible and realize an ideal recording which reproduces the source exactly, optimum recording level (sensitivity) and equalizer values must be set accordingly for each tape. In many conventional tape decks, standard values are fixed for standard tapes, thus nullifying the subtle differences between individual tapes. Perfect tuning by ear through use of fine adjustment controllers for bias and sensitivity is difficult and requires a lot of effort. It is especially difficult with a 2-head deck where the recording sound cannot be monitored.

The AUTO BLE on this unit automatically adjusts bias, level and equalizer by using a microprocessor to set the optimum recording characteristics accordingly for each tape.

FLEX (1/f) SYSTEM

- **FLEX System: Frequency Level Expander System**
This system automatically compensates high and low frequency level balance above 1 kHz according to the 1/f curve during playback.
Generally, envelope line of sound energy distribution of Hi-Fi sounds corresponds statistically with the 1/f curve.
The 1/f curve indicates that if the frequency doubles the level decreases by approx. half of the original frequency level.
- During playback, the FLEX system automatically compensates tapes with poor sound quality at high frequency levels of 1 kHz and over based on the appropriate auditory characteristics.
The FLEX system is designed to improve high frequency reproduction in the 10 kHz range by up to 12 dB, particularly in tapes with poor sound clarity and sound presence at high frequency levels. If the playback tape sound matches the 1/f curve, the FLEX system defeats compensation adjustment automatically.
- When you press the FLEX button to turn the FLEX system on and start playback, the 1/f indicator flash and compensation adjustment begins.
Compensation adjustment takes within approximately 3 seconds to complete, depending on the music source. The indicator change from a flashing to a steadily lit condition.
- When the FLEX system is engaged, each music selection is automatically adjusted during playback. System operation status is indicated by whether the 1/f indicator is lit.
Even when the FLEX system is turned on, the 1/f indicator is nullified automatically during all recording functions including: AUTO BLE tuning, CD•DECK synchro recording, and tape copying.

NOTE:

- *When a tape has been recorded at a high frequency level above the compensation level, the FLEX system operation is automatically defeated during playback.*

FUNCTION DISPLAY

The illustration shows model CT-W803RS.

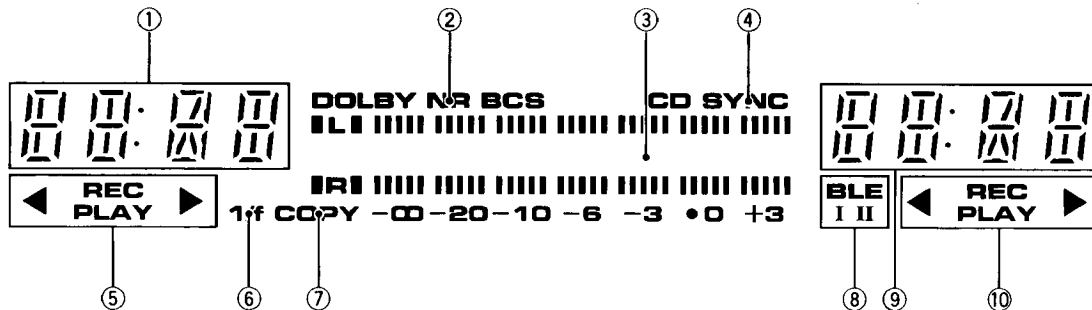

① **DECK I counter indicator**

Normally the tape counter or the time counter is displayed (see page 10). It flashes for 4 seconds after the power cord is connected to the power supply.

② **DOLBY NR B/C/S indicator**

③ **Level meter**

Holds peak for about 1.3 seconds.

The "•" mark beside the 0 dB mark indicates the Dolby NR systems standard level.

④ **CD DECK SYNCHRO indicator (CD SYNC)**

This indicator lights when the CD SYNC button is pressed and the operation starts.

⑤ **DECK I tape transport mode indicators**

- See page 10.

⑥ **FLEX (1/f) indicator**

This indicator lights when the FLEX button is pressed.

⑦ **Synchro copy indicator (COPY)**

Indicator lights steadily: Copying at normal speed.

Indicator flashes: Copying at twice the normal speed.

⑧ **AUTO BLE indicator**

- See page 15.

⑨ **DECK II counter indicator**

Normally the tape counter or time counter is displayed (see page 10). It flashes for 4 seconds after the power cord is connected to the power supply.

⑩ **DECK II tape transport mode indicators**

- See page 10.

DOLBY NR & DOLBY HX PRO

■ The B/C-type Dolby NR Systems

Dolby NR systems are designed to reduce the amount of tape hiss, mainly in the treble components. During recording, the high-pitched pianissimo sounds which are most characteristic of audible noise are boosted, and during playback, only these boosted sections are attenuated, so that tape sound is returned to normal. As a result, the noise is attenuated by an amount equal to the boosting in the treble range. The Dolby B-type NR system reduces noise in the treble range, cutting tape hiss and expanding the dynamic range. The Dolby C-type NR system is even more effective in reducing noise, as it reduces noise from the mid-range on.

■ Dolby S-type NR System

The Dolby S-type noise reduction system is effective at reducing noise not only in the treble and mid-range frequencies, but in the bass frequencies as well. In addition, maximum noise-reducing effect is demonstrated not only in non-recorded parts of the tape but in the recorded signal portions as well. The broad reduction of noise modulation (bridging noise), freedom from dynamic side-effects

in the audible spectrum (signal modulation) and reduction of decoding errors results in vastly improved sound quality.

NOTE:

When a tape has been recorded using the Dolby B-type, C-type or S-type NR system, set the DOLBY NR ON/OFF switch "ON" and then used the Dolby NR switch (B/C/S) to choose the system that was used during recording.

■ Dolby HX PRO Headroom Extension System

The DOLBY HX PRO system controls the bias current during recording and maintains it at the optimal level based on the amount of the high-frequency components in the music signal. It therefore provides excellent recording quality even when recording signals from digital sources, which contain a large amount of high-frequency components. To guarantee optimal results, the HX PRO system is activated automatically when recording begins. Since this system controls the quality of recording itself, the clarity of the sound will be maintained even when the tapes are played back on another cassette deck which does not contain the HX PRO Headroom Extension System.

FRONT PANEL FACILITIES

TAPE TRANSPORTATION MODE INDICATORS









<CT-W803RS>



These indicators display the current tape transport mode. The chart below shows the meaning of each of these indicators.







For both DECK I and II

 Flashing rapidly

	Forward mode	Reverse mode
Stop	▶	◀
Playback	▶ PLAY	◀ PLAY
Fast forward	▶ 	◀ 
Fast reverse	 ▶	◀ 
Forward music search	▶  PLAY	◀  PLAY
Reverse music search	 PLAY ▶	◀  PLAY

For both DECK I and II

(Except for DECK I of CT-W603RS)  Flashing slowly

	Forward mode	Reverse mode
Playback pause	▶  PLAY	◀  PLAY
Recording	▶ REC	◀ REC
Recording standby	▶  REC	◀  REC
Recording mute	▶  REC	◀  REC

TWO MODES COUNTER

Counter mode button (TIME/COUNT)

Press the button, and 2 modes change alternately.
Tape counter ↔ Time counter

■ Tape counter

Different counters are provided for DECK I and II. The number of a counter increases/decreases as a tape runs. It is convenient if you make a note of the recorded content and range of the counter while recording or playing back. You can then easily locate the desired track or where you lastly recorded to resume recording.

■ Time counter

- This indicates the elapsed time for recording or playback. This automatically starts counting when recording or playback starts. During fast-forwarding/rewinding, the counter automatically switches to a tape counter.
- The time counter indicates only time duration of recording or playback. When recording or playback is changed to fast-forwarding, rewinding, or music search, the counter switches from the time counter to tape counter. When the operation returns to recording or playback, the counter switches to the time counter.
- Tape counter indication

0000

- Time counter indication

00:00

Counter reset button (RESET)

Press this button to reset the tape counter to 0000, or to reset the time counter to 00:00.

Counter indicator during music search

0000

Normal tape counter indicator

P+01

Counter indicator during music search

Plus sign

P-01

Minus sign

- A plus sign (+) appears during music search in the forward direction.
- A minus sign (-) appears during music search in the reverse direction.

The last two digits of the counter indicator show the number of selections to be skipped. If three selections are to be skipped, for example, it shows "P+03" initially. The number then decreases by 1 each time a selection is skipped "P+02" → "P+01" etc.). When the deck resumes playback, the normal tape counter reappears.

REMOTE CONTROL OPERATION (CT-W803RS only)

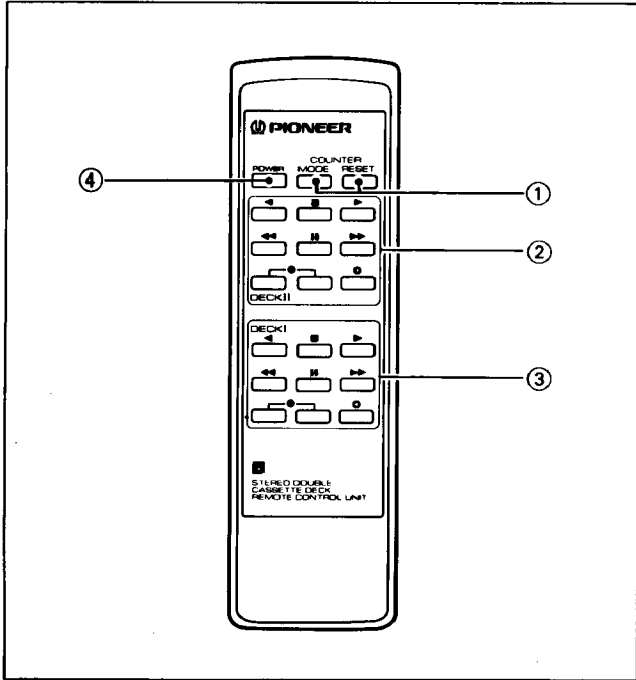

① Counter buttons (COUNTER)

To use DECK I or DECK II, press one of the relevant operation buttons and then press MODE or RESET.

MODE : Press to switch 2 modes (Tape counter/Time counter) alternately.

RESET : Press to return the counter reading to 0000.

② DECK II operation buttons

- : Recording mute
- : Press two buttons at the same time to set the recording standby mode.
- ◀ : Reverse playback
- ▶ : Forward playback
- ◀◀ : Fast reverse/music search
- ▶▶ : Fast forward/music search
- ⏸ : Pause
- : Stop

③ DECK I operation buttons

- : Recording mute
- : Press two buttons at the same time to set the recording standby mode.
- ◀ : Reverse playback
- ▶ : Forward playback
- ◀◀ : Fast reverse/music search
- ▶▶ : Fast forward/music search
- ⏸ : Pause
- : Stop

④ POWER button

REMOTE CONTROL OPERABLE RANGE

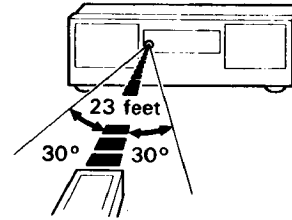

- The remote control can operate within the ranges of approx. 23 feet (7m) in distance from the deck, and 30 degrees to right or left from the position where the remote control points to the sensor on the deck vertically.
- The remote control may be disabled if any obstacle is placed between the deck and the remote control or if the remote control points to the sensor on the deck improperly.
- The deck may malfunction if it is used near equipment that generates infrared rays or near another remote control provided for equipment that generates infrared ray.
- Replace batteries when the operable ranges of the remote control drastically decrease.

REPLACING BATTERIES

Remove the battery compartment cover by sliding it away from the remote control unit. Place 2 dry batteries (AAA/IEC R03) following the polarity indication (+, -) inside the compartment, then return the cover.

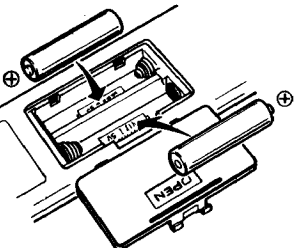

2 dry batteries
(AAA dry batteries
IEC R03 (UM-4))

Incorrect use of batteries may lead to leakage or rupture. Always be sure to follow these guidelines:

A.

Always insert batteries into the battery compartment correctly matching the positive + and negative - polarities, as indicated inside the compartment.

B.

Never mix new and used batteries.

C.

Batteries of the same size may have different voltages, depending on their type. Do not mix different types of batteries.

PLAYBACK

SINGLE PLAYBACK (Either DECK I or DECK II)

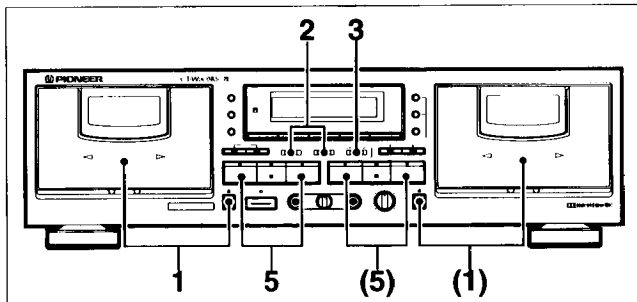

1. Load a prerecorded tape in DECK I or II.
2. Set the DOLBY NR ON/OFF switch and set the DOLBY NR switch.
 - Set the DOLBY ON/OFF switch to ON first, then select B, C or S-type NR with the DOLBY NR switch.
 - Always set the switch to the same position that was used for recording.
3. Set the REV MODE switch to or (see page 8).
4. Set the stereo amplifier for tape playback.
5. Press the playback (or) button of either DECK I or II.

To improve high frequency sound during playback in tapes with poor recordings

Press the FLEX button and playback the tape.

To stop playback temporarily (Except for DECK I of CT-W603RS)

Press the pause () button.

- To resume playback, either press the pause () button again, or press the playback (or) button.

To stop playback

Press the stop () button.

BLANK SKIP

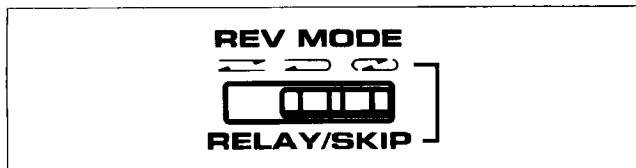

This function allows you to skip unrecorded portions of the tape during playback.

Set the REV MODE switch to .

- When this mode is selected, if the tape deck encounters an unrecorded portion of tape more than 15 seconds in length, it will fast forward the tape until it encounters another recorded portion, and resume playback from that point.

NOTE:

- When the REV MODE switch is set to position, relay mode will be engaged automatically.

RELAY PLAYBACK

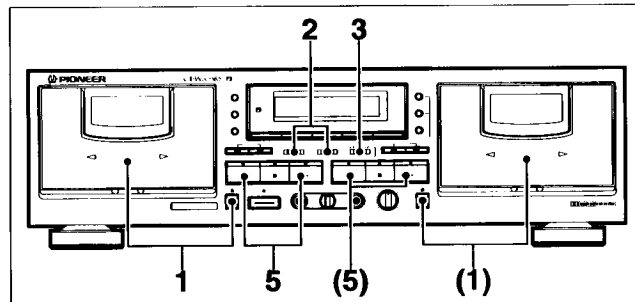

When relay playback mode is selected, continuous playback can be performed. When the tape in the first deck reaches its end and stops, the other deck will automatically begin playback.

1. Load prerecorded tapes in DECK I and DECK II.
2. Set the DOLBY NR ON/OFF switch and set the DOLBY NR switch.
 - Set the DOLBY NR ON/OFF switch to ON first, then select B, C or S type NR with the DOLBY NR switch.
 - Always set the switch to the same position that was used for recording.
3. Set the REV MODE switch to (see page 13).
4. Set the stereo amplifier for tape playback.
5. Press the playback (or) button of the deck that will start to play first.
 - When the tape in one deck ends, the other deck automatically begins playback.
 - To cancel relay playback, press the STOP () button.

To improve high frequency sound during playback in tapes with poor recordings

Press the FLEX button and playback the tape.

NOTES:

- Relay playback can begin from either DECK I or DECK II.
- The tape in the idle deck can be replaced during relay playback mode, allowing many tapes to be played back continuously. This is a convenient feature for parties, background music, etc.
- When this mode is selected, if the tape deck encounters an unrecorded portion of tape more than 15 seconds in length, it will fast forward the tape until it encounters another recorded portion, and resume playback from that point.

To stop playback temporarily (Except for DECK I of CT-W603RS)

Press the pause () button.

- To resume playback, either press the pause () button again, or press the playback (or) button.

To stop playback

Press the stop () button of the operating deck.

PLAYBACK SEQUENCE WITH REV MODE SWITCH SETTING

The playback sequence depends on the setting of the REV MODE switch and on which playback (▶ or ◀) button is pressed first. The playback sequence for each possible selection is shown below.

*2 In the repeat (↺) mode, relay playback is always begun from the forward direction.

- I ▶ : DECK I forward playback
- I ◀ : DECK I reverse playback
- II ▶ : DECK II forward playback
- II ◀ : DECK II reverse playback
- ∞ : Auto-reverse function
- : Relay

REV MODE switch	Starting playback button	Another deck mode	Playback sequence
↺	DECK I ▶	* 2	I▶∞I◀→II▶∞II◀→I▶∞I◀→... 15 times relay (32 sides playback)
↺	DECK I ◀	* 2	I◀→II▶∞II◀→I▶∞I◀→II▶... 15 times relay (31 sides playback)
↺	DECK II ▶	* 2	II▶∞II◀→I▶∞I◀→II▶∞II◀→... 15 times relay (32 sides playback)
↺	DECK II ◀	* 2	II◀→I▶∞I◀→II▶∞II◀→I▶... 15 times relay (31 sides playback)

MUSIC SEARCH

(Skipping forward or backward to playback a desired selection)

The music search function detects blanks (longer than 4 seconds) between selections, advances the tape in the forward or reverse direction to find the beginning of the desired selection and automatically starts playback.

It can find a selection located up to 15 selections before or after the present position.

During forward playback

When you wish to locate the next song or beyond, press the ▶▶ button as many times as the number of songs to be skipped. When you wish to listen to the song being currently played from the beginning, press the ◀◀ button once. To return to the previous song or beyond, press the ◀◀ button as many times as the number of songs to be skipped, plus one.

During reverse playback

When you wish to locate the next song or beyond, press the ◀◀ button as many times as the number of songs to be skipped. When you wish to listen to the song being currently played from the beginning, press the ▶▶ button once. To return to the previous song or before, press the ▶▶ button as many times as the number of songs to be skipped plus one.

From the stop mode

Press the playback (▶ or ◀) button to set the playback mode, then press the ◀◀ or ▶▶ button to perform music search as mentioned above.

- If the button is pressed more times than the number of selections recorded on the tape, forward search will continue on the opposite side, but reverse search will stop at the tape end.

NOTES:

In the following circumstances, the music search function may be unable to properly detect blanks between selections; this is not, however, a sign of unit malfunction.

- When using a tape with blanks between selections less than 4 seconds long.
- When listening to tapes with long low-level intervals, like classical music, or with sound breaks several seconds long within selections.
- When listening to recorded conferences or talk shows, where sound is intermittent.
- When using tapes with noise in the blanks between selections.

How selections are counted

When starting the music search operation from the middle of a selection and specifying "1st previous selection," playback will return to the beginning of the present selection. To return to selections further back, count one extra selection.

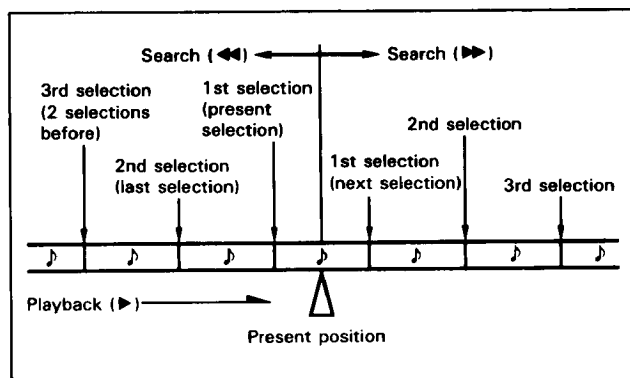

RECORDING

SINGLE RECORDING

CT-W803RS/CT-W703RS: both Deck I and II
CT-W603RS: Deck II only

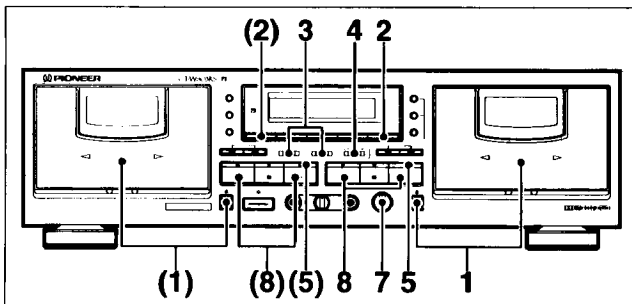

1. Load a tape for recording in DECK II (or I).
2. If you use AUTO BLE tuning, press the BLE button of DECK II (or I).

The II (or I) indicator will flash in the AUTO BLE display for about 30 seconds, after which it will light steadily (see page 15).
3. Set the DOLBY NR ON/OFF switch and set the DOLBY NR switch.
4. Set the REV MODE switch.
 - To record on one side only, set the switch to the position. To record on both sides, set the switch to the position.
5. Press the recording (●) button of DECK II (or I).
6. Prepare the audio source from which you wish to record. Turn on the stereo amplifier and prepare it for playback of the desired audio source.
7. Adjust the recording level. For details, see "ADJUSTING THE RECORDING LEVEL" below.
8. Press the playback (▶) or (◀) button or the pause (||) button of DECK II (or I) to begin recording.
 - When recording on both sides, press the ▶ button. If the ◀ button is pressed, recording will stop after only one side is recorded.

To stop recording temporarily

Press the pause (||) button.

- To resume recording, either press the pause (||) button again, or press the playback (▶) or (◀) button.

To stop recording

Press the stop (■) button.

Erasure prevention tabs

The recording (●) button does not work when the erasure prevention tabs of the loaded cassette tape have been broken off (See page 5). Do not press the recording (●) button with unreasonable force. When recording on both sides, make sure that both tabs are intact.

ADJUSTING THE RECORDING LEVEL

The adjustment of the recording level is the most important factor in achieving good recording results. A high level provides a good signal-to-noise ratio and dynamic range, but an excessively high level distorts the sound. If the level is set too low for fear of sound distortion, irritating tape hiss will mar the recording. The characteristics of tapes differ depending on the manufacturer and the type of tape. Set the REC LEVEL control so that the level meter's "-3 dB" indicator lights steadily most of the time. No harm will be done if the "0 dB" indicator lights momentarily at peaks. When

recording without Dolby NR, set the REC LEVEL control so that the "-3 dB" indicator lights, and the "0 dB" indicator lights occasionally at peaks.

NOTES:

- The optimal recording level may differ somewhat depending on the audio source and type of tape used. In order to obtain the best possible results, set the recording level after actual testing. Listen to your recordings, and adjust the level as necessary.
- The level meter may react differently during recording and playback of the same tape. This is due to differences in tape sensitivity, and creates no problem.
- If Deck I and II are loaded with tapes, relay recording will be performed from both the forward and the reverse sides of the tape in the Deck I, then both sides of the tape in Deck II. Be sure to check the position of the REV MODE switch before recording when you loaded tapes in both the Deck I and II.

RECORDING USING MICROPHONE (CT-W803RS/CT-W703RS only)

1. Connect the plug of the microphone to the MIC jack.
2. Follow the procedure for RECORDING given above.
 - To adjust mic recording level (step 7), use the mic level control (LEVEL) instead of the REC LEVEL control.
 - Set the REC LEVEL control to its minimum position when recording with a microphone only.

<Mixing recording>

Turn the REC LEVEL control up gradually after playing back music source during microphone recording.

Use both the REC LEVEL control and the MIC LEVEL control to adjust mixing level balance between microphone sound level and line source sound level.

NOTES:

- The MIC LEVEL control is only effective when a microphone is connected to the MIC jack.
- Be sure to disconnect the microphone plug from the MIC jack when not using the microphone for recording.
- Use a commercially available microphone when recording.

RECORDING MUTE

Use this function to create the 4.5-second blanks needed for proper operation of the music search function.

- Press the recording mute (□) button during recording and the deck will create a blank space by recording a section which contains no signal for approximately four seconds. The deck will then enter recording standby mode.
- To create a blank which is more than four seconds long, hold the button down for the desired length of time. When the button is released, the deck will enter recording standby mode.
- To resume recording, press the pause (||) button or the playback (▶) or (◀) button.

ERASING A TAPE

To erase the recorded contents of a tape, load the tape in DECK II (or I) and follow the procedure below.

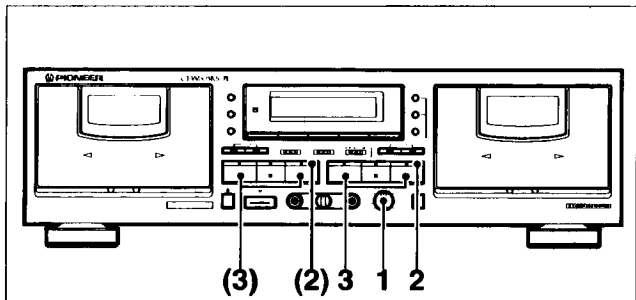

1. Set the REC LEVEL control to the MIN position.
2. Press the recording (●) button.
3. Press the playback (▶ or ◀) button or the pause (||) button.

AUTO BLE TUNING

When tuning DECK II (or I).

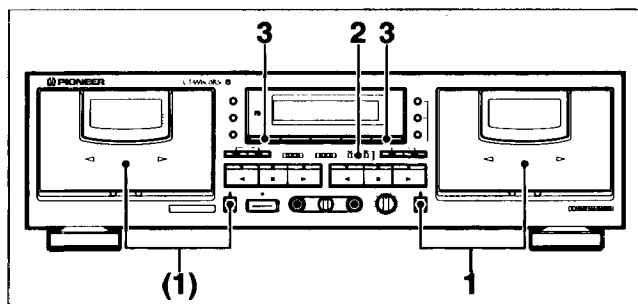

1. Load a tape in DECK II (or I).
 - The AUTO BLE does not work when the erasure prevention tabs of the loaded cassette tape have been broken off.
2. Set the REV MODE switch to ⤵ or ⤶.
3. Press the BLE button of DECK II (or I).

The II (or I) indicator will flash in the AUTO BLE display for about 30 seconds, after which it will light steadily.

The tape will be forwarded for approximately one second after pressing the start button so that recording will start from the recordable portion of the tape.

The operation is completed when the start position is resumed.

When tuning both decks in sequence (except for CT-W603RS)

1. Load tapes in both decks.
2. Set the REV MODE switch to ⤵ (RELAY/SKIP).
3. Press the BLE button of DECK I.

Auto BLE tuning starts from DECK I to DECK II.

 - If the BLE button of DECK II is pressed, the tuning will stop after only DECK II is tuned.
 - A tuning signal will be recorded on the cassette in the cassette deck when using AUTO BLE. The music and other information already recorded on this cassette will be erased from the point where tuning starts.

BLE operation	AUTO BLE indicator
DECK I tuning	BLE I ← Flashes
DECK I tuned	Lights → BLE I
DECK II tuning	Lights → BLE I II ← Flashes
DECK II tuned	Lights → BLE I II ← Lights

To stop AUTO BLE tuning

To cancel AUTO BLE tuning (e.g. must record urgently), press the stop (■) button.

To reset a tuned condition

Press the BLE button again.

Error display

- If the old tape, the tape end or the leader (white portion) immediately prior to the tape end is reached during AUTO BLE operation, tuning becomes impossible. That means recording will stop immediately and the counter indicator will display the following (flashing) message: "Err".
- In this case, press the BLE button again to reset, and record without AUTO BLE tuning.

The following illustrates the operation:

(Operation completed within approximately 30 seconds)
Each operation is shown on the left and right channel level meters during AUTO BLE tuning.

	Display
	Counter indicator
START	00:00 (Normal counter)
① ● Adjusting recording bias.	01:25
② ● Adjusting recording level (sensitivity).	LEVEL
③ ● Adjusting recording equalizer.	EQ
STOP END	00:00 (Return to normal counter)

RECORDING

RELAY RECORDING (CT-W803RS/ CT-W703RS) (from DECK I to DECK II)

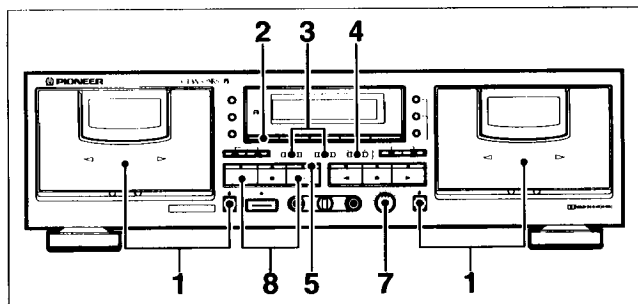

1. Load tapes for recording in DECK I and DECK II.
2. If you use AUTO BLE tuning, see page 15.
3. Set the DOLBY NR ON/OFF switch and set the DOLBY NR switch.
4. Set the REV MODE switch to .
5. Press the recording (●) button of DECK I.
6. Prepare the audio source from which you wish to record. Turn on the stereo amplifier and prepare it for playback of the desired audio source.
7. Adjust the recording level. For details, see page 14 "ADJUSTING THE RECORDING LEVEL".
8. Press the playback (▶ or ◀) button of DECK I to begin recording.
 - When recording on both sides, press the ▶ button. If the ◀ button is pressed, recording will stop after only one side is recorded.
 - When the tape in deck one ends, the other deck automatically begins recording.

NOTES:

- When erasure prevention tabs are broken, you cannot record even if you press the recording (●) button.
- You cannot relay-record from DECK II to DECK I.

To stop recording temporarily

Press the pause (||) button of the operating deck.

- To resume recording, either press the pause (||) button again, or press the playback (▶ or ◀) button.

To stop recording

Press the stop (■) button of the operating deck.





RELAY RECORDING SEQUENCE WITH REVERSE MODE SWITCH SETTING

The recording sequence depends on the setting of the REV MODE switch and on which playback (▶ or ◀) button is pressed first.

The recording sequence for each possible selection is shown below.



- Relay recording always begins from the direction indicated by the tape transport indicator (▶ or ◀). To change this direction, press the desired playback (▶ or ◀) button, then immediately press the stop (■) button.

- I▶ : DECK I forward recording
 I◀ : DECK I reverse recording
 II▶ : DECK II forward recording
 II◀ : DECK II reverse recording
 ∞ : Auto-reverse function
 → : Relay

REV MODE switch	Starting playback button	Another deck mode	Recording sequence
	DECK I ▶	II▶	I▶ ∞ I◀ → II▶ ∞ II◀
	DECK I ▶	II◀	I▶ ∞ I◀ → II◀
	DECK I ◀	II▶	I◀ → II▶ ∞ II◀
	DECK I ◀	II◀	I◀ → II◀

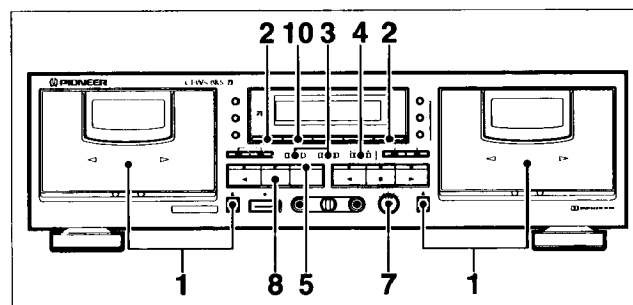
PARALLEL RECORDING (CT-W803RS only)



1. Load tapes for recording in DECK I and DECK II.
2. If you use AUTO BLE tuning, see page 15.
3. Set the type of the DOLBY NR ON/OFF switch and set the DOLBY NR switch.
4. Set the REV MODE switch.
 - To record on one side only, set the switch to the  position. To record on both sides, set the switch to either the  or the  position.
5. Press the recording (●) button of DECK I.
6. Prepare the audio source from which you wish to record. Turn on the stereo amplifier and prepare it for playback of the desired audio source.
7. Adjust the recording level. For details, see page 14 "ADJUSTING THE RECORDING LEVEL".
8. Press the stop (●) button of DECK I.
9. Set the tape transportation direction for recording

Parallel recording is always begun from the direction indicated by the tape transport indicator (▶ or ◀). To change this direction, press the desired playback button (▶ or ◀), then immediately press the stop (■) button.
10. Press PARALLEL REC button.

Both DECK I and DECK II start recording the same sound source.

To stop recording temporarily

Press the pause (■) button on either deck (both decks pause).

- To resume recording, press the pause (■) button again.

To stop recording

Press the stop (■) button on either deck (both decks stop).

NOTES:

- When either tape reaches the end, parallel recording is completed. Therefore, use the same length tapes for both decks.
- If the erasure prevention tabs are broken, you cannot parallel-record even if you press PARALLEL REC button.
- Always start recording from the forward direction (FWD) for both sides recording. Otherwise, the tape automatically stops when it reaches the end in the reverse direction.
- Since the recording level adjustment affects both decks equally, it is recommended that the same type of cassette tapes be used.
- If you press the recording mute (○) button, both decks enter the recording mute mode (see page 14).

CD•DECK SYNCHRO RECORDING

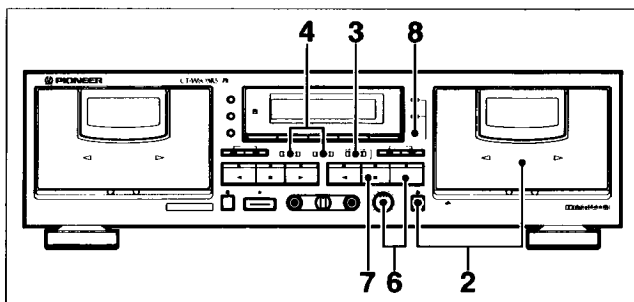

If the CD player has a program function to determine the order of playback, program the CD player before beginning this operation.

1. Load a compact disc in the CD player.
2. Load the cassette for recording.
 - Rewind the tape to the desired starting position.
3. Set the REV MODE switch.
 - To record on one side only, set the switch to the \rightleftarrows position. To record on both sides, set the switch to the \rightleftharpoons position.
4. Set the DOLBY NR ON/OFF switch and set the DOLBY NR switch.
5. Press the play button of the CD player.
6. Adjust the recording level.
 - See page 14.
7. Press the stop (■) button of both the cassette deck and the CD player.
 - Unless both this deck and the CD player are in stop mode, synchro recording cannot be performed.
8. Press the CD SYNC button.
 - The cassette deck begins recording, and the CD player begins playback.

ABOUT RECORDING

You can use either DECK I or II for synchro recording (CT-W803RS/CT-W703RS)

You can use the Deck II for synchro recording (CT-W603RS only).

You can also operate relay recording with the CD player (CT-W803RS/CT-W703RS).

When the compact disc finishes playing:

The CD player enters stop mode and the cassette deck enters recording standby mode. Change the disc and press the play button of the CD player to resume recording. If the CD player does not resume play within one minute, the cassette deck enters stop mode.

When the CD player changes discs (twin tray or multi-play disc CD players):

The cassette deck enters recording standby mode, and resumes recording when the CD player begins playing the next disc. A four-second blank space is automatically created between tracks.

When the end of the tape is reached while the CD player is still playing:

The CD player returns to the beginning of the currently playing selection and then enters the pause mode. To resume recording, load another tape and check the tape running indicator to ensure that the tape is moving in the desired direction. If not, press the playback (▶ or ◀) button to change the tape direction, then immediately press the stop (■) button. The tape running indicator will change direction. Synchro recording can be resumed by pressing the CD SYNC button again. (The CD SYNC button should be pressed within 1 minute. If more than 1 minute elapses, the CD player will enter stop mode.)

If the auto-reverse function operates while the CD is still playing:

The CD player returns to the beginning of the current selection and enters pause mode.

A ten-second blank space is automatically created on the reverse side, then the CD player resumes playback and the deck resumes recording.

[CT-W803RS/CT-W703RS only.]

■ Relay recording (set the REV MODE switch to \rightleftarrows (RELAY/SKIP).)

- After DECK I stops, DECK II starts to record.
- If the CD player stops playback while DECK I is recording, DECK I stops and DECK II starts recording from the beginning of the CD (if the CD player is either a twin or multi CD player, DECK II will record the next CD).

NOTE:

During relay recording, DECK I stops when CDs are changed as well as when the tape in DECK I reaches the end, and DECK II starts recording.

- A twin CD player stands for a twin-tray compact disc player.
- A multi CD player stands for a magazine compact disc player (sequential playback of 6 compact-disc player).

NOTES:

- The CD•DECK SYNCHRO function only works with PIONEER CD players equipped with the CD•DECK SYNCHRO function.
- Be sure to connect the deck and the CD player with the CD•DECK SYNCHRO control cord.
- Although recording begins when the CD SYNC button is pressed, the CD player does not start playback until the button is released. This function can be used to advance the tape past the leader section, or to create a blank section on the tape.
- Only PIONEER CD players equipped with a CD•DECK SYNCHRO jack can be used for CD•DECK SYNCHRO recording. Any type of CD player which meets these requirements, including twin-tray or multiplay models, can be used.

TAPE COPYING (from DECK I to DECK II)

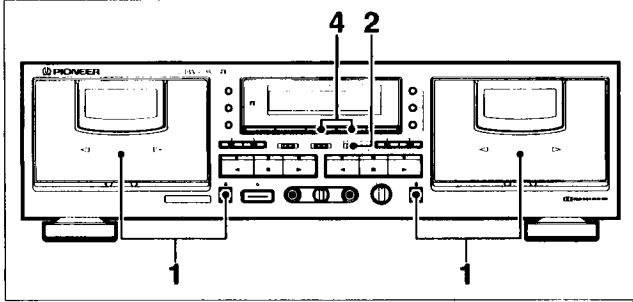

- The tape copying function permits you to copy the contents of a tape from DECK I to DECK II.
 - The SYNCHRO COPY button is used to select either normal speed copying, or high-speed copying (copying at twice the normal playback speed).
1. Load a tape for playback into DECK I and a tape for recording into DECK II.
 2. Set the REV MODE switch.
 3. Set the tape transport direction.
 - Tape copying is always performed in the direction indicated by the tape transport indicator (▶ or ◀). To change this direction, press the desired playback button (▶ or ◀), then immediately press the stop (■) button.
 4. Press the SYNCHRO COPY button to select either NORMAL or HIGH speed.
 - NORMAL: Tape copying at normal speed allows listen during playback (COPY indicator lights steadily).
 - HIGH: Tape copying at twice the normal speed (COPY indicator flashes). Playback will still audible.

To stop copying

Press the stop (■) button of either deck. Both decks will stop.

NOTES:

- The tape in DECK II will be copied in the same type of the DOLBY NR switch as DECK I's tape, regardless of its own setting. When listening to the copied tape, set the type of the DOLBY NR switch on DECK I.
- If a nearby television set is on while high-speed copying is being performed, a high-pitched interference sound may be heard on the tape. In this case, either use the normal speed copying function, or turn off the television.
- During high-speed copying, none of the operation buttons will function except for the stop (■) button.
- During normal speed copying, the recording mute (○) and pause (■) buttons of deck II also function.
- Tape copying is cancelled when either of the two tapes reaches the end. Therefore, it is advisable to use tapes of the same length.
- The sound quality of the copied tape will be somewhat less than the original. Therefore when making more than one copy, always record from the original tape (do not make a copy of a copy).
- The recording level adjustment is not necessary during tape copying.

TROUBLESHOOTING

Incorrect operations are often mistaken for trouble and malfunctions. If you think that there is something wrong with this component, check the points below. Sometimes the trouble may lie in another component. Investigate the other components and electrical appliances being used. If the trouble cannot be rectified even after exercising the checks listed below, ask your nearest PIONEER authorized service center or your dealer to carry out repair work.

Symptom	Cause	Remedy
POWER		
Cannot turn power on.	<ul style="list-style-type: none"> The power plug is removed. The component (stereo amplifier, audio timer, etc.) to which the power cord is connected is off. 	<ul style="list-style-type: none"> Insert the power plug correctly. Turn the stereo amplifier or audio timer on.
CASSETTE DOOR		
The door does not open.	<ul style="list-style-type: none"> The deck is not in stop mode (tape is moving). Power was turned off with the tape moving. 	<ul style="list-style-type: none"> Press the stop (■) button. Turn power on.
The door does not close.	<ul style="list-style-type: none"> The cassette is not properly loaded. 	<ul style="list-style-type: none"> Reinsert the cassette.
PLAYBACK		
Immediately stops.	<ul style="list-style-type: none"> The tape is completely wound. The tape is slack. 	<ul style="list-style-type: none"> Play back in the opposite direction. Rewind the tape. Take up slack (see page 5).
The level meter does not work.	<ul style="list-style-type: none"> The tape is not recorded. The tape head is dirty. 	<ul style="list-style-type: none"> Replace the tape with a recorded one. Clean the heads (see page 4).
No sound	<ul style="list-style-type: none"> The amplifier input selector is not correctly set. The amplifier volume level setting is too low. Connection problems (wrong connection, cord removed, poor contact, broken wire.) 	<ul style="list-style-type: none"> Set the amplifier input selector correctly. Turn the amplifier volume control up. Connect securely (see page 6).
RECORDING		
The recording indicator does not light up.	<ul style="list-style-type: none"> The cassette erasure prevention tabs are broken. 	<ul style="list-style-type: none"> Replace the cassette with one whose tabs are intact. Cover the hole over the tab (see page 5).
The level meter does not work.	<ul style="list-style-type: none"> REC LEVEL control is set too low. The amplifier is not delivering a recording signal (from the tuner, CD player, etc.). Wrong connection, connection cord removed, poor contact, broken wire. 	<ul style="list-style-type: none"> Turn REC LEVEL control up (see page 14). Set the amplifier recording output selector correctly. Check connections (see page 6).
Immediately stops.	<ul style="list-style-type: none"> The tape is completely wound up. The tape is slack. 	<ul style="list-style-type: none"> Record in the opposite direction. Rewind the tape. Take up slack (see page 5).
Cannot record	<ul style="list-style-type: none"> The head is dirty. 	<ul style="list-style-type: none"> Clean the head (see page 4).

TROUBLESHOOTING

Symptom	Cause	Remedy
POOR SOUND QUALITY		
Unstable or interrupted sound	<ul style="list-style-type: none"> • The head, pinch rollers and capstans are dirty. • The tape is not uniformly wound. 	<ul style="list-style-type: none"> • Clean (see page 4). • Completely fast-forward or rewind the tape.
No high frequencies	<ul style="list-style-type: none"> • A tape recorded without Dolby NR is being played back with DOLBY NR switch in the B/C or S position. • The head is dirty. 	<ul style="list-style-type: none"> • Set DOLBY NR ON/OFF switch to OFF. • Clean the head (see page 4).
High frequencies are emphasized.	<ul style="list-style-type: none"> • A Dolby NR-encoded tape is being played back with DOLBY NR ON/OFF switch in the OFF position. 	<ul style="list-style-type: none"> • Set the DOLBY NR ON/OFF switch to ON first, then set the DOLBY NR switch to the same position used for recording.
Sound from previous recordings remains when rerecording a tape.	<ul style="list-style-type: none"> • The head is dirty. 	<ul style="list-style-type: none"> • Clean the head (see page 4).
The sound is distorted.	<ul style="list-style-type: none"> • Recording level is too high. • The recorded signal itself is distorted. • The head is dirty. 	<ul style="list-style-type: none"> • Turn REC LEVEL control down when recording (see page 14). • Replace the cassette. • Clean the head (see page 4).
Too much noise	<ul style="list-style-type: none"> • Hi noise tape is being used. • Incomplete insertion of a connection cord, poor contact. • Recording level is too low. • The head is dirty. • The head is magnetized. 	<ul style="list-style-type: none"> • Replace the cassette. • Check connections (see page 6). • Turn REC LEVEL control up when recording (see page 14). • Clean the head (see page 4). • Demagnetize with a head demagnetizer.
OTHERS		
The music search function does not work.	<ul style="list-style-type: none"> • Blanks between selections are less than 4 seconds long. 	<ul style="list-style-type: none"> • Use a tape with blanks more than 4 seconds long.
Cannot use the remote control system (Except for CT-W803RS).	<ul style="list-style-type: none"> • The control cord is not connected. 	<ul style="list-style-type: none"> • Connect the control cord (see page 6).
CD•DECK SYNCHRO is disabled.	<ul style="list-style-type: none"> • The components are not connected properly. • The cassette erasure prevention tabs are broken. 	<ul style="list-style-type: none"> • Connect them properly (see page 6). • Replace the cassette with one whose tabs are intact.
The CD SYNC indicator is off during CD•DECK SYNCHRO recording.	<ul style="list-style-type: none"> • The tape ran out during the CD•DECK SYNCHRO mode. • After the deck entered recording standby mode, more than 1 minute elapsed before the CD player resumed playback. 	<ul style="list-style-type: none"> • Replace the tape with a longer one. • Change the disc and press the CD SYNC button again.

POWER-CORD CAUTION

Handle the power cord by the plug. Do not pull out the plug by tugging the cord and never touch the power cord when your hands are wet as this could cause a short circuit or electric shock. Do not place the unit, a piece of furniture, etc., on the power cord, or pinch the cord. Never make a knot in the cord or tie it with other cords. The power cords should be routed such that they are not likely to be stepped on. A damaged power cord can cause fire or give you an electrical shock. Check the power cord once in a while. When you find it damaged, ask your nearest PIONEER authorized service center or your dealer for a replacement.

SPECIFICATIONS

System	4-track, 2-channel stereo
Heads	
CT-W803RS/CT-W703RS	"Hard Permalloy" recording/playback head × 2 "Ferrite" erasing head × 2
CT-W603RS.....	"Hard Permalloy" recording/playback head × 1 "Hard Permalloy" playback head × 1 "Ferrite" erasing head × 1
Motor.....	DC servo motor × 2
Wow and Flutter.....	0.1% (WRMS)
Fast Winding Time	Approximately 100 seconds (C-60 tape)

Frequency Response	
–20 dB recording:	
CT-W803RS/CT-W703RS	
TYPE IV (Metal) tape.....	20 to 20,000 Hz
TYPE II (High/CrO ₂) tape	20 to 19,000 Hz
TYPE I (Normal) tape	20 to 18,000 Hz
CT-W603RS	
TYPE IV (Metal) tape.....	20 to 16,500 Hz
TYPE II (High/CrO ₂) tape	20 to 16,000 Hz
TYPE I (Normal) tape	20 to 16,000 Hz
Signal-to-Noise Ratio	
Dolby NR OFF.....	More than 57 dB
Noise Reduction Effect	
Dolby B-type NR ON.....	More than 10 dB (at 5 kHz)
Dolby C-type NR ON.....	More than 19 dB (at 5 kHz)
Dolby S-type NR ON.....	More than 22 dB (at 5 kHz)
Harmonic Distortion.....	No more than 0.8% (at –4 dB: 160 nwb/m)

Input (Sensitivity)	
LINE (INPUT)	100 mV (Input impedance 68 kΩ)
MIC	0.63 mV (CT-W803RS/CT-W703RS: U.S. and Canadian model only)
Output (Reference level)	
LINE (OUTPUT)	0.5 V (Output impedance 1.9 kΩ)
Headphones	0.63 mW (Load impedance 8 Ω)

Subfunctions

- Super AUTO BLE tuning system (CT-W803RS/CT-W703RS)
- AUTO BLE tuning system (CT-W603RS)
- Automatic reverse
- Double recording/playback reverse (CT-W803RS/CT-W703RS)
- DOLBY HX PRO recording function
- DOLBY B/C/S type NR
- Relay recording (CT-W803RS/CT-W703RS)
- Parallel recording (CT-W803RS only)
- Music search over ±15 selections
- Synchronized copy start
- High-speed and normal-speed copy (Deck I → Deck II)
- Relay playback/blank skip
- CD•DECK SYNCHRO recording capability
- Peak level meter with peak-hold function
- MPX FILTER (Interlocks with DOLBY NR switch)
(CT-W803RS/CT-W703RS)
- Automatic space recording mute
- Automatic tape selector
-  System remote control available
(CT-W703RS/CT-W603RS only)
- 2-mode electronic 4-digit twin tape counter
- Microphone jack
(CT-W803RS/CT-W703RS: U.S. and Canadian model only)
- Headphone jack
- Wireless remote control operation
(CT-W803RS: UK model only)
- Flex system

Miscellaneous

Power Requirements	
U.S., Canadian models.....	AC 120 V, 60 Hz
U.K. model	AC 230–240 Volts~, 50/60 Hz
Power Consumption	
CT-W803RS	24W
CT-W703RS/CT-W603RS	19W
Dimensions	420(W) × 125(H) × 250(D) mm 16-1/2 (W)×4-7/8 (H)×9-13/16 (D) in.
Weight (without package)	
CT-W803RS/CT-W703RS	4.2 kg (9 lb 4 oz.)
CT-W603RS	4.1 kg (9 lb 2 oz.)

Accessories

Operating instructions	1
Connection cord with pin plugs	2
 Remote control cord (CT-W703RS/CT-W603RS only)	1
CD•DECK SYNCHRO control cord.....	1
Remote control unit (CT-W803RS: UK model only)	1
Dry cell batteries (size AAA IEC R03/UM-4) (CT-W803RS: UK model only).....	2

NOTE:

Specifications and design subject to possible modifications without notice, due to improvements.

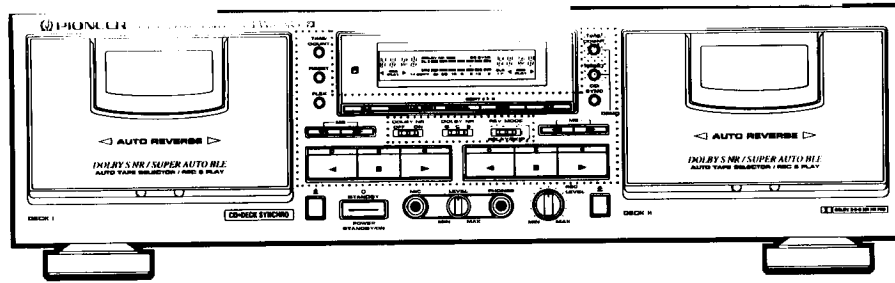

About the Demo mode

Press the DECK II counter reset button (RESET) and the DECK II counter mode button (TIME/COUNT) simultaneously to set the demonstration mode. To cancel the demonstration mode, press any one of the buttons enclosed in the dotted lines above.

Published by Pioneer Electronic Corporation.
 Copyright © 1993 Pioneer Electronic Corporation.
 All rights reserved.

PIONEER ELECTRONIC CORPORATION 4-1, Meguro 1-Chome, Meguro-ku, Tokyo 153, Japan
PIONEER ELECTRONICS [USA] INC. 2265 East 220th Street, Long Beach, California 90810, U.S.A.
 P.O. BOX 1720, Long Beach, California 90801, U.S.A.
PIONEER ELECTRONICS OF CANADA, INC. 300 Allstate Parkway Markham, Ontario L3R 0P2, Canada
PIONEER ELECTRONIC [EUROPE] N.V. Haven 1087 Keetberglaan 1, 9120 Melsele, Belgium, TEL: 03/750.05.11
PIONEER ELECTRONICS AUSTRALIA PTY. LTD. 178-184 Boundary Road, Braeside, Victoria 3195, Australia, TEL: [03] 580-9911

Free Manuals Download Website

<http://myh66.com>

<http://usermanuals.us>

<http://www.somanuals.com>

<http://www.4manuals.cc>

<http://www.manual-lib.com>

<http://www.404manual.com>

<http://www.luxmanual.com>

<http://aubethermostatmanual.com>

Golf course search by state

<http://golfingnear.com>

Email search by domain

<http://emailbydomain.com>

Auto manuals search

<http://auto.somanuals.com>

TV manuals search

<http://tv.somanuals.com>