



**Multi-CD control High power cassette player
with RDS tuner**

Operation Manual

KEH-P2830R

KEH-P2800R

Pioneer

| | | | |
|---|-----------|--|-----------|
| Installation | 3 | Using RDS Functions | 20 |
| Installation with the rubber bush | 3 | What is RDS? | 20 |
| Removing the Unit | 3 | Program Service Name Display | 20 |
| Connection Diagram | 4 | AF Function | 21 |
| Connecting the Units | 6 | PI Seek Function | 22 |
| Key Finder | 7 | REG Function | 22 |
| Before Using This Product | 8 | TA Function | 23 |
| About This Product | 8 | PTY Function | 25 |
| About This Manual | 8 | Using the Cassette Player | 28 |
| Precaution | 8 | Basic Operation of Cassette Player | 28 |
| In Case of Trouble | 8 | Fast Forward/Rewind | 29 |
| Detaching and Replacing the | | Entering the Function Menu | 29 |
| Front Panel | 9 | Radio Intercept | 30 |
| Theft Protection | 9 | Cassette Player and Care | 31 |
| Initial Setting Menu | 10 | Precaution | 31 |
| Entering the Initial Setting Menu | 10 | Cleaning the Head | 31 |
| Changing the FM Tuning Step | 10 | Audio Adjustment | 32 |
| Switching the Auto PI Seek | 11 | Selecting the Mode | 32 |
| Basic Operation | 12 | Balance Adjustment | 32 |
| Switching Power On | 12 | Bass/Treble Adjustment | 33 |
| Switching Power Off | 12 | Loudness Adjustment | 33 |
| Tuner Operation | 13 | Other Functions | 34 |
| Basic Operation of Tuner | 13 | Time Display/Setting | 34 |
| AF Function Switching | 14 | Specifications | 35 |
| Entering the Function Menu | 15 | | |
| Local Seek Tuning | 16 | | |
| Preset Tuning | 16 | | |
| BSM (Best Stations Memory) | 17 | | |
| Preset Memory | 17 | | |
| Recalling Preset Stations | 18 | | |
| Using the Programmable Button | 18 | | |

Installation

Note:

- Before finally installing the unit, connect the wiring temporarily, making sure it is all connected up properly, and the unit and the system work properly.
- Use only the parts included with the unit to ensure proper installation. The use of unauthorized parts can cause malfunctions.
- Consult with your nearest dealer if installation requires the drilling of holes or other modifications of the vehicle.
- Install the unit where it does not get in the driver's way and cannot injure the passenger if there is a sudden stop, like an emergency stop.
- If installation angle exceeds 30° from horizontal, the unit might not give its optimum performance.

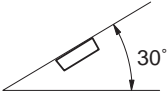

Installation with the rubber bush

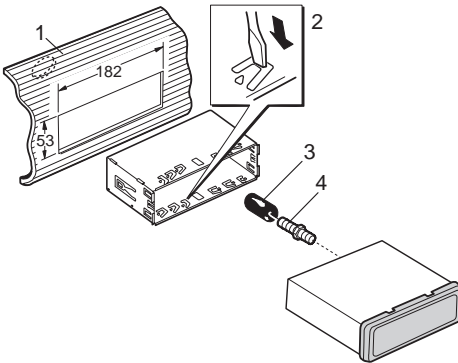

1. Dashboard
2. Holder

After inserting the holder into the dashboard, then select the appropriate tabs according to the thickness of the dashboard material and bend them.

(Install as firmly as possible using the top and the bottom tabs. To secure, bend the tabs 90 degrees.)

3. Rubber bush
4. Screw

Removing the Unit

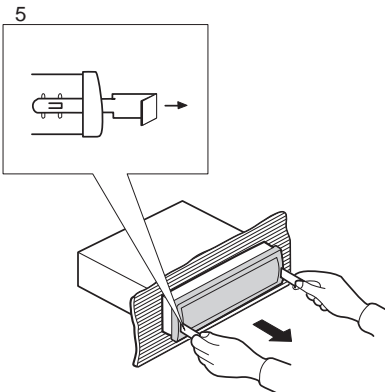

5. Insert the supplied extraction keys into the unit, as shown in the figure, until they click into place. Keeping the keys pressed against the sides of the unit, pull the unit out.

Connection Diagram

This product conforms to new cord colors.

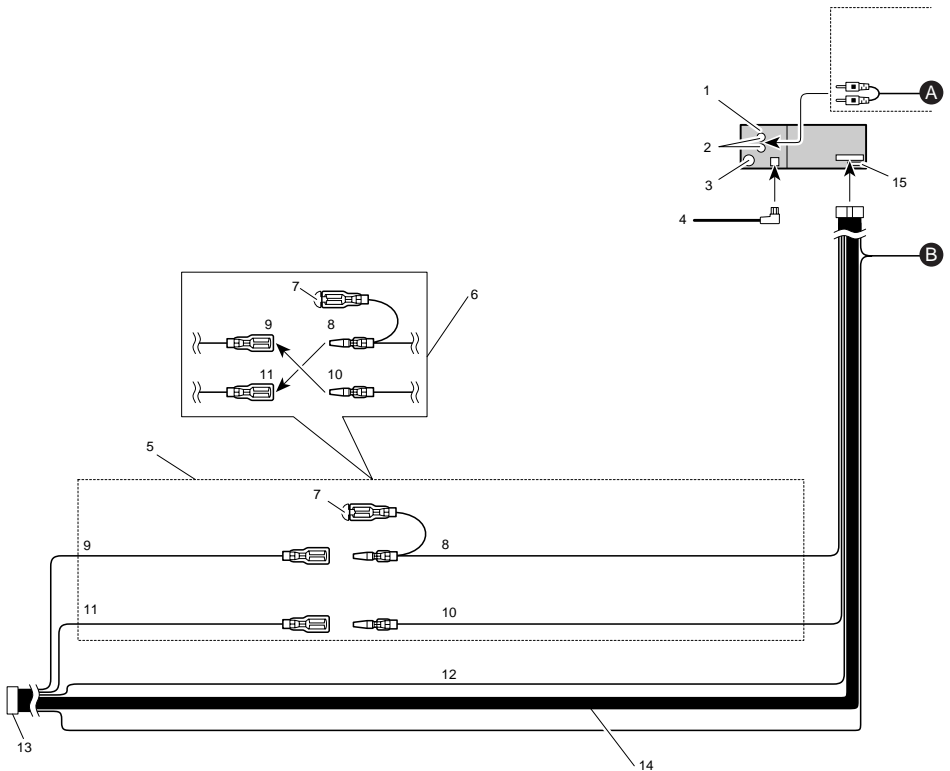

1. This unit
2. Rear output
3. Antenna jack
4. Multi-CD player (sold separately)
5. Connect leads of the same color to each other.
6. **Note:**
 - Depending on the kind of vehicle, the function of 9 and 11 may be different. If this is the case, be sure to connect 8 to 11 and 9 to 10.
 - When the power cord of a component such as a Multi-CD Player is connected to this unit's power cord, check that 9 and 11 (Back-up or Accessory) are operating correctly, and that connections are correct.
7. Cap
8. Yellow
To terminal always supplied with power regardless of ignition switch position.
9. Yellow
Back-up (or accessory)
10. Red
To electric terminal controlled by ignition switch (12 V DC) ON/OFF.
11. Red
Accessory (or Back-up)
12. Black (ground)
To vehicle (metal) body.
13. ISO connector
Note:
 - In some vehicles, the ISO connector may be divided into two. If this is the case, be sure to connect to both connectors.

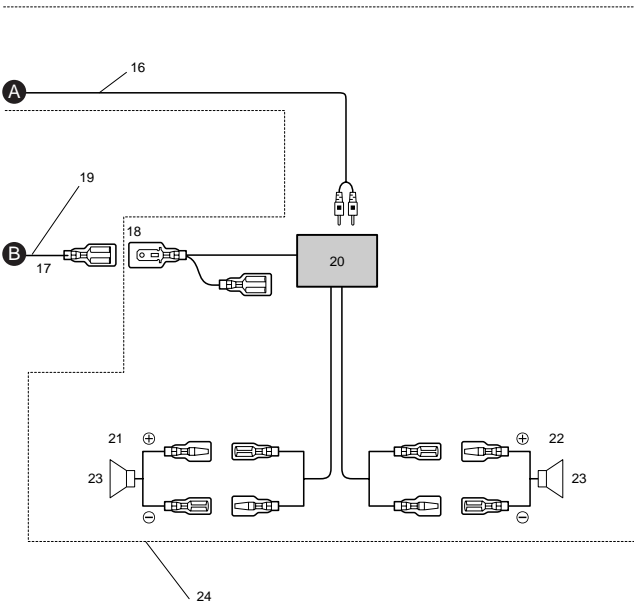

⚠ CAUTION

Cords for this product and those for other products may be different colors even if they have the same function. When connecting this product to another product, refer to the supplied Installation manuals of both products and

14. Speaker leads

- White: Front left ⊕
- White/black: Front left ⊖
- Gray: Front right ⊕
- Gray/black: Front right ⊖
- Green: Rear left ⊕
- Green/black: Rear left ⊖
- Violet: Rear right ⊕
- Violet/black: Rear right ⊖

15. Fuse

16. Connecting cords with RCA pin plugs (sold separately).

17. Blue/white

18. System remote control

19. To system control terminal of the power amp or Auto-antenna relay control terminal.
(Max. 300 mA 12 V DC.)

20. Power amp (sold separately)

21. Left speaker

22. Right speaker

23. Rear

24. Use this for connections when you have the separately available amplifier.

Connecting the Units

Note:

- This unit is for vehicles with a 12-volt battery and negative grounding. Before installing it in a recreational vehicle, truck, or bus, check the battery voltage.
- To avoid shorts in the electrical system, be sure to disconnect the ⊖ battery cable before beginning installation.
- Secure the wiring with cable clamps or adhesive tape. To protect the wiring, wrap adhesive tape around them where they lie against metal parts.
- Route and secure all wiring so it cannot touch any moving parts, such as the gear shift, handbrake and seat rails. Do not route wiring in places that get hot, such as near the heater outlet. If the insulation of the wiring melts or gets torn, there is a danger of the wiring short-circuiting to the vehicle body.
- Don't pass the yellow lead through a hole into the engine compartment to connect to the battery. This will damage the lead insulation and cause a very dangerous short.
- Do not shorten any leads. If you do, the protection circuit may fail to work when it should.
- Never feed power to other equipment by cutting the insulation of the power supply lead of the unit and tapping into the lead. The current capacity of the lead will be exceeded, causing overheating.
- When replacing fuse, be sure to use only fuse of the rating prescribed on this unit.
- Since a unique BPTL circuit is employed, never wire so the speaker leads are directly grounded or the left and right ⊖ speaker leads are common.
- The black lead is ground. Please ground this lead separately from the ground of high-current products such as power amps.

If you ground the products together and the ground becomes detached, there is a risk of damage to the products or fire.

- Speakers connected to this unit must be high-power types possessing minimum rating of 40 W and impedance of 4 to 8 ohms. Connecting speakers with output and/or impedance values other than those noted here can damage the speakers.
- When an external power amp is being used with this system, be sure not to connect the blue/white lead to the amp's power terminal. Likewise, do not connect the blue/white lead to the power terminal of the auto-antenna. Such connection could cause excessive current drain and malfunction.
- To prevent incorrect connection, the input side of the IP-BUS connector is blue, and the output side is black. Connect the connectors of the same colors correctly.
- If this unit is installed in a vehicle that does not have an ACC (accessory) position on the ignition switch, the red lead of the unit should be connected to a terminal coupled with ignition switch ON/OFF operations. If this is not done, the vehicle battery may be drained when you are away from the vehicle for several hours.



ACC position



No ACC position

Key Finder

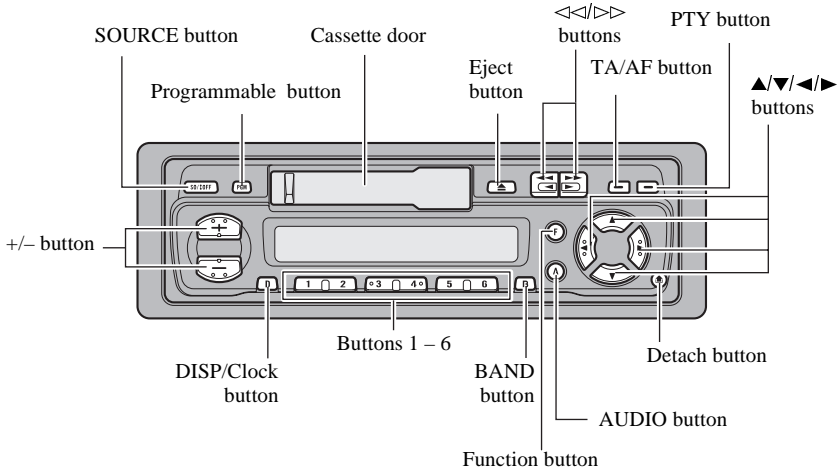

About This Product

- This product complies with the EMC Directives (89/336/EEC, 92/31/EEC) and CE Marking Directive (93/68/EEC).

The tuner frequencies on this product are allocated for use in Western Europe, Asia, the Middle East, Africa and Oceania. Use in other areas may result in improper reception. The RDS function operates only in areas with FM stations broadcasting RDS signals.

About This Manual

This product features a number of sophisticated functions ensuring superior reception and operation. All are designed for the easiest possible use, but many are not self-explanatory. This operation manual is intended to help you benefit fully from their potential and to maximize your listening enjoyment.

We recommend that you familiarize yourself with the functions and their operation by reading through the manual before you begin using this product. It is especially important that you read and observe the "Precaution" on this page and in other sections.

In this Operation Manual, the Basic Operation for each sound source is outlined at the beginning of its explanation, covering simple operation for that source, such as merely playing music.

Precaution

- The Pioneer CarStereo-Pass is for use only in Germany.
- Keep this manual handy as a reference for operating procedures and precautions.
- Always keep the volume low enough for outside sounds to be audible.
- Protect the product from moisture.
- If the battery is disconnected, the preset memory will be erased and must be reprogrammed.

In Case of Trouble

Should this product fail to operate properly, contact your dealer or nearest authorized Pioneer Service Station.

Detaching and Replacing the Front Panel

Theft Protection

The front panel of the main body is detachable to discourage theft.

■ Detaching the front panel

1. Eject the front panel.

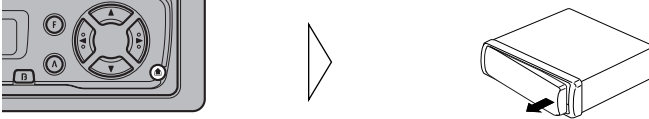

2. To remove the front panel, pull its right-hand side toward you.

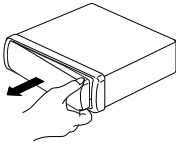

Take care not to grip it tightly or drop it.

3. Use the protective case provided to store/carry the detached front panel.

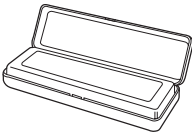

■ Replacing the Front Panel

● Replace the front panel by clipping it into place.

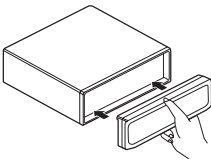

Precaution:

- Never use force or grip the display tightly when removing or replacing the front panel.
- Avoid subjecting the front panel to excessive shocks.
- Keep the front panel out of direct sunlight and high temperatures.

Initial Setting Menu

With this menu, you can perform initial settings for the unit. Setting options cover everything from tuning steps for the tuner to auto PI seek ON/OFF switching.

Entering the Initial Setting Menu

1. Enter the Initial Setting Menu with the sources off.

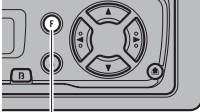

Hold for 2 seconds



To cancel the Initial Setting Menu, press the BAND button.

Note:

- Holding down the Function button for 2 seconds also cancels the Initial Setting Menu.

2. Select the desired mode.

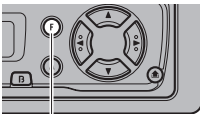

Each press changes the Mode ...



Each press of the Function button selects the mode in the following order:

FM STEP = A-PI

Changing the FM Tuning Step

Normally set at 50 kHz during Seek tuning in the FM mode, the tuning step changes to 100 kHz when the AF or TA mode is activated.

It may be preferable to set tuning step to 50 kHz in the AF mode.

• Select the desired tuning step.

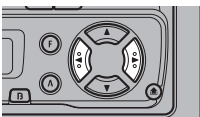

Note:

- The tuning step remains set at 50 kHz during Manual tuning.
- The tuning step returns to 100 kHz if the battery is temporarily disconnected.

Switching the Auto PI Seek

During Preset Station PI Seek operation, you can switch the Auto PI Seek function ON/OFF.
(Refer to “PI Seek Function” on page 22.)

- Switch the Auto PI Seek ON or OFF.

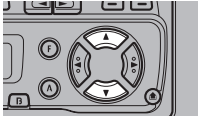

Switching the AUX mode

It is possible to use auxiliary (AUX) equipment with this product.

Activate the AUX mode when using external equipment with this product.

- Switch the AUX mode ON or OFF.

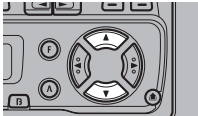

Switching Power On

- Select the desired source (such as the tuner).

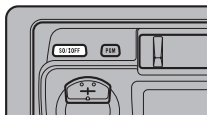

Each press of the SOURCE button selects the desired source in the following order:
Tuner → Tape → Multi-CD player → AUX

Note:

- In the following cases, the sound source will not change:
 - *No Multi-CD player is connected to this unit.
 - *No cassette tape is set in this unit.
 - *No magazine is set in the Multi-CD player.
 - *AUX (external input) is set to OFF. (See page 11.)

Switching Power Off

Switch the sources OFF.

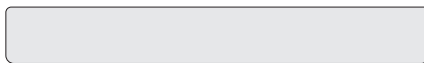
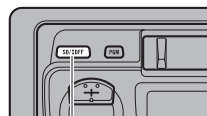

Hold for 1 second

Basic Operation of Tuner

1. Select Tuner. (See page 12.)

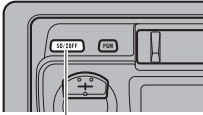

Each press changes the Source ...

The program service name or frequency appears on the display.
("Ⓞ") indicator lights when a stereo station is selected.)

2. Select the desired band.

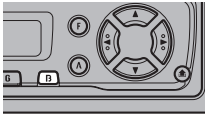

FI → FII → FIII → MW/LW

3. Tune the receiver to a higher or lower frequency.

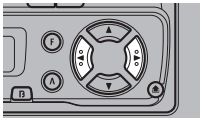

This product's tuner lets you select the tuning by changing the length of the time you press the button.

| | |
|------------------------------|---------------------|
| Manual Tuning (step by step) | 0.3 seconds or less |
| Seek Tuning | 0.3 - 2 seconds |
| Manual Tuning (continuously) | 2 seconds or more |

Note:

- To select a weak broadcasting station that cannot be tuned in with the Seek Tuning function, tune in with Manual Tuning.

Tuner Operation

4. Raise or lower the volume.

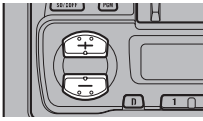

5. Turn the source OFF. (See page 12.)

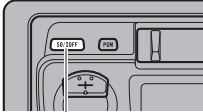

Hold for 1 second

AF Function Switching

This product's AF function can be switched ON and OFF. AF should be switched OFF for normal tuning operations.

● Switch AF OFF.

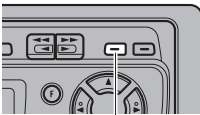

Hold for 2 seconds

"AF" disappears

To switch AF ON, repeat the preceding operation.

Note:

- You can also switch the AF Function ON/OFF in the Function Menu.

Entering the Function Menu

In this menu you can select tuner functions.

Note:

- REG, TA, PTY and AF are RDS functions. Refer to "Using RDS Function" for details and instructions on how to use these functions.

● **Select the desired mode in Function Menu.**

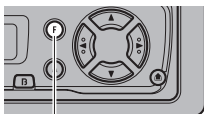

Each press changes the Mode ...

Each press of the Function button selects the mode in the following order:

BSM → REG → LOCAL → TA → PTY SELECT → AF

Note:

- You can cancel the Function Menu by pressing the BAND button.
- After selecting the Function Menu, if you do not perform an operation within about 30 seconds, the Function Menu is automatically canceled.

Local Seek Tuning

This mode selects only stations with especially strong signals. The sensitivity can be adjusted in 4 steps for FM and 2 steps for MW/LW.

1. Select the Local mode in the Function Menu.

2. Switch the Local mode ON or OFF.

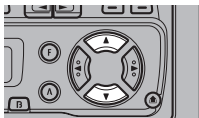

3. Select the desired Local Seek Sensitivity in the following order:

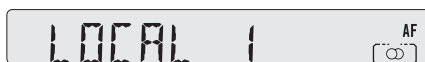
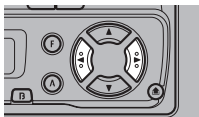

FM: LOCAL 1 ↔ LOCAL 2 ↔ LOCAL 3 ↔ LOCAL 4

MW/LW: LOCAL 1 ↔ LOCAL 2

Note:

- Pressing the BAND button cancels the Function Menu.
- The LOCAL 4 setting allows reception of only the strongest stations, while lower settings let you receive progressively weaker stations.

Preset Tuning

Up to 18 FM stations (6 in FI (FM1), FII (FM2) and FIII (FM3)) and 6 MW/LW stations can be stored in memory.

Store the stations in memory under buttons 1-6 beforehand with the BSM (Best Stations Memory) or Preset Memory function.

BSM (Best Stations Memory)

The BSM function stores stations in memory automatically.

1. Select the BSM mode in the Function Menu.

2. Switch the BSM mode ON.

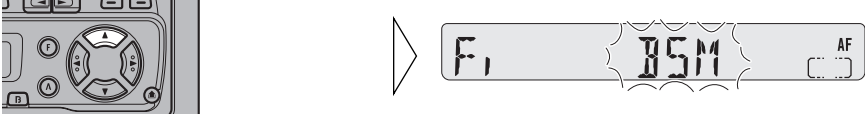

The stations with the strongest signals will be stored under buttons 1-6 and in order of their signal strength.

Note:

- Pressing the BAND button cancels the Function Menu.
- **To cancel the process, press the ▼ button in the Function Menu before memorization is complete.**

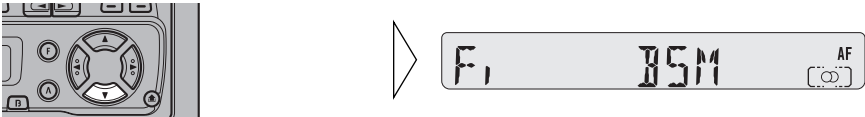

Preset Memory

The Preset Memory function stores stations in memory manually.

1. Select the station whose frequency you want to store in memory.

2. Press one of buttons 1-6 for 2 seconds or longer to store the desired stations.

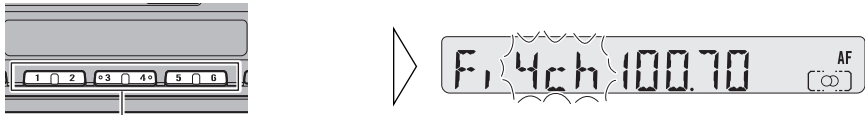

Hold for 2 seconds

The station is stored in memory under the selected button.

Recalling Preset Stations

There are two ways to recall preset stations.

■ Direct Recall

- Press one of buttons 1-6 to recall a station preset under that button.



■ Sequential Recall

- Recall a station preset under button 1-6.

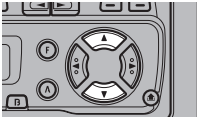

Using the Programmable Button

You can memorize Function Menu BSM, REG and LOCAL functions in the Programmable button.

Initially, the BSM function is memorized in the Programmable button.

■ Setting the Programmable Button

1. Select the Programmable button setting mode.

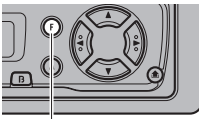

Hold for 2 seconds



2. Select the function you want to memorize in the Programmable button.

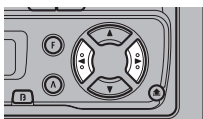

3. Memorize the function in the Programmable button.



Note:

- Pressing the BAND button cancels the Programmable button setting mode.

■ Using the Programmable Button

The Programmable button operates in a different way depending on the function programmed (memorized).

● Use the programmable button.

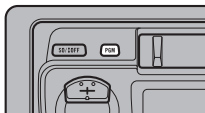

| Function | Press | Hold for 2 seconds |
|----------|--------|--|
| BSM | ——— | ON/OFF |
| REG | ON/OFF | ——— |
| LOC | ON/OFF | Entering the Local Seek Sensitivity mode |

What is RDS?

RDS (Radio Data System) is a system for transmitting data along with FM programs. This data, which is inaudible, provides a variety of features such as: program service name, program type display, traffic announcement standby, automatic tuning and program type tuning, intended to aid radio listeners in tuning to a desired station.

Note:

- RDS service may not be provided by all stations.
- RDS functions, like AF (Alternative frequencies search) and TA (Traffic Announcement standby), are only active when your radio is tuned to RDS stations.

Program Service Name Display

With this function, the names of networks/stations providing RDS services replace the frequency on the display a few seconds after they are tuned in.

● Change the display.

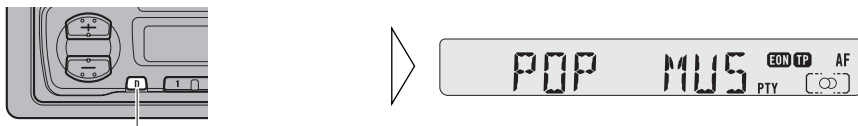

Each press changes the Mode ...

Each press of the DISP/Clock button selects the mode in the following order:

Program Service Name → PTY Information → Frequency

Note:

- After switching displays, if you do not perform an operation within 8 seconds, the Program Service Name is automatically displayed.

■ Displaying PTY Information

PTY (Program Type ID code) information for the currently tuned station appears on the display for 8 seconds. The information is correlated with the list in the section “PTY Function” on page 25.

■ Displaying the Frequency

The frequency of the current station appears on the display.

AF Function

The AF (Alternative Frequencies search) function is used to search for other frequencies in the same network as the currently tuned station. It automatically retunes the receiver to another frequency in the network which is broadcasting a stronger signal when there are problems with reception of the currently tuned station or better reception is possible on a different frequency.

Note:

- AF tunes the receiver only to RDS stations when you use Seek tuning or BSM Auto Memory with the "AF" indicator ON.
- When you recall a preset station, the tuner may update the preset station with a new frequency from the station's AF list. (This is only available when using presets on the FM1 and FM2 bands.) No preset number appears on the display if the RDS data for the station received differs from that for the originally stored station.
- Sound may be temporarily interrupted by another program during an AF frequency search.
- When the tuner is tuned to a non-RDS station, the "AF" indicator flashes.
- AF can be switched ON or OFF independently for each FM band.

■ Activating/deactivating the AF Function

AF is set to ON by default.

● Turn AF to OFF.

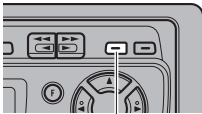

Hold for 2 seconds



"AF" disappears

To turn AF back ON, repeat the preceding operation.

Note:

- You can also switch the AF Function ON/OFF in the Function Menu.

PI Seek Function

The tuner searches for another frequency broadcasting the same programming. "PI SEEK" appears on the display and the radio volume is muted during a PI Seek. The muting is discontinued after completion of the PI Seek, whether or not the PI seek has succeeded. If the PI Seek is unsuccessful, the tuner returns to the previous frequency.

■ Auto PI Seek

If the tuner fails to locate a suitable alternative frequency or if the broadcasting signal is too weak for proper reception, the PI Seek will automatically start.

■ Preset Station PI Seek

When preset stations cannot be recalled, as when traveling long distances, the unit can be set to perform PI Seek also during preset recall.

The default setting for PI Seek is OFF.

Note:

- Refer to "Initial Setting Menu" for details on how to switch this unit ON/OFF.

REG Function

When AF is used to retune the tuner automatically, REG (regional) limits the selection to stations broadcasting regional programs.

Note:

- Regional programming and regional networks are organized differently depending on the country (i.e., they may change according to the hour, state or broadcast area).
- The preset number may disappear on the display if the tuner tunes in a regional station which differs from the originally set station.

■ Activating REG

The REG function can be turned ON independently for each FM band.

1. Select the REG mode in the Function Menu.

2. Activate or deactivate REG while in an FM band.

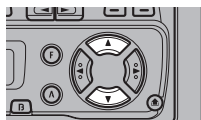

Note:

- Pressing the BAND button cancels the Function Menu.

TA Function

The TA (Traffic Announcement standby) function lets you receive traffic announcements automatically, no matter what source (tuner, cassette player or multi-CD player) you are listening to. The TA function can be activated for either a TP station (a station that broadcasts traffic information) or an EON TP station (a station carrying information which cross-references TP stations).

■ Activating/Deactivating the TA Function

1. Tune in a TP or EON TP station.

The "TP" indicator lights when the tuner is tuned to a TP station, and both the "EON" and "TP" indicators light when it is tuned to an EON TP station.

2. Activate the TA function.

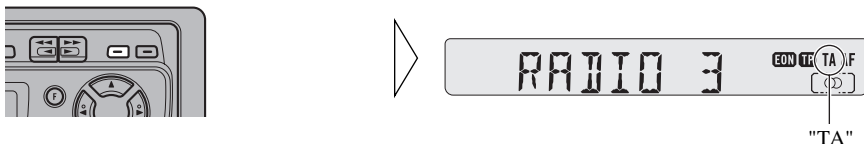

The "TA" indicator lights, indicating that the tuner is waiting for traffic announcements.

Repeat the preceding operation when no traffic announcement is being received to deactivate the TA function.

Note:

- You can also switch the TA Function ON/OFF in the Function Menu.
- Only the (+), (-), TA/AF, AUDIO, DISP/Clock and SOURCE buttons can be used during traffic announcement reception.
- The system switches back to the original source following traffic announcement reception.
- The TA function can be activated from the cassette player or multi-CD player mode if the tuner was last set to the FM band but not if it was last set to the MW/LW band.
- If the tuner was last set to FM, turning on the TA function lets you operate other tuning functions while listening to a cassette or CD.
- Only TP or EON-TP stations are tuned in during the Seek Tuning mode when the "TA" indicator is ON.
- Only TP or EON-TP stations are stored by BSM when the "TA" indicator is ON.

■ Canceling Traffic Announcements

- Press the TA/AF button while a traffic announcement is being received to cancel the announcement and return to the original source.



The announcement is canceled but the tuner remains in the TA mode until the TA/AF button is pressed again.

■ Adjusting the TA Volume

When a traffic announcement begins, the volume adjusts automatically to a preset level to enable you to hear the announcement clearly.

- Set the volume by adjusting it during reception of a traffic announcement.

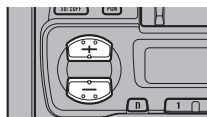

The newly set volume is stored in memory and recalled for subsequent traffic announcements.

■ TP Alarm function

About 30 seconds after the "TP" or "EON" indicator is extinguished due to a weak signal, a 5 second beep sounds to remind you to select another TP or EON-TP station.

- If you are listening to the tuner, tune in another TP station or EON-TP station.

In the cassette player mode, the tuner automatically seeks out the TP station with the strongest signal in the current area 10 (or 30)* seconds after "TP" disappears from the display.

* Time taken before Seek begins.

| | |
|---------------------|------------|
| TA function ON | 10 seconds |
| TA, AF functions ON | 30 seconds |

PTY Function

The PTY function enables you to select stations by the type of programming they broadcast (PTY Search). It also provides automatic tuning to emergency broadcasts (PTY Alarm).

Note:

- PTY code program types are as follows:

| | |
|---------------|---|
| 1. NEWS: | News. |
| 2. AFFAIRS: | Current affairs. |
| 3. INFO: | General information and advice. |
| 4. SPORT: | Sports programs. |
| 5. EDUCATE: | Educational programs. |
| 6. DRAMA: | All radio plays and serials. |
| 7. CULTURE: | Programs concerned with any aspect of national or regional culture. |
| 8. SCIENCE: | Programs about nature, science and technology. |
| 9. VARIED: | Light entertainment programs. |
| 10. POP MUS: | Popular music. |
| 11. ROCK MUS: | Contemporary modern music. |
| 12. EASY MUS: | Easy listening music. |
| 13. L. CLASS: | Light classical music. |
| 14. CLASSICS: | Serious classical music. |
| 15. OTH MUS: | Other types of music, which can't be categorized. |
| 16. WEATHER: | Weather reports/Meteorological information. |
| 17. FINANCE: | Stock market reports, commerce, trading etc. |
| 18. CHILDREN: | Children's programs. |
| 19. SOCIAL: | Social affairs programs. |
| 20. RELIGION: | Religion affairs programs or services. |
| 21. PHONE IN: | Phone in based programs. |
| 22. TOURING: | Travel programs, not for announcements about traffic problem. |
| 23. LEISURE: | Programs about hobbies and recreational activities. |
| 24. JAZZ: | Jazz music based programs. |
| 25. COUNTRY: | Country music based programs. |
| 26. NAT MUS: | National music based programs. |
| 27. OLDIES: | Oldies music, 'Golden age' based programs. |
| 28. FOLK MUS: | Folk music based programs. |
| 29. DOCUMENT: | Documentary programs. |

- If a PTY code of zero is received from a station, "NONE" will be displayed. This indicates that the station has not defined its programme contents.
- If the signal is too weak for this product to pick up the PTY code, "NO PTY" will be displayed.

■ PTY Search Setting Function

1. Enter the PTY Search setting mode.

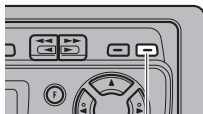

Hold for 2 seconds



The "PTY" indicator lights and the name of a program type appears on the display for 5 seconds.

Note:

- CURRENT sets desired PTY to the program type of the current station (only for RDS stations broadcasting PTY information).

2. Select one of the PTYs:

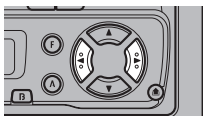

3. When the desired programming type appears on the display, return to the normal display.



Note:

- You can also select the PTY Search Setting PTY Code in the Function Menu, and switch the PTY Search Function ON/OFF.

■ PTY Search Function

- Initiate a PTY search.



The tuner searches for a station broadcasting the desired PTY.

Note:

- The program of some stations may differ from that indicated by the transmitted PTY.
- If no station broadcasting the selected programming type is found, "NOT FOUND" is displayed for about 2 seconds, and the tuner returns to the original station.

■ PTY Alarm

PTY Alarm is a special PTY code for announcements regarding emergencies such as natural disasters. When the tuner receives the radio alarm code, "ALARM" appears on the display and the volume adjusts to the TA volume. When the station stops broadcasting the emergency announcement, the system returns to the previous source.



Note:

- Only the (+), (-), TA/AF, AUDIO, DISP/Clock and SOURCE buttons can be used during emergency announcement reception.
- The system switches back to the original source following emergency announcement reception.

■ Canceling Emergency Announcements

- Press the TA/AF button during emergency announcement reception to cancel the announcement and return to the previous source.



Basic Operation of Cassette Player

1. Insert the cassette tape.

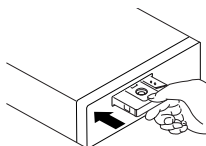

2. Switch tape playback from side A to side B, or vice versa.

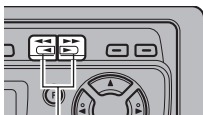

Same Time

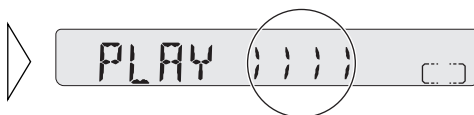

3. Raise or lower the volume.

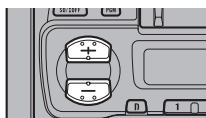

4. Remove the cassette tape.

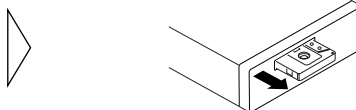
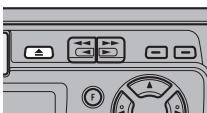

Note:

- The Tape function can be turned ON/OFF with the cassette tape remaining in this product. (See page 12.)

Fast Forward/Rewind

■ Fast Forward

While "<-->" is displayed, the system fast-forwards the cassette tape to the end of the current side.

- **Fast-forward the cassette tape by pressing the button for the same direction as the tape play indicator.**

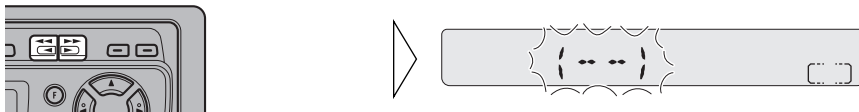

■ Rewind

While "<-->" is displayed, the system rewinds the cassette tape to the beginning of the current side.

- **Rewind the cassette tape by pressing the button for the opposite direction as the tape play indicator.**

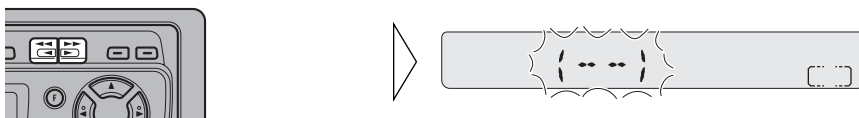

Entering the Function Menu

In this menu you can select Tape functions.

- **Select the Radio Intercept mode in Function Menu.**

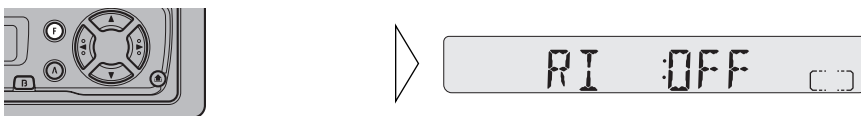

Note:

- You can cancel the Function Menu by pressing the BAND button.
- After selecting the Function Menu, if you do not perform an operation within about 30 seconds, the Function Menu is automatically canceled.
- This unit's cassette Function Menu enables Radio Intercept mode ON/OFF switching only. If you press the Function button for 2 seconds or more and select the Programmable button Setting mode, you can memorize the Radio Intercept mode ON/OFF setting beforehand.
- You can cancel the Programmable button setting mode by pressing the BAND button.

Radio Intercept (RI)

This function allows you to listen to the radio during tape fast-forwarding/rewinding.

- **Switch the Radio Intercept mode ON or OFF.**

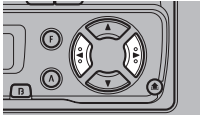

Note:

- You can also switch the Radio Intercept mode ON/OFF by pressing the Programmable button.

Precaution

■ About the Cassette Player

- A loose or warped label on a cassette tape may interfere with the eject mechanism of the unit or cause the cassette to become jammed in the unit. Avoid using such tapes or remove such labels from the cassette before attempting use.

■ About Cassette Tapes

- Do not use tapes longer than C-90 type (90 min.) cassettes. Longer tapes can interfere with tape transport.
- Storing cassettes in areas directly exposed to sunlight or high temperatures can distort them and subsequently interfere with tape transport.



- Store unused tapes in a tape case where there is no danger of them becoming loose or being exposed to dust.

Cleaning the Head

If the head becomes dirty, the sound quality will deteriorate and there will be sound dropouts and other imperfections in performance. In this case, the head must be cleaned.

This product can control one or more multi-CD players.

Basic Operation of Multi-CD Players

1. Select the multi-CD player source. (See page 12.)

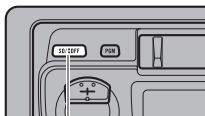

Each press changes the Source

Note:

- The multi-CD player may perform a preparatory operation, such as verifying the presence of a disc or reading disc information, when the power is turned ON or a new disc is selected for playback. "READY" is displayed.
- If the multi-CD player cannot operate properly, an error message such as "ERROR 14" is displayed. Refer to the multi-CD player owner's manual.

2. Select the desired disc.

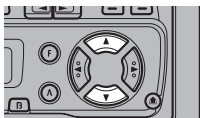

3. Reverse or advance track by track.

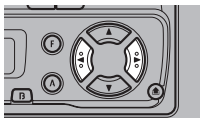

4. Raise or lower the volume.

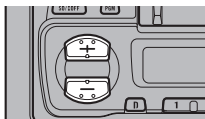

5. Turn the source OFF. (See page 12.)

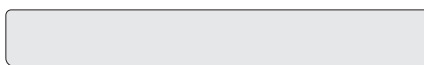
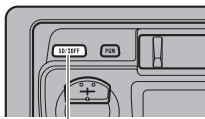

Hold for 1 second

Switching the Multi-CD Player

It is possible to connect up to three multi-CD players by means of a multiple installation adapter. When two or more multi-CD players are installed, their priorities must be specified. Follow the multi-CD player instructions carefully, and set the address switches properly.

- Select the multi-CD player you want to use.

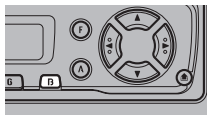

M1 → M2 → M3

Disc Number Search

■ Disc Number Search (for 6-Disc, 12-Disc types)

You can select discs directly with the 1 to 6 buttons. Just press the number corresponding to the disc you want to listen to.

Note:

- When a 12-Disc Multi-CD Player is connected and you want to select disc 7 to 12, press the 1 to 6 buttons for 2 seconds or longer.

- Select the desired disc. (eg. Press button 3.)



■ Disc Number Rough Search (for 50-Disc type only)

This handy function lets you select discs loaded in a 50-Disc Multi-CD Player using the 1 to 5 buttons. The 50 discs are divided into five blocks, with each of the 1 to 5 buttons assigned to a block.

For example, if you press button 1, discs 10 through 19 are searched in order, and then the disc with the lowest disc number is selected.

Note:

- Pressing button 5 lets you select the 50th disc only.
- Button 6 does not operate.
- Rough search of discs 1 to 9 is not possible. Use the ▲/▼ buttons to select a desired disc.

Using Multi-CD Player

1. Press the appropriate button from 1 to 5 to select the block containing the desired disc. (eg. Press button 4.)



2. Select the desired disc.

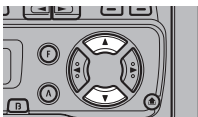

Track Search and Fast-forward/Reverse

Besides Track Search convenience when searching for a desired track, this unit also lets you fast-forward and reverse through tracks to find a desired phrase or section of music.

■ Track Search

This feature enables you to advance or reverse track by track.

- Reverse or advance track by track.

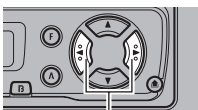

Hold for half a second or less



■ Fast-forward/Reverse

This feature enables you to advance or reverse at high speed between tracks.

- Reverse or fast-forward through tracks.

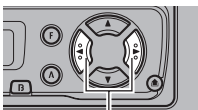

Continue pressing



Entering the Function Menu

In this menu you can select Multi-CD Player functions.

- **Select the desired mode in Function Menu.**

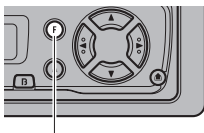

Each press changes the Mode ...

Each press of the Function button selects the mode in the following order:
REPEAT → RANDOM → ITS P → PAUSE

Note:

- You can cancel the Function Menu by pressing the BAND button.
- After selecting the Function Menu, if you do not perform an operation within about 30 seconds, the Function Menu is automatically canceled.

Entering the Detailed Setting Menu

In this menu you can perform Disc Title Input, and ITS Program and Programmable button settings.

- **Enter the Detailed Setting Menu.**

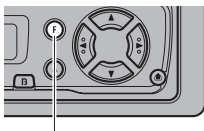

Hold for 2 seconds

Each press of the Function button selects the mode in the following order:

TITLE IN → ITS → PGM-FUNC

To cancel the Detailed Setting Menu, hold down the Function button for 2 seconds.

Note:

- Pressing the BAND button also cancels the Detailed Setting Menu.

Pause

1. **Select the Pause mode in the Function Menu.**
2. **Stop playback temporarily or restarts the system.**

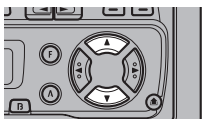

Note:

- Pressing the BAND button cancels the Function Menu.

Multi-CD Player Repeat Modes

Multi-CD players offer four repeat modes: One-track Repeat, Disc Repeat, Multi-CD player Repeat and All Repeat. Multi-CD player Repeat is the default mode (normal play) when one or more multi-CD players is installed.

1. Select the Repeat Selecting mode in the Function Menu.

2. Select the desired repeat mode in the following order:

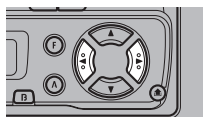

Multi-CD player Repeat (“MCD” is displayed) → ALL Repeat (“ALL” is displayed) → One-track Repeat (“TRK” is displayed) → Disc Repeat (“DSC” is displayed)

Note:

- Pressing the BAND button cancels the Function Menu.
- All Repeat is available only when two or more multi-CD players are installed.

■ Multi-CD player repeat modes

| Mode | Operation |
|--------------------------------------|---|
| One-track Repeat | Plays current track repeatedly. <ul style="list-style-type: none">• When Track Search or fast forward/reverse is performed, the mode returns to the Disc Repeat mode.• When a different disc or multi-CD player is selected, the mode switches to the Multi-CD player Repeat mode. |
| Disc Repeat | Plays current disc repeatedly. <ul style="list-style-type: none">• When a different disc or multi-CD player is selected, the mode switches to the Multi-CD player Repeat mode. |
| Multi-CD player Repeat (normal play) | Plays all discs loaded in the multi-CD player magazine repeatedly in order, starting with the first disc. |
| All Repeat | Plays all discs in the magazines of all multi-CD players in order. |

Multi-CD Player Random Play

Random Play is available when one or more multi-CD players are in use.

1. Select the Random mode in the Function Menu.

2. Switch the Random Play ON or OFF.

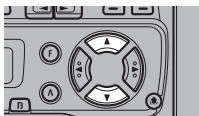

When Multi-CD Player Random Play is ON, you can combine it with Repeat Mode to operate as shown below. Switching the Repeat Mode switches Random Play OFF.

Note:

- Pressing the BAND button cancels the Function Menu.
- Since playback is random, the same track may be repeated consecutively.

■ Multi-CD player Random Play options

| Mode | Operation |
|------------------------|---|
| One-track Repeat | The mode returns to the Disc Repeat mode, and all tracks on the current disc are played randomly. |
| Disc Repeat | All tracks on the current disc are played randomly. |
| Multi-CD player Repeat | All tracks on the discs in the multi-CD player magazine are played randomly. |
| All Repeat | All tracks on the discs in all the multi-CD players are played randomly. |

ITS (Instant Track Selection)

The ITS function allows you to search for the track you wish to play back when one or more multi-CD players are installed. You can use ITS to program automatic playback of up to 24 tracks per disc from up to 100 discs. (You can store ITS program and Disc Title data for up to 100 discs in memory.) After 100 discs have been programmed, data for a new disc will overwrite the data for the disc that has not been played back for the longest time.

■ ITS Programming

ITS programming can be conducted in any multi-CD player playback mode except ITS playback.

1. Play the track you wish to program.

2. Select the ITS Programming mode in the Detailed Setting Menu.

3. Program the desired track.

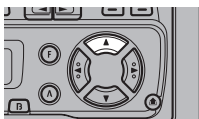

Note:

- Pressing the BAND button cancels the Detailed Setting Menu.

■ ITS Playback

ITS playback can be performed in any repeat mode.

1. Select the ITS Playback mode in the Function Menu.

2. Switch the ITS Playback ON or OFF.



When ITS Play is ON, you can combine it with Repeat Mode to operate as shown below. If you change Repeat Mode into One-track Repeat, ITS Play will be turned OFF.

The ITS programmed tracks are played back in order from first to last.

Note:

- Pressing the BAND button cancels the Function Menu.
- If no track in the current range is programmed for ITS playback, "ITS EMPTY" is displayed.

■ Multi-CD player ITS play

| Mode | Operation |
|------------------------|--|
| One-track Repeat | The mode returns to the Disc Repeat mode and all programmed tracks on the current disc are played. |
| Disc Repeat | All programmed tracks on the current disc are played. |
| Multi-CD player Repeat | All programmed tracks on the discs in the multi-CD player magazine are played back. <ul style="list-style-type: none"> • If there are no programmed tracks on the current disc, ITS advances to the next disc. |
| All Repeat | The programmed tracks on all the discs in the magazines of all the installed multi-CD are played back. <ul style="list-style-type: none"> • If there are no programmed tracks on the current disc (or multi-CD player), ITS advances to the next disc (or multi-CD player). |

Erasing ITS Programs

ITS programs for up to 100 discs are stored permanently until you erase them.

■ Erase a track program

1. Select the track you wish to erase, during ITS playback.
2. Select the ITS Programming mode in the Detailed Setting Menu.
3. Erase the track program.



ITS is canceled and playback of the next ITS-programmed track begins. If there are no more programmed tracks in the current range, "ITS EMPTY" is displayed and normal playback resumes.

Note:

- Pressing the BAND button cancels the Detailed Setting Menu.

■ Erase a disc program

1. Select the disc you wish to erase, while the disc is playing.
2. Select the ITS Programming mode in the Detailed Setting Menu.
3. Erase the disc program.

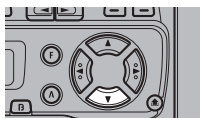

Note:

- Pressing the BAND button cancels the Detailed Setting Menu.

Disc Title Input

You can input Titles up to 10 letters long for up to 100 discs. Using this function lets you easily search for and select a desired disc for play. (You can store ITS program and Disc Title data for up to 100 discs in memory.)

1. Play the disc you wish to input the disc title.
2. Select the Disc Title Input mode in the Detailed Setting Menu.
3. Select a letter, number or symbol.

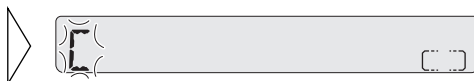
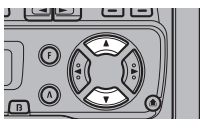

To insert a space, select the flashing cursor.

4. Reverse or advance box by box.

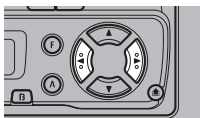

5. When the title is completed, store it in memory to make the flashing cursor fade out.

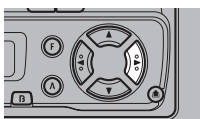

The title remains on the message display.

Note:

- Pressing the BAND button cancels the Detailed Setting Menu.
- Titles remain in memory, even after the disc has been removed from the magazine, and are recalled when the disc is reinserted.
- After the titles for 100 discs have been entered, data for a new disc will overwrite the data for the disc that has not been played back for the longest time. If a Multi-CD player is installed, the data is stored in the Multi-CD player's memory.

■ Displaying Disc Titles

- Change the Disc Title display of the current disc.

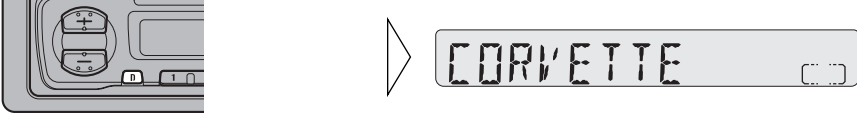

If no title has been input for a disc, “NO TITLE” flashes on the display for 8 seconds, after which the display becomes blank.

Repeat the preceding operation to return to the normal display.

Using the Programmable Button

In the Function Menu, you can memorize the PAUSE, REPEAT, RANDOM, and ITS functions in the Programmable button.

Initially, PAUSE is memorized in the Programmable button.

■ Setting the Programmable Button

1. Select the Programmable button setting mode in the Detailed Setting Menu.
2. Select the function you want to memorize in the Programmable button.

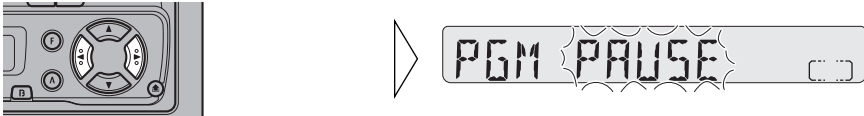

3. Memorize the function in the Programmable button.

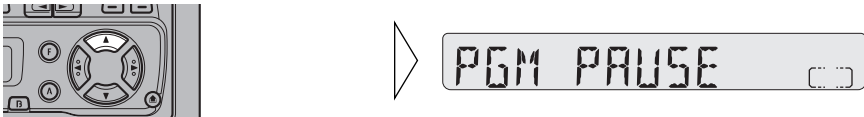

Note:

- Pressing the BAND button cancels the Detailed Setting Menu.

Using Multi-CD Players

■ Using the Programmable Button

The Programmable button operates in a different way depending on the function programmed (memorized).

- Use the Programmable button.



| Function | Press | Hold for 2 seconds |
|----------|--------------------|--------------------|
| PAUSE | ON/OFF | ———— |
| REPEAT | Selecting the mode | ———— |
| RANDOM | ON/OFF | ———— |
| ITS | ITS Programming | ON/OFF |

Selecting the Mode

- Select the mode you want to adjust.

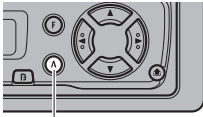

Each press changes the Mode ...

Each press of the AUDIO button selects the mode in the following order:

Fader/Balance → Bass → Treble → Loudness

When audio modes are selected for adjustment, the setting returns to the normal display after 30 seconds.

Balance Adjustment

This function allows you to select a Fader/Balance setting that provides ideal listening conditions in all occupied seats.

1. Select the Fader/Balance mode.

After adjustment use the BAND button to return to the normal display.

2. Shift the balance progressively to the front or rear speakers.

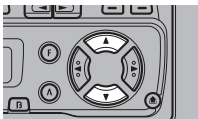

"FAD F15" – "FAD R15" is displayed as it moves from front to rear.

Note:

- "FAD 00" is the proper setting when 2 speakers are in use.

3. Shift the balance to the left or right speaker, respectively.

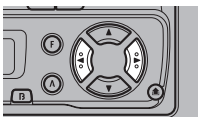

"BAL L9" – "BAL R9" is displayed as it moves from left to right.

Bass/Treble Adjustment

This product is equipped with two tone adjustment modes, the Bass Adjustment and Treble Adjustment modes.

1. Select "Bass Adjustment mode" or "Treble Adjustment mode".

After adjustment use the BAND button to return to the normal display.

2. Increase or decrease the intensity of the bass or treble, whichever is selected.

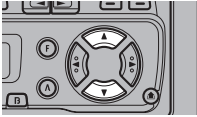

The display shows "+6" – "-6".

3. Repeat steps 1 – 2 above for the other Bass or Treble Adjustment mode.

Loudness Adjustment (LOUD)

The Loudness function compensates for deficiencies in the low and high sound ranges at low volume.

1. Select the Loudness adjustment mode.

After selection use the BAND button to return to the normal display.

2. Switch the Loudness function ON or OFF.

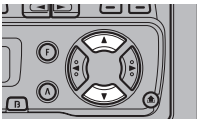

Time Display/Setting

■ Displaying the time

- To turn the time display ON with the Source ON.

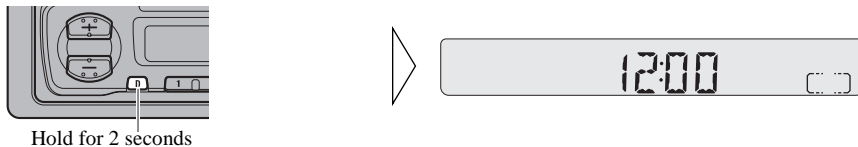

The time display disappears temporarily when you perform another operation, but the time indication returns to the display after 25 seconds.

■ Setting the Hours

- While holding down the DISP/Clock button for at least 2 seconds, press button 1 to set the hour.

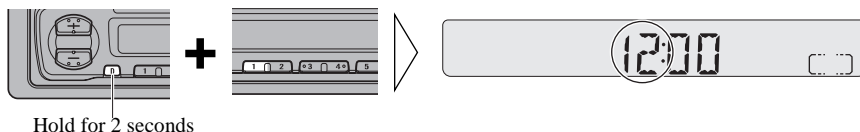

■ Setting the Minutes

- While holding down the DISP/Clock button for at least 2 seconds, press button 2 to set the minute.

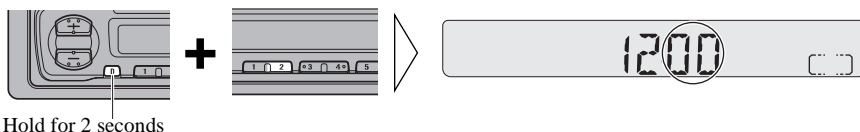

When you release the DISP/Clock button, the second count begins from 00 seconds.

■ Synchronizing with the time announcement

- While holding down the DISP/Clock button for at least 2 seconds, press button 3 to reset the minute and second indications to zero. Example: When synchronizing between 11:30 and 12:29.

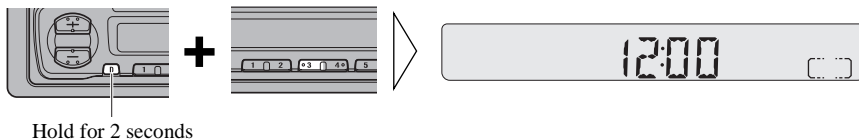

Note:

- The hour and minute can be advanced by pressing the respective buttons either consecutively or continuously.

Using the AUX mode

It is possible to use auxiliary (AUX) equipment with this product. Activate the AUX mode when using external equipment with this product.

■ Selecting the AUX Mode

- Select AUX.

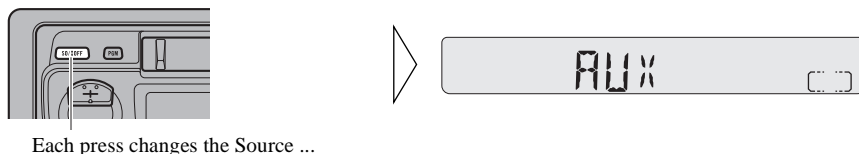

■ AUX Title Input

The display title for AUX mode can be changed.

1. Select the Aux Title Input mode in Detailed Setting Menu.

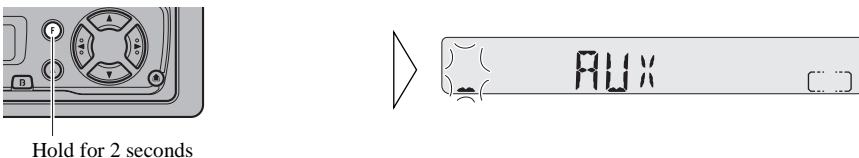

2. Input the Aux Title.

Refer to “Disc Title Input” on page 40, and perform procedures 3 to 5 in the same way.

Note:

- When using the “CD-RB20” inter connector to connect an auxiliary component, switch power to that component ON only when you want to listen to it. If power to the auxiliary component is switched ON when you are listening to another source, you will hear sound from both sources simultaneously (sound will be mixed).

Specifications

General

| | |
|--------------------------------|-------------------------------------|
| Power source | 14.4 V DC (10.8 – 15.1 V allowable) |
| Grounding system | Negative type |
| Max. current consumption | 8.5 A |
| Dimensions | |
| (mounting size) | 178 (W) × 50 (H) × 150 (D) mm |
| (front face) | 188 (W) × 58 (H) × 19 (D) mm |
| Weight | 1.2 kg |

Amplifier

| | |
|-------------------------------|---------------------------------|
| Maximum power output | 40 W × 4 |
| Continuous power output | 22 W × 4 |
| | (DIN45324, +B = 14.4 V) |
| Load impedance | 4 Ω (4 – 8 Ω allowable) |
| Tone controls | |
| (Bass) | ±12 dB (100 Hz) |
| (Treble) | ±12 dB (10 kHz) |
| Loudness contour | +10 dB (100 Hz), +7 dB (10 kHz) |
| | (volume: -30 dB) |

Cassette player

| | |
|-----------------------------------|-------------------------------------|
| Tape | Compact cassette tape (C-30 – C-90) |
| Tape speed | 4.8 cm/sec. |
| Fast forward/rewinding time | Approx. 90 sec. for C-60 |
| Wow & flutter | 0.13% (WRMS) |
| Frequency response | 40 – 14,000 Hz (±3 dB) |
| Stereo separation | 45 dB |
| Signal-to-noise ratio | 52 dB (IEC-A network) |

FM tuner

| | |
|----------------------------------|--|
| Frequency range | 87.5 – 108 MHz |
| Usable sensitivity | |
| | 11 dBf (1.0 μV/75 Ω, mono, S/N: 30 dB) |
| 50 dB quieting sensitivity | 16 dBf (1.7 μV/75 Ω, mono) |
| Signal-to-noise ratio | 70 dB (IEC-A network) |
| Distortion | 0.3% (at 65 dBf, 1 kHz, stereo) |
| Frequency response | 30 – 15,000 Hz (±3 dB) |
| Stereo separation | 40 dB (at 65 dBf, 1 kHz) |

MW tuner

| | |
|--------------------------|--------------------|
| Frequency range | 531 – 1,602 kHz |
| Usable sensitivity | 18 μV (S/N: 20 dB) |
| Selectivity | 50 dB (±9 kHz) |

LW tuner

| | |
|--------------------------|--------------------|
| Frequency range | 153 – 281 kHz |
| Usable sensitivity | 30 μV (S/N: 20 dB) |
| Selectivity | 50 dB (±9 kHz) |

Note:

- Specifications and the design are subject to possible modification without notice due to improvements.

France: tapez 36 15 PIONEER

PIONEER ELECTRONIC CORPORATION

1-4-1 MEGURO, MEGURO-KU, TOKYO 153-8654, JAPAN

PIONEER ELECTRONICS (USA) INC.

P.O. Box 1760, Long Beach, California 90801, U.S.A.

TEL: (800) 421-1404

PIONEER ELECTRONIC (EUROPE) N.V.

Haven 1087 Keetberglaan 1, 9120 Melsele, Belgium

TEL:(0) 3/570.05.11

PIONEER ELECTRONICS AUSTRALIA PTY. LTD.

178-184 Boundary Road, Braeside, Victoria 3195, Australia

TEL: (03) 580-9911

PIONEER ELECTRONICS OF CANADA, INC.

300 Allstate Parkway, Markham, Ontario L3R 0P2, Canada

TEL: (905) 479-4411

PIONEER ELECTRONICS DE MEXICO, S.A. de C.V.

San Lorenzo Num 1009 3er piso Desp. 302

Col. Del Valle, Mexico D.F. C.P. 03100

TEL: 5-688-52-90

Published by Pioneer Electronic Corporation. Copyright © 1999 by Pioneer Electronic Corporation. All rights reserved.

Free Manuals Download Website

<http://myh66.com>

<http://usermanuals.us>

<http://www.somanuals.com>

<http://www.4manuals.cc>

<http://www.manual-lib.com>

<http://www.404manual.com>

<http://www.luxmanual.com>

<http://aubethermostatmanual.com>

Golf course search by state

<http://golfingnear.com>

Email search by domain

<http://emailbydomain.com>

Auto manuals search

<http://auto.somanuals.com>

TV manuals search

<http://tv.somanuals.com>