



AUDIOVOX®
ELECTRONICS CORP.

AVD400 SLOT-IN DVD PLAYER



Owner's Manual

A. Welcome

Thank you for choosing the AVD400 DVD Player. The AVD400 is designed to optimize the enjoyment of your favorite DVDs in the mobile environment. This DVD Player is constructed to provide years of reliable, trouble-free service. Please read this manual thoroughly prior to operating the player and save it for future reference.

B. Precautions

EXPLANATION OF GRAPHIC SYMBOLS

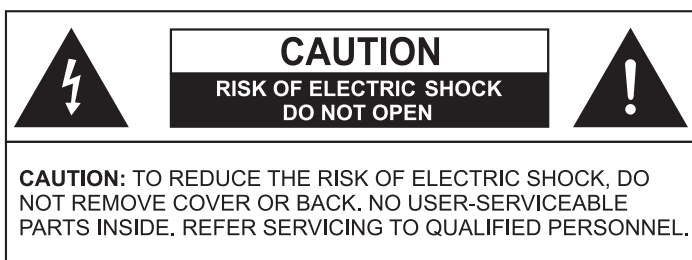

The lightning flash with arrowhead symbol, within an equilateral triangle, is intended to alert the user to the presence of uninsulated 'dangerous voltage' within the product's enclosure that may be of sufficient magnitude to constitute risk of electric shock to persons.



The exclamation point within an equilateral triangle is intended to alert the user to the presence of important operating and maintenance (servicing) instructions in the literature accompanying the appliance.

WARNING:

TO REDUCE THE RISK OF FIRE OR ELECTRIC SHOCK. DO NOT EXPOSE THIS DEVICE TO MOISTURE.

SAFETY PRECAUTION

For safety reasons do not allow children to unfasten seat-belts to change video media or make any adjustments to the system. Enjoy your entertainment system but always remember the safety of all passengers is the number one priority.

IMPORTANT NOTICE

It is unlawful in most states for a person to drive a motor vehicle which is equipped with a television viewer or screen that is located in the motor vehicle at any point forward of the back of the driver's seat, or that is visible, directly or indirectly, to the driver while operating the vehicle. In the interest of safety, this system should never be installed where it will be visible, directly or indirectly, by the operator of the motor vehicle.

1. OBJECT AND LIQUID

Do not insert objects of any kind into the system through its openings; do not spill or spray liquid on or into the system (this may result in a fire or electric shock). Do not place heavy objects on the unit. To ensure proper ventilation and proper operation, never cover or block the slots and openings.

2. DISASSEMBLE

Do not attempt to disassemble the unit. There is a risk of electric shock and/or exposure to Laser Radiation. Contact qualified service personnel if your system is in need of repair.

3. CLEANING UNIT

When cleaning, make sure the system is unplugged from the power source. Do not use any solvents or cleaning materials. Clean the DVD player using a lightly dampened lint free cloth to wipe the unit.

4. DISC

Do not use irregularly shaped discs such as heart or star-shaped discs as they may cause the unit to malfunction. Do not stick paper, tape or glue on the disc. Do not expose the disc to direct sunlight or heat sources. Do not touch the surface of the disc. Handle the disc by its edges. Clean the disc by wiping the disc from the center out with a soft lint free cleaning cloth. Remove the disc from the unit and store it in its case after playing. Some playback operations of discs may be intentionally fixed by software producers. Unit plays discs according to the disc contents the software producers designed therefore some playback features may not be available. Refer to the instructions supplied with the discs.

5. Powering the DVD Player

This system **MUST** be powered from switched (Accessory) power as indicated on the marking label. Power should be applied to the unit when the ignition key is in the Run and/or Accessory positions. Use only the supplied power cable provided with this set to avoid electric hazards.

6. Operation

When the temperature rises dramatically from a very low temperature, moisture may condense inside the AVD400 and cause the DVD player to malfunction. If the AVD400 does not operate properly under these conditions leave the AVD400 turned on for at least 30 minutes for the moisture to evaporate.

C. Contents

1. 1 Main Unit
2. 1 Remote control with one Battery
3. 1 12VDC Power Harness
4. 2 Brackets with 4 Screws
5. 1 Remote IR Receiver
6. 1 AV cable (RCA to RCA)
7. 1 AV cable (1/8 to RCA)
8. 1 Owner's Manual

D. Controls

Main Unit (Refer to Figure 1)

1. Power Button
2. Previous Button
3. Next Button
4. Stop Button
5. Remote Control Sensor
6. Play Button
7. A/V 2 Audio Input Jack
8. A/V 2 Video Input Jack
9. Eject Button
10. IR Input
11. A/V 1 Input Jacks
12. Digital Audio Output
13. Audio R Output Jack
14. Audio L Output Jack
15. Video Output Jack
16. S-Video Output Jack
17. DC In/Out 12V Power Supply Connector
18. DC In/Out 12V Power Supply Connector

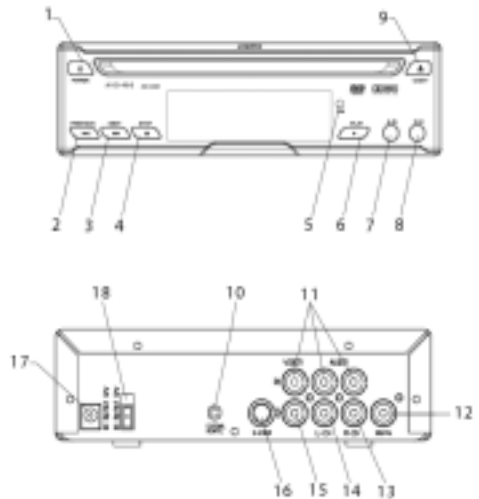

Figure1

E. Remote Control View (Refer to Figure 2)

- 1) MODE Button
- 2) POWER Button
- 3) MENU Button
- 4) UP/DOWN/
LEFT/RIGHT Button
- 5) ENTER/PLAY Button
- 6) VOLUME +/- Buttons
- 7) NUMERIC KEYPAD
- 8) 10+ Button
- 9) TITLE Button
- 10) AUDIO Button
- 11) REPEAT Button
- 12) SUBTITLE Button
- 13) DISPLAY Button
- 14) EJECT Button
- 15) SETUP Button
- 16) PAUSE Button
- 17) STOP Button
- 18) NEXT Button
- 19) PREVIOUS Button
- 20) SCAN FORWARD Button
- 21) SCAN REVERSE Button
- 22) MUTE Button
- 23) GOTO Button
- 24) ZOOM Button
- 25) A-B REPEAT Button
- 26) ANGLE Button
- 27) SLOW Button

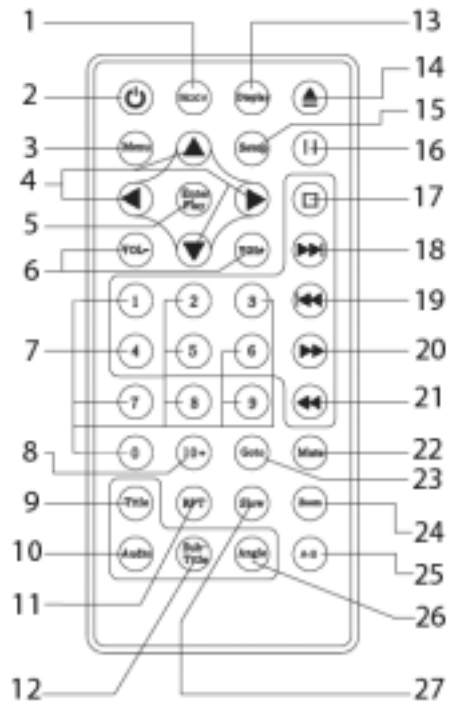

Figure 2

F. Connections

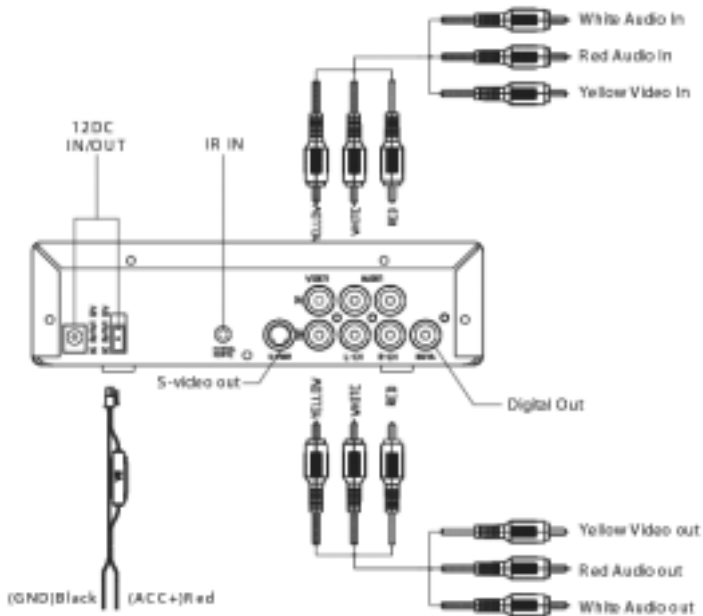

Figure 3

1. Powering your DVD Player (Refer to Figure 3)
Connect the black wire (-) to the vehicle ground. Connect the red wire (+) to a switched (Accessory) 12VDC source. Plug the other end into the 12VDC input jack on the back of the unit.
2. Remote IR Receiver (Refer to Figure 3)
Plug the 1/8" plug on the remote IR cable into the IR IN jack on the back of the DVD player. Place the IR receiver anywhere in the vehicle to allow remote control from any location.
3. Connecting to a Monitor
 - a. Match the color-coded plugs to the appropriate jacks on the back of the DVD Player A/V OUTPUT jacks: Yellow (video) to Yellow, White (left audio) to White, and Red (right audio) to Red.
4. Connecting an External Video Source
To connect a video game or another audio/video source, plug the A/V cable into the A/V input jack on the front or rear of the DVD player.

G. Playing

After connecting power to the unit, press the power button on the main unit momentarily. Insert the disc into the slot on the front of the unit, the unit will load the disc and start playing automatically: If there's a disc inside the unit, press the POWER button, the unit will start playing automatically.

1. BASIC OPERATION

POWER	Turn the unit on/off
EJECT	Eject/load the disc
PLAY	Start Play/Execute item or setting
SLOW	Play at 1/2, 1/4, 1/6 or 1/7 times speed
PAUSE	Still Picture
STOP	(1 time) Stop at the present playing point / (2 times) Stop playing
NEXT	Go to the next chapter, track or scene during play back
PREVIOUS	Go back to the preceding chapter, track or scene during play back
FAST FORWARD	Scan forward at 2, 4, 8 or 20 times normal speed
FAST REVERSE	Scan backward at 2, 4, 8 or 20 times normal speed
UP/DOWN/LEFT/RIGHT	Used for Menu Navigation
ENTER	Execute item or setting
NUMBERS	Select item or setting
RETURN	Return
MENU	Display the root menu of the disc
REPEAT	Repeat playing title, chapter, or track
DISPLAY	Display information (title, chapter, track, time, etc.).
ANGLE	Change the angles of a scene
SUBTITLE	Select the subtitle language
AUDIO	Select the audio language
ZOOM	Enlarge an image to 2, 3, or 4 times the original
SETUP	When the unit is in play mode this button will bring up a display for Brightness + Sharpness adjustment. For DVD playback Setup press stop and then press Setup to select and set items, and exit the setup menu.

2. MENU

A DVD is divided into sections called titles and chapters. When you play a DVD, a root menu of the disc will appear on the screen of your TV or Monitor. Contents of the menu will vary depending on the disc content. Press MENU during playback to display the main menu. Some DVDs only allow you to select disc playback options using the DVD root menu.

3. DISPLAY

1) Display mode

During playback press DISPLAY once to display items 5, and 7. Press DISPLAY twice to display the current disc playback information. Press display again to remove the display.

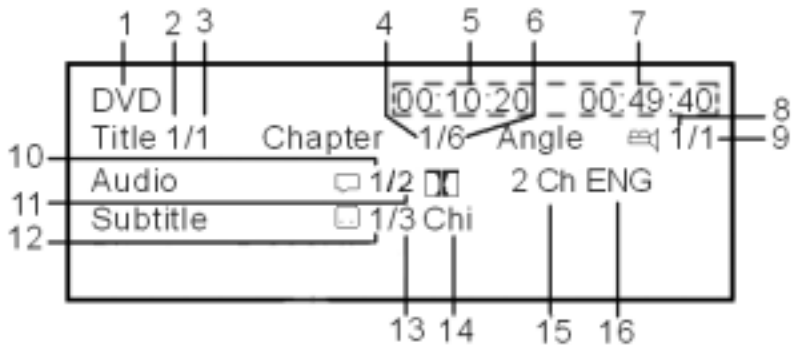

Display Mode

1. The type of disc.
2. The number of current title.
3. The number of total titles.
4. The number of current chapter.
5. The elapsed time of title.
6. The number of total chapters.
7. The remaining time of title.
8. The number of the current angle.
9. The number of total angles.
10. The number of the current audio language.
11. The number of total audio languages.
12. The number of current subtitle language.
13. The number of total subtitle languages.
14. Current subtitle language.
15. Dolby audio mode.
16. Current audio language selected.

4) ANGLE

During playback press ANGLE to change the current angle of discs containing multi-angles. (You can see item 8 in the display change) If the disc has only one angle, you will see  on the screen when pressing ANGLE indicating that no other angles are available.

5) SUBTITLE

During disc playback press SUBTITLE* to select the desired subtitle language. (You can see item 14 change)

6) AUDIO

During disc playback press AUDIO* to select the desired audio language. (You can see item 10 in Picture 1 change) *NOTE: Some DVD's only allow access to these functions through the DVD menu.

7) ZOOM

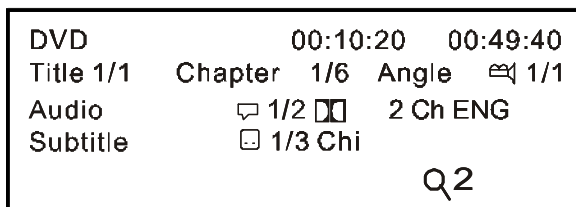

'Zoom' in Display Mode



'Zoom' Display

During playback press 'ZOOM' to enlarge the picture by 2x, 3x or 4X with the current zoom multiple displayed.

8) REPEAT

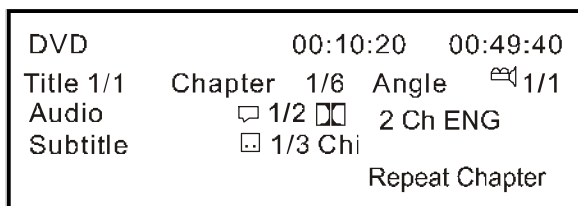

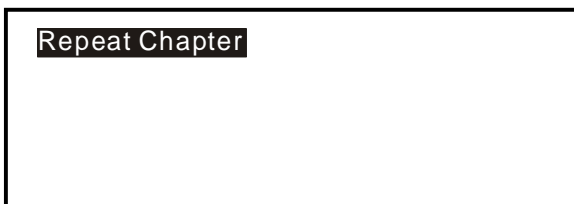

'Repeat' Display

During playback press 'REPEAT' once to repeatedly play the current chapter, press a 2nd time to repeat the current title, press a 3rd time and the repeat function is cancelled and normal playback resumes. Repeat mode sequence: Repeat Chapter/Repeat Title/Off.

9. PLAYING AUDIO CDS

When playing an audio CD the display will automatically display the disc playback information. The options below show you what information is displayed. Press the 'DISPLAY' button to remove the display.

1. The current track.
2. The number of total tracks.
3. Playing time of the disc.
4. Remaining time of the disc.

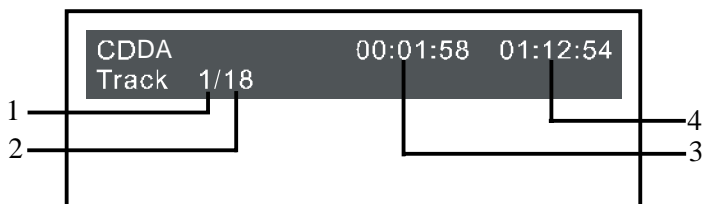

Display in Playing CD

USING THE REPEAT FEATURED

The default mode for the Repeat feature is OFF. Pressing REPEAT consecutively changes the repeat options:

- *Repeat Single*- repeats the track that is playing.
- *Repeat All*- repeats the disc that is playing.
- *Off*

As you toggle through the options, the repeat option changes. The selected repeat option loops repeatedly until its turned off.

10. PLAYING MP3 DISCS

MP3 is a digital audio format. An audio CD-quality song is compressed into the MP3 format with no significant loss of audio quality. CD-R / RW discs that have been encoded in MP3 format are compatible with this device.

Insert an MP3 Disc, the DVD player will initialize the disc and the directory (folder) will be shown on the monitor screen.

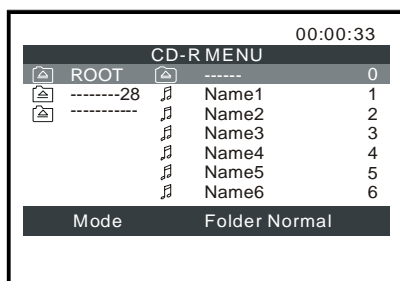

'MENU Screen' Display

When an MP3 disc is inserted into the unit, the menu screen appears automatically. You can use the menu screen to change folders and songs. The system plays the songs in the order they were recorded onto the disc.

1. Press the ▲ or ▼ button to choose a folder from the folder list on the left side of the screen.
2. Press ENTER to select the highlighted folder. All songs available under the selected folder will be listed.
3. Use ▲ or ▼ button to choose a song from the list then press ENTER to play the selected song.

Use the ►► (NEXT) button to move to the next song. Press the ◀◀ (PREVIOUS) button to move to the beginning of the song.



USING THE REPEAT FEATURE

The default mode for the Repeat feature is OFF. Pressing REPEAT consecutively changes the repeat options:

- Repeat Single(repeat playback of a song)
- Repeat All (repeat playback of all folder)
- Off (normal playback)

Pressing REPEAT a 3rd time will resume normal playback. As you toggle through the options, the repeat option changes. Selected repeat option loops repeatedly until you turn it off.

NOTICE

- “” sign in front of a file name indicates that this is a folder, not a MP3 file.
- “” sign in front of a file name indicates that this is a MP3 file. During MP3 playback, you cannot access “PLAY MODE”, folders or songs.

11. Playing a JPEG file

- 1) Insert the JPEG Disc into tray.
- 2) You can preview the JPEG file by pressing the MENU Button.
- 3) Press PLAY to playback the JPEGS in order.
- 4) Press PAUSE to STOP on a picture.

12. SETUP

Press STOP and then Press 'SETUP' to display the Main screen of the SETUP Menu on the screen. Press 'SETUP' again to exit the SETUP Menu and the unit will resume it's last playback mode.



Main 'SETUP' Menu Screen

- 1) Select language using the LEFT/RIGHT buttons, press ENTER to enter the 'LANGUAGE' setup page.



'Language' Display Menu

- a. Select 'OSD Menu' using the UP/DOWN buttons, then press ENTER to enter the submenu. Select the OSD language you desire using the UP/DOWN buttons, then press ENTER to confirm the setting.



'OSD' Display Menu

- b. Select 'Subtitle' using the UP/DOWN buttons, then press ENTER to enter the submenu. Select the 'Subtitle' language you desire using the UP/DOWN buttons, then press ENTER to confirm the setting.



'Subtitle' Display

- c. Select "Audio" using the UP/DOWN buttons, then press ENTER to enter the submenu. Select the audio language you desire using the UP/DOWN buttons, then press ENTER to confirm the setting.



'Audio' Display

- d. Select 'DVD Menu' using the UP/DOWN buttons, then press ENTER to enter the submenu. Select the 'DISC Menu' language you desire using the UP/DOWN buttons, then press ENTER to confirm the setting.



'DVD Menu' Display

2) Select 'Video' by using the LEFT/RIGHT buttons, press ENTER to enter the Video set up page.



'Video' Display

a. Select 'TV Shape' using the UP/DOWN buttons, then press ENTER to enter the submenu. Select the TV shape you desire using the UP/DOWN buttons, then press ENTER to confirm the setting.



'TV Shape' Display

- * 4:3/PS: When the player is connected to a normal TV, and a wide picture is shown on the full screen.
- * 4:3/LB: When the player is connected to a normal TV, and a wide picture is shown on the screen with a black strip at both the top and bottom of the screen.
- * 16:9: When the player is connected to a wide screen TV, a wide picture is shown on the full screen.

- b. Select 'TV System' using the UP/DOWN buttons, then press ENTER to enter the submenu. Select the TV System you desire using the UP/DOWN buttons, then press ENTER to confirm the setting.



'TV System' Display

- c. Select 'BRIGHTNESS' using the UP/DOWN buttons and then press ENTER to enter the submenu. Choose Brightness on or off using the UP/DOWN buttons, then press ENTER to confirm the setting.



'Brightness' Display

- d. Select 'EDGES' using the UP/DOWN buttons and then press ENTER to enter the submenu. Choose Edges on or off using the UP/DOWN buttons, then press ENTER to confirm the setting.



'Edges' Display

NOTE: Brightness and edges on/off will enable or disable this feature.

3) Select language using the LEFT/RIGHT buttons, press ENTER to enter the 'AUDIO' setup page.



'AUDIO' Display Menu

a. Select 'AC3' using the UP/DOWN buttons, then press ENTER to enter the submenu. Select the digital output you desire using the UP/DOWN buttons, then press ENTER to confirm the setting.



'AC3' Display Menu

- b. Select 'DTS' using the UP/DOWN buttons, then press ENTER to enter the submenu. Select the digital output you desire using the UP/DOWN buttons, then press ENTER to confirm the setting.



'DTS' Display

- c. Select 'MP3/WMA' using the UP/DOWN buttons, then press ENTER to enter the submenu. Select the digital output you desire using the UP/DOWN buttons, then press ENTER to confirm the setting.



'MP3/WMA' Display

- d. Select 'others' using the UP/DOWN buttons, then press ENTER to enter the submenu. Select the digital output you desire using the UP/DOWN buttons, then press ENTER to confirm the setting.



'Others' Display

- 4) Select 'Rating' by using the LEFT/RIGHT buttons, press ENTER to enter the Rating set up page.



'Rating' Display

Select 'Password' using the UP/DOWN buttons. For first time use the default password 3308 to unlock the unit. Select 'Rating' using the UP/DOWN buttons and press ENTER to enter the submenu. Select the rating level you desire by repeatedly pressing the ENTER button. Use the UP button to return to 'Password' and input either the default password or any new 4 digit password and press ENTER.

Rating:1.Kid Safe 2.G 3.PG 4.PG-13
5.PG-R 6.R 7.NC-17 8.Adult

NOTE: For 1st time use the default password is 3308.

NOTE: The Default Password is **3308**. This password is always effective even after you have selected your own password and changed it. To avoid the possibility of others using the default password to set the parental level and change the password, you can record this default password in another area and delete it from this manual. Some discs can be limited depending on the age of users while some discs can not.

Restore Default: To restore all of the options to the default settings select 'RESTORE DEFAULT' using the UP/DOWN buttons and press ENTER. This will return all of the settings except parental to the default settings.

H. Specification

Supported media	DVD/CD/VCD/MP3/JPEG CD-R
Signal format system	NTSC/PAL
DVD Video format	Horizontal 720 pixel, vertical 480 pixel
Video output	1.0 Vp-p/75 Ohm
Audio output	1.2 V to 1.8 V
Signal-to-noise ratio	More than 60 dB
Harmonic distortion	Less than 60 dB
Dynamic range	More than 70 dB
Wow and flutter	Beyond measurable Limits
Power source	DC 12 V Regulated
Power consumption	Less than 1W in stand-by mode; and less than 12W in use
Operating temperature	0°C (32°F) to +40°C (104°F)
Storage temperature	-20°C (-4°F) to +60°C (140°F)
Operating humidity	5% to 95%
Dimensions (W x H x D)	7 x 2 x 7.3 inches (178 x 50 x 186 mm)
Weight	3 lbs (1.6 kg)



90 DAY LIMITED WARRANTY

Applies to Audiovox Video Products

AUDIOVOX ELECTRONICS CORP. (the Company) warrants to the original retail purchaser of this product that should this product or any part thereof, under normal use and conditions, be proven defective in material or workmanship within 90 days from the date of original purchase, such defect(s) will be repaired or replaced with reconditioned product (at the Company's option) without charge for parts and repair labor.

To obtain repair or replacement within the terms of this Warranty, the product is to be delivered with proof of warranty coverage (e.g. dated bill of sale), specification of defect(s), transportation prepaid, to the Company at the address shown below.

This Warranty does not extend to the elimination of externally generated static or noise, to correction of antenna problems, to costs incurred for installation, removal or reinstallation of the product, or to damage to tapes, discs, speakers, accessories, or electrical systems.

This Warranty does not apply to any product or part thereof which, in the opinion of the Company, has suffered or been damaged through alteration, improper installation, mishandling, misuse, neglect, accident, or by removal or defacement of the factory serial number/bar code label(s). THE EXTENT OF THE COMPANY'S LIABILITY UNDER THIS WARRANTY IS LIMITED TO THE REPAIR OR REPLACEMENT

PROVIDED ABOVE AND, IN NO EVENT, SHALL THE COMPANY'S LIABILITY EXCEED THE PURCHASE PRICE PAID BY PURCHASER FOR THE PRODUCT.

This Warranty is in lieu of all other express warranties or liabilities. ANY IMPLIED WARRANTIES, INCLUDING ANY IMPLIED WARRANTY OF MERCHANTABILITY, SHALL BE LIMITED TO THE DURATION OF THIS WRITTEN WARRANTY. ANY ACTION FOR BREACH OF ANY WARRANTY HEREUNDER INCLUDING ANY IMPLIED WARRANTY OF MERCHANTABILITY MUST BE BROUGHT WITHIN A PERIOD OF 15 MONTHS FROM DATE OF ORIGINAL PURCHASE. IN NO CASE SHALL THE COMPANY BE LIABLE FOR ANY CONSEQUENTIAL OR INCIDENTAL DAMAGES FOR BREACH OF THIS OR ANY OTHER WARRANTY, EXPRESS OR IMPLIED, WHATSOEVER. No person or representative is authorized to assume for the Company any liability other than expressed herein in connection with the sale of this product.

Some states do not allow limitations on how long an implied warranty lasts or the exclusion or limitation of incidental or consequential damage so the above limitations or exclusions may not apply to you. This Warranty gives you specific legal rights and you may also have other rights which vary from state to state.

U.S.A. : AUDIOVOX ELECTRONICS CORPORATION, 150 MARCUS BLVD.,
HAUPPAUGE, NEW YORK 11788 1-800-645-4994

CANADA : CALL 1-800-645-4994 FOR LOCATION OF WARRANTY STATION
SERVING YOUR AREA

128-5556C



For Customer Service
Visit Our Website At

www.audiovox.com

Product Information, Photos,
FAQ's Owner's Manuals

Free Manuals Download Website

<http://myh66.com>

<http://usermanuals.us>

<http://www.somanuals.com>

<http://www.4manuals.cc>

<http://www.manual-lib.com>

<http://www.404manual.com>

<http://www.luxmanual.com>

<http://aubethermostatmanual.com>

Golf course search by state

<http://golfingnear.com>

Email search by domain

<http://emailbydomain.com>

Auto manuals search

<http://auto.somanuals.com>

TV manuals search

<http://tv.somanuals.com>