

# AVXMTGHR1M

## 7" LCD MONITOR

### FOR REAR SEAT ENTERTAINMENT

**Audiovox** **MTG**

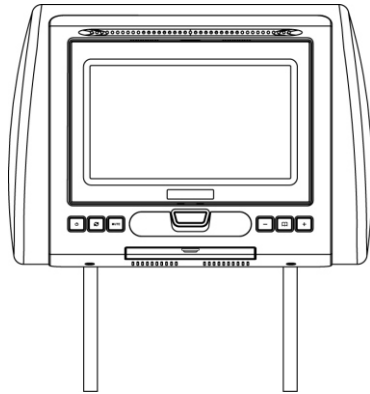

**ATTENTION** This product is designed for use on 2009 and prior model year vehicles. It is not lawful to install on 2010 model year vehicles or later.

**MISE EN GARDE** Ce produit est destiné à être utilisé sur des véhicules de modèles 2009 et antérieurs. Il est illégal de l'installer sur des modèles 2010 et plus récents.

**ATENCIÓN** Este producto está diseñado para utilizarse en vehículos modelo 2009 y anteriores. Es ilegal instalarlo en vehículos modelo 2010 y posteriores.

OPERATION MANUAL / INSTALLATION GUIDE



128-8945A

## **Important Notice**

Installation of headrest products require careful planning and preparation. Be extremely careful of seats that have airbags built into them. Keep wiring away from any air bag wiring (usually identified by yellow connectors and yellow wire jackets). Damage to air bag wiring can result in personal injury to vehicle occupants. If you have any questions regarding wire routing or installation in a vehicle, please contact Audiovox Technical Support at 1-800-225-6074.

When connecting power and ground in a mobile video installation, insure that the ACC wire is fused at the point where it is connected to the vehicle ACC wiring. Failure to do so can result in damage to the vehicle if a short circuit develops between the vehicle connection point and the mobile video product.

An LCD panel and/or video monitor may be installed in a motor vehicle and visible to the driver if the LCD panel or video monitor is used for vehicle information, system control, rear or side observation or navigation. If the LCD panel or video monitor is used for television reception, video or DVD play, the LCD panel or video monitor must be installed so that these features will only function when the vehicle is in "park" or when the vehicle's parking brake is applied.

An LCD panel or video monitor used for television reception, video or DVD play that operates when the vehicle is in gear or when the parking is not applied must be installed to the rear of the driver's seat where it will not be visible, directly or indirectly, to be operator of the motor vehicle.

Licensed under one or more of the following patents:

Patent NOS. 7,245,274 , 6,899,365 and 6,678,892

## **FEATURES**

- 7" Digital TFT (Thin Film Transistor) Active Matrix LCD (Liquid Crystal Display) Monitor
- OSD (On Screen Display) for control of picture quality and functions
- Two Audio / Video Source inputs (AV and AUX).
- Screen mode selection (4:3, 16:9)
- Full function remote control
- IR headphone (optional)

## **SPECIFICATIONS**

Type	TFT Active Matrix LCD
Resolution	480x234
Pixels	336,960
Operation Temperature	32 ~113° F (0 ~ 45° C)
Storage Temperature	-4 ~ 149° F (-20 ~ 65° C)
Backlit life	20,000 Hours
Video Display System	NTSC / PAL
Headphone Audio Output	0.03W @ 32 ohms
Power Source	10V~16V DC
Dimension (L x W x H)	147mm x 275mm x 200mm 5.7in x 10.8in x 7.8in

Specifications subject to change without notice.

# **MATERIAL TO USE IN THIS PACKAGE:**

1) AVXMTGHR1M System Monitor (AVXMTGHR1M )

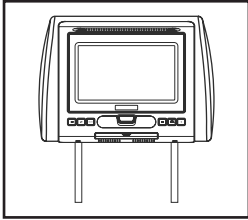

**NOTE:** The AVXMTGHR1M monitor has been designed to be interchangeable from one headrest to the other. The headrests will still have the Red Din cables on them and should be connected to their respective connectors. The headrest cover from the manufacturer is covered with shale colored vinyl.

**NOTE:** Headrest cable is included with the monitor.

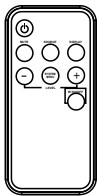

1) Remote Control  
(P/N 136-5151)-(1pc)

2) AUX PIGTAIL  
(P/N 112B3227 )-(1pc)



3) 8PIN (Male) AV OUT to RCA  
(P/N 112-4149)-(1pc)

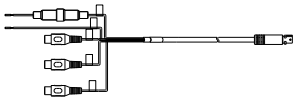

5) Heat Shrink Tube  
(P/N 138-1495)-(1pc)

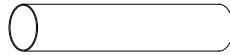

5) Black Vinyl Headrest Cover  
(P/N 126-1377)-(1pc)

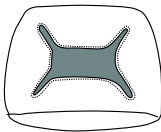

6) Pewter Vinyl Headrest Cover  
(P/N 126-1378)-(1pc)

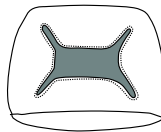

4) Support Tube Adaptor Box  
(P/N 170-0161)-(1box)

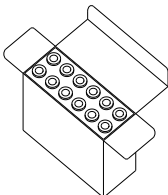

## **HEADREST COVER REPLACEMENT:**

**NOTE:** If desired, replace the headrest cover before installing the headrest in the vehicle.

1. Using a Philips screwdriver, unscrew the two Philips screws and lift the bottom edge of the monitor upward.

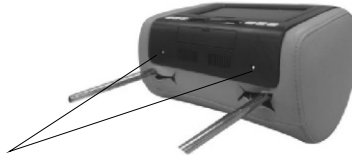

Unscrew Philips Screws

2. Remove the velcro tabs securing the headrest cover.

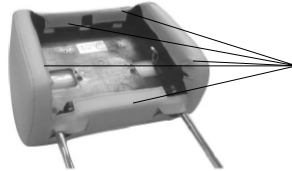

Remove Velcro Tabs

3. Replace the headrest cover with the desired color and secure the headrest cover by re-attaching the velcro tabs.



4. Place the monitor cable into the space on the right side of the headrest and lower the monitor into position to align the two Philips screws with the screw holes in the headrest. Close the screen and press the PUSH button to secure the screen.

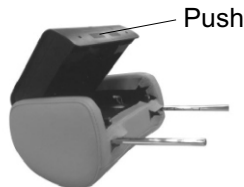

5. Tighten screws



Tighten Philips Screws

## VEHICLE PREPARATION

- 1) Decide on the system configuration and the options that will be installed.
- 2) Read the manuals and get familiar with the electrical requirements and connections.
- 3) Decide on the mounting locations and methods of mounting the products that will be connected to the AVXMTGHR1M.
- 4) Prepare the vehicle by removing any interior trim necessary to gain access to the vehicle's wiring as well as all areas where interconnecting wire harnesses will be located. The mounting method, and the location will vary from vehicle to vehicle, so this manual will only focus for the installation of the AVXMTGHR1M Monitors in the supplied configuration. The best location for the AVXMTGHR1M System components is:
  - a. Monitors: Vehicle specific Headrest **NOTE:** The Master Monitor should be installed in the passenger position most used.)
- 5) Locate an accessory power source (+12VDC present when the ignition key is in the accessory and run positions. 0VDC should be present when the ignition key is in the OFF position), a constant power source (+12VDC) at all times, regardless of the ignition key and a good ground. Generally, these wires can be found at the ignition switch or fusebox.

**NOTE:** Ensure that both the constant and accessory power is fused at the source. Failure to do so may result in vehicle wiring damage.
- 6) Run the wiring harnesses throughout the vehicle as necessary. (Refer to the Wiring Diagrams on page 7, as well as the wiring instructions for the individual components and accessory options being installed). Be sure, that all the wiring is protected from sharp edges and is routed in such a manner that it will not be pinched, when it is fully installed. Be sure to leave enough slack in the wiring at each component to allow sufficient working room. Be sure to leave enough slack in the monitor cables to allow the headrest to move up or down, and seat movement.
- 7) Remove all the A/V system components from their packaging and then place them in the vehicle at their respective locations.
- 8) Install the headrests:
  - a. Remove vehicle's original headrests.
  - b. insert appropriate support tube adaptors in vehicle post guides. (if needed)
  - c. Hold the headrest above the seat and insert the two cables into the vehicle support guides Make sure that the headrest is in the correct position (Display facing the rear).
  - d. Route the cables through the seat back and out the bottom of the seat while pulling the cables to remove the slack. Be sure to leave enough slack in the monitor cables to allow the headrest to move up or down.
- 9) Connect all the components together (electrically) and verify proper operation of all the system functions.

# AVXMTGHR1M WIRING DIAGRAM

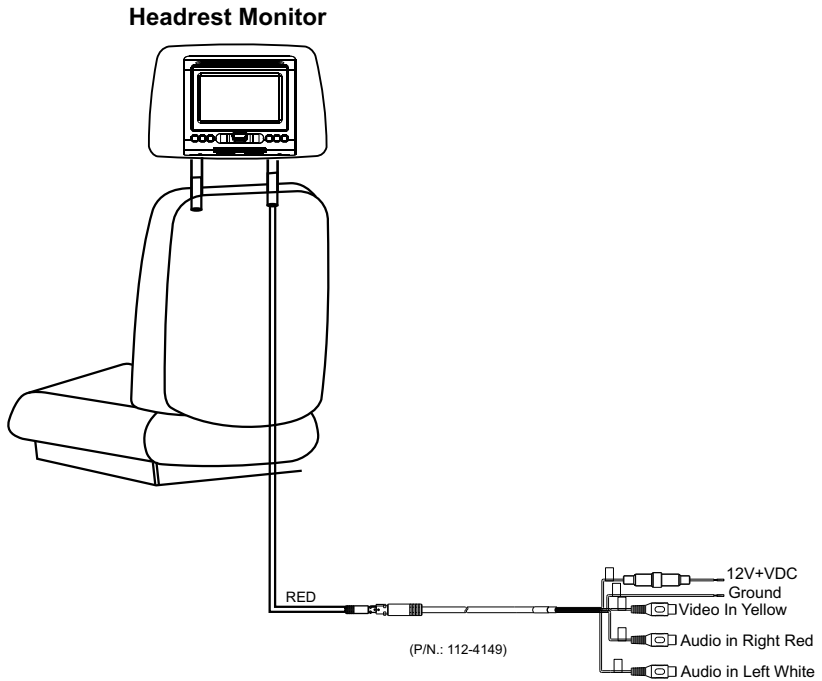

## CONTROLS AND INDICATORS DIAGRAM (FRONT VIEW)

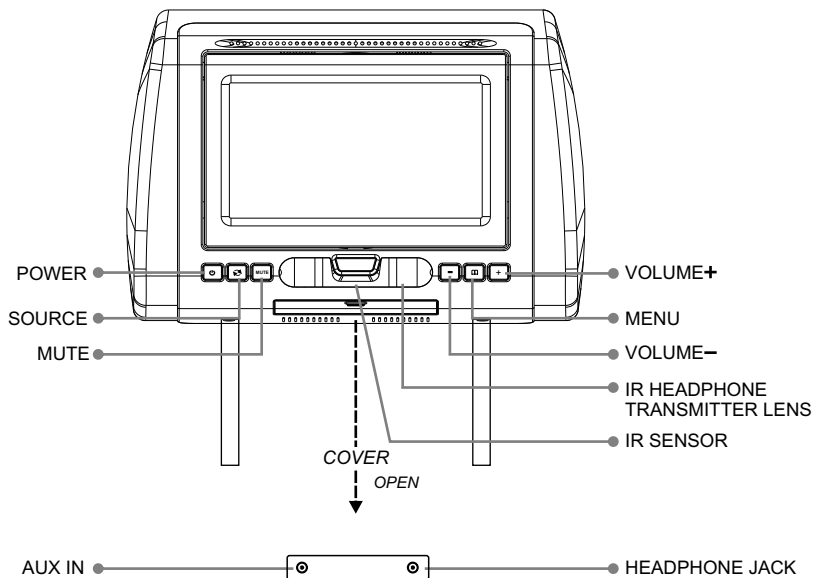

## REMOTE CONTROL OPERATION

**NOTE:** The remote control has a battery installed with a pull tab to prevent battery discharge. Remove the pull tab before attempting to use the remote.

### **Battery Replacement**

1. Remove the battery holder.
2. Insert the battery (CR2025) into the battery holder and insert the battery holder into the remote. Be sure to observe the correct polarity.
3. Align the battery holder with the remote control and push until the holder clicks.

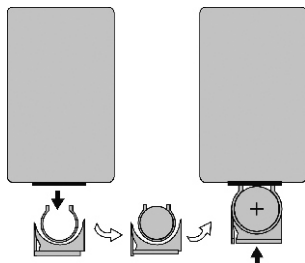



## Remote Control Function Description

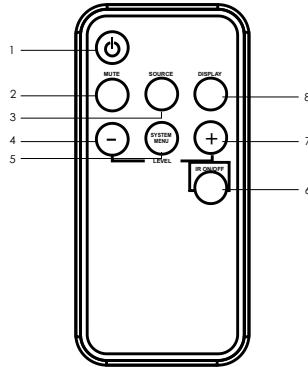

### 1. **POWER (⏻) Button\***

Press this button to turn the unit ON and OFF.

### 2. **MUTE Button**

Press this button to mute all the audio. Pressing the button again restores the sound to the previously set level.

### 3. **SOURCE Button**

Each time the button is pressed, the audio / video source will change in the following sequence:

AV1 > AUX

### 4. **VOLUME DOWN (-) Button**

Press to select the level of the picture adjustments when the unit is in picture adjustment mode or to decrease the volume for the wired headphones.

### 5. **SYSTEM MENU Button**

Press this button to enter the system menu which contains features and options to customize the screen display and change the OSD language.

### 6. **IR ON/OFF Button**

Press this button to turn the IRT function on or off.

### 7. **VOLUME UP (+) Button**

Press to select the level of the picture adjustments when the unit is in picture adjustment mode or to increase the volume for the wired headphones.

### 8. **DISPLAY Button**

Press to display current disc information while the disc is playing. The information displayed will be Title Elapsed, Title Remaining, Chapter Elapsed and Chapter Remaining. Pressing the button will also turn the display off.

## **MENU ADJUSTMENT**

The System Menu contains features and options that allow you to customize your system.

- 1) Press the “**⏏**” button on unit or press the TV button and the SYSTEM MENU button on the remote control, the menu display below will appear on screen.
- 2) Use the “+” “-” buttons to change the setting.
- 3) To select the next menu press the “**⏏**” button or the SYSTEM MENU button on the remote control.

## **MENU DISPLAY**

The first adjustment to appear is the volume adjustment. The volume can be adjusted from 1 to 32.



The picture can be adjusted under the system menu. The picture adjustments consist of brightness (BRIGHT), CONTRAST, COLOR, TINT (for NTSC only). The adjustments range from 1 to 32.



The screen mode select feature allows the user to change the screen format (aspect ratio from 4:3 or to 16:9).



The IRT can be set to Channel A or Channel B for use with optional wireless headphones. The default channel is Channel B. The IRT function can also be set to off.



The OSD Language feature allows the user to select the language for the on-screen display. The user can either select English, Dutch, French, Spanish, Russian or Chinese for the OSD language.

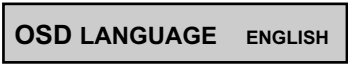

The RESET function allows all setting options to be reset to factory settings.





## 12 MONTH LIMITED WARRANTY

*Applies to Movies To Go Mobile Video Products*

AUDIOVOX ELECTRONICS CORP. (the Company) warrants to the original retail purchaser of this product that should this product or any part thereof, under normal use and conditions, be proven defective in material or workmanship within 12 months from the date of original purchase, such defect(s) will be repaired or replaced with reconditioned product (at the Company's option) without charge for parts and repair labor. A game controller, if supplied, is similarly warranted for ninety (90) days.

To obtain repair or replacement within the terms of this Warranty, the product is to be delivered with proof of warranty coverage (e.g. dated bill of sale), specification of defect(s), transportation prepaid, to the Company at the address shown below.

This Warranty does not extend to the elimination of externally generated static or noise, to correction of antenna problems, to costs incurred for installation, removal or reinstallation of the product, or to damage to digital memory/media devices, gaming devices, discs, speakers, accessories, or vehicle electrical systems.

This Warranty does not apply to any product or part thereof which, in the opinion of the Company, has suffered or been damaged through alteration, improper installation, mishandling, misuse, neglect, accident, or by removal or defacement of the factory serial number/bar code label(s). THE EXTENT OF THE COMPANY'S LIABILITY UNDER THIS WARRANTY IS LIMITED TO THE REPAIR OR REPLACEMENT PROVIDED ABOVE AND, IN NO EVENT, SHALL THE COMPANY'S LIABILITY EXCEED THE PURCHASE PRICE PAID BY PURCHASER FOR THE PRODUCT.

This Warranty is in lieu of all other express warranties or liabilities. ANY IMPLIED WARRANTIES, INCLUDING ANY IMPLIED WARRANTY OF MERCHANTABILITY, SHALL BE LIMITED TO THE DURATION OF THIS WRITTEN WARRANTY. ANY ACTION FOR BREACH OF ANY WARRANTY HEREUNDER INCLUDING ANY IMPLIED WARRANTY OF MERCHANTABILITY MUST BE BROUGHT WITHIN A PERIOD OF 24 MONTHS FROM DATE OF ORIGINAL PURCHASE. IN NO CASE SHALL THE COMPANY BE LIABLE FOR ANY CONSEQUENTIAL OR INCIDENTAL DAMAGES FOR BREACH OF THIS OR ANY OTHER WARRANTY. No person or representative is authorized to assume for the Company any liability other than expressed herein in connection with the sale of this product.

Audiovox Electronics Corporation,  
150 Marcus Blvd., Hauppauge, New York 11788 | 1-800-645-4994

128-6429F

## NOTES

## NOTES

## NOTES



For Customer Service  
Visit Our Website At  
[www.mobile.audiovox.com](http://www.mobile.audiovox.com)  
Product Information, Photos,  
FAQ's Owner's Manuals



## Free Manuals Download Website

<http://myh66.com>

<http://usermanuals.us>

<http://www.somanuals.com>

<http://www.4manuals.cc>

<http://www.manual-lib.com>

<http://www.404manual.com>

<http://www.luxmanual.com>

<http://aubethermostatmanual.com>

Golf course search by state

<http://golfingnear.com>

Email search by domain

<http://emailbydomain.com>

Auto manuals search

<http://auto.somanuals.com>

TV manuals search

<http://tv.somanuals.com>