

HR7008APKG

Two Custom Vehicle Headrests
with 7" LCD Monitors Touch Screen Control
and Built-in
DVD Player for Rear Entertainment

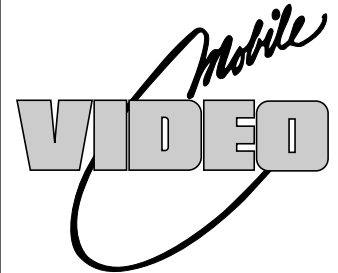
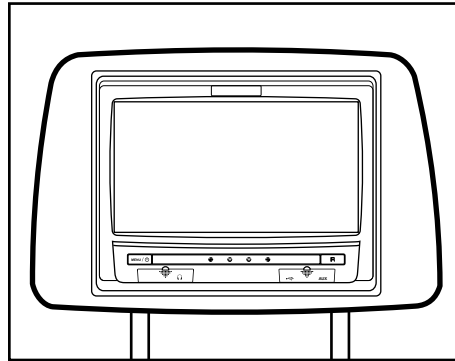
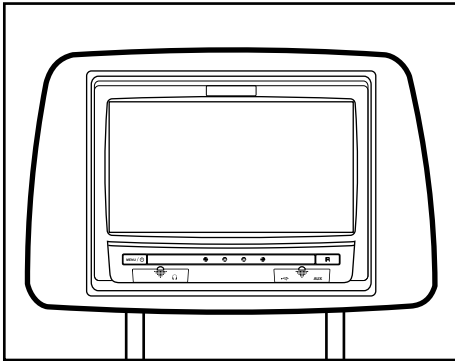

**OPERATION
MANUAL**

IMPORTANT

An LCD panel and/or video monitor may be installed in a motor vehicle and visible to the driver if the LCD panel or video monitor is used for vehicle information, system control, rear or side observation or navigation. If the LCD panel or video monitor is used for television reception, video or DVD play, the LCD panel or video monitor must be installed so that these features will only function when the vehicle is in “park” or when the vehicle’s parking brake is applied.

An LCD panel or video monitor used for television reception, video or DVD play that operates when the vehicle is in gear or when the parking is not applied must be installed to the rear of the driver’s seat where it will not be visible, directly or indirectly, to be operator of the motor vehicle.

An LCD panel or video monitor used for television reception, video or DVD play that operates when the vehicle is in gear or when the parking is not applied must be installed to the rear of the driver’s seat where it will not be visible, directly or indirectly, to be operator of the motor vehicle.

Licensed under one or more of the following patents:

Patent NOS. 7,245,274 and 6,899,365

HR7008APKG

The HR7008APKG contains two vehicle specific head-rests. Each has a 7" Monitor with touch screen control and built-in DVD Player. This system allows the users to either watch individual DVD's or watch the same DVD on both monitors. Both users can also share each others program. The full function remote control can operate either unit by selecting M1 or M2 on the remote.

Quick Start Guide

1. Turn on the **M1 monitor, to gain access to the DVD slot push at the top center of the screen frame, the screen will tilt forward.**
2. Insert a DVD, CD or MP3 disc into the slot, disc label toward driver. Push down gently on the disc until the player pulls the disc in.
3. Use the touch screen to access the DVD mode.
4. Tilt the monitor to a comfortable viewing position (the headrest itself can be tilted forward to help achieve a comfortable viewing position).
5. Each wireless headphone has a CH A/CH B switch. Turn the volume down to its lowest setting before putting them on your head. When sitting in front of the **M1** screen, use the CH A switch setting. When sitting in front of the **M2** screen, use the CH B switch setting. Set the headphone to the proper channel and press the Power On/Off switch. The power indicator will light up red.
6. When the DVD menu appears, select the menu item using the cursor keys and touch the **OK** or play button.
7. If audio playback through the vehicle radio is preferred, use the FM transmitter On/Off button on the remote control. Set the vehicle radio to the channel selected on the M1 monitor. If interference with a local radio station occurs, set the FM modulator to one of the other 15 radio frequencies using the CHANNEL SELECT button on the remote control.
8. Turn on the **M2 Monitor** using the power button on the front of the screen or remote control.
9. Tilt the screen to a comfortable viewing position (the headrest itself can be tilted forward to help achieve a comfortable viewing position).
10. Touch the screen and touch on M1 or use remote control to press SOURCE button to view program from M1 or select from the other available sources DVD, MEMORY CARD, USB, AV, AUX and MEDIA for M2 Monitor.

NOTE: To operate the M1 screen, press M1 on the remote control.
To operate the M2 screen, press M2 on the remote control.

HR7008APKG SYSTEM OVERVIEW

- 1) The HR7008APKG SYSTEM is a versatile headrest system. The headrests are referred to as M1 and M2 in this manual.
- 2) The M1 Monitor is comprised of a 7" Touch Screen TFT LCD monitor with built-in DVD player that allows the user to select from several sources (DVD, SD, USB, M2, AV, AUX, MEDIA and GAME Source). The M1 monitor has a built-in infrared audio transmitter channel (CH A) for use with the two-channel wireless headphones (CH A)
NOTE: When the DVD menu appears on the screen, touch the desired DVD menu selection to start the DVD playing. Refer to page for 6 operation.
- 3) The M2 monitor is comprised of a 7" Touch Screen TFT LCD monitor with built-in DVD player that allows the user to select from several sources (DVD, SD, USB, M1, AV, AUX and MEDIA Source). The M2 monitor has a built-in infrared audio transmitter channel (CH B) for use with the two-channel wireless headphones (CH B).
NOTE: When the DVD menu appears on the screen, touch the desired DVD menu selection to start the DVD playing. Refer to page for 6 operation.
- 4) The monitors will display all of the functions with the comprehensive Graphical User Interface (GUI) and can be accessed using the touch screen.
- 5) The two-channel wireless headphone sets have an A-B switch that allow the users to select the audio from either the M1 (CH A) or the M2 (CH B).
- 6) When using the IR remote control, the M1 Monitor will only respond to the remote control unit when the Monitor Select (**M1**) button on remote control is pressed. The M2 Monitor only respond to the Remote Control unit when the Monitor Select (**M2**) button on remote control is pressed.
- 7) Optional wired headphones allow the user to listen to audio from the system.
- 8) The M1 and M2 Monitor will accept an audio / video input through the 1/8" jack located on the front of the unit. The audio / video device could be a video game system, video camera or other input device.

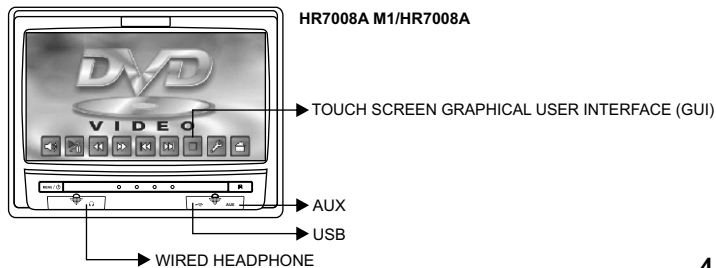

9) Press and release the screen at the top of the screen to release the screen for disc insertion. The headrest itself can be tilted forward to help achieve a comfortable viewing position. Pressing it again will lock the screen back in the closed position.

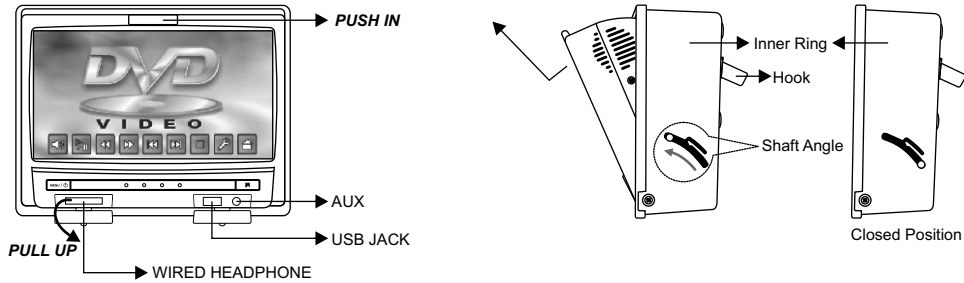

10) Insert/Eject disc and SD Card

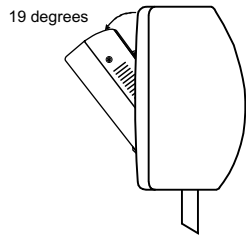
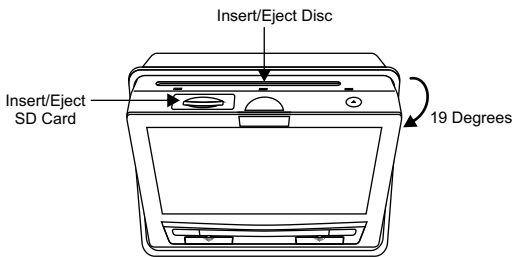

HR7008APKG Touch Screen

The touch screen of the HR7008APKG allows the user to start DVD play by touching PLAY MOVIE or any of the DVD menu features on the LCD screen.



Some DVD's will not allow this function. One method is to use the remote control instead of the touch screen. The other method is to touch any of four corners of the screen to pop up the DVD menu navigation screen (below)



Use the up/down/left/right icons to select an item from the DVD menu. Use the Enter  to start DVD play.

CONTROLS AND INDICATORS DIAGRAM

Control Function Description for M1 and M2 Monitor

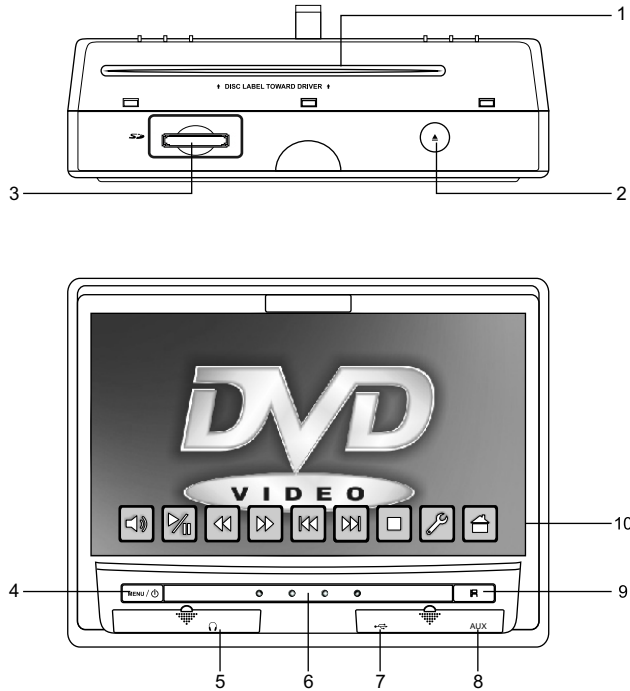

M1/M2 Panel Control

1. DVD disc insertion slot.
2. EJECT Button - Press this button to eject the disc.
3. SD Card Reader
4. MENU/POWER Button with Power Indicator LED.
5. Wired Headphone Jack
6. IR Transmitter LEDS.
7. USB Port
8. AUX Jack
9. IR Sensor
10. Graphical User Interface (GUI) Touch Screen

Touch Screen For HR7008AM1/M2

Main Page

Turn on the unit by pressing the power button located on

The lower left of the unit.

i) Touch the panel then touch the Home icon to display the Main Menu. The Main Menu can also be accessed by pressing the MENU button on the unit's front panel.

ii) The Main Menu screens for M1 and M2 contains the following icons:

M1 Unit

DVD, MEMORY CARD, USB, M2, AV, AUX, MEDIA, GAME, PIX, SCREEN OFF, MUTE, FMM.

M2 Unit

DVD, MEMORY CARD, USB, M1, AV, AUX, MEDIA, PIX, SCREEN OFF, MUTE

DVD

Touch the Main Menu DVD icon to set the source to DVD. Then insert the DVD into slot with label face toward driver. Gently push down on the disc and the disc will load automatically.



Main Menu



M1



M2

MEMORY CARD

Insert Memory Card / SD Card into SD CARD slot.

Touch the Main Menu MEMORY CARD icon to set unit' source to SD.

USB

Insert the USB to the USB Slot. Touch the Main Menu USB icon to set the unit's source to USB.

M2

Touch the Main Menu M2 icon on the M1 unit to link the M1 unit to the M2 unit. The M1 unit will now receive its AV from M2.

M1

Touch the Main Menu M1 icon on the M2 unit to link the M2 unit to the M1 unit. The M2 unit will now receive its AV from M1.

AV

Touch the Main Menu A/V icon to route external audio and video supplied to the system's AV IN RCA connectors.

NOTE: May not be available on all installations. Contact your dealer for more information.

AUX

Touch the Main Menu AUX icon to route external audio and video supplied to the unit via the cable adapter.

MEDIA

Touch the Main Menu MEDIA icon to select the MEDIA display.

GAME

Touch the Main Menu GAME icon on (for M1 only). The GAME selection is controlled by wireless game controller.

PIX

Touch the Main Menu PIX icon to gain access to the display's picture controls. The controls available are BRIGHTNESS, CONTRAST, COLOR, TINT and RESET.

Adjustment of each control is made by touching + (increase) or - (decrease), then touch

 (enter) to exit.



The on screen DVD menu of most DVD's can be used to select a DVD menu feature such as "Play Movie", "Scene Select", etc. by touching the menu item on the touch screen. For example, touching "Play Movie" in the below screen will start movie play.

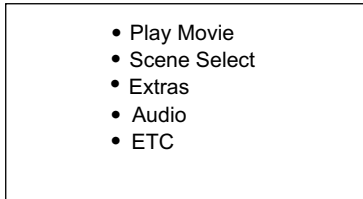

NOTE: A small number of DVD discs will not function like this. In that event use the remote control to start the movie or select the different DVD options.

MUTE

Touch the Main Menu MUTE icon to toggle the unit's audio between on and off.

SCREEN OFF

Touch the Main Menu SCREEN OFF icon and the screen will shut off. Touch the screen again to turn it back on. The screen will turn back on after cycling power.

FMM

Touch the Main Menu FM MODULATOR icon (For M1 only) to gain access to the FM Modulator controls

To turn on FM Modulator touch + or - icon, then select the FM modulator transmission frequency by touching - (decrease) or + (increase) [88.1MHz ~ 91.1MHz]. Touch  (enter) to exit. Set the vehicle radio to the selected frequency to listen to the movie over the vehicle sound system.

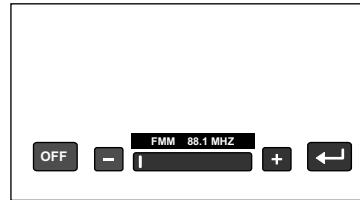

To turn off the FM Modulator function, touch OFF icon. Then touch  (enter) to exit.

REMOTE CONTROL WITH WIRELESS GAME CONTROL OPERATION

Back View

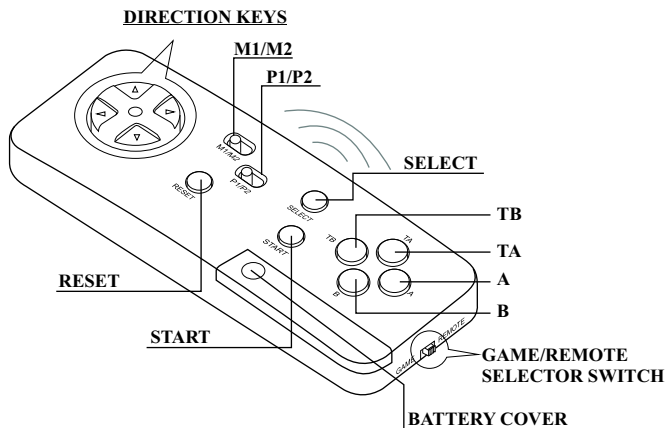

Battery Installation

Before attempting to operate your remote control, install the batteries as described below.

- 1) Turn the remote control face down. Using a finger, slide battery cover off in the direction of the arrow.
- 2) Install three "AAA" batteries. Make sure that proper polarity (+ or -) is observed.
- 3) Align the cover tabs with the remote control and slide the cover until it locks.

The remote control will operate the M1/M2. It is not a universal remote control and will not control equipment from other manufacturers.

WIRELESS GAME CONTROLLER FUNCTIONAL DESCRIPTION

1. Position the GAME/REMOTE selector switch to Game position.
2. Use the select button (page up & page down) to display the games (1-32). Then use the direction buttons to move the arrow to the desired game. Press Start to select the game.
3. A Key : "A Function Key" activates the jump and optional weapons.
4. B Key : " B Function Key" activates Bullet fire and attack.
5. TA Key : TURBO "A" Function Key.
6. TB Key : TURBO "B" Function Key.
7. Press Start to begin the game. Press Start again at any time to pause the game.
8. Press RESET to return to the game menu.
9. P1/P2 selector switch is used for playing 2 player games. P1 is M1 player, P2 is for M2 player.
10. M1/M2 selector switch to M1 position only for games.
11. Return the GAME/REMOTE selector switch to Remote position after use.

MAIN FUNCTION DESCRIPTION

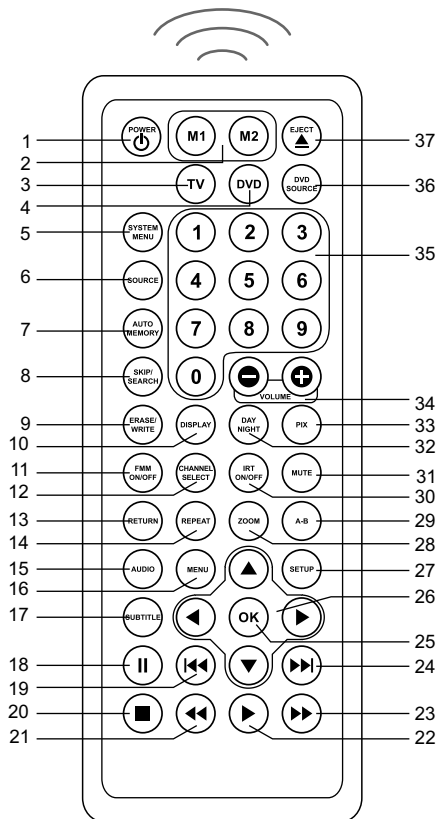

* Function control is available on the unit and the remote control.

1. POWER Button*

Press this button to turn the unit ON and OFF.

2. MONITOR SELECT

M1 Button – Sets the remote control codes to enable the control of M1 Monitor.

M2 Button – Sets the remote control codes to enable the control of M2 Monitor.

3. TV Mode Select Button

TV function not available in this model.

Note: Pressing the TV button will disable the DVD, SD, and USB functions. To regain control of the functions, press the DVD button.

4. DVD Mode Select Button*

Switches certain function keys on the remote control for DVD functions. See page 13.

Note: Pressing the TV button will disable the DVD, SD, and USB functions. To regain control of the functions, press the DVD button.

5. SYSTEM MENU Button

Function not available in this model.

6. SOURCE Button*

For M1: Each time the button is pressed, the audio / video source will change in the following sequence:
DVD > M2 > AV > AUX > MEDIA > GAME.

For M2: Each time the button is pressed, the audio / video source will change in the following sequence:
DVD > M1 > AV > AUX > MEDIA.

7. AUTO MEMORY Button (AUTO PROGRAM Button)

Function not available in this model.

8. SKIP / SEARCH Button

Function not available in this model.

9. ERASE / WRITE Button

Function not available in this model.

10. DISPLAY

Press to display current disc information while the disc is playing. Press cursor (▲▼) buttons to select the Title or Chapter. For Title/Chapter selection use the numeric buttons to enter the desired Title Chapter selection.

11. FMM ON/OFF Button*

Turn the wireless FM Modulator on or off.

12. CHANNEL SELECT Button*

Select the wireless FM Modulator Frequency:

(**CH1** 88.1MHz, **CH2** 88.3MHz, **CH3** 88.5MHz, **CH4** 88.7MHz, **CH5** 88.9MHz, **CH6** 89.1MHz, **CH7** 89.3MHz, **CH8** 89.5MHz, **CH9** 89.7MHz, **CH10** 89.9MHz, **CH11** 90.1MHz, **CH12** 90.3MHz, **CH13** 90.5MHz, **CH14** 90.7MHz, **CH15** 90.9MHz, **CH16** 91.1MHz).

13. RETURN Button

Press Return Once: Go to disc menu.

Press Return Twice: Go to movies playback.

14. REPEAT Button

Allows the user to repeat a selected title, chapter or track.

15. AUDIO Button

Press to display and select the available AUDIO languages in DVD mode. Each time you press the button, the language changes.

Note: *The audio languages vary from disc to disc.*

16. MENU Button

Pressing the MENU button in DVD mode will cause the DVD root menu to be displayed. When using the SD card or a USB device, pressing the MENU button will cause the root menu to be displayed. Pressing the MENU button while listening to MP3 files has no effect. The operation is prohibited.

Note: *Pressing the TV button will disable the DVD, SD, and USB functions. To regain control of the functions, press the DVD button.*

17. SUBTITLE Button

Press to display and select the available subtitle language in DVD mode. Each time you press the button, the subtitle language changes.

Note: *The type and number of subtitle languages vary from disc to disc.*

18. PAUSE (II) Button*

Allows the user to pause the playback. Pressing pause again or pressing the Play Button will resume normal playback.

19. PREVIOUS (⏮) Button*

Press to return to the previous chapter or track.

20. STOP (■) Button*

Press to stop playback.

21. SCAN BACKWARD (⏪) Button*

Press to search in the backward direction. Press repeatedly to change the search speed from 2, 4, 8 and 16 times the normal speed.

22. PLAY (▶) Button*

Press to activate the play mode when a disc is loaded in the disc compartment.

23. SCAN FORWARD (▶▶) Button*

Press to search in the forward direction. Press repeatedly to change the search speed from 2, 4, 8 and 16 times the normal speed.

24. NEXT (▶▶) Button*

Press to skip to the next chapter or track.

25. OK Button (ENTER)*

Used to implement a selected setting or menu option.

26. CURSOR (▲▼◀▶)*

Use these buttons to navigate the menu selection on the screen.

27. SETUP Button

Press the DVD button and SETUP button to display the Setup Menu which allows the user to change the DVD player options such as OSD Language, Video, Rating etc. Refer to the settings and adjustment section for more information.

28. ZOOM Button

Press this button to enlarge the picture when playing a DVD disc.

<u>Press ZOOM button</u>	<u>DVD Player perform</u>
Once	Enlarge the picture
Twice	Enlarge the picture
3 Times	Enlarge the picture
4 Times	Picture is returned to original size

29. A-B Button

Allow user to repeat disc playback from point A to point B.

<u>Press A-B button</u>	<u>On-Screen Display</u>	<u>DVD Player</u>
Once	Repeat A-	Mark the beginning of the section to repeat (Set point A)
Twice	Repeat A-B	Mark the end of the section to repeat (Set point B)
3 Times	AB Off	Cancel the A-B repeat function

30. IRT ON/OFF Button

Turn the Infrared Transmitter ON or OFF for IR Wireless Headphones. Pressing M1 then IRT ON/OFF will control the IR Transmitter for M1. Pressing M2 then IRT ON/OFF will control the IR Transmitter for M2.

31. MUTE Button*

Press this button to mute all the audio.

Pressing the button again restores the sound to the previously set level.

32. DAY / NIGHT Mode Button

Function not available in this model.

33. PIX Button (Picture Select)*

Each time this button is pressed, the on screen picture adjustment displays the "adjustment bar" for BRIGHTNESS, CONTRAST, COLOR, TINT or RESET. Once the desired adjustment bar is displayed, use the VOLUME (+) / VOLUME (-) button to adjust the setting. The display will automatically turn off if no adjustments are made within 6 seconds.

34. VOLUME DOWN (-) or UP (+)*

Press to select the level of the picture adjustments when the unit is in picture adjustment mode or to increase or decrease the volume for the wired headphones.

35. NUMBER Buttons

Allow the user to enter numbers 0 to 9 for selection of selection of CD tracks, DVD chapters and password.

36. DVD Source*

This button is only active when remote control is in DVD mode. Each time the button is pressed one of the source (DVD, Card Reader and USB) will be selected. If the Card Reader and USB are not plugged in, it will remain on DVD Source. Press to change source in sequence of DVD > SD > USB.

37. EJECT (▲) Button

This button is used to eject the disc.

NOTE: This function is not available on this model. Use the eject button on the DVD player.

SETTINGS AND ADJUSTMENTS

The Setup Menu contains features and options that let you customize your DVD player. For example, you can set a language for the on-screen display or control DVD playback content for children. You can use the remote control or the touch screen to navigate the setup menu.

Using the DVD Setup Menu

The Setup Menu can be accessed using either the remote control or the touch screen. To access the Setup Menu using the touch screen you must have a DVD in the unit and be in DVD Mode.

The remote control can access the DVD Setup Menu by pressing DVD and SETUP.

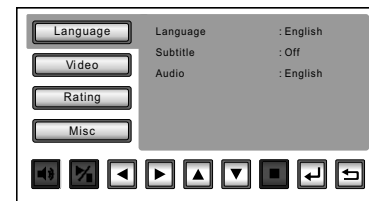

Touch Screen:

1. Touch the touch screen to bring up the DVD control menu.
2. Touch the (tool) icon to bring up the DVD Setup Menu.
3. Touch any of the four settings (Language/Video/Rating/Misc) to access the submenu for that item.
4. Touch the submenu item on the right side of the screen to select it, a submenu will appear. Touch the submenu item to select it.
5. Touch the RETURN icon to return to the DVD movie.

Note: The cursor keys at the bottom of the screen can be used to navigate through the touch screen menu.

Remote Control:

1. Press DVD and SETUP on the remote control to bring up the DVD Setup Menu.
2. Use the UP/DOWN buttons to select any of the four settings (Language/Video/Rating/Misc) to access the submenu for that item.
3. Use the RIGHT ARROW button to highlight the desired menu item. A submenu will appear. Use the UP/DOWN arrow button to highlight the desired submenu item. Press the OK key to set the item.
4. Use the LEFT ARROW button to return to the settings on the left.
5. Use the SETUP button on the remote control to exit the DVD Setup Menu and return to the movie.

LANGUAGE SETUP

Language for On-Screen Display

OSD MENU: The OSD MENU setup allows you to select the language for the on-screen display.

The user can either select English, French, Spanish, German or Italian for the OSD language.



SUBTITLE SETUP

Select "SUBTITLE" using ▲▼button, then press ►button to enter the Sub menu. Select the subtitle you desire using ▲▼button, then press **OK** /  to confirm the setting. Press ◀button to return.

Note: The subtitle selection is only available for discs that are recorded in the above listed languages. If the selected, language is not available, the player will play and display on the screen the original language contained in the disc.

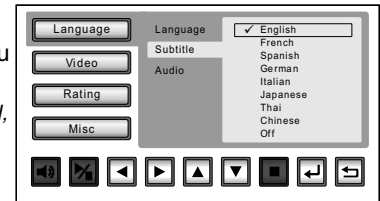

AUDIO SETUP

Select "AUDIO" using ▲▼button, then press ►button to enter the Sub menu. Select the audio you desire using ▲▼button, then press **OK** /  to confirm the setting. Press ◀button to return.

Note: The audio selection is only available for discs that are recorded in the above listed languages. If the selected, language is not available, the player will play and display on the screen the original language contained in the disc.

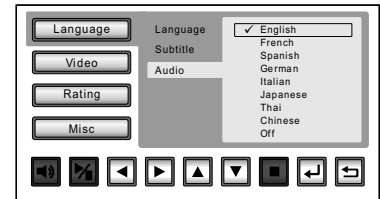

VIDEO SETUP

TV Display

The TV DISPLAY setup allows you to adjust screen setting (aspect ratio) from 4:3 or 16:9. Depending on the DVD format, the screen will appear full or with black bands.

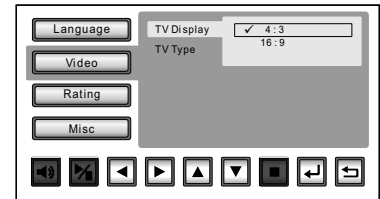

TV Type

The TV Type setup allows you to select the system to fit to the color system of the TV to be connected.

NTSC - Select this type for NTSC TV

PAL - Select this type for PAL TV

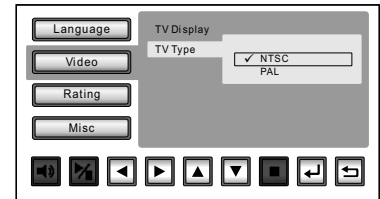



RATING SETUP

Parental Control

This item allows you to limit the content of movie playback from G to Adult. The lower the value, the more strict the control.



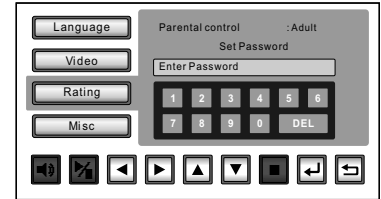
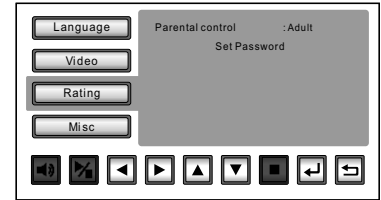

1. G
2. PG
3. PG – 13
4. R
5. NC – 17
6. Adult

The rating level can only be changed when the correct password is provided. For first time use to change the parental control, use cursor ► button to enter parental mode. Press **OK** /  and key in the default password (3308) and press **OK** / .

Press **OK** /  button again to select the parental level, select the level and press **OK** / .



Change Password

To change the password to your own password select “Set Password” mode and press **OK** / . Enter the default password (3308) and press **OK** / . Press **OK** /  button again and key in a new four digit password. A prompt will appear to “Confirm Password” Enter the new password again and press **OK** / . You will then see a prompt that states “Set Password Successful”.

Note: The Default Password is 3308. This password is always effective even after you have selected your own password and changed it. To avoid the possibility of others using the default password to set the parental level and change the password, you can record this default password in another area and delete it from this manual. Playback of some discs can be limited depending on the age of users while some discs cannot.

Misc SETUP

Select "MISC" using ▲▼ button, then press ► button to enter the Misc menu. Select the option you want to change using ▲▼ button, then press "OK" / .

Use Default Setting

This option allows you to reset all options to settings.

* This function will not affect the Rating control settings.

Screen Saver

This option allows the operator to set the Screen saver mode.

ON -Screen saver will appear

OFF -Screen saver will not appear

Note: The DVD player will enter Screen Saver mode if the unit is inactive for approximately 2 minutes.

Touch Cal

This option allows you to calibrate the touch screen. Select 'TOUCH CAL" and press OK / .

Use the ▼ button to select 'YES". Press OK/ . Touch each of the panel calibration symbols (+) on the panel's four points. Once the four points have been touched the unit will display "CAL OK" or "INVALID CAL". If the calibration is invalid, repeat the procedure until the prompt "CAL OK" is displayed.

After the calibration, the new record will overwrite the old one.

Playing DVDs

1. Press the DISPLAY button on the remote control to display the status banner.

The banner includes title, chapter, angle, audio, subtitle, title selection and chapter selection .

2. **Title Selection**

Press numeric (0~9) buttons to initiate a change of title selection. Then press **OK** button to implement the selection.

3. **Chapter selection**

Press numeric (0~9) buttons to initiate a change of chapter selection. Then press **OK** button to implement the selection.

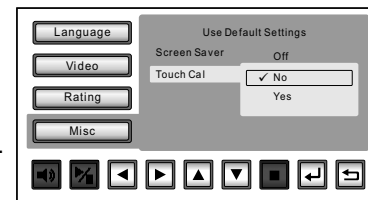
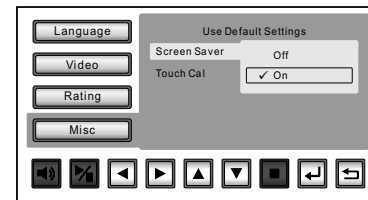
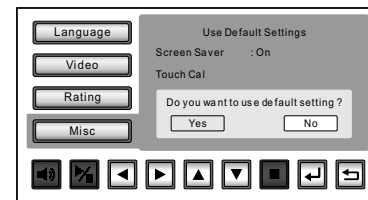

Playing MP3 Discs

MP3 is a format for storing digital audio. An audio CD-quality song can be compressed into the MP3 format with very little loss of quality, while taking up much less space. CD-R discs that have been encoded in MP3 format can be played on DVD player. The DVD player plays the songs in the order they were burned on to the disc. When playback is started the elapsed time of the track that is playing will be displayed.

Selecting Folders and Songs

When a device containing MP3 files is loaded in the player, the navigation menu appears automatically.

1. Press **▲** or **▼** to move the highlight to the desired folder (if present) on the left side of the menu and press **OK**. The songs in the folder will be displayed on screen.
2. Press **▲** or **▼** to move the highlight to the desired track containing the song and press **OK** to begin track playback or touch on the track title on the screen.

Skipping Songs

Use the Next (**▶▶**) button on the remote control to move to the next song. Use the Previous (**◀◀**) button to move to the previous song.

Selecting a Play Mode

Filter (For MP3 & JPEG only)

Filter Mode enables or disables the display of files contained on the media based on their file extension.

The filter function applies to the following formats:

Audio - Audio data format (MP3, WMA)

Photo - Photo data format (JPEG)

Video - Video data format (MPEG I, II)

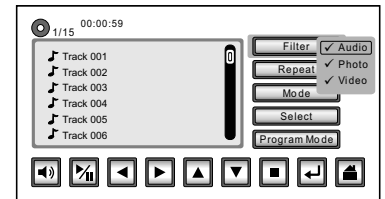
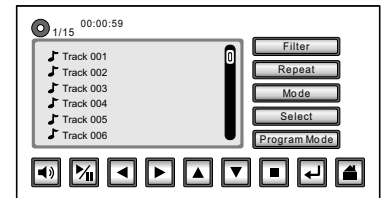

Repeat:

Repeat function has 4 options : Off, Single, Folder, All. Move cursor to Repeat function and press **OK** / . Each time **OK** / is pressed the unit will cycle through the available options.

Off/Single/Folder/All are displayed in that order. Repeat default is Off;

Off Turn off repeat function

Single Repeat the song being played until STOP is pressed.

Folder Play all songs in a folder repetitively

All Play all songs on the disc repetitively

Mode: play mode

The Mode function has 4 options: Normal, Shuffle, Random and Music Intro. Move cursor to the Mode function area and press **OK** / repeatedly till the desired mode is displayed. Normal/Shuffle/Random/Music Intro are displayed in that order. The Mode function default is Normal.

Normal: Play all songs in folder once.

Shuffle: Play songs in a folder in a shuffle order. Each song in the folder is played only once.

Random: Play songs in a folder in a random order. Each song in a folder is played only once.

Music Intro: Play each song in order in the folder for 10 seconds. The purpose of the Music Intro function is to provide a sample of each song for 10 seconds, thereby making it easy to select and listen to a favorite song.

Select:

Set the select mode to Off or On for selected songs.

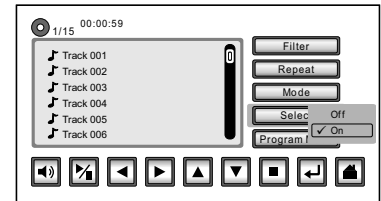
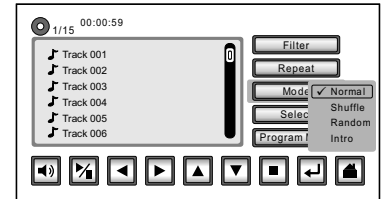
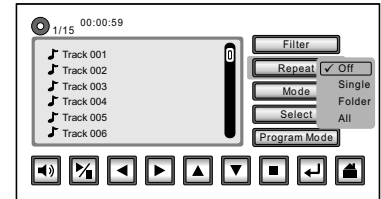

Program Mode:

Add

Set the "Select Mode" to ON. Select the desired songs from the song list on the left side of the screen. A check mark will appear next to the song. Touch "Program Mode" and select "Add". Touch "Program" to view the play list. Press the "Play" to hear the play list.

Program

The selected songs that are added into a new play list will be displayed.

Browser

Touch "Browser" to see the songs contained on the disc.

Clear

Move cursor to the selected song in the play list and select the songs which you want to delete. Touch "Clear". The selected songs will be deleted from the play list.

NOTE: Disc playback should be off when selecting or deleting a song from the play list.

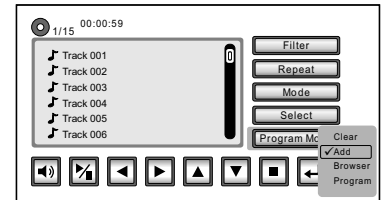

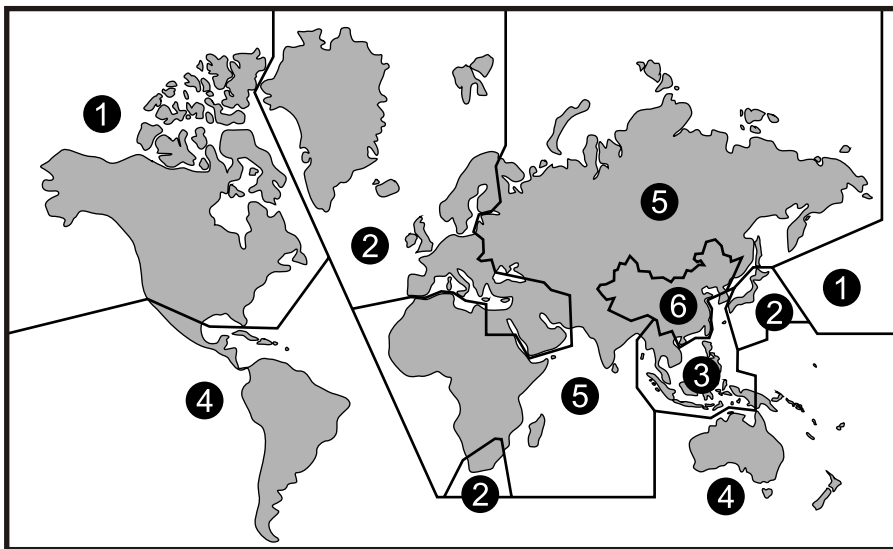

Region 1- USA, Canada

Region 2- Japan, Europe, South Africa, Middle East, Greenland

Region 3- S. Korea, Taiwan, Hong Kong, Parts of South East Asia

Region 4- Australia, New Zealand, Latin America (including Mexico)

Region 5- Eastern Europe, Russia, India, Africa

Region 6- China

DVD Area Code

The DVD player is preset to a region code at the factory depending on where the DVD player is sold. DVD from a different region cannot be played in this unit and the unit will display "WRONG REGION"

DVD Basics

To get the optimum use out of the DVD section, make sure you read this section completely.

Types of Discs your DVD will play

- DVD* disc - DVD discs which contain video.
 - Audio disc - Audio CDs contain musical or sound content only.
 - MP3 disc - A disc that contains audio files (for example, a CD-R with downloaded MP3 files).
- * This system is capable of playing most recordable DVD formats. However, due to the variety of disc manufacturers and software, playback cannot be guaranteed.

Loading and Playing Discs

Before you load a disc, make sure that it is compatible with the player. Insert the disc with the disc label facing toward the driver.

Note: *the following Discs **CANNOT** be used with this player :*

- *MiniDisc*
- *Laserdisc*
- *CD-1, CD-ROM, DVD-ROM, Super Audio CD (SACD), DVD Audio, JPEG*

To load and Play a Disc

Press the Power button to turn the unit on. Select DVD mode and insert the disc (label facing toward the driver) into the disc compartment. Push down gently on the disc and the player will pull the disc in.

Audio / Video Inputs and Outputs

Audio Output

The Audio output will provide the Audio signal from the M1 unit. This output can be heard on the Built-In Wireless Modulator.

TROUBLESHOOTING

PROBLEM	SOLUTION
IR sensor inoperative	<ul style="list-style-type: none">• Verify that the batteries in the remote are fresh.• Verify that the remote sensor eye is not obstructed.• Verify that M1 or M2 has been selected correctly.
Disc won't play	<ul style="list-style-type: none">• Disc is scratched or damaged. Try another disc.• Check the type of disc you put into disc tray. This unit only plays DVDs, audio CDs and MP3s.• Both the unit and the disc are coded by region. If the regional codes don't match, the disc can't be played• Verify that the disc label is toward the driver.
Play starts, but then stops immediately Picture pixelates or plays intermittently	<ul style="list-style-type: none">• The disc is dirty. Clean it.• Condensation has formed. Allow player to dry out.• Disc is scratched, replace the disc.

TROUBLESHOOTING

PROBLEM	SOLUTION
No sound or distorted sound	<ul style="list-style-type: none">• Make sure your DVD is connected properly. Make sure all cables are securely inserted into the appropriate jacks.• Disc loaded backwards, turn disc around so that the disc is facing towards the driver.
OSD Displays "Incorrect Disc Format"	<ul style="list-style-type: none">• Disc loaded backwards, turn disc around so that the disc label is facing towards the driver.
Touch screen operation is erratic	<ul style="list-style-type: none">• Re-calibrate the touch screen. Refer to page 19.

CAUTION



1. Keep the monitor clean and dry.
2. Always seek qualified personnel to perform repairs. Never attempt your own repairs.
3. Do not drop the monitor or expose to strong impacts.
4. Do not expose to direct sunlight for extended periods of time.

MONITOR SPECIFICATIONS

1. Type	: TFT Active Matrix LCD	7. Operating Temperature	: 32°F ~ 125°F (-0°C ~+52°C)
2. Resolution	: 1440(W) x 234 (H)	8. Storage Temperature	: -22°F ~ 150°F (-30°C~ +70°C)
3. Pixels	: 336, 960	9. Video Display System	: NTSC/PAL
4. Back Light	: Edge Light Tube	10. Backlight life	: 10,000 hours
5. Power Source	: +12 VDC	11. Headphone Audio Output	: 0.03W @ 32 ohm
6. Power Consumption	: 28W		

Free Manuals Download Website

<http://myh66.com>

<http://usermanuals.us>

<http://www.somanuals.com>

<http://www.4manuals.cc>

<http://www.manual-lib.com>

<http://www.404manual.com>

<http://www.luxmanual.com>

<http://aubethermostatmanual.com>

Golf course search by state

<http://golfingnear.com>

Email search by domain

<http://emailbydomain.com>

Auto manuals search

<http://auto.somanuals.com>

TV manuals search

<http://tv.somanuals.com>