

AUDIOVOX®
ELECTRONICS CORP.

**HRDV700 Two 7" Monitors with
Built-in DVD player and Two Audio/Video
Input Capability Mounted in Vehicle
Specific Headrests**

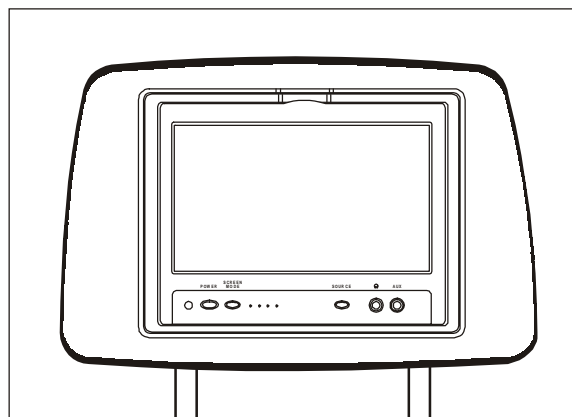
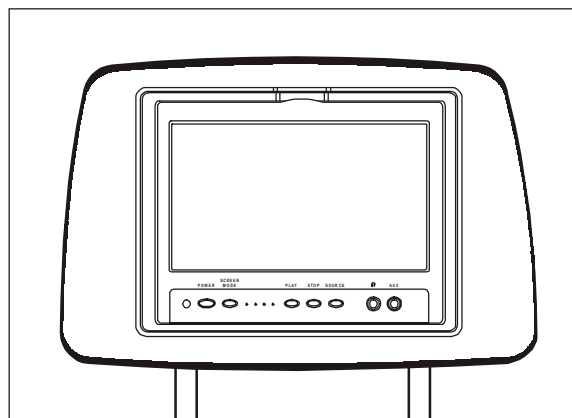

Operation Manual

IMPORTANT

An LCD panel and/or video monitor may be installed in a motor vehicle and visible to the driver if the LCD panel or video monitor is used for vehicle information, system control, rear or side observation or navigation. If the LCD panel or video monitor is used for television reception, video or DVD play, the LCD panel or video monitor must be installed so that these features will only function when the vehicle is in 'park' or when the vehicle's parking brake is applied.

An LCD panel or video monitor used for television reception, video or DVD play that operates when the vehicle is in gear or when the parking brake is not applied, must be installed to the rear of the driver's seat where it will not be visible, directly or indirectly, to the operator of the motor vehicle.

HRDV700 system

The HRDV700 system is composed of two headrest units. The master unit has a built-in DVD player and the satellite unit has a monitor that is used to either watch the DVD movie that is playing in the master unit or play a video game plugged into the AV1 input or AUX input. Each unit has a remote control. The remote control for the master unit is a full-function remote control while the remote control for the satellite unit has limited functions.

Caution: Each monitor has an AUX input on the bottom right hand side of the screen. When the AUX connector is plugged in to this input use care when pivoting the screen downwards. The plug will limit screen travel. Excessive force can screen and/or plug.

Quick Start Guide

1. On master monitor, tilt the screen forward using the center tab at the top of the screen.
2. Insert a DVD, CD or MP3 disc into the slot, label facing you.
3. The disc will start playing.
4. Tilt the monitor to a comfortable viewing position (the headrest itself can be tilted forward to help achieve a comfortable viewing position).
5. Each wireless headphone has a CH A/CH B switch. When sitting in front of the master screen, use the CH A switch setting. When sitting in front of the satellite screen, use the CH B switch setting. Set the headphone to the proper channel and press the Power On/Off switch. The power indicator will light up red. Turn the volume down to its lowest setting before putting them on your head.
6. When the DVD menu appears, select the menu item using the cursor keys and press the Enter or Play button.
7. If audio playback through the vehicle radio is preferred, use the FM transmitter On/Off button on the master remote control. Use the FMM Source button to select DVD Audio. Set the vehicle radio to the channel selected on the master monitor. If interference with a local radio station occurs, set the FM modulator to one of the other two radio frequencies using the FM transmitter select button on the master remote control.
8. Turn on the satellite screen using the power button on the front of the screen or the satellite remote control.
9. Tilt the screen to a comfortable viewing position (the headrest itself can be tilted forward to help achieve a comfortable viewing position).

NOTE: The master remote control will only control the master screen; the satellite remote control will only control the satellite screen.

Controls on Master Monitor and Master Remote Control Unit

Master Monitor Panel Controls

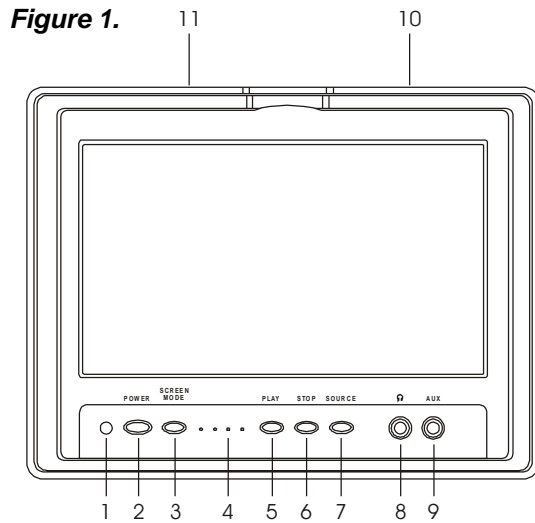

1. Remote Control Sensor (IR)
2. Power ON/OFF Button
3. Screen Mode Button
4. Infrared Audio Transmitter
5. Play Button
6. Stop Button
7. Source Button
8. Earphone Jack
9. AUX Input Jack
10. Eject Button
11. DVD disc insertion slot

Master Remote Control Unit

Figure 2.

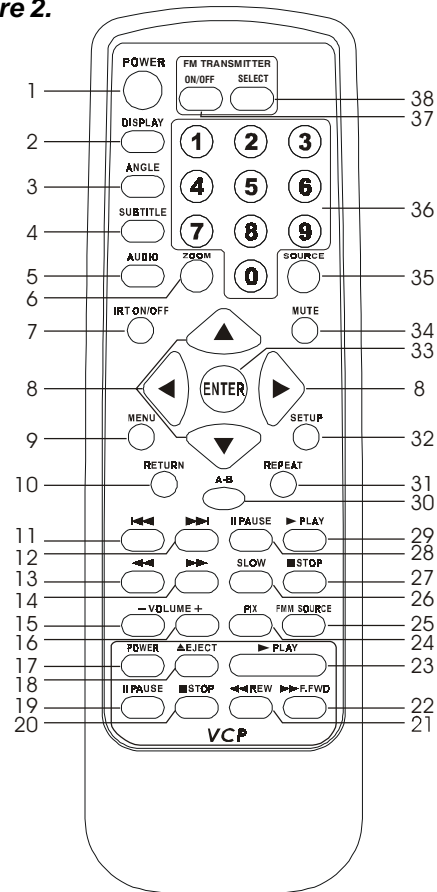

Master Remote Control Unit Buttons (Figure 2)

* Function control is available on the unit and remote control

1. **POWER ON/OFF Button*** – Press this button to turn the HRDV700M master unit on. Press the button again to turn the HRDV700M master unit off.
2. **DISPLAY Button** – Press this button to display the DVD Disc information listed below.

Press DISPLAY button	OSD	DVD Player Perform
Once	TITLE & CHAPTER	Display current TITLE, CHAPTER & elapsed time
Twice	SUBTITLE	Display current SUBTITLE
3 times	AUDIO	Display current AUDIO language, channel & elapsed time
4 times	SURROUND	Display SURROUND current status & elapsed time
5 times	ANGLE	Display current ANGLE & elapsed time
6 times	A TO B	Display A-B current status & elapsed time
7 times	REPEAT	Display REPEAT current status & elapsed time
8 times		Display is turn off

Use cursor buttons for title/chapter selection, then press Enter button to implement the selection. For Subtitle, Audio, Surround, Angle, A to B & Repeat, press Enter key repeatedly to change the options. These options may vary from disc to disc.

3. **ANGLE Button** – Press this button to display and select the camera angles. Each time the button is pressed, the angle will change. *NOTE: The number of angles vary from disc to disc.*
4. **SUBTITLE Button** – Press this button to display and select the subtitle language in DVD. Each time the button is pressed, the subtitle language changes. *NOTE: The type & number of languages for subtitles vary from disc to disc.*
5. **AUDIO Button** – Press this button to display and select AUDIO language and channel. Each time the button is pressed, the language or channel changes. *NOTE: The languages & channel you can select are vary from disc to disc.*
6. **ZOOM Button** – Press this button to zoom the picture

Press ZOOM button	OSD	DVD Player Perform
Once	ZOOM x1.5	ZOOM picture 1.5 times
Twice	ZOOM x2	ZOOM picture 2 times
3 times	ZOOM x4	ZOOM picture 4 times
4 times	ZOOM OFF	picture is back to normal size

7. **IRT ON/OFF Button** – Press this button to turn the HRDV700M master unit IR Transmitter ON/OFF.
8. **CURSOR Button** (▼▲◀▶) – Use these buttons to navigate the Setup Menu and change settings.
9. **MENU Button** – Press this button to access the Main Menu.
10. **RETURN Button** – Press this button to return to the main page.
11. **PREVIOUS Button** (◀◀) – Press this button to return to the previous chapter or track.
12. **NEXT Button** (▶▶) – Press this button to skip to the next chapter or track.
13. **SCAN FORWARD Button** (▶▶▶) – Press this button to search in a forward direction at 2,4,6 and 8 times the normal speed.
14. **SCAN BACKWARD Button** (◀◀◀) – Press this button to search in a backward direction at 2,4,6 and 8 times the normal speed.
15. **VOLUME DOWN Button** (-) – Press this button to decrease the volume level of the wired headphones. This button is also used to make picture adjustments in the picture select mode.
16. **VOLUME UP Button** (+) – Press this button to raise the volume level of the wired headphones. This button is also used to make picture adjustments in the picture select mode.
17. **POWER Button** – Press this button to turn the Video Cassette Player (VCP) ON, if equipped. Press the button again to turn the VCP OFF.
18. **EJECT Button** – Press this button to eject the VCP tape.
19. **PAUSE Button** – Press this button to pause VCP playback.
20. **STOP Button** – Press this button to stop VCP playback.
21. **REWIND Button** (◀◀ REW) – Press this button to rewind the tape in the VCP.
22. **FAST FORWARD Button** (▶▶ F.FWD) – Press this button to fast forward the tape in the VCP.
23. **PLAY Button** (▶) – Press this button to activate the play mode while a tape is loaded.

24. **PICTURE SELECT Button** – Each time this button is pressed, the OSD will display the "adjustment bars" for BRIGHTNESS, CONTRAST, COLOR or TINT. Once the desired adjustment bar is displayed, use the VOLUME UP/DOWN buttons to adjust the setting. The display will automatically turn off if no adjustments are made within 6 seconds, or if any other button is depressed.
25. **FMM SOURCE Button** – Press this button to switch the FMM Modulator Audio Source to DVD or AV1.
26. **SLOW Button** – Press this button to reduced the DVD viewing speed by 1/2, 1/4, 1/8 times of normal speed.
27. **STOP Button*** (■) – Press this button to stop the playback of the DVD disc.
28. **PAUSE Button** (II) – Press this button to pause the playback of the DVD disc.
29. **PLAY Button*** (▶) – Press this button to activate the play mode while a disc is loaded into the disc compartment.
30. **A-B REPEAT Button** – Press this button to repeat playback of a DVD or CD from point A to point B.
31. **REPEAT Button** – Press this button to repeat various titles, chapter or tracks of a DVD, CD or MP3.
32. **SETUP Button** – Press this button to select the DVD player's options (Display, OSD Language, Defaults, Parental Control, Password, Exit Setup).
33. **ENTER Button** – Press this button to implement the setting(s) selected.
34. **MUTE Button** – Press this button to mute the audio headphones. Pressing the button again will restore the sound to the previous set level.
35. **SOURCE Button*** – The video signals from video equipment connected to the A/V1 or AUX inputs can be displayed on the monitor by pressing this button. Each time the button is pressed, the source will change in the following sequence: DVD, AV1 and AUX.
36. **NUMBER Buttons** – Press these buttons to enter the numbers 0 to 9 for selection of CD tracks, DVD chapters, and password setting.
37. **FM ON/OFF Button** – Press this button to turn the FM Modulator power ON/OFF.
38. **FM SELECT Button** – Press this button to select the FM modulator Frequency (Frequency 1, 88.3MHz, Frequency 2, 88.7MHz, Frequency 3, 89.1MHz).

NOTE: VCP function buttons are for Audiovox VCP'S only.

Controls on Satellite Monitor and Satellite Remote Control Unit

Satellite Monitor Panel Controls

Figure 1.

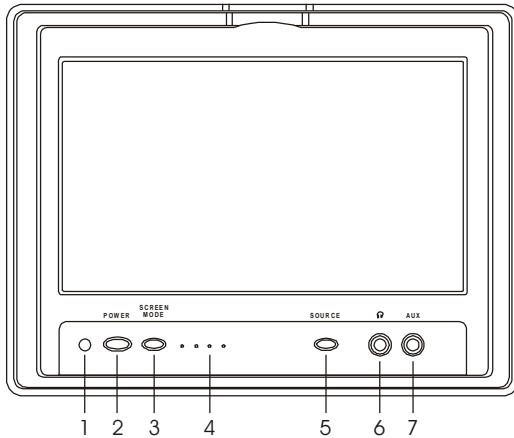

1. Remote Control Sensor (IR)
2. Power ON/OFF Button
3. Screen Mode Button
4. Infrared Audio Transmitter
5. Source Button
6. Earphone Jack
7. AUX Input Jack

Satellite Remote Control Unit

Figure 2.

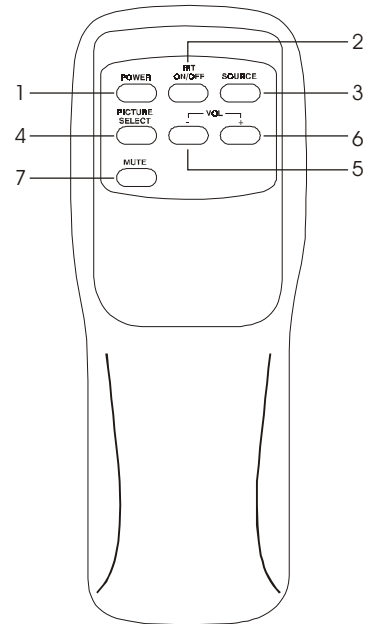

Satellite Remote Control Unit Buttons (Figure 2)

* Function control is available on the unit and the remote control.

1. **POWER ON/OFF Button*** – Press this button to turn the HRDV700S Satellite Unit on.
2. **IRT ON/OFF Button** – Press this button to turn the HRDV700S Satellite Unit IR Transmitter ON/OFF.
3. **SOURCE Button*** – The video signals from video equipment connected to the AV1 or AUX inputs can be displayed on the monitor by pressing this button. Each time the button is pressed, the source will change in the following sequence: DVD, AV1 and AUX.
4. **PICTURE SELECT Button** – Each time this button is pressed, the OSD will display the "adjustment bars" for BRIGHTNESS, CONTRAST, COLOR or TINT. Once the desired adjustment bar is displayed, use the VOLUME UP/DOWN buttons to adjust the setting. The display will automatically turn off if no adjustments are made within 6 seconds, or if any other button is depressed.
5. **VOLUME DOWN Button (-)** – Press this button to decrease the volume level of the wired headphones. This button is also used to make picture adjustments in the picture select mode.
6. **VOLUME UP Button (+)** – Press this button to raise the volume level of the wired headphones. This button is also used to make picture adjustments in the picture select mode.
7. **MUTE Button** – Press this button to mute the audio. Pressing the button again will restore the sound to the previous set level.

OPERATION INSTRUCTION

Button Functions (HRDV700M Master Unit)

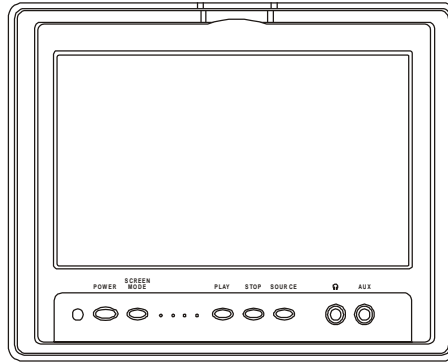

There are five (5) buttons on the front of the HRDV700M Master unit: POWER, SCREEN MODE, PLAY, STOP, SOURCE.

- 1) POWER : Pressing this button will turn the unit ON/ OFF.
- 2) SCREEN MODE : Pressing this button will select between 16:9 , 4:3 aspect ratio or Screen Off (display OFF).
- 3) PLAY : Pressing this button will activate the play mode.
- 4) STOP : Pressing this button will stop the DVD disc.
- 5) SOURCE : Pressing this button will select between DVD, AV1 and AUX.

Button Functions (HRDV700S Satellite Unit)

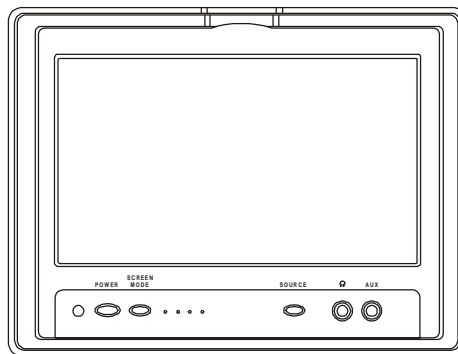

There are three (3) buttons on the front of the HRDV700S Satellite unit: POWER, SCREEN MODE, SOURCE.

- 1) POWER : Pressing this button will turn the unit ON/OFF.
- 2) SCREEN MODE : Pressing this button will select between 16:9, 4:3 screen format or Screen OFF (display OFF).
- 3) SOURCE : Pressing this button will select between DVD, AV1 and AUX.

NOTE: The AUX input is only available on the unit to which it is connected.

CAUTION: The AUX input cable limits screen travel. Do not force the screen open with the AUX cable plugged in otherwise damage may result.

DVD Settings and Adjustments

This chapter describes how to set and adjust various DVD functions using the on-screen SETUP menu.

Using the Setup Menu

The Setup Display is used for the initial setup, select the DVD playback screen rating, and set the various outputs. You can also set a language for the on-screen display and the setup display and limit playback by children.

- 1) Press the SETUP button to display the "setup menu" on the display screen.
- 2) Select the menu item you want using the cursor (▲▼) buttons, and then press the ENTER button.

To Cancel Setup

Press the SETUP button on the remote.

Setting the Display

Press the SETUP button and select Display. The DISPLAY SETUP allows you to adjust screen aspect ratio. Press ► and then use the (▲▼) buttons to select the appropriate settings.

4:3/PS

This displays a wide picture on the screen with a portion of the left & right side removed.

4:3/LB

This displays a wide picture with black bands on the upper and lower portions of the screen.

16:9

This displays a picture with black bands on the upper and lower portion of the screen.

Then press ENTER to confirm your selection.

Setting the Language for On-Screen Display

Press the SETUP button and using the (▲▼) buttons select "OSD LANGUAGE".

OSD (On-Screen Display) Language Menu

The OSD Language Menu allows the user to select the language for the on-screen display. Press ► and then use the (▲▼) buttons to select the desired language then press ENTER to confirm your selection. The user can select either English, French or Spanish for the OSD language.

Defaults Setting

Press the SETUP button and select DEFAULTS. The DEFAULTS RESET allows you to reset all options to the factory settings or press ► and then press Enter to implement the reset.

NOTE: This function will not effect the Parental setting.

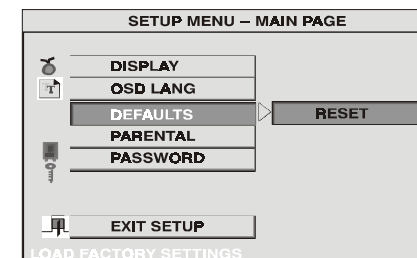
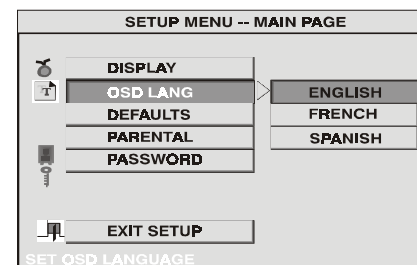
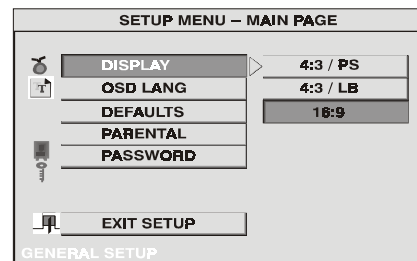

Settings for Parental (Parental Control)

This section of the SETUP Menu allows the user to select a rating limit* from G to NO_PARENTAL. The Parental Control function allows you to limit viewing to your preference.

1. Press ► and use the ▲▼ buttons to select from:

- G (Children)
- PG
- PG 13
- R
- NC-17
- ADULT (Adult)
- NO_PARENTAL

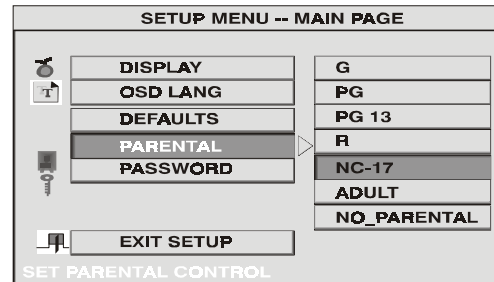

* **NOTE: Not all discs contain the lockout feature.**

2. Press the Enter button to confirm the selection.

3. Input a 4 digit password in using the numeric buttons then press the Enter button. The Default password is 3308. This password is always effective, even after a new password has been set.

Setting Password (Parental Control Password)

Press the SETUP button and select PASSWORD. The PASSWORD SETUP allows you to change the parental control password. Press ► and then press Enter.

OLD PASSWORD

Input the old password or the default password (4 digits)

NEW PASSWORD

Input a new password (4 digits) using numeric buttons

CONFIRM PWD

Confirm the new password by entering the same new password again.

Then press Enter to implement it.

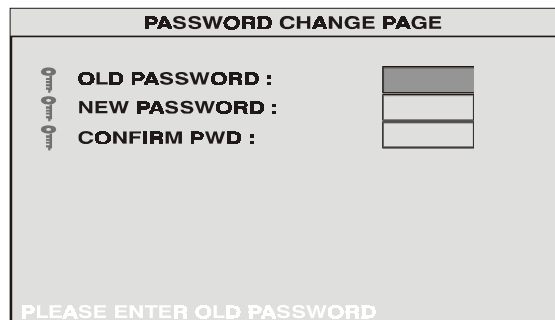
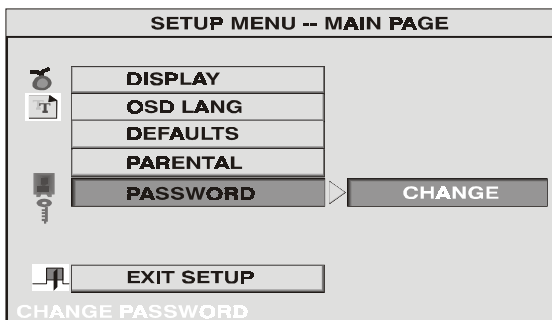

Playing Audio CDs

When playing an audio CD, the DISPLAY Banner appears automatically. It displays the current track and the amount of the time for the track playing. The total amount of time on the disc and the current time running on the disc. Press the DISPLAY button on the remote to change the DISPLAY Banner. The options below show you what happens when you press the DISPLAY button.

Press DISPLAY 1x	<i>SINGLE ELAPSED</i> appears along with the current track playing and the time of that track.
Press DISPLAY 2x	<i>SINGLE REMAIN</i> appears along with the current track playing the and the amount of time left.
Press DISPLAY 3x	<i>TOTAL ELAPSED</i> appears along with the current track playing the total time playing on the CD.
Press DISPLAY 4x	<i>TOTAL REMAIN</i> appears along with the current track playing and the amount of time left on the CD.
Press DISPLAY 5x	Turns off the DISPLAY Banner.

Using the REPEAT Feature

The default mode for the Repeat feature is OFF. Pressing REPEAT consecutively changes the repeat options:

- *REP-ONE*- repeats the track that is playing.
- *REP-ALL*- repeats the disc that is playing.
- *REPEAT OFF*

Playing MP3 Discs

MP3 is a format for storing digital audio. An audio CD-quality song can be compressed into the MP3 format with very little loss of quality, while taking up much less space. CD-R discs that have been encoded in MP3 format can be played on your DVD player.

Press the DISPLAY button on the remote to DISPLAY Banner. The options below show you what happens when you press the DISPLAY button.

- | | |
|------------------|--|
| Press DISPLAY 1x | <i>TIME ELAPSED</i> appears along with the amount of time the song has played. <i>TIME ELAPSED</i> and the time will remain on-screen until you press DISPLAY again. |
| Press DISPLAY 2x | <i>TIME REMAIN</i> appears along with the amount of time left in the song that is playing. <i>TIME REMAIN</i> and the time that is left remain on-screen until you press DISPLAY again. |
| Press DISPLAY 3x | <i>OFF</i> appears along with the amount of time the song has played. The time remains on-screen until you press DISPLAY again to see the time left in the song that is playing or you press STOP. |

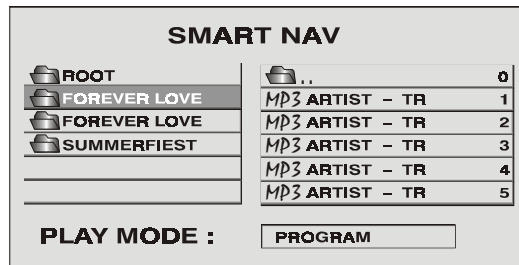

Selecting Folders and Songs

When an MP3 disc is inserted in the player, the Smart Nav screen appears automatically. You can change folders and songs through Smart Nav. The DVD player plays the songs in order they were burned on to the disc.

1. If a disc is playing, press STOP. Press the up or down arrow button to go through the folder list on the right side of the Smart Nav screen.
2. Once the folder you want is highlighted, press Enter (the folder list shifts to the left side of the screen and the songs in the folder appear on the right).
3. Press the up or down arrow button to go through the song list and highlight the song you want. Press Enter to begin playback of the highlighted song.

Skipping Songs

Use the Next (▶▶) button on the remote control to move to the next song. Use the Previous (◀◀) button to move to the beginning of the currently playing song. Press the ◀◀ button 2 times to move to the previous song.

Using The Repeat Feature

The default mode for the Repeat feature is OFF. Pressing REPEAT consecutively changes the repeat options:

- *REP-ONE*- repeats the songs that is playing.
- *FOLDER REP*- repeats the folder that is playing.
- *FOLDER*- turns off repeat and returns to regular play mode.

Selecting a Play Mode

You can choose the order that the songs will play on a disc temporarily. The FOLDER play mode is the default. To access the play mode options, press STOP if the disc is playing. Press the right arrow button until the PLAY MODE option is highlighted. Use the up or down arrow to choose an option. The play mode options are:

- SINGLE: Play a selected song.
- REP_ONE: Repeats the song that is playing.
- FOLDER: Plays the folder in the order the songs were recorded.
- FOLDER REP: Repeats the folder that is playing.
- DISC SCAN : Plays the song for 10 second for each song in the disc.
- DISC: Plays the entire disc.
- DISC REP : Repeats the disc that is playing.
- RANDOM: Plays the songs in the random order.
- SHUFFLE ON: Plays the songs in random order (from within the selected folder)
- PROG-PO: Plays the songs on the disc in the order you have programmed (you must create a playlist to set the order you want the tracks on the disc to play). When you are creating a playlist, this option changes to PROGRAM END.

Program Play

To use the program play option, you must create a playlist of songs in the order you want them to play.

Note: *Once you begin adding songs from a folder to create your play list, you cannot add songs from a different folder.*

1. Choose the PROG-PO option for the PLAY MODE.
2. Highlight and enter the folder you want to program.
3. Add songs to the program list by pressing ENTER once the song is highlighted. The song you have chosen and the number of songs you have chosen appear at the top of the screen. For example, if you choose the number five song within the folder and it is the first song you have chosen, PROGRAM P01:05 appears.
4. You can continue to add songs to the list from within the same folder by using the up or down arrow button and then pressing ENTER to add it to the list.
5. When you are done creating the list, press STOP to end the programming. Then press PLAY to begin the program play mode.

Deleting the Playlist

To delete the entire playlist, press STOP while the disc is playing and change to another play mode.

Troubleshooting

<u>PROBLEM</u>	<u>SOLUTION</u>
Poor in vehicle radio reception (FM modulator installed)	<ul style="list-style-type: none"> • Check the condition of the vehicle's radio antenna. • Verify that the antenna is fully raised. • Verify that it that the FM Modulator is turned OFF by using the remote.
IR sensor inoperative	<ul style="list-style-type: none"> • Verify that the batteries in the remote are fresh. • Verify that the remote sensor eye is not obstructed. • Verify that the infrared transmitter is affixed over the sensor eye of the component to be controlled.
Disc won't play	<ul style="list-style-type: none"> • Insert a disc with the label side facing the front of the unit. • Check the type of disc you put into disc tray. This DVD player only plays DVD's, audio CDs and MP3s. • Both the unit and the disc are coded by region. If the regional codes don't match, the disc can't be played. This DVD player is Region Number 1.
Play starts, but then stops immediately	<ul style="list-style-type: none"> • The disc is dirty. Clean it. • Condensation has formed. Allow the player to dry out.
No sound or distorted sound	<ul style="list-style-type: none"> • Make sure your DVD player is connected properly. Make sure all cables are securely inserted into the appropriate jacks. • If you are using the IR headphones, make sure you turn on the IRT power. • Make sure the FM Modulator is ON and the proper Frequency has been selected.
Can't advance through a movie	<ul style="list-style-type: none"> • You can't advance through the opening credits and warning information that appears at the beginning of movies because the disc is programmed to prohibit that action.
The icon (⏮) appears on screen	<ul style="list-style-type: none"> • The feature or action cannot be completed at this time because: <ol style="list-style-type: none"> 1. The disc's software restricts it. 2. The disc's software doesn't support the feature (e.g., angles) 3. The feature is not available at the moment. 4. You've requested a title or chapter number that is out of range.
Picture is distorted	<ul style="list-style-type: none"> • The disc might be damaged. Try another disc. • It is normal for some distortion to appear during forward or reverse scan.
No forward or reverse scan	<ul style="list-style-type: none"> • Some discs have sections that prohibit rapid scanning or title and chapter skip. • If you try to skip through the warning information and credits at the beginning of a movie, you won't be able to. This part of the movie is often programmed to prohibit skipping through it.



CAUTION

1. Keep the monitor clean and dry.
2. Always seek qualified personnel to perform repairs. Never attempt your own repairs.
3. Do not drop the monitor or expose to strong impacts.
4. Do not expose to direct sunlight for extended periods of time.

MONITOR SPECIFICATIONS

- | | |
|------------------------------|--|
| 1. Type : | TFT Active Matrix LCD |
| 2. Resolution: | 1440 (W) x 234 (H) |
| 3. Pixels: | 336,960 |
| 4. Back Light : | Cold Cathode Fluorescent Lamp |
| 5. Power Source : | +12 VDC |
| 6. Power Consumption : | 30W For 2 Monitors + 1 DVD |
| 7. Connection Terminals : | Power Input 12V (Accessory, Constant, and Ground)
Audio/Video Input Jacks (RCA) x3, IR Repeater 1,
7pin JST connector x1 (for FM Modulator). |
| 8. Operating Temperature : | 32°F – 104°F (0°C – 40°C) |
| 9. Storage Temperature : | -4°F – 176°F (-20°C – +80°C) |
| 10. Video Display System : | NTSC/PAL |
| 11. Backlight life : | 10,000 hours |
| 12. Headphone Audio Output : | 0.03W @ 32 ohm |



12 MONTH LIMITED WARRANTY

Applies to Audiovox Mobile Video Products

AUDIOVOX ELECTRONICS CORP. (the Company) warrants to the original retail purchaser of this product that should this product or any part thereof, under normal use and conditions, be proven defective in material or workmanship within 12 months from the date of original purchase, such defect(s) will be repaired or replaced with reconditioned product (at the Company's option) without charge for parts and repair labor.

To obtain repair or replacement within the terms of this Warranty, the product is to be delivered with proof of warranty coverage (e.g. dated bill of sale), specification of defect(s), transportation prepaid, to the Company at the address shown below.

This Warranty does not extend to the elimination of externally generated static or noise, to correction of antenna problems, to costs incurred for installation, removal or reinstallation of the product, or to damage to tapes, discs, speakers, accessories, or vehicle electrical systems.

This Warranty does not apply to any product or part thereof which, in the opinion of the Company, has suffered or been damaged through alteration, improper installation, mishandling, misuse, neglect, accident, or by removal or defacement of the factory serial number/bar code label(s). THE EXTENT OF THE COMPANY'S LIABILITY UNDER THIS WARRANTY IS LIMITED TO THE REPAIR OR REPLACEMENT PROVIDED ABOVE AND, IN NO EVENT, SHALL THE COMPANY'S LIABILITY EXCEED THE PURCHASE PRICE PAID BY PURCHASER FOR THE PRODUCT.

This Warranty is in lieu of all other express warranties or liabilities. ANY IMPLIED WARRANTIES, INCLUDING ANY IMPLIED WARRANTY OF MERCHANTABILITY, SHALL BE LIMITED TO THE DURATION OF THIS WRITTEN WARRANTY. ANY ACTION FOR BREACH OF ANY WARRANTY HEREUNDER INCLUDING ANY IMPLIED WARRANTY OF MERCHANTABILITY MUST BE BROUGHT WITHIN A PERIOD OF 24 MONTHS FROM DATE OF ORIGINAL PURCHASE. IN NO CASE SHALL THE COMPANY BE LIABLE FOR ANY CONSEQUENTIAL OR INCIDENTAL DAMAGES FOR BREACH OF THIS OR ANY OTHER WARRANTY, EXPRESS OR IMPLIED, WHATSOEVER. No person or representative is authorized to assume for the Company any liability other than expressed herein in connection with the sale of this product.

Some states do not allow limitations on how long an implied warranty lasts or the exclusion or limitation of incidental or consequential damage so the above limitations or exclusions may not apply to you. This Warranty gives you specific legal rights and you may also have other rights which vary from state to state.

U.S.A. : AUDIOVOX 150 MARCUS BLVD., HAUPPAUGE, NEW YORK 11788 • 1-800-645-4994

CANADA : CALL 1-800-645-4994 FOR LOCATION OF WARRANTY STATION SERVING YOUR AREA

128-5495C



For Customer Service
Visit Our Website At
www.audiovox.com
Product Information, Photos,
FAQ's Owner's Manuals

Free Manuals Download Website

<http://myh66.com>

<http://usermanuals.us>

<http://www.somanuals.com>

<http://www.4manuals.cc>

<http://www.manual-lib.com>

<http://www.404manual.com>

<http://www.luxmanual.com>

<http://aubethermostatmanual.com>

Golf course search by state

<http://golfingnear.com>

Email search by domain

<http://emailbydomain.com>

Auto manuals search

<http://auto.somanuals.com>

TV manuals search

<http://tv.somanuals.com>