



AUDIOVOX®
ELECTRONICS CORP.

LCM5043NP & LCM5643NP
Remote Controlled Color Display Monitor
with Headphone Jack



5-INCH COLOR DISPLAY MONITOR

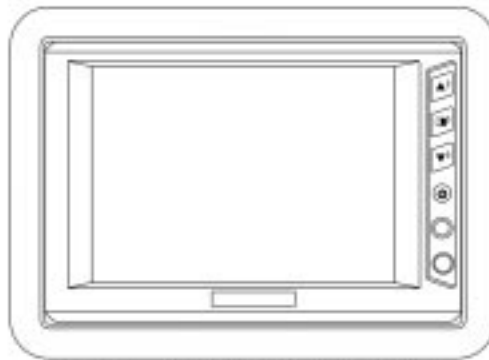

5.6-INCH COLOR DISPLAY MONITOR

Installation and Owner's Manual

Released: 03-25-02.

128-6323
1 of 20

EXPLANATION OF GRAPHIC SYMBOLS



The lightning flash with the arrowhead within a triangle is intended to alert the user that parts inside the product are capable of producing an electric shock.



The exclamation point within a triangle is intended to alert the user that important operating and servicing instructions are being provided.

WARNING:
TO PREVENT FIRE OR ELECTRIC SHOCK HAZARD, DO NOT EXPOSE THIS PRODUCT TO RAIN OR MOISTURE.

CAUTION:

1. This product is designed to operate with a 12 volt, negative ground battery system.
2. Disconnect the ground wire from the battery terminal before connecting the electrical system. Refer to the electrical connection diagram to avoid wrong connection of the electrical system.
Always use authorized service center for service assistance.
3. Do not operate the monitor at temperatures below 32°F (0°C) or above 104°F (40°C).
4. Keep the monitor clean and dry.
5. Never attempt your own repairs. This unit should be installed and repaired by qualified technicians or service personnel.
6. Do not drop the monitor or expose to strong impacts.
7. Do not expose to direct sunlight for extended periods of time.
8. Use proper insulation material to prevent short-circuiting of the supply system.
9. Tighten all loose wires after installation.

SYSTEM OVERVIEW

The LCM5043NP is comprised of a 5" Thin Film Transistor (TFT) Liquid Crystal Display (LCD) Monitor. The LCM5643NP is comprised of a 5.6" Thin Film Transistor (TFT) Liquid Crystal Display (LCD) Monitor. The Monitor for both of these systems have a 4:3 Aspect Ratio display that allows the user to select between two video sources (Not Supplied). The Monitors displays all functions with the comprehensive On Screen Display (OSD). Can be used with an optional Wired Headphone.

OPTIONAL AUDIO CONNECTION

- 1) Wired Headphones P/N =HP275

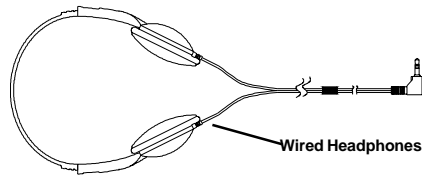

MATERIALS LIST

1. System Monitor (LCM5043NP=136C2187) or (LCM5643NP=136C2186) (1pc.)
2. Remote Control Unit (136B2156) with Lithium Battery, 3V,CR 2025 (1pc.)
3. Interconnect Box (136B2183) (1pc.)
4. Monitor Cable, 8' (112B3152) (1pc.)
5. Headrest Mounting Tray (LCM5043NP=102C3740)
or (LCM5643NP=102C3742) (1pc.)
6. Trim Ring for Mounting Tray (LCM5043NP=102B3741)
or (LCM5643NP=102B3743) (1pc.)
7. Power Cable, 2.46' (112B3127) (1pc.)
8. Removal Tool (108B3632) (1pc.)



VEHICLE PREPARATION

- 1) Decide on the system configuration and the options that will be installed (i.e. what components, VCP, DVD, TV Tuner, Video Game, Monitor, FM Modulator, etc.).
- 2) Read the manuals and get familiar with the electrical requirements and connections.
- 3) Decide on the mounting locations and methods of mounting the products.
- 4) Prepare the vehicle by removing any interior trim necessary to gain access to the vehicle's wiring as well as all areas where interconnecting wire harnesses will be located. If any access holes need to be cut into the vehicle, headrests, or other trim components, this should be performed now. (Refer to the Installation Procedure).
- 5) Run the wiring harnesses and cabling throughout the vehicle as necessary. (Refer to the wiring instructions for the individual components and accessory options being installed). Be sure, that all the wiring is protected from sharp edges and is routed in such a manner that it will not be pinched, when it is fully installed. Be sure to leave enough slack in the wiring at each component to allow sufficient working room.
- 6) Remove all the A/V system components from their packaging and then place them in the vehicle at their respective locations.
- 7) Locate an accessory power source (Red Wire)(+12VDC present when the ignition key is in the accessory and run positions. 0VDC should be present, when the ignition key is in the OFF position). Generally, these wires can be found at the ignition switch or fuse box.
- 8) Locate a Constant Power Source (Yellow Wire)(+12VDC present at all times).
NOTE: Ensure that the accessory power is fused at the source. Failure to do so may result in vehicle wiring damage.) Ground the black wire to a chassis ground close to the mounting location of AV sources.
- 9) Connect all the components together (electrically) and verify that the proper operation of all the system functions. **NOTE:** This is best done BEFORE the components are permanently mounted.

- 10) After verifying the proper operation of the system, proceed to mount each component.
- 11) The mounting method, and the location will vary from vehicle to vehicle, so this manual will only focus for the installation of the
- 12) The best location for the system components is:
 - a) Monitor: Headrest or bracket (optional) mounted onto a flat surface.
 - b) System Interconnection Box (AVX-6869): In line with all the system cabling and in an area where it can be easily accessed.
 - c) System Main Cable: Under either seat where monitors are located.

Tools and Materials Required:

Utility knife or box cutter with sharp blade.
Permanent Marker.
Tie Wraps.

INSTALLATION

Optional Bracket Mounting:

This procedure describes mounting the system monitor using an optional Surface Mount Bracket (sold separately, # FB1)

- 1) Start by firmly attaching the Surface Mount Bracket onto a flat surface

IMPORTANT NOTICE

It is unlawful in most jurisdictions to drive a motor vehicle which is equipped with a television viewer or screen that is located at the point forward of the back of the driver's seat, or that is visible directly or indirectly, to the driver while operating the vehicle.

- 2) Slide monitor onto Surface Mount Bracket and then tighten the fastener wheel.

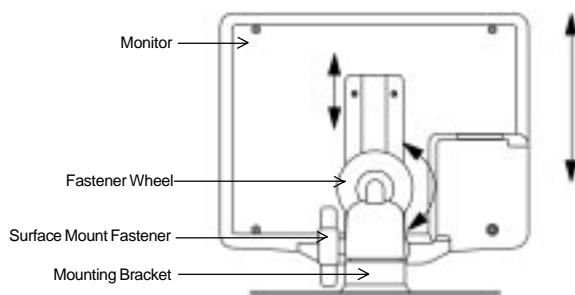

- 3) Adjust viewing angle of monitor by tightening the fastener at the side.

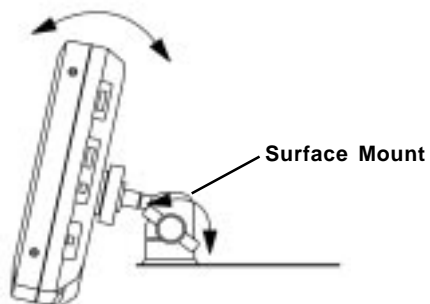

- 4) When the system components are mounted, test the system to verify that it is functioning correctly. Make sure that no wiring was pinched, or connected improperly during the final installation.

Headrest Mounting:

- 1) Remove the headrest from the vehicle for easiest installation.
- 2) Lay headrest on a flat surface.
- 3) Center trim collar on headrest as shown.

NOTE: Depending on the angle of the headrest the Trim Ring and housing may be mounted upside down.

- 4) Using a Permanent Marker, mark headrest material along the interior of the Trim Ring.

- 5) Remove the Trim Ring and mark an "X" from corner to corner as shown.

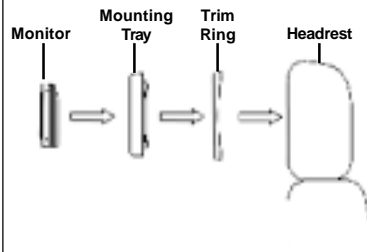

- 6) Using the utility knife, cut the headrest material along the "X" lines. Do not cut the material along the other lines at this time.



- 7) This will leave you with an "X" cut as shown.



- 8) Pull the flaps up and cut the foam beneath the material to the proper depth. Cut all four sides of the foam.



- 9) Using your fingers, tear the foam out of the headrest leaving a recess where the shell will be inserted.



NOTE: At this point you will need to install the harness up through the area into the recess. It may be helpful to follow one of the posts and tie wrap it to the post for restraint.

- 10) Lay the flaps of headrest material down into the recess and insert the Mounting Tray into the recess. Check for fit. If it does not fit properly, you may need to remove some more foam.

NOTE: The Mounting Tray will need to be secured to the headrest, either by using tie straps, screws, ect..

- 11) Guide the cable through the side opening of the Mounting Tray and plug it into the Monitor. Make sure the connector locks into place. Insert the Monitor into the Mounting Tray and secure the cable using tie wraps or screws
- 12) Turn the Monitor around and insert it into the Mounting Tray housing. Snap into place.
- 13) Connect the Monitor power input plug to a DC power source (Red plug +12 VDC, Yellow plug +12 VDC Constant and Black plug (-) to ground).
- 14) Connect the external video source output signal (from VCP/ DVD, TV Etc.) to the VIDEO IN jack. Test the system to verify proper installation.



ELECTRICAL CONNECTION (Wiring Diagram)

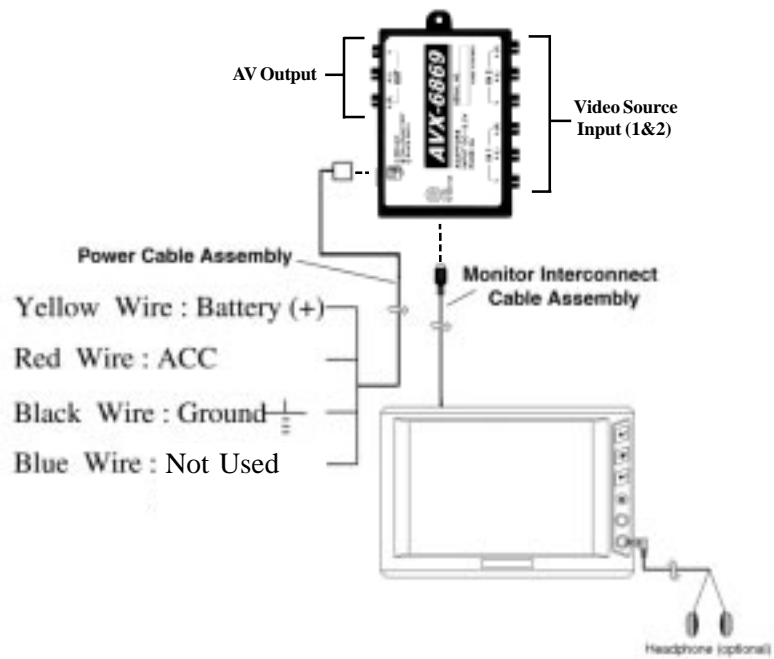

Monitor Removal:

The following procedure is to remove the Monitor from the Mounting Tray using the supplied Removal Tool. **NOTE:** Use care when performing this procedure not to scratch any exposed surfaces with the edges of the Removal Tool. Masking tape applied to the two tips or legs of the Removal Tool will help prevent scratching.

- 1) Locate the Removal Tool and apply tape to the tips.

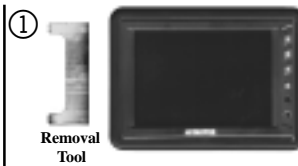

- 2) Insert the Removal Tool into the center of the space between the top outer Mounting Tray and the Monitor. You will hear click(s) when inserted correctly. This will disengage the two pressure latches holding the monitor in place.



- 3) While applying upwardly pressure, pull the Removal Tool out and up.

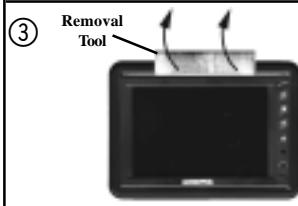

- 4) The Monitor will pop out from the top and can be removed by detaching the Monitor Cable.

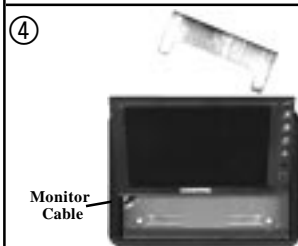

CONTROLS AND INDICATORS

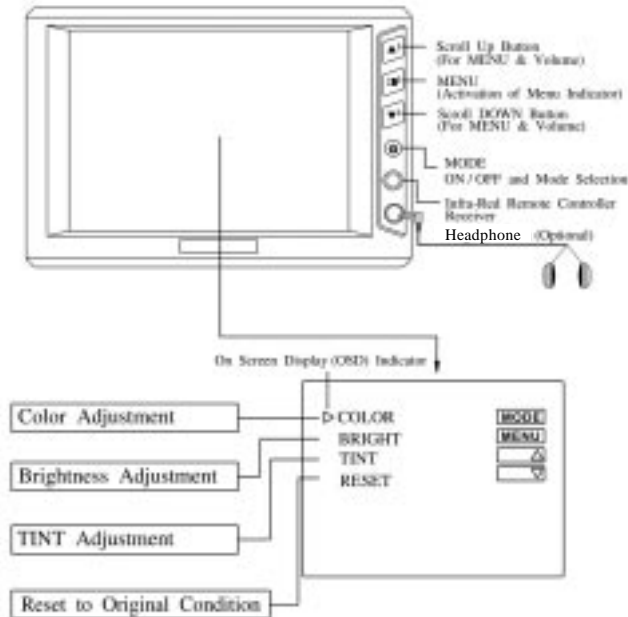

OPERATION

1. Press power On/Off button to the On position. The LED power indicator will light red.
2. Press the Picture Select button to adjust the picture display characteristics. The adjustments will be shown on the On Screen Display in the following sequence: Contrast, Brightness, Color, and TINT.
3. While in the video adjustment mode, press the up button to increase the selected adjustment level or press the down button to decrease the level.

MAINTENANCE

To avoid electrical shock, do not open the enclosure. High voltage is present. No user serviceable parts inside the enclosure.

Do not use any chemical solvent, cleaning agent or corrosive detergent to clean away dirt on the surface of the screen. To clean off dirt or fingerprint, we recommend the use of a soft damp lens cleaning cloth.

Should there be requirement to replace blown fuse, do remember to disconnect all power supply and switched off the unit before replacing it with a new one. Only use fuse's with a correct rating to avoid damaging the unit.

REMOTE CONTROLLER

NOTE: The Remote Controller supplied with this system is a standard remote control, which is used to operate other systems. The Remote Controller is not a universal remote and will only perform the functions described herein. Only the Keys highlighted on the Remote Controller image below are used to operate this system.



Functional Remote Controller Keys

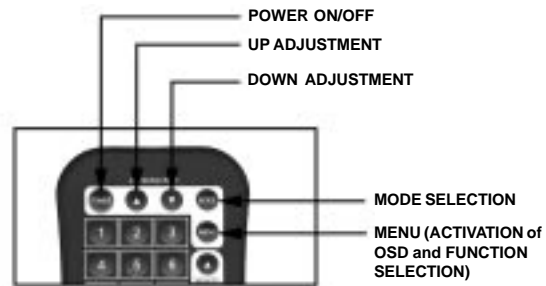

MENU FUNCTION KEY:

The MENU Key is used to navigate between the Color, Brightness and Tint adjustment modes. When the MENU Key is pressed an On Screen Display(OSD) will appear as shown bellow.

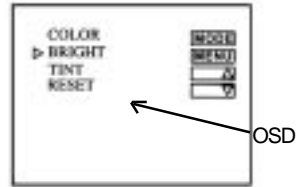

Press release and tap the MENU Key until the desired adjustment mode is selected. To return to the original settings select the RESET.

When an adjustment mode is selected, press and hold the either the ▲ or ▼ (CH/DISK/SET) Key until the desired setting is reached.

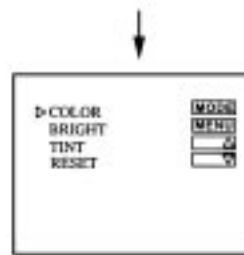

Using the ▲ Key

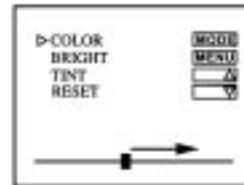

Using the ▼ Key

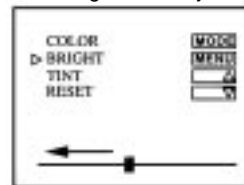

VIDEO SOURCE MODE KEY:

To switch between Video Input Sources (AV1 and AV2) press and release the MODE Key.

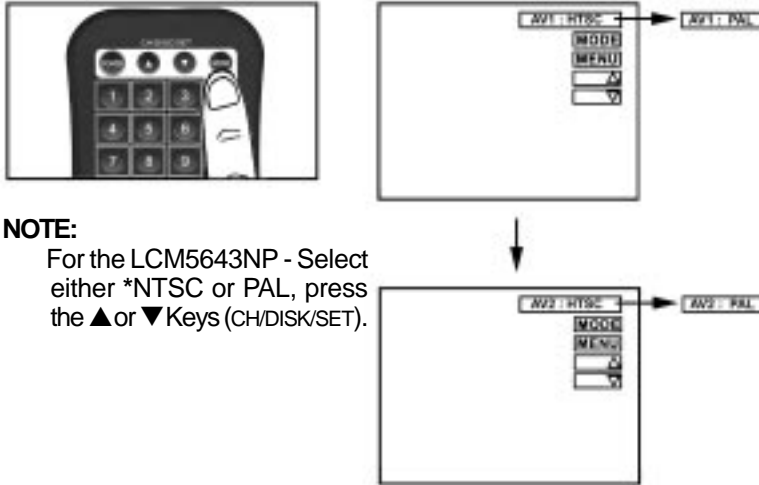

NOTE:

For the LCM5643NP - Select either *NTSC or PAL, press the ▲ or ▼ Keys (CH/DISK/SET).

VOLUME CONTROL KEY:

To increase or decrease the Volume, press and hold the VOL ▲ or ▼ Key until the desired volume is reached.



Replacement of Remote Controller Battery:

1. Use a small coin to pry open battery holder from compartment.
2. Remove old battery and put in a new one with positive sign “ + “ facing upward.
3. Push compartment into position.

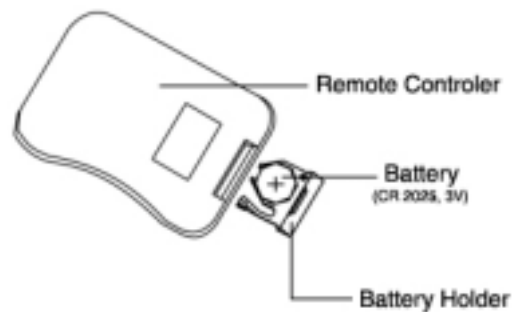

Precaution:

1. Dispose off used battery properly.
2. Do not misuse battery by short - circuiting the “ + “ and “ - “ terminal or put it into fire.
3. Remove used battery from compartment to prevent leakage from damaged battery.
4. To avoid accident, do prevent children from playing with the battery.

SPECIFICATIONS

LCM5043NP:

LCD Panel Size (Diagonal)	5"
LCD Panel Format	960 x 234 dots
LCD Panel Resolution	224,640 pixels
LCD Backlight Life	10,000 hrs
Image Aspect Ratio	4:3
Video Input Signal	NTSC Composite Video
Power Source	+12V
Power Consumption	10W
Operating Temperature	0 C to 60 C
Storage Temperature	-20 C to 80 C
Weight	0.259 kg
Dimensions	13.8 x 9.8 x 2.8 cm

LCM5643NP:

LCD Panel Size (Diagonal)	5.6"
LCD Panel Format	960 x 234 dots
LCD Panel Resolution	224,640 pixels
LCD Backlight Life	10,000 hrs
Image Aspect Ratio	4:3
Video Input Signal	NTSC Composite Video
Power Source	+12V
Power Consumption	10W
Operating Temperature	0 C to 60C
Storage Temperature	-20 C to 80 C
Weight	0.343 kg
Dimensions	15.1 x 10.8 x 3.1 cm



36 MONTH LIMITED WARRANTY

Applies to Audiovox Mobile Video Products

AUDIOVOX ELECTRONICS CORP. (the Company) warrants to the original retail purchaser of this product that should this product or any part thereof, under normal use and conditions, be proven defective in material or workmanship within 36 months from the date of original purchase, such defect(s) will be repaired or replaced with reconditioned product (at the Company's option) without charge for parts and repair labor.

To obtain repair or replacement within the terms of this Warranty, the product is to be delivered with proof of warranty coverage (e.g. dated bill of sale), specification of defect(s), transportation prepaid, to the Company at the address shown below.

This Warranty does not extend to the elimination of externally generated static or noise, to correction of antenna problems, to costs incurred for installation, removal or reinstallation of the product, or to damage to tapes, discs, speakers, accessories, or vehicle electrical systems.

This Warranty does not apply to any product or part thereof which, in the opinion of the Company, has suffered or been damaged through alteration, improper installation, mishandling, misuse, neglect, accident, or by removal or defacement of the factory serial number/bar code label(s). THE EXTENT OF THE COMPANY'S LIABILITY UNDER THIS WARRANTY IS LIMITED TO THE REPAIR OR REPLACEMENT PROVIDED ABOVE AND, IN NO EVENT, SHALL THE COMPANY'S LIABILITY EXCEED THE PURCHASE PRICE PAID BY PURCHASER FOR THE PRODUCT.

This Warranty is in lieu of all other express warranties or liabilities. ANY IMPLIED WARRANTIES, INCLUDING ANY IMPLIED WARRANTY OF MERCHANTABILITY, SHALL BE LIMITED TO THE DURATION OF THIS WRITTEN WARRANTY. ANY ACTION FOR BREACH OF ANY WARRANTY HEREUNDER INCLUDING ANY IMPLIED WARRANTY OF MERCHANTABILITY MUST BE BROUGHT WITHIN A PERIOD OF 48 MONTHS FROM DATE OF ORIGINAL PURCHASE. IN NO CASE SHALL THE COMPANY BE LIABLE FOR ANY CONSEQUENTIAL OR INCIDENTAL DAMAGES FOR BREACH OF THIS OR ANY OTHER WARRANTY, EXPRESS OR IMPLIED, WHATSOEVER. No person or representative is authorized to assume for the Company any liability other than expressed herein in connection with the sale of this product.

Some states do not allow limitations on how long an implied warranty lasts or the exclusion or limitation of incidental or consequential damage so the above limitations or exclusions may not apply to you. This Warranty gives you specific legal rights and you may also have other rights which vary from state to state.

U.S.A.: AUDIOVOX ELECTRONICS Corp., 150 MARCUS BLVD., HAUPPAUGE, NY 11788 1-800-645-4994

CANADA : CALL 1-800-645-4994 FOR LOCATION OF WARRANTY STATION SERVING YOUR AREA

© 2002 Audiovox Electronics Corp., Hauppauge, NY

128-6323

128-6323
20 of 20

Free Manuals Download Website

<http://myh66.com>

<http://usermanuals.us>

<http://www.somanuals.com>

<http://www.4manuals.cc>

<http://www.manual-lib.com>

<http://www.404manual.com>

<http://www.luxmanual.com>

<http://aubethermostatmanual.com>

Golf course search by state

<http://golfingnear.com>

Email search by domain

<http://emailbydomain.com>

Auto manuals search

<http://auto.somanuals.com>

TV manuals search

<http://tv.somanuals.com>