

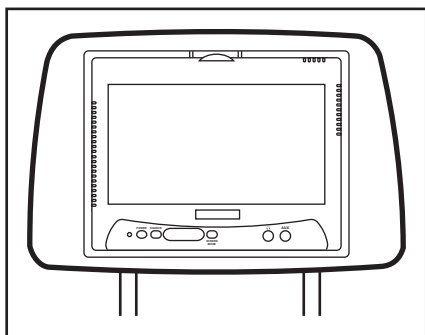

MMD7HRB
MMD7HRT
MMD7HRG

Two Specific Vehicle Headrests
With 7" LCD Monitors and Built-In
DVD Player for Rear Seat Entertainment

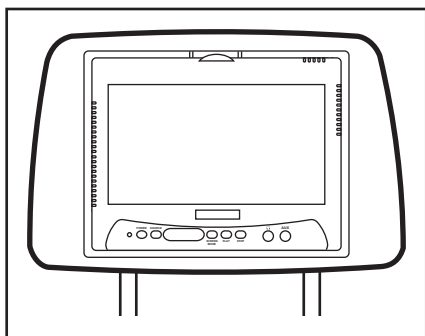

Installation Guide

IMPORTANT

Installation of headrest products require careful planning and preparation. Be extremely careful of seats that have air bags built into them. Keep wiring away from any air bag wiring (usually identified by yellow connectors and yellow wire jackets). Damage to air bag wiring can result in personal injury to vehicle occupants. If you have any questions regarding wire routing or installation in a vehicle, please contact Audiovox Technical Support at 1-800-225-6074.

When connecting power and ground in a mobile video installation, insure that the ACC wire is fused at the point where it is connected to the vehicle ACC wiring. Failure to do so can result in damage to the vehicle if a short circuit develops between the vehicle connection point and the mobile video product.

An LCD panel and/or video monitor may be installed in a motor vehicle and visible to the driver if the LCD panel or video monitor is used for vehicle information, system control, rear or side observation or navigation. If the LCD panel or video monitor is used for television reception, video or DVD play, the LCD panel or video monitor must be installed so that these features will only function when the vehicle is in "park" or when the vehicle's parking brake is applied.

An LCD panel or video monitor used for television reception, video or DVD play that operates when the vehicle is in gear or when the parking is not applied must be installed to the rear of the driver's seat where it will not be visible, directly or indirectly, to the operator of the motor vehicle.

Licensed under one or more of the following patents:
Patent NOS. 7245,274 and 6,899,365

MATERIALS INCLUDED IN THIS PACKAGE:

- 1) **MMD7HRB, MMD7HRT, MMD7HRG System Monitor**
MMD7HRM Master Monitor with DVD Player (1pc)
MMD7HRS Satellite Monitor (1pc)

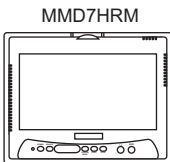

Master Monitor (M1)

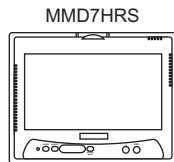

Satellite Monitor (SM)

2) Interface Harness
(P/N 136-3977) - (1pc)

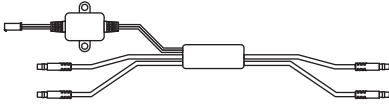

2) Universal Remote Control
(P/N 136-3785) – (1pc)

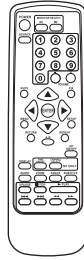

3) AV Adapter Cable
(P/N 112B3227) - (2pc)



4) 2 Pin DC Power Cable
(P/N 112-3667) - (1pc)



5) Post Tube 12MM
(P/N 100-2508) - (2pcs)

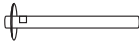

6) Post Tube 14MM
(P/N 100-2509) - (2pcs)

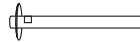

7) Wired Headphone (P/N 136-3758) - (2pcs)



OPTIONAL ACCESSORIES:

8) Infrared Channel Wireless Headphones



MMD7HRB, MMD7HRT, MMD7HRG SYSTEM OVERVIEW

- 1) The SYSTEM is a versatile audio / video system with built-in DVD player (MMD7HRM only) which includes two monitors, that can accept an Audio / Video input and independent AUX input. A separate audio output is provided for connecting an optional FM Modulator to the vehicle's radio.
- 2) The M1 Monitor (MMD7HRM) is comprised of a 7" TFT LCD monitor with built-in DVD player that allows the user to playback DVD, and the AUX source. The M1 monitor has a built-in infrared audio transmitter (CHA) for use with the optional two-channel wireless headphones (CHA).
- 3) The SM Monitor (MMD7HRS) is comprised of a 7" TFT LCD monitor that allows the user to select display from the DVD source in M1 (AV1) or AUX source. The SM monitor has a built-in infrared audio transmitter (CHB) for use with the optional two channel wireless headphones (CHB).
- 4) The monitors will show all of the functions with the comprehensive OSD.
- 5) The optional two-channel wireless Headphone sets have an A-B switch that allow the users to select the audio from either M1 (MMD7HRM, CHA) or SM (MMD7HRS, CHB).
- 6) Using different IR codes, the M1 Monitor will only respond to the remote control unit when the Monitor Select (**M1**) button on remote control is pressed. The SM Monitor will only respond to the Remote Control unit when the Monitor Select (**M2**) button on remote control is pressed.
- 7) The wired headphones allow the user to listen to audio from the system.
- 8) The M1 (MMD7HRM) and SM (MMD7HRS) Monitor will accept an audio / video input through the 1/8" jack located on the front of the unit. The audio / video device could be a video game system, video camera, or other input device.

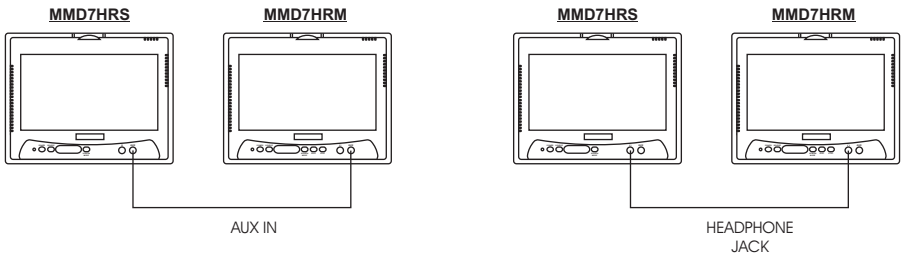

9) Pivot the screen until a comfortable viewing angle reached. The internal lock limits the screen to a maximum adjustment of 30 degrees from closed position, the headrest itself can be tilted forward to help achieve a comfortable viewing position.

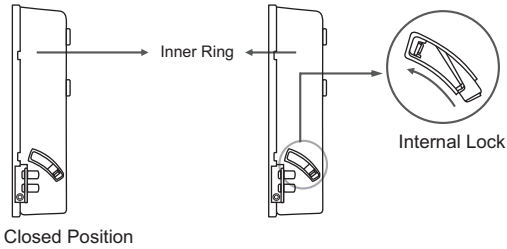

10) Insert disc

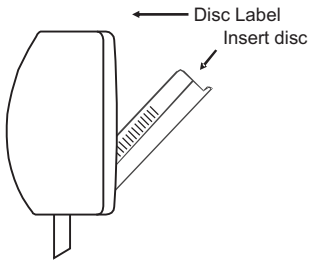

MMD7HRM Monitor only.

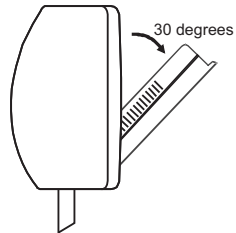

11) Eject disc

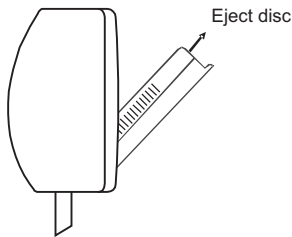

MMD7HRM Monitor only.

Headrest Installation Description

Choose the headrest cover color to best match your vehicle interior.

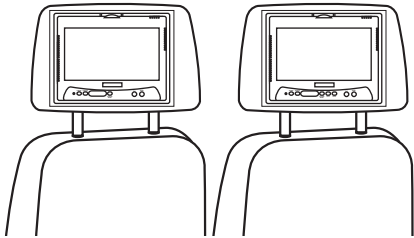

Monitor Unit

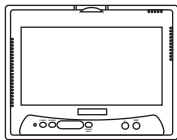

MMD7HRS
(Satellite Monitor)

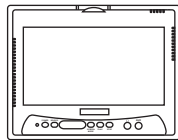

MMD7HRM
(Master Monitor)

HEADREST SEMI - ASSEMBLY WITH UNIT

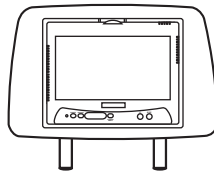

MMD7HRS Monitor
(Satellite Monitor / SM)

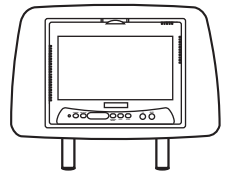

MMD7HRM Monitor
(Master Monitor / M1)

①

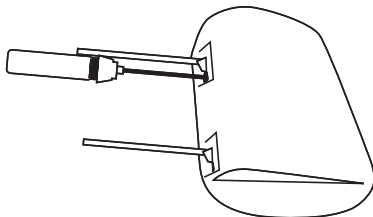

Use a screwdriver to loosen the screw from the inner-bracket of the headrest.

②

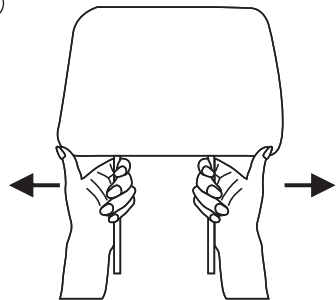

Push the headrest support inwards or pull them outward adjust the distance.

3

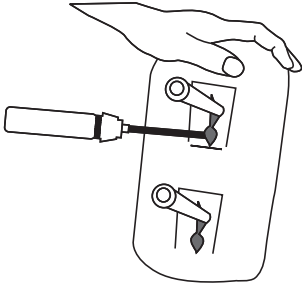

Use a screwdriver to tighten the screw after headrest support have been adjusted.

4

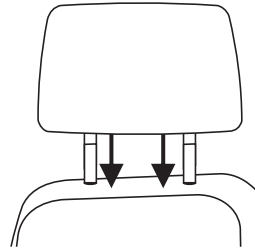

5

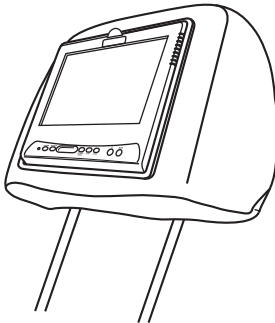

6

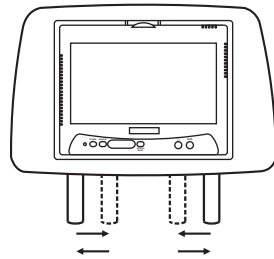

Adjust match your vehicle seatback dimension

VEHICLE PREPARATION:

- 1) Read the manuals and get familiar with the electrical requirements and connections.
- 2) Prepare the vehicle by removing any interior trim necessary to gain access to the vehicle's wiring as well as all areas where interconnecting wire harnesses will be located. (Refer to the Installation Procedure). The mounting method, and the location will vary from vehicle to vehicle, so this manual will only focus for the installation of the UNIT Master and Satellite Monitors in the supplied configuration. The best location for the UNIT components is:
 - a. Monitors: (NOTE: The MMD7HRM Monitor should be installed where the passenger usually sits behind the front passenger seat.
 - b. Audio Interface Box: Under either seat where monitors are located.
- 3) Locate an accessory power source (+12VDC present when the ignition key is in the accessory and run positions. 0VDC should be present when the ignition key is in the OFF position), and a good ground. Generally, these wires can be located at the ignition switch or fusebox.

(NOTE: Ensure that the switched power is fused at the source. Failure to do so may result in vehicle wiring damage.)
- 4) Run the wiring harnesses throughout the vehicle as necessary. (Refer to the Wiring Diagrams on page 10, as well as the wiring instructions for the individual components and accessory options being installed). Be sure, that all the wiring is protected from sharp edges and is routed in such a manner that it will not be pinched, when it is fully installed. Be sure to leave enough slack in the wiring at each component to allow sufficient working room. Be sure to leave enough slack in the monitor cables to allow the headrest to move up or down, and the seat to move backward and forward.
- 5) Remove all the components from their packaging and then place them in the vehicle at their respective locations.
- 6) Install the Headrests:
 - a. Remove vehicle's original Headrests. Measure the distance between the posts and adjust the new Headrests to same dimension.
 - b. Place the appropriate headrest support tube into the support tube hole. (If needed)
 - c. Hold the UNIT Headrest above the seat and insert the two cables into the headrest support tube holes. Make sure that the headrest is in the correct position (Display facing the rear).

- 7) Connect all the components together (electrically) and verify proper operation of all the system functions.
 - a. The headrest DIN cables and the Interface Harness DIN cables are color coded. Connect each headrest cable to the correct color cable on the Audio interface harness. In some vehicles it will be necessary to use the supplied DIN extension cables to reach from under one seat to the other seat. The DIN extension cables can be used for either the MMD7HRM or MMD7HRS monitors. The extension cables are labeled with color coded Green/Red and Blue/Yellow. When connecting the extension cables, ensure that the Green/Red extension cable is used with the Master monitor cable and the Blue/Yellow extension cable is used with the Satellite monitor cable.
 - b. Connect the DC power jack.
- 8) Verify proper operation of the system.
- 9) Make sure that no wiring is pinched, or connected improperly during the final installation.

MMD7HRPKG WIRING DIAGRAM

MMD7HRS Monitor
Satellite Monitor

MMD7HRM Monitor
Master Monitor

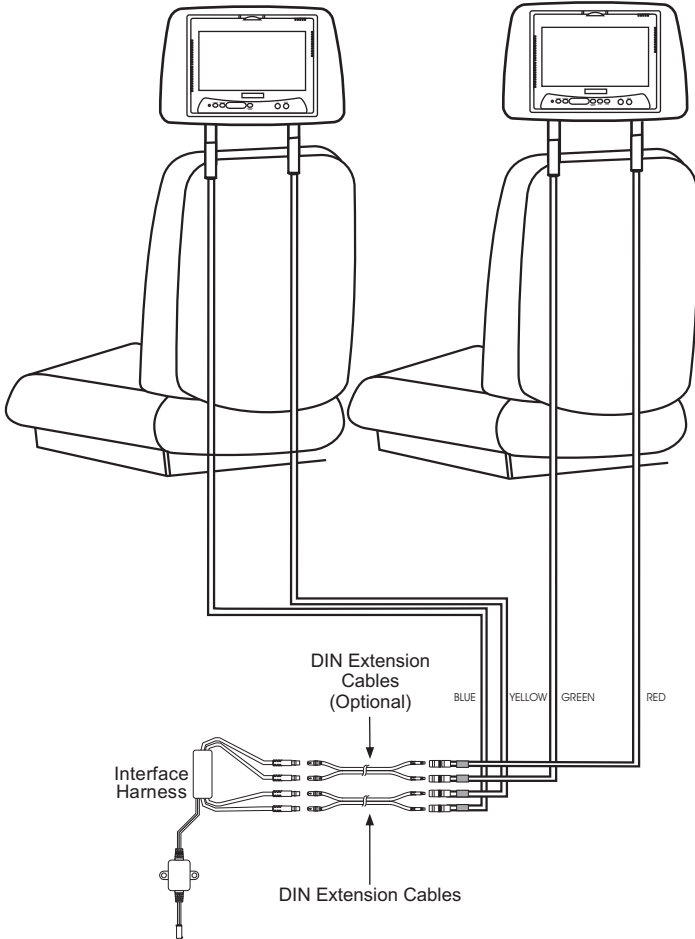



For Customer Service
Visit Our Website At
www.mobile.audiovox.com
Product Information, Photos,
FAQ's Owner's Manuals

Free Manuals Download Website

<http://myh66.com>

<http://usermanuals.us>

<http://www.somanuals.com>

<http://www.4manuals.cc>

<http://www.manual-lib.com>

<http://www.404manual.com>

<http://www.luxmanual.com>

<http://aubethermostatmanual.com>

Golf course search by state

<http://golfingnear.com>

Email search by domain

<http://emailbydomain.com>

Auto manuals search

<http://auto.somanuals.com>

TV manuals search

<http://tv.somanuals.com>