

VOD128A
12.1" OVERHEAD LCD
MONITOR WITH
DVD PLAYER

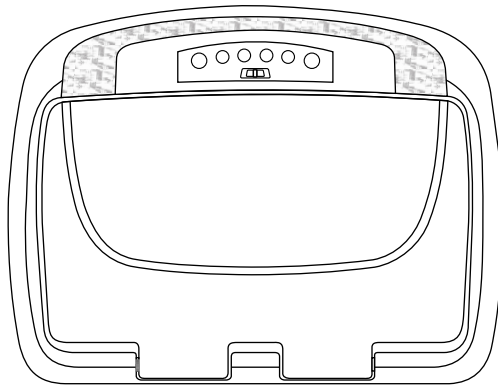

OPERATION
MANUAL



128-8353

Important Notice

An LCD panel and/or video monitor may be installed in a motor vehicle and visible to the driver if the LCD panel or video monitor is used for vehicle information, system control, rear or side observation or navigation. If the LCD panel or video monitor is used for television reception, video or DVD play, the LCD panel or video monitor must be installed so that these features will only function when the vehicle is in "park" or when the vehicle's parking brake is applied.

An LCD panel or video monitor used for television reception, video or DVD play that operates when the vehicle is in gear or when the parking brake is not applied must be installed to the rear of the driver's seat where it will not be visible, directly or indirectly, to the operator of the motor vehicle.

Warnings

- Do not use any solvents or cleaning materials when cleaning the video monitor.
- Do not use any abrasive cleaners, they may scratch the screen.
- Use only a lightly dampened lint free cloth to wipe the screen if it is dirty.
- Lock the LCD screen in the fully closed position when not in use.
- Before putting on headphones always adjust the volume setting to the lowest position.
- Remember to leave the dome light switch in the off or auto positions when the vehicle is unattended, as the dome lights, if left on, can drain the vehicle's battery.
- Do not put pressure on the screen.
- Caution children to avoid touching or scratching the screen, as it may become dirty or damaged.

Licensed under one or more of the following patents,
Patent NOS. 5,775,762 and 5,927,784

Congratulations

Congratulations on your purchase of the Audiovox VOD128A DVD Player with Drop-Down Video / Monitor. The VOD128A has been designed to give you and your family many years of video entertainment in the mobile environment. Please read the directions that follow to familiarize yourself with the product to ensure that you obtain the best results from your equipment.

Please note: Installation options vary, see the individual owner's manuals for each component in your system to obtain a full understanding of each component's operation.

Safety Precaution

For safety reasons, when changing video media it is recommended that the vehicle is not in motion, and that you do not allow children to unfasten seat-belts to change video media or make any adjustments to the system. System adjustments can be accomplished using the remote control, while seat-belts remain fastened. Enjoy your Audiovox entertainment system but remember the safety of all passengers remains the number one priority.

FEATURES

- 12.1" TFT (Thin Film Transistor) Active Matrix LCD (Liquid Crystal Display) Monitor
- Built-in DVD Player
- Auto On with Disc insertion
- Selectable (M1 and M2) IR Receive and Transmit Codes
- Multi-Lingual OSD (On Screen Display) for Control of Picture Quality and Functions
- Switchable Channel Infrared Transmitter for use with IR Wireless Headphones
- Four Audio / Video Source Inputs (DVD, VIDEO 1, VIDEO 2, VIDEO 3)
- Dome Lights with Built-in Three Way Switch
- Built-in 16 Channel Frequency Wireless FM Modulator
- Last Position Memory for DVD
- Headphone Jack
- Screen Mode Selection (16:9, 4:3)
- Remote Control
- Wireless Game Controller
- Backlit Touch Sensitive Controls
- Day / Night Picture Modes
- AV Output
- Pause To Talk Feature

CONTROLS AND INDICATORS DIAGRAM (FRONT VIEW)

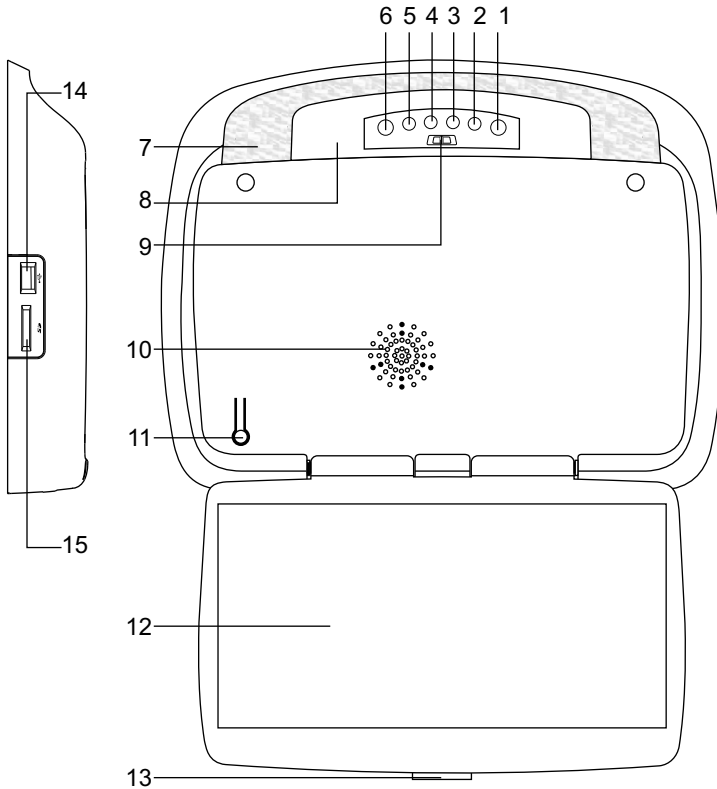

1. EJECT (▲) Control

This control is used for ejecting discs from the disc compartment. (**Note:** Disc can be ejected with the unit turned Off. Vehicle ignition must be in Run or ACC position). After the Disc is removed the unit will turn Off after 15-20 seconds.

2. STOP (■) Control

- Touch STOP once : Stops playback, touching the PLAY button again will resume normal playback.
- Touch STOP twice : To stop playback.

3. PLAY (▶) Control

This control is used to start playback of a disc.

4. Source Select

Use to select one of the four sources: DVD, VIDEO 1, VIDEO 2, VIDEO 3.

5. FMM Source Select Control

Used to select the frequency in sequence rotation: FM OFF, CH1 88.1MHz, CH2 88.3MHz, CH3 88.5MHz, CH4 88.7MHz, CH5 88.9MHz, CH6 89.1MHz, CH7 89.3MHz, CH8 89.5MHz, CH9 89.7MHz, CH10 89.9MHz, CH11 90.1MHz, CH12 90.3MHz, CH13 90.5MHz, CH14 90.7MHz, CH15 90.9MHz, CH16 91.1MHz.

6. POWER (⏻) Control

Used to turn the system on/off.

7. Dome Lights

Provide additional interior illumination.

CONTROL FUNCTION DESCRIPTION (FRONT VIEW)

8. Infrared Transmitter and Sensor

Transmits audio to wireless headphones. Also allows the remote control to operate the VOD128A and to control other accessories in the system.

9. Three Position Dome Light Switch

ON – Turns on the dome lights.

OFF – The dome lights will not turn on in this position.

AUTO – Automatically switches on the dome lights in conjunction with the vehicle's interior illumination.

10. Ventilation Openings

11. LCD Cut Off Switch

Used to turn off the LCD panel monitor when in the closed position.

12. LCD Panel

13. Screen Release

Press to release the screen.

14. USB 1.1 INPUT FOR USB THUMB DRIVE

15. SD Card Reader - Allows reading the contents (Audio, Photo, Video) data stored on the Secure Digital Card (SD Card).

The VOD128A has an option that allows the user to select from two IR transmit and receive codes (M1 or M2). This feature can be used when using two VOD128As in the same installation or if the vehicle has an RSA (Rear Seat Audio) that uses an "A" channel headset. The VOD128A comes factory set to M1. When in the M1 mode the unit will respond to remote commands when M1 is selected on the remote and will transmit audio on the A channel. When in the M2 mode the unit will respond to remote commands when M2 is selected on the remote and will transmit audio on the B channel.

Note: 2-channel IR headphones (set to CH B) will need to be used when monitor is set to M2 mode.

Note:

OSD will appear on the screen for 4~5 seconds

Selecting a Monitor Code (M1 or M2)

1. Power ON unit and waiting until M1 OSD appears, the M1 OSD will appear on the screen for 4~5 seconds. After the M1 OSD disappears, within 10 seconds press remote control TV button and continue press code number **6353**. It will change from M1 to M2.
2. To change the monitor code from M2 to M1, repeat the above instruction

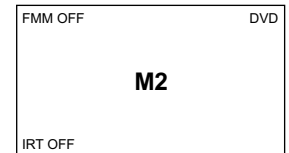
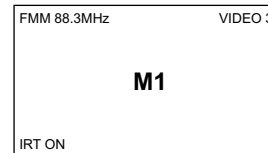

CONTROL FUNCTION DESCRIPTION (SIDE VIEW & BACK VIEW)

Side View

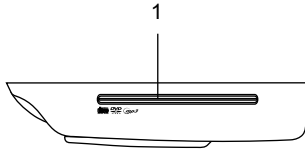

1. DVD Disc insertion Slot

For loading and removing discs. Unit will turn On and load disc when disc is inserted. Insert disc with label side facing up.

Note: Disc slot will be lit when unit is turned Off for easy loading at night.

Back View

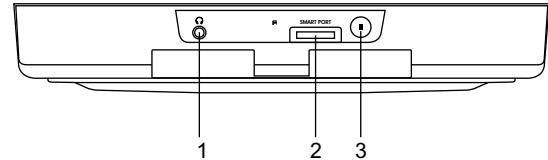

1. Headphone Jack

Allow the use of wired headphones with a 1/8" (3.5mm) plug for listening to the video program audio.

2. Smart Port

AUX Cable - Connect Auxiliary AV Input.

Remark: When AUX cable is connected. The game feature will be disabled.

3. PAUSE To Talk (II) Button

Allows the front seat passenger to pause the playback. Pressing PAUSE again or touching the PLAY button will resume normal playback.

REMOTE CONTROL OPERATION

Back View

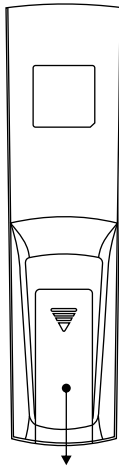

Battery Cover

Battery Installation

Before attempting to operate your Remote Control, install the batteries as described below.

- 1) Turn the Remote Control face down. Using your finger, slide the battery cover off in the direction of the arrow.
- 2) Install Two "AAA" batteries. Make sure that proper polarity (+ or -) is observed.
- 3) Align the cover tabs with the remote control and slide the cover until it locks.

The remote control will operate the VOD128A. It is not a universal remote control and will not control equipment from other manufacturers.

MAIN FUNCTION DESCRIPTION

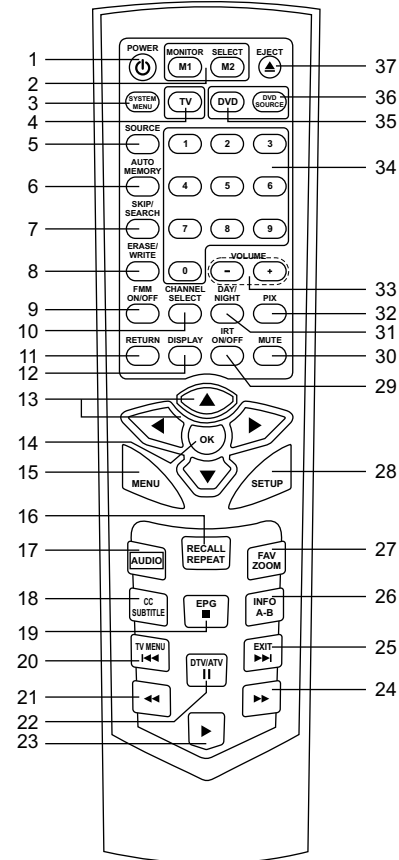

- * Function control is available on the unit and the remote control.
- ** Function not available in this model.

1. POWER Button*

Press this button to turn the unit ON and OFF.

2. MONITOR SELECT

M1 Button – Sets the remote control code to allow control of the unit set to M1 mode. (See page 5 for detail)

M2 Button – Sets the remote control code to allow control of the unit set to M2 mode.

3. SYSTEM MENU Button

Allow the user to access the system menu. Press cursor (▲▼) buttons to select desired screen mode, OSD language and source default on power up.

4. TV Mode Select Button**

Switches certain function keys on the remote control for TV functions.

5. SOURCE Button*

Each time the button is pressed, the audio/video source will change in the following sequence: DVD > VIDEO 1 > VIDEO 2 > VIDEO 3.

6. AUTO MEMORY Button (AUTO PROGRAM Button)**

When the AUTO MEMORY button is pressed, all channels are searched and channels that are detected with signals of sufficient levels are automatically stored in memory.

7. SKIP / SEARCH Button**

This button selects between SKIP and SEARCH mode. In "SKIP mode" the TV tuner will tune and stop on channels that are programmed into memory when the CHANNEL UP / DOWN buttons are used. When the SKIP mode is disable, the TV will stop on all active channels.

8. ERASE / WRITE Button**

While tuned to a channel, pressing this button will alternately store or erase the channel from memory.

9. FMM ON / OFF Button*

Turns the wireless FM Modulator on or off.

10. CHANNEL SELECT Button*

Selects the wireless FM Modulator Frequency (CH1-88.1MHz, CH2-88.3MHz, CH3-88.5MHz, CH4-88.7MHz, CH5-88.9MHz, CH6-89.1MHz, CH7-89.3MHz, CH8-89.5MHz, CH9-89.7MHz, CH10-89.9MHz, CH11-90.1MHz, CH12-90.3MHz, CH13-90.5MHz, CH14-90.7MHz, CH15-90.9MHz, CH16-91.1MHz)

11. RETURN Button

Press Return Once : Go to disc menu.

Press Return Twice : Go to movie playback.

12. DISPLAY

Press to display current disc information while the disc is playing. Press cursor (▲▼) buttons to select the Title or Chapter.

For Title/Chapter selection use the numeric buttons to enter the desired Title Chapter selection.

13. CURSOR / CHANNEL UP DOWN (▲▼◀▶)

Use these buttons to navigate the menu selections on the screen.

Use the CH▲ to increase the channel number and use CH▼ to decrease the channel number. **

14. OK Button (ENTER)

Used to implement a selected setting or menu option.

15. MENU Button

Allows the user to access the DVD MENU (DVD MODE).

16. REPEAT Button

Allows the user to repeat a selected title, chapter, or track.

17. AUDIO Button

Press to display and select the available AUDIO languages in DVD mode. Each time you press the button, the language changes.

Note: *The available audio languages vary from disc to disc.*

18. SUBTITLE Button

Press to display and select the available subtitle language in DVD mode. Each time you press the button, the subtitle language changes.

Note: *The type and number of languages for subtitle vary from disc to disc.*

19. STOP (■) Button*

Press to stop playback.

20. PREVIOUS (⏮) Button

Press to return to the previous chapter or track.

21. SCAN BACKWARD (⏪) Button

Press to search in a backward direction. Press repeatedly to change the search speed from 2, 4, 8, and 16 times the normal speed.

22. PAUSE (⏸) Button*

Allows the user to pause the playback. Pressing pause again or pressing the Play Button will resume normal playback.

23. PLAY Button*

Press to activate the play mode when a disc is loaded in the disc compartment.

24. SCAN FORWARD (⏩) Button

Press to search in a forward direction. Press repeatedly to change the search speed from 2, 4, 8, and 16 times the normal speed.

25. NEXT (⏭) Button

Press to skip to the next chapter or track.

26. A-B Button

Allow user to repeat the playback from point A to point B.

Press A-B button **On-Screen Display** **DVD player**

Once	Repeat A-	Mark the beginning of the section to repeat (Set point A)
Twice	Repeat A-B	Mark the end of the section to repeat (Set point B)
3 times	AB Off	Cancel the A-B repeat function

27. ZOOM Button

Press this button to enlarge the picture when playing a DVD disc.

Press ZOOM button **DVD player perform**

Once	Enlarge the picture 1 times of the original size
Twice	Enlarge the picture 2 times of the original size
3 times	Enlarge the picture 3 times of the original size
4 times	Picture is returned to original size

28. SETUP Button

Press to display the Setup Menu which allows the user to change the DVD player options such as Language, Video, Rating and Misc. Refer to the settings and Adjustments section for more information.

29. IRT ON/OFF Button

Turns the Infrared Transmitter ON or OFF for IR Wireless Headphones. Pressing M1 then IRT ON/OFF will control the IR Transmitter for M1. Pressing M2 then IRT ON/OFF will control the IR Transmitter for M2.

30. MUTE Button

Press this button to mute the audio for wireless FMM and wired headphones.
Pressing the button again restores the sound to the previously set level.

31. DAY / NIGHT Mode Button

This control toggles the unit between “Day” and “Night” LCD illumination modes. In the “Day” mode, the LCD backlit intensity is brighter. In “Night” mode, the LCD backlit is dimmed to a preset level that is more suitable for low light operation.

32. PIX Button (Picture Select)

Each time this button is pressed, the on screen picture adjustment displays the “adjustment bar” for BRIGHTNESS, CONTRAST, COLOR, TINT or RESET. Once the desired adjustment bar is displayed, use the VOLUME(+)/ VOLUME(–) button to adjust the setting. The display will automatically turn off if no adjustments are made within 6 seconds, or is any other button is pressed.

33. VOLUME DOWN (–) or UP (+)

Press to decrease or increase the level of the picture adjustments. Press to decrease or increase the volume of the wired headphones.

34. NUMBER Buttons

Allow the user to enter numbers 0 to 9 for selection of selection of CD tracks, DVD chapters and password.

35. DVD Mode Select Button

Switches certain function keys on the remote control for DVD function.

36. DVD Source

This button is only active when remote control is in DVD mode. Each time the button is pressed one of the source (DVD, Card Reader and USB) will be selected. If the Card Reader and USB are not plugged in, it will remain on DVD Source. Press to change source in sequence of DVD > SD > USB.

37. EJECT (▲) Button*

This button is used to eject the disc.

MENU ADJUSTMENT

The System Menu Contains features and options that let you customize your system to change the screen mode display, OSD language and source default.

- 1) Press the SYSTEM MENU button on the remote, the main page of the system menu will appear on screen.
- 2) Use the cursor buttons ▲ or ▼ to select the desired item in the main page and press the OK button to select.
- 3) The sub menu will appear on screen.
- 4) Use the cursor buttons ▲ or ▼ to select an item in the sub menu and then press the OK button to select.
- 5) Press the System Menu button to exit System Menu.

Note: System Menu can be controlled via Remote Control only. (Items selected in the menu will have a green background)

SCREEN MODE SELECT

This allows the user to change the screen format (aspect ratio 16:9, 4:3).

- 1) To select the screen aspect ratio format highlight SCREEN MODE and then press the OK button to enter the sub menu. Use the cursor buttons ▲ or ▼ to select from either 4:3 or 16:9. Press the OK button to confirm the setting.

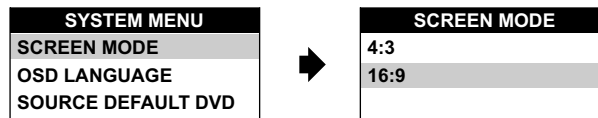

OSD LANGUAGE

This allows the user to select the language for the on-screen display. The user can either select English, Spanish, French or German for the OSD language.

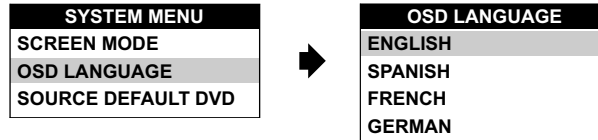

SOURCE DEFAULT DVD

This allows the user to select from:

DVD default on- Whenever the unit is turned on it will return to DVD mode.

DVD default off- Whenever the unit is turned on it will return to the last source selected.

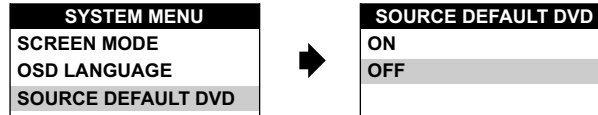

SETTINGS AND ADJUSTMENTS

The Setup Menu contains features and options that let you customize your DVD player. For example, you can set a language for the on-screen display or prevent DVD playback of certain DVD discs (For example PG-13 or R Rated) for children.

Using the Setup Menu

1. Press the SETUP button on the remote. The Setup Menu appears on the screen as shown per diagram.

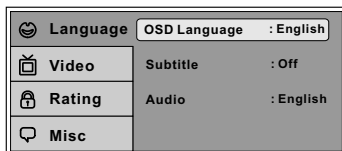

2. In order to set the desired option, move the highlight into the setup area using the cursor button ►.
3. After entering the setup area, highlight the desired option using the cursor button ▲ or ▼.
4. Press ► to move the highlight to the different options for the selected item. Press ▲ or ▼ to select the desired options, and then press OK button to confirm the selection.
5. Repeat steps 3~4 to continue setting the options that reside on the same Setup Page.
6. To change to another Setup page, press ◀ until the highlight moves back to the icon on the top part of the Setup Menu. Then, repeat steps 2~5.

Exiting the Setup Menu

Press the SETUP button again.

LANGUAGE SETUP

Language for On-Screen Display

OSD MENU: The OSD MENU setup allows you to select the language for the on-screen display. The user can either select English, French, Spanish, German or Italian for the OSD language.

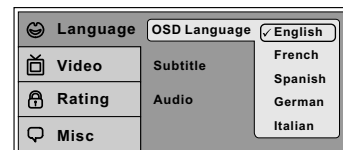

SUBTITLE SETUP

Select "SUBTITLE" using ▲▼button, then press ►button to enter the Sub menu. Select the subtitle you desire using ▲▼button, then press "OK" to confirm the setting. Press ◀button to return.

Note: The subtitle selection is only available for discs that are recorded in the above listed languages. If the selected, language is not available, the player will play and display on the screen the original language contained in the disc.

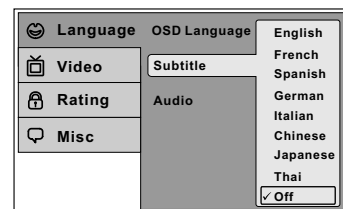

AUDIO SETUP

Select "AUDIO" using ▲▼button, then press ►button to enter the Sub menu. Select the audio you desire using ▲▼button, then press "OK" to confirm the setting. Press ◀button to return.

Note: The audio selection is only available for discs that are recorded in the above listed languages. If the selected, language is not available, the player will play and display on the screen the original language contained in the disc.

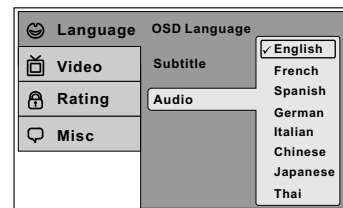

VIDEO SETUP

TV Display

The TV DISPLAY setup allows you to adjust screen setting (aspect ratio).

4:3 This displays the wide picture with black bands on the upper and lower portions of the screen.

16:9 This displays a wide picture with black bands on the upper and lower portion of the screen.

The bandwidth will vary, depending on the aspect ratio of the disc.

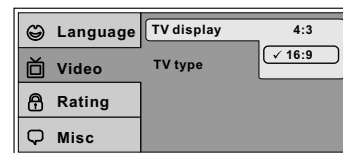

TV Type

The TV TYPE setup allows you to select the system to fit to the color system of the TV to be connected.

NTSC - Select this type for NTSC TV

PAL - Select this type for PAL TV

MULTI - Select this type for multi-system TV

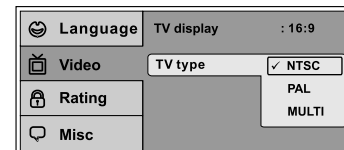

RATING SETUP

Rating

This item allows you to limit the content of movie playback from G to Adult. The lower the value, the more strict the control.

1. G
2. PG
3. PG - 13
4. R
5. NC - 17
6. Adult

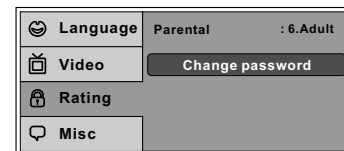

The rating level can only be changed when the displayed lock is open. For first time use to change parental control, use the cursor ► button to enter parental mode, key in the default password (3308) and press OK. Press OK button again to select the parental level, select the level and press OK. To change the password to your own password press "Change Password" mode and enter the default password (3308) and press OK. Press OK button and again and key in a new four digit password. After complete press OK button to end the process.

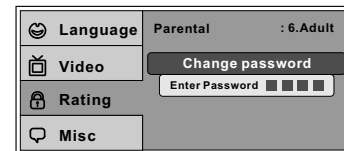

Note: The Default Password is 3308. This password is always effective even after you have selected your own password and changed it. To avoid the possibility of others using the default password to set the parental level and change the password, you can record this default password in another area and delete it from this manual. Some discs can be limited depending on the age of users while some discs cannot.

Misc SETUP

select "MISC" using ▲▼button, then press ►button to enter the Misc menu. Select the subtitle you desire using ▲▼button, then press "OK" to confirm the setting. Press ◀button to return.

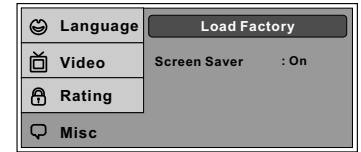

Load Factory

Load Factory allows you to reset all options to factory settings.

* This function will not affect the Rating control settings.

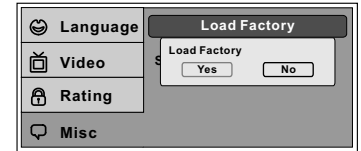

Screen Saver

ON -Screen saver will appear

OFF -Screen saver will not appear

Note: The DVD player will enable the Screen Saver mode if the unit is inactive for approximately 2 minutes.

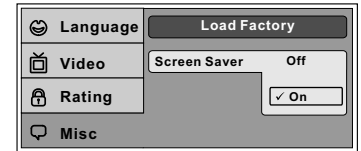

Playing DVDs

1. Press the DISPLAY button on the remote control to display the status banner. The banner includes title, chapter, angle, audio, subtitle, title selection & chapter selection.
2. **Title Selection**
Press numeric(0~9) buttons to initiate a change of title selection. Then press OK button to implement the selection.
3. **Chapter selection**
Press numeric(0~9) buttons to initiate a change of chapter selection. Then press OK button to implement the selection.

As you toggle through the options, the repeat option changes at that time. The track, for example, repeats once that track has ended. The selected repeat option loops repeatedly until you turn it off.

Playing USB, Memory Cards (SD/MMC/MS)

1. The System will detect the insertion of the USB or CARD (SD/MMC/MS) media automatically if no disc is loaded.
The system only auto detects the first media inserted (card or USB drive); the second media source can be manually selected by pressing the DVD source button on the remote control (See button 36 on Remote Control.)
2. When a disc is inserted, the system will switch to DVD mode immediately regardless of which type of media (card or USB) is currently playing.
3. The DVD source (DVD, USB, or SD Card) can only be changed if the DVD is stopped (not playing)
4. This system cannot support more than 2 memory partitions on the USB thumb drive.

Note: The system will always default to the DVD when the system detects a disc in the DVD player.

Playing MP3 Discs

MP3 is a format for storing digital audio. An audio CD-quality song can be compressed into the MP3 format with very little loss of quality, while taking up much less space. CD-R discs that have been encoded in MP3 format can be played on your DVD player. The DVD player plays the songs in the order they were burned on to the disc.

When playback is started the elapsed time of the track that is playing will be displayed.

Selecting Folders and Songs

When a device containing MP3 files is loaded in the player, the navigation menu appears automatically.

1. Press ▲ or ▼ to move the highlight to the desired folder (if present) on the left side of the menu and press OK. The songs in the folder will be displayed on screen.
2. Press ▲ or ▼ to move the highlight to the desired track containing the song and press OK to begin track playback.

Skipping Songs

Use the Next (▶▶) button on the remote control to move to the next song. Use the Previous (◀◀) button to move to the previous song.

Selecting a Play Mode

Filter (For MP3 & JPEG only)

Filter Mode enables or disables the display of files contained on the media based on their file extension.

The Filter function applies to the following formats:

- Audio** - Audio data format (MP3, WMA)
- Photo** - Photo data format (JPEG)
- Video** - Video data format (MPEG I, II)

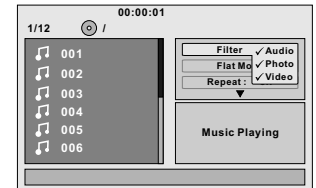

Flat Mode: play the entire disc

This mode is always on (default). During the Flat Mode all the data folder with MP3, JPEG & movies will be played in sequence. If the Flat Mode function is off, it will only play the selected folder; other folders are disabled.

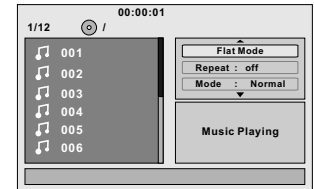

Repeat: play repetitively

Repeat function has 4 options : Off, Single, Folder, All. Move cursor to Repeat function and press OK, Off/Single/Folder/All are displayed in that order. Repeat default is Off;

Off Turn off repeat function

Single Repeat the song being played until STOP is pressed.

Folder Play all songs in a folder repetitively

All Play all songs on the disc repetitively

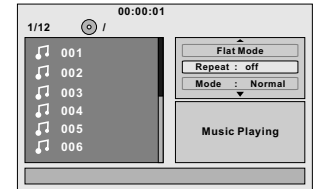

Mode: play mode

The Mode function has 4 options: Normal, Shuffle, Random and Music Intro. Move cursor to the desired Mode function and press OK; Normal/Shuffle/Random/Music Intro are selected in that order. The Mode function default status is Normal.

Normal: Play all songs in folder once

Shuffle: Play songs in a folder in a shuffle order. Each song in the folder is played only once.

Random: Play songs in a folder in a random order.

Music Intro: Play each song in order in the folder for 10 seconds

Remark– The purpose of the Music Intro function is to provide the user with a sample of each song for 10 seconds, thereby making it easy to select and listen to a favorite song.

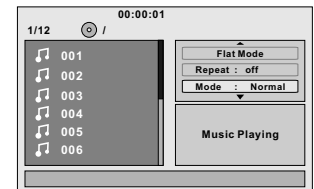

Add to program

Method: To add the selected songs into Browser view, make sure disc playback is off. Move cursor to Edit mode function and press OK. After Edit mode is selected, move cursor to songs list and select the songs which will be compiled and press OK. A check mark appears to the left of the selected song; to add the selected songs to the program, move cursor to the “Add to program” function and press OK. The selected songs is added into a new program list and the check mark will disappear on play list, move cursor to “Program view” function and press OK to browse the songs in the program. Press play button to play the selected songs.

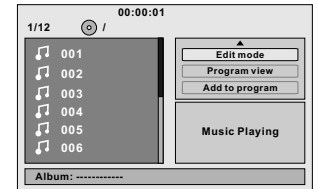

Notice: Edit mode, Program view or Add to program functions are relationship related when select the preferred song add to the songs list.

Clear program

Method: To clear the selected songs program file, double press stop button to the playback mode, move cursor to Edit mode function and press OK. After Edit mode is selected, move cursor to selected songs list and select the songs which you want to delete; press OK and a check mark will appear to the left of the selected song, move cursor to clear program and press OK, the selected songs will be deleted and disappear on the play list.

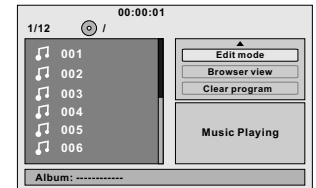

Notice: Edit mode, Browser view or Clear program functions are relationship related when delete the selected song at the songs list.

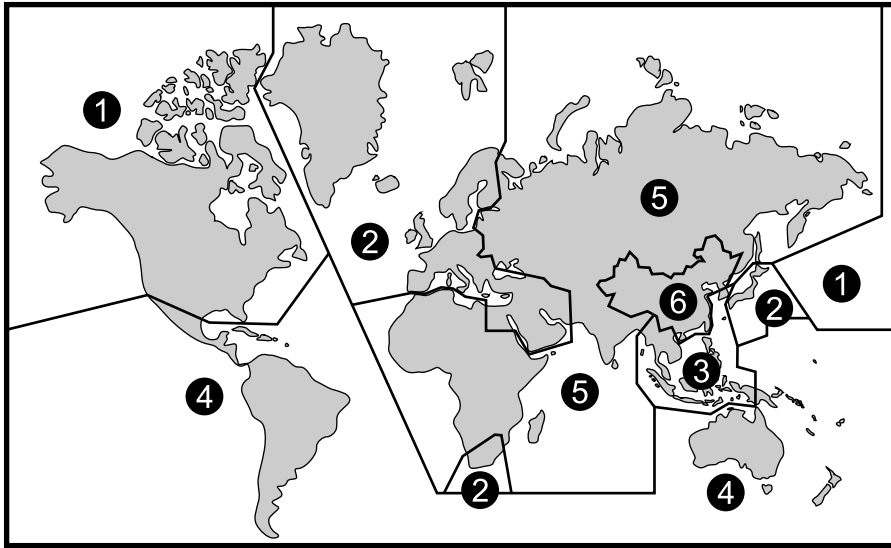

Region 1- USA, Canada

Region 2- Japan, Europe, South Africa, Middle East, Greenland

Region 3- S. Korea, Taiwan, Hong Kong, Parts of South East Asia

Region 4- Australia, New Zealand, Latin America (including Mexico)

Region 5- Eastern Europe, Russia, India, Africa

Region 6- China

DVD Area Code

The DVD player is preset to a region code at the factory depending on where the DVD player is sold. DVDs from a different regions cannot be played in this unit and the unit will display “DISC REGION INCORRECT”.

DVD Basics

To get the optimum use out of the DVD section, make sure you read this section completely.

Types of Discs your DVD will play

- DVD* disc - DVD discs which contain video.
 - Audio discs - Audio CDs contain musical or sound content only.
 - MP3 discs - A disc that contains audio files (for example, a CD-R with downloaded MP3 files).
- * This system is capable of playing most recordable DVD formats. However, due to the variety of disc manufacturers and software, playback cannot be guaranteed.

Loading and Playing Discs

Before you load a disc, make sure that it is compatible with the player. Insert the disc with the label facing the driver.

Note: *the following Discs **CANNOT** be used with this player :*

- *MiniDisc*
- *Laserdisc*
- *CD-1, CD-ROM, DVD-ROM, Super Audio CD (SACD), DVD Audio, JPEG (KODAK)*

To load and Play a Disc

Press the Power button to turn the unit ON. Select DVD mode and insert the disc (Label facing ceiling) into the disc compartment.

TURNING THE UNIT ON OR OFF

1. Pushing in the Screen Release button will unlock the LCD screen and it will drop down slightly. Pivot the screen downward until a comfortable viewing angle is reached. The hinge friction will hold the screen in position while the system is in use.
2. Touching the power button* on the unit or the remote control will turn the system on and off. When in use the internal backlighting will illuminate the controls on the unit.
3. After the unit has been turned on and is displaying a picture, adjust the viewing angle, by pivoting the screen to optimize the picture quality.
4. Remember to turn the unit off and pivot the LCD to the locked position when not in use.

***Note:** *Unit will turn On automatically when a Disc is inserted*

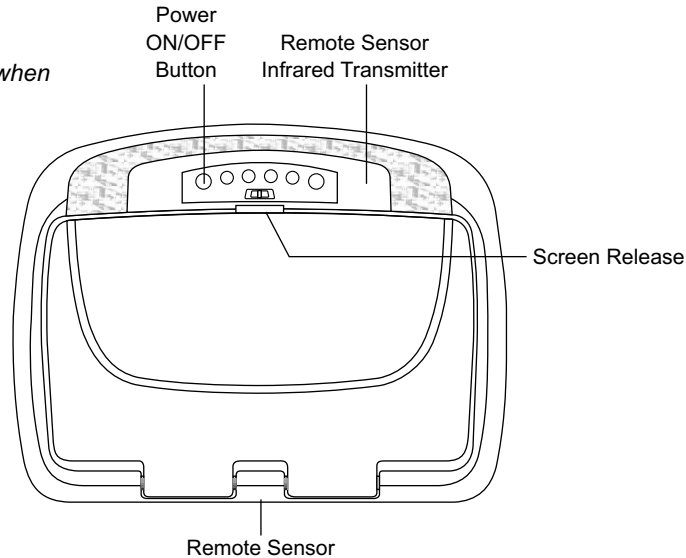

OVERHEAD DOME LIGHTS

The Dome Lights integrated into the VOD128A are controlled by a three position slide switch. Sliding the switch to the ON position will turn the lights ON. The OFF position will prevent the lights from turning ON with the vehicle's interior lighting, and the auto position will allow the lights to turn ON and OFF with the vehicle's interior lighting. Refer to the Installation Guide for wire connections. Do not leave the vehicle unattended with the dome light switch in the ON position, as this could result in a discharged battery.

REMOTE SENSOR

The VOD128A incorporates two infrared remote sensors to relay signals to the unit when the remote control is pointed at the remote

ACCESSORIES

WIRELESS HEADPHONES

The VOD128A includes a built-in infrared transmitter for use with the supplied wireless headphones. The headphone volume is adjusted using the controls on each headset. Any number of wireless headphones may be used but they must be used within a line of sight from the transmitter, as infrared transmissions, like visible light travel only in a straight line. See the documentation accompanying your wireless headphones.

Note: *If the monitor is set to M2 mode, the headphones supplied with this unit will not work, as these headphones are single channel. Only two-channel wireless headphones (Audiovox Model IR2CHS) will work with this unit when set to M2 mode. The only time it is necessary to set this unit to M2 mode is if there is an RSA (Rear Seat Audio) installed in the vehicle or if two of these monitors are installed in one vehicle.*

WIRED HEADPHONES (OPTIONAL)

There is one 1/8" headphone jack on the VOD128A that can be used with any standard wired stereo headphones with a 1/8" plug. This jack is controlled by the volume up/down buttons on the VOD128A remote control or the +/- keys located on the unit.

SOURCE FEATURE*

VIDEO 1

The VIDEO 1 input may be connected to a Video Cassette Player (VCP), video game system, or other audio / video devices. To access the A/V inputs, turn the VOD128A on and press the S (source) button on the VOD128A or the Source button on the remote control until "VIDEO 1" is displayed on the screen. Turn the video source component on with its power button or remote control. The VOD128A is now ready to play the audio and video signals from the source connected to VIDEO 1 input (optional accessory cable part number 8010730 required).

VIDEO 2

The VIDEO 2 input may be connected to a Video Cassette Player (VCP), Video game system, any other audio / video device. To access the A/V inputs, turn the VOD128A on and press the S (source) button on the VOD128A or the source button on the remote control until VIDEO 2 is displayed on the screen.

VIDEO 3 (SMART PORT)

The VOD128A will accept audio / video input through the Smart port located on the rear of the unit. The audio / video device could be a video game system, video camera, or other input device.

Notes: The AUX/Game input is a shared input 30-pin connector (Priority AUX); when an AUX input is connected, it will automatically disable the game input.

Video Out

The VOD128A provides a video output for optional video monitor(s). This output will provide a video signal that duplicates the signal displayed by the VOD128A to an additional monitor or video display. Please see your installer for more information.

***Note:** VIDEO 1 and VIDEO 2 sources are available only if pre-installed during your video product installation.

USING THE WIRELESS GAME CONTROLLER

The Game Controller transmits to the VOD128A with two infrared transmitters located on the front of the Game Controller.

The Game Controller must be pointed toward the VOD128A for correct operation.

Press the source button on the remote control or the unit until AUX/GAME* is displayed.

GAME CONTROLLER FUNCTIONAL DESCRIPTION

1. Install two AAA batteries in the Game Controller. Observe the correct polarity.
2. Use the ON/OFF selector switch to turn on the Game Controller. A list of ten games will be displayed.
3. Use the A button (page up) or B button (page down) to display the three pages of games (1-10, 11-20, 21-30). Then use the direction buttons to move the arrow to the desired game. Press Start to select the game.
4. Press Start to begin the game. Press Start again at any time to pause the game.
5. Press RESET to return to the game list.
6. Use the ON/OFF selector switch to turn off the Game Controller after use.

***Note:** The AUX/GAME input is a shared input. For game operation remove all plugs from the AUX input.

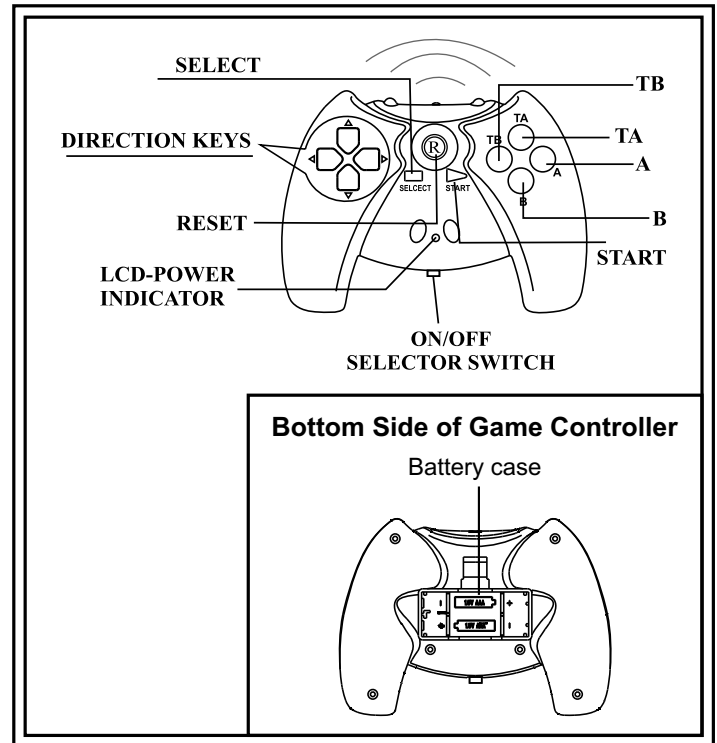

TROUBLESHOOTING

PROBLEM	SOLUTION
IR remote inoperative	<ul style="list-style-type: none">• Verify that the batteries in the remote are fresh.• Verify that the remote sensor eye is not obstructed.• If monitor is set to M1, press M1 button on remote; If monitor is set to M2, press M2 on remote.
Disc won't play	<ul style="list-style-type: none">• Insert a disc with the label side facing up.• Check the type of disc you put into disc tray. This DVD only plays DVDs, audio CDs and MP3s.• Both the unit and the disc are coded by region. If the regional codes don't match, the disc can't be played. This DVD player is set to Region Number 1.
Play starts, but then stops immediately	<ul style="list-style-type: none">• The disc is dirty. Clean it.• Condensation has formed. Allow player to dry out.
No sound or distorted sound	<ul style="list-style-type: none">• Make sure your DVD is connected properly. Make sure all cables are securely inserted into the appropriate jacks.• If you are using the 2-channel IR headphones, make sure you turn on the IR headphone power, make sure the correct channel (A-B) is selected.• Make sure the Modulator is ON and the proper Frequency has been selected.• Make sure that unit is set to M1 when using Single Channel Headphones.
Can't advance through a movie	<ul style="list-style-type: none">• You can't advance through the opening credits and warning information that appears at the beginning of movies because the disc is programmed to prohibit that action.

PROBLEM	SOLUTION
⊘ Not allowed at the moment	<ul style="list-style-type: none"> • The feature or action cannot be completed at this time because: <ol style="list-style-type: none"> 1. The disc's software restricts it. 2. The disc's software doesn't support the feature (e.g., angles) 3. The feature is not available at the moment. 4. You've requested a title or chapter number that is out of range.
Picture is distorted	<ul style="list-style-type: none"> • The disc might be damaged. Try another disc. • It is normal for some distortion to appear during forward or reverse scan.
No forward or reverse scan	<ul style="list-style-type: none"> • Some discs have sections that prohibit rapid scanning or title and chapter skip. • If you try to skip through the warning information and credits at the beginning of a movie, you won't be able to. This part of the movie is often programmed to prohibit skipping through it.

REPLACEMENT PARTS

SPECIFICATIONS

Remote Control

136-4427

LCD Backlighting

Edge Light Tube

Resolution

1280 x 800

Pixels

1280 RGB x 800

Operation Temperature

32 ~131° F (0 ~ 55° C)

Storage Temperature

-4 ~ 158° F (-20 ~ 70° C)

Backlit life

30,000 Hours

Video Display System

NTSC / PAL

Headphone Audio Output

0.03W @ 32 ohms

Video Output

1.0Vp-p @ 75 ohms

Power Source

12V DC

Dimension

L x W x H

14.0" x 12.0" x 2.0"

356mm x 305mm x 51mm

Specifications subject to change without notice.



12 MONTH LIMITED WARRANTY

Applies to Audiovox Mobile Video Products

AUDIOVOX ELECTRONICS CORP. (the Company) warrants to the original retail purchaser of this product that should this product or any part thereof, under normal use and conditions, be proven defective in material or workmanship within 12 months from the date of original purchase, such defect(s) will be repaired or replaced with reconditioned product (at the Company's option) without charge for parts and repair labor. A game controller, if supplied, is similarly warranted for ninety (90) days.

To obtain repair or replacement within the terms of this Warranty, the product is to be delivered with proof of warranty coverage (e.g. dated bill of sale), specification of defect(s), transportation prepaid, to the Company at the address shown below.

This Warranty does not extend to the elimination of externally generated static or noise, to correction of antenna problems, to costs incurred for installation, removal or reinstallation of the product, or to damage to digital memory/media devices, gaming devices, discs, speakers, accessories, or vehicle electrical systems.

This Warranty does not apply to any product or part thereof which, in the opinion of the Company, has suffered or been damaged through alteration, improper installation, mishandling, misuse, neglect, accident, or by removal or defacement of the factory serial number/bar code label(s). THE EXTENT OF THE COMPANY'S LIABILITY UNDER THIS WARRANTY IS LIMITED TO THE REPAIR OR REPLACEMENT PROVIDED ABOVE AND, IN NO EVENT, SHALL THE COMPANY'S LIABILITY EXCEED THE PURCHASE PRICE PAID BY PURCHASER FOR THE PRODUCT.

This Warranty is in lieu of all other express warranties or liabilities. ANY IMPLIED WARRANTIES, INCLUDING ANY IMPLIED WARRANTY OF MERCHANTABILITY, SHALL BE LIMITED TO THE DURATION OF THIS WRITTEN WARRANTY. ANY ACTION FOR BREACH OF ANY WARRANTY HEREUNDER INCLUDING ANY IMPLIED WARRANTY OF MERCHANTABILITY MUST BE BROUGHT WITHIN A PERIOD OF 24 MONTHS FROM DATE OF ORIGINAL PURCHASE. IN NO CASE SHALL THE COMPANY BE LIABLE FOR ANY CONSEQUENTIAL OR INCIDENTAL DAMAGES FOR BREACH OF THIS OR ANY OTHER WARRANTY. No person or representative is authorized to assume for the Company any liability other than expressed herein in connection with the sale of this product.

Some states do not allow limitations on how long an implied warranty lasts or the exclusion or limitation of incidental or consequential damage so the above limitations or exclusions may not apply to you. This Warranty gives you specific legal rights and you may also have other rights which vary from state to state.

Audiovox Electronics Corporation, 150 Marcus Blvd., Hauppauge, New York 11788 | 1-800-645-4994

© 2007 Audiovox Electronics Corporation

128-5495F



For Customer Service
Visit Our Website At

www.audiovox.com

Product Information, Photos,
FAQ's Owner's Manuals

Free Manuals Download Website

<http://myh66.com>

<http://usermanuals.us>

<http://www.somanuals.com>

<http://www.4manuals.cc>

<http://www.manual-lib.com>

<http://www.404manual.com>

<http://www.luxmanual.com>

<http://aubethermostatmanual.com>

Golf course search by state

<http://golfingnear.com>

Email search by domain

<http://emailbydomain.com>

Auto manuals search

<http://auto.somanuals.com>

TV manuals search

<http://tv.somanuals.com>