



CDM-4000 CDM-4000 XL

DUAL MODE DIGITAL CDMA TELEPHONE



OWNER'S OPERATING MANUAL



AUDIOVOX™
COMMUNICATIONS CORP.

555 Wireless Blvd., Hauppauge, NY 11788 • 516-233-3300 • <http://www.audiovox.com>

©1999 Audiovox Communications Corporation • Printed in Japan • 10/99



AUDIOVOX™
COMMUNICATIONS CORP.

TABLE OF CONTENTS

SAFETY INFORMATION FOR WIRELESS HANDHELD PHONES	6
PRECAUTIONS	9
SYSTEM CONFIGURATION	10
WRIST STRAP ATTACHMENT	11
BATTERY INSTALLATION AND RECHARGING	12
To Attach the Battery Pack	12
To Detach the Battery Pack	12
To Recharge Battery	12
FUNCTIONS	14
External View	14
Function of Keys	15
LCD Display Indication	15
GETTING STARTED	16
Turning the Phone On/Off	16
Antenna Position	16
Receiving Signal Strength Indicator ()	16
Battery Level Indicator	16
Power Management	16
BASIC OPERATION	17
Placing Calls	17
To Place a Call	17
To Terminate a Call	17
Last Number Redial	17
To Dial the Last Number Received	17
Phonebook Dialing	17
To mute a Phone Conversation	17
Speed Dialing	18
Quick Dialing	18
Emergency Call	18
OneTouch Emergency Call	19
Receiving Calls	19
To Receive a Call	19
Any Key Answering	19
Caller ID with Name	19
Automatic Calls-in-Absence Indicator	20
Ringing Tone with Melody	20
Distinctive Ringing (Audible Caller ID)	20
During Calls	20
To Adjust the Earpiece Volume	20
Scratch Pad Dialing	20
To Send Touch Tone™ Signals	20
Automatic Talk Timer	21
Call Waiting	21
Three-Way Calling	21
Standby	21
Clock Indicator (Digital Mode Only)	21
End to End Signaling	22
Touch Tone™ from Display	22
Touch Tone™ from Memory	22

PHONEBOOK OPERATION	23
Phonebook Entry	23
To Store a Number without Name	23
Overwrite Warning	24
Auto Hyphenation	24
Manual Hyphenation	25
Automatic Storing into Phonebook	25
To Store Dual Numbers in Phonebook	26
To Store a Name with the Phone Number	27
Alpha Mode	27
To Store a Ring Type with the Phone Number	29
Recall Menu	30
Recall Menu Tree	30
Phonebook Recall	31
Phonebook Address Mode	31
Phonebook Sort Scroll Mode	31
Phonebook Key Word Search Mode	32
To Dial Dual Numbers	33
To Review Long Numbers	33
To Review Long Names	33
Prepending Dialing	33
Phonebook Edit	34
To Modify Numbers and Names	34
To Move Numbers and Names	35
To Change Priority of Dual Numbers	36
To Erase Numbers and Names	36
Secret Memory	37
To Store a Secret Number	37
To Recall a Secret Number	37
Link Dialing	38
To Store Linked Numbers in Phonebook	38
To Place Calls using Linked Numbers	39
Call History	40
To Review Outgoing Call History	40
To Review Incoming Call History	41
To Review Scratch Pad	41
To Save a Number to Phonebook	42
MESSAGING FEATURES	43
Voice Mail	43
Voice Mail Notification	43
To Display the Number of Voice Mail Messages	44
Voice Mail Dialing	44
Text Messages (Short Message Service)	45
To Review a Text Message	46
FUNCTION MENU	47
To Access Function Menu	47
Function Menu Tree	48
Lock Features	49
Security Code and Unlock Code	49
Keypad Lock (F11)	49
Phone Lock (F12)	50
Automatic Phone Lock (F13)	50
To Unlock the Phone	50
To Change the Unlock Code (F14)	50
Display Features	51
Own Telephone Number Display (F21)	51
Backlight Control (Standby) (F22-1)	51
Backlight Control (In-Use) (F22-2)	52
Auto Hyphenation (F23)	52
SMS Text Lines Selection (F24)	52
Contrast Control (F25)	52
Software Version Review (F26)	53
Last Rescan SID Indicator (F27)	53
PRL ID Review (F28)	53

Volume and Tone Controls	54
Alert Tone Volume Control (F31)	54
Ring Type Selection (F32)	54
Key Tone Volume Control (F33)	54
To Mute a Phone Conversation (F34)	55
Sending DTMF (F35)	55
Setting Tones (F36)	55
Key Tone Length (F36-1)	55
Single Alert Beep Tone (F36-2)	56
Voice Mail Alert (F36-3)	56
Text Message Alert (F36-4)	56
Caller ID Alert (F36-5)	56
Service Mode Alert (F36-6)	57
Voice Privacy Alert (F36-7)	57
One Minute Beep Tone (F36-8)	57
Low Battery Alarm (F36-9)	57
Call Timers	58
Last Call Timer (F41-1)	58
Outgoing Call Timer (F41-2)	58
All Calls Timer (F41-3)	58
Lifetime Timer (F41-4)	58
Clock Indicator (F42)	58
System Features	59
A/B System Selection (F51)	59
Enhanced Roaming	59
NAM Selection (F52)	60
Force Analog Call (F53)	60
System Settings (F54)	61
NAM Name Display (F54-1)	61
Automatic NAM (F54-2)	61
Automatic Retry (F54-3)	61
Enhanced Voice Privacy Service (F54-4)	62
Anti Fraud Security Features	62
To Place a Call with the Manual PIN Entry	63
To Place a Call with the Automatic PIN Feature	63
To Place a Call to Voice Mail using the Automatic PIN Feature	63
To Turn the Automatic PIN Feature On/Off (F54-5)	63
To Program or Change your Automatic PIN (F54-6)	64
Security Features	64
Call Restriction (F61)	64
To Change Emergency Numbers (F62)	65
To Turn On/Off OneTouch Emergency Call Feature (F63)	65
To Change the Security Code (F64)	65
Reset Functions (F65)	66
Call Timer Reset (F65-1)	66
Phonebook All Clear (F65-2)	66
Call History All Clear (F65-3)	66
Text Message & Voice Mail All Clear (F65-4)	67
Function Reset (F65-5)	67
Other Functions	67
Quick Dialing (F01)	67
Automatic Answering (F02)	67
Function Reset Status	68
INDEX	71
WARNING	72
12 MONTH LIMITED WARRANTY	73
Quick Reference	75
ACCESSORIES	77

Touch Tone™ is a registered trade mark of AT & T.

AUDIOVOX
CDM-4000/CDM-4000XL

**Dual Mode CDMA/AMPS
Handheld Portable
Cellular Telephone**

Congratulations... You have just purchased one of the most advanced cellular telephones in the market today. Your new Audiovox portable telephone is a dual mode cellular telephone operating in both the standard analog and the CDMA "digital" modes.

CDMA technology is a superior digital technology that greatly increases the quality and capacity of the cellular system and will provide you with enhanced features and services. Among the many additional benefits your new Audiovox portable phone will provide while operating in the digital mode are, superior voice quality, increased talk and standby times and enhanced privacy. Your new Audiovox dual mode cellular telephone combines all the advantages of CDMA digital technology along with Audiovox innovative engineering into a small, attractive unit that is very easy to use.

The Audiovox CDM-4000/CDM-4000XL is packed with advanced features that provide you with the ultimate in convenience and performance such as a full dot matrix LCD display, 99 dual-number alpha numeric memory locations, a user friendly multi-function key, as well as a one touch voice mail access key.

Other feature highlights include one touch emergency dialing, caller ID with name display, 10 number storage each for incoming and outgoing calls, text messaging and voice mail notification.

Optional accessories include an extended lithium ion battery, a hands free car kit, a cigarette lighter charger and an earphone/microphone. A leather carrying case is also available.

And of course, your new Audiovox Dual Mode cellular telephone comes with something only an Audiovox phone can provide. The proven reliability that has made Audiovox one of the world's leading suppliers of cellular communications equipment.

Please take a few moments to read the following pages of this user's operation manual. It will help you make the most efficient use of this valuable communications tool.

SAFETY INFORMATION FOR WIRELESS HANDHELD PHONES

Read this information before using your handheld portable Cellular Telephone.

EXPOSURE TO RADIO FREQUENCY SIGNALS

Your wireless handheld portable telephone is a low power radio transmitter and receiver. When it is ON, it receives and also sends out radio frequency (RF) signals.

In August, 1996, the Federal Communications Commission (FCC) adopted RF exposure guidelines with safety levels for handheld wireless phones. Those guidelines are consistent with the safety standards previously set by both U.S. and international standards bodies:

- *ANSI C95.1 (1992)
- *NCRP Report 88 (1986)
- *ICNIRP (1996)

Those standards were based on comprehensive and periodic evaluations of the relevant scientific literature. For example, over 120 scientists, engineers, and physicians from universities, government health agencies, and industry reviewed the available body of research to develop the ANSI Standard (C95.1). The design of your phone complies with the FCC guidelines (and those standards).

ANTENNA CARE

Use only the supplied or an approved replacement antenna. Unauthorized antennas, modifications, or attachments could damage the phone and may violate FCC regulations.

PHONE OPERATION

Normal Position: Hold the phone as you would any other telephone with the antenna pointed up and over your shoulder.

*The meanings of the acronyms are:

- ANSI** : American National Standards Institute
- NCRP** : National Council on Radiation Protection and Measurements
- ICNIRP**: International Commission on Nonionizing Radiation Protection

Tips on Efficient Operation:

For your phone to operate most efficiently:

- Extend your antenna fully.
- Do not touch the antenna unnecessarily when the phone is in use. Contact with the antenna affects call quality and may cause the phone to operate at a higher power level than otherwise needed.

DRIVING

Check the laws and regulations on the use of wireless telephones in the areas where you drive. Always obey them. Also, if using your phone while driving, please:

- Give full attention to driving — driving safely is your first responsibility.
- Use handsfree operation, if available.
- Pull off the road and park before making or answering a call if driving conditions so require.

ELECTRONIC DEVICES

Most modern electronic equipment is shielded from RF signals. However, certain electronic equipment may not be shielded against the RF signals from your wireless phone.

Pacemakers

The health Industry Manufacturers Association recommends that a minimum separation of six (6") inches be maintained between a handheld wireless phone and a pacemaker to avoid potential interference with the pacemaker. These recommendations are consistent with the independent research by and recommendations of Wireless Technology Research.

Persons with pacemakers:

- Should ALWAYS keep the phone more than six (6") inches from their pacemaker when the phone is turned ON.
- Should not carry the phone in a breast pocket.
- Should use the ear opposite the pacemaker to minimize the potential for interference.
- If you have any reason to suspect that interference is taking place, turn your phone OFF immediately.

Hearing Aids

Some digital wireless phones may interfere with some hearing aids. In the event of such interference, you may want to consult your service provider [or call the customer service line to discuss alternatives.]

Other Medical Devices

If you use any other personal medical device, consult the manufacturer of your device to determine if they are adequately shielded from external RF energy. Your physician may be able to assist you in obtaining this information.

Vehicles

RF signals may affect improperly installed or inadequately shielded electronic systems in motor vehicles. Check with the manufacturer or its representative regarding your vehicle. You should also consult the manufacturer of any equipment that has been added to your vehicle.

Posted Facilities

Turn your phone OFF in any facility where posted notices so require.

AIRCRAFT

FCC regulations prohibit using your phone while in the air. Switch OFF your phone before boarding an aircraft.

BLASTING AREAS

To avoid interfering with blasting operations, turn your phone OFF when in a "Blasting area" or in areas posted "Turn off two-way radio". Obey all signs and instructions.

POTENTIALLY EXPLOSIVE ATMOSPHERES

Turn your phone OFF when in any area with a potentially explosive atmosphere and obey all signs and instructions. Sparks in such areas could cause an explosion or fire resulting in bodily injury or even death.

Areas with a potentially explosive atmosphere are often but not always clearly marked. They include fueling areas such as gasoline stations, below deck on boats, fuel or chemical transfer or storage vehicles using liquefied petroleum gas (such as propane or butane), areas where the air contains chemicals or particles, such as: grain, dust, or metal powders, and any other area where you would normally be advised to turn off your vehicle engine.

For Vehicles Equipped with an Air Bag

An air bag inflates with great force. DO NOT place objects, including both installed or portable wireless equipment, in the area over the air bag or in the air bag deployment area. If in-vehicle wireless equipment is improperly installed and the air bag inflates, serious injury could result.

PRECAUTIONS

Your Handheld Portable Telephone is a high quality piece of equipment. Before operating the equipment, read all instructions and cautionary markings on (1) AC Adapter, (2) Battery and (3) Product using Battery.

- 1. DO NOT use this equipment in an extreme environment where high temperature or high humidity exists.**
- 2. DO NOT abuse the equipment. Avoid striking, shaking or shocking. When not using the unit, lay down the unit to avoid possible damage due to instability.**
- 3. DO NOT expose this equipment to rain or spilled beverages.**
- 4. DO NOT use unauthorized accessories.**
- 5. DO NOT disassemble the phone or its accessories; If service or repair is required, return the unit to an authorized Audiovox cellular service center. If the unit is disassembled, the risk of electric shock or fire may result.**
- 6. To prevent injury or burns, DO NOT allow metal objects to contact or short circuit the battery terminals.**
- 7. DO NOT open the battery case. If the battery is accidentally broken, avoid skin contact with the internal chemical contents. If there is skin contact, wash the affected area immediately and seek medical advice.**
- 8. DO NOT put the battery close to, nor dispose it into fire.**
- 9. The product that you have purchased contains a rechargeable Battery. At the end of its useful life, under various state and local laws, it may be illegal to dispose of this Battery into the municipal waste stream. Check with your local solid waste officials for proper disposal procedures in your area.**

SYSTEM CONFIGURATION

System configuration and the equipment list are as shown below.

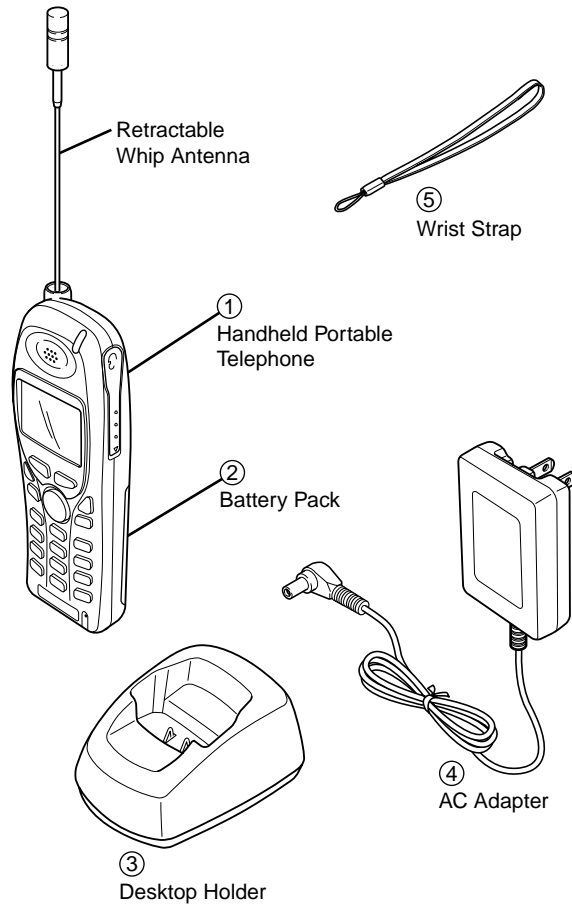

List of Equipment

No.	Name of the Equipment
①	Handheld Portable Telephone
②	Slim Lithium Ion Battery Pack (BTR-4000)
③	Desktop Holder (DTH-4000)
④	AC Adapter (CNR-4000)
⑤	Wrist Strap

WRIST STRAP ATTACHMENT

Attach the wrist strap to the phone through the strap hole as shown below ① .

Then put the long loop through the smaller loop as shown below ② .

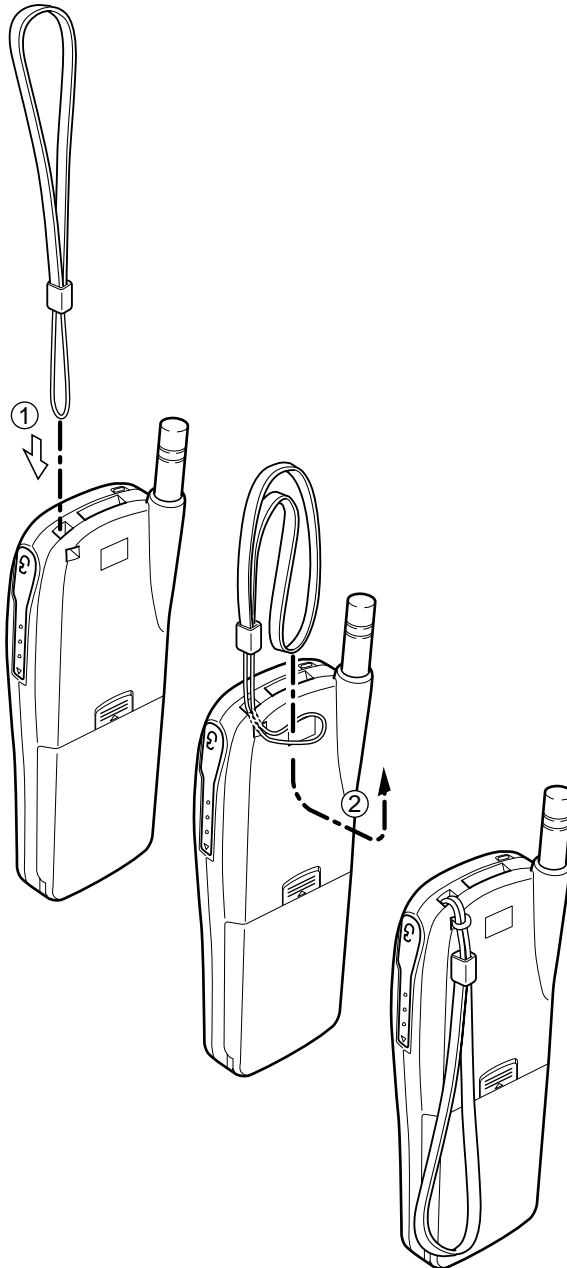

BATTERY INSTALLATION AND RECHARGING

To Attach the Battery Pack

- ① Insert the hook at the end of the Battery Pack into the slot at the end of the phone.
- ② Press the Battery Pack down to lock the Battery Pack onto the phone.

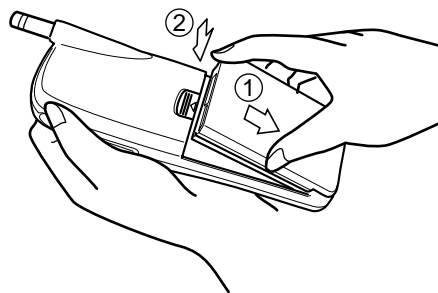

To Detach the Battery Pack

- ① Slide back the Release Latch as shown below.
- ② Lift up to remove the Battery Pack from the phone gently.

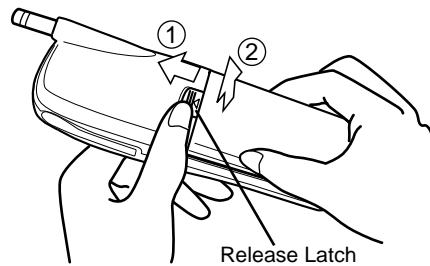

To Recharge Battery

Your CDM-4000 has a built-in charger function. To recharge the Battery Pack, always install the Battery Pack to the Phone.

1. Attach the Battery Pack to the Phone.
2. Insert the DC plug of the AC Adapter (CNR-4000) to the Desktop Holder (DTH-4000). Plug the AC Adapter to AC outlet.
3. Place the Phone with Battery Pack into the Desktop Holder.

4. Then the recharging starts. The display indicates “**now charging**” with animation. You can see a battery level indicator scrolling at the upper-right of the display.



5. For complete recharging, it is recommended that the phone is turned off during recharging.
6. When the recharging is completed, the display indicates “**fully charged**”.
7. It is normal that Battery Pack may become a little warmer during recharging.

The recharging time, from empty to full, depends on the environmental temperature, 0 to +35°C.

Battery Type	Recharging Time
Slim Lithium Ion (BTR-4000)	1.5 to 2 h
Extended Lithium Ion (BTE-4000)	2.5 to 3.5 h

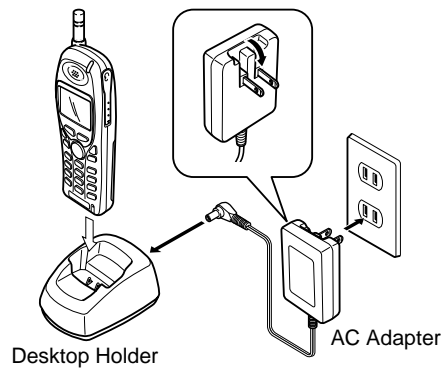

Alternatively you can recharge the Phone using AC Adapter as illustrated below.

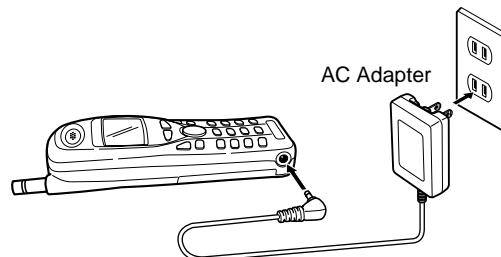

Note: Do not feed the power to the Phone without Battery Pack.

FUNCTIONS

External View

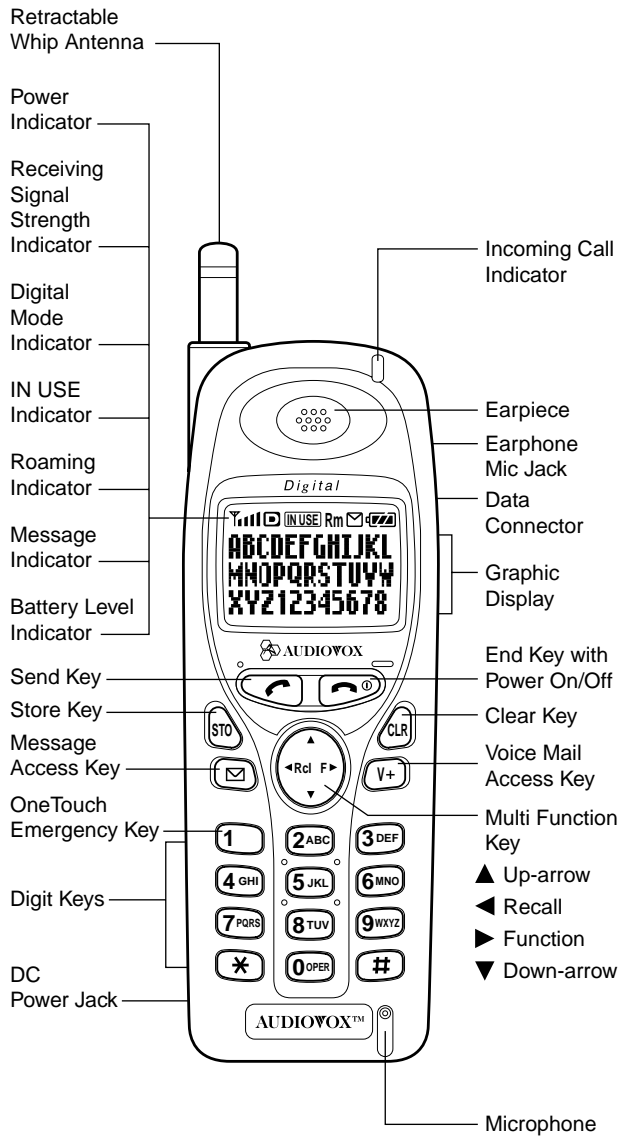

Function of Keys



Key- Board Arrangement	Digit Keys <p>To enter Telephone Numbers, Names or special characters (* or #). 1 is also used for OneTouch Emergency feature.</p>	
	Function Keys 	
		SEND key. To originate or receive a Call.
		END key. To terminate a Call and to turn the phone ON/OFF.
		To recall phone numbers from memory. Also used as Left-arrow key.
		To be used with other keys to activate various special features. Also used as Right-arrow key.
		To control Earpiece audio level, Alert Tone and Key Tone.
		Also used as Up/Down-arrow keys.
		To store phone numbers in memory.
		To clear digits from the display or from a memory location.
	To review Text Messages or to learn how many Voice Messages are in your Voice Mailbox.	
	To access your Voice Mail with only one key.	

LCD Display Indication

Items	Descriptions
	Receiving Signal Strength Indicator. The number of lines indicates the received Signal Strength, and Υ is also used as a POWER ON Indicator.
	Digital Mode Indicator. To indicate the phone is operating in digital mode.
	A Call is in progress.
	The phone is out of the Home-Area.
	Message Indicator. To indicate that Text Messages are stored in memory or Voice Messages are in your Voice Mailbox.
	Battery Level Indicator. Monitors the battery charge condition.
	Graphic full-dot matrix display with flexible font size in 2 to 4 lines.

GETTING STARTED

Turning the Phone On/Off

Press  for more than one second. All the indicators and the digit display will light momentarily, and a tone will be heard. The indicator  will stay while the phone is turned on.

To turn the phone off, press  for more than one second.

Antenna Position



The antenna can be used in its fully extended or fully retracted position only. It is recommended that the antenna should be fully extended for optimum performance and signal strength or while operating in poor signal areas.

Receiving Signal Strength Indicator ()

The number of lines indicates the Signal Strength in your area. Four lines show the maximum level. The display will vary as you move with the phone. If the signal is not strong enough to place a call, “No Service” will appear on the LCD display.

Battery Level Indicator

You can always monitor the battery charge condition with the constant battery level indicator. The number of blocks indicates the battery conditions as follows:

-  Full charge
-  Low charge
-  Flashing indicates discharged.

Power Management

Battery	Mode	Talk Time up to	Standby Time up to
Slim Battery (BTR-4000)	CDMA	190 min.	170 h
	Analog	65 min.	12 h
Extended (BTE-4000)	CDMA	380 min.	340 h
	Analog	130 min.	24 h

The operating times are approximate values and may vary depending on network configuration and handset usage.

BASIC OPERATION

Placing Calls

To Place a Call

1. Enter the phone number.
(A maximum of 32 digits will be displayed.)

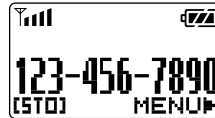

2. Press .
The **IN USE** indicator will light.

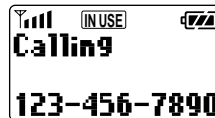

- **To Correct a Number**

Press to clear the last digit.

Press and hold to erase all the digits entered.

- **If the Call Fails to Go Through**

Press and to redial the number.

To Terminate a Call

Press . The **IN USE** indicator will go out.

Last Number Redial

Press to recall the last number you dialed, then press .

See **Call History** on page 40 for details.

To Dial the Last Number Received

Press to dial the last number with Caller ID you received, then press .

See **Call History** on page 40 for details.

Phonebook Dialing

Press and enter an address (01 to 99) to recall a number from your phonebook, then press .

See **Phonebook Recall** on page 31 for details.

To Mute a Phone Conversation

Press to mute your conversation at any time during a call. "Mute" will be displayed.

To return to normal conversation, press again.

Speed Dialing



If you know the phonebook address of the telephone number that you want to call, you may place a call without using .

1. Enter the one or two digits of your Phonebook address (1 ~ 9 or 10 ~ 99).
2. Press . The phone number will be displayed. The **IN USE** indicator will light, and the call will be placed.

Note: If two telephone numbers are stored in the address, the Primary Number will be dialed.

Quick Dialing

When this feature is on, the Primary number in your Phonebook address 02 to 09 can be dialed with just one push of the key. See **Quick Dialing (F01)** on page 67 to turn this feature on/off.





1. Press a digit key ( to ) for more than one second.
2. The number in your phonebook is automatically dialed. The phone number will be displayed. The **IN USE** indicator will light.

Note: The key  is not for Quick Dialing, but for **One Touch Emergency Call**, page 19.

Emergency Call

This feature permits you to place an emergency call even if your telephone is in “**Phone Lock**”, “**Keypad Lock**” or “**Restrict**” mode. Up to 3 numbers can be programmed as Emergency numbers. The emergency numbers “**911**” and “***911**” are already preprogrammed. See **To Change Emergency Numbers (F62)** on page 65.

Example: To Call 911 in “**Phone Lock**” or “**Keypad Lock**” mode.

1. Enter   . The “**911**” will not be displayed, but “**Phone Lock**” or “**Keypad Lock**” will be displayed.
2. Press .
The “**911**” will be displayed.
The **IN USE** indicator will light, and the call will be placed.

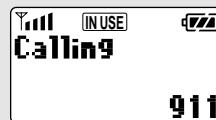

OneTouch Emergency Call

This feature permits you to dial an emergency number by a single key stroke, even in the “**Phone Lock**” or “**Restrict**” mode. This feature can be turned off to prevent unintentional calls to the emergency number.

See **To Turn On/Off OneTouch Emergency Call Feature (F63)** on page 65.

1. Press and hold  for more than 2 seconds. The number in emergency memory location “1” will be dialed.
2. Then the **INUSE** indicator will light, and the call will be placed. (The factory preset number is “911”.)



Note: This feature cannot be used if the Keypad Lock is on. You need to dial all the digits and .

Receiving Calls

To Receive a Call

When the telephone rings, press  to answer the call. The **INUSE** indicator will light.

Any Key Answering

This feature permits you to answer an incoming call by pressing any key on the key pad except  and .

Caller ID with Name

This feature allows you to preview in your display the number and name of the party calling you before you answer the call. The name is as you programmed it in your phonebook.

1. When the phone rings, the  Calling Number appears in the display.
2. The last 10 Caller IDs are stored in the memory for your review and redial. See **Call History** on page 40 for details.

Note: “**Number Restricted**” or “**Number Unavailable**” is displayed when the Caller ID is restricted or not available.

Automatic Calls-in-Absence Indicator

This feature indicates the number of unanswered incoming calls. If incoming calls are not answered, the LCD display will indicate "Called XX". "XX" is the number of calls (01 to 99) missed.

Example:

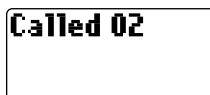

Depressing any key will clear the number of calls indicated in the display.

Ringing Tone with Melody



The CDM-4000 offers you 15 styles of ringer tones and melodies for alerting incoming calls. Ringer volume can also be adjusted. See **Ring Type Selection (F32)** and **Alert Tone Volume Control (F31)** on page 54 for setting.

Distinctive Ringing (Audible Caller ID)

You may program different ringer styles for different phonebook addresses. See **To Store a Ring Type with the Phone Number** on page 29 for setting.

During Calls

To Adjust the Earpiece Volume

Simply press  or  to adjust Earpiece Volume during a call.







Scratch Pad Dialing

If you enter a telephone number during a call, the number will be stored in the Scratch Pad memory. After terminating the call, the number you entered can be dialed by .

Note: You can deactivate "Sending DTMF" so that keypad tones will not be transmitted to the calling party. See **Sending DTMF (F35)** on page 55.

To Send Touch Tone™ Signals

When **Sending DTMF** (page 55) mode is on, the numbers will be sent in TouchTone™ signals during a call as you press digit keys,  through  WXYZ,  OPER,  and .

For more information, see **End to End Signaling** on page 22.

Automatic Talk Timer



The talk time of the current call will be automatically displayed.

Example:





Call Waiting

Your service provider may provide Call Waiting service. When you are on a call, you may hear beep tone alerting you of another incoming call. Your phone displays “**New Caller**” and the new caller’s ID with the name. The name is as you programmed it in your phonebook.

1. Press  to answer the new call.
2. Press  again to switch between the two calls.

Three-Way Calling

Your service provider may provide Three-Way Calling service. When a call is already in progress, you may call the third party.

1. Enter a number and press  to call the third party.
2. Press  again to connect all three parties.

Ask your service provider for the detailed information.

Standby

Clock Indicator (Digital Mode Only)

When the phone is in an area with digital service (Digital Mode), Date and Time are automatically displayed, if this feature is enabled. See **Clock Indicator (F42)** on page 58 to turn this feature on/off.

Example:

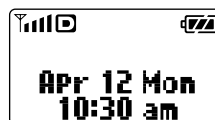

- Notes:**
1. During Digital Mode, the  indicator lights.
 2. During Analog Mode, or while “**No Service**” is indicated, the time display is not available even if this feature is enabled.

End to End Signaling

To utilize certain phone services, such as accessing an alternate long distance network, signaling a pager or banking by phone etc., Touch Tone™ signaling is required. The following features will make it easy to send frequently used Touch Tone™ signals. See **Link Dialing** on page 38 for more information.

Touch Tone™ from Display

When **Sending DTMF** (page 55) mode is on, the numbers will be sent in TouchTone™ signals during a call as you press digit keys. When **Sending DTMF** mode is off, you can send TouchTone™ signals in the following manner.

1. Enter the number.

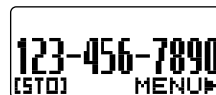

2. Press  and scroll to "TONE".





3. Press . The number in the display will be sent in Touch Tone™ signals.

Touch Tone™ from Memory

Touch Tone™ signals can be sent from memory during a call.

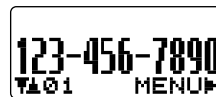
1. Press , and recall the number you want to send in Touch Tone™ signals.



2. Press  and scroll to "TONE".



3. Press . The number in the display will be sent in Touch Tone™ signals.

PHONEBOOK OPERATION





Your phone has an Enhanced Phonebook with 99 dual-number memory addresses. At each address, you can store up to two telephone numbers under one name. This feature allows you to store, under one name, a person's home and office number, office and mobile number, etc. Stored numbers can be easily recalled and dialed by pressing . Numbers can also be marked Secret for added privacy.

Number of Digits per Phonebook Address



Address	Single Number or Dual Numbers	Linked Numbers
01 to 90	Up to 32 digits	Up to 40 digits
91 to 99	Up to 32 digits	Up to 80 digits
Note	Includes Dual Mark and Manual Hyphens	Includes Link Marks and Manual Hyphens

Phonebook Entry

To program your phonebook, enter the information in the following order. You may skip "Name" and/or "Option".

 Number  Name  Option 

To Store a Number without Name

1. Press , then enter the phone number.
2. Press  , then enter the desired memory address (01 through 99).

Example: To store the phone number 1 2 3 4 5 6 7 8 9 0 in address 07.

1. Press .

2. Enter          .

3. Press  .

4. Enter  .

123-456-7890
[STO] MENU

Address: __
Auto: 04
[STO] OPTION

#07 Stored
95 Empty
4 Used

Overwrite Warning

When you attempt to store a number in an address where another number has been already stored, you will have “OVERWRITE” warning.

Example: To store the number 9 8 7 6 5 4 3 2 1 0 in the address 07, where another number 1 2 3 4 5 6 7 8 9 0 is already stored.

1. Press **CLR**.

2. Enter **9** **8** **7** **6** **5** **4** **3** **2** **1** **0**.

987-654-3210
[STO] MENU

3. Press **STO** **STO**.

Address: 07
Auto: 04
[STO] OPTION

4. Enter **0** **7**.

The already stored number is displayed momentarily.

123-456-7890
#07 USED

5. Two seconds later.

OVERWRITE
YES NO

6. If you accept to overwrite, scroll to “YES” and Press **F2**.

7. If you do not want to overwrite, scroll to “NO” and press **F2**. The screen returns to the step 3 again.

Auto Hyphenation

With this feature on, hyphens are automatically inserted when you enter telephone numbers and when you recall the numbers from the Phonebook. See **Auto Hyphenation (F23)** on page 52 to activate or deactivate this feature.

Length of Number	Display Example
10 digits or less	123-456-7890
11 to 21 digits	1-234-567-89012
22 digits or more	No hyphens

Note: When you manually insert hyphens, the “Auto Hyphenation” feature will not work for that particular number.

Manual Hyphenation

You can manually insert a hyphen at any place when you enter a telephone number. The maximum number is 32 digits long including hyphens.

Example: To insert a hyphen in the number 1 2 3 4 5 6 7 to display it as 123-4567.

1. Press **CLR**.

2. Enter **1** **2** **3**.

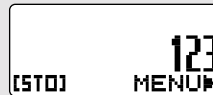

123
[STO] MENU

3. Press **F>** and scroll to "HYPHEN".



MENU
LINK MARK
DUAL MARK
HYPHEN

4. Press **F>**.

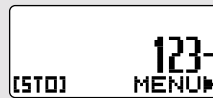

123-
[STO] MENU

5. Enter **4** **5** **6** **7**.



123-4567
[STO] MENU

Automatic Storing into Phonebook

This feature allows convenient automatic storing into a vacant phonebook address.

The number will be stored in the first available memory address which will be indicated in the display. This feature can prevent the possible overwriting of a previously stored number.

1. Enter the phone number.

2. Press **STO** **STO** **STO**.

Example: To store the phone number 1 2 3 4 5 6 7 8 9 0 into a vacant memory address 04.

1. Press **CLR**.

2. Enter **1** **2** **3** **4** **5** **6** **7** **8** **9** **0**.



123-456-7890
[STO] MENU

3. Press **STO** **STO**.



Address: 04
[STO] OPTION

4. Press **(STO)** .

#04 Stored
94 Empty
5 Used

To Store Dual Numbers in Phonebook

You can store Dual Numbers with Dual Mark “\” up to 32 digits for all the address 01 to 99 in the phonebook.

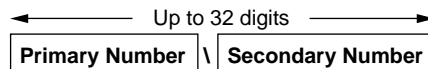

To store two telephone numbers in one phonebook address, enter the first number, select the Dual Mark “\” by using Menu, then enter the second number.

Example: To store the primary number 1 2 3 4 5 6 7 8 9 0 and the secondary number 9 8 7 6 5 4 3 2 1 0 in address 08.

1. Press **(CLR)** .

2. Enter **1** **2** **3** **4** **5** **6** **7** **8** **9** **0** .

123-456-7890
[STO] MENU▶

3. Press **(F▶)** and scroll to “DUAL MARK”.

MENU
LINK MARK
DUAL MARK ▶
HYPHEN

4. Press **(F▶)** .
The Dual Mark “\” is inserted.

1
23-456-7890\
[STO] MENU▶

5. Enter **9** **8** **7** **6** **5** **4** **3** **2** **1** **0** .

987-654-3210
[STO] MENU▶

6. Press **(STO)** **(STO)** .

Address:
Auto:05
[STO] OPTION▶

7. Enter **(OPER)** **(8 TUV)** .

#08 Stored
93 Empty
6 Used

Note: You can add a second number after storing a first number. See **To Enter a Second Number** on page 34.



To Store a Name with the Phone Number

To use this procedure, you will need to refer to “Alpha Mode” below.

1. Enter the phone number.
2. Press **(STO)** to select the Alpha Mode.
3. Enter the name.
4. Press **(STO)**, then enter the memory address (01 through 99) to store the number with the name into memory.

Example: To store the phone number 1 2 3 4 5 6 7 8 9 0 with the name Mr. JACKSON into memory address 11.

1. Enter the phone number;

2. Set Alpha Mode; **(STO)**



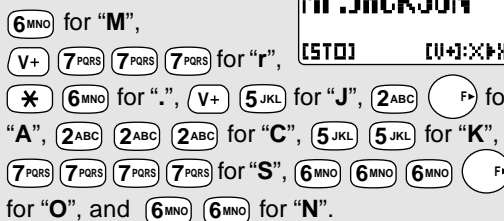
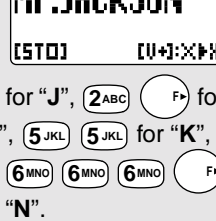

3. Enter the Name;

4. Press **(STO)**.

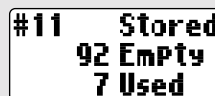

5. Enter **(1)** **(1)**.

Alpha Mode

You can add an identifying name (“Alpha Tag” up to 2 lines or 20 to 24 characters) to the phone numbers at each phonebook address.

To Enter Names using Alpha (Letters)

1. Press **(CLR)**, then enter the phone number.
2. Press **(STO)**.



- Press digit key repeatedly to display the letter that you want. The following table shows which character is assigned with each digit key. For example, to enter the letter "D", press **3_{DEF}** once. For the letter "F", press **3_{DEF}** 3 times.

Assigned Alpha Characters

Key	1 press	2 press	3 press	4 press	5 press
1	Blank	1			
2 ABC	A / a	B / b	C / c	2	
3 DEF	D / d	E / e	F / f	3	
4 GHI	G / g	H / h	I / i	4	
5 JKL	J / j	K / k	L / l	5	
6 MNO	M / m	N / n	O / o	6	
7 PQRS	P / p	Q / q	R / r	S / s	7
8 TUV	T / t	U / u	V / v	8	
9 WXYZ	W / w	X / x	Y / y	Z / z	9
0 OPER	0				

- To change from upper to lower case characters or vice versa, press **v+** during entry of Alpha.
- To enter special characters, press ***** or **#** and a digit key to select characters from the table below.

Assigned Special Characters

*					#						
1	!	2	?	3	_	1	(2)	3	:
4	+	5	-	6	.	4	<	5	>	6	&
7	*	8	/	9	=	7	"	8	'	9	#

- If you make a mistake, press **CLR** to erase the last character. Press and hold **CLR** to erase all the characters on the display.
- Press **F>** to move the cursor, which inserts a blank space after the last character.
- Press **Rcl** to move the cursor back to insert new characters.
- To exit the Alpha Mode, press **☎**.

Note: You must enter the phone number first, then add the name. Entering a number after the name will erase the name.

To Store a Ring Type with the Phone Number (Distinctive Ringing)

You can choose one of 15 ring types for each phonebook address. With this feature, you will be able to distinguish who is calling by hearing the ringing tone. The ring type is selected while storing the number when the word "OPTION" appears.

Example: To store a number with Ring Type #02 in the address 12.

1. Enter the phone number, and press **(STO)** **(STO)** .



Address: 12
Auto: 05
[STO] OPTION

2. Press **(F)** and scroll to "RING TYPE".



OPTION
RING TYPE
SECRET

3. Press **(F)** and scroll to one of the numbers, which you want to set.

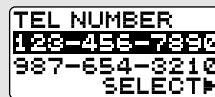

TEL NUMBER
128-456-7890
987-654-3210
SELECT

4. Press **(F)** and scroll to sample the different ring types.

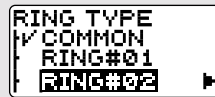

RING TYPE
COMMON
RING#01
RING#02

5. Press **(F)** to set the new ring type.



Address: 12
Auto: 05
[STO] OPTION

6. Press **(1)** **(2ABC)** .

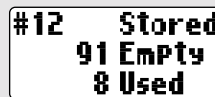

#12 Stored
91 Empty
8 Used

- Notes:**
1. If you have one number only, the step 3 is skipped.
 2. The "COMMON" shown in the step 4 is the ring type you selected with the Function Menu. See **Ring Type Selection (F32)** on page 54.

Recall Menu

Press  key. The following "RECALL" menu will prompt you to recall the number from the memory.



- "ADDRESS" : Phonebook Address Mode
- "SEARCH" : Phonebook Sort Scroll Mode or Phonebook Key Word Search Mode
- "HISTORY" : Call History Mode

Recall Menu Tree

Main Menu Sub-menu

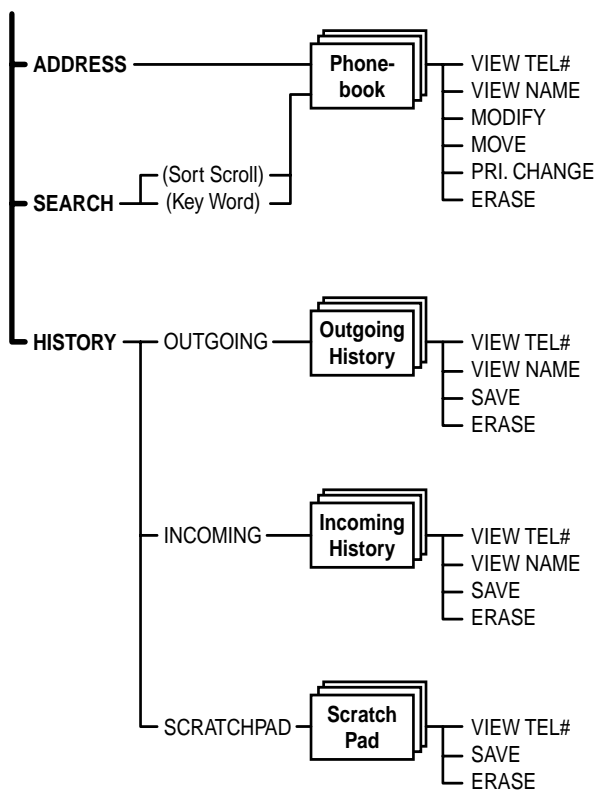



Note: The submenu "PRI.CHANGE" will be available only when two telephone numbers are stored in that address.

Phonebook Recall

To recall the numbers stored in your phonebook, you have three methods: Address Mode, Sort Scroll Mode and Key Word Search Mode.

Phonebook Address Mode

This mode is useful in finding a phone number by recalling a specific address or by scrolling the Phonebook.

1. Press .
2. Enter the two-digit Memory Address.
3. Press  or  to scroll.



Note: The scroll feature will skip any vacant memory address(es).

Phonebook Sort Scroll Mode

This mode sorts and displays, in alphabetical order, telephone numbers stored with "Alpha Tags" (Names). Blank digits on top will be disregarded for scroll.

Example: To display the numbers stored in the memory alphabetically from "J".

1. Press  .



2. Press  for "J".



3. Press .



4. Press .



5. Press .



Note: When the Alpha Tag is 2 lines long, only the Alpha Tag is displayed without the telephone number. However, a call can still be made by simply pressing .

Phonebook Key Word Search Mode

This mode searches and displays the character string of Alpha Tags stored in the Phonebook. Any part of the Alpha Tag can be used for the search.

Example: To search the character string AN stored in the Phonebook.



1. Press   .

2. Press  for "A".

3. Press   for "N".

4. Press  .

5. Press  .

6. Press  .

7. Press  .



8. Press  .

Notes: 1. The key word can be searched regardless of upper or lower case letters.

2. When the Alpha Tag is 2 lines long, only the Alpha Tag is displayed without the telephone number. However, a call can be made by simply pressing  .

To Dial Dual Numbers

After the number is recalled in the display, it can be easily called by pressing .

- To dial the primary number, just press .
- To dial the secondary number, press  .

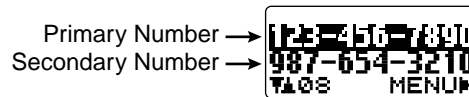



To Review Long Numbers

This feature allows you to review all the digits of very long numbers or numbers stored with Alpha Tags.

1. Use any of the previously described Phonebook search modes to recall a number.
2. Press  and scroll to “VIEW TEL#”, and the entire digits of the number will be displayed.

To Review Long Names

This feature allows you to review whole Alpha Name Tag stored with dual numbers.

1. Use any of the previously described Phonebook search modes to recall a number.
2. Press  and scroll to “VIEW NAME”. Press  again, and all the characters of the Name will be displayed.

Prepending Dialing

This feature will be convenient when you need to add an area code to the number in the phonebook.

Example: To add 1 2 3 to a number 4 5 6 7 8 9 0.

1. Recall the number.



2. Enter   .

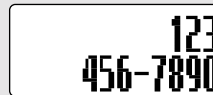

3. Press . Then the call is placed to 123-4567890.

Note: The added digits will not be stored in the phonebook memory.

Phonebook Edit





This section guides you how to modify, move, change priority and erase the phonebook contents.

To Modify Numbers and Names



You can modify any of the phonebook contents you have stored, including Phone Numbers, Names, Ring Type, Secret and Address.

To Modify Phone Numbers



Recall the number from the phonebook.

Press  to select "MENU", then scroll to "MODIFY" and press . Enter the new digit(s) and delete the old digit(s) by pressing . To move the cursor, press  to left,  to right.

To Modify Alpha Name Tag

Recall the number and proceed to "MODIFY" as above. Press , and the Name Tag will appear by itself. Press  to clear the letter(s), and enter the new Name.

To Modify Address

After you modified number/name, just press  without entering new address, and the current phonebook address will be overwritten. If you enter a new address, and press , the modified number/name will be copied to the new address, while the original address will remain unchanged.

To Enter a Second Number

Example: To add the secondary number 9 8 7 6 5 4 3 2 1 0 in the address 07.

1. Recall the number stored in the memory address 07.

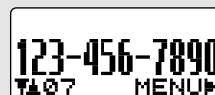

123-456-7890
07 MENU

2. Press  and scroll to "MODIFY".



MENU
VIEW TEL#
VIEW NAME
MODIFY

3. Press .













123-456-7890
[STO] MENU



4. Press  and scroll to "DUAL MARK".



MENU
LINK MARK
DUAL MARK
HYPHEN

5. Press  .
The Dual Mark “\” is inserted.







6. Enter           .

7. Press   .

8. Press  .
The original number is displayed momentarily.

9. Two seconds later.

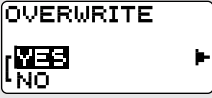
10. Press  to store in the original address.









To Move Numbers and Names



You can move the phonebook contents to a new address. The original address will then be erased.





Example: To move the number 1 2 3 4 5 6 7 8 9 0 from the address 20 to 15.

1. Recall the number stored in the address 20.

2. Press  and scroll to “MOVE”.

3. Press  .

4. Enter   as a new address.







To Change Priority of Dual Numbers

You can interchange the primary and the secondary numbers in a phonebook address. The submenu “**PRI.CHANGE**” will only be available when two telephone numbers are stored in that address.

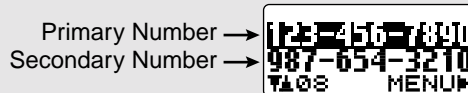
Example:

1. Recall the number.



2. Press and scroll to “**PRI.CHANGE**”.



3. Press . The display shows the status after change.

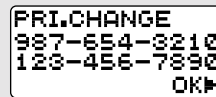

4. Press to decide it.

Note: The primary number will be dialed when you use **Speed Dialing** and **Quick Dialing** features.

To Erase Numbers and Names

This feature erases the number already stored in the Phonebook.

Example: To erase the number 9 8 7 6 5 4 3 2 1 0 1 2 3 stored in the memory address 16.

1. Recall the number stored in the memory address 16.

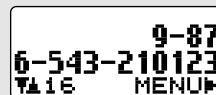

2. Press and scroll to “**ERASE**”.



3. Press . The number is shown again.

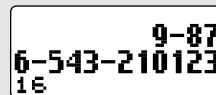

4. Two seconds later the screen is changed.







5. To erase the number scroll to “**YES**”, otherwise “**NO**”, and Press .

Secret Memory

To Store a Secret Number

This feature permits you to store a phone number that you want to keep secret in your phonebook. The secret number can be accessed only by entering the **security code** (see page 49).

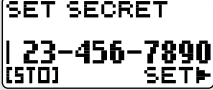
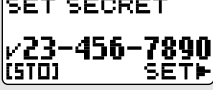
Example: To store the phone number 1 2 3 4 5 6 7 8 9 0 in address 30 as a secret number.

1. Press **CLR**.
2. Enter **1** **2** **3** **4** **5** **6** **7** **8** **9** **0**.

3. Press **STO** **STO**.

4. Press **F** and scroll to "SECRET".

5. Press **F**.

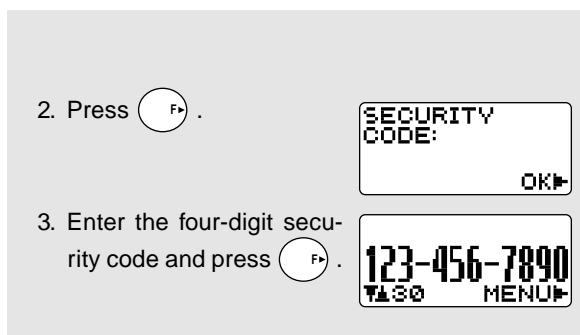
6. Press **F** to put a mark "✓" on the number to be secret.

7. Press **STO**.
8. Enter **3** **0** to store it.

To Recall a Secret Number

Example: To recall the number 1 2 3 4 5 6 7 8 9 0 stored in the address 30.

1. Use Phonebook Search Mode to recall a secret number.



Link Dialing

This feature permits you to link groups of numbers to be sent in sequence. The linked numbers can be stored in memory. When dialed, the first group of numbers will be sent in digital signaling, and the rest of the numbers will be sent in Touch Tone™ group by group each time you press .

To Store Linked Numbers in Phonebook

Linked Numbers can be stored using any of the procedures described under memory operations (at a specific address, with a Name Tag, at the next vacant memory location or as secret). The only difference is, that a Link Mark “=” must be entered between the linked numbers. The link mark is entered using the key sequence .



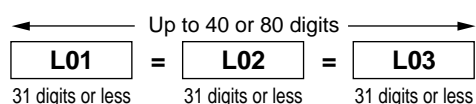





You can store Linked Numbers with Link Marks “=” up to 40 digits for the address 01 to 90, and up to 80 digits for the address 91 to 99 in the phonebook.



The example on the next page shows how to store a Linked number at a specific memory address.

1. Enter the first number.
2. Press . A link mark “=” will be added at the end of the number.
3. Enter the second number. If you wish to link additional number(s), return to 2.
4. Press , then enter the memory address (01 ~ 99).

Example: To link 3 numbers and store in Address 35.

1. Enter **7** PORS **4** GHI **6** MNO **3** DEF
4 GHI **7** PORS **9** WXYZ .

2. Press **F>** .

3. Press **F>** .

4. Enter **1** **2** ABC **3** DEF .

5. Press **F>** .

6. Press **F>** .

7. Enter **1** **2** ABC **3** DEF **4** GHI
5 JKL **6** MNO **7** PORS **8** TUV **9** WXYZ
0 OPER .

8. Press **STO** **STO** **3** DEF **5** JKL .

Note: While entering a linked number, you may review all the parts of that number, even those already entered.

Press **F>**, scroll to "VIEW TEL#" and press **F>**. The linked numbers you have just entered will be displayed one by one each time you press **F>**.

To Place Calls using Linked Numbers

1. Press **<Rec**, and select the linked number you want to call. (See **Phonebook Recall** on page 31.)
2. Press **[hook]**. Then the **IN USE** indicator will light as the first number is dialed.
3. Press **[hook]**. The second linked number will be sent in Touch Tone™ signals. Succeeding numbers can be sent sequentially by pressing **[hook]** again.

Call History

This feature recalls outgoing Call History and incoming Caller ID numbers. This is convenient for redialing recently called numbers or for returning missed calls by using the stored Caller ID. (See **Caller ID with Name** on page 19.)

Call History Memories

Memory	Description
OUTGOING	Last 10 numbers you dialed. Address 01 to 10.
INCOMING	Last 10 numbers you answered or missed. Address 01 to 10.
SCRATCHPAD	Last 3 numbers you wrote during calls. Address 01 to 03.

You can access the memory in two ways, Scroll and Shortcut.





By Scrolling

1. Press  and scroll to "HISTORY".







2. Press  and scroll to the menu item you want.



3. Press  to select.
4. To review the numbers in memory, scroll with  or .
5. After a number is displayed, it can be easily dialed, by simply pressing .

Shortcut:



- Press   to display the latest number in the outgoing history memory.
- Press   to display the latest number in the incoming history memory.

To Review Outgoing Call History

Example: To recall a number from Outgoing History.

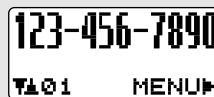
1. Press   .
The most recent call is displayed.















2. Scroll with  or  to review other numbers.
3. You can place a call by simply pressing .

When duplicate numbers are called, only the latest call is stored in the outgoing call history memory.









To Review Incoming Call History

Example: To recall a received Caller ID from Memory Stack.

1. Press   .
The most recent call is displayed. 
2. Press  . A time stamp is shown, if available. 
3. Press  .
A name is shown, if available in your phonebook. 
4. You can place a call by simply pressing .

In the incoming call history, the calls are marked with “” or “”. Numbers with “” represent calls you missed, and numbers with “” represent calls that you answered. When duplicate numbers are received, only the latest call is stored in the incoming call history memory.

To Review Scratch Pad

- Example:**
1. Press    .
  . 
 2. Scroll with  or  to review other numbers.
 3. You can place a call by simply pressing .

To Save a Number to Phonebook

The numbers of Call History and Scratch Pad Memory can be stored in your phonebook. You can add a name in the same way as “MODIFY”. See **To Modify Numbers and Names** on page 34.

Example: To save a received Caller ID to Phonebook.

1. Recall a number.



123-456-7890
T101* MENU▶

2. Press  and scroll to “SAVE”.



MENU
VIEW TEL#
VIEW NAME
SAVE ▶

3. Press .



123-456-7890
[STO] MENU▶

4. Press  .



Address: Auto:25
[STO] OPTION▶

5. Enter   as an address.

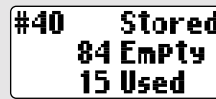





#40 Stored
84 Empty
15 Used

MESSAGING FEATURES

Your CDM-4000/CDM-4000XL Audiovox Cellular Telephone has been engineered to operate with the latest technology that will allow you to enjoy the benefit of Voice Mail Notification and Text Messages. Please note that operation of these features depends on the Cellular System and therefore may not be available in all areas.

Message Indicator

A message indicator  shows you the current status as explained below.

 Flashing	You have new Text Messages or new Voice Mail Notification.
 Steady	You have Text Messages or Voice Mail Notification, which you have seen already.
 off	Neither Text Message nor Voice Mail Notification.

In addition to the  indicator, whenever your Voice Mail contains unreviewed messages, you will occasionally hear a short beep as a reminder.

Voice Mail

Voice Mail Notification

Your cellular telephone notifies you when new messages are in your Voice Mail. When messages are left in your Voice Mail, the  indicator at the upper right of the display flashes to alert you.

Normal Voice Mail Notification

When your phone is notified by the cellular system that there are messages in your Voice Mail, the following occurs.

1. The phone sounds a short beep tone.
2. The  indicator at the upper right of the display flashes to alert you.

The display indicates "NEW MESSAGE" with animation.



3. The Phone's Memory Stack is updated as to the number of unreviewed messages in your Voice Mail.

Voice Mail Notification with Mail Retrieval Service (MRS)

1. The phone sounds a short beep tone.



2. Press to answer the incoming call, your phone will be connected to your Voice Message Service so that you may retrieve your messages.
3. If you choose not to answer the incoming call, "Message Retrieval" will be stored in the stack for retrieval of your messages at a later time.

To Display the Number of Voice Mail Messages

Example:

1. Press . A mark "*" is flashing, when a new message is available.



2. Press to select "VOICE". The number of messages in your Voice Mail will be displayed.



3. If a Text Message is attached to the Voice Mail Notification, the Text Message can be reviewed by . Otherwise this step is skipped.

4. Press . Scroll to "QUIT" or "ERASE" the notification you reviewed.



5. Press .



6. To erase the Voice Mail Notification, scroll to "YES", otherwise "NO", and press .

Voice Mail Dialing

You can store one set of linked numbers in a specially provided memory, and access these numbers with one touch of the "Voice Mail Access" key .

To Store the Voice Mail Access Number

Please see **To Store Linked Numbers in Phonebook** on page 38, and follow the steps 1 ~ 3 to make a set of linked numbers. Press **(STO)** **(STO)** **(V+)** to store. Up to 80 digits of linked numbers can be stored including link mark “ = ”. You can also add a Name Tag (up to 20 characters) with your voice mail number. (See **To Store a Name with Phone Number** on page 27.)

To Call Your Voice Mail



1. Press and hold **(V+)**. The first number will be displayed and dialed.
2. Press **(V+)**. The second number will be displayed and sent in Touch Tone™ signal.
3. The succeeding numbers can be sent sequentially by pressing **(V+)**.

To Review the Voice Mail Access Number

1. Press **(Rcd)** to select the Phonebook Address Mode.
2. Press **(V+)**. The first linked number in **(V+)** will be displayed.
3. Press **(F+)** (one or more times) to display the remaining linked numbers in **(V+)**.

Text Messages (Short Message Service)















Your phone is able to receive and display Text Messages of up to 255 characters long. The Text Message memory stack can store up to 30 messages. When an SMS message is received, the following occurs.

1. A short beep tone sounds.
2. The  indicator at the upper right of the display flashes to alert you. The display indicates “**NEW MESSAGE**” with animation. 
3. The Text Message just received is stored in the Memory Stack. To review stored messages, see **To Review a Text Message** on page 46.
4. If the Memory Stack is full, any new Text Messages will not be stored, and you will have the display: 

To Review a Text Message

Text messages are stored in the address 01 to 30 in the memory stack. The address 01 has the last message. Every message moves to the next address when a new message is stored.

Example: To display a Text Message stored in the Memory Stack.

1. Press  and scroll to "TEXT". You have now 10 Text Messages out of 30 memories. A mark "*" is flashing, when a new message is available. 
2. Press . The first Text Message is displayed. A longer message will be automatically scrolled every 6 seconds. 
3. Press  or wait for 6 seconds to review an optional information. 
4. Press  or wait for 6 seconds. If a Callback Number is displayed, you can dial it by simply pressing . 
5. Press  and scroll "QUIT" or "ERASE" for the message that you just reviewed. 
6. Press  to select. 
7. To erase the Text Message, scroll to "YES", otherwise "NO", and press .
8. To review another message, scroll with  or .

Notes: New Text Messages are marked with "*". Text Messages you have already reviewed are marked with "◇".

FUNCTION MENU



To Access Function Menu

Various phone settings can be changed through Function Menu to customize your phone's functions to fit your convenience. See **Function Menu Tree** in the following page. You can reach the Function you want to access in two ways; Scroll and Shortcut.

By Scrolling

1. Press  to enter Main Menu.





2. Scroll with  or  key to the desired item in the Main Menu.



3. Press  to enter the submenu.





4. Scroll with  or  key to the desired item in the submenu.





5. Press  to enter the function.

By Shortcut

Each Function has its shortcut number for direct access. For example, to enter the function "RINGTYPE" (F32), press   .

To Exit from Function Menu

- To return from a submenu to the main menu, press .
- To exit from Function Menu, press .

Notes: 1. A mark "▶" at the right in a menu prompt you that you can see its detailed items by pressing .

2. A mark "▼" shows the current setting of the function.

Function Menu Tree

Main Menu Submenu Branch

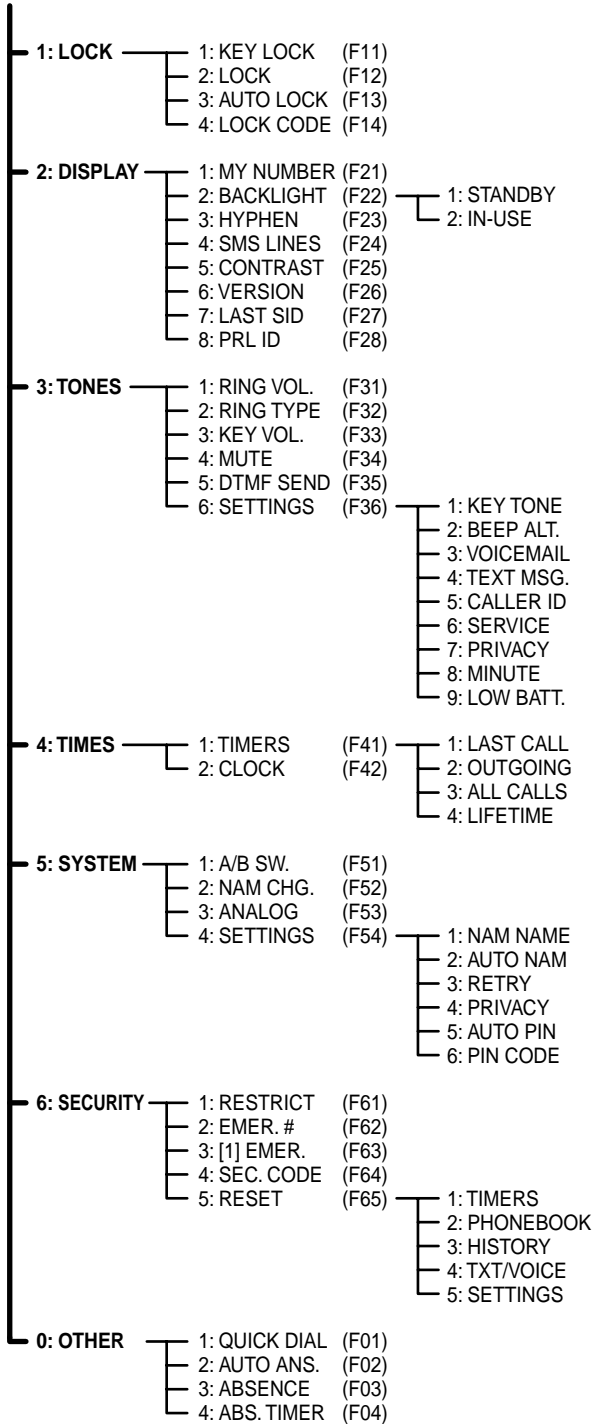

Lock Features

Security Code and Unlock Code

Your phone is equipped with the Security Code and the Unlock Code to access various security features. You may change the preset codes for added protection.

Code	Preset	Description
Security Code	1234	To access Secret Number, to set Call Restriction, etc.
Unlock Code	1234	To unlock the Phone

See **To Change the Security Code (F64)** on page 65.

See **To Change the Unlock Code (F14)** on page 50.

Keypad Lock (F11)

This mode is useful for preventing inadvertent pressing of keys. (For example, when the phone is in a purse or pocket.)







With this feature on, the following functions are still available.

- Incoming calls can be answered with .
- Programmed emergency numbers can be called. (Except for **OneTouch Emergency Call**.)

When this feature is on, the following functions are not available.



- Automatic Answering
- Any Key Answering
- OneTouch Emergency Call
- Quick Dialing
- Turning off the phone by .

To Activate/Deactivate this Feature:

1. Press    to activate "Keypad Lock" mode. 
2. Press    again to deactivate.

Phone Lock (F12)



This mode is useful to prevent unauthorized use of the phone. With this feature on, the following functions are still available.

- Incoming calls can be answered with .
- Any Key Answering
- Programmed Emergency Call
- OneTouch Emergency Call
- Turning off the phone by .

The following functions are not available when this feature is on.

- Automatic Answering
- Quick Dialing

To Activate:

1. Press    to activate "Phone Lock" mode.

Note: The phone will remain locked even if the power is turned off.





Automatic Phone Lock (F13)

If you activate this feature, the phone will automatically go into the phone lock condition after it is turned off. (See **Phone Lock (F12)** above.) When you turn the phone on, you must enter the four-digit unlock code before it operates. (See **To Unlock the Phone** below.)

1. Press   .



2. You can turn this feature on/off by  or .
3. Press  to set.

To Unlock the Phone

1. Enter the four-digit unlock code.
2. The "Phone Lock" indicator will go out.

To Change the Unlock Code (F14)

1. Press   .



2. Enter the four-digit security code and press .

- The current unlock code will be displayed.

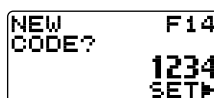

- Enter a new four-digit unlock code and press  .

Display Features

Own Telephone Number Display (F21)

This feature enables you to display your own telephone number and the ID number (SID) of your “Home” Cellular System.

Press    .



Backlight Control (Standby) (F22-1)

The LCD display and keypad are backlit automatically after Power-On.



The backlighting duration can be changed. Four modes are available.

- Press    .



- Press  .



- You can change the current mode by  or  .
- Press  to set.

- **10SEC – 10 Seconds Mode**

Backlight is on for 10 seconds after a key is pressed. It also lights automatically when the power is turned on and for an incoming call. The duration is variable between 5 to 30 seconds, by pressing  .

- **OFF – Off Mode**

Backlight is on momentarily when the power is first turned on, but remains off thereafter.









- **ALWAYS ON – Always On Mode**

Backlight is always on.

Note: You can keep the backlight on while you are engaged in a conversation. See **Backlight Control (In-Use) (F22-2)** on page 52.







Backlight Control (In-Use) (F22-2)

For ease of operation, you may select to have the backlight always on while you are engaged in a conversation. When this feature is set to the “ALWAYS ON” mode, the backlight is turned on as long as the call is connected.

1. Press   , and scroll to “IN-USE”.

2. Press .

3. Scroll with  or  to “NORMAL” or “ALWAYS ON”.
4. Press  to set.







Auto Hyphenation (F23)

See **Auto Hyphenation** on page 24.

1. Press   .

2. Scroll with  or  to “ON” or “OFF”.
3. Press  to set.







SMS Text Lines Selection (F24)

You can select to have Text Messages displayed in either 3 or 4 lines.

1. Press   .

2. Scroll with  or  to “3LINES” or “4LINES”.
3. Press  to set.

Contrast Control (F25)

The LCD display contrast can be adjusted in 7 steps for your best condition.

1. Press   .

2. Adjust the contrast with  or .
3. Press  to set.

Software Version Review (F26)

This feature permits you to review the software version which is installed in your phone.

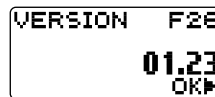
1. Press   .



```
VERSION F26
01.23
OK
```

2. Press  to exit.

Last Rescan SID Indicator (F27)

This menu item permits you to view the **System Identification number (SID)**, which your phone is currently using.

1. Press   .

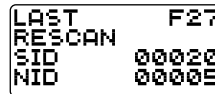

```
LAST RESCAN F27
SID 00020
NID 00005
OK
```

2. Press  to exit.

PRL ID Review (F28)

This menu item permits you to view the **Preferred Roaming List (PRL)** version that is programmed in your phone.

1. Press   .

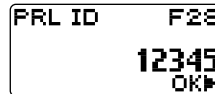

```
PRL ID F28
12345
OK
```



2. Press  to exit.

Volume and Tone Controls

Alert Tone Volume Control (F31)

1. Press   .



2. Keep pressing  or  until you get the desired sound level, or "silent" mode.



Note: In "silent" alert mode, alert tone is not given for an incoming call. However, if Automatic Answering feature is ON, alert tone is given with the lowest available volume.

Ring Type Selection (F32)

This feature permits you to select an alert tone pattern from 15 options including melody ringers.

1. Press   .





2. Press  or  to select the alert tone.
3. Press  to set.

Key Tone Volume Control (F33)

1. Press   .









2. Keep pressing  or  until you achieve the desired sound level, or "silent" mode.

Note: Key tone will be off in "silent mode", but tone will be heard on the other side of the line.





To Mute a Phone Conversation (F34)

You can mute your conversation at any time during a call.

1. Press   .
2. Then the "Mute" indicator is displayed. The transmit audio will be muted but the receive audio will still be heard from the receiver. 
3. To return to normal conversation, press    again.
4. Mute is reset when the call is terminated.





Sending DTMF (F35)

This feature allows you to activate or deactivate Sending DTMF (Touch Tone™) when you enter a number during a call.

1. Press   .
2. Scroll to "ON" or "OFF" to select. 
3. Press  to set.









Setting Tones (F36)

This is a group of 9 functions related to the setting of tones.

1. Press   . The Branch Menu is displayed. 
2. Refer to the particular functions for details.

Key Tone Length (F36-1)

This feature selects the duration of the tone length when a key is pressed.

1. Press    and . 
2. You can change the current mode by  or .
3. Press  to set.

- **NORMAL – Normal Mode**









Tone is heard as long as the key is being pressed.

- **SHORT – Short Mode**

Tone is heard for a short time even if the key remains pressed.









Single Alert Beep Tone (F36-2)

This feature is used to signal an incoming call with only a single beep. This feature can only be used with the “silent” alert mode. See **Alert Tone Volume Control (F31)** on page 54.

1. Press    and  .

2. You can turn this feature on/off by  or  .
3. Press  to set.









Voice Mail Alert (F36-3)

This feature audibly alerts you when a Voice Mail Notification is received. A Voice Mail Notification is received if your Voice Mail contains messages that have not been reviewed.

1. Press    and  .

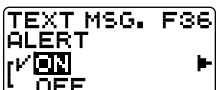
2. You can turn this feature on/off by  or  .
3. Press  to set.









Text Message Alert (F36-4)

This feature audibly alerts you when a Text Message is received.

1. Press    and  .

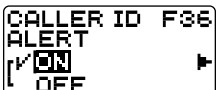
2. You can turn this feature on/off by  or  .
3. Press  to set.









Caller ID Alert (F36-5)

This feature audibly alerts you when a Caller ID is received.

1. Press    and  .

2. You can turn this feature on/off by  or  .
3. Press  to set.









Service Mode Alert (F36-6)

With this feature on, an audible tone alerts you when the service mode changes from Digital to Analog, or vice versa.

1. Press    and  .

2. You can turn this feature on/off by  or  .
3. Press  to set.









Voice Privacy Alert (F36-7)

This feature audibly alerts you when the voice privacy service is provided, and also when the service is canceled.

1. Press    and  .

2. You can turn this feature on/off by  or  .
3. Press  to set.

One Minute Beep Tone (F36-8)









With this feature on, you will be notified during a call, once every minute by a short beep tone. In addition, two beep tones will sound every five minutes.

1. Press    and  .

2. You can turn this feature on/off by  or  .
3. Press  to set.

Low Battery Alarm (F36-9)

When activated, this feature warns by an audible alarm when the battery level is low.

If the alarm is given, recharge the battery or replace it with a fully charged battery.

1. Press    and  .

2. You can turn this feature on/off by  or  .
3. Press  to set.

Call Timers

To help you manage your calls, your phone is equipped with several Call Timers.

Last Call Timer (F41-1)

1. Press .
The talk time of the last call will be displayed.
2. Press to exit.

```
TIMERS F41
      1M23S
1: LAST CALL
2: OUTGOING
```

Outgoing Call Timer (F41-2)

1. Press and . The cumulative talk time of all outgoing calls will be displayed.
2. Press to exit.

```
TIMERS F41
      34M56S
2: OUTGOING
3: ALL CALLS
```

All Calls Timer (F41-3)

1. Press and . The cumulative talk time of all incoming and outgoing calls will be displayed.
2. Press to exit.

```
TIMERS F41
      1H23M45S
3: ALL CALLS
4: LIFETIME
```

Note: The above three timers can be reset to zero by using “Call Timer Reset” feature. See page 66.

Lifetime Timer (F41-4)

1. Press and . The cumulative “lifetime” talk time of all incoming and outgoing calls will be displayed.
This timer cannot be reset to zero.
2. Press to exit.

```
TIMERS F41
      12H34M56S
4: LIFETIME
1: LAST CALL
```

Clock Indicator (F42)

When the phone is in an area with digital service (Digital Mode) with this feature enabled, the date and time are automatically displayed.

1. Press .
2. You can turn this feature on/off by or .
3. Press to set.

```
CLOCK F42
[ ON OFF ]
```







System Features

A/B System Selection (F51)

This feature permits you to select which Cellular system (A or B) your phone uses. When you turn the phone on, it remembers the last A/B setting and will scan the radio channels based on that setting.

Leave this setting as it has been preprogrammed unless you have a reason to alter the system selection.

To alter the system selection:

1. Press    .
The current mode will be displayed.
2. You can change the current mode by  or  .
3. Press  to set.



- **AUTO ROAM – Auto Roam Mode**

The phone will scan the priority systems first, and then non-priority systems. For more information as to how this mode works, see **Enhanced Roaming** below.

- **HOME – Home Only Mode**

You can place or receive calls only within your home area or home affiliated area.

- **A-ONLY – A-System Only Mode**

The phone will scan the A-system only and prevents switching over to the B-system.

- **B-ONLY – B-System Only Mode**

The phone will scan the B-system only.

Note: If your LCD displays “**AUTO ROAM**”, your phone has been pre-programmed to operate in the **Auto Roam Mode** only.

Enhanced Roaming

Cellular systems are identified by a number called System Identifier or SID. Your phone is equipped with a **Preferred Roaming List (PRL)** which can be programmed by your Carrier to take advantage of the families of cellular system (SIDs) that your Carrier owns, or has special billing arrangements with, in different cities.

In your Home System Area, both “**No Service**” and “**Rm**” are off in your display. Outside of the Home System in Service Areas closely associated with your Carrier, the phone’s display may appear the same as when operating in the Home System.

In areas where your Carrier has Roaming agreements, your phone will display a steady "Rm" indication. If your display indicates a flashing "Rm", you are in a cellular system which is not associated with your Carrier (you can still make or receive calls).

If your display indicates "(No Service)", you may have to change your A/B System Selection or NAM Selection in order to obtain service. If your display indicates "No Service", you are in an area where there is no cellular service.

NAM Selection (F52)



Some Cellular users may find it beneficial to register their phones with multiple numbers, for different cities where they may frequently travel. To provide this ability, your phone has two NAMs (Number Assignment Modules) enabling up to two registrations.

If you have multiple registrations, the NAM Selection feature enables you to change the NAM being used by your phone. Do not use this feature, if you do not have multiple registrations.

To change NAMs:

1. Press   .



2. You can change the current NAM by  or .
3. Press  to set.

Force Analog Call (F53)

This feature temporarily directs the phone to use the Analog Mode even if the Digital Mode has been previously selected.

1. Press   .





2. Press  when scanning the Analog Mode.

Notes: This feature automatically ends if:

- 1) The phone is turned off.
- 2) An outgoing call is made.
- 3) An incoming call is received.
- 4) After 10 minutes if items 1) ~ 3) did not occur.

System Settings (F54)





This is a group of several functions for settings related to the system.

1. Press    .
The Branch Menu is displayed.





NAM Name Display (F54-1)

You can program a greeting or a name of a maximum 10 to 12 characters in the second line of your LCD display. This will be displayed when the phone is turned on or when you change the NAM. (See **NAM Selection (F52)** on page 60.) As you can program different name for each NAM, you can tell which NAM is currently active when you turn the phone on.

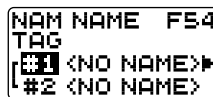
1. Press    and  .



2. You can select other NAM by  or  .







Then press  to edit.



3. Enter your message.
(See **Alpha Mode** on page 27.)
4. Press  to store the message.

Automatic NAM (F54-2)

If you have multiple NAM registrations (see previous description), your phone will recognize NAMs for which you are registered. The phone will then automatically switch to the proper NAM for the area in which you are in.

1. Press    and  .











2. You can turn this feature on/off by  or  .
3. Press  to set.

Automatic Retry (F54-3)

With this feature on, your telephone will automatically make up to seven call attempts when the first try is not successful.











The **INUSE** indicator will stay on, and the speaker will be muted. Press  to cancel the Automatic Retry.

1. Press    and  .

2. You can turn this feature on/off by  or  .
3. Press  to set.

Enhanced Voice Privacy Service (F54-4) (Digital Mode Only)

This feature requests the cellular system to provide the enhanced voice privacy service. This service can only be provided in the Digital Mode, and its availability depends on the cellular system and your service provider.

To Set the Enhanced Voice Privacy Mode:

1. Press    and  .

2. To request the cellular system to provide the enhanced voice privacy service, select “**ENHANCED**” with  or  , and press  .
3. When the phone is operating in the Enhanced Voice Privacy Mode, “**VP**” appears in the upper line of the display during talking.
4. To request the cellular system not to use the enhanced voice privacy service, select “**STANDARD**” with  or  , and press  .

Notes: 1. This feature must be activated before the call is initiated.

2. Even if the standard mode is selected, the cellular system may direct the phone to use the Enhanced Voice Privacy Mode.



Anti Fraud Security Features

Your new Audiovox Cellular telephone has been engineered with the latest technology to help protect from the fraudulent use of your cellular telephone number.



Your phone is equipped with Authentication and PIN (Personal Identification Number) Dialing. (Availability of these features depends on your Service Provider).

Should your Service Provider require use of a PIN, your PIN can be sent manually or programmed into the phone for more convenient use.

To Place a Call with the Manual PIN Entry

1. Enter the number you are calling, or recall the number from a specific memory location.
2. Press . Your call will be processed. Listen for a double beep, which will prompt you to send your PIN.
3. Enter your PIN number, and press . Your call will then be placed.







To Place a Call with the Automatic PIN Feature

1. Enter the number you are calling, or recall the number from a specific memory location.
2. Press "SEND" key . As your call is being processed, you will have the display:

3. Press "SEND" key  again. Your call will then be placed.









Note: Before you can use this feature, you must program your PIN and turn the Automatic PIN feature on. (See procedures below.)

To Place a Call to Voice Mail using the Automatic PIN Feature









(See **Voice Mail Dialing** on page 44.)

1. Press  for more than one second. As your call is being processed, you will have the display:

2. Press  again, your PIN will be sent.
3. Press  again. The second number stored in  will be sent in Touch Tone™ signals. The subsequent numbers, if any, can be sent sequentially by pressing .

To Turn the Automatic PIN Feature On/Off (F54-5)

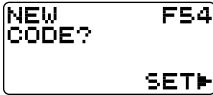
1. Press    and .

2. You can turn this feature on/off by  or .
3. Press  to set.

To Program or Change your Automatic PIN (F54-6)









1. Press    and  .

2. Enter the four-digit security code and press  .

3. Enter your new PIN Code. Press  to program.

Security Features

Call Restriction (F61)

This feature permits you to impose various kinds of restrictions on outgoing calls. Emergency numbers can be placed even when this feature is on.

To Set Call Restriction Mode

1. Press    .

2. Enter the four-digit security code and press  .

3. You can change the current Restriction mode by  or  .
4. Press  to set.

The available Restriction modes are as follows:

- **11DIGITS – 11 Digits Mode**

Only phone numbers of 11 digits or less are accepted.
Operator assisted dialing is prohibited.

- **7DIGITS – 7 Digits Mode**

Only phone numbers of 7 digits or less are accepted.
Operator assisted dialing is prohibited.

- **OPERATOR – Operator Mode**

Operator assisted dialing (0 Origination Call) is prohibited.

- **RCL01-09 – Phonebook Address Mode**

Only outgoing calls to the numbers stored in the phonebook address range 01 – 09 can be made. If there is a need to expand this range of addresses please ask your dealer.

- **OFF – Off Mode**

No restriction.

To Change Emergency Numbers (F62)

You can program your own emergency numbers. Up to 3 numbers of maximum 32 digits can be stored.

Memory Location	Preset Emergency Number
# 1	911
# 2	*911
# 3	Blank

1. Press .

2. Enter the four-digit security code and press .

3. Press or to select the emergency number memory location (1, 2 or 3) that you want to change or program, and press .

4. Enter the new emergency number, and press .

Note: The emergency number in memory location 1 will be dialed when the **OneTouch Emergency Call** feature is used.

To Turn On/Off OneTouch Emergency Call Feature (F63)

1. Press .

2. Enter the four-digit security code and press .

3. You can turn this feature on/off by or .

4. Press to set.

To Change the Security Code (F64)

1. Press .

2. Enter the four-digit security code and press .

3. The current security code is displayed.

4. Enter a new four-digit security code and press .

Reset Functions (F65)

This is a group of several functions for Function/Memory Reset.

1. Press **F** **6** **MNO** **5** **JKL** .

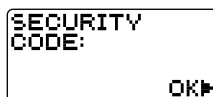

2. Enter the four-digit security code and press **F** .

Then the Branch Menu is displayed.



Call Timer Reset (F65-1)

This feature resets all the following three Call Timers; Last Call Timer, Outgoing Call Timer and All Calls Timer.

1. Press **F** **6** **MNO** **5** **JKL** .
2. Enter the four-digit security code and press **F** .
3. Press **1** .



4. Press **F** to reset the call timers.

Phonebook All Clear (F65-2)

This feature clears all of Phonebook locations (01 to 99) and the voice mail dialing memory **V+** .

1. Press **F** **6** **MNO** **5** **JKL** .
2. Enter the four-digit security code and press **F** .
3. Press **2** **ABC** .



4. Press **F** to clear the memory.

Call History All Clear (F65-3)

This feature clears all call history for outgoing and incoming calls including Caller ID.

1. Press **F** **6** **MNO** **5** **JKL** .
2. Enter the four-digit security code and press **F** .
3. Press **3** **DEF** .



4. Press **F** to clear the history.

Text Message & Voice Mail All Clear (F65-4)

This feature clears all Text Messages and the Voice Mail number.

1. Press **F▶** **6** **MNO** **5** **JKL** .
2. Enter the four-digit security code and press **F▶** .
3. Press **4** **GHI** .
4. Press **F▶** to clear the message.



Function Reset (F65-5)

This feature permits you to reset the User-Programmable functions to their initial settings.

1. Press **F▶** **6** **MNO** **5** **JKL** .
2. Enter the four-digit security code and press **F▶** .
3. Press **5** **JKL** .
4. Press **F▶** to reset.



Note: See *Function Reset Status* on page 68.

Other Functions

Quick Dialing (F01)

When this feature is on, the primary number in your phonebook address 02 to 09 can be dialed with just a single press of the key.

1. Press **F▶** **0** **OPER** **1** .
2. Scroll to "ON" or "OFF" you want and press **F▶** .



Automatic Answering (F02)

With this feature on, incoming calls will be automatically answered after a preset duration of alert tones. This feature may be convenient when your telephone is installed in the handsfree car kit.

1. Press **F▶** **0** **OPER** **2** **ABC** .
2. Scroll to "ON" and press **F▶** .
3. Enter duration (5 to 30) in seconds.
4. Press **F▶** to set.



Note: This feature will not function if the phone is in "Phone Lock", or "Keypad Lock" mode.

Function Reset Status

The following functions will return to the initial settings after **Function Reset**.

Functions	Initial Setting
Automatic Lock (F13)	OFF
Backlight Control (Standby) (F22-1)	Portable Use
	With Car Kit
Backlight Control (In-Use) (F22-2)	Normal
Auto Hyphenation (F23)	ON
Text Lines Selection (F24)	3 Lines
Contrast Control (F25)	Standard
Earpiece Volume Control	Level 3 (Max = 4)
Alert Tone Volume Control (F31)	Level 4 (Max = 4)
Ring Type Selection (F32)	Ring #1
Key Tone Volume Control (F33)	Level 3 (Max = 4)
Sending DTMF (F35)	ON
Key Tone Length (F36-1)	Normal
Single Alert Beep Tone (F36-2)	OFF
Voice Mail Alert (F36-3)	ON
Text Message Alert (F36-4)	ON
Caller ID Alert (F36-5)	ON
Service Mode Alert (F36-6)	OFF
Voice Privacy Alert (F36-7)	OFF
One Minute Beep Tone (F36-8)	OFF
Low Battery Alarm (F36-9)	ON
Clock Indicator (F42)	ON
A/B System Selection (F51)	Auto Roam
NAM Selection (F52)	NAM #1
Automatic NAM (F54-2)	OFF
Automatic Retry (F54-3)	OFF
Voice Privacy Service (F54-4)	Standard
Automatic PIN Mode (F54-5)	OFF
Call Restriction (F61)	OFF
OneTouch Emergency Call (F63)	ON
Quick Dialing (F01)	ON
Automatic Answering (F02)	OFF
*Call in Absence Indicator (F03)	OFF
*Safety Timer (F04)	8 hours

* Affects Handsfree operation only.
Refer to Handsfree Car Kit (HF-4000) manual.

MEMO



MEMO

INDEX

A	
Alpha Mode	27
Any Key Answering	19
Automatic Answering ...	67
Automatic Calls-in-Absence Indicator	20
B	
Backlight Control	
In-Use	52
Standby	51
Battery	
Alarm	57
Attach/Detach	12
Recharge	12
C	
Call	
Place	17
Receive	19
Terminate	17
Call History	40
All Clear	66
Call Restriction	64
Call Timers	58
Reset	66
Call Waiting	21
Caller ID	19
Alert	56
Clock Indicator	21, 58
Contrast	52
D	
Distinctive Ringing	20
DTMF	55
E	
Emergency Call	18
One Touch	19, 65
Emergency Number	
Change	65
Enhanced Roaming	59
F	
Force Analog Call	60
Function Menu	
Access	47
Tree	48
Function Reset	67
H	
Hyphenation	
Auto	24, 52
Manual	25
K	
Keypad Lock	49
L	
Link Dialing	38
M	
Mute	55, 17
N	
NAM	
Automatic	61
Selection	60
Name Display	61
O	
Own Telephone Number	51
P	
Phone Lock	50
Automatic	50
Unlock	50
Phonebook	
All Clear	66
Phonebook Edit	
Change Priority	36
Erase	36
Modify	34
Move	35
Phonebook Entry	
Automatic Storing	25
Dual Numbers	26
Name	27
Number	23
Overwrite	24
Ring Type	29
Phonebook Recall	
Address Mode	31
Key Word	
Search Mode	32
Sort Scroll Mode	31
PIN	
Automatic	63, 64
Manual	63
Prepending Dialing	33
PRL	53, 59
Q	
Quick Dialing	18, 67
R	
Recall Menu	30
Retry	61
Ring Type	54
Ring Tone	20
S	
Scratch Pad	20, 41
Secret Memory	37
Security Code	49, 65
Short Message	
Service	45
SID	53, 59
Speed Dialing	18
System Selection	59
T	
Talk Timer	21
Text Messages	
Alert	56
All Clear	67
TouchTone™	20
from Display	22
from Memory	22
U	
Unlock Code	49, 50
V	
Voice Mail	
Alert	56
All Clear	67
Dialing	44
Notification	43
Voice Privacy	62
Alert	57
Volume	
Alert Tone	54
Earpiece	20
Key Tone	54

WARNING

When using your cellular telephone, please note that the following offenses are punishable by fine, imprisonment, or both:

- Using obscene, indecent, or profane language.
- Using the phone to give off false distress calls.
- Wiretapping or otherwise intercepting a telephone call, unless that person has first obtained the consent of the parties participating in the call.
- Making anonymous calls to annoy, harass, or molest other people.
- Charging to an account without authorization to avoid payment for service.
- Refusing to yield line when informed that it is needed for an emergency call (It is also unlawful to take over a line by stating falsely that it is needed for an emergency).

The CDM-4000/CDM-4000XL is using one or more of the following US patents licensed by QUALCOMM Incorporated:

4,901,307	5,309,474
5,056,109	5,103,459
5,101,501	5,099,204
5,109,390	5,107,225
5,228,054	5,283,536
5,257,283	5,280,472
5,265,119	5,337,338
5,267,261	5,339,046
5,267,262	5,341,456
5,289,527	

12 MONTH LIMITED WARRANTY

AUDIOVOX COMMUNICATIONS CORP. (the Company), warrants to the original retail purchaser of this Audiovox Handheld Portable Cellular Telephone, that should this product or any part thereof (except the items listed below), under normal use and conditions, be proven defective in material or workmanship within the first twelve (12) month period from the date of purchase, such defect(s) will be repaired or replaced (with new or rebuilt parts) at the Company's option, without charge for parts or labor directly related to the defect(s).

The keypad and display are similarly warranted for ninety (90) days from date of purchase.

The accessories consisting of the antenna and rechargeable battery pack, desktop charger are similarly warranted for twelve (12) months from original purchase.

This Warranty does not apply to batteries, fuses, or costs incurred for testing or checking, or to any product or part hereof which has suffered through alteration, serial number defacement, improper installation, excessive temperature or humidity, environmental conditions, mishandling, misuse, neglect or accident. This Warranty is not assignable or transferable.

To obtain repairs or replacement within the terms of this Warranty, the product should be delivered with proof of warranty coverage, specification of defect(s), transportation prepaid, to the Company at the address shown below. For TRAVELERS WARRANTY SERVICE.

Call toll free to (800) 229-1235 (in N.Y. State, (516) 233-3410) for reference to an Authorized Warranty Station in your area.

THE EXTENT OF THE COMPANY'S LIABILITY UNDER THIS WARRANTY IS LIMITED TO THE REPAIR OR REPLACEMENT PROVIDED ABOVE AND, IN NO EVENT, SHALL THE COMPANY'S LIABILITY EXCEED THE PURCHASE PRICE PAID BY PURCHASER FOR THE PRODUCT.

The Company disclaims liability for geographic coverage, inadequate signal to antenna, communications range or operation of the Cellular System as a whole.

ANY IMPLIED WARRANTIES, INCLUDING ANY IMPLIED WARRANTY OF MERCHANTABILITY SHALL BE LIMITED TO THE DURATION OF THIS WRITTEN WARRANTY. ANY ACTION FOR BREACH OF ANY WARRANTY HEREUNDER INCLUDING ANY IMPLIED WARRANTY OF MERCHANTABILITY MUST BE BROUGHT WITHIN A PERIOD OF 24 MONTHS FROM DATE OF ORIGINAL PURCHASE. IN NO CASE SHALL THE COMPANY BE LIABLE FOR ANY CONSEQUENTIAL OR INCIDENTAL DAMAGES FOR BREACH OF THIS OR ANY OTHER WARRANTY, EXPRESS OR IMPLIED, WHATSOEVER.

No person or representative is authorized to assume for the Company any liability other than expressed herein in connection with the sale of this product.









Some states do not allow limitations on how long an implied warranty lasts or the exclusion or limitation of incidental or consequential damage so the above limitation or exclusions may not apply to you. This Warranty gives you specific legal rights, and you may also have other rights which vary from state to state.

IN U.S.A.: AUDIOVOX COMMUNICATIONS
CORP.
555 Wireless Blvd., Hauppauge,
New York 11788
(516) 233-3300













IN CANADA: AUDIOVOX CANADA LTD.
405 Britannia Road East,
Mississauga, Ontario L4Z3E6
(905) 712-9299

Quick Reference







Basic Operation

Turn On/Off	 (more than one second)
Place a Call	Phone Number, 
Terminate a Call	
Receive a Call	Any Key (except  and )
Clear Last Digit	 (less than 0.5 sec.)
Clear All Digits	 (more than 0.5 sec.)
Earpiece Volume	 or  during a call

Convenience Features









Store Number in Phonebook	 , Phone Number,   , Phonebook Address
Phonebook Dialing	 , Phonebook Address, 
Speed Dialing	Phonebook Address, 
Last Number Redial	  
Dial last Number Received	  

Messaging Features













Review Voice Mail Number	 
Review Text Messages	   , then  or  for scroll

Quick Reference

Basic Operation

Turn On/Off	 (more than one second)
Place a Call	Phone Number, 
Terminate a Call	
Receive a Call	Any Key (except  and )
Clear Last Digit	 (less than 0.5 sec.)
Clear All Digits	 (more than 0.5 sec.)
Earpiece Volume	 or  during a call

Convenience Features

Store Number in Phonebook	 , Phone Number,   , Phonebook Address
Phonebook Dialing	 , Phonebook Address, 
Speed Dialing	Phonebook Address, 
Last Number Redial	  
Dial last Number Received	  

Messaging Features

Review Voice Mail Number	 
Review Text Messages	   , then  or  for scroll

Functions

Mute/Unmute	F▶ F▶
Keypad Lock	F▶ 1 1
Lock the Phone	F▶ 1 2ABC
Automatic Lock	F▶ 1 3DEF
Display Own Phone Number & SID	F▶ 2ABC 1
Backlight Control	F▶ 2ABC 2ABC
Last Call Time Display	F▶ 4GHI 1
Outgoing Call Time Display	F▶ 4GHI 1 2ABC
All Calls Time Display	F▶ 4GHI 1 3DEF
Automatic Answering	F▶ 0OPER 2ABC
A/B System Selection	F▶ 5JKL 1
Force Analog Call	F▶ 5JKL 3DEF

Functions

Mute/Unmute	F▶ F▶
Keypad Lock	F▶ 1 1
Lock the Phone	F▶ 1 2ABC
Automatic Lock	F▶ 1 3DEF
Display Own Phone Number & SID	F▶ 2ABC 1
Backlight Control	F▶ 2ABC 2ABC
Last Call Time Display	F▶ 4GHI 1
Outgoing Call Time Display	F▶ 4GHI 1 2ABC
All Calls Time Display	F▶ 4GHI 1 3DEF
Automatic Answering	F▶ 0OPER 2ABC
A/B System Selection	F▶ 5JKL 1
Force Analog Call	F▶ 5JKL 3DEF

CDM-4000/CDM-4000

*DUAL MODE DIGITAL CDMA TELEPHONE
ACCESSORIES*



BTR 4000
Slim Lithium Ion Battery



EM 425
Earphone Microphone



BTE 4000
Extended Lithium Ion Battery



CLP 4000
Cigarette Lighter Plug-In



CNR 4000
AC Adapter



DTH 4000
Desktop Holder

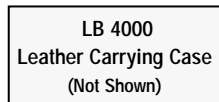

LB 4000
Leather Carrying Case
(Not Shown)

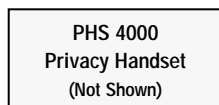

PHS 4000
Privacy Handset
(Not Shown)



HF 4000
Hands Free Car Kit



DTC 4000
Desktop Charger With AC Adapter

PROTECT YOUR WARRANTY

Read your Warranty carefully, with the special consideration to paragraph seven of the Limited Warranty for your unit.

“Warranty does not apply to...or to any product or part thereof which has suffered through alteration... mishandling, misuse, neglect, or accident”.

Many companies are making look-alike accessories and in some cases, promoting that their product is equal to or better than the Audiovox product. Be careful. Some of these products may not be compatible for use with your Audiovox product and may damage the unit or cause it to malfunction. If service is required on your unit, and it is determined that a non-Audiovox accessory has created the problem with your unit, the Warranty will not apply. In addition, if the unit has already suffered irreversible damage by reason of a non-compatible accessory, the Warranty will be voided. To protect your Warranty, use only compatible accessories which cannot damage or interfere with the functioning of your Audiovox product.



AUDIOVOX COMMUNICATIONS CORP.

555 Wireless Blvd., Hauppauge, New York 11788, 516-233-3300
16808 Marquardt Avenue, Cerritos, California 90701, 562-802-5100

Audiovox Canada
405 Britannia Rd. East, Ste 101, Mississauga, Ontario,
Canada L4Z3E6, 905-712-9299

Audiovox Pacific Pty Ltd
110 Rocky Point Road, Kogarah, NSW 2217, Australia,
02-9587-0000

Audiovox New Zealand Pty Ltd
Unit B, 6 Henderson Place, Auckland, 6496345720

Audiovox Singapore Pte Ltd
268 Orchard Road, #07-07, Singapore, 238856, 65-733-5902

<http://www.audiovox.com>



Free Manuals Download Website

<http://myh66.com>

<http://usermanuals.us>

<http://www.somanuals.com>

<http://www.4manuals.cc>

<http://www.manual-lib.com>

<http://www.404manual.com>

<http://www.luxmanual.com>

<http://aubethermostatmanual.com>

Golf course search by state

<http://golfingnear.com>

Email search by domain

<http://emailbydomain.com>

Auto manuals search

<http://auto.somanuals.com>

TV manuals search

<http://tv.somanuals.com>