

 **AUDIOVOX**
Cellular Communications

MVX-430

 **AUDIOVOX**[®]
Cellular Communications

Division of Audiovox Corporation
185 Oser Ave., Hauppauge, NY 11788

PRINTED IN HONG KONG 12-95

**HANDHELD
PORTABLE
CELLULAR
TELEPHONE**

**OWNER'S OPERATING
INSTRUCTIONS**

TABLE OF CONTENTS

SYSTEM CONFIGURATION	6
WRIST STRAP ATTACHMENT (OPTION)	7
BATTERY INSTALLATION AND RECHARGING	8
To Attach the Battery Pack	
To Detach the Battery Pack	
To Recharge Battery	
IMPORTANT SAFETY INSTRUCTIONS	11
PRECAUTIONS	12
GENERAL SPECIFICATIONS	13
FEATURES AND OPTIONS	14
FUNCTIONS	15
BASIC OPERATION	17
Turning the Unit On/Off	
• Antenna Position	
• Receiving Signal Strength Indicator	
• Battery Level Indicator	
To Store a Number in Memory	
To Recall a Number from Memory	
To Review the Prefix	
Display Own Telephone Number	
Repertory Memory Scroll	
Automatic Storing into a Vacant Memory Address	
To Lock the Unit	
To Unlock the Unit	
Volume Control	

PLACING TELEPHONE CALLS	20
To Place a Call	
If the Call Fails to Go Through	
Automatic Redial (NAM Option)	
Terminating a Call	
To Receive Calls	
Silent Incoming Calls	
Any Digit Key Answering	
Automatic Answering	
Anti Fraud Security Feature	
To Place a Call with a Number in the Memory	
Speed Dialing	
Last Number Redial	
Programmable Emergency Call (NAM Option)	
One Touch Emergency Call	
To Mute a Phone Conversation	
ONE TOUCH DIALING	25
To Store a Number into One Touch Memory	
To Place a Call to a Number in One Touch Memory	
END-TO-END SIGNALING	26
SCRATCH-PAD DIALING	26
SCRATCH-PAD DIALING	
WITHOUT KEYING TONES	26
CALL TIME DISPLAY	27
To Display the Talk Time	
Outgoing Call Timer Only (NAM Option)	
To Clear the Timer	

SID MANAGEMENT (NAM OPTION)	28
A/B SYSTEM SELECTION	28
MULTIPLE CITY REGISTRATION	29
LAST RESCAN SID INDICATOR	30
AUTOMATIC CALLS IN ABSENCE	
INDICATOR	30
IMPORTANT SAFETY INFORMATION	31
WARNING	31

AUDIOVOX MVX 430 HANDHELD PORTABLE CELLULAR TELEPHONE

Congratulations... You have just purchased one of the most advanced, yet simple to use handheld cellular telephones in the market today. Your new MVX-430 allows you the freedom to enjoy the benefits of cellular communications without the limitations.

It has been built to the same exacting level of high engineering standards that has made the Audiovox cellular telephone line a top rated brand in the industry.

The Audiovox MVX-430 is packed with advanced features that provide the ultimate in convenience and safety, like one touch emergency dialing, a constant signal strength and battery life indicator and an anti-fraud security feature.

It also features "Any Digit Key Answer" that allows you to answer a call by pressing any of the numbered keys on the keypad. For ease of operation, the MVX-430 has been designed with a feature menu printed directly on the key pad. By simply pressing the green function button and the feature you wish to access, your desired function is complete. It's that simple!

Optional accessories include a desk top charger, a slim profile battery and an earphone microphone for hands free use. A cigarette lighter charger, leather carrying case and battery eliminator are also available.

And of course, your new Audiovox MVX-430 comes with something only an Audiovox phone can provide. The proven reliability that has made Audiovox one of the world's leading suppliers of cellular communications equipment.

SYSTEM CONFIGURATION

System configuration and the equipment list are as shown below.

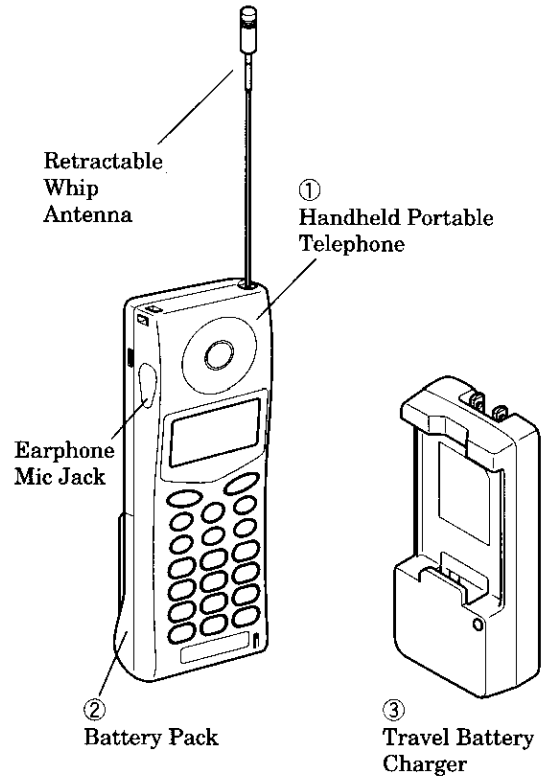

List of Equipment

No.	Name of the Equipment
①	Handheld Portable Telephone
②	Battery Pack (BTE-700)
③	Travel Battery Charger (TRC-700B)

WRIST STRAP ATTACHMENT (OPTION)

Attach the wrist strap WS700 (option) to the unit through the strap hole as shown below ①.

Then put the long loop through the smaller loop as shown below ②.

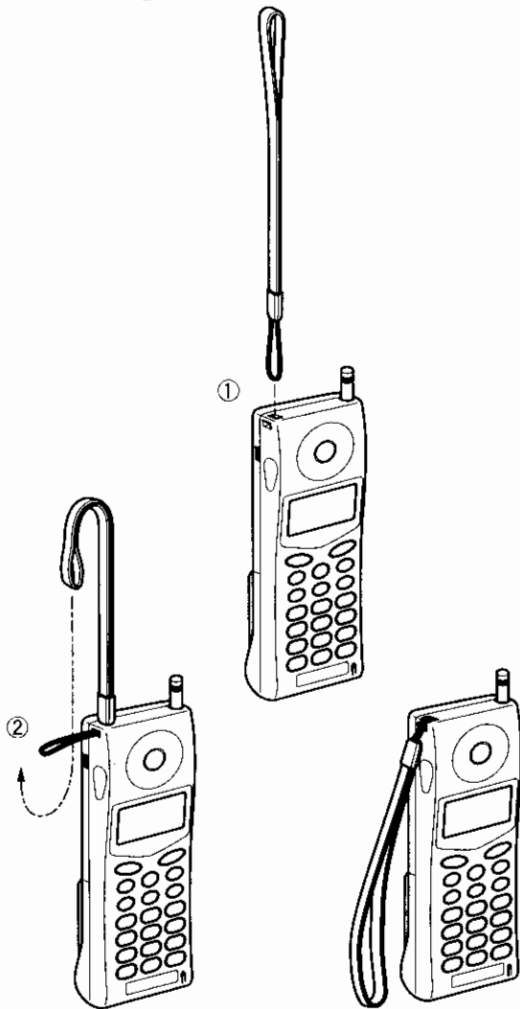

7

BATTERY INSTALLATION AND RECHARGING

The Portable Telephone contains a Detachable Battery Pack (BTE-700). Fully charged Battery Pack offers approximately 140 minutes Talk Time or 23 hours standby. It is recommended to carry one fully charged spare Battery Pack for longer operation. (Additional Battery Packs may be purchased at your Cellular Telephone Dealer.)

To Attach the Battery Pack

- ① Insert the hook at the end of the Battery Pack into the slot at the end of the unit.
- ② Press the Battery Pack down to lock the Battery Pack onto the unit.

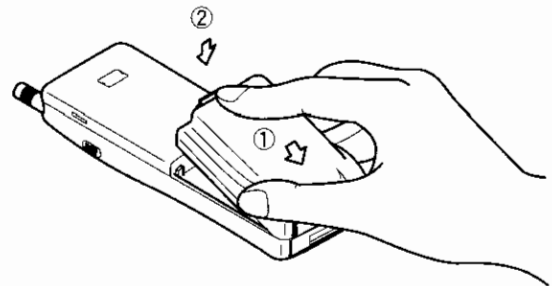

To Detach the Battery Pack

- ① Press the Release Latch as shown below.
- ② Lift up to remove the Battery Pack from the unit gently.

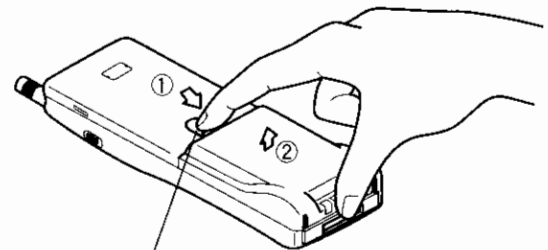

Release Latch

8

To Recharge Battery

The Travel Battery Charger (TRC-700B) can recharge the Standard Battery (BTE-700) in 10 hours or the optional Slim Battery (BTR-700) at 6 hours respectively.

1. Set the Battery Pack

- ① Holding the Travel Battery Charger in your hand, insert the Battery Pack into the Travel Battery Charger.
- ② Press the Battery Pack down to lock the Battery Pack onto the Travel Battery Charger.

2. Flip up the blades on the back side of the Travel Battery Charger and plug into AC outlet. The LED (Light Emitting Diode) on the Travel Battery Charger will light red while recharging.

The light will shut off when charging is complete.

Note: (1) Environmental temperature for full battery recharging with fixed time: 0~+35°C

- (2) We recommend you to set the Battery Pack in to the Travel Battery Charger and plug into AC outlet as shown below.

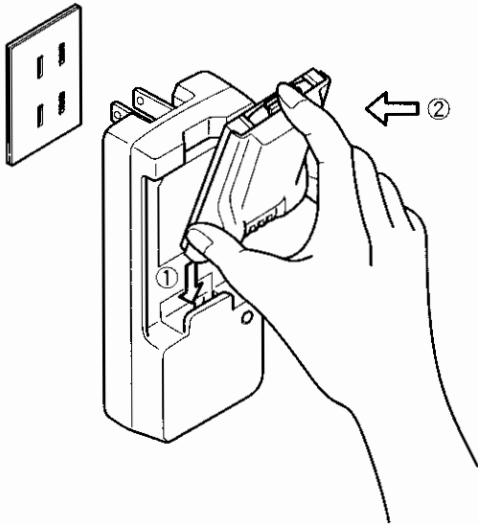

3. After recharging has been finished, unplug from AC outlet and take off the Battery Pack so as not to reduce the life and capacity of the Battery Pack.

- ① Unplug from AC outlet by holding the top of Travel Battery Charger as shown below.

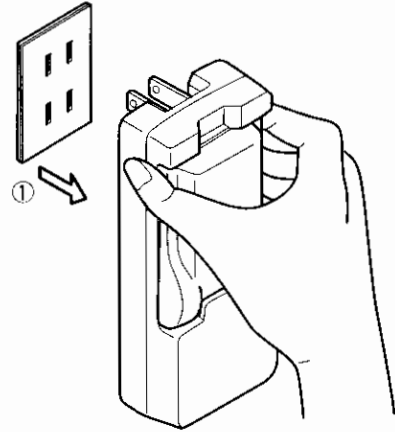

- ② Holding the Travel Battery Charger with your hand, and then press the Release Latch as shown below.

- ③ Lift up to remove the Battery Pack from the Travel Battery Charger gently.

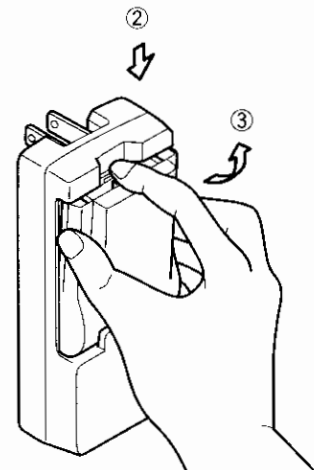

IMPORTANT SAFETY INSTRUCTIONS for Travel Battery Charger

1. **SAVE THESE INSTRUCTIONS** - This manual contains important safety and operating instructions for battery charger.
2. Before using battery charger, read all instructions and cautionary markings on (1) battery charger, (2) battery, and (3) product using battery.
3. **CAUTION** - To reduce risk of injury, charge only Ni-MH type rechargeable batteries. Other types of batteries may burst causing personal injury and damage.
4. Do not expose charger to rain or snow.
5. Use of an attachment not recommended or sold by the battery charger manufacturer may result in a risk of fire, electric shock, or injury to persons.
6. An extension cord should not be used unless absolutely necessary. Use of improper extension cord could result in a risk of fire and electric shock. If extension cord must be used, make sure:
 - a. That pins of plug of extension cord are the same number, size, and shape as those of plug on charger;
 - b. That extension cord is properly wired and in good electrical condition; and
 - c. That wire size is large enough for AC ampere rating of charge.
7. Do not operate charger with damaged plug - replace charger immediately.
8. Do not operate charger if it has received a sharp blow, been dropped, or otherwise damaged in any way; take it to an authorized Audiovox cellular service center.
9. Do not disassemble charger; take it to an authorized Audiovox cellular service center when service or repair is required. Incorrect reassembly may result in a risk of electric shock or fire.
10. To reduce risk of electric shock, unplug charger from outlet before attempting any maintenance or cleaning.

PRECAUTIONS

Your Handheld Portable Telephone is a high quality piece of equipment. Before operating the equipment, please take the following precautions.

1. Don't use this equipment in an extreme environment where high temperature or high humidity exists.
2. Don't abuse the equipment. Avoid striking, shaking or shocking. When not using the unit, lay down the unit to avoid possible damage due to instability.
3. Don't expose this equipment to rain or spilled beverages.
4. Recharge the battery fully before your first use of the unit.
5. When the battery becomes discharged, two beep tones will be heard every 10 seconds, and the battery level indicator B ■■■ will be flashing. In such a case, replace the battery with a fully charged one, and recharge the discharged battery.
6. To ensure long battery life, operate the unit until the battery level indicator B ■■■ flashes, then recharge the battery. Remove Battery Pack from the unit when it is not expected to be used for a long period. Recharging at least once every month is recommended when not being used.
7. Don't charge the Battery in an area with direct exposure to sunlight.



The product that you have purchased contains a rechargeable Battery. The Battery is recyclable. At the end of its useful life, under various state and local laws, it may be illegal to dispose of this Battery into the municipal waste stream. Check with your local solid waste officials for details in your area for recycling options or proper disposal.

GENERAL SPECIFICATIONS

(Subject to change without notice)

Frequency Range : 824 to 849 MHz, Transmit
869 to 894 MHz, Receive

Number of RF Channels : 832, Full Duplex

Channel Spacing : 30 KHz

Duplex Spacing : 45 MHz

Frequency Stability : ± 2.5 PPM

RF Output Power : 0.6W ERP With Power
Control

Receiver Sensitivity : -116 dBm (12 dB SINAD)

Modulation/Demodulation : Voice PM (With Componder)
Data FM

Operating Temperature : -20°C to $+60^{\circ}\text{C}$

Supply Voltage : 4.8 V
(NiMH Battery 1.2V \times 4,
1200 mA(H))

Current Drain : In Use;
Approx. 500 mA
Standby;
Approx. 50 mA

Operating Time : Talk;
Approx. 140 min.
(at full power output)
Standby;
Approx. 23 hours

Size : Approx.
25(H) \times 53(W) \times 160(D) mm
0.96(H) \times 2.1(W) \times 6.3(D) inch

Weight : Approx. 260 gr (9.2 oz)

FEATURES AND OPTIONS

- Push Button Dialing
- Large Size LCD Display
 - Status/Function Indicator
 - 8 Digits Dial Number
 - Receiving Signal Strength Indicator
 - Battery Level Indicator
- (Electronic) Volume Control
- Pre-set Dialing up to 32 Digits
- Extended Readability (Prefix Review)
- Last Digit Clear
- Digit Display Clear
- Programmable Emergency Call (NAM Option)
- One Touch Emergency Call
- Repertory Dialing: 32-Digit 30 Memories
- Speed Dialing
- Repertory Memory Scroll
- Automatic Storing into a Vacant Memory Address
- One Touch Dialing
- Any Digit Key Answering
- Automatic Answering
- Anti Fraud Security Feature
- Last Number Redial
- Automatic Redial (NAM Option)
- Mute
- Scratch-pad Dialing (with/without Keying Tones)
- End-to-End Signaling
- Continuous DTMF from Keypad
- Silent Incoming Calls
- Call Time Display
- Automatic Calls in Absence Indicator
- Display Own Telephone Number
- Multiple A/B System Selection
- SID Management (NAM Option)
- Multiple City Registration
- Last Rescan SID Indicator
- Electronic Lock

FUNCTIONS

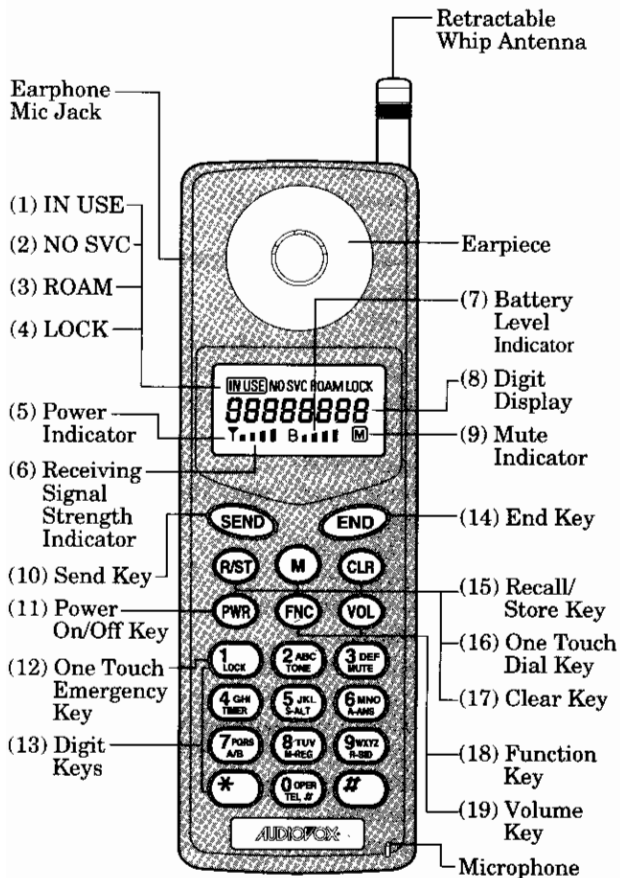

- (1) **IN USE** indicator lights when a call is in progress.
 - (2) **NO SVC** (no service) indicator lights when the unit is in a non-coverage area.
 - (3) **ROAM** indicator lights when the unit is out of the home area.
 - (4) **LOCK** indicator lights when the unit is locked.
 - (5) **[P]** is used as a POWER ON indicator which lights when the unit is turned on.
 - (6) **RECEIVING SIGNAL STRENGTH INDICATOR:** The number of shaded blocks indicates the Receiving Signal Strength.
 - (7) **B ■■■■** is used as a battery level indicator.
 - (8) **8-CHARACTER FUNCTIONAL DIGIT DISPLAY:** The remaining character show the last digits of the dialed number.
 - (9) **[M]** informs that the microphone has been switched off.
 - (10) **[SEND]** (send key) is used for placing or receiving a call.
 - (11) **[PWR]** (power on/off key) is used to turn on/off the unit.
 - (12) **[1]** One Touch Emergency key.
 - (13) **DIGIT KEYS** to enter a phone number.
 - (14) **[END]** (end key) terminate a call.
 - (15) **[R/ST]** (recall/store key)
 - To recall phone numbers from repertory memory, press **[R/ST]**.
 - To store phone numbers in repertory memory, press **[FNC] [R/ST]**.
 - (16) **[M]** (one-touch key) allows you to place a call with a single key stroke.
 - (17) **[CLR]** (clear key) clears the digit(s) from the display.
 - (18) **[FNC]** (function key) shifts the digit keys to the functional keys.
 - (19) **[VOL]** (volume key) is used to control Earpiece audio level as well as the Alert Tone.
- Earphone Mic Jack is used for handsfree operation with EM-425 Earphone Mic (option).

BASIC OPERATION

Turning the Unit On/Off

Press **ON** for about one second to turn on the unit. All the indicators and digit display will light momentarily, and a tone will be heard. The indicator **ON** will stay while the unit is turned on. Press **ON** again for about one second to turn off the unit.

• Antenna Position

Your portable cellular telephone is equipped with a dual position antenna system.

This dual position antenna has been especially designed to allow your phone to receive calls while the antenna is down. However, for optimum performance and signal strength or while operating in poor signal areas, it is recommended that the antenna be fully extended.

Note: The antenna can be used in its fully extended or fully retracted position only.

• Receiving Signal Strength Indicator (RSSI)

The number of shaded blocks indicates the Signal Strength in your area. Four blocks show the maximum level. The display will vary as you move with the unit. If the signal is not strong enough to place a call, the **NO SVC** indicator will appear on the readout.

• Battery Level Indicator

You can always monitor the current battery voltage level with the constant battery level indicator. The number of blocks indicates the battery conditions as follows:

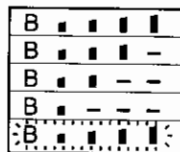

Full charge
Normal phone call
Short phone call
Recharge battery
(Flashing is discharged)

To Store a Number in Memory

1. Press **MEM**, then enter the phone number.
2. Press **FNC**, **RST**, then enter the memory address (01 through 30)

Example: Press **FNC**, **RST**, key **15** then **15**, the displayed number will be stored into memory address 15.

To Recall a Number from Memory

Press **MEM**, then enter the memory address (01 through 30).

Example: Press **MEM**, key **15** then **15**, the number stored in memory address 15 will be displayed on the readout.

To Review the Prefix

(Number longer than 8 digits)

After pressing **MEM**, hold down the second digit of the memory address.

Display Own Telephone Number

You can see your system ID number and your own phone number on the readout. Press **FNC**, key **MEM**. Your system ID will be displayed while the key **MEM** is held down.

Repertory Memory Scroll

This feature is useful in finding a certain phone number by scrolling the repertory memory from one of the designated starting addresses.

1. Press **MEM**, key **X** then **MEM**.
X is the digit to assign the starting address as follows.

X	Starting address
0	01
1	11
2	21

2. Press **UP** or **DOWN**.
UP: Scroll upward (with roll back to 01)
DOWN: Scroll downward (with roll up to 30)
Memory address and the last 5 digits of the stored number will be displayed on the readout as follows.

Example: **30-12345**

Address No. Tel. No.

Note: In this scroll feature, any vacant memory address(es) will be skipped.

Automatic Storing into a Vacant Memory Address

This feature allows automatic storing into a vacant repository memory address. This ends the possible problem of writing over a previously stored number.

1. Enter the phone number.
2. Press **FUNC**, key **VS1**, then **#**.
3. The number will be stored automatically to the memory address of the smallest number among the available vacant locations. The memory address and the last 5 digits of the stored phone number will be displayed on the readout as follows.

Example:

3	0	-	1	2	3	4	5
---	---	---	---	---	---	---	---

Note: If there is no vacant address, the phone number will not be stored in the memory.

To lock the Unit

Press **FUNC**, then key **L** (LOCK).

The **LOCK** indicator lights. The unit will remain locked until unlocked, even if the power is turned off.

To Unlock the Unit

Enter the three-digit unlock code. The **LOCK** indicator will go out when the three-digit code is the same as the code registered in the NAM.

Volume Control

The audio level of the earpiece and the alert tone can be adjusted by the Volume Control Key **VOL**.

• Earpiece:

Keep pressing **VOL** until you get the desired sound level. Sound level will be displayed on the readout digitally during the level adjustment and the sample tone will indicate the sound level when you are not engaged in a telephone conversation. The display format is as follows.

H	-	5	X		
---	---	---	---	--	--

(X = 1~5)

• Alert Tone:

Press **FUNC**, **VOL** key. Then adjust the alert tone level in the same manner as above. Your telephone will ring at the new level. In this case, the display format is as follows.

R	L	5	X		
---	---	---	---	--	--

(X = 1~5)

PLACING TELEPHONE CALLS

To Place a Call

1. Enter the phone number. The last 8 digits of the dialed number are displayed on the readout.
2. If a dialing error is made, press **CLR**, then enter the phone number again. Pressing **CLR** momentarily (less than approx. 0.5 sec.) clears only the last digit.
3. Press **SEND**. The **INUSE** indicator will light. When the called party answers, proceed with your conversation.

If the Call Fails to Go Through

1. If you hear the "reorder" signal, press **END**, then if there were no dialing errors, press **SEND** for redial. (Redialing with digit keys is not necessary.)
2. If the "intercept" signal is heard, press **END** then redial the correct number.

Automatic Redial (NAM Option)

If the feature of Automatic Redial (NAM Option) is selected, your unit will automatically make seven attempts to reach the cell site when the first try is not successful.

The **INUSE** indicator will stay on, but the speaker will be muted for thirty seconds. This is done so that you do not hear the reorder signals out of the speaker. If you need to terminate the automatic redial, press **END**.

Terminating a Call

Press **END** and the **INUSE** indicator will go out.

To Receive Calls

1. When the telephone rings, press **SEND** to answer the call. The **INUSE** indicator will light.

Silent Incoming Calls

If Silent Alert feature is set, a single beep and a flashing **[CRL]** message on the display will alert you of an incoming call.

Once you have switched to silent alert, the phone stays in that mode until you deactivate it.

1. Press **[FNC]**, then **[*]**. The **[5-RLE] [OFF]** will appear in the display.
2. When you receive a call, a single beep and a flashing **[CRL]** message on the display will alert you.
3. Press **[SEND]** to answer the call. **[CRL]** on the readout will go out.
4. This mode is deactivated by pressing **[FNC]**, then **[*]**. **[5-RLE] [OFF]** will be displayed for 5 seconds.
5. If the Silent Incoming Calls is activated when the unit is powered up, **[5-RLE] [OFF]** will appear on the readout for 5 seconds.

Any Digit Key Answering

This feature permits you to answer an incoming call by pressing any of the digit keys on the key pad.

Automatic Answering

With this feature, the incoming call will be automatically connected for operation after two alert tones, and the **[INUSE]** indicator will light on the readout. Then the unit is ready for conversation.

1. To activate this mode, press **[FNC]** and then key **[*]**. **[R-RN5] [OFF]** will appear on the readout.
2. This mode is deactivated when **[FNC]** and then key **[*]** are pressed again. **[R-RN5] [OFF]** will be displayed for 5 seconds.
3. This feature will not function if the unit is in the Lock and Silent Incoming Calls.
4. If the Automatic Answering is activated when the unit is powered up, **[R-RN5] [OFF]** will appear on the readout for 5 seconds.

Anti Fraud Security Feature

Your new Audiovox Cellular telephone has been engineered with the latest technology to help protect from the fraudulent use of your cellular telephone number.

Cellular fraud most often occurs by cellular thieves using electronic devices that can read your unique cellular phone number and your phone's electronic serial number (E.S.N.). This information can then be programmed into another phone for fraudulent use.

Certain cellular systems provide for an ANTI-FRAUD security feature to help protect the unauthorized use of your cellular telephone number. This feature utilizes a special personal identification number (PIN).

Should your cellular carrier offer this enhanced service, your new phone must be programmed with a PIN chosen by you. For your protection, you cannot make any outgoing calls until you have established your PIN. To establish your PIN, please contact your cellular service provider for specific instructions.

To place a call using PIN security feature

1. Enter the number you are calling by either dialing the number or recalling the number from a specific memory location.
2. Press the **[SEND]** key as your call is being processed the word PIN will appear in the display.
3. Press the **[SEND]** key again, your call will then be placed.

To turn the ANTI FRAUD feature on or off.

1. Enter your three digit security code.
2. Press the **[FNC]** key **[*]** then **[*] [4] [*]**.
3. Your PIN number and the on/off status will appear in the display.
4. Press the **[VOL]** key to turn the PIN entry feature on or off.
5. After you have entered the desired on or off status, press the **[FNC]** key then the **[CLR]** key.

To place a call with the PIN entry feature in one touch dialing

1. Press the **[*]** key for more than 0.5 seconds. The last eight digits of the number will appear in the display. As your call is being processed, the word PIN will appear on the display.
2. Press the **[*]** key again, your call will then be placed.

To Place a Call with a Number in the Memory

1. Press **(RST)**, then enter the memory address (01 through 30). The last 8 digits of the number will appear on the readout. If the number is longer than 8 digits, hold down the second digit of the memory address (after pressing **(RST)**) to see the prefix.
Note: See "To Recall a Number from Memory" and "To Review the Prefix" for more details.
2. Press **(SEND)**. The **(INUSE)** indicator will light as the call is placed.

Speed Dialing

This feature permits you to place a call from the stored memory locations without using the recall **(RST)** key. Speed dialing is a quick method of placing calls from memory.

1. Enter the one or two digits of memory address (1 through 9 and 10 through 30).
2. Press **(SEND)**. The last 8 digits of the phone number will appear on the readout, and the **(INUSE)** indicator will light.

Last Number Redial

This feature permits you to redial any of the last phone numbers you attempted to call.

Numbers will be stored in memory only if **(SEND)** key is pressed.

1. Press **(RST)**, **(*)** then **(#)**.

2. Press **(SEND)** to send a displayed number.

Note: To clear the stored number, press **(CLR)**, then **(SEND)**.

Programmable Emergency Call (NAM Option)

This feature permits you to place a call to two emergency numbers (maximum of 7 digits) even if your telephone has been locked.

The two emergency numbers must be pre-programmed in the NAM.

Note: 911 is preset emergency number. (you may change this number if you wish.)

Operation in Lock Mode

1. Enter the emergency call number (911); **(RST)** **(Lm)** **(Lm)** ("911" does not indicate, but the **(LOCK)** indicator will light.)
2. Press **(SEND)**, the **(INUSE)** indicator will light.
To terminate the call, press **(END)**.
(The **(INUSE)** indicator will go out.)

One Touch Emergency Call

This feature permits you to place a call to an emergency number by a single key stroke, even when the unit is in lock mode. You can deactivate this feature to prevent unintentional call by mistake.

1. Press key **(Lm)** for more than 2 seconds. The first emergency number that is pre-programmed in the NAM will be displayed, and **(INUSE)** indicator will light as a call is placed. The factory pre-set number is 911.
2. If you wish to deactivate this feature, press the following key sequence.

(X|Y|Z) **(FMC)** **(*)** **(RST)** **(Lm)** (XYZ is Security Code)

To activate this feature again, follow the same key sequence.

When this mode is ON :

E	-	L	R	L	o	n
---	---	---	---	---	---	---

OFF :

E	-	L	R	L	o	F
---	---	---	---	---	---	---

See also Programmable Emergency Call.

To Mute a Phone Conversation

1. Press **[MUTE]**, then key **[MUTE]**. **[M]** (Mute indicator) will appear on the readout. The transmit audio will be muted and the receive audio will be heard from the receiver.
2. To return to normal conversation: Press **[MUTE]**, then key **[MUTE]** again.
3. Mute is reset when the call is terminated.



When this mode is ON: Turned ON

When this mode is OFF: Turned OFF

ONE TOUCH DIALING

This feature permits you to place a call by a single key stroke.

To Store a Number into One Touch Memory

1. Press **[CL]**, then enter a phone number.
2. Press **[FNC]**, **[RST]**, the One Touch Key **[M]**.

Stored numbers can be reviewed by pressing **[RST]**, then the One Touch Key you want to review.

To Place a Call to a Number in One Touch Memory

Press the One Touch Key for approx. 0.5sec.

The last 8 digits of the number will be displayed on the readout, and the **[INUSE]** indicator will light as a call is placed.

END-TO-END SIGNALING

This feature permits you to utilize additional phone services, such as accessing an alternate long distance network, signaling pager, or banking by phone etc.. For these services the signaling should be in DTMF (Touch Tone™).

SCRATCH-PAD DIALING

This feature permits you to enter a number to be redialed (or store a number in memory) while engaged in a conversation.

SCRATCH-PAD DIALING WITHOUT KEYING TONES

This feature permits you to activate scratch-pad memory without annoying key tones over the circuit.

1. Press **[MUTE]**, then key **[MUTE]**, then enter a phone number.

t	a	n	e	o	f
---	---	---	---	---	---

 will be displayed for 5 seconds. The Microphone circuit will remain active, but the tones will not be heard.
2. If necessary, press **[FNC]**, **[RST]**, then enter the memory address.
3. To exit the Scratch-pad Mode, press **[MUTE]**, then key **[MUTE]** again.

t	a	n	e	o	n
---	---	---	---	---	---

 will be displayed for 5 seconds.

CALL TIME DISPLAY

This feature automatically records the elapsed time per conversation. The talk time of the last call and cumulative talk time can be displayed on the readout. The timers can also be cleared if necessary.

To Display the Talk Time

1. Press **FUNC**, then key **1**.
2. While the key **1** is held down, the cumulative talk time will be displayed on the readout in minute format.

1 8 1 ... 18 min.

3. The talk time of the last call will be displayed on the readout for 5 seconds after the **1** is released. While in a conversation, the talk time of a call in progress will be displayed. The display format is as follows.

0 1 ' 2 5 ... 1 min. and 25 sec.

Outgoing Call Timer Only (NAM Option)

Normal call timer operation is to time both the calls made and the calls received. If the "outgoing call timer only" function is activated (NAM Option), the call timer will only amount of time when placing calls. It will not amount of time for calls received.

To Clear the Timer

1. Press **END**, then enter the three-digit security code.
2. Press **FUNC**, key **1** then **1**, **1**. 0 0 0 0 1 will be displayed for 5 seconds. The timers will be cleared, and the count for the cumulative talk time will start from zero.

SID MANAGEMENT (NAM OPTION)

This feature enables you (by NAM option) to take advantage of the family of SID groups. This is a group of cellular systems in cities that your carrier owns or has special billing arrangements with. Your close family SID's (like brothers and sisters) will be billed at the same rate as your home billing and will be indicated as "Home" (i.e. both **NO SVC** and **ROAM** are off) on your display. More distant family SID's (like cousins) that your cellular service provider has roaming agreements with will be displayed as a solid **ROAM**. When flashing **ROAM** is displayed, you are using a SID system that is not included in the NAM assigned groups.

If your display indicates flashing **NO SVC**, you will need to change your A/B switch selection or, please refer to Multiple City Registration to change phone registration to enable you to make a call.

If in question as to what SID (system identification) you are using, push **FUNC**, **END** to display the current SID.

A/B SYSTEM SELECTION

This feature permits you to select the system you need to use. The system that you are registered with is the preferred system, and your home system.

When you turn the unit on, the unit remembers the last position of the A/B system selected, and will start to scan the radio frequency channels of that selection.

1. Press **FUNC**, key **1**. The current mode will be displayed.
2. You can change the current mode by pressing

↑ or **↓**.

↑: Scroll upward

↓: Scroll downward

S k d : Standard Mode

H - 5 5 5 : Home Only Mode

P - 5 5 5 : Preferred System Only Mode

n P - 5 5 5 : Non-preferred System Only Mode

- **Standard Mode**
The unit will scan the preferred system channels. If unable to find an acceptable preferred channel, the unit switches to scan the non-preferred channels.
- **Home Only Mode**
You can place or receive calls only within your home area.
- **Preferred System Only Mode**
The unit will scan the preferred system only and prevents switching over to the non-preferred system.
- **Non-preferred System Only Mode**
The unit will scan the non-preferred system only.

MULTIPLE CITY REGISTRATION

Some cellular users find it beneficial to register their phone in multiple cities, rather than rely on "roam". The multiple city registration feature permits you to reprogram from the telephone unit, the different phone numbers for the cities in which you are registered. Each programmed phone number will be designated as your home system.

Press **[M]**, and enter the new system ID number (5 digits) followed by the corresponding phone number (10 digits). Please include your area code. You must register your unit with the carrier in order to get both the system ID number and your phone number.

Press **[M]** then key **[*]**. Your new phone number will be displayed on the readout. (Holding down **[*]**, to display your new system ID number.)

- Note: (1) System ID number and phone number can not be programmed during a call.
(2) Calls are placed or received using only the programmed phone number, in use at the time of call.

LAST RESCAN SID INDICATOR

This feature permits you to recall the last system identification accessed by your phone.

Press **[M]**, then **[*]**.

The last rescan SID is displayed on the readout for 5 sec. The display format is as follows:

i	d	-	X	X	X	X	X
---	---	---	---	---	---	---	---

If the **[NOSVC]** indicator is on, the display will show

i	d	-	-	-	-	-	-
---	---	---	---	---	---	---	---

AUTOMATIC CALLS IN ABSENCE INDICATOR

This feature indicates the number of unanswered incoming calls. If incoming calls are unanswered, the unit will indicate the following.

C	R	L	L	X	X
---	---	---	---	---	---

[X] is the number of calls (01 to 99) missed. Depressing any key (other than the Power Key) will clear the number of calls indicated in Display. However, the number of calls will remain if the unit is turned off.

IMPORTANT SAFETY INFORMATION

Please read and follow these cautions carefully.

TURN OFF your unit in an explosive atmosphere (near a fuel pump, blasting area, etc.).

DO NOT dial when your unit is moving in states where this action is illegal (this is not a prudent practice, even where it is legal).

DO NOT permit untrained personnel to operate the unit.

DO NOT use unauthorized accessories.

DO NOT disassemble the phone or its accessories; If service or repair is required, return unit to an authorized Audiovox cellular service center. If unit is disassembled, the risk of electric shock or fire may result.

DO NOT open the battery case. If the battery is accidentally broken, avoid skin contact with the internal chemical contents. If there is skin contact, wash the affected area immediately and seek medical advice.

DO NOT short - circuit the battery terminals by metal items etc.

DO NOT have the battery left together with vehicle key or metal necklace, etc.

DO NOT put the battery close to, nor dispose it into fire.

WARNING

The following offences can be punished by fine, imprisonment, or both:

- Using obscene, indecent, or profane language.
- Using the unit to give off false distress calls.
- Wiretapping or otherwise intercepting a telephone call, unless that person has first obtained the consent of the parties participating in the call.
- Making anonymous calls to annoy, harass, or molest other people.
- Charging to an account without authorization to avoid payment for service.
- Refusing to yield a party line when informed that it is needed for an emergency call (It is also unlawful to take over a party line by stating falsely that it is needed for an emergency).

24 MONTH LIMITED WARRANTY

AUDIOVOX CORPORATION (the Company), warrants to the original retail purchaser of this Audiovox Handheld Portable Cellular Telephone, that should this product or any part thereof (except the items listed below), under normal use and conditions, be proven defective in material or workmanship within the first twenty-four (24) month period from the date of purchase, such defect(s) will be repaired or replaced (with new or rebuilt parts) at the Company's option, without charge for parts or labor directly related to the defect(s).

The keypad and display are similarly warranted for twelve (12) months from date of purchase.

The accessories consisting of the antenna and rechargeable battery pack, desk top battery charger, wrist strap are similarly warranted for only ninety (90) days from original purchase.

This Warranty does not apply to batteries, fuses, or costs incurred for testing or checking, or to any product or part hereof which has suffered through alteration, serial number defacement, improper installation, excessive temperature or humidity, environmental conditions, mishandling, misuse, neglect or accident. This Warranty is not assignable or transferable.

To obtain repairs or replacement within the terms of this Warranty, the product should be delivered with proof of warranty coverage, specification of defect(s), transportation prepaid, to the Company at the address shown below. For TRAVELERS WARRANTY SERVICE.

Call toll free to (800) 229-1235 (in N.Y. State, (516) 233-3410) for reference to an Authorized Warranty Station in your area.

THE EXTENT OF THE COMPANY'S LIABILITY UNDER THIS WARRANTY IS LIMITED TO THE REPAIR OR REPLACEMENT PROVIDED ABOVE AND, IN NO EVENT, SHALL THE COMPANY'S LIABILITY EXCEED THE PURCHASE PRICE PAID BY PURCHASER FOR THE PRODUCT.

The Company disclaims liability for geographic coverage, inadequate signal to antenna, communications range or operation of the Cellular System as a whole.

ANY IMPLIED WARRANTIES, INCLUDING ANY IMPLIED WARRANTY OF MERCHANTABILITY SHALL BE LIMITED TO THE DURATION OF THIS WRITTEN WARRANTY. ANY ACTION FOR BREACH OF ANY WARRANTY HEREUNDER INCLUDING ANY IMPLIED WARRANTY OF MERCHANTABILITY MUST BE BROUGHT WITHIN A PERIOD OF 36 MONTHS FROM DATE OF ORIGINAL PURCHASE. IN NO CASE SHALL THE COMPANY BE LIABLE FOR ANY CONSEQUENTIAL OR INCIDENTAL DAMAGES FOR BREACH OF THIS OR ANY OTHER WARRANTY, EXPRESS OR IMPLIED, WHATSOEVER.

No person or representative is authorized to assume for the Company any liability other than expressed herein in connection with the sale of this product.

Some states do not allow limitations on how long an implied warranty lasts or the exclusion or limitation of incidental or consequential damage so the above limitation or exclusions may not apply to you. This Warranty gives you specific legal rights, and you may also have other rights which vary from state to state.

IN U.S.A.: AUDIOVOX CORPORATION

185 Oser Avenue, Hauppauge,
New York 11788
(516) 233-3300

IN CANADA: AUDIOVOX CANADA LTD.

405 Britannia Road East,
Mississauga, Ontario L4Z3E6
(905) 712-9299

Audiovox Accessory Catalog

**MVX530/MVX560
MVX430/MVX460**

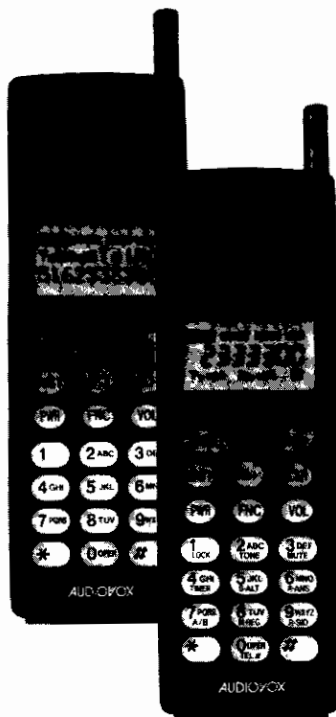



DTC700
Desk Top Charger

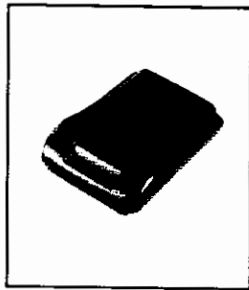

BTE700
Extended Life Battery
(Nickel Metal Hydride)



EM-425
Ear Phone
Microphone For
Hands Free Use



LB550
Leather Carrying Case

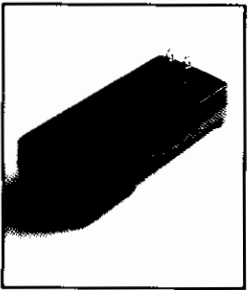

TRC700A/B
Travel Charger



BTR700
Standard Life Battery
(Nickel Metal Hydride)

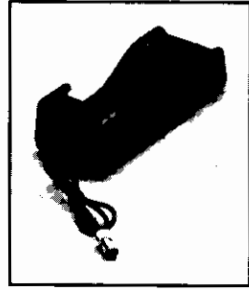

HF530
Hands Free Car
Adaptor Kit
(For MVX530/560)



BTE425
Extended Life NiCd Battery
(Cannot be Charged with
RC700)



RC700
Rapid Charger
(For BTE700/BTR700 only)



CLA700
Battery Eliminator

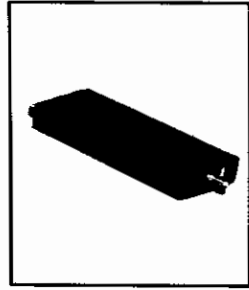

PBK530
3 Watt Power Booster
(For use with HF530)

PROTECT YOUR WARRANTY

Read your Warranty carefully, with the special consideration to paragraph seven of the Limited Warranty for your unit.

“Warranty does not apply to...or to any product or part thereof which has suffered through alteration... mishandling, misuse, neglect, or accident”.

Many companies are making look-alike accessories and in some cases, promoting that their product is equal to or better than the Audiovox product. Be careful. Some of these products may not be compatible for use with your Audiovox product and may damage the unit or cause it to malfunction. If service is required on your unit, and it is determined that a non-Audiovox accessory has created the problem with your unit, the Warranty will not apply. In addition, if the unit has already suffered irreversible damage by reason of a non-compatible accessory, the Warranty will be voided. To protect your Warranty, use only compatible accessories which cannot damage or interfere with the functioning of your Audiovox product.



AUDIOVOX CELLULAR COMMUNICATIONS
185 Oser Avenue, Hauppauge, NY 11788, 516-233-3300
16808 Marquardt Avenue, Cerritos, California 90701, 310-926-7758
405 Britannia Road, East Mississauga, Ont L4Z3E6 905-712-9299
AUDIOVOX PACIFIC PTY LTD.
15-17 Doyle Ave., Unanderra 2526 NSW Australia, 61-42-718555

Free Manuals Download Website

<http://myh66.com>

<http://usermanuals.us>

<http://www.somanuals.com>

<http://www.4manuals.cc>

<http://www.manual-lib.com>

<http://www.404manual.com>

<http://www.luxmanual.com>

<http://aubethermostatmanual.com>

Golf course search by state

<http://golfingnear.com>

Email search by domain

<http://emailbydomain.com>

Auto manuals search

<http://auto.somanuals.com>

TV manuals search

<http://tv.somanuals.com>