



185 Oser Ave., Hauppauge, NY 11788

PRINTED IN JAPAN 6-97

The logo for Audiovox Communications Corp. features a stylized graphic of three interconnected hexagons on the left. To the right of this graphic, the word "AUDIOVOX" is written in a bold, sans-serif font with a registered trademark symbol (®). Below "AUDIOVOX", the words "Communications Corp." are written in a smaller, italicized sans-serif font.

**AUDIOVOX®**  
*Communications Corp.*

**MVX-440/470/475**

**HANDHELD  
PORTABLE  
CELLULAR  
TELEPHONE**

**OWNER'S OPERATING  
INSTRUCTIONS**

# TABLE OF CONTENTS

<b>SAFETY INFORMATION FOR WIRELESS HANDHELD PHONES</b> ...	2
<b>PRECAUTIONS</b> .....	9
<b>SYSTEM CONFIGURATION</b> .....	10
<b>WRIST STRAP ATTACHMENT (OPTION)</b> .....	11
<b>BATTERY INSTALLATION AND RECHARGING</b> .....	12
To Attach the Battery Pack	
To Detach the Battery Pack	
To Recharge Battery	
<b>GENERAL SPECIFICATIONS</b> .....	16
<b>FEATURES AND OPTIONS</b> .....	17
<b>FUNCTIONS</b> .....	18
<b>BASIC OPERATION</b> .....	20
Turning the Unit On/Off	
• Antenna Position	
• Receiving Signal Strength Indicator	
• Battery Level Indicator	
To Store a Number in Memory	
To Recall a Number from Memory	
To Review the Prefix	
Display Own Telephone Number	
Repertory Memory Scroll	
Automatic Storing into a Vacant Memory Address	
To Lock the Unit	
To Unlock the Unit	
Volume Control	
<b>MEMORY NAME TAG</b> .....	25
To Enter Names using Alpha (Letters)	
To Store Name with Phone Number	
To Recall from Memory with Name	
<b>PLACING TELEPHONE CALLS</b> .....	27
To Place a Call	
If the Call Fails to Go Through	
Automatic Redial (Programmable Option)	
Terminating a Call	
To Receive Calls	
Silent Incoming Calls	
To Mute a Phone Conversation	
Any Digit Key Answering	
Automatic Answering	
Anti Fraud Security Feature	
To Place a Call with a Number in the Memory	
Speed Dialing	
Last Number Redial	
Programmable Emergency Call (Programmable Option)	
One Touch Emergency Call	
To Mute a Phone Conversation	
<b>VOICE MAIL DIALING</b> .....	33
To Store a Numbers	
To Place a Call	
<b>END-TO-END SIGNALING</b> .....	34
<b>SCRATCH-PAD DIALING</b> .....	34
<b>SCRATCH-PAD DIALING WITHOUT KEYING TONES</b> .....	34
<b>CALL TIME DISPLAY</b> .....	35
To Display the Talk Time	
Outgoing Call Timer Only (Programmable Option)	
To Clear the Timer	
<b>SID MANAGEMENT (PROGRAMMABLE OPTION)</b> ....	36
<b>A/B SYSTEM SELECTION</b> .....	36
<b>MULTIPLE CITY REGISTRATION</b> .....	37
<b>LAST RESCAN SID INDICATOR</b> .....	38
<b>AUTOMATIC CALLS IN ABSENCE INDICATOR</b> .....	38
<b>ENHANCED FEATURES*</b> .....	39
Caller ID*	
Voice Mail Notification*	
* ; Service Provider Dependant	
<b>WARNING</b> .....	42
<b>WARRANTY</b> .....	43
<b>ACCESSORY CATALOG</b> .....	46

# **AUDIOVOX MVX 440/470/475 Handheld Portable Cellular Telephone**

Congratulations... You have just purchased one of the most advanced, yet simple to use handheld cellular telephones in the market today. Your new Audiovox portable telephone allows you the freedom to enjoy the benefits of cellular communications without the limitations.

It has been built to the same exacting level of high engineering standards that has made the Audiovox cellular telephone line a top rated brand in the industry.

Your new Audiovox Cellular telephone has been engineered to support a number of enhanced services that may be offered by your cellular service provider. In order to take advantage of these special, enhanced services, you must subscribe to them through your home cellular service provider.

The Audiovox MVX440/470/475 is packed with advanced features that provide the ultimate in convenience and safety like one touch emergency dialing, a constant signal strength and battery life indicator, a voice mail access key and the most advanced anti-fraud security features in the industry.

It also features a multi function access key that allows for simplified storing and recalling of numbers in memory.

For ease of operation, the MVX440/470/475 has been designed with a feature menu printed directly on the key pad. By simply pressing the green function button and the feature you wish to access, your desired function is complete. It's that simple!

Optional accessories include a rapid charger, a slim profile battery and an earphone microphone for hands free use. A cigarette lighter charger, leather carrying case and battery eliminator are also available.

And of course, your new Audiovox MVX440/470/475 comes with something only an Audiovox phone can provide. The proven reliability that has made Audiovox one of the world's leading suppliers of cellular communications equipment.

## **SAFETY INFORMATION FOR WIRELESS HANDHELD PHONES**

**Read this information before using your Handheld portable Cellular Telephone.**

### **EXPOSURE TO RADIO FREQUENCY SIGNALS**

Your wireless handheld portable telephone is a low power radio transmitter and receiver. When it is ON, it receives and also sends out radio frequency (RF) signals.

In August, 1996, the Federal Communications Commissions (FCC) adopted RF exposure guidelines with safety levels for handheld wireless phones. Those guidelines are consistent with the safety standards previously set by both U.S. and international standards bodies:

ANSI C95.1 (1992)\*  
NCRP Report 88(1986)\*  
ICNIRP (1996)\*

Those standards were based on comprehensive and periodic evaluations of the relevant scientific literature. For example, over 120 scientists, engineers, and physicians from universities, government health agencies, and industry reviewed the available body of research to develop the ANSI Standard (C95.1).

The design of your phone complies with the FCC guidelines (and those standards).

\*;

American National Standards Institute;  
National Council on Radiation Protection and Measurements; International Commission on Non-ionizing Radiation Protection.

### **ANTENNA CARE**

Use only the supplied or an approved replacement antenna. Unauthorized antennas, modifications, or attachments could damage the phone and may violate FCC regulations.

## PHONE OPERATION

**Normal Position:** Hold the phone as you would any other telephone with the antenna pointed up and over your shoulder.

**Tips on Efficient Operation:** For your phone to operate most efficiently:

- Extend your antenna fully.
- Do not touch the antenna unnecessarily when the phone is in use. Contact with the antenna affects call quality and may cause the phone to operate at a higher power level than otherwise needed.

## DRIVING

Check the laws and regulations on the use of wireless telephones in the areas where you drive. Always obey them. Also, if using your phone while driving, please:

- Give full attention to driving -- driving safely is your first responsibility.
- Use hands-free operation, if available.
- Pull off the road and park before making or answering a call if driving conditions so require.

## ELECTRONIC DEVICES

Most modern electronic equipment is shielded from RF signals. However, certain electronic equipment may not be shielded against the RF signals from your wireless phone.

### Pacemakers.

The health Industry Manufacturers Association recommends that a minimum separation of six (6") Inches be maintained between a handheld wireless phone and a pacemaker to avoid potential interference with the pacemaker. These recommendations are consistent with the independent research by and recommendations of Wireless Technology Research.

Persons with pacemakers:

- Should ALWAYS keep the phone more than six inches from their pacemaker when the phone is turned ON.
- Should not carry the phone in a breast pocket.
- Should use the ear opposite the pacemaker to minimize the potential for interference.
- If you have any reason to suspect that interference is taking place, turn your phone OFF immediately.

## Hearing Aids

Some digital wireless phones may interfere with some hearing aids. In the event of such interference, you may want to consult your service provider [or call the customer service line to discuss alternatives.]

## Other Medical Devices

If you use any other personal medical device, consult the manufacturer of your device to determine if they are adequately shielded from external RF energy. Your physician may be able to assist you in obtaining this information.

## Vehicles

RF signals may affect improperly installed or inadequately shielded electronic systems in motor vehicles. Check with the manufacturer or its representative regarding your vehicle. You should also consult the manufacturer of any equipment that has been added to your vehicle.

## Posted Facilities

Turn your phone OFF in any facility where posted notices so require.

## AIRCRAFT

FCC regulations prohibit using your phone while in the air.

Switch OFF your phone before boarding an aircraft.

## **BLASTING AREAS**

To avoid interfering with blasting operations, turn your phone OFF when in a "Blasting area" or in areas posted "Turn off two-way radio". Obey all signs and instructions.

## **POTENTIALLY EXPLOSIVE ATMOSPHERES**

Turn your phone OFF when in any area with a potentially explosive atmosphere and obey all signs and instructions. Sparks in such areas could cause an explosion or fire resulting in bodily injury or even death.

Areas with a potentially explosive atmosphere are often but not always clearly marked. They include fueling areas such as gasoline stations: below deck on boats: fuel or chemical transfer or storage vehicles using liquefied petroleum gas (such as propane or butane): areas where the air contains chemicals or particles, such as grain, dust, or metal powders: and any other area where you would normally be advised to turn off your vehicle engine.

### **For vehicles Equipped with an Air Bag**

An air bag inflates with great force. DO NOT place objects, including both installed or portable wireless equipment, in the area over the air bag or in the air bag deployment area. If in-vehicle wireless equipment is improperly installed and the air bag inflates, serious injury could result.

## **PRECAUTIONS**

Your Handheld Portable Telephone is a high quality piece of equipment. Before operating the equipment, read all instructions and cautionary markings on (1) AC Adaptor (2) Battery and (3) Product using Battery.

1. DO NOT use this equipment in an extreme environment where high temperature or high humidity exists.
2. DO NOT abuse the equipment. Avoid striking, shaking or shocking. When not using the unit, lay down the unit to avoid possible damage due to instability.
3. DO NOT expose this equipment to rain or spilled beverages.
4. DO NOT use unauthorized accessories.
5. DO NOT disassemble the phone or its accessories; If service or repair is required, return unit to an authorized Audiovox cellular service center. If unit is disassembled, the risk of electric shock or fire may result.
6. DO NOT short-circuit the battery terminals by metal items etc.

## SYSTEM CONFIGURATION

System configuration and the equipment list are as shown below.

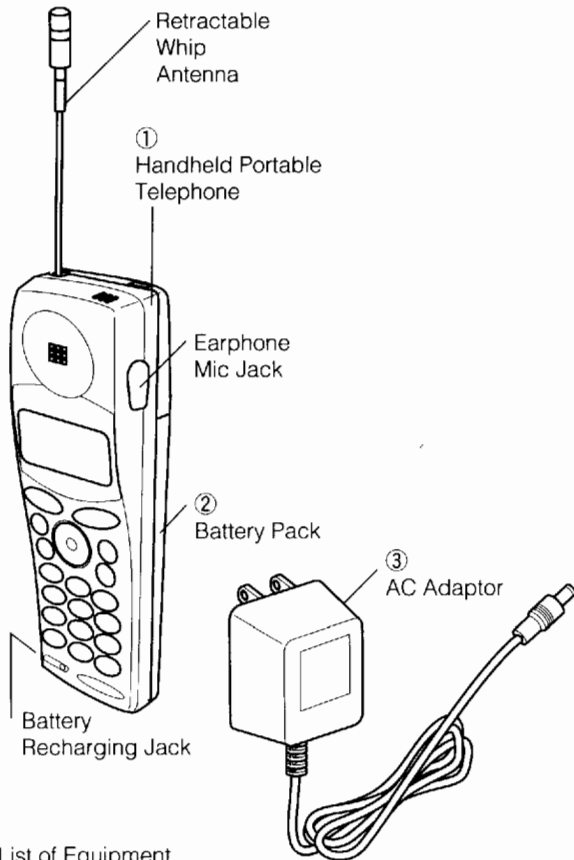

List of Equipment

No.	Name of the Equipment
①	Handheld Portable Telephone
②	Battery Pack (BTE-440)
③	AC Adaptor (CNR-440)

## WRIST STRAP ATTACHMENT (OPTION)

Attach the wrist strap WS700 (option) to the unit through the strap hole as shown below ①.

Then put the long loop through the smaller loop as shown below ②.

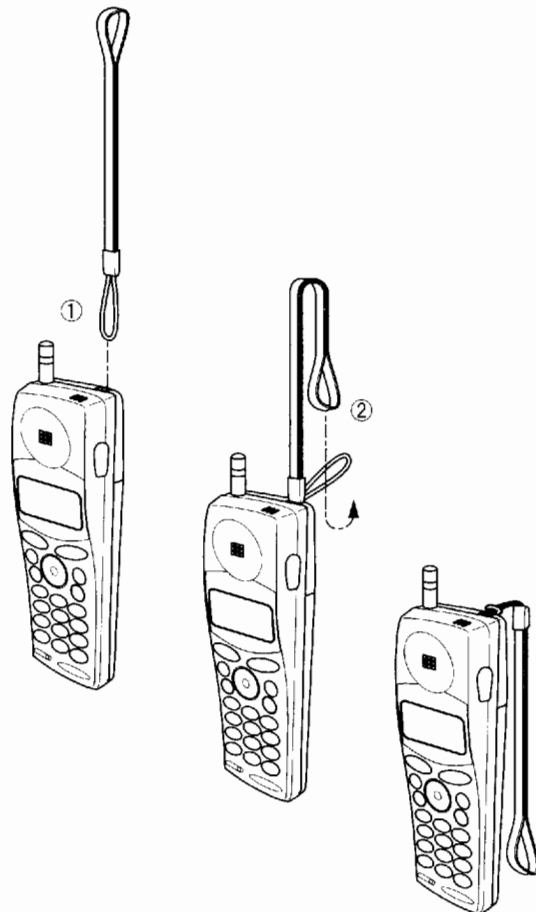

# BATTERY INSTALLATION AND RECHARGING

The Portable Telephone contains a Detachable Battery Pack (BTE-440). Fully charged Battery Pack offers approximately 140 minutes Talk Time or 28 hours standby. It is recommended to carry one fully charged spare Battery Pack for longer operation.

(Additional Battery Packs may be purchased at your Cellular Telephone Dealer.)

## To Attach the Battery Pack

- ① Insert the hook at the end of the Battery Pack into the slot at the end of the unit.
- ② Press the Battery Pack down to lock the Battery Pack onto the unit.

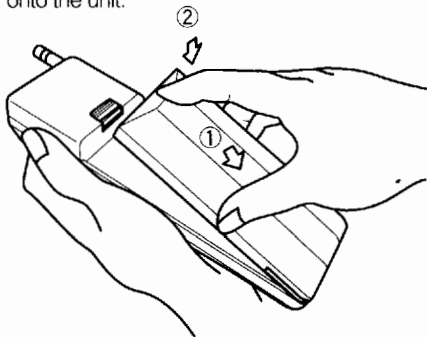

## To Detach the Battery Pack

- ① Slide back the Release Latch as shown below.
- ② Lift up to remove the Battery Pack from the unit gently.

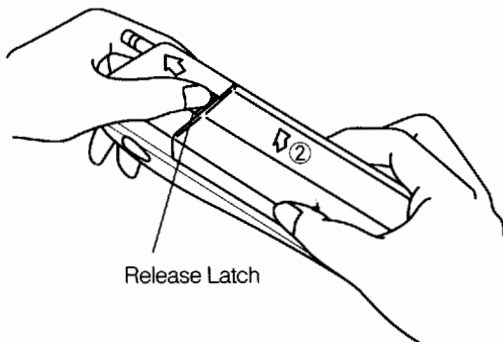

Release Latch

## To Recharge Battery

The AC Adaptor (CNR-440) can recharge the Standard Battery (BTE-440) in 10 hours or the optional Slim Battery (BTR-440) in 7 hours respectively.

1. Attach the Battery Pack to the Phone.
2. Set the AC Adaptor
  - 1) Insert the DC plug of the AC Adaptor into the Battery recharging jack on the phone.
  - 2) Plug the AC Adaptor into AC outlet.
3. Then Battery recharging will start.

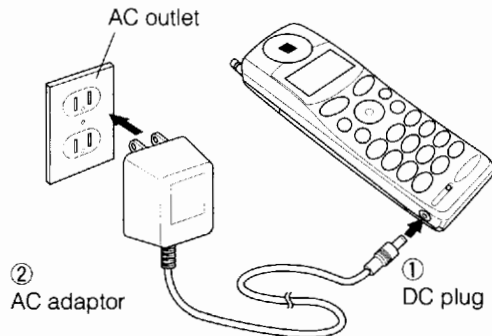

Note: For complete recharging, it is recommended that the phones' power is off while recharging the battery.

4. Battery charging Indication.
  - 1) While charging the battery, the battery life indicator will scroll on the readout and be displayed as shown below.

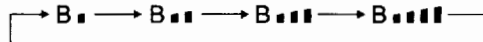

- 2) If the phone's power is off, "Charging" will appear in the readout during the battery Charging operation as shown below.

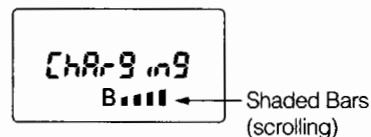

Shaded Bars (scrolling)

- 3) After all of the segments of the battery indicator stop scrolling, the battery is fully charged.
- 4) Environmental temperature for full battery recharging with fixed time: 0~+35°C
5. Disconnect the AC adaptor (battery charger) from the AC outlet and from the phone.
6. After recharging, battery pack may become a little warmer. However this is normal.
7. Recharge the battery fully before your first use of the unit.
8. When the battery becomes discharged, two beep tones will be heard every 10 seconds, and the battery level indicator **B ■■■■** will be flashing. In such a case, replace the battery with a fully charged one, or recharge the discharged battery.
9. To ensure long battery life, operate the unit until the battery level indicator **B ■■■■** flashes, then recharge the battery. Remove Battery Pack from the unit when it is not expected to be used for a long period. Recharging at least once every month is recommended when not being used.
10. DO NOT charge the Battery in an area with direct exposure to sunlight.
11. All batteries can cause property damage, injury or burns if a conductive material, such as jewelry, keys or beaded chains, touches exposed terminals. The material may complete an electrical circuit(short circuit) and become quite hot. Exercise care in handling any charged battery, particularly when placing it inside your pocket, purse, or other container with metal objects.
12. DO NOT open the battery case. If the battery is accidentally broken, avoid skin contact with the internal chemical contents. If there is skin contact, wash the affected area immediately and seek medical advice.

13. DO NOT put the battery close to, nor dispose it into fire.
14. Use of an attachment not recommended or sold by the AC adaptor manufacturer may result in a risk of fire, electric shock, or injury to persons.
15. An extension cord should not be used unless absolutely necessary. Use of improper extension cord could result in a risk of fire and electric shock. If extension cord must be used, make sure:
  - a. That plug of extension cord are the same number, size and shape as those of plug of AC adaptor.
  - b. That extension cord is properly wired and in good electrical condition.
  - c. That wire size is large enough for AC ampere rating of charge.
16. DO NOT operate AC adaptor with damaged plug. Replace AC adaptor immediately.
17. DO NOT operate charger if it has received a sharp blow, been dropped, or otherwise damaged in any way; take it to an authorized Audiovox cellular service center.
18. To reduce risk of electric shock, unplug charger from outlet before attempting any maintenance or cleaning.
19.  The product that you have purchased contains a rechargeable Battery. The Battery is recyclable. At the end of its useful life, under various state and local laws, it may be illegal to dispose of this Battery into the municipal waste stream. Check with your local solid waste officials for details in your area for recycling options or proper disposal.



## GENERAL SPECIFICATIONS

(Subject to change without notice)

Frequency Range : 824 to 849 MHz, Transmit  
869 to 894 MHz, Receive

Number of RF Channels : 832, Full Duplex

Channel Spacing : 30 KHz

Duplex Spacing : 45 MHz

Frequency Stability :  $\pm 2.5$  PPM

RF Output Power : 0.6W ERP With Power  
Control

Receiver Sensitivity :  $-116$  dBm (12 dB SINAD)

Modulation/Demodulation : Voice PM (With Compander)  
Data FM

Operating Temperature :  $-20^{\circ}\text{C}$  to  $+60^{\circ}\text{C}$

Supply Voltage : 4.8 V  
(NiMH Battery 1.2 V  $\times$  4,  
1200 mAh)

Current Drain : In Use;  
Approx. 500 mA  
Standby;  
Approx. 45 mA

Operating Time : Talk;  
Approx. 140 min.  
(at full power output)  
Standby;  
Approx. 28 hours

Size : Approx.  
27(H) $\times$ 52(W) $\times$ 160(D) mm  
1.1(H) $\times$ 2.1(W) $\times$ 6.3(D) inch

Weight : Approx. 250 gr (8.8 oz)

## FEATURES AND OPTIONS

- Push Button Dialing
  - Large Size LCD Display
    - Status/Function Indicator
    - 10 Digit Number Display
    - Receiving Signal Strength Indicator
    - Battery Level Indicator
    - Envelope Message Icon
  - (Electronic) Volume Control
  - Pre-set Dialing up to 32 Digits
  - Extended Readability (Prefix Review)
  - Last Digit Clear
  - Digit Display Clear
  - Programmable Emergency Call (Programmable Option)
  - One Touch Emergency Call
  - Repertory Dialing:32-Digit 30 Memories
  - Speed Dialing
  - Repertory Memory Scroll
  - Automatic Storing into a Vacant Memory Address
  - Voice Mail Dialing
  - Memory Name Tag
  - Any Digit Key Answering
  - Automatic Answering
  - Anti Fraud Security Feature
  - Last Number Redial
  - Automatic Redial (Programmable Option)
  - Mute
  - Scratch-pad Dialing (with/without Keying Tones)
  - End-to-End Signaling
  - Continuous DTMF from Keypad
  - Silent Incoming Calls
  - Call Time Display
  - Automatic Calls in Absence Indicator
  - Display Own Telephone Number
  - A/B System Selection
  - SID Management (Programmable Option)
  - Multiple City Registration
  - Last Rescan SID Indicator
  - Electronic Lock
  - Enhanced Features\*
    - Caller ID\*
    - Voice Mail Notification\*
- \*; Service Provider Dependant

# FUNCTIONS

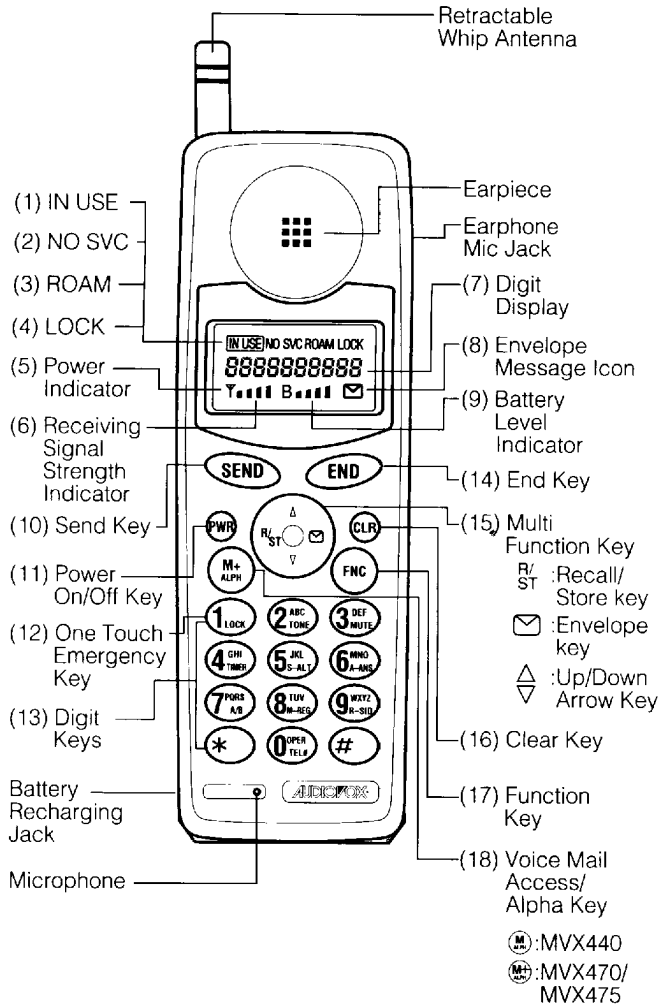

- (1) **IN USE** indicator lights when a call is in progress.
  - (2) **NO SVC** (no service) indicator lights when the unit is in a non-coverage area.
  - (3) **ROAM** indicator lights when the unit is out of the home area.
  - (4) **LOCK** indicator lights when the unit is locked.
  - (5) **Y** is used as a POWER ON indicator which lights when the unit is turned on.
  - (6) **RECEIVING SIGNAL STRENGTH INDICATOR:** The number of shaded blocks indicates the Receiving Signal Strength.
  - (7) **10-CHARACTER FUNCTIONAL DIGIT DISPLAY:** The remaining character show the last digits of the dialed number.
  - (8) **Envelope Message Icon** informs that there are messages and/or calling line ID numbers in the memory.
  - (9) **B** is used as a battery level indicator.
  - (10) **SEND** (send key) is used for placing or receiving a call.
  - (11) **PWR** (power on/off key) is used to turn on/off the unit.
  - (12) **1** One Touch Emergency key.
  - (13) **DIGIT KEYS** to enter a phone number.
  - (14) **END** (end key) terminates a call.
  - (15) **(Multi Function Key)**
    - a) **RV/ST** (Recall/Store Key)
      - To recall phone numbers from repertory memory, press **RV/ST**.
      - To store phone numbers in repertory memory, press **FNC**, **RV/ST**.
    - b) **e** (Envelope Key) is used for Voice Mail Notification and Caller ID.
    - c) **Δ** or **∇** (Up-arrow Key or Down arrow Key)
      - To control earpiece audio level, press **Δ** or **∇**.
      - To control alert tone level, press **FNC** **Δ** or **∇**.
  - (16) **CLR** (clear key) clears the digit(s) from the display.
  - (17) **FNC** (function key) shifts the digit keys to the functional keys.
  - (18) **Ⓜ+** (voice mail access / alpha key)
    - To access the linked speed dialing capability, press **Ⓜ+**.
    - To enter alphabetical characters, press **FNC** **Ⓜ+**.
- Earphone Mic Jack is used for handsfree operation with EM-425 Earphone Mic (option).

# BASIC OPERATION

## Turning the Unit On/Off

Press **(PWR)** for about one second to turn on the unit. All the indicators and digit display will light momentarily, and a tone will be heard. The indicator “**Y**” will stay while the unit is turned on. Press **(PWR)** again for about one second to turn off the unit.

### • Antenna Position

Your portable cellular telephone is equipped with a dual position antenna system.

This dual position antenna has been especially designed to allow your phone to receive calls while the antenna is down. However, for optimum performance and signal strength or while operating in poor signal areas, it is recommended that the antenna be fully extended.

Note: The antenna can be used in its fully extended or fully retracted position only.

### • Receiving Signal Strength Indicator (Y,■■■■)

The number of shaded blocks indicates the Signal Strength in your area. Four blocks show the maximum level. The display will vary as you move with the unit. If the signal is not strong enough to place a call, the **NO SVC** indicator will appear on the readout.

### • Battery Level Indicator

You can always monitor the current battery voltage level with the constant battery level indicator. The number of blocks indicates the battery conditions as follows:

B ■■■■■■	Full charge
B ■■■■	Normal phone call
B ■■■	Short phone call
B ■■	Recharge battery
B ■	(Flashing is discharged)

## To Store a Number in Memory

1. Press **(CLR)**, then enter the phone number.
2. Press **(FNC)**, **(ST)**, then enter the two digit memory address. (01 through 30).

**Example: To store the phone number 123-456-7890 in address 07.**

1. Press **(CLR)**.

2. Enter **(1)**, **(2)**, **(3)**, **(4)**, **(5)**, **(6)**, **(7)**, **(8)**, **(9)**, **(0)**.

3. Press **(FNC)**, **(ST)**.
4. Enter **(0)**, **(7)**.

**The displayed number will be stored into memory address 07.**

## To Recall a Number from Memory

Press **(ST)**, then enter the two digit memory address (01 through 30)

**Example: To recall the phone number in address 07.**

1. Press **(ST)**.
2. Enter **(0)**, **(7)**.

Note: You can see the last 10 digits on the readout. If the number is longer than 10 digits, see "To Review the Prefix".

## To Review the Prefix

(Number longer than 10 digits)

Press **(ST)**, then enter the first digit of the memory address, then hold down the second digit of the memory address.

## Display Own Telephone Number

1. Press **FNC**, **0**.

Your system ID number will be displayed while the key **0** is held down and your own phone number will be displayed when you stop pressing key **0**.

## Repertory Memory Scroll

(Memory Address)

This feature is useful in finding a certain phone number by scrolling the repertory memory.

1. Press **BY** then **▲** or **▼**.

▲: Scroll upward (with roll back to 01)

▼: Scroll downward (with roll up to 30)

Memory address and the last 7 digits of the stored number will be displayed on the readout as follows.

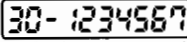
Example: 

Address No. Tel. No.

Note: In this scroll feature, any vacant memory address(es) will be skipped.

## Automatic Storing into a Vacant Memory Address

This feature allows automatic storing into a vacant repertory memory address.

This can prevent the possible over writing of a previously stored number.

1. Enter the phone number.
2. Press **FNC**, **R/ST** then **#**.

**Example: To store the phone number 123-456-7890 into a vacant memory address(03)**

1. Enter **1**, **2**, **3**, **4**, **5**, **6**, **7**, **8**, **9**, **0**.

2. Press **FNC**, **R/ST**, **#**.

3. Memory address number and the last 7 digits of the Stored phone number will be displayed.



Note: The number will be stored in the smallest available vacant memory address number. However, if no vacant address is available, the phone number will not be stored.

## To Lock the Unit

1. Press **FNC** then **1**.
2. The **LOCK** indicator turns on.



Note: The unit will remain locked until unlocked, even if the power is turned off.

## To Unlock the Unit

1. Enter the three-digit unlock code.
2. The **LOCK** indicator will go out.

Note: The unlock code is registered in the programmable option and advised by your dealer when you purchase the phone.



## Volume Control

The audio level of the earpiece and the alert tone can be adjusted by the Volume Control Key  or .

△ : To increase the sound level

▽ : To decrease the sound level.

• Earpiece volume:

1. Keep pressing  or  until you get the desired sound level.

2. Sound level "H-S VOL X" (X=1~5) will be displayed on the readout.

You can monitor the sound level with the sample tone when you are not engaged in a phone conversation.

Example: (X = 5)

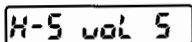

• Alert Tone:

1. Press .

2. Keep pressing  or  until you get the desired sound level.

3. Sound level "ALT VOL X" (X=1~5) will be displayed on the readout.

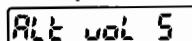

Example: (X = 5)



## MEMORY NAME TAG

This feature permits you to tag an identifying name (up to 5 characters) to each phone number in the memory address. The name will be displayed each time you recall a number from memory address.

### To Enter Names using Alpha (Letters)

1. Press  . "ALPHA" will appear on the readout to indicate the Alpha Mode is active.

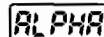



2. Press digit keys repeatedly until the character you need appears. The following table shows which character is assigned with each digit key.

#### ASSIGNED ALPHA CHARACTERS

Key	1press	2press	3press	4press	5press	
1	-	!				
2	ABC	AB	BC	2		
3	DEF	d	E	F	3	
4	GHI	g	h	i	4	
5	JKL	j	k	L	5	
6	MNO	m	n	o	6	
7	PQRS	p	q	r	S	7
8	TUV	t	U	v	8	
9	WXYZ	w	X	Y	Z	9
0	OPER	0				
*	(Blank)					
#	(Blank)					

3. When the letter or number you want is shown on the display, press  to locate the second letter or number.

4. Go back to step 2, and repeat the same procedures until the complete character name is displayed.

5. When an entry error is made, press  momentarily to erase the last character. If you press  more than a second, all characters on the readout will be erased.

6. To exit Alpha Mode, press  .

- Notes: 1. If the next letter or number is assigned on the other key (not same key), you can display the next letter or number without pressing **M+**.
2. You must enter the phone number first, then apply the name. Entering a number after applying the name will erase its name.

## To Store Name with Phone Number

1. Enter the phone number.
2. Press **FNC** **M+** to set Alpha Mode.
3. Enter the name you need. (Refer to "To Enter Names using Alpha" .)
4. Press **FNC** **0/ST**, then enter the memory address (01 through 30), to store the number with the name into memory.

Note: If you enter the phone number after entering the name, the name will be erased.

**Example: To store the phone number 1234567890 with the name JACK into memory address 01**

### 1. Enter the phone number;

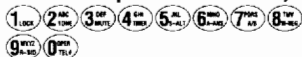

1234567890

### 2. Set Alpha Mode; **FNC** **M+**

ALPHA

### 3. Enter the Name;

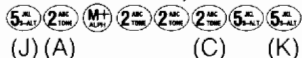

JACK

### 4. Store the Number; **FNC** **0/ST** **0** **1**

1234567890

## To Recall from Memory with Name

Recalling from the repertory memory with name is identical to standard repertory recall. When the number is recalled, the display will show the Alpha Name Tag as well as the stored phone number.

# PLACING TELEPHONE CALLS

## To Place a Call

1. Enter the phone number.
2. The last 10 digits of the dialed number are displayed on the readout.
3. Press **SEND**. The **IN USE** indicator will light.

**Example: To Call 123-456-7890**

1. **1** **2** **3** **4** **5** **6** **7** **8** **9** **0**

2. **SEND**

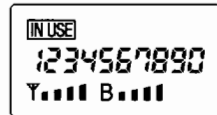

3. Talk with the other party.

NOTE: If dialing error is made, press **CLR**, then enter the phone number again. Pressing **CLR** momentarily (Approximately less than 0.5 sec.) clears the last digit only.

## If the Call Fails to Go Through

- If you hear the "reorder" signal, press **END**, then if there were no dialing errors, press **SEND** for redial. (Redialing with digit keys is not necessary.)
- If the "intercept" signal is heard, press **END** then redial the correct number.

## Automatic Redial (Programmable Option)

If the feature of Automatic Redial (Programmable Option) is selected, your unit will automatically make seven attempts to reach the cell site when the first try is not successful.

The **IN USE** indicator will stay on, but the speaker will be muted for thirty seconds. This is done so that you do not hear the reorder signals out of the speaker. If you need to terminate the automatic redial, press

**END**

## Terminating a Call

Press **END** and the **IN USE** indicator will go out.



## To Receive Calls

1. When the telephone rings, press **SEND** to answer the call. The **IN USE** indicator will light.

## Silent Incoming Calls

If Silent Alert feature is set, a single beep and a flashing "CALL" message on the display will alert you of an incoming call.

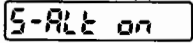
Once you have switched to silent alert, the phone stays in that mode until you deactivate it.

1. Press **FNC**, then **5.5**. The "S-ALT ON" will appear in the display. 
2. When you receive a call, a single beep and a flashing "CALL" message on the display will alert you. 
3. Press **SEND** to answer the call. "CALL" on the readout will go out.
4. This mode is deactivated by pressing **FNC**, then **5.5**. "S-ALT OFF" will be displayed for 5 seconds.

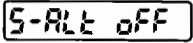
5. If the Silent Incoming Calls is activated when the unit is powered up "S-ALT ON" will appear on the readout for 5 seconds. 

## Any Digit Key Answering

This feature permits you to answer on incoming call by pressing any of the digit keys on the key pad.

## Automatic Answering

With this feature, the incoming call will be automatically connected for operation after two alert tones, and the **IN USE** indicator will light on the readout.

Then the unit is ready for conversation.

1. To activate this mode, press **FNC** and then key **6.5**. "A-ANS ON" will appear on the readout.

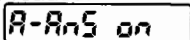

2. This mode is deactivated when **FNC** and then key **6.5** are pressed again. "A-ANS OFF" will be displayed for 5 seconds.

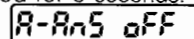

3. This feature will not function if the unit is in the Lock or Silent Incoming Call Mode.

If the Automatic Answering is activated when the unit is powered up, "A-ANS ON" will appear on the readout for 5 seconds.

## Anti Fraud Security Feature

Your new Audiovox Cellular telephone has been engineered with the latest technology to help protect from the fraudulent use of your cellular telephone number.

Cellular fraud most often occurs by cellular thieves using electronic devices that can read your unique cellular phone number and your phone's electronic serial number (E.S.N.). This information can then be programmed into another phone for fraudulent use.

Certain cellular systems provide for an ANTI-FRAUD security feature to help protect the unauthorized use of your cellular telephone number. This feature utilizes a special personal identification number (PIN).

Should your cellular carrier offer this enhanced service, your new phone must be programmed with a PIN chosen by you. For your protection, you cannot make any outgoing calls until you have established your PIN. To establish your PIN, please contact your cellular service provider for specific instructions.

### To place a call using PIN security feature

1. Enter the number you are calling by either dialing the number or recalling the number from a specific memory location.
2. Press the **SEND** key as your call is being processed the word "SEND PIN" will appear in the display.

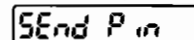

3. Press the **SEND** key again, your call will then be placed.

### To program your PIN

1. Enter your three digit security code.
2. Press the **FNC** key, **\*** then **9.99** **4.44**.

3. The word "OFF" will appear in the display.
4. Enter your 4 digit PIN.
5. Press the key to turn your PIN feature on.

To turn the ANTI FRAUD feature on / off and change PIN Number.

1. Enter your three digit security code.
2. Press the , , then , .
3. Your PIN number and the "ON/OFF" status will appear in the display.

or

4. Press the key to turn the PIN entry feature on or off.
5. If necessary, enter the new PIN Number.
6. After you have entered the desired on or off status or new PIN Number, press the key then the .

To place a call with the PIN entry feature in Voice Mail dialing (See "VOICE MAIL DIALING" for more details)

1. Press the key for more than 0.5 seconds. The last 10 digits of the number in memory address 41 will appear in the display. As your call is being processed, the word "SEND PIN" will appear in the display.

2. Press the key again, your call will then be sent digitally to the cell site. After you hear the signal from the Operating Office, press "Voice Mail Access" key again. The second number in memory address 42 is sent with DTMF tones. You will monitor the tones through the loudspeaker. The third through fifth number in memory address 43 through 45 can be accessed sequentially in the same manner as above.

## To Place a Call with a Number in the Memory

1. Press , then enter the memory address (01 through 30). The last 10 digits of the number will appear on the readout. If the number is longer than 10 digits, press , then enter the first digit of the memory address, then hold down the second digit of the memory address.

Note: See "To Recall a Number from Memory" and "To Review the Prefix" for more details.

2. Press . The **INUSE** indicator will light as the call is placed.

**Example: To CALL the number 123-456-7890 stored in the memory number 07**

1. Press .
2. Enter , . **1234567890 is shown on the display.**
3. Press .

Y... B...

**INUSE**  
  
Y... B...

## Speed Dialing

This feature permits you to place a call from the stored memory locations without using the recall key. Speed dialing is a quick method of placing calls from memory.

1. Enter the one or two digits of memory address (1 through 9 and 10 through 30).
2. Press . The last 10 digits of the phone number will appear on the readout, and the **INUSE** indicator will light.

## Last Number Redial

This feature permits you to redial the last phone number you attempted to call.

Numbers will be stored in memory only if key is pressed.

1. Press , , then .
2. Press to send a displayed number.

Note: To clear the stored number, press then .

## Programmable Emergency Call (Programmable Option)

This feature permits you to place a call to two emergency numbers (maximum of 7 digits) even if your telephone has been locked.



The two emergency numbers must be pre-programmed in the NAM memory (NAM: Number Assignment Module).

Note: 911 is preset emergency number. (you may change this number if you wish.)

## Operation in Lock Mode

### Example: To call 911

1. Enter **9<sup>EM</sup>**, **1<sup>LOC</sup>**, **1<sup>LOC</sup>**.  
"911" does not indicate, but the **LOCK** indicator will light. (911 is emergency call number)
2. Press **SEND**.  
The **IN USE** indicator will light.

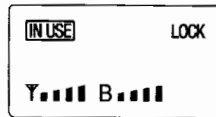

NOTE: To terminate the call, press **END**.  
(The **IN USE** indicator will go out.)

## One Touch Emergency Call

This feature permits you to place a call to an emergency number by a single key stroke, even when the unit is in the "lock" mode. You can deactivate this feature to prevent unintentional call by mistake.

1. Press key **1<sup>LOC</sup>** for more than 2 seconds. The first emergency number that is pre-programmed in the memory will be displayed, and **IN USE** indicator will light as a call is placed. The factory pre-set number is 911.
2. If you wish to deactivate this feature, press the following key sequence.

**X Y Z** **FNC** **\*** **9<sup>EM</sup>** **1<sup>LOC</sup>** (XYZ is Security Code)

To activate this feature again, follow the same key sequence.

When this mode is ON : **E-CALL on**  
OFF : **E-CALL off**

See also Programmable Emergency Call.

## To Mute a Phone Conversation

### Example: To Mute a Phone Conversation

1. Press **FNC**, **3<sup>MT</sup>**.



2. The transmit audio will be muted and the receive audio will be heard from the receiver.

3. To return to normal conversation. Press **FNC**, **3<sup>MT</sup>** again.

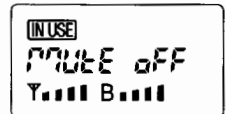

4. Mute is reset when the call is terminated.

## VOICE MAIL DIALING

This feature permits you to access, through telephone lines, a computer system and send DTMF number codes in sequence. Up to five numbers can be stored and are sequentially accessed with one touch of the "Voice Mail Access" key. The first number is sent in digital form to the cell site, then up to four other numbers are sent with DTMF signaling.

## To Store Numbers

Store the numbers to be linked into the special memory address 41 through 45. Each number should be within 32 digits.

## To Place a Call

Press **MT** "Voice Mail Access" key for approx. 0.5sec. The first number in memory address 41 will appear on the readout and will be sent digitally to the cell site. After you hear the signal from the Operating Office, press **MT** "Voice Mail Access" key again. The second number is memory address 42 will appear on the readout and is sent with DTMF tones. You will monitor the tones through the loudspeaker. The third

through fifth number in memory address 43 through 45 can be accessed sequentially in the same manner as above.

## END-TO-END SIGNALING

This feature permits you to utilize additional phone services, such as accessing an alternate long distance network, signaling a pager, or banking by phone etc.. For these services the signaling should be in DTMF (Touch Tone™).

## SCRATCH-PAD DIALING

This feature permits you to enter a number to be redialed (or store a number in memory) while engaged in a conversation.

## SCRATCH-PAD DIALING WITHOUT KEYING TONES

This feature permits you to activate scratch-pad memory without annoying key tones over the circuit.

1. Press **(FNC)**, **(2<sup>nd</sup>)**, then enter a phone number.  
"TONE OFF" will be displayed for 5 seconds.

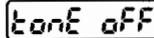

The Microphone circuit will remain active, but the tones will not be heard.

2. If necessary, press **(FNC)**, **(R/ST)**, then enter the memory address to store the number.
3. To exit the Scratch-pad Mode, press **(FNC)**, then key **(2<sup>nd</sup>)** again.

"TONE ON" will be displayed for 5 seconds.

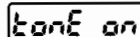

## CALL TIME DISPLAY

This feature automatically records the elapsed time per conversation. The talk time of the last call and cumulative talk time can be displayed on the readout. The timers can also be cleared if necessary.

### To Display the Talk Time

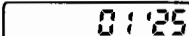
1. Press **(FNC)**, then key **(4<sup>th</sup>)**.
2. While the key **(4<sup>th</sup>)** is held down, the cumulative talk time will be displayed on the readout in minute format.  
Example ... 18 min. 
3. The talk time of the last call will be displayed on the readout for 5 seconds after the **(4<sup>th</sup>)** is released.  
While in a conversation, the talk time of a call in progress will be displayed. The display format is as follows.  
Example ... 1 min. and 25 sec. 

### Outgoing Call Timer Only (Programmable Option)

Normal call timer operation is to time both the calls made and the calls received. If the "outgoing call timer only" function is activated (Programmable Option), the call timer will only display the amount of time when placing calls. It will not display the amount of time for calls received.

### To Clear the Timer

1. Press **(CLR)**, then enter the three-digit security code.
2. Press **(FNC)**, key **(\*)** then **(9<sup>th</sup>)**, **(9<sup>th</sup>)**.  
"CLEARED" will be displayed for 5 seconds.



The timers will be cleared, and the count for the cumulative talk time will start from zero.

## SID MANAGEMENT (Programmable Option)

This feature enables you (by Programmable option) to take advantage of the family of SID groups. This is a group of cellular systems in cities that your carrier owns or has special billing arrangements with. Your close family SID's (like brothers and sisters) will be billed at the same rate as your home billing and will be indicated as "Home" (i.e. both **NO SVC** and **ROAM** are off) on your display. More distant family SID's (like cousins) that your cellular service provider has roaming agreements with will be displayed as a solid **ROAM**. When flashing **ROAM** is displayed, you are using a SID system that is not included in the NAM assigned groups.

If your display indicates flashing **NO SVC**, you will need to change your A/B switch selection or, please refer to Multiple City Registration to change phone registration to enable you to make a call.

If in question as to what SID (system identification) you are using, push **FNC**, **9** to display the current SID.

## A/B SYSTEM SELECTION

This feature permits you to select the system you need to use. The system that you are registered with is the preferred system, and your home system.

When you turn the unit on, the unit remembers the last position of the A/B system selected, and will start to scan the radio frequency channels of that selection.

1. Press **FNC**, key **7**. The current mode will be displayed.
2. You can change the current mode by pressing **▲** or **▼**.

▲: Scroll upward

▼: Scroll downward

- Standard Mode  
The unit will scan the preferred system channels. If unable to find an acceptable preferred channel, the unit switches to scan the non-preferred channels.

**Std**

- Home Only Mode  
You can place or receive calls only within your home area.

**H-SYS**

- Preferred System Only Mode  
The unit will scan the preferred system only and prevents switching over to the non-preferred system.

**P-SYS**

- Non-preferred System Only Mode  
The unit will scan the non-preferred system only.

**nP-SYS**

## MULTIPLE CITY REGISTRATION

Some cellular users find it beneficial to register their phone in multiple cities, rather than rely on "roam". The multiple city registration feature permits you to reprogram from the telephone unit, the different phone numbers for the cities in which you are registered. Each programmed phone number will be designated as your home system.

Press **CLR**, and enter the new system ID number (5 digits) followed by the corresponding phone number (10 digits). Please include your area code. You must register your unit with the carrier in order to get both the system ID number and your phone number.

Press **FNC** then key **8**. Your new phone number will be displayed on the readout. (Holding down **8**, to display your new system ID number.)

- Note: (1) System ID number and phone number can not be programmed during a call.
- (2) Calls are placed or received using only the programmed phone number in use at the time of call.

## LAST RESCAN SID INDICATOR

This feature permits you to recall the last system identification accessed by your phone.

Press **FNC**, then **9**.

The last rescan SID is displayed on the readout for 5 sec.

The display format is as follows:

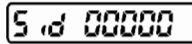

If the **NO SVC** indicator is on, the display will show as follows.



## AUTOMATIC CALLS IN ABSENCE INDICATOR

This feature indicates the number of unanswered incoming calls. If incoming calls are unanswered, the unit will indicate "CALLED XX"

"XX" is the number of calls (01 to 99) missed. For example "XX" is "02", the unit will indicate the following.

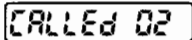

Depressing any key (other than the Power Key) will clear the number of calls indicated in Display. However, the number of calls will remain if the unit is turned off.

## ENHANCED FEATURES

Your new Audiovox Cellular Telephone has been engineered to operate with the latest technology that will allow you to enjoy the benefit of two new exciting features.

**CALLER ID:** Allows you to preview in your display the number of the party calling you.

**VOICE MAIL NOTIFICATION:** Your Cellular telephone notifies you when new messages are in your voice mailbox.

*(Please note that operation of these features depends on the Cellular system and therefore may not be available in all areas.)*

### Operation

**CALLER ID:** If your phone is ON but not in a conversation, Caller ID operates as follows: When the phone rings, the Calling Number flashes in the phone's display. If you do not answer the Call (by pressing the "SEND" key) the Calling Number is stored in the phone's Memory Stack. (See memory stack explanation)

The Memory Stack can store up to three Calling Numbers for your retrieval and later use. To conserve memory, if consecutive calls are received from the same number, that number is stored only once.

When information such as "Voice Mail" or "Caller ID" is stored in the memory stack, the "☑" icon at the lower right of the display, flashes.

Your phone also counts and displays the number of unanswered calls. For example, if two calls were not answered, "CALLED 02" will appear in the phone's display.

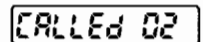

**CALL WAITING CALLER ID:** If your phone is in use and another call is directed to your phone, a short three beep tone alerts you of the new call and the new Calling Number is flashed in the display as described above. Upon viewing the new incoming Calling Number, you may choose whether or not to answer the call. If you choose to answer the call simply press the **SEND** key. This places the first calling party on hold while allowing you to converse with the new incoming caller. If you choose not to answer the new incoming call, this number is not stored in the memory stack. However, this number may be accessed by pressing the **SEND** key after completion of the original call.

*(Note: you may switch back and forth and converse with both calling parties by alternately pressing the **SEND** key.)*

**Unavailable or Restricted Numbers:** In addition to the incoming caller ID, two additional indications are possible. When the display indicates “RES” the calling number is Restricted by the calling party who does not want the number to be displayed.

RES

A display of “UNA” indicates that the number is unavailable for display.

UNA

**VOICE MAIL NOTIFICATION:** When messages are left in you voice mail, the “☑” icon at the lower right of the display, flashes to alert you. The memory stack stores the number of new messages that are in your mailbox. (New messages are messages that you have not retrieved). Two indications can be displayed “**NO VOICE**” when there are no messages or “**VOICE XX**” (xx indicates the number of new messages).

Example: NO Voice Mail

no vo ic

Two Voice Mail

vo icE-02

If your mailbox contains urgent voice mail;

vo icE-02<sup>o</sup>

## Reviewing the Memory Stack

**Memory Stack:** The memory Stack contains four memory locations. The first memory location is used to store the number of new Voice Messages in your voice mail.

**Memory Stack Alert:** Whenever the Memory Stack contains information for your review (Calling Numbers or Voice Mail Notification) the flashing “☑” icon at the lower right side of the display flashes to alert you. In addition, if your voice mail contains new messages, you will occasionally hear a short beep as a reminder of pending messages.

**Memory Stack Retrieval:** To retrieve information from the memory stack the following two-key stroke sequence should be used: Press (☑, Then ▲ or ▼). The first memory displayed after this sequence shows the number of new voice messages in your voice mail. As an example, if four new messages are in your voice mail the “**VOICE-04**” will be displayed by the first memory stack location. To continue to scroll through the memory locations press the ▲ key to scroll forward and the ▼ key to scroll backwards.

vo icE-04

Calling numbers in the memory stack are displayed in two parts:

While the ▲ key is pressed, “CX-” (X=1~3) is displayed. After the ▲ key is released, the 10 digit telephone number is displayed. (Figure 1)

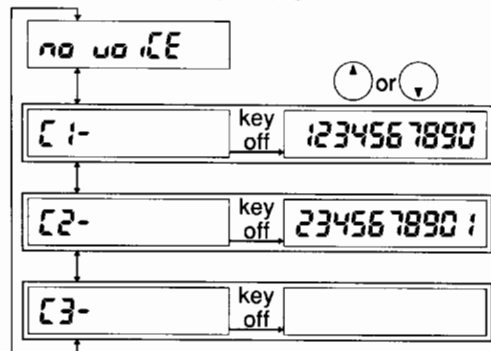

Figure 1 Memory stack Retrieval

**Memory Stack Clearing:** To clear the memory stack you must first be in the memory stack viewing mode (☒), Then (▲) or (▼) then press (FNC),

(CLR). This will clear all four memory stack locations and also delete the flashing "☒" icon. The memory stack does not allow for individual locations to be deleted.

*(Note: If there are still new messages in your voice mail, your phone will beep and the "☒" will resume flashing when the system reminds your phone of the pending messages).*

## WARNING

The following offenses are punishable by fine, imprisonment, or both:

- Using obscene, indecent, or profane language.
- Using the unit to give off false distress calls.
- Wiretapping or otherwise intercepting a telephone call, unless that person has first obtained the consent of the parties participating in the call.
- Making anonymous calls to annoy, harass, or molest other people.
- Charging to an account without authorization to avoid payment for service.
- Refusing to yield a party line when informed that it is needed for an emergency call (It is also unlawful to take over a party line by stating falsely that it is needed for an emergency).

## 12 MONTH LIMITED WARRANTY

AUDIOVOX CORPORATION (the Company), warrants to the original retail purchaser of this Audiovox Handheld Portable Cellular Telephone, that should this product or any part thereof (except the items listed below), under normal use and conditions, be proven defective in material or workmanship within the first twelve (12) month period from the date of purchase, such defect(s) will be repaired or replaced (with new or rebuilt parts) at the Company's option, without charge for parts or labor directly related to the defect(s).

The keypad and display are similarly warranted for ninety (90) days from date of purchase.

The accessories consisting of the antenna and rechargeable battery pack, travel charger are similarly warranted for twelve (12) months from original purchase.

This Warranty does not apply to batteries, fuses, or costs incurred for testing or checking, or to any product or part hereof which has suffered through alteration, serial number defacement, improper installation, excessive temperature or humidity, environmental conditions, mishandling, misuse, neglect or accident. This Warranty is not assignable or transferable.

To obtain repairs or replacement within the terms of this Warranty, the product should be delivered with proof of warranty coverage, specification of defect(s), transportation prepaid, to the Company at the address shown below. For TRAVELERS WARRANTY SERVICE.

Call toll free to (800) 229-1235 (in N.Y. State, (516) 233-3410) for reference to an Authorized Warranty Station in your area.

THE EXTENT OF THE COMPANY'S LIABILITY UNDER THIS WARRANTY IS LIMITED TO THE REPAIR OR REPLACEMENT PROVIDED ABOVE AND, IN NO EVENT, SHALL THE COMPANY'S LIABILITY EXCEED THE PURCHASE PRICE PAID BY PURCHASER FOR THE PRODUCT.

The Company disclaims liability for geographic coverage, inadequate signal to antenna, communications range or operation of the Cellular System as a whole.

ANY IMPLIED WARRANTIES, INCLUDING ANY IMPLIED WARRANTY OF MERCHANTABILITY SHALL BE LIMITED TO THE DURATION OF THIS WRITTEN WARRANTY. ANY ACTION FOR BREACH OF ANY WARRANTY HEREUNDER INCLUDING ANY IMPLIED WARRANTY OF MERCHANTABILITY MUST BE BROUGHT WITHIN A PERIOD OF 24 MONTHS FROM DATE OF ORIGINAL PURCHASE. IN NO CASE SHALL THE COMPANY BE LIABLE FOR ANY CONSEQUENTIAL OR INCIDENTAL DAMAGES FOR BREACH OF THIS OR ANY OTHER WARRANTY, EXPRESS OR IMPLIED, WHATSOEVER.

No person or representative is authorized to assume for the Company any liability other than expressed herein in connection with the sale of this product.











Some states do not allow limitations on how long an implied warranty lasts or the exclusion or limitation of incidental or consequential damage so the above limitation or exclusions may not apply to you. This Warranty gives you specific legal rights, and you may also have other rights which vary from state to state.

**IN U.S.A.:** AUDIOVOX COMMUNICATIONS CORPORATION  
185 Oser Avenue, Hauppauge,  
New York 11788  
(516) 233-3300







**IN CANADA:** AUDIOVOX CANADA LTD.  
405 Britannia Road East,  
Mississauga, Ontario L4Z3E6  
(905) 712-9299

## Quick Reference

### Basic Operation











- Turn on/off 
- Place a call Phone No., 
- Terminate a call 
- Receive a call  or ANY DIGIT KEY
- Clear last digit  (less than 0.5 sec.)
- Clear all digit  (more than 0.5 sec.)
- Volume control (Earpiece)  or 
- (Alert Tone)   or 

### Convenient Features







- Store number in memory , Phone No., , ,  
memory address
- Recall number from memory , memory address
- Speed dialing memory address, 
- Last number redial , \*, #, 

## Quick Reference

### Basic Operation

- Turn on/off 
- Place a call Phone No., 
- Terminate a call 
- Receive a call  or ANY DIGIT KEY
- Clear last digit  (less than 0.5 sec.)
- Clear all digit  (more than 0.5 sec.)
- Volume control (Earpiece)  or 
- (Alert Tone)   or 

### Convenient Features

- Store number in memory , Phone No., , ,  
memory address
- Recall number from memory , memory address
- Speed dialing memory address, 
- Last number redial , \*, #, 

## Functions

- Lock the unit (FNC), (1) Lock
- Key tone on/off (FNC), (2) MUTE
- Mute/Unmute (FNC), (3) MUTE
- Last call time display (FNC), (4) MUTE
- Silent incoming call on / off (FNC), (5) MUTE
- Automatic answering (FNC), (6) MUTE
- A/B system selection (FNC), (7) MUTE, (▲) or (▼)  
(Standard, Home, Preferred/Non-Preferred Sys)
- Multiple city registration SID, Tel No., (FNC), (8) MUTE
- Last rescan SID indicator (FNC), (9) MUTE
- Own SID&TEL No. display (FNC), (0) MUTE

## Enhanced Feature

(Caller ID&Voice Mail Notification)

- Memory Stack Retrieval (☺), (▲) or (▼)
- Memory Stack Clearing (☺), (▲) or (▼), (FNC), (CLR)

## Functions

- Lock the unit (FNC), (1) Lock
- Key tone on/off (FNC), (2) MUTE
- Mute/Unmute (FNC), (3) MUTE
- Last call time display (FNC), (4) MUTE
- Silent incoming call on / off (FNC), (5) MUTE
- Automatic answering (FNC), (6) MUTE
- A/B system selection (FNC), (7) MUTE, (▲) or (▼)  
(Standard, Home, Preferred/Non-Preferred Sys)
- Multiple city registration SID, Tel No., (FNC), (8) MUTE
- Last rescan SID indicator (FNC), (9) MUTE
- Own SID&TEL No. display (FNC), (0) MUTE

## Enhanced Feature

(Caller ID&Voice Mail Notification)

- Memory Stack Retrieval (☺), (▲) or (▼)
- Memory Stack Clearing (☺), (▲) or (▼), (FNC), (CLR)

# Audiovox Accessory Catalog MVX440 Series

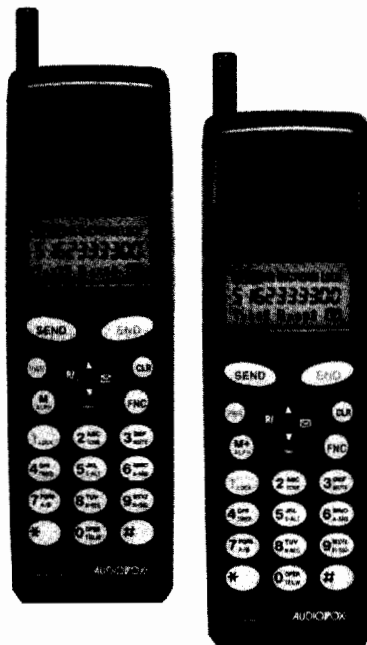

**MVX440 /MVX470 /MVX475**



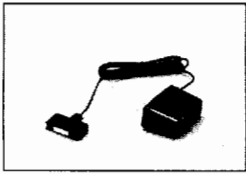

**CRC440**  
Clip-On Rapid Charger  
(AC) Charges either  
BTR440 or BTE440 in  
2.5 Hours

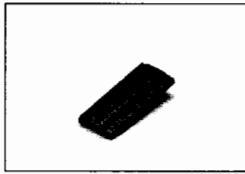

**BTE440**  
Extended Life Battery  
1200mAH NiMH  
Talk Time: 140min.  
Standby 28 Hours



**EM-425**  
Ear Phone  
Microphone For  
Hands Free Use



**LB440**  
Leather Carrying Case  
With Belt Clip and  
Protective Cover

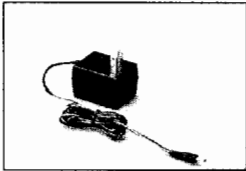

**CNR440**  
Plug-In Trickle Charger  
Specs: 7.5 V, 200mA

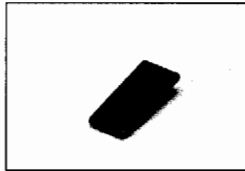

**BTR440**  
Slim Battery  
750 mAH NiMH  
Talk Time: 80 min.  
Standby Time 17Hours



**CHF440**  
Cigarette Lighter  
Hands Free Kit



**CLP440**  
Plug-in Battery Eliminator  
Trickle Charges Battery

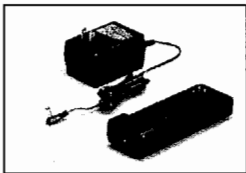

**RC440**  
Rapid Charger  
Charges either BTR440 or  
BTE440 in 2.5 Hours

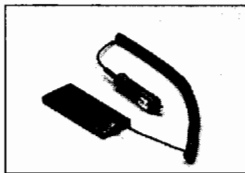

**CLA440**  
Battery Eliminator

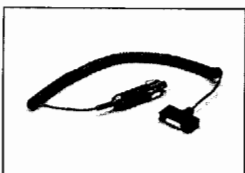

**CLC440**  
Cigarette Lighter Rapid Charger  
Charges Both BTR440 and  
BTE440 in 2.5 hours

## PROTECT YOUR WARRANTY

Read your Warranty carefully, with the special consideration to paragraph seven of the Limited Warranty for your unit.

“Warranty does not apply to...or to any product or part thereof which has suffered through alteration... mishandling, misuse, neglect, or accident”.

Many companies are making look-alike accessories and in some cases, promoting that their product is equal to or better than the Audiovox product. Be careful. Some of these products may not be compatible for use with your Audiovox product and may damage the unit or cause it to malfunction. If service is required on your unit, and it is determined that a non-Audiovox accessory has created the problem with your unit, the Warranty will not apply. In addition, if the unit has already suffered irreversible damage by reason of a non-compatible accessory, the Warranty will be voided. To protect your Warranty, use only compatible accessories which cannot damage or interfere with the functioning of your Audiovox product.



Audiovox Communications Corp., 185 Oser Avenue, Hauppauge, New York 11788, 516-233-3300  
16808 Marquardt Avenue, Cerritos, California 90701, 310-802-5100

Audiovox Canada, 405 Britannia Rd. East, Suite 101, Mississauga, Ontario, Canada L4Z3E6 905-712-9299

Audiovox Pacific Pty Ltd, 110 Rocky Point Road, Kogarah, NSW 2217, Australia, 20-9587-0011

Audiovox New Zealand Pty Ltd, Unit B, 6 Handerson Place, Auckland, 6496345720

Audiovox Singapore Pte Ltd, 268 Orchard Road, #07-07, Singapore, 238856, 65-733-5902

<http://www.audiovox.com>

©1997 Audiovox Corporation

## Free Manuals Download Website

<http://myh66.com>

<http://usermanuals.us>

<http://www.somanuals.com>

<http://www.4manuals.cc>

<http://www.manual-lib.com>

<http://www.404manual.com>

<http://www.luxmanual.com>

<http://aubethermostatmanual.com>

Golf course search by state

<http://golfingnear.com>

Email search by domain

<http://emailbydomain.com>

Auto manuals search

<http://auto.somanuals.com>

TV manuals search

<http://tv.somanuals.com>