

 **AUDIOVOX**  
*Communications Corp.*

 **AUDIOVOX**  
*Communications Corp.*  
185 OSER AVE., HAUPPAUGE, NY 11788

*OPERATING INSTRUCTIONS*



*HANDHELD PORTABLE CELLULAR TELEPHONE  
COMPLETE WITH CHARGER AND BATTERY*

**MVX507**

# MVX507 HANDHELD CELLULAR TELEPHONE

Congratulations. By choosing the MVX507, you have joined the millions of satisfied customers who are enjoying the benefits and quality performance that only an Audiovox Cellular Telephone can provide.

Your Audiovox Portable Cellular Telephone has been designed to the highest standards of quality and manufacturing excellence to fulfill both your personal and business requirements. Fully charged standard Extended Life Nickel Metal Hydride Battery provides approximately 120 minutes of continuous talk time or approximately 20 hours of standby time.

The Audiovox MVX507 is packed with advanced features like Programmable One Touch Emergency Dialing, Anti-Fraud Security Features, Automatic Call Retry, a Constant Signal Strength Indicator and Battery Level Indicator.

Optional Accessories include; a Ni-Cad battery, a Slim Profile Nickel Metal Hydride Battery, a Hands free Mobile Kit with provisions for external antenna and a 3 watt RF Power Booster. A Desk Top Charger, Cigarette Lighter Charger, Battery Eliminator and a Leather Carrying Case are also available.

And of course, your new Audiovox MVX507 comes with something only an Audiovox phone can provide. The proven reliability that has made Audiovox one of the world's leading suppliers of cellular communications equipment.

The following pages describe your phone's functions and will help you make the most efficient use of this wonderful communications tool.

Following codes can be obtained through your authorized Audiovox dealer.

- a. 3-digit Initial Lock (Unlock) Code
- b. 3-digit Initial Call Restriction Code
- c. 2-digit Initial Call Counter Code
- d. 2-digit Initial Call Timer Code

Keep these codes in a safe place!

# TABLE OF CONTENTS

<b>INTRODUCTION .....</b>	<b>3</b>
Safety Information for Wireless Handheld Phones .....	3
Features .....	7
Key/Display Names and Functions .....	8
Wrist Strap Attachment .....	10
<b>BATTERY OPERATION .....</b>	<b>10</b>
Battery Insertion/Removal .....	10
Battery Charging .....	10
Battery Level Indicator .....	12
Low Battery Warning .....	13
<b>BASIC OPERATION .....</b>	<b>13</b>
Turning Your Phone ON and OFF .....	13
Backlighting .....	13
Antenna Position .....	13
Display Own Telephone Number .....	13
Display Own System ID .....	13
Placing Calls .....	14
Call-in Progress Protection .....	14
Receiving Calls .....	14
Call in Absence Indication .....	14
Silent Incoming Calls .....	14
Automatic Answering .....	15
Redialing Functions .....	15
Last Three Numbers Dialed .....	15
Automatic Redial (Programmable Option) .....	16
MIC Mute During Conversation .....	16
Volume Adjustment .....	16
Earpiece Volume .....	16
Alert Volume .....	16
Keypad Tone Volume .....	17
<b>ENHANCED OPERATION .....</b>	<b>17</b>
Locking/Unlocking Your Phone .....	17
Locking Your Phone .....	17
Changing Your Unlock Code .....	17
Automatic Lock (Programmable Option) .....	18
Keypad Disable Function in Handsfree Mode (Programmable Option) .....	18
Storing in the Memory .....	19
Name Entry Keys .....	19
Manual Storage .....	20
Automatic Storage .....	22
Storage After Vacant Memory Location Search .....	22
Editing the Telephone Numbers and Names .....	23
Editing the Telephone Numbers .....	23
Editing the Names .....	24
Editing Phone Number under Stored Name .....	24
Memory Search .....	24

Recalling Numbers from Memory .....	24
Memory Dialing .....	24
Dialing after Telephone Number Search .....	25
Dialing after Name Search .....	25
Speed Dialing .....	25
Link Dialing .....	26
One Touch Dialing .....	27
Storing in the One Touch Memory .....	27
Placing a Call with One Touch Memory .....	27
Programmable One Touch Emergency Call .....	27
Placing One Touch Emergency Call .....	27
One Touch Emergency Call ON/OFF .....	27
Programming a New Emergency Number .....	27
Scratch Pad Memory .....	28
Storing Numbers in the Scratch Pad Memory .....	28
Dialing Numbers in the Scratch Pad Memory .....	28
Emergency and Priority Dialing .....	28
Storing the Emergency and Priority Number .....	28
Dialing the Emergency and Priority Number .....	28

## **EXTENDED FEATURES AND FUNCTIONS ..... 29**

Call Restriction .....	29
To Activate Call Restriction .....	29
To Change your Call Restriction Code .....	29
Keypad (DTMF) Tones .....	30
Keypad (DTMF) Tones Duration Selection .....	30
Keypad (DTMF) Tones Mute during conversation .....	30
Sending DTMF Tones During a Call .....	30
Timer and Counter Functions .....	30
Elapsed Time Display .....	30
Outgoing Call Timer .....	31
Cumulative Call Timer .....	31
Temporary Accumulated Call Counter .....	31
Outgoing Call Counter .....	32
Accumulated Call Counter .....	32
To Change Your Call Timer/Call Counter Codes .....	32
Call Time Warning Tone .....	33
SID Management (Programmable Option) .....	33
A/B System Selection .....	33
Multiple City Registration .....	34
Current SID, Channel and RSSI Level Display .....	35
ESN (Electronic Serial Number) Display .....	35
Anti Fraud Security Feature (PIN Feature) .....	35
Function Review .....	36
Enhanced Feature Operation .....	38
Audiobox Accessory Catalog .....	45

## **GENERAL SPECIFICATIONS ..... 49**

## **TABLE OF KEY OPERATION ..... 50**

## **12 MONTH LIMITED WARRANTY ..... 53**

## **INDEX**

# **INTRODUCTION**

First introduced in 1984, the handheld portable cellular telephone is one of the most exciting and innovative electronic products ever developed. With it you can stay in contact with your office, your home, emergency services, and others.

## **SAFETY INFORMATION FOR WIRELESS HANDHELD PHONES**

### **READ THIS INFORMATION BEFORE USING YOUR HANDHELD PORTABLE CELLULAR TELEPHONE**

#### ***EXPOSURE TO RADIO FREQUENCY SIGNALS***

Your wireless handheld portable telephone is a low power radio transmitter and receiver. When it is ON, it receives and also sends out radio frequency (RF) signals.

In August, 1996, the Federal Communications Commission (FCC) adopted RF exposure guidelines with safety levels for hand-held wireless phones. Those guidelines are consistent with the safety standards previously set by both U.S. and international standards bodies:

ANSI C95.1 (1992)\*

NCRP Report 86 (1986)\*

ICNIRP (1996)\*

• American National Standards Institute; National Council on Radiation Protection and Measurements; International Commission on Non-Ionizing Radiation Protection

Those standards were based on comprehensive and periodic evaluations of the relevant scientific literature. For example, over 120 scientists, engineers, and physicians from universities, government health agencies, and industry reviewed the available body of research to develop the ANSI Standard (C95.1).

The design of your phone complies with the FCC guidelines (and those standards).

#### ***ANTENNA CARE***

Use only the supplied or an approved replacement antenna. Unauthorized antennas, modifications, or attachments could damage the phone and may violate FCC regulations.

## ***PHONE OPERATION***

**NORMAL POSITION:** Hold the phone as you would any other telephone with the antenna pointed up and over your shoulder.

**TIPS ON EFFICIENT OPERATION :** For your phone to operate most efficiently:

- Extend your antenna fully.
- Do not touch the antenna unnecessarily when the phone is in use. Contact with the antenna affects call quality and may cause the phone to operate at a higher power level than otherwise needed.

## ***DRIVING***

Check the laws and regulations on the use of wireless telephones in the areas where you drive. Always obey them. Also, if using your phone while driving, please:

- Give full attention to driving - - driving safely is your first responsibility.
- Use hands-free operation, if available.
- Pull off the road and park before making or answering a call if driving conditions so require.

## ***ELECTRONIC DEVICES***

Most modern electronic equipment is shielded from RF signals. However, certain electronic equipment may not be shielded against the RF signals from your wireless phone.

## ***PACEMAKERS***

The Health Industry Manufacturers Association recommends that a minimum separation of six (6") inches be maintained between a handheld wireless phone and a pacemaker to avoid potential interference with the pacemaker. These recommendations are consistent with the independent research by and recommendations of Wireless Technology Research.

Persons with pacemakers:

- Should **ALWAYS** keep the phone more than six inches from their pacemaker when the phone is turned ON.
- Should not carry the phone in a breast pocket.
- Should use the ear opposite the pacemaker to minimize the potential for interference.
- If you have any reason to suspect that interference is taking place, turn your phone OFF immediately.

## ***HEARING AIDS***

Some digital wireless phones may interfere with some hearing aids. In the events of such interference, you may want to consult your service provider or call the customer service line to discuss alternatives.

## ***OTHER MEDICAL DEVICES***

If you use any other personal medical device, consult the manufacturer of your device to determine if they are adequately shielded from external RF energy. Your physician may be able to assist you in obtaining this information.

Turn your phone OFF in health care facilities when any regulations posted in these areas instruct you to do so.

Hospitals or health care facilities may be using equipment that could be sensitive to external RF energy.

## ***VEHICLES***

RF signals may affect improperly installed or inadequately shielded electronic systems in motor vehicles. Check with the manufacturer or its representative regarding your vehicle. You should also consult the manufacturer of any equipment that has been added to your vehicle.

## ***POSTED FACILITIES***

Turn your phone OFF in any facility where posted notices so require.

## ***AIRCRAFT***

FCC regulations prohibit using your phone while in the air. Switch OFF your phone before boarding an aircraft.

## ***BLASTING AREAS***

To avoid interfering with blasting operations, turn your phone OFF when in a "blasting area" or in areas posted: "**Turn off two-way radio**". Obey all signs and instructions.

## ***POTENTIALLY EXPLOSIVE ATMOSPHERES***

Turn your phone OFF when in any area with a potentially explosive atmosphere and obey all signs and instructions. Sparks in such areas could cause an explosion or fire resulting in bodily injury or even death.

Areas with a potentially explosive atmosphere are often but not always clearly marked. They include fueling areas such as gasoline stations; below deck on boats; fuel or chemical

transfer or storage facilities; vehicles using liquefied petroleum gas (such as propane or butane); areas where the air contains chemicals or particles, such as grain, dust or metal powders; and any other area where you would normally be advised to turn off your vehicle engine.

### ***FOR VEHICLES EQUIPPED WITH AN AIR BAG***

An air bag inflates with great force. DO NOT place objects, including both installed or portable wireless equipment, in the area over the air bag or in the air bag deployment area. If in-vehicle wireless equipment is improperly installed and the air bag inflates, serious injury could result.

## **FEATURES**

- SID management (programmable option)
- Multiple city registration
- Easy to read LCD display with alphanumeric and status indicators
- Back-lit keypad and LCD display
- Microphone mute control
- Priority/emergency calling with automatic retry
- 9 number speed dialing
- Link dialing
- Automatic redial (programmable option)
- 89 alphanumeric memory locations
- 7 location scratch pad, with automatic scroll
- Vacant memory location search
- Automatic entry into vacant memory location
- Phone number search
- Name search
- Programmable one touch dialing
- Programmable one touch emergency call
- Last 3 number dialed memory
- Silent incoming calls
- Automatic answering
- Call in progress protection
- Call time warning tone
- DTMF tone dialing from memory
- DTMF keypad mute
- DTMF extended tone dialing
- A/B system selection
- Current SID, RF channel and RSSI level display
- Automatic self diagnostics
- Electronic serial number display (own)
- Telephone number display (own)
- System ID display (own)
- 6 function call timer
- Function review
- Constant battery level indicator
- Anti-Fraud PIN feature capability
- Automatic lock (programmable option)
- Keypad disable in handsfree mode (programmable option)

This cellular telephone is also capable of supporting the following optional network services.

- 1) Caller ID
- 2) Voice Mail Notification
- 3) Short Messaging Service

**Note: Your cellular service provider may use different terminology when referring to the enhanced features listed above. Please check with your cellular service provider for an explanation and availability of these enhanced features.**

# KEY/DISPLAY NAMES AND FUNCTIONS

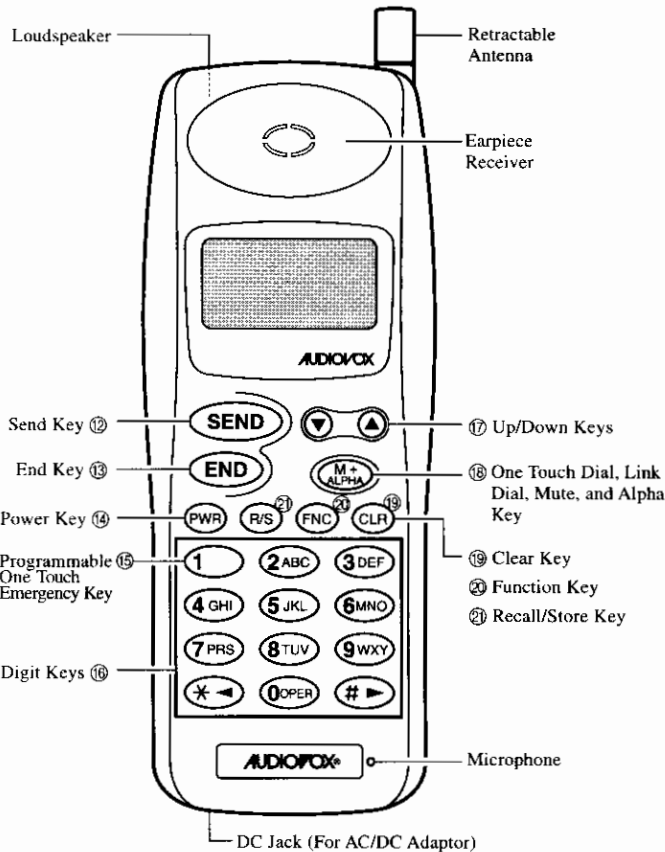
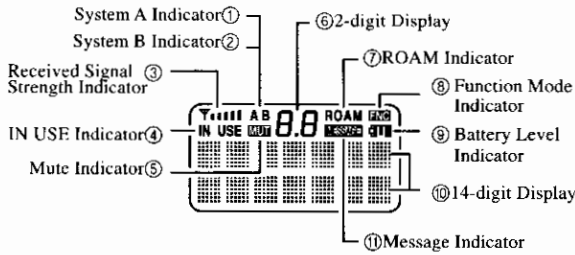

- ① **A** lights when the system A (non-wireline) is selected.
- ② **B** lights when the system B (wireline) is selected.

**Note:** **AB** lights when standard mode is selected.

- ③ Received Signal Strength Indicator constantly displays the signal strength represented by the number of bars.
- ④ **IN USE** lights when a call is in progress.
- ⑤ **MUTE** lights when the mute control is in effect.
- ⑥ 2-digit display shows the memory location number and the status of various functions.
- ⑦ **ROAM** lights when receiving services other than a registered home system.
- ⑧ **FNC** lights when is pressed to select extended functions, etc.
- ⑨ Battery Level Indicator constantly displays Battery Level by the number of bar segments.
- ⑩ 14-digit display shows the telephone number dialed, etc.
- ⑪ **MESSAGE** flashes when Message is received where Enhanced Feature Service is provided.
- ⑫ initiates and answers a call.
- ⑬ terminates a call.
- ⑭ (Power) turns your phone on and off.
- ⑮ (Programmable One Touch Emergency Key) places a call to the programmed emergency number by a single key stroke.
- ⑯ Digit keys enter telephone numbers, alphanumeric information, etc.
- ⑰ Up/Down keys adjusts the alert, earpiece and keypad tones. and are also used to select ON/OFF setting and scroll.
- ⑱ (One Touch Dial, Link Dial, Mute and Alpha Key):
  - In standby mode, the stored telephone number in the one touch memory is dialed with a single key stroke.
  - During conversation except Link Dialing, switches off the microphone to mute your voice.
  - Used to make Link Dialing and to enter alphanumeric characters.
- ⑲ (Clear) clears the digit(s) from the display.
- ⑳ (Function) is used with digit keys to allow operation of extended functions, etc.
- ㉑ (Recall/Store) recalls telephone numbers from the memory. Also used to store telephone numbers in the memory.

## WRIST STRAP ATTACHMENT

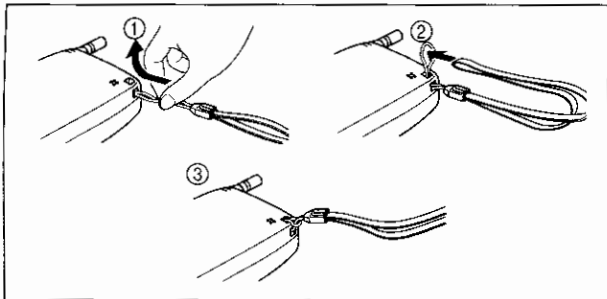

## BATTERY OPERATION

Be sure that your battery is fully charged before using your cellular telephone for the first time. Your telephone will not operate without a charged battery.

## BATTERY INSERTION/REMOVAL

### Battery Insertion

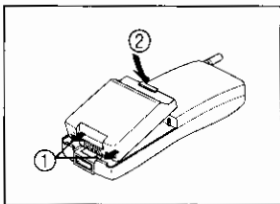

### Battery Removal

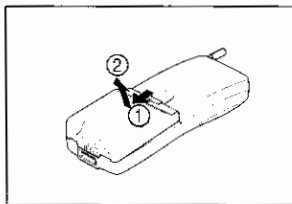

## BATTERY CHARGING

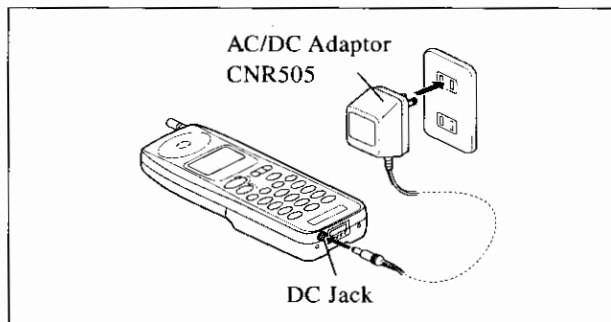

When your battery is charged as illustrated in the previous page, "Battery Charge" will be displayed. The bar segment of the Battery Level Indicator will flash during charging.

- When "Fully Charged" is displayed, battery charging is completed.

**Notes:**

- The standard battery BTE405 will be fully charged in about 3 hours. The optional BTR405 and BTM405 will be fully charged in about 2 hours. However, actual charging time varies with battery conditions.

- To place or receive calls during charging, press and hold **(PWR)** to turn your phone on. After calls, press and hold **(PWR)** again to turn your phone off.

The desk-top type Rapid Charger RC505 is standard accessory of MVX507. During charging by use of RC505, LED on the Rapid Charger will light red. When the charging is completed, the LED color will change to green.

A flashing red light indicates when the battery temperature is out of charge range or defective.

**Note:** When charging your Battery only, make sure that the battery label faces the LED side of Rapid Charger.

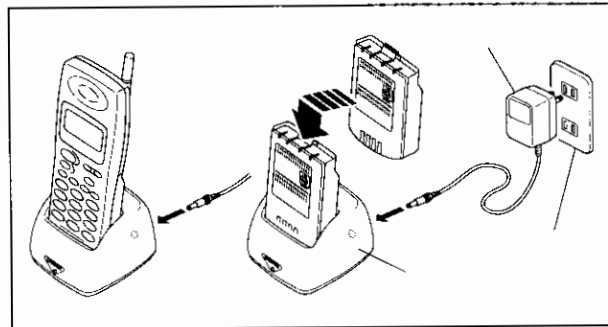

## CAUTIONS:

- Use only the supplied AC/DC Adaptor CNR505. Using other AC/DC Adaptors can damage the battery and/or the handset.
- Do not discard the battery into fire.
- Do not “short out” the battery (direct connection of the + and - terminals on the battery).
- Do not use any batteries or chargers other than those specifically designed for use with this phone.
- Charge the battery indoors with the ambient temperature between 41°F and 104°F (5°C and 40°C).
- Do not charge the battery in direct sunlight or in high humidity places like a bathroom.
- Do not recharge or “top-off” the battery pack by charging for short periods of time to avoid shortening the battery life. It is recommended to charge the battery after the battery is discharged completely.
- The product that you have purchased contains a rechargeable Battery. The Battery is recyclable. At the end of its useful life, under various state and local laws, it may be



illegal to dispose of this Battery into the municipal waste stream. Check with your local solid waste officials for details in your area for recycling options or proper disposal.

### Power Management Talk & Stand-By Times

Battery	Talk-Time	Stand-By Time	Weight
800 mAH NICAD BTR405	80 Minutes	12 Hours	7.6 oz.
1200mAH NiMH BTE405	120 Minutes	20 Hours	8.1 oz.
800 mAH NiMH BTM405	80 Minutes	12 Hours	7.6 oz.

*Please note all times are approximate.*

## BATTERY LEVEL INDICATOR

The Battery Level Indicator shows the current strength of the battery in the three-level bar segment in the battery symbol. Note that the battery level indication may be affected by variables such as temperature, battery age, and charging conditions.

Talk & Stand-by times can vary and are dependent upon the coverage of the network and how you use your phone.

## LOW BATTERY WARNING

When “Low Battery” and the Battery Level Indicator flashes every second, and an alarm tone sounds, there are only a few minutes left for call processing. If usage continues, “Low Battery” flashes more frequently. A few moments later, your call is terminated and your phone is automatically turned off.

## BASIC OPERATION

### TURNING YOUR PHONE ON AND OFF

Press and hold **(PWR)** to turn on your phone. Your own telephone number will be momentarily displayed.

**Note: When “NO SVC” (No Service) is displayed, you cannot place or receive calls as the “Cellular System” is not available.**

To turn off your phone, press and hold **(PWR)** again.

### Backlighting

When you press any key, the backlighting for display and keypad turns on to provide easier operation of your phone. It will go out 8 seconds after the last key press.

### Antenna Position

The dual position antenna allows your phone to receive calls while the antenna is down. However, for optimum performance and signal strength or while operating in poor signal areas, please extend your antenna fully.

**Note: The antenna can be used in its fully extended or fully retracted position only.**

### Display Own Telephone Number

Press **(FNC)**, **(#)**, **(1)**.

To clear the display, press **(CLR)**.

### Display Own System ID

Press **(FNC)**, **(#)**, **(3DEF)**.

To clear the display, press **(CLR)**.



## PLACING CALLS

1. Enter a telephone number.
2. Press **SEND**.  
The **IN USE** indicator will light.
3. When you finish talking, press **END**.

### Example: To call 123-4567

1. Enter **1** **2ABC** **3DEF** **4GHI** **5JKL** **6MNO** **7PQRS**.
2. Press **SEND**.  
Talk with the other party.
3. To terminate the call, press **END**.

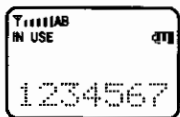

### To Correct Entered Digits:

- Press **CLR** to erase the last digit entered.
- Press and hold **CLR** to erase the whole number.

### To View Whole Number (Hidden Digits):

Although you can enter up to 32 digits, the display can show the last 14 digits only. To view the whole number, press and hold **FNC**. The hidden digits (over 14 digits) and the last 14 digits will scroll displaying “P 1” (for the last 14 digit), “P 2” (for the next 14 digits) and “P 3” (for the rest of upper digits).

## Call-in Progress Protection

Even if **PWR** is pressed during conversation, your call is not interrupted.

## RECEIVING CALLS

1. When an incoming call is attempted, an alert tone will sound and “CALL” will flash repeatedly.
2. Press any key except **PWR**, **END**, **▲**, and **▼**.  
The **IN USE** will light and you can talk with the other party.
3. To terminate your call, press **END**.

### Call in Absence Indication

If calls go unanswered, “CALL” and the number of unanswered calls will appear in the 2-digit display.

To clear the display, press **CLR**.

## Silent Incoming Calls

When this feature is activated, a single beep and a flashing “CALL” message will alert you of an incoming call.

**Note: If the Silent Incoming Calls is activated, “Silent Alert on” will be displayed when your phone is powered up. To clear the display, press CLR.**

### To Activate the Silent Incoming Calls:

Press **FNC**, **BTUV**.

“Silent Alert on” will be displayed.

To clear the display, press **CLR**.

### To Deactivate the Silent Incoming Calls:

Press **FNC**, **BTUV** again.

“Silent Alert ofF” will be displayed.

To clear the display, press **CLR**.

## Automatic Answering

When this feature is activated in handsfree mode, your phone will automatically answer an incoming call on the second alert.

### To Activate Automatic Answering:

Press **FNC**, **9WXY**.

“Auto Answer on” will be displayed.

To clear the display, press **CLR**.

### To Deactivate Automatic Answering:

Press **FNC**, **9WXY** again.

“Auto Answer ofF” will be displayed.

To clear the display, press **CLR**.

**Notes:** • **Automatic Answering will function in handsfree mode only.**

- **Automatic Answering will not function if your phone is in the lock, call restriction, or silent incoming calls mode.**

• **If Automatic Answering is activated, “Auto Answer on” will be displayed when your phone is powered up.**

## REDIALING FUNCTIONS

### Last Three Numbers Dialed

You can display and redial any of the last three telephone numbers you tried to call.

1. Select one of the telephone numbers out of three.

- Press (R/S), (#), (OPER) to display the most recent number.
- Press (R/S), (#), (1) to display the second most recent number.
- Press (R/S), (#), (2ABC) to display the third most recent number.

2. Press (SEND) for redialing.

**Note:** If “Redial” is displayed and you wish to redial the last number dialed, simply press (SEND).

### Automatic Redial (Programmable Option)

If Automatic Redial is selected, your phone will automatically continue redialing in 20 seconds if the attempt to reach the cell site is not successful. The **IN USE** indicator will stay on, but the earpiece speaker will be muted.

**Note:** Automatic Redial will initiate only on a “Cellular System” busy signal but not on a “Line” busy signal.

### MIC MUTE DURING CONVERSATION

#### To Mute the Microphone:

During conversation, press (MUTE).

#### To Release Mute:

During conversation, press (MUTE) again.

**Notes:** • The mute will be automatically released when the call is terminated.

• The MIC Mute will not function during Link Dialing.

### VOLUME ADJUSTMENT

Your phone has 7-level volume controls each for the Earpiece volume, the alert level and the keypad tone level.

#### Earpiece Volume

During conversation, press (▲) or (▼) to raise or lower the loudness of other party's voice.

While not in use, press (FNC), (\*), (9WXYZ), (OPER) to display “Voice”. Press (▲) or (▼) to adjust the earpiece Volume.

#### Alert Volume

During ringing, press (▲) or (▼) to raise or lower the alert volume level.

While not in use, press (FNC), (\*), (9WXYZ), (1) to display “Alert”. Press (▲) or (▼) to adjust the Alert Volume.

### Keypad Tone Volume

In standby mode, press (▲) or (▼) to raise or lower the keypad tone volume level.

## ENHANCED OPERATION

### LOCKING/UNLOCKING YOUR PHONE

You can restrict outgoing calls except for the Programmable One Touch Emergency Call, Emergency (911, 000, 119), and the number stored in the emergency/priority dialing area. Your phone will receive calls normally even if it is locked.

#### Locking your Phone

1. Press (FNC), (5.KL).
2. Enter your 3-digit Unlock code.

**Notes:** • Please contact your authorized Audiovox dealer to check your initial Unlock code.

• If your phone is locked, “Locked” will be displayed when your phone is powered up.

#### To Unlock your Phone:

While “Locked” is displayed, enter your 3-digit Unlock code.

#### Changing your Unlock Code

1. Press (FNC), (#), (5.KL), (1).
- “Unlock Pre?” will be displayed.
2. Enter your current 3-digit Unlock code.

**Note:** Please contact your authorized Audiovox dealer to check your initial Unlock code.

“Unlock New?” will be displayed.

3. Enter a new 3-digit Unlock code except 911, 000, and 119.
4. Press (R/S).

**CAUTION:** Keep the record of new code in a safe place!

## AUTOMATIC LOCK (Programmable Option)

You can automatically lock your phone by programmable option each time your phone is turned on.

The display shows "Locked" when your phone is turned on. Even in automatic lock mode, your phone will receive calls normally.

### To Unlock your Phone:

Enter your 3-digit Unlock code.

## KEYPAD DISABLE FUNCTION IN HANDSFREE MODE (Programmable Option)

This function prevents accidental or unintentional use of the keypad in handsfree mode.

When this function is activated by Programmable option, no key operations in handsfree mode are possible. The display shows "Keypad Disable" each time your phone is turned on.

**Note: Even in keypad disable mode, your phone will receive calls normally.**

### To Temporarily Release Keypad Disable Mode:

Press and hold **(\*)** and **(#)** simultaneously. "Keypad Disable" will disappear.

### To Return to Keypad Disable Mode:

Press and hold **(\*)** and **(#)** simultaneously again. "Keypad Disable" will be displayed.

- Notes:**
- When handsfree curly cord is disconnected from your phone, key operations become possible and "Keypad Disable" disappears.
  - When both automatic lock and keypad disable modes are selected by Programmable option and your phone is disconnected from the curly cord, your phone goes into the locked mode automatically.
  - When both automatic lock and keypad disable modes are selected by Programmable option and your phone is connected to the handsfree kit with curly cord, the display shows "Keypad Disable" upon powering up.

## STORING IN THE MEMORY

You can store telephone numbers and names in the 89 memory locations. For each memory location, you can store a telephone number of up to 32 digits and a name of up to 7 characters. (Entry of name can be omitted.)

### Name Entry Keys

To enter names, the following keys are used:

#### [Alphanumeric Character Entry Keys]

Key	Key Presses				
	1st	2nd	3rd	4th	5th
<b>(1)</b>	&	@	Space	1	
<b>(2 ABC)</b>	A	B	C	2	
<b>(3 DEF)</b>	D	E	F	3	
<b>(4 GHI)</b>	G	H	I	4	
<b>(5 JKL)</b>	J	K	L	5	
<b>(6 MNOP)</b>	M	N	O	6	
<b>(7 PQRS)</b>	P	Q	R	5	7
<b>(8 TUV)</b>	T	U	V	8	
<b>(9 WXYZ)</b>	W	X	Y	Z	9
<b>(0 PER)</b>	.	-	#	0	

#### [Editor Function Keys]

Key	Function
<b>(#)</b>	Shifts cursor to the right.
<b>(*)</b>	Shifts cursor to the left.
Press <b>(CLR)</b>	Deletes the character where the cursor is positioned.
Hold <b>(CLR)</b>	Deletes all the characters.

The following example shows how to enter the name JOHN. You can learn the characters behind the digit keys and how to move the characters with the cursor keys. Note this example illustrates how to enter a name but not actually store the name.

**Example: To enter the name JOHN**

1. To enter name entry mode,

press (CLR) (FNC) (MEM ALPHA).

"ALPHA" will flash.

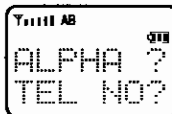

2. Enter the name JOHN.

Press (5 JKL) (#) (6MNO) (J) (J) (JM)

(6MNO) (6MNO) (#) (4 GHI) (JN) (JO) (JO) (JOG)

(4 GHI) (#) (6MNO) (6MNO) (JOH) (JOH) (JOHM) (JOHN)

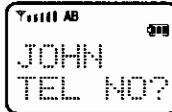

3. Press (END) to terminate this example.

**Manual Storage**

Telephone numbers and names can be stored manually into the memory locations 01 to 89.

1. Press (CLR), then enter a telephone number.

2. Enter the name.

1) Press (FNC), (MEM ALPHA). "ALPHA?" will flash.

2) Enter the name with the name entry keys.

3. Press (FNC), (R/S). "Store ?" will be displayed.

4. Enter a 2-digit location number (01-89). After the momentary display of "Stored", the stored memory location number, the telephone number and name remain displayed.

5. Press (CLR).

**Note: If the selected memory location number is already used, the previous information will be overwritten.**

The following examples show how to store the telephone number together with name, as well as how to store telephone number alone.

**Example 1: To store telephone No. 123-4567 with name JOHN in memory location No. 10**

1. Press (CLR), then enter (1) (2ABC) (3DEF) (4 GHI) (5 JKL) (6MNO) (7PRS).

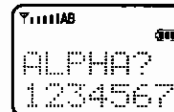

2. Press (FNC) (MEM ALPHA).

"ALPHA?" will flash.

3. Enter the name JOHN with the name entry keys.

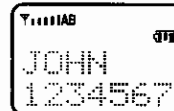

4. Press (FNC) (R/S). "Store ?" will be displayed.

5. Enter (1) (00PE). After the momentary display of "Stored", the stored memory location number, telephone number and name will be displayed.

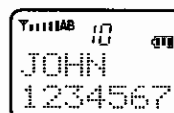

6. Press (CLR) to clear the display.

**Note: If telephone number is not entered before pressing (FNC) (MEM ALPHA) "TEL NO?" is displayed. In this case, press (MEM ALPHA) to enter the telephone number.**

**Example 2: To store telephone No. 234-5678 alone in memory location No. 11**

1. Press (CLR), then enter (2ABC) (3DEF) (4 GHI) (5 JKL) (6MNO) (7PRS) (8TUV).

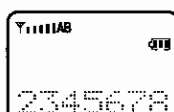

2. Press (FNC) (R/S).

3. Enter (1) (1) while the telephone number is flashing.

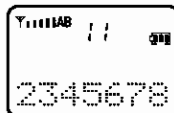

4. Press (CLR) to clear the display.

## Automatic Storage

You can automatically store telephone numbers and names in vacant memory locations. (You may choose to omit names.)

1. Press (CLR), then enter the telephone number.
2. Enter the name.
  - 1) Press (FNC), (MT ALPHA). "ALPHA?" will flash.
  - 2) Enter the name with the name entry keys.
3. Press (FNC), (R/S), (R/S).  
The telephone number and name are automatically stored in the first available vacant memory location.
4. Press (CLR).

**Note: If there is no available location, "Memory Full" will be displayed momentarily. In this case, choose a memory location that you wish to overwrite with the new information (Name, Number).**

**Example: To automatically store telephone No. 345-6789 with name JOHN in vacant memory**

1. Press (CLR), then enter (3 DEF) (4 GHI) (5 JKL) (6 MNO) (7 PRS) (8 TUV) (9 WXY).

2. Enter the name.
  - 1) Press (FNC), (MT ALPHA). "ALPHA?" will flash.
  - 2) Enter the name with the name entry keys.
3. Press (FNC) (R/S) (R/S).

The telephone number and name are automatically stored in the vacant memory location 12, for example.

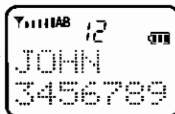

4. Press (CLR).

## Storage After Vacant Memory Location Search

You can search for unused memory locations for which telephone numbers and names can be stored. (You may choose to omit names.)

1. Press (CLR), then enter the telephone number.
2. Enter the name.
  - 1) Press (FNC), (MT ALPHA). "ALPHA?" will flash.
  - 2) Enter the name with the name entry keys.
3. Press (FNC), (R/S).
4. Press (▲) or (▼) to search for the desired vacant memory location.
5. Press (R/S) to store in that memory location.
6. Press (CLR).

**Example: To store telephone No. 456-7890 with name JOHN in the vacant memory location No. 13**

1. Press (CLR), then enter (4 GHI) (5 JKL) (6 MNO) (7 PRS) (8 TUV) (9 WXY) (00PR).
2. Enter the name.
  - 1) Press (FNC) (MT ALPHA). "ALPHA?" will flash.
  - 2) Enter the name with the name entry keys.
3. Press (FNC) (R/S).
4. Press (▲) or (▼) to search for vacant memory location 13, for example.
5. Press (R/S).
6. Press (CLR).

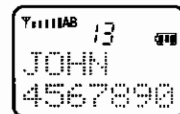

**Notes:** • To exit the Vacant Memory Location Search function, press (END).

- If there is no available location, "Memory Full" will be displayed momentarily. In this case, choose a memory location that you wish to overwrite with new information (Name, Number).

## EDITING THE TELEPHONE NUMBERS AND NAMES

You can edit the telephone numbers or names as required.

### Editing the Telephone Numbers

**To Change the Telephone Number of Location No. XX (01-89):**

1. Press (CLR), then enter a new telephone number.
2. Press (FNC), (R/S). The entered telephone number will flash.
3. Enter 2-digit location number (X) (X) to store the new number.

**To Delete the Telephone Number of Location No. XX (1-89):**

1. To display the telephone number, follow one of the next procedures.
  - To search for the telephone number, press (R/S), then (▲) / (▼).
  - Press (R/S), (X) / (X) (X).
2. Press (CLR). "Memory Clear ?" will be displayed.
3. Press (CLR) again. "Memory Cleared" will be displayed momentarily.

## Editing the Names

To edit the name of location No. XX (1-89), follow the next steps.

1. Press **(R/S)**, and enter **(X)/(X)(X)**.
2. Press **(FNC)**, **(M+ALPHA)**.
3. Edit the name with the name entry keys.
4. Press **(FNC)**, **(R/S)**, **(R/S)** to store the new name.

**Note:** To exit the editing mode, press **(END)** at any time.

## Editing Phone Number under stored Name

To edit phone number under stored name, follow the next steps.

1. Press **(FNC)**, **(M+ALPHA)**.
2. Enter the name with the name entry keys.
3. Enter **(R/S)**, **(▲)**/**(▼)** for direct search.
4. Press **(M+ALPHA)**, **(M+ALPHA)** to set phone number edit mode.
5. Enter a new Phone Number.
6. Press **(FNC)**, **(R/S)**, **(R/S)** to store.
7. Press **(CLR)** to clear the display.

## Memory Search

When you wish to search the memory information:

1. Press **(R/S)**. "Recall" will be displayed.
2. Press **(▲)** or **(▼)** to scroll up/down memory information.

**Note:** Holding **(▲)** or **(▼)** automatically scrolls up/down memory information.

## RECALLING NUMBERS FROM MEMORY

### Memory Dialing

Telephone numbers can be recalled and dialed from one of any 89 different memory locations.

1. Press **(R/S)**.
2. Enter the 1 or 2 digit location number (1-89).  
The telephone number and name will be displayed.
3. Press **(SEND)** to initiate dialing.

**Note:** If nothing is stored in a particular memory location, "Memory Empty" will be displayed momentarily. In this case, check the memory location with Memory Search.

**Example:** To place a call using memory location No. 10

1. Press **(R/S)**.
2. Enter **(1)**, **(OPER)**.
3. Press **(SEND)**.

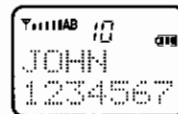

## Dialing after Telephone Number Search

You can scan, recall and dial numbers stored in memory locations 1 through 89.

1. Press **(R/S)**.
2. Press **(▲)** or **(▼)** to scroll up or down the memory locations.
3. If your desired telephone number is displayed, press **(SEND)** to initiate dialing.

**Note:** To exit the search mode, press **(END)** at any time.

## Dialing after Name Search

You can dial after searching for telephone numbers by their names.

1. Press **(CLR)**, **(FNC)**, **(M+ALPHA)**.  
"ALPHA?" will flash.
2. Enter the beginning part of name with the digit keys.  
Example: Enter J, JO, or JOH for JOHN.
3. Press **(R/S)**. "Search" will be displayed.
4. Press **(▲)** or **(▼)** to search for the desired name.
5. Press **(SEND)** to initiate dialing.

**Notes:** • If no name is found, "Not Found" will be displayed momentarily in step 4. Enter another character(s) to continue name search.

• To exit from the search mode, press **(END)** at any time.

## Speed Dialing

You can place a call from the stored memory locations 1 to 9 using the keys **(1)** to **(9wxy)**.

1. Press one of keys **(1)** to **(9wxy)**.
2. Press **(SEND)** to initiate dialing.

## LINK DIALING

When you receive service such as Voice Mail from your cellular service provider, you can dial a number and make Link Dialing with **MM ALPHA** key only.

Five Link Dialing Memories (M1 to M5) are provided with your phone.

### Storing Number in Link Dialing Memory

1. Enter a number to be stored.
2. To store the number as non-secret number, press **FNC** **R/S** **MM ALPHA** and enter Link Dialing Memory Number.

To store the number as secret number, press **FNC** **R/S** **\* →** **MM ALPHA** and enter Link Dialing Memory Number.

**Note: Maximum 16 digits can be stored in each Link Dialing Memory. When you try to store more than 16 digits, the lastly entered 16 digits are valid.**

### Recalling number from Link Dialing Memory

1. To recall a non-secret number from a Link Dialing Memory, press **R/S** **MM ALPHA** and enter Link Dialing Memory Number.

To recall a secret number from a Link Dialing Memory, press **END**, 3 digit lock code, **R/S** **MM ALPHA** and enter Link Dialing Memory Number.

### Making Link Dialing

1. To display a Link Dialing Number stored in "M1", press **MM ALPHA**.

**Note: When the Link Dialing number is stored as secret, "Secret" will be displayed.**

To dial the Link Dialing Number and activate Link Dialing, keep holding **MM ALPHA**.

2. To transmit DTMF signals for numbers stored in M2 to M5, press **MM ALPHA** each time during conversation.

**Notes:** • When the number is stored as secret number, "Secret" will be displayed.

• When PIN mode is ON, "PIN" will flash.

In this case, press **MM ALPHA** or **SEND** to send the PIN first.

3. To exit from Link Dialing mode, press **CLR**.

## ONE TOUCH DIALING

By using Link Dial Memory M1, you can place a call with **MM ALPHA** key after storing a telephone number in the one touch memory assigned to **MM ALPHA** key.

### Storing in the One Touch Memory

1. Press **CLR**, then enter a telephone number.
2. Press **FNC**, **R/S**, **MM ALPHA**, **1**.

**Note: The stored telephone number can be reviewed by pressing **R/S**, **MM ALPHA**, **1**.**

### Placing a Call with One Touch Memory

1. Press and hold **MM ALPHA**.
2. The telephone number will be displayed, and the **IN USE** indicator will light as the call is placed.

## PROGRAMMABLE ONE TOUCH EMERGENCY CALL

You can place an emergency call with **1** key alone, even when your phone is in lock and/or call restriction mode. 911 is the preset emergency number. You can reprogram this number with another number (up to 7 digits) if you wish. Also, you can deactivate this feature to avoid an unintentional call by mistake.

### Placing One Touch Emergency Call

1. Press and hold **1** for 2 seconds.  
The pre-programmed emergency number will be displayed, and the **IN USE** indicator will light as the call is placed.

### One Touch Emergency Call ON/OFF

1. Press **FNC**, **\* →**, **4 GH**.
2. Enter your 3-digit Unlock code.
3. Press **▲** to select "ON", or **▼** to select "OFF".
4. Press **R/S** to store.
5. Press **CLR** to clear the display.

### Programming a New Emergency Number

1. Press **FNC**, **\* →**, **4 GH**.
2. Enter your 3-digit Unlock code.
3. Enter a new emergency number (Max. 7 digits).
4. Press **R/S** to store.
5. Press **CLR** to clear the display.

## SCRATCH PAD MEMORY

As a sort of numerical note pad, you can enter up to 7 entries in special memory locations (memory locations 90 to 96) of up to 32 digits each. Also, you can place a call from the scratch pad memory. The 8th entry scrolls the scratch pad memory and the number entered first is erased.

**Note: Contents of the scratch pad memory will not be cleared even if your phone is turned off.**

### Storing Numbers in the Scratch Pad Memory

1. Press **(CLR)** and enter a number you wish to store (up to 32 digits).
2. Press **(FNC)**, **(1)**.

### Dialing Numbers in the Scratch Pad Memory

1. Press **(R/S)**.
2. Enter one of the location numbers (90 to 96).  
Example: Enter **(9WXY)** **(0OPER)** to recall the last number entered.
3. Press **(SEND)** to initiate dialing.

## EMERGENCY AND PRIORITY DIALING

You can store a single telephone number up to 32 digits for emergency or priority purpose. The memory location 97 is reserved for this purpose.

### Storing the Emergency and Priority Number

1. Press **(CLR)**, then enter a telephone number.
2. Press **(FNC)**, **(R/S)**.
3. Enter **(9WXY)**, **(7PRS)** while the telephone number is flashing.
4. Press **(CLR)** to clear the display.

### Dialing the Emergency and Priority Number

1. Press **(R/S)**, **(9WXY)**, **(7PRS)**.
2. Press **(SEND)**.

**Note: The emergency and priority number will automatically be redialed up to 3 times at 50 second intervals or until a connection is made. During redialing sequence, "Priority Dial" will be displayed indicating that this feature is in operation.**

## EXTENDED FEATURES AND FUNCTIONS

### CALL RESTRICTION

In the call restriction mode, only specific keys are effective to prevent unauthorized operation of the phone. Only the following keys are operative to place a call.

- 1) Any combination of numbers 1 and 2 for a call:
  - **(R/S)** + (1, 2, 11, 12, 21, 22) + **(SEND)**
- 2) Emergency Calls:
  - **(R/S)** + 9 + 7 + **(SEND)**
  - 9 + 1 + 1 + **(SEND)**
  - 0 + 0 + 0 + **(SEND)**
  - 1 + 1 + 9 + **(SEND)**
- 3) One Touch Emergency Call:
  - Holding **(1)** for 2 seconds.

**Note: You can receive a call even if your phone is in the call restriction mode.**

### To Activate Call Restriction

1. Press **(FNC)**, **(\*)**, **(5JKL)**.
2. Enter your 3-digit Call Restriction code.

**Note: Please contact your authorized Audiovox dealer to check your initial Call Restriction code.**

"CR" will be displayed to indicate that call restriction is in effect.

**Note: The call restriction is effective until it is deactivated. When the power is turned on, "CR" will be displayed. ("Locked" will be displayed if your phone is locked.)**

### To Exit Call Restriction Mode:

While "CR" is displayed, enter your 3-digit Call Restriction code. Then, "Regular" will be displayed. To clear the display, press **(CLR)**.

### To Change your Call Restriction Code

1. Press **(FNC)**, **(#)**, **(5JKL)**, **(2ABC)**.  
"Restr. Pre?" will be displayed.
2. Enter your current 3-digit Call Restriction code.  
"Restr. New?" will be displayed.
3. Enter a new 3-digit Call Restriction code except 911, 000, and 119.
4. Press **(R/S)**.



**CAUTION: Keep the record of new code in a safe place!**

**Note: If you enter a wrong code in step 2, your phone will return to standby mode.**

## KEYPAD (DTMF) TONES

Dual Tone Multi-Frequency (DTMF), or “Keypad Tone” signals can be transmitted during a call by entering digits on the keypad or recalling numbers from the memory. By sending the DTMF signals, you can access special services such as voice mail and answering machines that require long duration tone.

### Keypad (DTMF) Tones Duration Selection

To toggle the Long Tone and Short Tone for the time duration of DTMF tones, press **(FNC)**, **(#)**, **(8TUV)**.

### Keypad (DTMF) Tones Mute during conversation

To mute the keypad (DTMF) tone, press **(FNC)**, **(3DEF)** during conversation.

To enable the keypad (DTMF) tones, press **(FNC)**, **(3DEF)** again during conversation.

### Sending DTMF Tones During a Call

#### From the Keypad:

1. During a call, press any key on the keypad.

#### From the Memory:

1. During a call, press **(R/S)**, **(\*)**.
2. Enter a 2-digit memory location (01-89).

## TIMER AND COUNTER FUNCTIONS

### Elapsed Time Display

You can display the elapsed time of the current call or last call while not in use.

1. Press **(FNC)**, **(\*)**, **(3DEF)**, **(0OPER)**.

“Time mm:ss” will be displayed. (mm: Minutes, ss: Seconds)

2. Press **(CLR)** to exit this mode.

**Note: The time count will automatically reset to 00:00 after 99 minutes and 59 seconds.**

### Outgoing Call Timer

You can display your outgoing call time.

1. Press **(FNC)**, **(\*)**, **(3DEF)**, **(1)**.
2. Enter your 2-digit Call Timer code.

**Note: Please contact your authorized Audiovox dealer to check your initial Call Timer code.**

“Outgo-T hhhh:mm” will be displayed. (hhhh: Hours, mm: Minutes)

To exit this mode, press **(CLR)**.

To reset the Outgoing Call Timer to 0000:00, press **(\*)**, **(CLR)**.

**Note: The timer will automatically reset to 0000:00 after 9,999 hours and 59 minutes.**

### Cumulative Call Timer

You can display a running total of on-air usage.

1. Press **(FNC)**, **(\*)**, **(3DEF)**, **(2ABC)**.
2. Enter your 2-digit Call Timer code.

**Note: Please contact your authorized Audiovox dealer to check your initial Call Timer code.**

“Total-T hhhh:mm” will be displayed. (hhhh: Hours, mm: Minutes)

To exit this mode, press **(CLR)**.

To reset the Cumulative Call Timer to 0000:00, press **(\*)**, **(CLR)**.

**Note: The timer will automatically reset to 0000:00 after 9,999 hours and 59 minutes have been accumulated.**

### Temporary Accumulated Call Counter

You can display the temporary accumulated number of calls.

1. Press **(FNC)**, **(\*)**, **(2ABC)**, **(0OPER)**.

“Call XXXX” will be displayed. (XXXX: Number of calls)

To exit this mode, press **(CLR)**.

To reset the total number to 0000, press **(\*)**, **(CLR)**.

**Note: The call counter will automatically reset to 0 after 9,999 calls.**

## Outgoing Call Counter

You can check the accumulated number of outgoing calls.

1. Press **(FNC)**, **(\*)**, **(2ABC)**, **(1)**.
2. Enter your 2-digit Call Counter code.

**Note: Please contact your authorized Audiovox dealer to check your initial Call Counter code.**

“Outgo-C XXXX” will be displayed. (XXXX: Number of outgoing calls)

To exit this mode, press **(CLR)**.

To reset the Outgoing Call Counter to 0000, press **(\*)**, **(CLR)**.

**Note: The call counter will automatically reset to 0 after 9,999 calls.**

## Accumulated Call Counter

You can check the accumulated number of calls.

1. Press **(FNC)**, **(\*)**, **(2ABC)**, **(2ABC)**.
2. Enter your 2-digit Call Counter code.

**Note: Please contact your authorized Audiovox dealer to check your initial Call Counter code.**

“Total-C XXXX” will be displayed. (XXXX: Number of calls)

To exit this mode, press **(CLR)**.

To reset the Accumulated Call Counter to 0000, press **(\*)**, **(CLR)**.

**Note: The call counter will automatically reset to 0 after 9,999th call has been made.**

## To Change your Call Timer/Call Counter Codes

- In case of Call Timer code change, press **(FNC)**, **(#)**, **(5JKL)**, **(4GHI)**.

“Timer Pre?” will be displayed.

- In case of Call Counter code change, press **(FNC)**, **(#)**, **(5JKL)**, **(3DEF)**.
- “Counter Pre?” will be displayed.

2. Enter the current code.

**Note: Please contact your authorized Audiovox dealer to check your initial code.**

“Timer New?” or “Counter New?” will be displayed.

3. Enter a new 2-digit code.
4. Press **(R/S)**.

**CAUTION: Keep the record of new codes in a safe place!**

## Call Time Warning Tone

You can turn the Call Time Warning Tone on and off. When it is set to on, a single warning tone will be heard every 1 minute and a double warning tone will be heard every 5 minutes during a call.

### To Turn the Warning Tone ON:

1. Press **(FNC)**, **(\*)**, **(1)** while not in use.  
“Beep Tone on” will be displayed.
2. Press **(CLR)** to clear the display.

### To Turn the Warning Tone OFF:

1. Press **(FNC)**, **(\*)**, **(1)** again while not in use. On/off toggles and “Beep Tone off” will be displayed.
2. Press **(CLR)** to clear the display.

## SID MANAGEMENT (Programmable Option)

You can take advantage of a family of SID (System Identification) groups by this Programmable option. This is a group of cellular systems in cities that your carrier owns or has special billing arrangements with. Your close family SID's will be billed at the same rate as your home billing. (Both “NO SVC” and **ROAM** are off.) More distant family SID's will be billed at a preferred rate. Your phone will display solid **ROAM**. When flashing **ROAM** is displayed, you are using a SID system that is not included in the groups assigned at the time of programming.

If your display indicates “NO SVC”, you will need to change your A/B system selection or, please refer to Multiple City Registration to change phone registration to enable you to make a call.

**Note: For specific information regarding special billing arrangements, please consult your cellular service provider.**

## A/B SYSTEM SELECTION

You can select the system you need to use. The system that you are registered with is the preferred system and your home system.

1. Press **(FNC)**, **(6MNO)**.
2. Press **(▲)** or **(▼)** until your desired system is displayed.
3. Press **(R/S)**.
4. Press **(CLR)** to clear the display.

**Note: When you turn your phone on, your phone will start to scan the system of the last power-off.**

### Standard Mode:

Your phone will scan the preferred system channels. If unable to find an acceptable preferred channel, your phone switches to scan the non-preferred system channels. "A B" will light in the display.

### System A Only Mode:

Your phone will scan the system A only. "A" will light in the display.

### System B Only Mode:

Your phone will scan the system B only. "B" will light in the display.

### Home Mode:

Your phone will scan preferred system and Brother/Sister system channels.

You can place or receive calls only within your Home area.

### Family Mode:

Your phone will scan both systems A and B regardless of Brother/Sister or Cousin system channels.

## MULTIPLE CITY REGISTRATION

You can reprogram the different phone numbers for the cities in which you are registered. Each programmed phone number will be designated as your home system.

**Note: To use this feature, you must register your phone with the carrier in order to get both the system ID number and your phone number.**

### To Program the Phone Number:

1. Press (CLR), then enter the new system ID number (5 digits).
2. Enter corresponding phone number including your area code (10 digits).
3. Press (FNC), (#), (#).
4. Enter your 3-digit Unlock code.

After programming the new number, your phone automatically wakes up again and displays the new phone number.

**Note: Calls are placed or received using the programmed phone number only.**

## CURRENT SID, CHANNEL AND RSSI LEVEL DISPLAY

You can see the current SID (System Identification), channel No. and RSSI level at a time. The RSSI is the signal strength of the current channel of operation represented in voltage. The higher voltage shows the better connection and clearer communications.

1. Press (FNC), (\*), (SMC).
2. To clear the display, press (CLR).

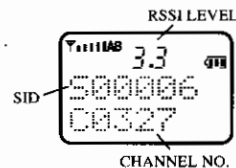

## ESN (Electronic Serial Number) Display

Press (FNC), (#), (2ABC) to display your ESN.

To clear the display, press (CLR).

## ANTI FRAUD SECURITY FEATURE (PIN Feature)

If your cellular carrier offers Personal Identification Number (PIN) service, your new phone must be programmed with your PIN. For your protection, you cannot make any outgoing calls until establishing your PIN. Please contact your cellular service provider for specific instructions.

### To Place a Call Using the PIN service:

1. Enter the telephone number.
2. Press (SEND).  
"PIN" will flash in the display.
3. Press (SEND) again. Your call will then be placed.

### To Enter the PIN and Turn the PIN Feature ON or OFF:

1. Press (FNC), (#), (\*).
2. Enter your 3-digit Unlock code.

**Note: Please contact your authorized Audiovox dealer to check your initial Unlock code.**

3. Enter your PIN (up to 6 digits).
4. Press (▲) or (▼) to turn the PIN feature on or off.
5. Press (R/S).
6. To exit the mode, press (CLR).

## FUNCTION REVIEW

### To Review the Function Menus:

1. Press **FNC**, then **▲** or **▼**. "FNC Review" will be displayed.
2. Press **▲** or **▼** to scroll up or down the function menus.
3. Press **CLR** to exit the mode.

- Notes:**
- You can directly access to "FNC \*1" by pressing **FNC**, **\*>**, **▲/▼**.
  - You can directly access to "FNC #1" by pressing **FNC**, **#>**, **▲/▼**.

### To Directly Enter the Function Setting Mode:

1. Press **FNC**, then **▲** or **▼** to search for the desired function menu.
2. Press **FNC**. Then, you can enter the function setting mode.

The following table shows each function menu. In the actual display, "FNC 1 Scratch" and "FNC 1 Pad" are alternately displayed in case of FNC 1.

Display	Function
FNC 1 Scratch Pad	Scratch pad memory
FNC 3 DTMF Tone	DTMF tone mute (during a call)
FNC 5 Lock	Locking your phone electronically
FNC 6 System Standard	Scan mode selection
FNC 8 Silent Alert	Silent alert selection
FNC 9 Auto Answer	Automatic answer selection
FNC 71 Message Mode	Message mode selection
FNC 72 Message Beep	Message beep selection
FNC *1 Beep Tone	Call time warning tone selection

Display	Function
FNC *4 1-Touch Emerg.	One touch emergency call selection
FNC *5 Call Restr.	Call restriction mode selection
FNC *6 Display RSSI	Current SID, RF Channel and RSSI level display
FNC *20 Call Counter	Temporarily accumulated call counter display
FNC *21 Outgo Call	Accumulated outgoing call counter display
FNC *22 Total Call	Accumulated call counter display
FNC *30 Call Timer	Elapsed timer display for current or last call
FNC *31 Outgo Time	Outgoing call timer display
FNC *32 Total Time	Cumulative call timer display
FNC *90 Voice Volume	Earpiece volume selection
FNC *91 Alert Volume	Alert volume selection
FNC *92 Tone Volume	Keypad tone volume selection
FNC *93 M-Beep Volume	Message Beep volume selection
FNC #1 Own Phone	Own telephone number display
FNC #2 Display ESN	Own ESN display (Electronic Serial Number)
FNC #3 Display SIDH	Own system ID display
FNC #8 Change DTMF	DTMF (keypad) tone duration selection
FNC #51 Change Unlock	Lock/Unlock code change
FNC #52 Change CR	Call restriction access code change

Display	Function
FNC #53 Change C-Count	Call counter access code change
FNC #54 Change C-Timer	Call timer access code change
FNC #* Change PIN	PIN entry mode
FNC ## Multi Reg.	Multiple city registration (phone number and SID entry)

## ENHANCED FEATURE OPERATION

The feature operation on the following pages pertains to “Enhanced Features” that may be offered by your cellular service provider. Before you can use these features, you must subscribe to them through your home cellular service provider.





**Note: These optional network services may not be available in all areas.**

### Message Indicator



When your phone has unread messages, Message Indicator will be displayed. When your phone receives a message, Message Indicator will flash in the display.



### Message Display On/Off Mode Selection

Message Display ON Mode is preset at the factory.

- To change the Message Display ON/OFF Mode, press .
- Enter 3 digit Lock code.
- Press  to select ON mode or  to select OFF mode.
- Press .
- To clear the display, press .

### Message Display at Message Receiving

When Message Display Mode is On and your phone receives Call Back Number, Short Message or Voice Mail, “CALL BACK”, “SHORT MESSAGE” or “VOICE MAIL” will be displayed respectively. To view the message, press any key except  and .



When Message Display Mode is Off and your phone receives the message, the Message Indicator will flash in the display. To view the message, enter Message Review Mode by pressing   (Hold the second  for 2 seconds).

### Message Display Upon Power Up

When Message Display Mode is On and there are unread messages in the memory, the display will indicate the number of stored messages and the number of unread messages.

For example, if the display indicates “10-03 MESSAGE”, “10” indicates the number of stored messages and “03” indicates the number of unread messages.

When Message Display Mode is Off and your phone with unread messages is powered up, the Message Indicator will be displayed.

To view the message, enter Message Review Mode by pressing   (Hold the second  for 2 seconds).



### Common Incoming Memory Stack

Your phone has a memory stack of 30 messages for the Message Services. Each message consists of up to 32 digits or 32 characters.

When your phone receives more than 30 messages, the message marked with “#” will be deleted from memory first. When your phone has no memory marked with “#”, the oldest message will be deleted so that the latest 30 messages remain in the memory stack.

**Note: When a particular message is marked with “#”, the message will not be deleted by this operation.**

### Message Review

- Press   to enter Message Review Mode. (Hold the second  for 2 seconds)

“10-03 MESSAGE” will be displayed, for example.

In this case, “10” indicates the number of stored messages and “03” indicates the number of unread messages.

**Note: When your phone has no messages, “NO MSGS” will be displayed. To clear the display, press (CLR).**

2. For specific key operations for message service, please use the following key operations:

- a. To search and display unreviewed messages, press (R/S).
- b. To show the message from the latest memory, press (▼).
- c. To show the message from the oldest memory, press (▲).
- d. To hold the message in memory, press (\*→). “\*” will be displayed. Maximum 10 messages can be held in the memory.
- e. To prioritize deletion of a specific message, press the (#→) key while message is displayed. When your phone attempts to store over 30 messages, the message with the “#” mark will be deleted first.
- f. To delete the displayed message from memory, press (CLR) (CLR).
- g. To delete all the messages from memory, press (CLR) (CLR) (Hold the first (CLR) for 2 seconds).
- h. To store the displayed message except Short Messages and Voice Mail into a phone number memory, press (FNC) (R/S) and enter a memory number of 01 to 89.
- i. To originate a call to the displayed number except Short Message, press (SEND).
- j. To exit Message Review Mode, press (END).

**Notes:**

- The “▼” mark in the display indicates there is a hidden display. Press (▼) to view the display.
- When a message has been reviewed, “#” will be displayed.
- When all the messages have been reviewed by (R/S) operation, “ALL Review” will be displayed momentarily.

## Example

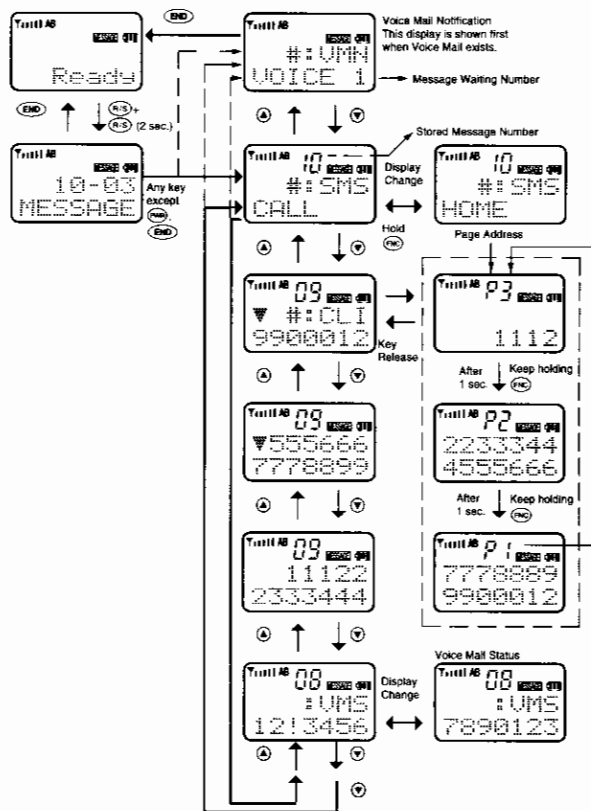

VMN	: Voice Mail Notification
VMS	: Voice Mail Status
VMS(!)	: Voice Mail Status (Urgent)
CLI	: Call Line Identifier
SMS	: Short Message Status
CID	: Caller ID
	Alert with Info
	Flash with Info

### Deleting a Message Individually

1. Press **CLR** momentarily. "Clear ?" will be displayed.
2. If you do not wish to delete the message, press **END**.  
Or to execute the deletion of the message, press **CLR**.  
"Cleared" will be displayed momentarily.

### Deleting all the Messages

1. Press and hold **CLR** for two seconds.  
"ALL Clear ?" will be displayed.
2. If you do not wish to delete all the messages, press **END**.  
Or to execute the deletion of all the messages, press **CLR**.  
"ALL Cleared" will be displayed momentarily.

### Storing a Digit Message of Call Back Number and Caller ID into Phone Number Memory

1. Press **FNC** **R/S**.
2. Enter XY. (XY is a location number of 01 to 89)

Or to automatically store a digit message at an unused memory location, press **FNC** **R/S** **R/S**. The stored memory number will be displayed for one second.

**Notes:** • Only digit messages can be stored.

- UNA (Number not available) and RES (Number Restricted) or Short Message will not be stored.

### Caller ID

When your phone receives a call, the caller's phone number will be displayed and stored in the memory. If you are in a conversation and another call is attempted, your phone beeps three times and the caller's phone number will be displayed in Call Waiting.

To answer the call, press any key except **PWR** and **END**.  
If you do not answer the call, the message indicator will flash and the Caller ID will be displayed.

### Voice Mail Access Number

1. Press **MT** **ALPHA** to recall your Voice Mail Number.
2. In the following cases, press **SEND** to place a call to the Voice Mail Number.
  - At Voice Mail Notification
  - At Short Message "MRS" display during Message Review Mode

**Note:** It will be necessary to store your voice mail retrieval number in **MT** **ALPHA** in advance to use the **MT** **ALPHA** one touch dialing feature.

**Refer to Storing Number in Link Dialing Memory (Page 26).**

### Message Beep Alert

Your phone will beep when receiving Message services:

- Short Message ..... Repeat of single Beep
- Voice Mail Number/  
Voice Mail Notification ..... Repeat of two Beeps
- Call Back Number ..... Repeat of three Beeps
- Flash with Info ..... Repeat of three Beeps

**Note:** When Message Display Mode is Off, the above Beep Alert will not be repeated.

### Message Beep Alert Tone Level Control

You can adjust Beep Alert tone level to seven levels while not in use.

1. Press **FNC** **\*** **9** **WXYZ** **3DEF**.  
The current Beep Alert Tone will be heard and the level will be displayed.
2. Press **▲** or **▼** according to your desired tone level.
3. To clear the display, press **CLR**.

### Message Beep On/Off Selection

Message Beep ON mode is preset at the factory.

1. To toggle Message Beep On/Off mode, press **(FNC)** **(7PRS)** **(2ABC)**. "Message Beep oF" or "Message Beep on" will be displayed.
2. To clear the display, press **(CLR)**.

When Message Beep Alert Mode is Off, Message Beep Alert will not sound even if your phone receives Message services. When Message Beep Alert Mode is Off, "Message Beep oF" will be displayed upon power up. To clear the display, press **(CLR)**.

## AUDIOVOX ACCESSORY CATALOG MVX-501/505/506/507

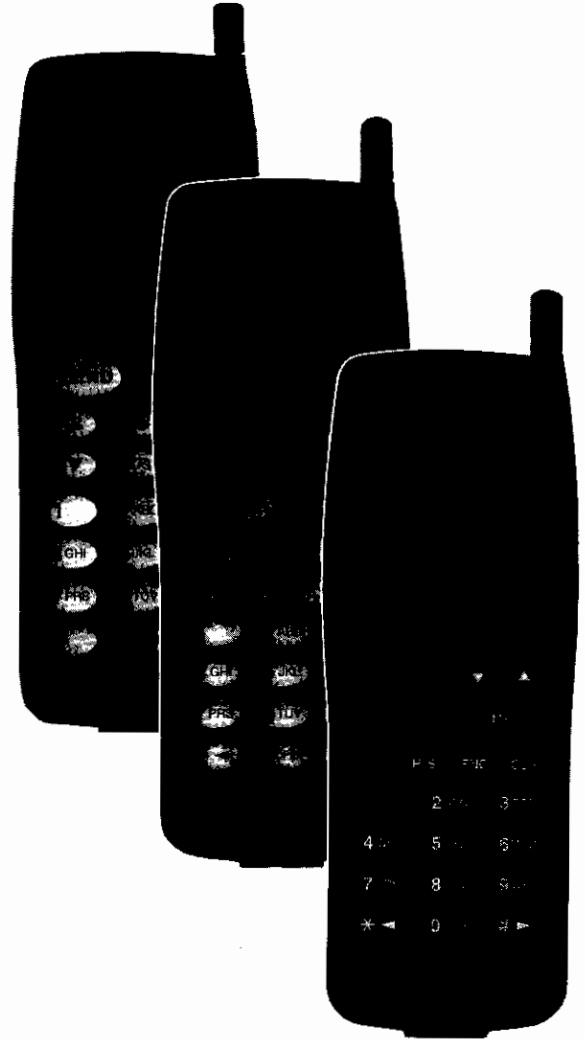



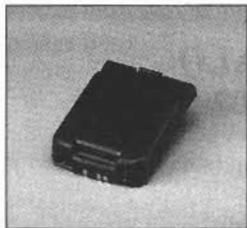

**BTR-405**  
Standard Life NiCad Battery  
(800 mAh) (standard with  
MVX-501/505/506)



**BTE-405**  
Extended Life NiMH Battery  
(1200 mAh)  
(standard with MVX-507)

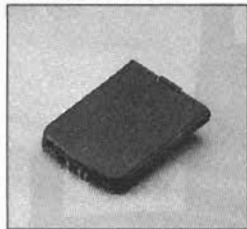

**BTM-405**  
Slim NiMH Battery  
(800 mAh) (option)



**DTC-405**  
Desk Top Charger  
(option)



**HF-505**  
Hands Free Mobile Kit  
(option)



**CLA-505**  
Cigarette Lighter Adapter  
(option)



**RC-505**  
Rapid Charger  
(standard with MVX507)



**CHF-505**  
Cigarette Lighter Hands  
Free (option)



**CLP-505**  
Cigarette Lighter  
Charger (option)



**LB-405**  
Leather Carrying Case  
(option)

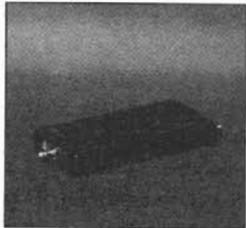

**PBK-505**  
3 Watt RF Power  
Booster (must be used  
with HF-505) (option)



**CNR-505**  
AC Rapid Charger (stan-  
dard with MVX-501/505/  
506)



**PCP505**  
Personalized Colored Plastics

- Available Colors:
- Dark Blue PCP505DB
  - Forest Green PCP505FG
  - Yellow PCP505Y
  - Ruby Red PCP505RR
  - Wood Grain PCP505WG

**WS-700**  
Wrist Strap (Not shown)

These accessories are available at your local AUDIOVOX Dealer. For more information call 1-800-1CEL.



## PROTECT YOUR WARRANTY

Read your Warranty carefully, with the special consideration to paragraph seven of the Limited Warranty for your unit.

“Warranty does not apply to...or to any product or part thereof which has suffered through alteration... mishandling, misuse, neglect, or accident”.

Many companies are making look-alike accessories and in some cases, promoting that their product is equal to or better than the Audiovox product. Be careful. Some of these products may not be compatible for use with your Audiovox product and may damage the unit or cause it to malfunction. If service is required on your unit, and it is determined that a non-Audiovox accessory has created the problem with your unit, the Warranty will not apply. In addition, if the unit has already suffered irreversible damage by reason of a non-compatible accessory, the Warranty will be voided. To protect your Warranty, use only compatible accessories which cannot damage or interfere with the functioning of your Audiovox product.



### AUDIOVOX COMMUNICATIONS CORP.

185 Oser Avenue, Hauppauge, New York 11788, 516-233-3300  
16808 Marquardt Avenue, Cerritos, California 90701, 562-802-5100  
Audiovox Canada  
405 Britannia Rd. East, Ste 101, Mississauga, Ontario, Canada  
L4Z3E6, 905-712-9299  
Audiovox Pacific Pty Ltd  
110 Rocky Point Road, Kogarah, NSW 2217, Australia, 02-9587-0011  
Audiovox New Zealand Pty Ltd  
Unit B, 6 Henderson Place, Auckland, 6496345720  
Audiovox Singapore Pte Ltd  
268 Orchard Road, #07-07, Singapore, 238856, 65-733-5902  
<http://www.audiovox.com>

©1997 Audiovox Corporation

## GENERAL SPECIFICATIONS

Frequency Range:	
Transmit:	824.030 to 848.980 MHz
Receive:	869.030 to 893.980 MHz
Number of RF Channels:	2412 Channels, Full Duplex
Channel Spacing:	10 KHz
Duplex Spacing:	45 MHz
Frequency Stability:	±1.0 PPM
Operating Temperature:	
Main Unit:	-22°F to +140°F (-30°C to +60°C)
Battery:	+5°F to +122°F (-15°C to +50°C)
Battery Charging	
Temperature:	+41°F to +104°F (5°C to +40°C)
Supply Voltage:	4.8 V – DC
RF Power Output:	0.6 W
Dimensions:	6.3" × 2.3" × 0.9" (159 mm × 60 mm × 24 mm)

### Weight:

with Standard Extended life	
Ni-MH Battery:	Approx. 8.1 oz. (229 g)
with Ni-Cad Battery:	Approx. 7.6 oz. (216 g)
with Slim profile Ni-MH Battery:	Approx. 7.6 oz. (216 g)

### Talk Time:

with Standard Extended life	
Ni-MH Battery:	Approx. 120 Minutes
with Ni-Cad Battery:	Approx. 80 Minutes
with Slim profile Ni-MH Battery:	Approx. 80 Minutes

### Stand-by Time:

with Standard Extended life	
Ni-MH Battery:	Approx. 20 Hours
with Ni-Cad Battery:	Approx. 12 Hours
with Slim profile Ni-MH Battery:	Approx. 12 Hours

\* Subject to change without notice.

## TABLE OF KEY OPERATION

Key operation	Function
$\text{PWR}$	Holding $\text{PWR}$ turns your phone on and off.
Phone No. + $\text{FNC} + 1$	Stores to Scratch Pad Memory.
$\text{FNC} + 3 \text{DEF}$ (During conversation)	Turns the DTMF tone on and off.
$\text{FNC} + 5 \text{JKL} + 3$ Digit Code	Locks your phone electronically.
$\text{FNC} + 6 \text{MNO} + \blacktriangle$	Displays current scan mode.
$\text{FNC} + 6 \text{MNO} + \blacktriangle + \blacktriangle \dots \text{R/S}$	Selects Scan Mode.
$\text{FNC} + 7 \text{PRS} + 1$ +3 Digit Code + $\blacktriangle / \blacktriangledown$ + $\text{R/S}$	Turns the Message Mode on and off.
$\text{FNC} + 7 \text{PRS} + 2 \text{ABC}$	Turns the Message Beep on and off.
$\text{FNC} + 8 \text{TUV}$	Turns the Silent Alert mode on and off.
$\text{FNC} + 9 \text{WXYZ}$	Turns the Automatic Answer mode on and off.
$\text{FNC} + \text{MT ALPHA}$	Enters the Alphanumeric entry mode.
$\text{FNC} + * \rightarrow + 1$	Turns the Call Time Warning Tone on and off.
$\text{FNC} + * \rightarrow + 2 \text{ABC} + 0 \text{OPER}$	Displays the temporarily accumulated number of calls.
$\text{FNC} + * \rightarrow + 2 \text{ABC} + 1$ +2 Digit Code	Displays the number of outgoing calls.
$\text{FNC} + * \rightarrow + 2 \text{ABC} + 2 \text{ABC}$ +2 Digit Code	Displays the accumulated number of calls.
$\text{FNC} + * \rightarrow + 3 \text{DEF} + 0 \text{OPER}$	Displays the time of current or last call.
$\text{FNC} + * \rightarrow + 3 \text{DEF} + 1$ +2 Digit Code	Displays the time of outgoing calls.
$\text{FNC} + * \rightarrow + 3 \text{DEF} + 2 \text{ABC}$ +2 Digit Code	Displays the cumulative call time.
$\text{FNC} + * \rightarrow + 4 \text{GHI}$ +3 Digit Code + New Emergency No. + $\blacktriangle / \blacktriangledown$ + $\text{R/S}$	Changes Emergency Number and turns the One Touch Emergency call mode on and off.
$\text{FNC} + * \rightarrow + 5 \text{JKL}$ +3 Digit Code	Activates the Call Restriction mode.

Key operation	Function
$\text{FNC} + * \rightarrow + 6 \text{MNO}$	Displays the current SID, current Channel and the RSSI Level.
$\text{FNC} + * \rightarrow + 9 \text{WXYZ} + 0 \text{OPER}$ + $\blacktriangle / \blacktriangledown$	Adjusts the earpiece volume level.
$\text{FNC} + * \rightarrow + 9 \text{WXYZ} + 1$ + $\blacktriangle / \blacktriangledown$	Adjusts the alert sound output volume level.
$\text{FNC} + * \rightarrow + 9 \text{WXYZ} + 2 \text{ABC}$ + $\blacktriangle / \blacktriangledown$	Adjusts the tone volume level.
$\text{FNC} + * \rightarrow + 9 \text{WXYZ} + 3 \text{DEF}$ + $\blacktriangle / \blacktriangledown$	Adjusts the Message Beep volume level.
$\text{FNC} + \# \rightarrow + 1$	Displays own telephone number.
$\text{FNC} + \# \rightarrow + 2 \text{ABC}$	Displays your Electronic Serial Number (ESN).
$\text{FNC} + \# \rightarrow + 3 \text{DEF}$	Displays the Home System ID (SIDH).
$\text{FNC} + \# \rightarrow + 5 \text{JKL} + 1$	Changes your Lock/Unlock Code.
$\text{FNC} + \# \rightarrow + 5 \text{JKL} + 2 \text{ABC}$	Changes your Call Restriction Access Code.
$\text{FNC} + \# \rightarrow + 5 \text{JKL} + 3 \text{DEF}$	Changes your Call Counter Access Code.
$\text{FNC} + \# \rightarrow + 5 \text{JKL} + 4 \text{GHI}$	Changes your Air Timer Access Code.
$\text{FNC} + \# \rightarrow + 8 \text{TUV}$	Changes the Keypad (DTMF) Tone Duration
$\text{FNC} + \# \rightarrow + * \rightarrow + 3$ Digit Code + PIN + $\blacktriangle / \blacktriangledown$ + $\text{R/S}$	Enters PIN and turns PIN feature on and off
$\text{CLR} + 5$ Digit New SID + 10 Digit Phone No. + $\text{FNC} + \# \rightarrow + \# \rightarrow$ +3 Digit Code	Multiple City Registration (Changes the phone number and SIDH)
$\text{CLR}$	Clears the last digit. If held in, erases the entire number from display.
$\text{CLR} + \text{END}$	Clears the entire number from display.
Phone No. + $\text{FNC} + \text{R/S}$ + Memory Location No.	Stores the telephone number in the memory.

Key operation	Function
Phone No.+ $\text{FNC} + \text{M+ALPHA}$ +Name+ $\text{FNC} + \text{R/S}$ +Memory Location No.	Stores the telephone number and the alphanumeric information in the memory.
Phone No.+ $\text{FNC} + \text{R/S} + \text{R/S}$	Searches the vacant memory and stores the telephone number automatically.
Phone No.+ $\text{FNC} + \text{M+ALPHA}$ +Name+ $\text{FNC} + \text{R/S} + \text{R/S}$	Searches the vacant memory and stores the telephone number and alphanumeric information automatically.
Phone No.+ $\text{FNC} + \text{R/S} + \text{▲} / \text{▼}$	Searches the vacant memory address to store.
$\text{R/S} + \text{#} + \text{OPER} / 1 / 2 \text{ABC}$	Displays the telephone number of three latest calls.
$\text{R/S} + \text{Memory Location No.}$	Recalls the telephone number from the memory.
$\text{R/S} + \text{*} \text{↔}$ +Memory Location No.	Adds the DTMF tone to the recalled number.
$\text{R/S} + \text{▲} / \text{▼}$	Recalls the telephone number in address order.
$\text{FNC} + \text{M+ALPHA} + \text{Name}$ + $\text{R/S} + \text{▲} / \text{▼}$	Searches the telephone number by alphanumeric characters.
$\text{M+ALPHA}$	In standby mode, holding $\text{M+ALPHA}$ initiates a call to the number stored in One Touch Memory or Link Dialing Memory. During conversation, except Link Dialing, pressing $\text{M+ALPHA}$ switches the Mute mode on and off. During conversation mode of Link Dialing, pressing $\text{M+ALPHA}$ activates Link Dialing in order. In alphanumeric entry mode, pressing $\text{M+ALPHA}$ toggles between phone number entry and name entry mode.
$\text{SEND}$	Receives the call when "Call" is flashed in the display. Redials the last number dialed when "Ready" is displayed.
Phone No.+ $\text{SEND}$	Processes the call.
$\text{END}$	Terminates the call.

## 12 MONTH LIMITED WARRANTY

AUDIOVOX COMMUNICATIONS CORPORATION (the Company), warrants to the original retail purchaser of this Audiovox Cellular Telephone, that should this product or any part there of (except the items listed below), under normal use and conditions, be proven defective in material or workmanship within the first twelve (12) month period from the date of purchase, such defect(s) will be repaired or replaced (with new or rebuilt parts) at the Company's option, without charge for parts or labor directly related to the defect(s). Accessories, if supplied, except rechargeable battery packs, are similarly warranted for 12 months. Battery packs are warranted from the date of purchase for 90 days.

To obtain repairs or replacement within the terms of this Warranty, the product should be delivered with proof of warranty coverage, specification of defect(s), transportation prepaid, to the Company at the address shown below.

In the United States call toll free to (800) 229-1235 [in NY State and other areas, call (516) 233-3410]

This Warranty does not apply to fuses, or costs incurred for removal, reinstallation, testing, evaluation, or to any product or part there of which has suffered through alteration, serial number defacement, improper installation, excessive temperature or humidity, environmental conditions, mishandling, misuse, neglect or accident. This Warranty is not assignable or transferable. THE EXTENT OF THE COMPANY'S LIABILITY UNDER THIS WARRANTY IS LIMITED TO THE REPAIR OR REPLACEMENT PROVIDED ABOVE AND, IN NO EVENT, SHALL THE COMPANY'S LIABILITY EXCEED THE PURCHASE PRICE PAID BY PURCHASER FOR THE PRODUCT.

The Company disclaims liability for geographic coverage, inadequate signal to antenna, communications range or operation of the Cellular System as a whole. ANY IMPLIED WARRANTIES, INCLUDING ANY IMPLIED WARRANTY OF MERCHANTABILITY SHALL BE LIMITED TO THE DURATION OF THIS WRITTEN WARRANTY, ANY ACTION FOR BREACH OF ANY WARRANTY HEREUNDER INCLUDING ANY IMPLIED WARRANTY OF MERCHANTABILITY MUST BE BROUGHT WITHIN A PERIOD OF 24 MONTHS FROM DATE OF ORIGINAL PURCHASE. IN NO CASE SHALL THE COMPANY BE LIABLE FOR ANY CONSEQUENTIAL OR INCIDENTAL DAMAGES FOR BREACH OF THIS OR ANY OTHER WARRANTY, EXPRESS OR IMPLIED, WHATSOEVER.

No person or representative is authorized to assume for the Company any liability other than expressed herein in connection with the sale of this product.

Some states do not allow limitations on how long an implied warranty lasts or the exclusion or limitation of incidental or consequential damage so the above limitation or exclusions may not apply to you. This Warranty gives you specific legal rights, and you may also have other rights which vary from state to state.

IN U.S.A.: AUDIOVOX COMMUNICATIONS CORPORATION

185 Oser Avenue, Hauppauge, New York 11788 (516) 233-3300

IN CANADA: AUDIOVOX CANADA, LTD.

405 Britannia Road East Suite 101 Mississauga, Ontario L4Z 3E6 (905) 712-9299 (800) 465-9672

# INDEX

Accessory Catalog .....	45
Automatic Lock .....	18
Automatic Redial .....	16
Automatic Storage .....	22
Battery Operation .....	10
Call Counter Display .....	31
Call Restriction .....	29
Call Time Warning Tone .....	33
Call Timer Display .....	30
Caller ID .....	42
Emergency and Priority Dialing .....	28
ESN Display .....	35
Function Review .....	36
Key/Display Names and Functions .....	8
Keypad Disable .....	18
Keypad Tones .....	30
Link Dialing .....	26
Locking .....	17
Manual Storage .....	20
Memory Dialing .....	24
Memory Search .....	24
Message Review .....	39
Mic Mute .....	16
Multiple City Registration .....	34
One Touch Dialing .....	27
One Touch Emergency Call .....	27
PIN Feature .....	35
Placing Calls .....	14
Receiving Calls .....	14
Redialing (Last three numbers dialed) .....	15
Scratch Pad Memory .....	28
Speed Dialing .....	25
System ID (Current System ID) Display .....	35
System ID (Own System ID) Display .....	13
System Selection .....	33
Table of Key Operation .....	50
Telephone Number (Own) Display .....	13
Unlocking .....	17
Volume Adjustment .....	16

## Free Manuals Download Website

<http://myh66.com>

<http://usermanuals.us>

<http://www.somanuals.com>

<http://www.4manuals.cc>

<http://www.manual-lib.com>

<http://www.404manual.com>

<http://www.luxmanual.com>

<http://aubethermostatmanual.com>

Golf course search by state

<http://golfingnear.com>

Email search by domain

<http://emailbydomain.com>

Auto manuals search

<http://auto.somanuals.com>

TV manuals search

<http://tv.somanuals.com>