

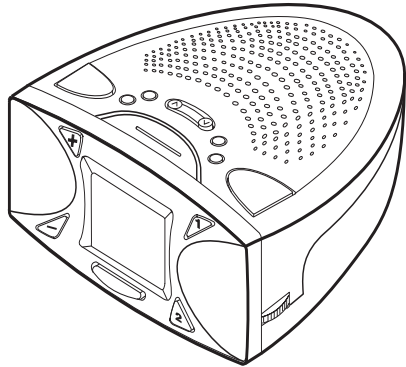



DIGITAL CLOCK RADIO

OPERATION INSTRUCTION



WARNING

EXPLANATION OF GRAPHICAL SYMBOLS:

 <p>WARNING RISK OF ELECTRIC SHOCK DO NOT OPEN</p> 	 <p>The lightning flash with an arrowhead symbol, within the equilateral triangle, is intended to alert the user to the presence of uninsulated "dangerous voltage" within the product's enclosure that may be of sufficient magnitude to constitute an electric shock to persons.</p>
<p>"WARNING: TO REDUCE THE RISK OF ELECTRIC SHOCK, DO NOT REMOVE COVER (OR BACK). NO USER-SERVICABLE PARTS INSIDE. REFER SERVICING TO QUALIFIED SERVICE PERSONNEL."</p>	 <p>The exclamation point within the equilateral triangle is intended to alert the user to the presence of important operating and maintenance (servicing) instructions in the literature accompanying the appliance.</p>

WARNING: TO PREVENT FIRE OR SHOCK HAZARD, DO NOT EXPOSE THIS APPLIANCE TO RAIN OR MOISTURE.

PRECAUTION

Follow the advice below for safe and appropriate operation.

ON PLACEMENT

- Do not use the unit in places which are extremely hot, cold, dusty, or humid.
- Place the unit on a flat and even surface.
- Do not restrict the air flow through the ventilation slots by placing the unit on soft furnishings, by covering the unit with a piece of cloth or by placing the unit on a carpet.

ON AC VOLTAGE

- Before using, check that the rated voltage of your unit matches your local voltage.

ON SAFETY

- When connecting and disconnecting the AC cord, grip the plug instead of the cord itself. Pulling the cord may damage it and create hazard.
- When you are not going to use the unit for a long period of time, disconnect the AC power cord.

FCC INFORMATION (FOR USA ONLY)

This device complies with Part 15 of FCC Rules.

Operations are subject to the following two conditions:

- This device may not cause harmful interference, and
- This device must accept any interference received, including interference that may cause undesirable operations.

Should any trouble occur, disconnect the AC power cord and refer servicing to qualified personnel.

LOCATION OF CONTROLS

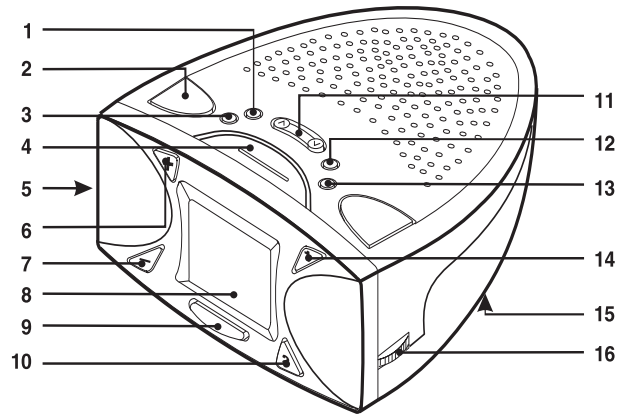

- | | |
|------------------------|--|
| 1. SET/MEMORY Knob | 10. ALARM2 Knob |
| 2. POWER (ON/OFF) Knob | 11. H...TIME SET...M (Hour/Minute) /TUNING Control |
| 3. BAND Knob | 12. SLEEP Knob |
| 4. SNOOZE Knob | 13. DIMMER Knob |
| 5. BUZZER/RADIO Switch | 14. ALARM1 Knob |
| 6. PRESET (+) Knob | 15. RESET Knob |
| 7. PRESET (-) Knob | 16. VOLUME Control |
| 8. DISPLAY | |
| 9. COLORS Knob | |

CLOCK SETTING

- The clock display and adjustment must be in radio off.

- Connect AC power, the clock digital will indicate on screen.
- Check that the rated voltage of your unit matches your local voltage.



- Press "SET/MEMORY" knob, the clock digital will flash.

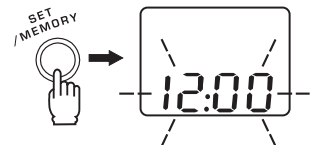

- Press " H...TIME SET...M/TUNING " knob to adjust the Hour/Minute.

- When " PM " appears, it comes to set noontime.

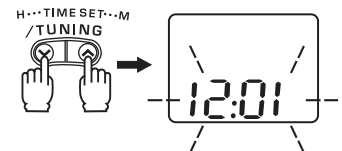

- Press " MEMORY " knob to store.

DIMMER FUNCTION

- Press "DIMMER" knob to change the LCD display brightness.
- Press "COLORS" knob to repeatedly select the multi-color display changed cyclically as below.

RED → ORANGE → GREEN

DUAL ALARM SETTING

- Operation must be in radio off.
- The unit can alarm twice per day by setting different alarm time in **ALARM1** and **ALARM2**.
- The radio can wake up to alarm with "Radio" or "Buzzer" sound by putting switch in RADIO or BUZZER position.

ALARM1 SETTING

1. Press "ALARM1" knob, "🔔" icon will flash.
2. Press "MEMORY" knob, timer icon will flash.
3. Press "H...TIME SET...M / TUNING" knob to adjust Hour/Minute.
4. Press "MEMORY" knob to store.

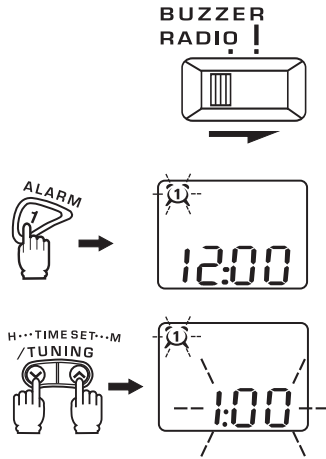

ALARM2 SETTING

1. Press "ALARM2" knob, "🔔" icon will flash.
2. Press "MEMORY" knob, timer icon will flash.
3. Press "H...TIME SET...M / TUNING" knob to adjust Hour/Minute.
4. Press "MEMORY" knob to store.

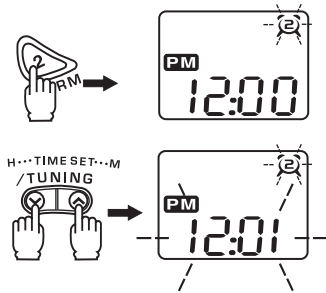

5

DUAL ALARM SETTING

NOTE:

- The clock radio will wake up to "Radio" or "Buzzer" when alarm timer comes to the preset time. After about 10 seconds, the volume of alarm will increase.
- To stop "Radio" or "Buzzer" sound by pressing any knob.
- The alarm will continue after 5 minutes if press the "SNOOZE" knob.
- The "Radio" or "Buzzer" sound will automatically turn off after 60 minutes if not press any knob.



- To clear the preset alarm time by pressing "ALARM1" or "ALARM2" knob twice, until "🔔" or "🔔" icon flashes. Alarm function will be cancelled automatically after few seconds.
- To activate the preset alarm time, press "ALARM1" or "ALARM2" knob repeatedly until "🔔" or "🔔" icon appears on the display.
- Press "ALARM1" or "ALARM2" knob to check and modify the preset ALARM time.
- Can not set "Radio" and "Buzzer" alarms at the same time.
- The clock radio alarms only one time, if the alarm setting time of ALARM1 and ALARM2 are same.

SLEEP TIMER SETTING

1. Press "SLEEP" knob to set the sleep time.
2. Press "SLEEP" knob to repeatedly select the desired time changed cyclically as below.

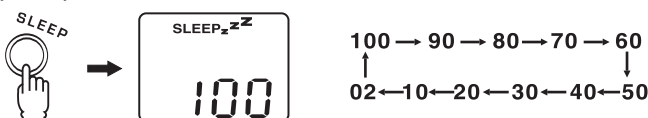

- The power will be off automatically once unit reaches the sleep time.
- To clear the preset sleep time by pressing "SLEEP" knob till "SLEEP" disappears from the display.

6

RADIO RECEPTION

VOLUME ADJUSTMENT

Adjust the **VOLUME** control to obtain the desired volume level before using the unit.



SELECT BAND

1. Press "POWER ON/OFF" knob to turn on radio.
2. Press "BAND" knob to repeatedly select FM or AM, the band changed shown in display.
3. Press "H...TIME SET...M / TUNING" knob to select the desired station.

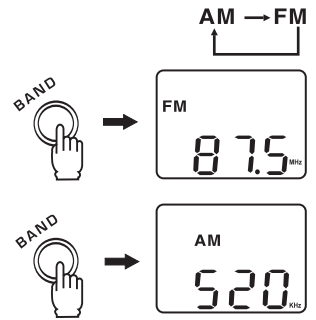

PRESET CHANNEL

- There are up to 10 preset channels in each band.
- Press PRESET knob to select preset channel stored in memory.
- Operation must be in radio on.

1. Press "MEMORY" knob until "MEMORY" flashes on screen.
2. Press "PRESET +" knob to increase channel, press "PRESET -" knob to decrease channel.

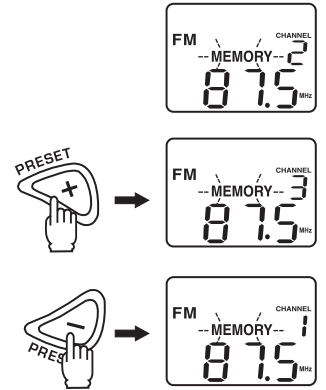

3. Press "MEMORY" knob to store.

7

RADIO RECEPTION

FOR BETTER RECEPTION

FM: Extend the FM wire antenna fully.

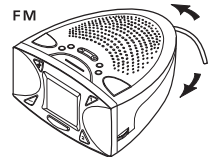

AM: Turn the unit to find the position which gives the best reception.

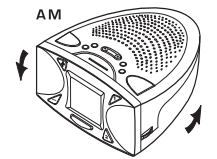

NOTE:

Do not connect FM wire antenna to external antenna.

RESET FUNCTION

To delete all setting information by pressing "RESET" knob on the bottom of unit, at the same time the system will resume the specified initial state which set before leaving the factory.



SPECIFICATION

Power requirements	AC 120V/60Hz
Power consumption	4W

Specification and external appearance are subject to change without advance notice due to continuous product improvement.

Printed in china
811-CR3891-010

8

Free Manuals Download Website

<http://myh66.com>

<http://usermanuals.us>

<http://www.somanuals.com>

<http://www.4manuals.cc>

<http://www.manual-lib.com>

<http://www.404manual.com>

<http://www.luxmanual.com>

<http://aubethermostatmanual.com>

Golf course search by state

<http://golfingnear.com>

Email search by domain

<http://emailbydomain.com>

Auto manuals search

<http://auto.somanuals.com>

TV manuals search

<http://tv.somanuals.com>