



AUDIOVOX

MODEL:D1730

USER'S GUIDE



**PORTABLE
DVD
VIDEO
PLAYER**



128-6430

SAFETY PRECAUTIONS

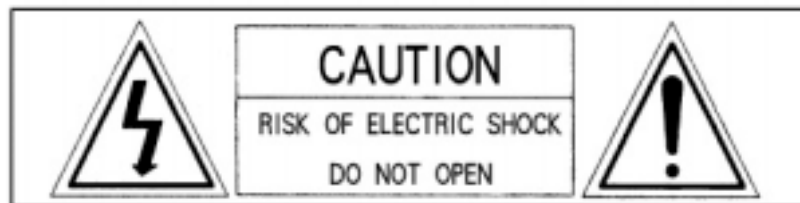

°§ The lightning flash with arrowhead symbol within an equilateral triangle is intended to alert the user to the presence of uninsulated "dangerous voltage" within the product's enclosure that may be of sufficient magnitude to constitute risk of electric shock to persons.



°§ The exclamation point within an equilateral triangle is intended to alert the user to the presence of important operating and maintenance (servicing) instructions in the literature accompanying the product.

WARNING: To reduce the risk of fire or electric shock, do not expose this appliance to rain or moisture. Dangerous high voltage is present inside the enclosure. Do not open the cabinet.

CAUTION: To prevent electric shock, match wide blade plug to wide slot and fully insert.

CAUTION: The unit employs a laser system. To ensure the proper use of the unit, read this manual carefully and keep it for future reference. If the unit requires servicing, contact the seller or our service center. (See "troubleshooting".)

To prevent direct exposure to the laser radiation, do not open the cabinet. Invisible laser radiation is present when the cabinet is opened or the interlocks are defeated. Do not stare into the laser beam.

Use of any controls, adjustments, or procedures other than those specified herein may result in hazardous radiation exposure.

WARNING: Any change or modification to the unit, not expressly approved by **AUDIOVOX** or its authorized parties, could void user's authority to operate the unit.

SAFETY PRECAUTIONS

POWER SOURCES

This unit can operate on an AC adapter (included), car cigarette lighter adapter (optional) and rechargeable battery (included).

- °§ Make sure that the input voltage to the AC adapter is 100~120VAC; otherwise, the AC adapter and unit may be damaged.
- °§ Do not touch the AC adapter with wet hands so as to avoid electric shocks.
- °§ When connecting with car power (cigarette lighter) adapter, be sure the DC input voltage to the adapter is identical with car voltage (+12VDC).
- °§ Unplug the AC adapter from the outlet or remove the rechargeable batteries when the unit is not used for a long time.
- °§ Hold the plug to disconnect the AC adapter. Do not pull the power cord.

ON PLACEMENT

Avoid placing the unit in the following places:

- °§ Under direct sunlight or near a source of heat such as a heater.
Never leave the unit in a closed automobile, on a dashboard or a parcel shelf. Excess heat may deform the unit enclosure or cause a malfunction.
- °§ Where it is very dusty or sandy.
- °§ Wet or humid places, such as bathroom.
- °§ Near sources of strong magnetism, such as television, speaker, or magnet.
- °§ Where there is a lot of movement or vibration, such as on a car dashboard or an unstable shelf.
- °§ Where it is extremely hot or cold.
- °§ Where the unit is exposed to rain or water.

FOR SAFETY

- °§ Do not disassemble the unit; laser rays are dangerous to the eyes.

Any service should be done by qualified service personnel.

SAFETY PRECAUTIONS

°§Unplug the AC adapter to cut the power if liquid or objects get inside the unit.

°§Take care not to drop the unit or subject it to strong shocks, which may cause malfunction.

Note: When unit is in use for a long period of time, the surface of the unit will be heated. This should not affect playback ability.

MAINTENANCE FOR PICKUP

°§If the unit is suddenly moved from a cold place to a warm one to experience a rapid temperature change, or the unit is put in a humid place, moisture will condense on the pickup lens and result in malfunction or playback difficulties. In this case, unload the disc and leave the unit on for about one hour to evaporate the moisture.

°§Keep dust from the pickup lens. Keep the disc tray closed after use. If there is dust on the pickup lens, use a cleaning disc to clean them. Please refer to the operation instructions of the cleaning disc you bought.

WHEN USING HEADPHONES

°§To avoid hearing damage caused by a sudden volume increase, keep the volume at the lowest level before play back. Then adjust it to needed level.

°§Keep the volume lower to protect your ears.

°§Never wear headphones when driving or riding bicycle so as to avoid traffic accidents.

IMPORTANT SAFETY INSTRUCTIONS

- (1) Read instructions - All the safety and operating instructions should be read before the product is operated.
- (2) Retain instructions - The safety and operating instructions should be retained for future reference.
- (3) Warnings - All warnings on the product and in the operating instructions should be adhered to.
- (4) Follow instructions - All operating and use instructions should be followed.
- (5) Cleaning - Unplug this product from the wall outlet before cleaning. Do not use liquid cleaners or aerosol cleaners. Use a damp cloth for cleaning.
- (6) Attachments - Do not use attachments not recommended by the product manufacturer as they may cause unwanted hazards.
- (7) Water and moisture - Do not use this product near water - for example, near a bath tub, wash bowl, kitchen sink, or laundry tub; in a wet basement; or near a swimming pool; and the like.
- (8) Accessories - Do not place this product on an unstable cart, stand, tripod, bracket, or table. The product may fall, causing serious injury to a child or adult, and serious damage to the product. Use only with a cart, stand, tripod, bracket, or table recommended by the manufacturer, or sold with the product. Any mounting of the product should follow the manufacturer's instructions; use a mounting accessory recommended by the manufacturer.

IMPORTANT SAFETY INSTRUCTIONS

- (9) A product and cart combination should be moved with care. Quick stops, excessive force and uneven surfaces may cause the product and cart combination to overturn.
- (10) Power Sources - This product should be operated only from the type of power source indicated on the rear panel. If you are not sure of the type of power supply to your home, consult your product dealer or local power company. For products intended to operate from battery power, or other sources, refer to the operating instructions.
- (11) Grounding or Polarization - This product may be equipped with a polarized alternating - current line plug (a plug having one blade wider than the other). This plug will fit into the power outlet only one way. This is a safety feature. If you are unable to insert the plug fully into the outlet, try reversing the plug. If the plug should still fail to fit, contact your electrician to replace your obsolete outlet. Do not defeat the safety purpose of the polarized plug.
- (12) Power Cord Protection - Power supply cords should be routed so that they are not likely to be walked on or pinched by items placed upon or against them, paying particular attention to cords at plugs, convenience receptacles, and the point where they exit from the product.
- (13) Lightning - For added protection for this product during a lightning storm, or when it is left unattended and unused for

IMPORTANT SAFETY INSTRUCTIONS

long periods of time, unplug it from the wall outlet and disconnect the antenna or cable system. This will prevent damage to the product due to lightning and power line surges.

- (14) Power Lines - An outside antenna system should not be located in the vicinity of overhead power lines or other electric light or power circuits, or where it can fall into such power lines or circuits. When installing an outside antenna system, extreme care should be taken to keep from touching such power lines or circuits as contact with them might be fatal.
- (15) Overloading - Do not overload wall outlets, extension cords, or integral convenience receptacles as this can result in a risk of fire or electric shock.
- (16) Object and Liquid Entry - Never push objects of any kind into this product; fire or electric shock could result. Never spill liquid of any kind on the product.
- (17) Servicing - Do not attempt to service this product yourself as opening or removing should be accomplished by qualified service personnel.
- (18) Damages Requiring Service - Unplug this product from the wall outlet and refer servicing to qualified service personnel under the following conditions:
 - a) When the power supply cord or plug is damaged.
 - b) If liquid has been spilled, or objects have fallen into the product.
 - c) If the product has been exposed to rain or water.
 - d) If the product does not operate normally by

IMPORTANT SAFETY INSTRUCTIONS

following the operating instructions. Adjust only those controls that are covered by the operating instructions, since improper adjustment of other controls may result in damage and will often require extensive work by a qualified technician to restore the product to its normal operation.

e) If the product has been dropped or damaged in any way.

f) When the product exhibits a distinct change in performance - this indicates a need for service.

(19) Replacement parts - When replacement parts are required, be sure the service technician has used replacement parts specified by the manufacturer or that have the same characteristics as the original part. Unauthorized substitutions may result in fire, electric shock or other hazards.



(20) Safety Check - Upon completion of any service or repair to this product, ask the service technician to perform safety checks to determine that the product is in proper operating condition.

(21) Heat - The product should be situated away from heat sources such as radiators, heat registers, stoves or other products (including amplifiers) that produce heat.

(22) During playback, few bright or dark flecks may appear on the TFT LCD, which is a normal phenomenon in active matrix display technology, but not a malfunction.

FEATURES

1. OUTSTANDING SOUND QUALITY

Dolby Digital  system developed by Dolby Laboratories and DTS  developed by DTS Inc, features high quality surround sound which can be enjoyed during DVD or CD disc play at home.

2. HIGH DEFINITION

The unit adopts MPEG2 coding format and brings the horizontal resolution to over 500 lines.

3. UNIQUE FUNCTIONS

Multi - angle and multi - language enables unique trick functions.

Parental lock makes it easy to control the content of discs.

4. ZOOM

It can enlarge pictures twice or three or four times the original size.

It can also shrink pictures 1/2, 1/3 or 1/4 as big.

5. MULTI - FUNCTIONS

Fast forward, fast reverse, slow play, frame play, repeat play and program play.

6. TIME SEARCH

It can search a specific part on a disc, especially good for watching action movies.

FEATURES

7. RESUME PLAY

It can memorize the position where the disc is stopped and resume playback from this point.

8. CONTENT DISPLAY

7" TFT LCD and English On-Screen-Display (OSD), makes the disc content clearer.

9. AUDIO OUTPUT

Analog audio output and coaxial digital audio output can be connected with any amplifier to enjoy high quality sound effects.

10. TFT color LCD, chargeable batteries and headphone output are all convenient for enjoying great pictures and beautiful music on the go.

Manufactured under license from Dolby Laboratories. "Dolby" and the double - D symbol are trademarks of Dolby Laboratories. Confidential Unpublished works. © 1992-1997 Dolby Laboratories, Inc. All rights reserved.

"DTS" and "DTS Digital Out" are trademarks of Digital Theater Systems, Inc.

TABLE OF CONTENTS

1.	SAFETY PRECAUTIONS	1
2.	IMPORTANT SAFETY INSTRUCTIONS.....	4
3.	FEATURES.....	8
4.	DEFINITION OF TERMS.....	12
5.	PARTS LOCATION	13
	◦ MAIN UNIT	13
	◦ REMOTE CONTROL.....	14
6.	CONNECTIONS.....	15
7.	PREPARATIONS BEFORE OPERATION	17
	◦ USE REMOTE CONTROL.....	17
	◦ PLAYABLE DISCS	18
	◦ USING AC ADAPTOR	19
8.	BASIC OPERATIONS	20
	◦ BEFORE OPERATION.....	20
	◦ LOAD DISC	20
	◦ TFT PICTURE ADJUSTMENT	21
	◦ SYSTEM SETTING	22
	◦ PAUSE	23
	◦ OSD	23
	◦ DVD MENU PLAY	26
	◦ SELECT WITH NUMBER BUTTONS	26
9.	FUNCTION SETTING	27
	◦ MENU SETTING	27
10.	PLAY DISCS IN VARIOUS WAYS	31
	◦ AUDIO MODE	31
	◦ MUTE	32
	◦ FAST PLAY	33
	◦ SLOW PLAY.....	33

TABLE OF CONTENTS

°^ REPEAT PLAY	33
°^ SELECT SUBTITLES	34
°^ SELECT ANGLES	35
°^ TIME SEARCH	35
°^ BOOKMARK	36
°^ ZOOM PLAY	37
°^ PROGRAM PLAY	38
°^ SHUFFLE OR RANDOM PLAY	38
°^ DIGEST PLAY	39
11. MP3 OPERATION	40
12. OTHERS	41
°^ ACCESSORIES	41
°^ PRECAUTIONS FOR DISC	41
°^ TROUBLESHOOTING	42
°^ TECHNICAL SPECIFICATIONS	43
13. USING THE BATTERY PACK	44

DEFINITION OF TERMS

°§TITLE

The images or music of a DVD are divided into a number of units, among which title is the biggest one. To an image in video software, title is movie, to a piece of music in audio software, it is music.

°§CHAPTER

It is smaller than title among the units of a DVD. A title is made up of several chapters, and each chapter has a number for search. But some discs may not have numbered chapters.

°§TRACK

The music in a CD. Each track has a number for search.

STRUCTURE OF DVD

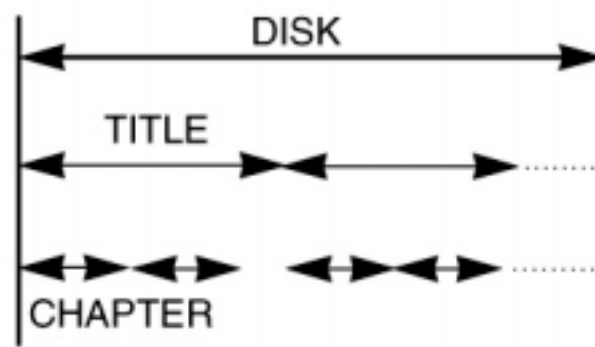

STRUCTURE OF CD

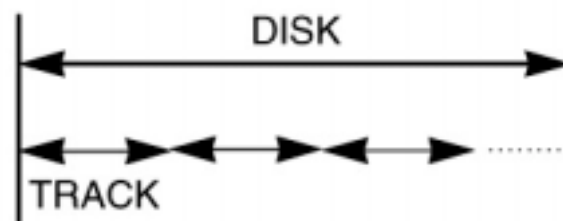

PARTS LOCATION

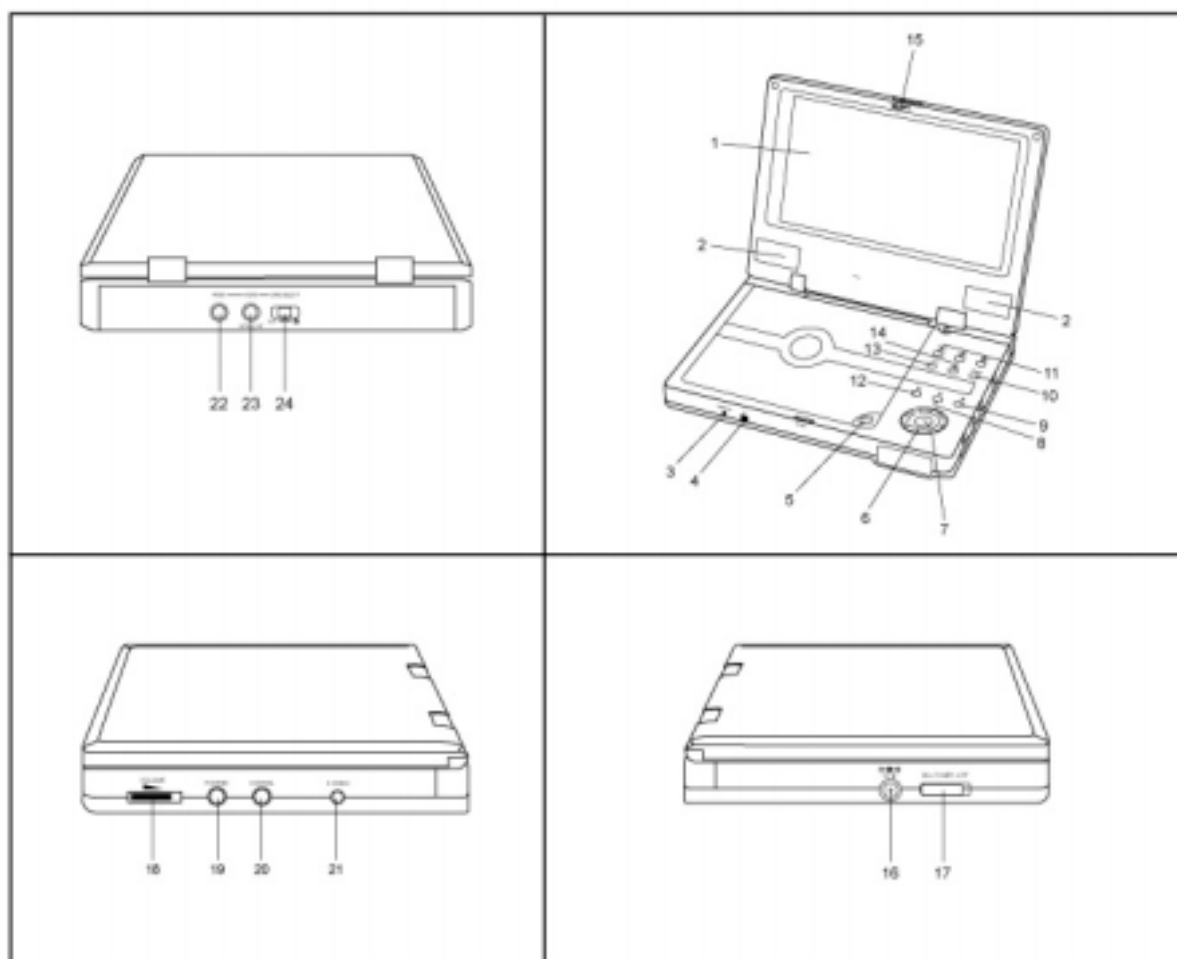

MAIN UNIT

- | | |
|-----------------------------|--------------------------|
| (1) TFT LCD | (13) TITLE |
| (2) SPEAKER | (14) MENU |
| (3) POWER INDICATOR | (15) LOCK |
| (4) REMOTE SENSOR | (16) DC IN |
| (5) PUSH OPEN | (17) POWER ON/OFF |
| (6) DIRECTION BUTTONS | (18) VOLUME |
| (7) OK | (19) PHONES JACK |
| (8) PAUSE | (20) COAXIAL OUT |
| (9) STOP | (21) S-VIDEO OUT |
| (10) RETURN | (22) VIDEO OUT/IN |
| (11) DISPLAY MODE & ►► / ◄◄ | (23) AUDIO OUT/IN |
| (12) PLAY | (24) LINE SELECT(OUT/IN) |

PARTS LOCATION

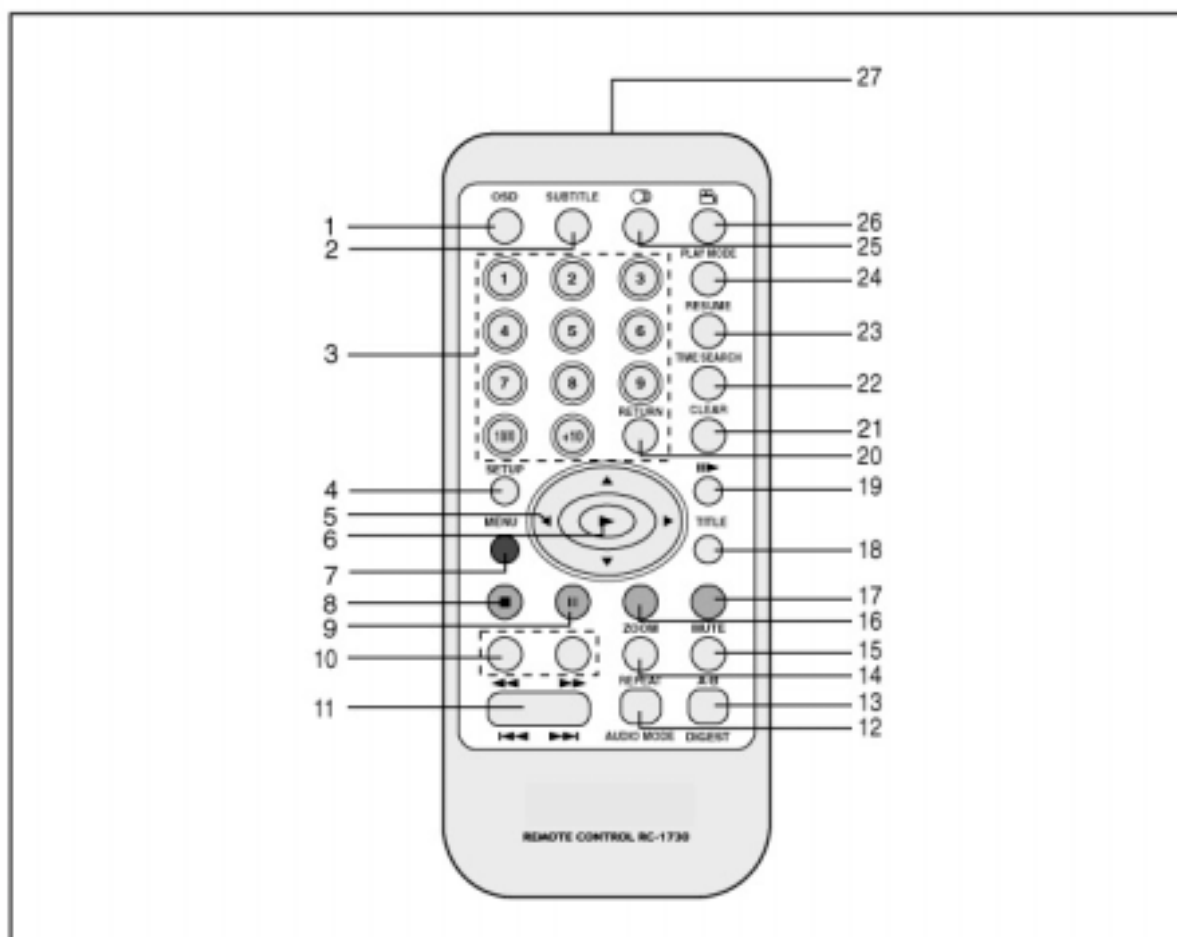

■ REMOTE CONTROL

- | | |
|-----------------------|---|
| (1) OSD | (15) A-B REPEAT |
| (2) SUBTITLE | (16) ZOOM |
| (3) NUMBER BUTTONS | (17) MUTE |
| (4) SETUP | (18) TITLE |
| (5) DIRECTION BUTTONS | (19) SLOW PLAY |
| (6) PLAY | (20) RETURN |
| (7) MENU | (21) CLEAR |
| (8) STOP | (22) TIME SEARCH |
| (9) PAUSE | (23) RESUME |
| (10) FF/FR SEARCH | (24) PLAY MODE |
| (11) PREV/NEXT SKIP | (25) LANGUAGE  |
| (12) AUDIO MODE | (26) ANGLE |
| (13) DIGEST | (27) REMOTE TRANSMITTER |
| (14) REPEAT | |

CONNECTIONS

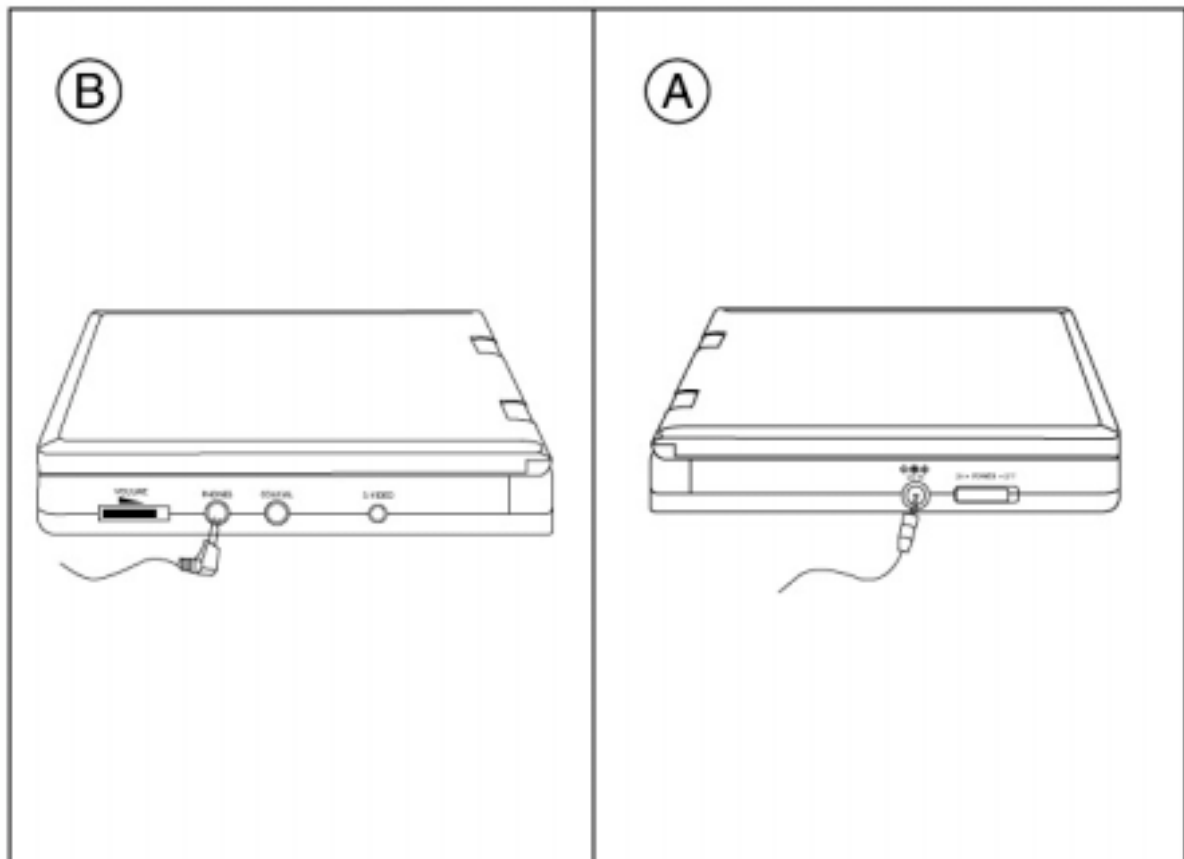

CONNECT TO POWER → (A)

Please make sure that the applied AC adaptor is within the range (100~120VAC) of the local voltage. Connect the applied AC adapter to:

1. DC IN on the left side.
2. The AC power outlet.

USE HEADPHONES → (B)

°§Insert headphones into the phones jack of the unit.

°§Turn off the power when inserting or pulling headphones.

CONNECT TO EXTERNAL EQUIPMENTS

You can connect the unit to a TV or an amplifier to enjoy action VCDs or karaoke.

BEFORE CONNECTIONS

°§Turn off the power to the unit and external equipments.

°§Insert the plug fully.

°§Hold the plug when disconnecting the cord; do not pull the cord.

CONNECTIONS

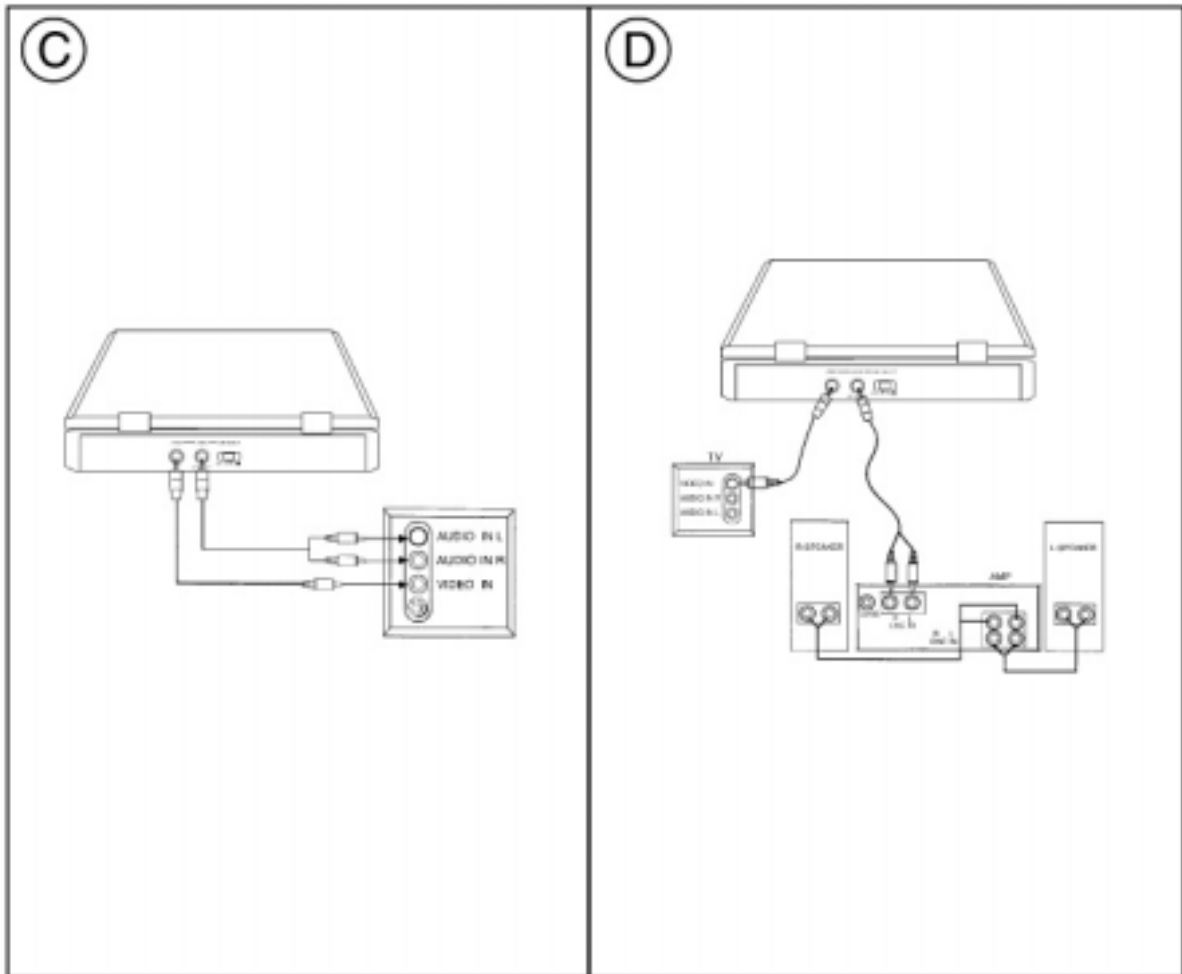

CONNECT TO TV (C)

The AV cords are connected according to diagram (C) :

1. Mini - plug: connect to the VIDEO OUT jack of the unit.
2. Yellow plug: connect to the VIDEO IN jack of the TV.
3. Mini - plug: connect to the AUDIO OUT jack of the unit.
4. Red - plug: connect to the AUDIO IN R jack of the TV.
5. White - plug: connect to the AUDIO IN L jack of the TV.

CONNECT TO TV AND AMPLIFIER (D)

The AV cords are connected according to diagram (D) :

1. Mini - plug: connect to the VIDEO OUT jack of the unit.
2. Yellow plug: connect to the VIDEO IN jack of the TV.
3. Mini - plug: connect to the AUDIO OUT jack of the unit.
4. Red - plug: connect to the LINE IN R jack of the amplifier.
5. White - plug: connect to the LINE IN L jack of the amplifier.

PREPARATIONS BEFORE OPERATION

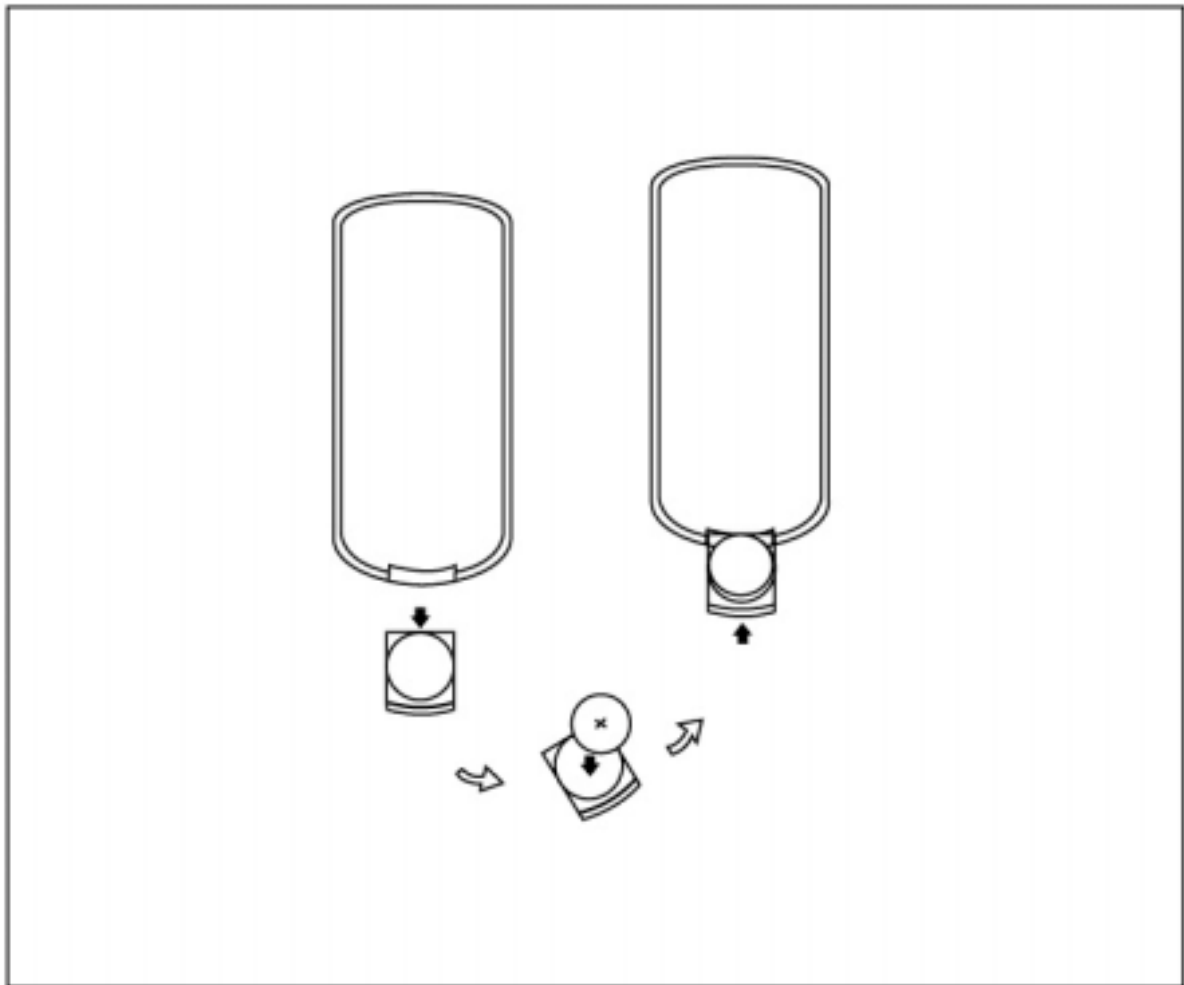

USE REMOTE CONTROL

1. Refer to the diagram, open the battery compartment of the remote control, insert battery, then close the compartment.

NOTE: Remove plastic insulator from battery compartment to permit remote operation, when remote control is shipped with battery already installed.



2. To use the remote control, point it at the remote sensor (IR) of the unit; operate within a distance of 5 meters and 60°.

3. Generally, a battery will last for about one year; replace the battery if the remote control does not work. Observe proper polarity.



4. Remove the battery if remote control is not used for a long time.

PREPARATIONS BEFORE OPERATION

PLAYABLE DISCS

TYPE	DISC LOGO	CONTENT	SIZE	PLAYING TIME
DVD		audio+video (motion pictures)	12cm	about 2hrs(single-side disc) about 4hrs (double-side disc)
			8cm	about 80mins(single-side disc) about 160mins(double-side disc)
CD		audio	12cm	about 74mins
			8cm	about 20mins
MP3		audio	8cm	about 600mins

°§The marks shown in the following chart are used in the manual.

MARK	INDICATION
	functions of DVD
	functions of CD

PREPARATIONS BEFORE OPERATION

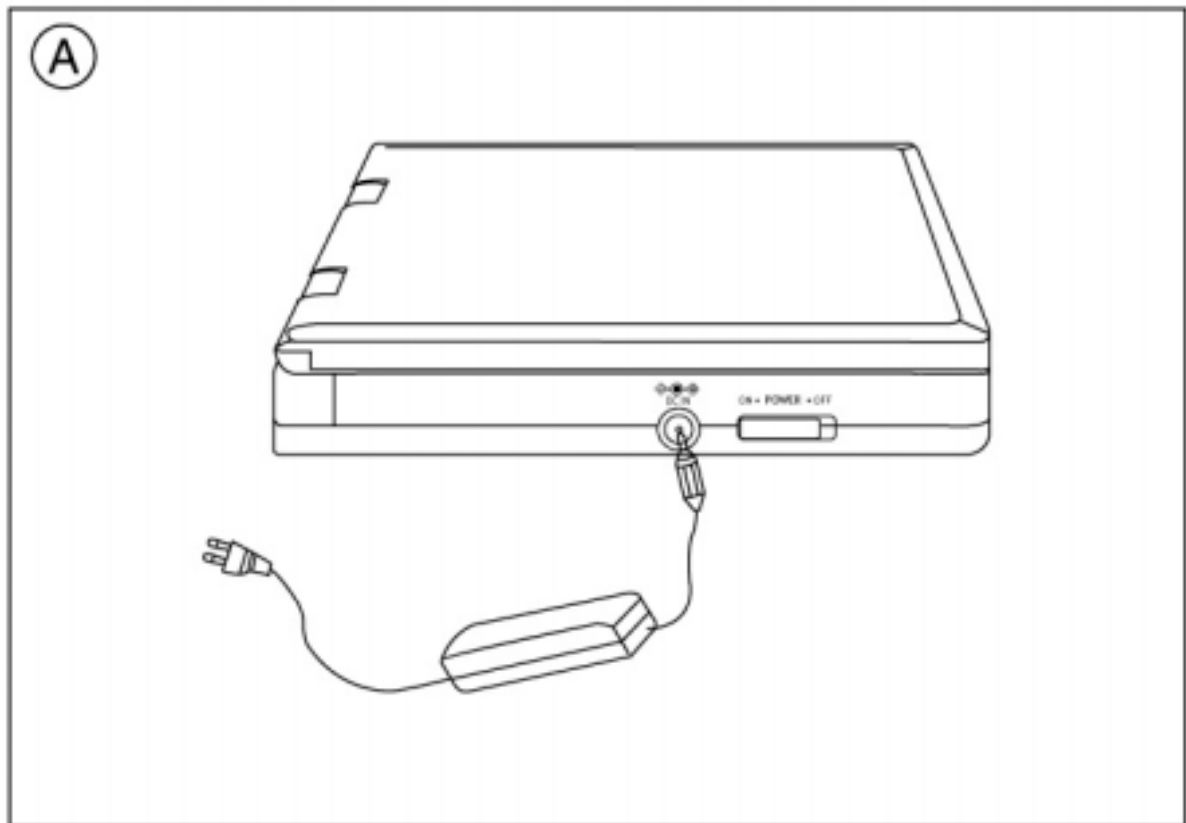

USING THE AC ADAPTER → Ⓐ

The unit can use the special AC adapter supplied.

1. Insert the AC adapter into DC IN jack of the unit.
2. Insert one end of the power supply cord into the input jack of the adapter and the other end into the household mains socket (100~120VAC). At this time, the unit can work normally.

Note: Turn off the unit before unplugging the AC adapter from the unit to avoid damaging the unit.

BASIC OPERATIONS

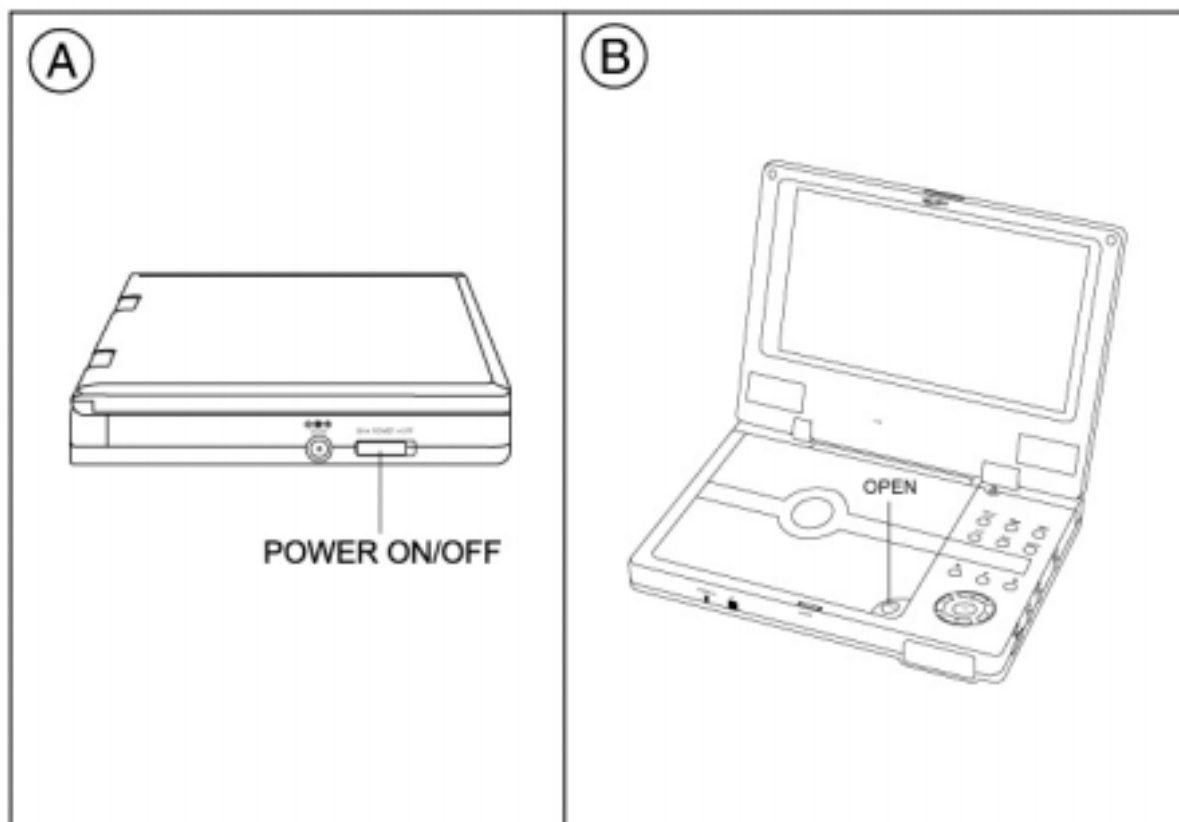

BEFORE OPERATION → (A)

1. Apply power to the unit (POWER ON LED lights red).
2. Press the lock switch to open the cabinet cover.
3. Set POWER ON/OFF switch to ON (POWER ON LED lights green).
4. Turn VOLUME to adjust volume. (including when using headphones).
5. When the unit is connected to a TV or an amplifier, adjust the volume according to owner's manual and set TV to AV mode.

LOAD DISC → (B)

1. Press PUSH OPEN to open the disc tray.
2. Hold the edge of the disc to put it in the center with the label side up.
3. Close the disc tray, wait until it clicks.

BASIC OPERATIONS

TFT PICTURE ADJUSTMENT

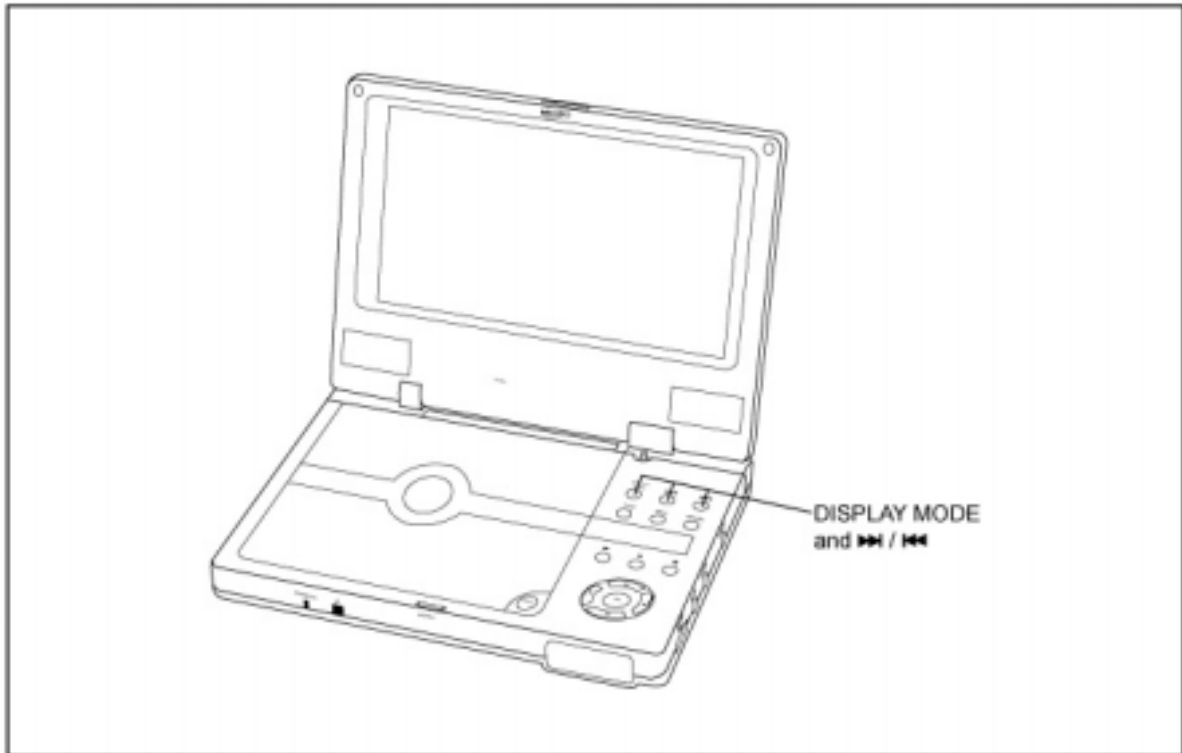

1. If display brightness is unsuitable during playback, press the DISPLAY MODE button to select bright adjustment and press >>> or <<< buttons until desired brightness is achieved.
2. If display (picture) color is unsuitable during playback, press the DISPLAY MODE button to select color adjustment and press >>> or <<< buttons until desired color is achieved.
3. Press the DISPLAY MODE button to select display mode selection and press >>> or <<< buttons to select: Full mode, Normal mode, Zoom mode.

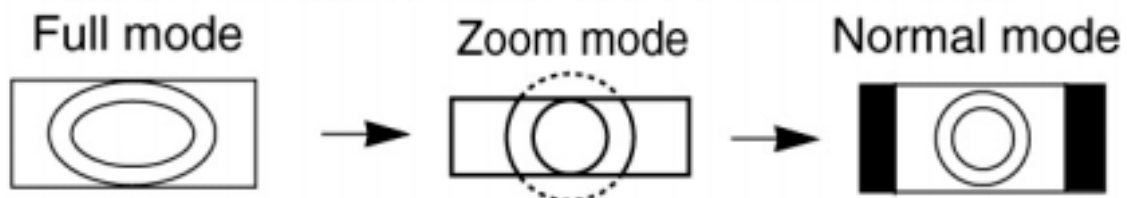

Note: During playback, a few bright or dark flecks may appear on the TFT LCD, which is a normal phenomenon in active matrix display technology, but not a malfunction.

BASIC OPERATIONS

◦^ SYSTEM SETTING

The unit can recognize the color system of the disc automatically and transmit the corresponding signal.

◦§If your TV can only receive PAL system, select the standard of the unit PAL. The unit will keep PAL output in spite of which signal format is used by the disc being played.

◦§If your TV can only receive NTSC system, select the standard of the unit NTSC.

◦§If your TV is multi - system, we advise you to select MULTI to get clearer images.

PLAY DISCS

1. Load a disc and press ► (PLAY) to play the disc.

2. Stop playback.

Press ◦^ .

3. Remove the disc and switch off the unit.

◦§You have to press this "◦^" button twice to stop the playback of DVD discs.

BASIC OPERATIONS

PAUSE

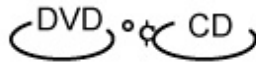



Press 

◦ WHEN PLAYING PICTURES

If the pictures of DVD are played,

press  to pause playback.

The unit enters step play status. Each time you press , the picture advances one frame.

Press  (play) to resume playback.







◦ WHEN PLAYING MUSIC CD

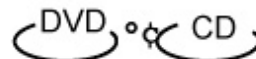

Press  to make playback pause.

Press  (PLAY) to resume playback.

OSD (REMOTE CONTROL UNIT)



The On-Screen-Display (OSD) contains many playback features. To see the Display, press the  button on the remote while a disc is playing. The Display appears across the top of the screen. Each feature is illustrated with an icon. Use the  or  buttons on the remote to move through the different icons in the Display.

When an icon is highlighted, use the  or  buttons on the remote to scroll through the choices displayed in the text box under the icons.

Remember, you can only access the Display when you're playing a disc. Also, the Display features are only available if the disc was created with that particular feature (i.e., if you select the Subtitle icon, you won't be able to change the subtitle language unless the author of the disc created the disc with subtitles).

The invalid symbol "⊗" appears on the screen when you press a button that doesn't have any function. If one of the icons is "grayed out", that Display feature isn't available for the disc you're playing. To make the Display disappear from the screen, press OSD on the remote.



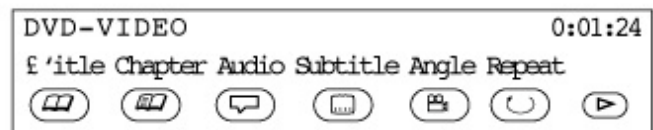

WHEN PLAYING DVD

DVD discs have the following playback features: Title, Chapter, Audio, Subtitle, Angle and Repeat.



◦ Select a Title

Some discs contain more than one title. For example, there might be four movies on one disc (each movie might be considered a title). Each title is divided into chapters. To select a title:

1. While the disc is playing, press  on the remote to bring up the Display.
2. If the Title icon on the Display isn't highlighted, use the  or  buttons to highlight it.
3. Press the  or  buttons to go to the next or previous title.

Note: Some discs only have one title.

◦ Select a Chapter

Because DVD discs use digital technology, a title can be divided into individual chapters (similar to tracks on a CD). You can skip to a specific chapter by using the Chapter feature in the Display.

1. While the disc is playing, press  on the remote to bring up the Display.

BASIC OPERATIONS

2. Press the ◀ or ▶ buttons to highlight the Chapter icon.
3. Press the ▲ or ▼ buttons to go to the next or previous chapter.

Notes: The chapter feature won't work if the disc isn't formatted with separate chapters. You can also advance to the next chapter by pressing ►► on the remote and go to the preceding chapter by pressing ◀◀ on the remote.

◦^ Changing the Audio Language

If the disc was created with different language tracks (recorded in different languages), you can use the Display to temporarily change the DVD player's Audio Language setting.

1. While the disc is playing, press **OSD** on the remote to bring up the Display.
2. Press the ◀ or ▶ buttons to highlight the Audio icon. The current audio language appears in the text box below the row of icons.
3. Press the ▲ or ▼ buttons to scroll through the audio languages that are available on the disc until the audio language you want to use appears in the text box. Audio will be played in that language.
4. To make the Display disappear, press the **OSD** button on the remote.

Note: The language feature only works if the disc was created with multiple audio tracks. When you choose an audio language from the Display, you only override the audio language setting in the DVD player's main menu temporarily.

The audio language can also be changed through the DVD player menu.

◦^ Selecting the Subtitle Language

If the disc was created with subtitles, you can use the Display to change the Subtitle language.

1. When the disc is playing, press **OSD** on the remote to bring up the Display.
2. Press the ◀ or ▶ buttons to highlight the Subtitle icon.
3. Press the ▲ or ▼ buttons to scroll through the subtitle languages that are available on the disc until the subtitle language you want to use appears in the text box. The subtitles will be shown in that language.
4. To make the Display disappear, press the **OSD** button on the remote.

Notes: Changing the subtitle language with the Display will only affect the disc currently being played. When the disc is removed or the player is turned off, the subtitle language will revert to the language setting specified through the DVD player main menu.

The subtitle language can also be changed through the DVD player menu.

◦^ Changing the Camera Angle

Some discs contain multiple angles of a particular scene or sequence. If the disc only has one angle, this feature won't work. When multiple angles are available, to change the camera angle:

1. When a disc is playing, press **OSD** on the remote to bring up the Display.
2. The Angle icon will display the number of angles available. For example, if there are 3 different angles, the icon will read 1 of 3. This means angle 1 is currently being played.
3. Press the ▲ or ▼ buttons to scroll through the angle choices. The angle number displayed in the text window is automatically shown.
4. To make the Display disappear, press the **OSD** button on the remote.

◦^ Using the Repeat Feature

The default mode for the Repeat feature is off. There are three Repeat options:

BASIC OPERATIONS

- °§ All-repeats the disc that is playing
- °§ Title-repeats the title that is playing
- °§ Chapter-repeats the chapter that is playing

To Use Repeat:

1. While a disc is playing, press **[OSD]** on the remote to bring up the Display.
2. Highlight the Repeat icon.
3. Press the **▲** or **▼** buttons to scroll through the Repeat options until the Repeat option you want is displayed in the text box.
4. The selected repeat option will loop repeatedly until you turn Repeat off.

How to Cancel Repeat:

There are three ways to cancel Repeat:

- °§ Press STOP twice.
- °§ Go to Repeat icon in the Display and select Off.
- °§ Eject the disc.

WHEN PLAYING CD

CD discs have the following playback features: Track, L/R, Audio (not available) and Repeat.

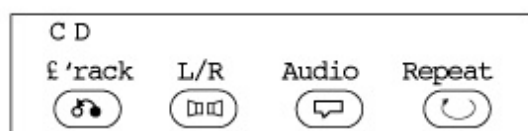

^ Select a Specific Track

1. While the disc is playing, press **[OSD]** on the remote to bring up the Display.
2. Highlight the Track icon.
3. Press the **▲** or **▼** buttons to scroll through the track numbers.

^ Changing the Audio Channel Output

If you are playing a Stereo CD, you can change the channel output from the player.

1. Press **[OSD]** on the remote to bring up the Display.
2. Highlight the L/R icon on the Display.
3. The audio channel choices appear in the text box. Press the **▲** or **▼** buttons to scroll through the choices: LEFT MONO, RIGHT MONO, MIXED MONO or STEREO. Whatever choice is displayed becomes the active choice.

^ Using the Repeat Feature

The default mode for the Repeat feature is off. There are two Repeat options for CDs:

- °§ All-repeats the disc that is playing
- °§ Track-repeats the track that is playing

To Use Repeat:

1. While a disc is playing, press **[OSD]** on the remote to bring up the Display.
2. Highlight the Repeat icon.
3. Press the **▲** or **▼** buttons to scroll through the Repeat options until the Repeat option you want is displayed in the text box.
4. The selected repeat option will loop repeatedly until you turn Repeat off.

BASIC OPERATIONS

DVD MENU PLAY

some DVDs have title menus and chapter menus.

Press ►(PLAY), the screen shows the menu.
Press ►► or ◀◀ to skip to the next or previous page, select with number buttons or direction buttons.

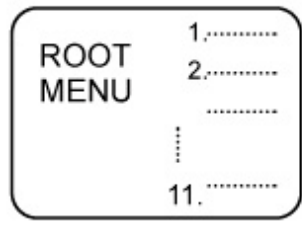

Example: select track 13.

1. Press ►► to enter the next menu.

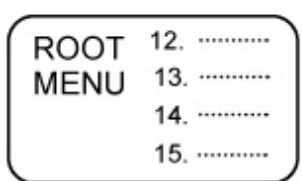

2. Press number buttons to select directly.

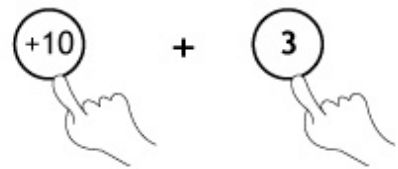

You can also do as follows:

1. Press ▼ to select track 13.

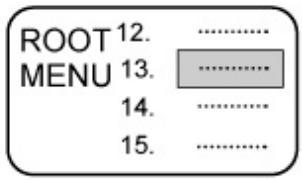

2. Press ► (PLAY) to start playing track 13.

Press **TITLE** once to return to the title menu.
Press **MENU** once to return to the root menu.

SELECT WITH NUMBER BUTTONS

Load a disc. Press number buttons on remote to select tracks after the unit finishes reading the disc.

1. If the track number isn't over 10, just push buttons 1-10.

Example: push **8** to select track 8.



The screen shows:

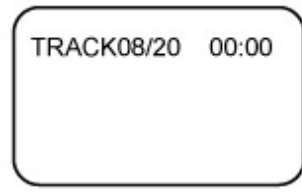

2. If the track number is over 10, press **+10** once and a button among 1-10.

Example: if you select track 12, press **+10** once and button **2**.

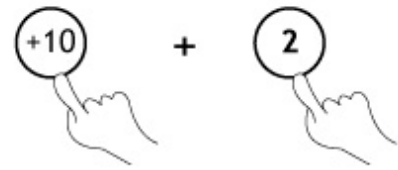

The screen shows:

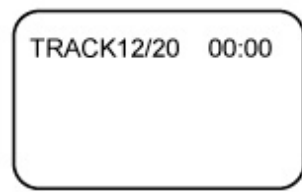

FUNCTION SETTING

MENU SETTING



According to the recorded information and external equipment, set the following functions for the player to obtain the best playing status.

1. Press **SETUP** on the remote to set the main menu.

SETUP



The screen shows:

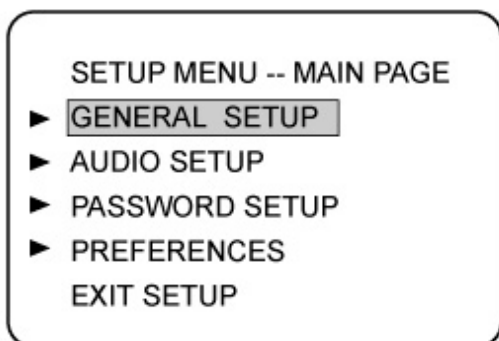

2. Press direction buttons (▶, ▲) to select and press ▶ (PLAY) to confirm.

Example: To select "AUDIO SETUP"

- Press direction button ▼ to highlight.

The screen shows:

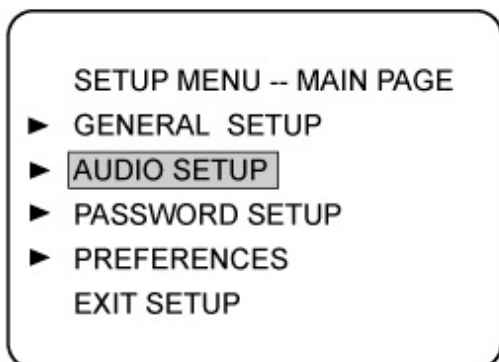

- Press ▶ (PLAY) to confirm and enter "AUDIO SETUP". The screen shows the submenu for your selection.

The screen shows:

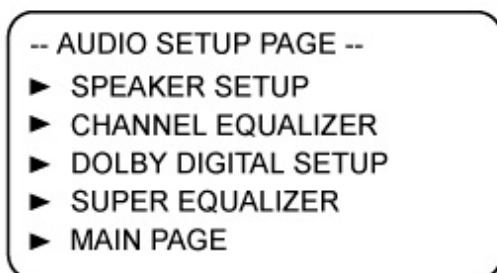

- Press the ▼ button and ▶ (PLAY) to confirm and enter "DOLBY DIGITAL SETUP". The screen shows the submenu for your selection.

The screen shows:

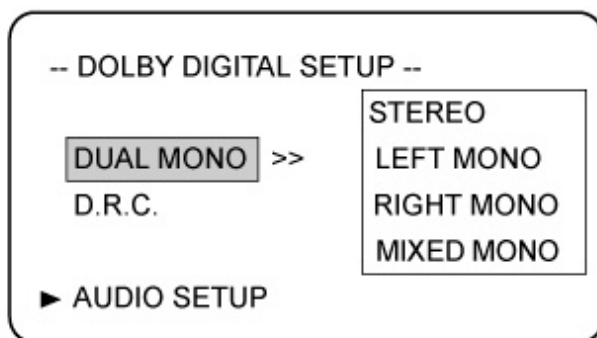

- Press direction button ▶ & ▼ to select "LEFT MONO"

The screen shows:

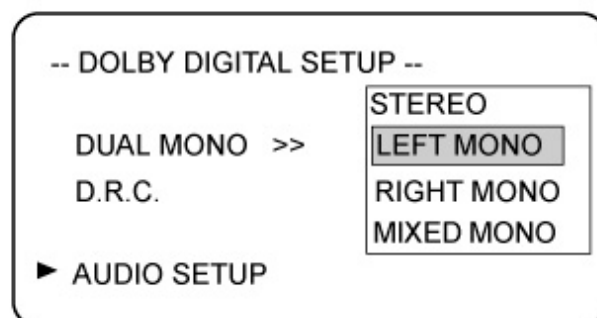

- Press ▶ (PLAY) to confirm selection.



Set "DUAL MONO" in "DOLBY DIGITAL SETUP" to "LEFT MONO".

FUNCTION SETTING

3. Exit from menus.

Press direction buttons and ► (PLAY) to select the relevant exit column.

- Press the direction buttons ▲ ◦◄ to exit from "DUAL MONO".
- Press the direction button ▼ to select "AUDIO SETUP", press ► (PLAY) to exit from the current column and return to the "AUDIO SETUP PAGE".
- Press ▲, ▼ to select "MAIN PAGE", then press ► (PLAY) to return to the main menu.



2. NORMAL/LB

This is selected when the unit is connected to a normal TV. Wide-screen images are shown on the screen, with black belt on the top and bottom.



GENERAL SETUP

The setting structure is as follows:

--GENERAL PAGE--

TV DISPLAY >>	NORMAL/PS NORMAL/LB WIDE
TV TYPE >>	PAL MULTI NTSC
SPDIF >>	OFF SPDIF/RAW SPDIF/PCM
CAPTIONS >>	ON OFF
SCREEN SAVER >>	ON OFF
MENU STYLE >>	TYPE 1 TYPE 2
MAIN PAGE	

◦^ TV DISPLAY

1. NORMAL/PS

This is selected when the unit is connected to a normal TV.

Wide-screen images are shown on the screen, but with some parts cut automatically.

3. WIDE

This is selected when the unit is connected to a wide-screen TV.



◦^ TV TYPE

You may select according to the color system of the TV to be connected.

- Select "MULTI" for a multi-system TV.
- Select "NTSC" for an NTSC TV.
- Select "PAL" for a PAL TV.

FUNCTION SETTING

◦^ SPDIF OUTPUT

◦ SPDIF OFF: No signal is output from the coaxial port.

◦ SPDIF/RAW: Select this when the DVD player is connected with a digital amplifier through coaxial port. When a Dolby Digital disc, DTS disc or MPEG disc are played, the coaxial output will be optional. The power amplifier to be connected must have Dolby Digital, DTS and MPEG decoding.

◦ SPDIF/PCM: Select this when the DVD player is connected with a 2-channel digital stereo amplifier. When a Dolby Digital or MPEG disc is played, the coaxial port will output in PCM 2-channel format.

◦^ CAPTIONS

◦ ON

The hidden subtitle is shown.

◦ OFF

The hidden subtitle is turned off.

◦^ SCREEN SAVER

Start the screen saver, the screen saver image appears when the unit stops or the image is frozen for a few minutes. This saver can keep the screen from being damaged.

◦ ON: Enable the screen saver.

◦ OFF: Remove the screen saver.

◦^ MENU STYLE

The menu has two types of styles (type 1 and type 2).

You can select one type which you like.

AUDIO SETUP

The setting structure is:

--AUDIO SETUP PAGE --

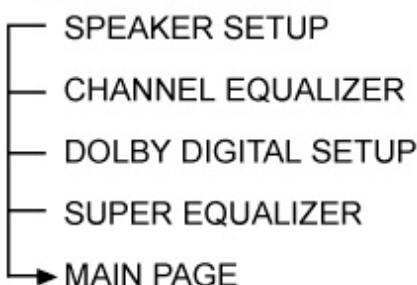

◦^ SPEAKER SETUP

This option will help select the DOWNMIX mode.

The setting structure is:



Select the right or left speaker, or the stereo mode (both).

◦ LT/RT

On a disc recorded for multi channel soundtrack, the output signal can be sent to the left or right channel.

◦ STEREO

On a disc recorded for multi channel soundtrack, the output signal can also be reproduced in stereo.

◦^ CHANNEL EQUALIZER

This option will help you to select graphic equalizer patterns according to the genre of the music being played.

The setting structure is:

--CHANNEL EQUALIZER--

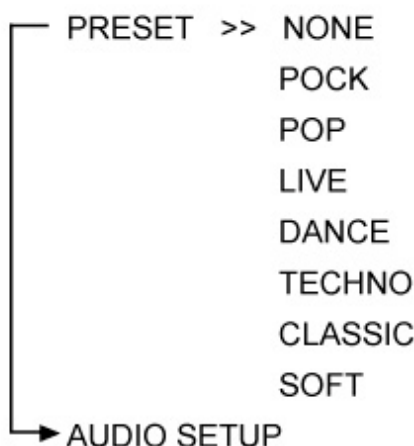

You can select music category by pressing the direction buttons and confirm by pressing the **PLAY** button.

FUNCTION SETTING

°^ DOLBY DIGITAL SETUP

The setting structure is:

--DOLBY DIGITAL SETUP --

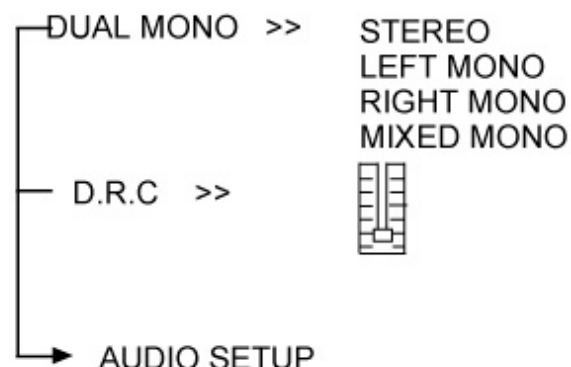

° DUAL MONO

This is the output mode of the L and R signals of the set audio output. If it is set to "MIXED MONO", the function only works when the DVD being played is 5.1-channel.

° D.R.C

When the compression mode is set to "LINE OUT", this is selected to adjust linear compression rate to obtain the different compression results of the signals.

°^ SUPER EQUALIZER

This option will help you to adjust the bass equalizer.

The setting structure is:

--SUPER EQUALIZER PAGE--

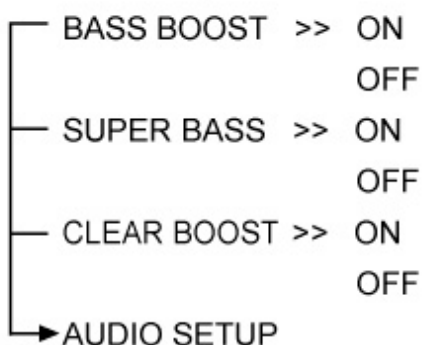

° BASS BOOST

Uses to turn BASS BOOST on and off.

° SUPER BASS

Uses to turn SUPER BASS on and off.

° CLEAR BOOST

Uses to turn CLEAR BOOST on and off.

PASSWORD SETUP

The setting structure is :

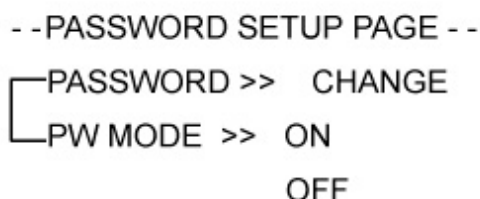

°^ PASSWORD MODE

° ON: The password works, "PARENTAL" is dim and can not be selected.

° OFF: The password is locked, "PARENTAL" can be selected.

°^ PASSWORD CHANGE

Select this to change the code; the screen shows:



Enter a password according to the screen.

Note: The password is automatically factory set to 99999.

PREFERENCES

To access this menu item, the disc must be stopped (PUSH OPEN). OPEN appears on the screen.

The setting structure is :

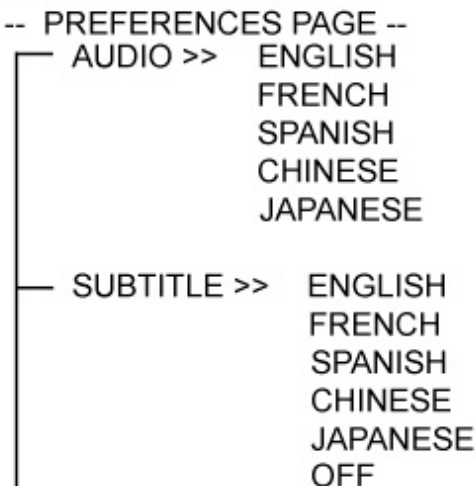

DISC MENU >>	ENGLISH CHINESE FRENCH SPANISH JAPANESE
LOCALE >>	CHINA FRANCE HONG KONG JAPAN TAIWAN GBR USA
PARENTAL >>	1. G 2. 3. PG 4. PG 13 5. PGR 6. R 7. NC-17 8. ADULT
DEFAULT >>	RESET

°^ LANGUAGE SELECTION

If a language mentioned above is recorded on the disc, you can select sounds, subtitles or disc menu languages. If not, the language recorded on the disc is shown.

°^ PARENTAL LOCK

When playing disc with parental lock function, you may select an age control grade according to grade of disc and your desire.

Example: Select "PG", you cannot play DVD video disc rated higher than the PG grade.

°^ DEFAULT >> RESET

Each function setting returns to the initial status in the factory if you select this option.

AUDIO MODE



- ° You may select a needed language from a multi-language DVD .
- ° You may select the right channel or left channel or stereo from a multi-channel CD.

WHEN PLAYING DVD

- ° Press the language button on the remote; the screen shows in order:

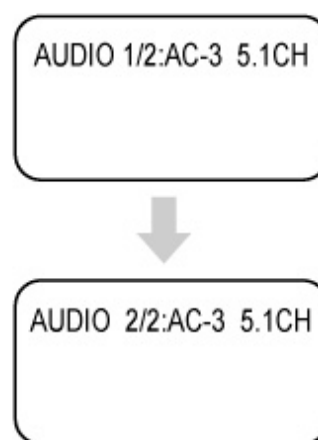

Different discs differ in languages.

NOTE: The language (and subtitles) can also be selected from the On-Screen-Display during disc play.

- ° Press **AUDIO MODE**, the screen shows orderly:

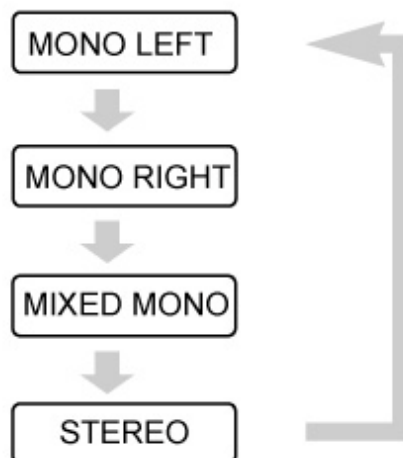

PLAY DISCS IN VARIOUS WAYS

WHEN PLAYING CD

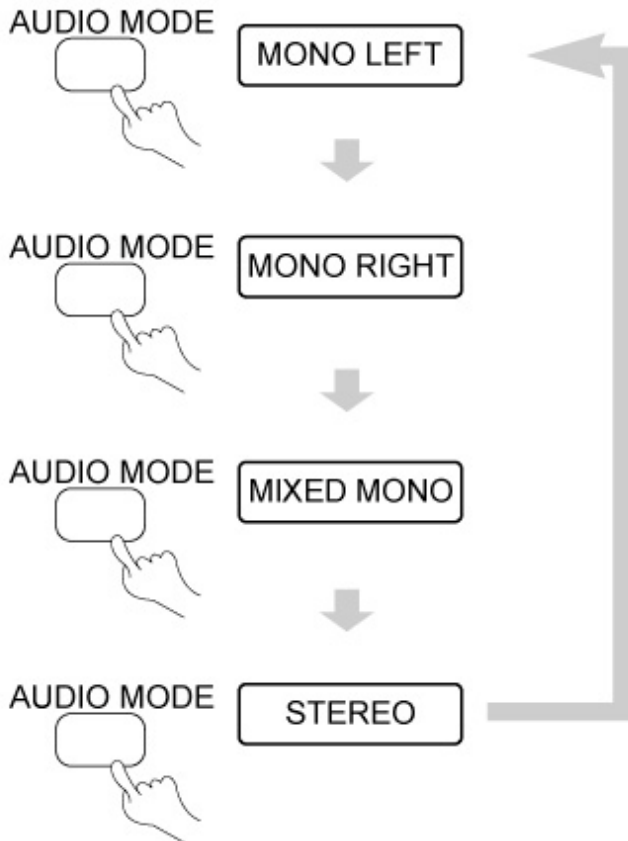

You may select one mode.

Notes:

• Different discs differ in languages.

FAST PLAY



When playing a disc, you may play it forward fast or reverse it fast to find what you want.

WHEN PLAYING DVD OR CD

1. Press **▶▶** on the remote to play forward fast. Each time you press the button, the screen shows, in order:

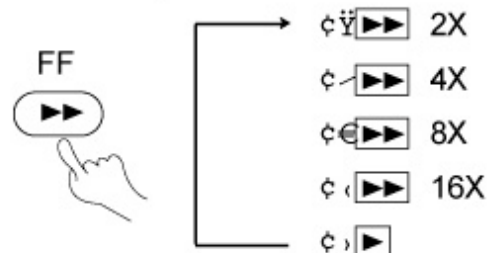

2. Press **◀◀** to reverse the disc fast. Each time you press the button, the screen shows, in order:

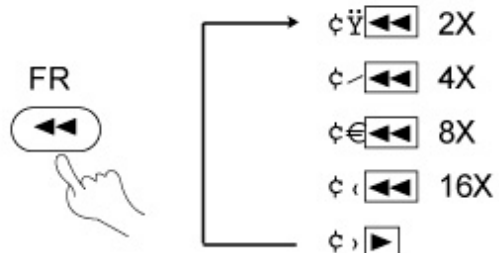

3. Press **▶** (PLAY) to switch to normal play while FF or FR playing.

MUTE



When playing a disc, this function can remove the sound.

1. REMOVE SOUND

Press **MUTE**, the screen shows "MUTE".



2. RESUME SOUND

Press **MUTE** again, the screen shows "MUTE OFF".

PLAY DISCS IN VARIOUS WAYS

SLOW PLAY

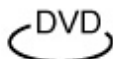

Enjoy slow motions by the following steps.

WHEN PLAYING DVD

1. Press **⏪** to play slowly.

SLOW



The screen shows, in order:

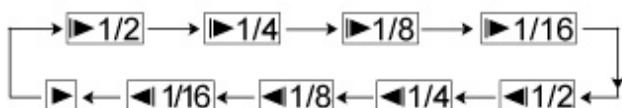

2. Press **▶** (PLAY) at any setting to play normally.

REPEAT PLAY

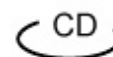

This function can be used to repeatedly play a title, chapter, track, disc, or some part on a disc.

PLAYING A DISC REPEATEDLY

°^ DVD

You may repeat a title or chapter.

1. Repeat a chapter.

Press **REPEAT** on the remote; the screen will show

REPEAT

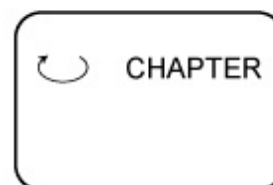

2. Repeat a title

Press **REPEAT** twice, the screen will show

REPEAT



3. Repeat all.

Press **REPEAT** third time, the screen shows " ALL".

4. Remove "REPEAT" function.

Press **REPEAT** until " ALL" disappears.

°^ CD

° You may repeat a track, a disc according to the following steps.

1. Repeat a track.

Press **REPEAT**, the screen shows " TRACK". The unit plays the current track.

PLAY DISCS IN VARIOUS WAYS

REPEAT

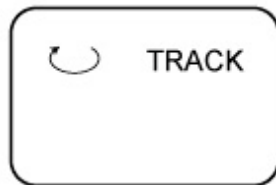

2. Repeat a disc.

Press **REPEAT**, the screen shows "↻ ALL". The unit plays all the tracks on the disc.

REPEAT

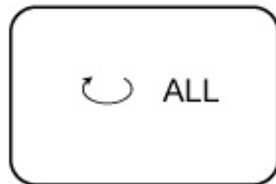

3. Remove "REPEAT" function.

Press **REPEAT** till "↻ ALL" disappears.

REPEAT SOME PARTS

You may press **A-B** on the remote to enjoy some parts repeatedly when playing a disc.

°^ PLAY DVD or CD.

1. Set a starting point A.

The screen shows:

A-B



2. Set an end point B.

The screen shows:

A-B

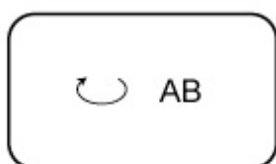

Afterwards, the unit plays from A to B.

3. Press **A-B** again till "↻ AB" disappears.

SELECT SUBTITLES



This operation works only with discs on which multiple subtitle language are recorded.

PLAY DVD

1. Press **SUBTITLE** on the remote repeatedly until the desired language is selected.

The screen shows:

SUBTITLE



SUBTITLE01/03:ENGLISH

2. Remove the subtitle.

Press **SUBTITLE** until the screen shows "TURN OFF SUBTITLES".

Notes:

- ° For some discs, subtitles can not be removed.
- ° Different discs differ in the language of subtitles.
- ° If the subtitles of discs can not be selected, press **SUBTITLE**, the screen shows "NO SUBTITLE".

PLAY DISCS IN VARIOUS WAYS

ANGLES SELECT



Some discs have images with different viewing angles, you may select among them. For example, when you watch a running train, you may watch it from the front, the left window or the right window without stopping it.

Example:

A DVD has four viewing angles at your option.

1. Press the angle button  on the remote to select ANGLE1.

SCREEN

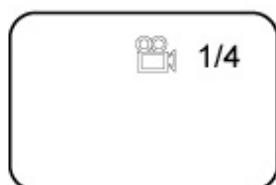

2. Press ANGLE to select other angles, the screen shows respectively:

 2/4 (select ANGLE2)

 3/4 (select ANGLE3)

 4/4 (select ANGLE4)

3. To resume normal playback, press the angle button to select the original angle.

NOTE: To display angle mark on the TV screen, make sure ANGLE MARK is set to ON.

NOTE: The viewing angle can also be selected from the OSD during disc play. If the DVD has just one angle, NONE will be displayed.

TIME SEARCH

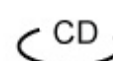

TIME SEARCH

You may directly enter a time, title or chapter number to search fast on a disc, the unit plays from that point.

° ^ PLAY DVD

1. Search a title or a chapter.

Example: Search chapter 2 in title 6.

- ° Press **TIME SEARCH** on the remote; the screen shows:

TITLE03/30 CHAPTER 001 /004

- ° Press the direction button and move the cursor to illuminate the title number. The screen shows:

TITLE 03 /30 CHAPTER001/004

- ° Press button **6** to select title 6; the screen shows:

TITLE 06 /30 CHAPTER001/004

- ° Repeat the steps above, select chapter 2 in title 6.

2. TIME SEARCH

- ° Press **TIME SEARCH** until the screen shows:

TIME ___: ___: ___

- ° Press number buttons to enter hour, minute and second.

Example: Enter **0,1,0,2,3,8**

After setting, the unit will play the disc from 1:02:38.

PLAY DISCS IN VARIOUS WAYS

◦^ PLAY CD

To jump to a specific time, use **TIME SEARCH** to set the time for the desired location.

Example: Play from 00:01:38 of track 6.

1. Press button **6** to select track 6.

The screen shows:

TRACK06
00:46

2. Press **TIME SEARCH** until the screen shows:

TRACK GO TO _ _ : _ _
TRACK 06
00:46

3. Press button **0**, **1**, **3**, **8** to enter the time.
The screen shows:

TRACK06
01:38

◦ The unit plays from 00:01:38 of track 6 after setting.

◦ Press **10/0** to enter 0.

Note: CD discs have three options in time search function:

- You can enter the elapsed time of a disc to play.
- You can enter the elapsed time of a track to play.
- You can go to a track you want play by entering the track number.

BOOKMARK

The bookmark feature lets you mark a point on the disc that you can go to quickly. You can store up to 12 bookmarks per disc. When you turn the player off or remove the disc, bookmarks are cleared.

Storing a Bookmark

1. While a disc is playing, press **RESUME** on the remote.
2. The Bookmark Menu appears.
3. When you reach the scene you want to mark, press **PLAY**.
4. If you want to mark another point, press the **▶** button to move the cursor to next spot. When you reach another scene you want to mark, press **PLAY**.
5. Press **RESUME** to make the Bookmark Menu disappear from the screen and resume to normal playback.

Using a Bookmark

1. While a disc is playing, press **RESUME** on the remote.
2. The Bookmark Menu appears.
3. Use the direction buttons to highlight the bookmarked scene you want to activate. Press **PLAY** to go to the place you marked.

PLAY DISCS IN VARIOUS WAYS

ZOOM PLAY

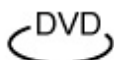

This function can be used to watch a motion or motionless picture.

1. Press **ZOOM** during playback, the screen shows:

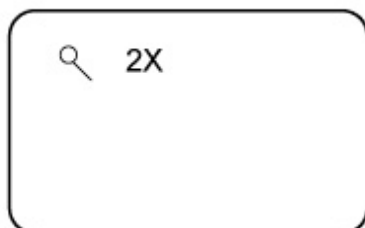

The picture is enlarged twice the size.

2. Press **ZOOM** again, the screen shows:

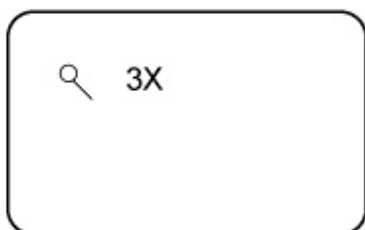

The picture is enlarged three times the size.

Note: The unit has six zoom steps:

🔍 2X, 🔍 3X, 🔍 4X, 🔍 1/2, 🔍 1/3, and
🔍 1/4.

3. Push **◀**, **▲**, **▼**, **▶** to move the enlarged picture.
4. To resume the picture, push **ZOOM** until the picture is in normal size.

PROGRAM PLAY



To use the program playback feature, you must enter the order in which you want the titles (and chapters) on the DVD or the tracks on the CD to play by creating a program.

WHEN PLAYING DVD

1. Press **PLAY MODE** until the screen shows:

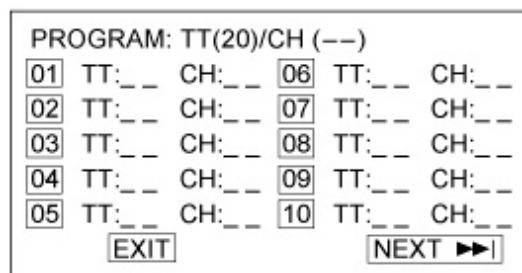

2. Use the number buttons on the remote to enter the title (and chapter) you want to play first. The title (and chapter) number you entered appears in the box. The screen shows:

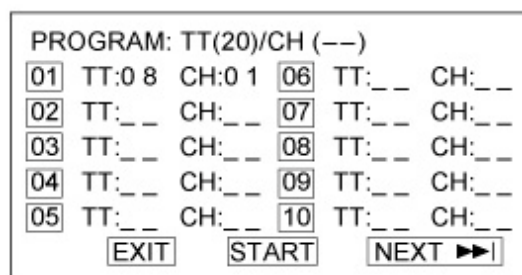

3. The cursor jumps to the next spot in the program list section. Make sure the box is highlighted and enter your next track.
4. Continue adding titles (and chapters) until your program is complete. You can play your program by highlighting **START** and press **PLAY**.

Note: If the titles (and chapters) you want

PLAY DISCS IN VARIOUS WAYS

to program are more than 10, you can highlight NEXT and press **PLAY** to go to the next page.

5. To remove program playback, highlight EXIT and press **PLAY** to confirm.

WHEN PLAYING CD

1. Press **PLAY MODE** until the screen shows:

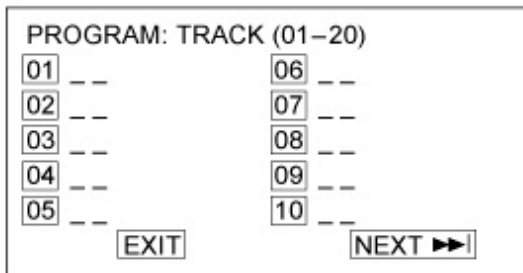

2. Use the number buttons on the remote to enter the track number you entered appears in the box. The screen shows:

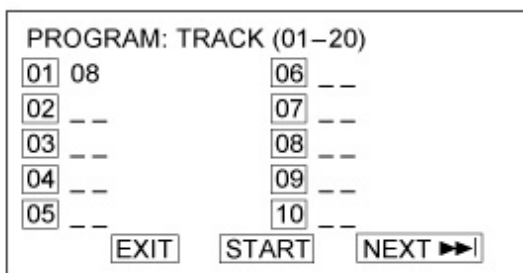

3. The cursor jumps to the next spot in the program list section. Make sure the box is highlighted and enter your next track.

4. Continue adding tracks until your program is complete. You can play your program by highlighting START and press **PLAY**

Note: If the tracks you want to program are more than 10, you can highlight NEXT and press **PLAY** to go to the next page.

5. To remove program playback, highlight EXIT and press **PLAY** to confirm.

SHUFFLE OR RANDOM PLAY



The unit can play by random orders. The order is different each time.

1. Press **PLAY MODE** to select shuffle or random play mode while a disc is playing.

PLAY MODE



The screen shows:

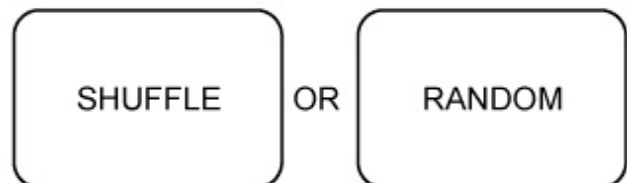

2. press ► (PLAY) to start shuffle or random play.

The unit selects a track to play.

3. Remove shuffle or random play.

◦ When playing a DVD disc, press ◦^ twice.

◦ When playing a CD disc, press ◦^.

PLAY DISCS IN VARIOUS WAYS

DIGEST PLAY

This function can be used to look through the content of the track or disc.

PLAYING DVD

1. Press **DIGEST** while a disc is playing.



The screen shows:

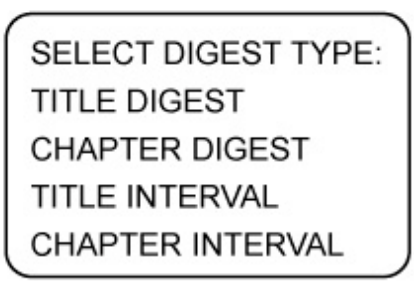

Use the **▼** or **▲** buttons to select "TITLE DIGEST" and press **PLAY** to confirm.

The unit begins to look through the titles, and shows the starting picture of each title on the screen.

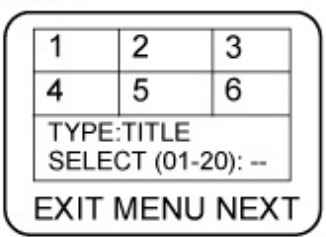

Each page has six pictures, their location may be different.

2. Use the direction buttons to select **NEXT** on the screen, and press **PLAY** to go to the next page.

3. To remove the digest feature, use the direction buttons to select **EXIT** on the screen and press **PLAY** to confirm.

Note: If you have stored bookmarks on a DVD disc, there will be one more digest option: **BOOKMARK DIGEST**.

PLAYING CD

1. Press **DIGEST** after the unit stops.



The screen shows:

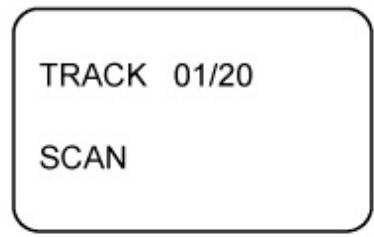

The unit plays the first ten seconds of each track one after another.

2. Remove digest play.
Press **STOP**, digest play is removed and the unit stops.

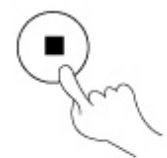

Note: A CD disc only has "SCAN" function.

MP3 OPERATION

◦^ SELECT TRACKS WITH MENU

1. Insert a disc, the unit will search disc information. The TV screen displays main menu.

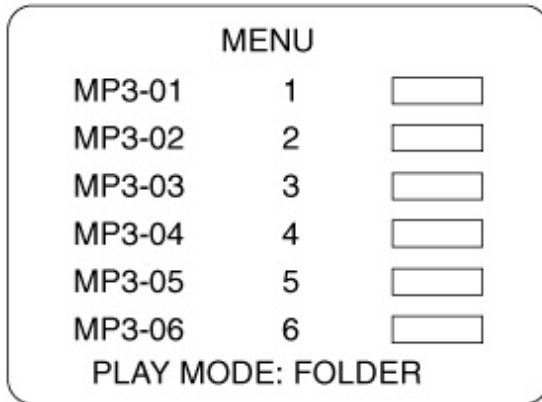

2. Press direction key ▼ to select song folder. Press ► (PLAY) to confirm selection. Example: Select MP3-02, the TV screen displays.



3. Press direction buttons to select a song. Press ► (PLAY) button to start playback.
4. Press ▲ or ▼ button to select other tracks in stop mode.
5. In stop mode, select the folder icon (UP DIR 1) on the left side, then press ► (PLAY) button to return to the main menu.
6. Press ►|◀ or ◀◀ to play previous or next songs.

◦^ OTHER FUNCTIONS

During playback of MP3 discs, the unit features mute, volume control, repeat play and etc. Operations are the same as CD.

OTHERS

ACCESSORIES

Check if you have all the accessories after the carton is opened.

°§Audio cable	1
°§Video cable	1
°§Remote control	1
°§Owner's manual	1
°§AC power adaptor	1
°§Rechargeable battery pack	1

PRECAUTIONS FOR DISC

°ðHANDLING DISC

°§To keep the disc clean, do not touch the play sides of the disc

°§Do not attach paper or tape to the disc.



°§Keep the disc away from direct sunlight or heat sources.

°§Store the disc in a disc case after playback.

°ð CLEANING DISC

°§Before playback, wipe the disc outwards from the center with clean cloth.



OTHERS

TROUBLE SHOOTING

If you experience the following problems while using the unit, this troubleshooting guide can help you.

No sound

- °§Check if the unit is connected securely.
- °§Check if the volume of headphone is set to MIN when using headphone.
- °§Make sure you operate the TV or amplifier correctly.
- °§Make sure you have selected DVD player position on the amplifier.

No image

- °§Check if the unit is connected securely.
- °§Make sure you operate the TV correctly.
- °§Make sure you set the color system correctly.

Bad sound quality

- °§Make sure the audio output mode is set correctly.
- °§Make sure the audio connection between the unit and amplifier is right.

Disc can not be played

- °§There is no disc in the unit.
- °§Put the disc on the disc tray properly with the label side up.
- °§Clean the disc.
- °§Moisture has condensed in the unit.
Remove the disc and leave the unit on for about one hour.

Remote control does not work

- °§Remove barriers between the remote control and the unit.
- °§Point the remote control at the remote control sensor of the unit.
- °§Replace the batteries with new ones.

Image rolls and no color

The color system of the unit doesn't match with that of TV. Please select the correct TV TYPE until TV shows normal color.

OTHERS

TECHNICAL SPECIFICATIONS

Laser	wavelength 650nm	
Video system	PAL/MULTI/NTSC	
Frequency response	20Hz ^o ~ 20KHz ^o ± 1dB	
Signal/noise ratio	^o , 95dB	
Audio distortion + noise	^o , -80(1KHz)	
Channel separation	^o , 85dB	
Dynamic range	^o , 85dB	
Output	Audio out (analog audio)	Output level: 2V ^o ± 10% Load impedance: 10k
	Audio out (digital audio)	Output level: 0.5Vp - p
	Video out	Output level: 1Vp - p ^o ± 20% Load impedance: 75 , imbalance, negative polarity
Power supply	DC 9V 2A	
Allowable motion temperature	5 ^o ~ 35 ^o Ê (41 ^o F to 95 ^o F)	
Power Consumption	^o , 20W	
Dimensions	190 ^o 142 ^o 29mm (7.5" W ^o 5.6" D ^o 1.14" H)	
Weight	825g	

This manual is only for your reference, any change to the design and specifications will not be advised.

This product incorporates copyright protection technology that is protected by method claims of certain U.S. patents and other intellectual property rights owned by Macrovision Corporation and other rights owners. Use of this copyright protection technology must be authorized by Macrovision Corporation, and is intended for home and other limited viewing uses only unless otherwise authorized by Macrovision Corporation. Reverse engineering or disassembly is prohibited.

USING THE BATTERY PACK

The rechargeable battery pack is suitable when adapting the DVD player for portable use and when it is convenient for you to enjoy the unique functions of the DVD player out of doors. To recharge the battery:

1. Remove the battery pack from the DVD player (if being used) and attach it to the supplied battery charger. Then connect the battery pack output plug to the charger OUTPUT jack. Connect the charger INPUT jack to the AC adapter output (DC 9V at 2.2A).

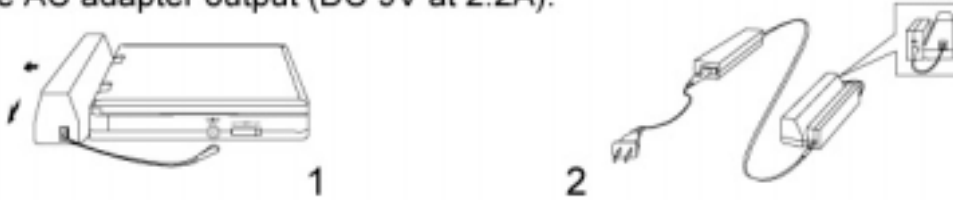

- Notes:
- 1) The input voltage of the battery charger is:DC9V, 2.2A;
 - 2) Generally, the battery pack can be charged and discharged about 500 times;
 - 3) The marking voltage of the battery pack is 7.4V, the capacity is 5750mAh. A special IC protection logic is included to prevent deformation caused by over-charging and over-discharging.
2. It takes about 6 hours to fully charge the battery pack; the red charging LED indicator goes out and charging is complete. Unplug the AC power supply cord from the AC adapter; then unplug the battery pack from the battery charger and attach it at the corresponding position at the back of the DVD player. Insert the plug of the battery pack to the DC IN jack of the DVD player.

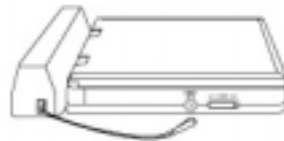

- Notes:
- 1) A fully-charged battery pack will discharge automatically in a month, if it remains unused.
 - 2) If the battery pack is not used for a long period of time, discharge it and store it in a place that is cool, dry and dark.
 - 3) When the battery pack is empty, LOW BATTERY will flash on the DVD player TFT. In this case, stop using the unit, and recharge the battery.



3. Generally, after the battery pack is recharged, its continuously working time is as follows. For example:

<u>Model</u>	<u>Operating status</u>	<u>Continuous playing time</u>
D1730	Play DVD, TFT on	about 3 hours
	Play DVD, TFT off	about 5 hours

4. Conditions and attention:

While using the battery pack, the environmental temperature should be 5°C (41°F) to 35°C (95°F).

A newly purchased battery pack can only be used after being charged.

To undertake the longest service life of the battery pack, charge it under or close to indoor-temperature.

Never dispose of in fire, water or heat up.

Do not use in high temperature or near heat sources.

Never connect the positive and negative poles with metal.

Do not open the battery, refer servicing only to qualified service personnel.



12 MONTH DAY LIMITED WARRANTY

Applies to Audiovox Video Products

AUDIOVOX ELECTRONICS CORPORATION (the Company) warrants to the original retail purchaser of this product that should this product or any part thereof, under normal use and conditions, be proven defective in material or workmanship within 12 months from the date of original purchase, such defect(s) will be repaired or replaced with reconditioned product (at the Company's option) without charge for parts and repair labor.

To obtain repair or replacement within the terms of this Warranty, the product is to be delivered with proof of warranty coverage (e.g. dated bill of sale), specification of defect(s), transportation prepaid, to the Company at the address shown below.

This Warranty does not extend to the elimination of externally generated static or noise, to correction of antenna problems, to costs incurred for installation, removal or reinstallation of the product, or to damage to tapes, discs, speakers, accessories, or electrical systems.

This Warranty does not apply to any product or part thereof which, in the opinion of the Company, has suffered or been damaged through alteration, improper installation, mishandling, misuse, neglect, accident, or by removal or defacement of the factory serial number/bar code label(s). THE EXTENT OF THE COMPANY'S LIABILITY UNDER THIS WARRANTY IS LIMITED TO THE REPAIR OR REPLACEMENT PROVIDED ABOVE AND, IN NO EVENT, SHALL THE COMPANY'S LIABILITY EXCEED THE PURCHASE PRICE PAID BY PURCHASER FOR THE PRODUCT.

This Warranty is in lieu of all other express warranties or liabilities. ANY IMPLIED WARRANTIES, INCLUDING ANY IMPLIED WARRANTY OF MERCHANTABILITY, SHALL BE LIMITED TO THE DURATION OF THIS WRITTEN WARRANTY. ANY ACTION FOR BREACH OF ANY WARRANTY HEREUNDER INCLUDING ANY IMPLIED WARRANTY OF MERCHANTABILITY MUST BE BROUGHT WITHIN A PERIOD OF 30 MONTHS FROM DATE OF ORIGINAL PURCHASE. IN NO CASE SHALL THE COMPANY BE LIABLE FOR ANY CONSEQUENTIAL OR INCIDENTAL DAMAGES FOR BREACH OF THIS OR ANY OTHER WARRANTY, EXPRESS OR IMPLIED, WHATSOEVER. No person or representative is authorized to assume for the Company any liability other than expressed herein in connection with the sale of this product.

Some states do not allow limitations on how long an implied warranty lasts or the exclusion or limitation of incidental or consequential damage so the above limitations or exclusions may not apply to you. This Warranty gives you specific legal rights and you may also have other rights which vary from state to state.

U.S.A. : AUDIOVOX ELECTRONICS CORPORATION, 150 MARCUS BLVD., HAUPPAUGE, NEW YORK 11788 • 1-800-645-4994

CANADA : CALL 1-800-645-4994 FOR LOCATION OF WARRANTY STATION SERVING YOUR AREA

128-5918A

Free Manuals Download Website

<http://myh66.com>

<http://usermanuals.us>

<http://www.somanuals.com>

<http://www.4manuals.cc>

<http://www.manual-lib.com>

<http://www.404manual.com>

<http://www.luxmanual.com>

<http://aubethermostatmanual.com>

Golf course search by state

<http://golfingnear.com>

Email search by domain

<http://emailbydomain.com>

Auto manuals search

<http://auto.somanuals.com>

TV manuals search

<http://tv.somanuals.com>