

D1809

8" LCD MONITOR WITH DVD PLAYER



Important Safety Instructions

Some of the following information may not apply to your particular product; however, as with any electronic product, precautions should be observed during handling and use.

- | Read these instructions.
- | Keep these instructions.
- | Heed all warnings.
- | Follow all instructions.
- | Do not use this apparatus near water.
- | Clean only with dry cloth.
- | Do not block any ventilation openings. Install in accordance with the manufacturer's instructions.
- | Do not install near any heat sources such as radiators, heat registers, stoves, or other apparatus (including amplifiers) that produce heat.
- | Do not defeat the safety purpose of the polarized or grounding-type plug. A polarized plug has two blades with one wider than the other. A grounding type plug has two blades and a third grounding prong. The wide blade or the third prong is provided for your safety. If the provided plug does not fit into your outlet, consult an electrician for replacement of the obsolete outlet.
- | Protect the power cord from being walked on or pinched particularly at plugs, convenience receptacles, and the point where they exit from the apparatus.
- | Only use attachments/accessories specified by the manufacturer.
- | Use only with the cart, stand, tripod, bracket, or table specified by the manufacturer, or sold with the apparatus. When a cart is used, use caution when moving the cart/apparatus combination to avoid injury from tip-over.
- | Unplug this apparatus during lightning storms or when unused for long periods of time.
- | Refer all servicing to qualified service personnel. Servicing is required when the apparatus has been damaged in any way, such as power-supply cord or plug is damaged, liquid has been spilled or objects have fallen into the apparatus, the apparatus has been exposed to rain or moisture, does not operate normally, or has been dropped.



Additional Safety Information

- | Apparatus shall not be exposed to dripping or splashing and no objects filled with liquids, such as vases, shall be placed on the apparatus.
- | Always leave sufficient space around the product for ventilation. Do not place product in or on a bed, rug, in a bookcase or cabinet that may prevent air flow through vent openings.
- | Do not place lighted candles, cigarettes, cigars, etc. on the product.
- | Connect power cord only to AC power source as marked on the product.
- | Care should be taken so that objects do not fall into the product.
- | Do not attempt to disassemble the cabinet. This product does not contain customer serviceable components.
- | Do not use the unit immediately after transportation from a cold place to a warm place; condensation problems may result. Wait for about one hour till the moisture evaporates before operating the unit.
- | When using your portable DVD player, do not sit or stand too close to the screen.
- | To use a headset safely, please keep the following in mind:
 - Do not play your headset at a high volume. Hearing experts advise against continuous extended play.
 - If you experience ringing in your ears, turn down the volume or stop using the headset.
 - Do not use a headset while driving a motorized vehicle or riding a bike. It may cause a traffic hazard and is illegal in many areas.
 - Even if your headset is an open-air type designed to let you hear outside sounds, don't turn up the volume so high that can't hear sounds around you.
- | CAUTION! CD and DVD products utilize a laser. Do not try to open the product. Refer all servicing to qualified service personnel.
- | CAUTION! Danger of explosion if battery is incorrectly replaced. Replace only with the same or equivalent type.
- | Warning: Your DVD player contains a battery and charging system which is designed to work in temperatures that do not exceed 50°C (122°F). Leaving this product in a closed automobile or in the trunk of an automobile where temperature may exceed 50°C may result in permanent battery damage, fire, or explosion. Please remove your product from the automobile when you exit, do not place your product in the trunk of your automobile, and do not leave your product in any location where temperature may exceed 50°C.

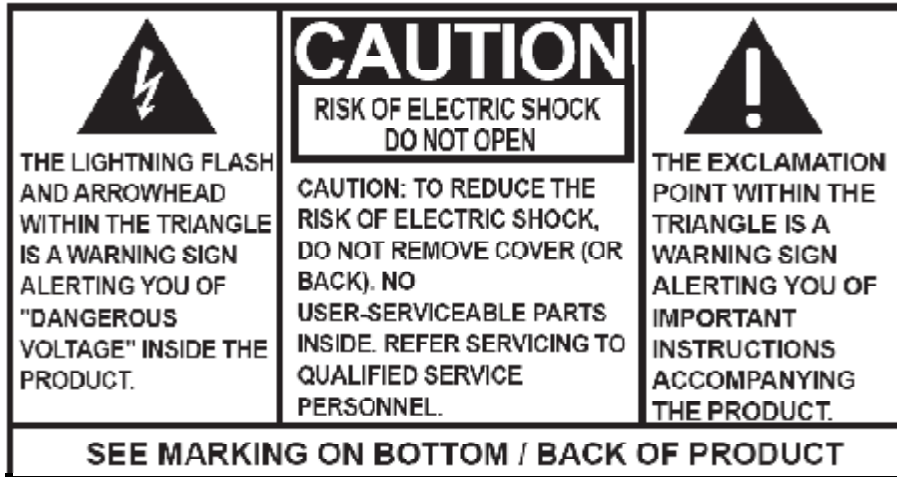

WARNING: TO PREVENT FIRE OR ELECTRICAL SHOCK HAZARD, DO NOT EXPOSE THIS PRODUCT TO RAIN OR MOISTURE.

FCC Information

This device complies with part 15 of the FCC rules. Operation is subject to the following two conditions: (1) This device may not cause harmful interference, and (2) This device must accept any interference received, including interference which may cause undesired operation.

This equipment has been tested and found to comply with the limits for a Class B digital device, pursuant to Part 15 of the FCC Rules. These limits are designed to provide reasonable protection against harmful interference in a residential installation. This equipment generates, uses and can radiate radio frequency energy and, if not installed and used in accordance with the instructions, may cause harmful interference to radio communications. However, there is no guarantee that interference will not occur in a particular installation.

If this equipment does cause harmful interference to radio or television reception, which can be determined by turning the equipment off and on, the user is encouraged to try to correct the interference by one or more of the following measures:

- Reorient or relocate the receiving antenna.
- Increase the separation between the equipment and receiver.

- Connect the equipment into an outlet on a circuit different from that to which the receiver is connected.

- Consult the dealer or an experienced radio / TV technician for help.

In accordance with FCC requirements, changes or modifications not expressly approved by manufacturer could void the user's authority to operate this product.

Manufacturer/Responsible Party

Audiovox Electronics Corp.,
150 Marcus Blvd., Hauppauge, NY 11788

This class B digital apparatus complies with Canadian ICES-003.
Cet appareil numérique de la classe B est conforme à la norme NMB-003 du Canada.

Service Information

This product should be serviced only by those specially trained in appropriate servicing techniques. For instructions on how to obtain service, refer to the warranty included in this user manual.

For Your Records

Keep your sales receipt for proof of purchase to obtain warranty parts and service.

In the event that service should be required, you may need both the model number and the serial number. In the space below, record the date and place of purchase, and the serial number:

Model No.

Date of Purchase

Place of Purchase

Serial No.

Content

A. Introduction	7
B. DVD and Disc Information	7
C. Contents	8
D. Powering and installation	8
E. Controls, Indicators, and Connectors.....	9
F. Loading and Playing a Disc	10
G. Basic Operation.....	11
H. Menu	12
I. Display.....	12
J. Playing Audio CDs.....	18
K. Playing JPEG Files.....	19
L. Connecting to Other Equipment.....	20
M. Setup	21
N. Specifications	29
O. Rechargeable Built-in Battery use.....	29
P. Troubleshooting	31

A. Introduction

Thank you for choosing the D1809 portable DVD player. The main features include a 8" wide Screen (16:9 Aspect Ratio) Liquid Crystal Display (LCD) monitor and a DVD player. The unit applies the latest state of the art electronics and is designed for use in hotels, offices or your home. The unit is constructed to provide years of reliable, trouble-free service and is compact so that you can take it with you anywhere and is designed for quick and easy installation. Please read the entire instruction manual supplied with this product prior to using. The documentation will assist you in using the system properly to obtain the best equipment performance. Please save this manual for later use.

B. DVD and Disc Information

DVD Copy Protection - This Product incorporates copyright protection technology that is protected by method claims of certain U.S. Patents and other intellectual property rights owned by Macrovision Corporation and other rights owners. Use of this copyright protection technology must be authorized by Macrovision Corporation, and is intended for home and other limited viewing uses only unless otherwise authorized by Macrovision Corporation. Reverse engineering or disassembly is prohibited.

DVD Regional Code - Your DVD player has been designed to process regional management information that is stored on DVD discs. The regional code for your player is 1 (The U.S., U.S. Territories and Canada). Only DVD discs that have regional codes of 1 or ALL (for all regions) can be played by your player.



Disc - Do not use irregularly shaped discs such as heart or star-shaped discs as they may cause the unit to malfunction. Do not stick paper, tape or glue on the disc. Do not expose the disc to direct sunlight or heat sources such as hot air ducts. Do not touch the surface of disc. Handle the disc by its edge. Clean the disc by wiping the disc from the center out with a cleaning cloth. Remove the disc from the unit and store it in its case after playing. Some playback operations of discs may be intentionally fixed by software producers. Since this unit plays discs according to the disc contents the software producers designed, some playback features may not be available. Also refer to the instructions supplied with the discs.

C. Contents

1. 1 x 8" LCD Monitor and DVD Player
2. 1 x Remote Control with Battery (CR2025)
3. 1 x Audio/Video Cable
4. 1 x AC to DC Adapter
5. 1 x DC Power Adapter
6. 1 x Instruction Manual
7. 1 x Product Registration Card
8. 1 x eMusic Card

D. Powering and Installation

1. Powering the System Indoors (Refer to Figure 1)

Plug one end of the AC to DC adapter into the DC input jack on the right side of the main unit, then plug the other end into the 100~240V AC power receptacle.

2. Powering the System in a Car

Plug one end of the DC Power adapter into the DC input jack on the unit, then plug the other end into the vehicle power outlet.

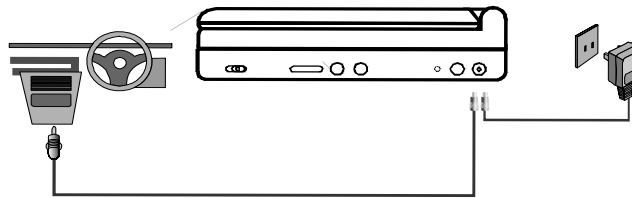

Figure 1

3. To Charge the Built-in Battery

Plug one end of the AC to DC adapter into the DC jack on the side of the player, as shown in Figure 1, then plug the other end into the 100~240V AC power outlet. Make sure that the player's power slide switch is in the "OFF/CHG." position, The charge light will flash for about 3 seconds, then it turns to red. Once fully charged, the LED indicator will be green, then remove the AC to DC adapter wall plug.

NOTE: Your new battery must be charged a minimum of 8 hours before the first usage. Each full recharge takes approximately five hours and one full charge can provide power to the player for approximately 2 hours.

E. Controls, Indicators, and Connectors

1. Unit View (Refer to Figure 2)

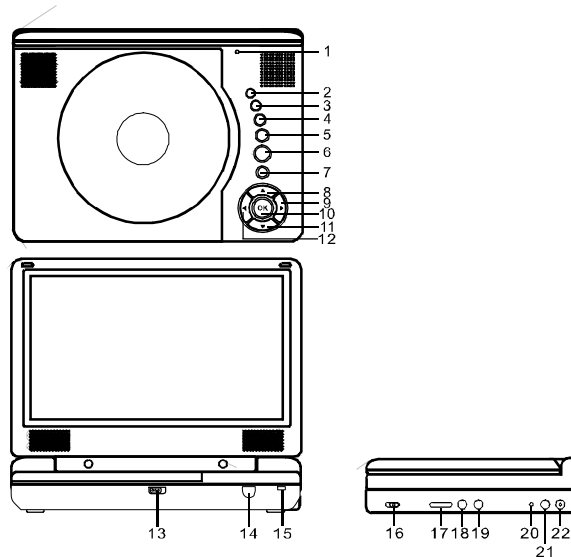

Figure 2

- | | |
|------------------------------|-------------------------|
| 1) LCD Panel Shut Off Switch | 12) Left Button |
| 2) Wide Screen Button | 13) Open Door Switch |
| 3) Stop Button | 14) IR Sensor |
| 4) Previous Button | 15) Power LED |
| 5) Next Button | 16) Power on/off Switch |
| 6) Play/Pause Button | 17) Volume Control |
| 7) Menu Button | 18) Headphone 1* |
| 8) Up Button | 19) Headphone 2 |
| 9) Right Button | 20) Charge Indicator |
| 10) OK Button | 21) AV Out Jack |
| 11) Down Button | 22) DC 9-12V Input Jack |

*Using headphone jack 1 will disable the internal speakers.

2. Remote Control (Refer to Figure 3)

- 1) SETUP Button
- 2) UP Button
- 3) PREVIOUS Button
- 4) ENTER Button
- 5) REVERSE/LEFT Button
- 6) DOWN Button
- 7) NUMERIC Buttons
- 8) DISPLAY Button
- 9) ZOOM Button
- 10) SUB Button
- 11) NEXT Button
- 12) A-B REPEAT Button
- 13) FORWARD/RIGHT Button
- 14) 1/All REPEAT Button
- 15) STOP Button
- 16) MENU Button
- 17) AUDIO Button
- 18) ANGLE Button
- 19) PLAY/PAUSE Button

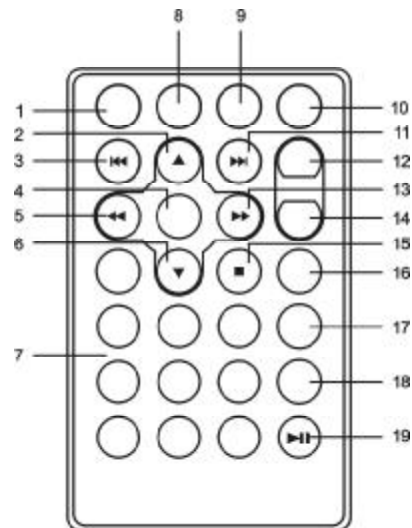

Figure 3

F. Loading and Playing a Disc

- a. After connecting power to the unit, apply power to the DVD player by sliding the POWER ON/OFF switch to ON. The power indicator will be green.
- b. Open the disc tray by sliding cover OPEN switch and place a disc onto the tray with the label side facing up.
- c. Close the tray by pressing the area marked "PUSH TO CLOSE". The unit will load the disc and start playing.
- d. Rotate VOLUME control to adjust the DVD player's volume.
- e. To stop playing a disc, press the STOP button.
- f. To turn off the DVD player, slide the POWER ON/OFF switch to OFF.

G. Basic Operation

POWER	Turn the unit on/off
OPEN	Remove/load the disc
PLAY	Start Play/Execute item or setting
PAUSE	Still Picture
STOP	(1 time) Stop at the present playing point / (2 times) Stop playback of the DVD/CD
NEXT	Go to the next chapter, track or scene during playback
PREVIOUS	Go back to the previous chapter, track or scene during playback
FORWARD	Scan forward at 2, 4, 8, 16 or 32x times speed
REVERSE	Scan backward at 2, 4, 8, 16 or 32x times speed
LEFT/RIGHT/UP/DOWN	Used for Menu Navigation
ENTER	Execute item or confirm setting
NUMBERS	Select item or setting
MENU	Display the main menu of the disc
REPEAT	Repeat playing title, chapter, or track
A-B	Repeat a specific portion from point A to point B of the disc
DISPLAY	Display information (title, chapter, track, time, etc.)
ANGLE	Change the viewing angles on the scene
SUBTITLE	Select the subtitle language and turn it on/off
AUDIO	Select the audio language
ZOOM	Enlarge an image to 2, 3, or 4 times the original size during DVD playback.
SETUP	Display the setup menu to select and set items, and exit the setup menu.

H. Menu

A DVD is divided into sections called titles and chapters. When you play a DVD, a root menu of the disc will appear on the screen of your TV or Monitor. The contents of the menu vary from disc to disc. Press MENU during playback to display the menu. Some DVDs only allow you to select disc playback options using the DVD root menu.

I. Display (Display contents vary from disc to disc.)

1. Playing Time and Remaining Time

- a. During playback press the DISPLAY button to display the current Title Number (1), the total Number of Titles (2), the current Chapter Number (3), the total Number of Chapters (4), and the elapsed playing Time for the title (5). The heading will disappear automatically after 3 seconds if no buttons are pressed.

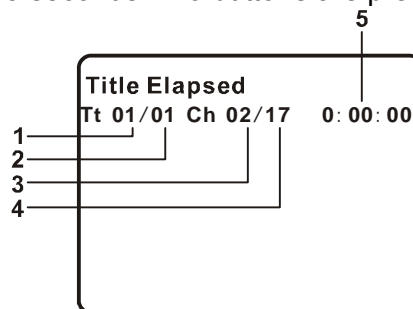

Title, Chapter Number and Time Screen Display

- b. Press DISPLAY button again to display the Remaining Time of the title. The heading will disappear automatically in 3 seconds.

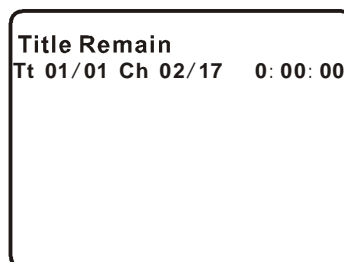

Title Remaining Time Screen Display

- c. Press DISPLAY button a third time to display the Elapsed Time for the chapter. The heading will disappear automatically in 3 seconds.

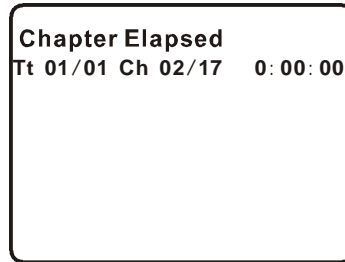

Chapter Elapsed Time Screen Display

- d. Press DISPLAY button a fourth time to display the Remaining Time for the chapter. The heading will disappear automatically in 3 seconds.

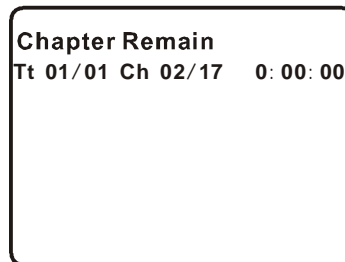

Chapter Remaining Time Screen Display

- e. Press DISPLAY button a fifth time to exit, 'DISPLAY OFF' will be displayed and will disappear automatically in 3 seconds.

NOTE: To select the Chapter you want, enter the number of the Chapter you want on the remote while in any display mode. The information for Chapter and Title will be displayed and the number of the Chapter you selected will be highlighted. Press ENTER button to confirm the selection.

2. Angle

During playback of a disc, press ANGLE button to display the available angles for discs containing multi-angles*, with the current angle number (1) and the total number of angles (2) displaying. Press ANGLE button to select other angles.

***NOTE:** Not all discs contain this feature.

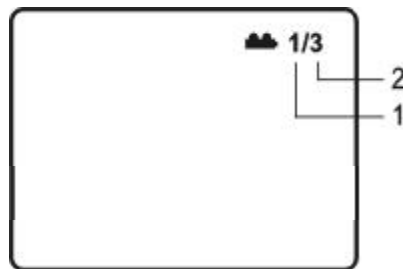

Angle Screen Display

3. Subtitle

During disc playback press SUB button to select the subtitle language you desire*, with the current Subtitle Language Number (1) and the total Number of Subtitle Languages (2) displayed. If there are multiple languages press SUB button again to select another subtitle language. To turn subtitles OFF, press the SUB button until 'SUBTITLE OFF' is displayed. The Subtitle display will disappear automatically if the SUB button is not pressed again within 3 seconds.

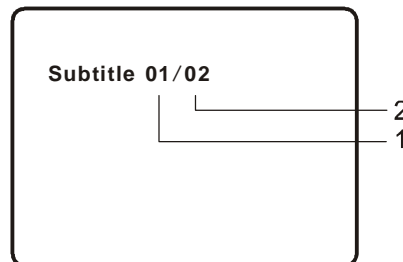

Subtitle Screen Display

* Some DVDs only allow access to this function through the DVD menu.

4. Audio

During playback press AUDIO button to select the audio language you desire*, with the current Audio Channel Number (1) and the total number of Audio Channels (2) displayed. Press AUDIO again to select another audio language. The audio display will disappear automatically if the AUDIO button is not pressed within 3 seconds.

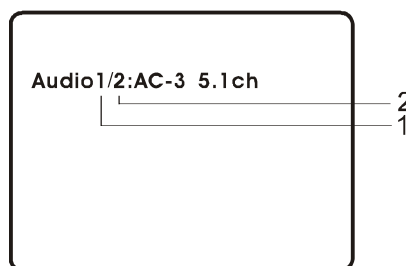

Audio Language Screen Display

* Some DVDs only allow access to this function through the DVD menu.

5. Zoom

During playback press ZOOM button to enlarge the picture by 2x, 3x or 4X with the current zoom multiple. Press ZOOM button one time, the picture will be enlarged 2X. Press ZOOM button a second time, the picture will be enlarged 3X. Press ZOOM button a third time, the picture will be enlarged 4X. Press ZOOM button a fourth time, the picture will return to normal size.

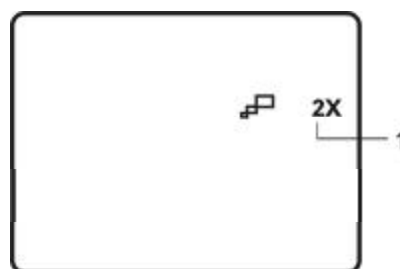

ZOOM Screen Display

6. A-B Repeat

- a. During playback press A-B button to set the Starting Point A.



A-B Repeat Starting Point Screen Display

- b. Press A-B button a second time to set the Ending Point B and the player will repeatedly play the part between Point A and Point B.

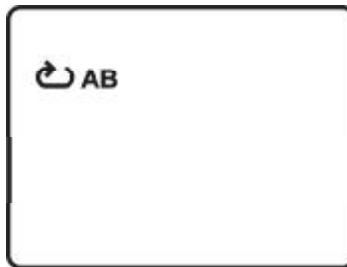

A-B Repeat Ending Point Screen Display

- c. Press A-B button a third time to cancel A-B repeat and resume normal playback.

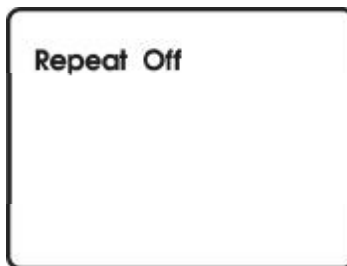

A-B Repeat Cancelled Screen Display

7. Repeat

- a. During playback press 1/ALL button once to repeatedly play the current chapter.

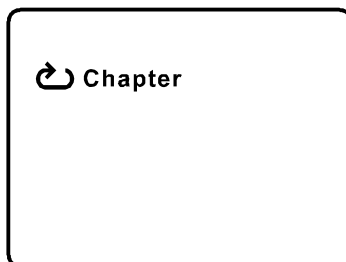

Chapter Repeat ON Screen Display

- b. During playback press 1/ALL button again to repeatedly play the current title.



Title Repeat ON Screen Display

- c. During playback press 1/ALL button a third time to repeat all chapters and titles.



All Repeat ON Screen Display

d. Press 1/ALL button a fourth time, to resume normal playback.

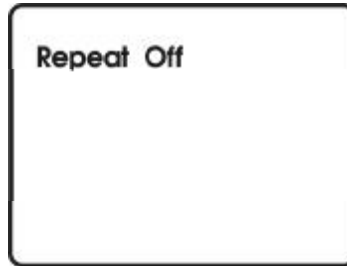

Repeat Off Screen Display

8. Forward/Reverse Scan

- a. During playback press **u u** to scan forward at 2x, 4x, 8x, 16x, 32x and normal speed.
- b. During playback press **t t** to scan backward at 2x, 4x, 8x, 16x, 32x and normal speed.

J. Playing Audio CDs

When an CD disc is put into the unit, the Menu Screen appears. You can use Up and DOWN button to choose the song you desired. Press ENTER button to play.

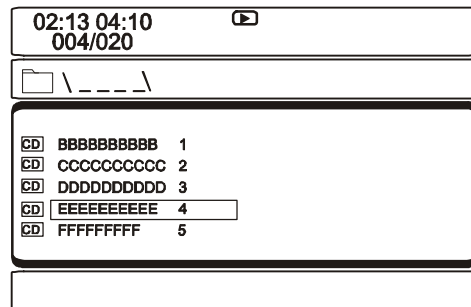

Menu Screen

1. Using the Repeat Feature

The default mode for the Repeat feature is OFF. Pressing 1/ALL button consecutively changes the repeat options:

- *Repeat One* - repeats the track that is playing.
- *Repeat All* - repeats the disc that is playing.
- *Repeat Off*

As you toggle through the options, the repeat option changes. The selected repeat option loops repeatedly until you turn it off.

2. A-B Repeat

- a. During playback press A-B to set the Starting Point A.
- b. Press A-B a second time to set the Ending Point B and the player will repeatedly play the part between Point A and Point B.
- c. Press A-B a third time to cancel A-B repeat and resume the normal playback.

3. Forward/Reverse Scan

- a. During playback press **uu** to scan forward at 2x, 4x, 8x, 16x, 32x and normal speed.
- b. During playback press **tt** to scan backward at 2x, 4x, 8x, 16x, 32x and normal speed.

K. Playing JPEG Files

- 1) Load a JPEG disc onto the disc tray.
- 2) A screen showing folders or picture files contained on the disc will be displayed automatically after loading.
- 3) Press UP, DOWN and ENTER button to select a folder or a picture. If a picture is selected, photo slideshow will start with the selected picture.
- 4) Press the DOWN button to rotate the picture clockwise.
- 5) Press the ZOOM button to enlarge the picture size by 125%, 150%, 200% or zoom out by 75%, 50% and then return to the original size. When the image is enlarged, you can use the navigation buttons to view blocked parts of the picture.
- 6) Press UP or STOP button to return to the screen showing folders or picture files.
- 7) Press PLAY/PAUSE button then the slideshow will pause. Press the button again to resume the slideshow playback.

L. Connecting to Other Equipment

1. AV Out

Connecting to a TV or Another Monitor (Refer to Figure 4)

Connect the black end (1/8" plug) of the audio/video cable into the unit's DVD's A/V OUT jack, and connect the other end to the AUDIO INPUT jacks on your TV or Monitor using an additional set of AV cable (not included) (white = left audio channel, red = right audio channel, yellow = video).

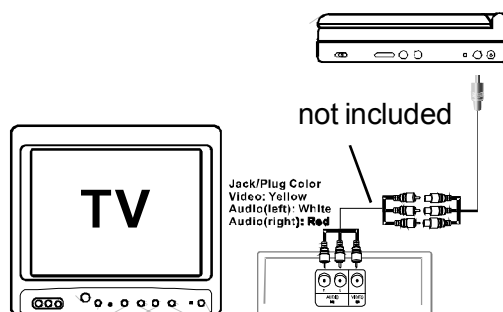

Figure 4

2. Connecting Headphones (Not included)

Simply plug the headphones into either Headphone jack 1 or Headphone jack 2 on the left side of the DVD Player. (Refer to Figure 5)

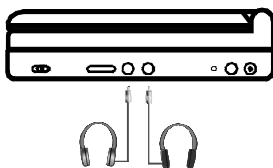

Figure 5

Plugging into Headphone jack 1 will disable the internal speakers.

M. Setup

Press SETUP button to display the Main screen of the SETUP Menu on the screen. Press SETUP button again to exit the SETUP Menu and the unit will resume its last playback mode.

- 1) Press SETUP, the 'GENERAL SETUP PAGE' will display on the screen.

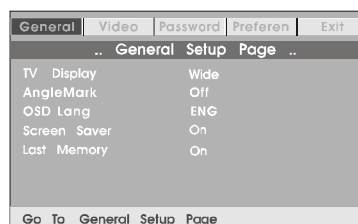

Main SETUP Menu Screen Display

- a) Select 'TV DISPLAY' using the DOWN button, and then press RIGHT to enter the submenu. Select the TV display mode on the screen using UP/DOWN, and press ENTER to confirm the setting. Press the LEFT button to exit the TV DISPLAY menu.
 - * NORMAL/PS: When the player is connected to a normal TV, and a wide picture is shown on the full screen.
 - * NORMAL/LB: When the player is connected to a normal TV, and a wide picture is shown on the screen with a black strip at both the top and bottom of the screen.
 - * WIDE: When the player is connected to a wide screen TV, a wide picture is shown on the full screen.

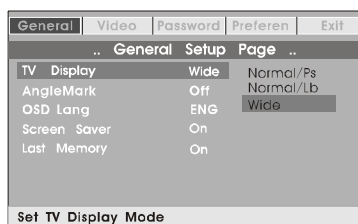

TV Display Screen Display

- b) Select 'ANGLE MARK' using the DOWN button, and then press the RIGHT button to enter the submenu. Choose Angle Mark on or off using the UP/DOWN button and then press ENTER button to confirm the setting. Press the LEFT button to return.

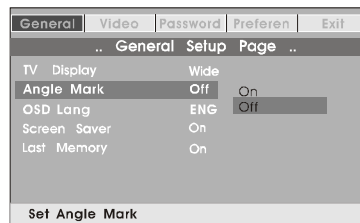

Angle Mark Screen Display

- * ON: The screen will show the angle mark icon. (*If an angle option is available).
 - * OFF: The screen will not display the Angle Mark icon.
- NOTE:** Not all discs contain above features.

- c) Select 'OSD LANG' using the DOWN button, and then press the RIGHT button to enter the submenu. Choose the language you desire as the display language. Press the LEFT button to return.



OSD Language Screen Display

- d) Select 'SCREEN SAVER' using the DOWN button. and then press the RIGHT button to enter the submenu. Choose Screen saver on or off using the UP/DOWN buttons and then press ENTER button to confirm the setting. Press the LEFT button to return.

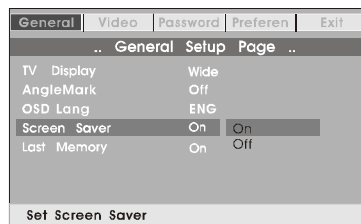

Screen Saver Screen Display

*ON: Enables screen saver.

*OFF: Disables screen saver.

NOTE: The DVD player will enter the Screen Saver mode after approximately five minutes if the same image remains on the screen.

- e) Select 'LAST MEMORY' by using the DOWN button. and then press the RIGHT button to enter the submenu. Choose Last Memory on or off using the UP/DOWN buttons and then press ENTER button to confirm the setting. Press the LEFT button to return.

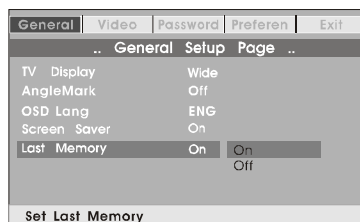

Last Memory Screen Display

*ON: During playback or in the pause mode, if you open the disc tray and then close without changing a disc, the unit will memorize the last playback status and resume playback from the memorized point.

*OFF: Disable the last memory function.

NOTE: The last memory function will be disabled when you input password to temporarily change the player's parental level to play a disc.

- 2) Select 'VIDEO' by using the LEFT/RIGHT buttons, press ENTER button to enter the VIDEO SETUP PAGE.



Video Quality Setup Screen Display

- a) Select 'BRIGHTNESS' by using the UP or DOWN button, then press ENTER button. Adjust the Brightness by pressing the LEFT or RIGHT button. To exit Brightness Setting, press ENTER button again.

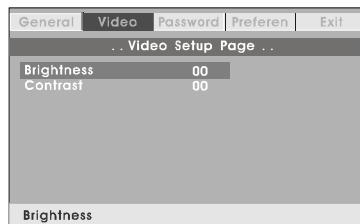

Brightness Screen Display

- b) Select 'CONTRAST' by using the UP or DOWN buttons, then press ENTER button. Adjust the Contrast by pressing the LEFT or RIGHT buttons.

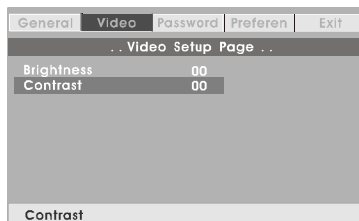

Contrast Screen Display

Press ENTER button again to exit the Contrast setting. And press LEFT button to exit the VIDEO QUALITY SETUP menu.

- 3) Select 'PASSWORD' using the LEFT or RIGHT buttons, then press the ENTER button to enter the submenu.

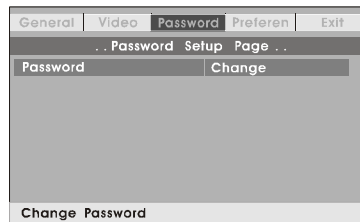

Password Setup Page Screen Display

Press ENTER button twice to enter the PASSWORD CHANGE PAGE. Input the Old Password or the Default Password, the New Password, and the Confirmed New Password. Press ENTER button to confirm the change.

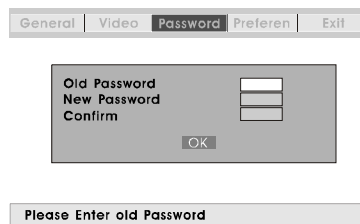

Password Change Page Screen Display

NOTE: The Default Password is **3308**. This password is always effective even after you have selected your own password and changed it. To avoid the possibility of others using the default password to set the parental level and change the password, you can record this default password in another area and delete it from this manual. Some discs can be limited depending on the age of users while some discs cannot.

- 4) With no disc inside the player select 'PREFEREN' using the LEFT or RIGHT button, then press ENTER button to enter the 'PREFERENCE PAGE'.

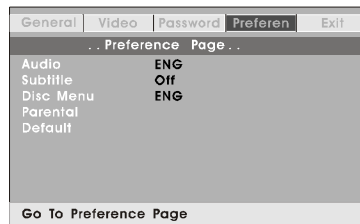

Preference Page Screen Display

- a) Select 'AUDIO' using the DOWN button, then press ENTER button to enter the submenu. Select the audio language you desire using the UP or DOWN buttons, then press ENTER button to confirm the setting. Press LEFT button to return.

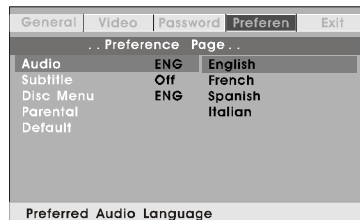

Preferred Audio Language Screen Display

- b) Select 'SUBTITLE' using the DOWN button, then press ENTER button to enter the submenu. Select the desired subtitle language or OFF using the UP or DOWN buttons, then press ENTER to confirm the setting. Press LEFT to return.

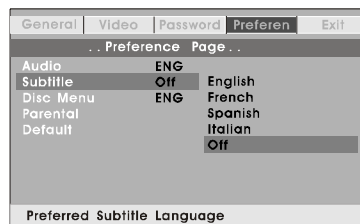

Preferred Subtitle Language

- c) Select 'DISC MENU' using the DOWN button, then press ENTER button to enter the submenu. Select the Disc Menu Language you desire using the UP or DOWN buttons, then press ENTER button to confirm the setting. Press LEFT to return.



Preferred Disc Menu Language Screen Display

NOTE: Language and subtitle selection is only available for discs that are recorded in the above listed languages. If the selected language is not available, the player will play and display on the screen the original recorded language contained in the disc.

- d) Select 'PARENTAL' using the DOWN button, then press ENTER button to enter the submenu.

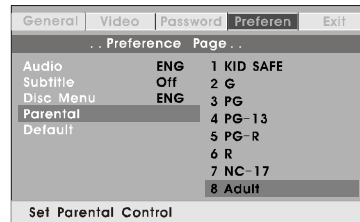

Parental Preference Screen Display

Select the parental level you desire using the UP or DOWN button for discs with lock-out function or multiple rating levels. These are listed from the lowest level (1 KID SAFE) to the highest level (8 ADULT). Enter a 4 digit password, then press ENTER button to confirm the parental level setting.

NOTE: The level of 8 ADULT is the factory default.

- e) Select 'DEFAULT' using the DOWN button, then press ENTER button to enter the submenu. Press ENTER button to make the setting return to the factory-set mode.



Load Factory Setting Screen Display

NOTE: The parental setting is not affected by the default reset function.

N. Specifications

Compatible DISC: DVD, CD, CD-R, CD-RW, DVD+/-R, DVD+/-RW

Signal system: NTSC

Panel size: 8 inch

Frequency response: 20 Hz to 20 kHz

Video output: 1 V_{p-p}/75 Ohm, unbalanced

Audio output: 1.4V_{rms}/10kOhm

Audio S/N: Better than 60 dB

Dynamic range : Better than 85 dB

Laser: Semiconductor Laser, Wave Length: 650 nm/795 nm

Power source: DC 9-12 V

Power consumption: 7 W

Operating temperature: 41~95°F (5~35°C)

Weight : 1.74lbs (0.79 kg)

Dimensions (W x D x H): 8.03 X 5.90 X 1.57 inches

(204 x 150 x 40 mm)

Battery spec

Type: Li-polymer

Model no.: 6532100(30)

Rating: 1600mAh 7.4V

Manufacturer: Great Power Battery (Zhuhai) Co., Ltd

O. Rechargeable Built-in Battery Use

The DVD player utilizes a long-life Li-Polymer battery for portability. Li-Polymer batteries feature high storage capacity and low level of degradation. This means the Li-Polymer batteries do not have “Memory Effect” and thus can be recharged regardless of whether the battery is fully or only partially discharged. **The battery must be charged at least 8 hours prior to first use.**

NOTE: If you plan not to use the battery for an extended period of time (one week or longer), we recommend that you fully charge the battery. For longer periods of storage, please recharge the battery at least once every two months to maintain the battery in optimum condition.

Each full recharge takes approximately five hours and one full charge can provide power to the player for approximately 2 hours. During recharge, the red indicator will stay on. Once fully recharged, the red light will be green. At this point you may remove the wall plug and stop charging.

Precautions Related to Battery Recharge:

1. The DVD player must be set to power off.
2. Once the battery is fully discharged, immediately recharge (regardless of whether you plan to use battery or not) in order to maximize battery life.
3. To charge the battery, please connect the power jack directly into the DVD Player and leave connected until the red power indicator turns green.

Using and Maintaining Your Rechargeable Batteries

1. Please make sure you always use **only** the AC adapter included with the player to recharge your battery. The battery can only be charged with the AC adaptor and will **NOT** charge with the car DC adaptor.
2. Recharge efficiency will degrade when environmental temperatures drop below 41°F (5°C) or exceed 95°F (35°C).
3. Do not leave the DVD player in a hot automobile or temperatures exceeding 122°F (50°C). Permanent battery damage, fire, or explosion may result.

P. Troubleshooting

PROBLEM	SOLUTION
No sound or distorted sound	<ul style="list-style-type: none">• Make sure the DVD player is connected properly. Make sure all cables are securely inserted into the appropriate jacks.
Can't advance through a movie	<ul style="list-style-type: none">• You can't advance through the opening credits and warning information that appears at the beginning of movies because the disc is programmed to prohibit that action.
The icon (⊗) appears on screen	<p>The feature or action cannot be completed at this time because:</p> <ol style="list-style-type: none">1. The disc's software restricts it.2. The disc's software doesn't support the feature (e.g., angles)3. The feature is not available at the moment.4. You've requested a title or chapter number that is out of range.
Picture is distorted	<ul style="list-style-type: none">• The disc might be damaged. Try another disc.• It is normal for some distortion to appear during forward or reverse scan.
No forward or reverse scan	<ul style="list-style-type: none">• Some discs have sections that prohibit rapid scanning or title and chapter skip.• You will not be able to skip through the warning information and credits at the beginning of a movie. This part of the movie is often programmed to prohibit skipping through it.

Troubleshooting (Cont)

PROBLEM	SOLUTION
IR sensor inoperative	<ul style="list-style-type: none">• Verify that the batteries in the remote are fresh.• Verify that the remote sensor eye is not obstructed.
Disc won't play	<ul style="list-style-type: none">• Check the type of disc you put into disc tray. This DVD player only plays DVDs and audio CDs.
Play starts, but then stops immediately	<ul style="list-style-type: none">• Your DVD player has been designed to process regional management information that is stored on DVD discs. The regional code for your player is 1 (The U.S., U.S. Territories and Canada). Only DVD discs that have regional codes of 1 or ALL (for all regions) can be played by your player.• The disc is dirty. Clean it.• Condensation has formed. Allow player to dry out.

The descriptions and characteristics in this owner's manual are for the purpose of general reference only and not as a guarantee. In order to provide you with the highest quality product, we may make changes or modifications without prior notice. The English version serves as the final reference on all product and operation details should any discrepancies arise in other languages.



AUDIOVOX
ELECTRONICS CORP.

90 DAY LIMITED WARRANTY
Applies to Audiovox Video Products

AUDIOVOX ELECTRONICS CORP. (the Company) warrants to the original retail purchaser of this product that should this product or any part thereof, under normal use and conditions, be proven defective in material or workmanship within ninety (90) days from the date of original purchase, such defect(s) will be repaired or replaced with reconditioned product (at the Company's option) without charge for parts and repair labor. A game controller, if supplied, is similarly warranted for ninety (90) days.

To obtain repair or replacement within the terms of this Warranty, the product is to be delivered with proof of warranty coverage (e.g. dated bill of sale), specification of defect(s), transportation prepaid, to the Company at the address shown below.

This Warranty does not extend to the elimination of externally generated static or noise, to correction of antenna problems, to costs incurred for installation, removal or reinstallation of the product, or to damage to digital memory/media devices, gaming devices, discs, speakers, accessories, or electrical systems.

This Warranty does not apply to any product or part thereof which, in the opinion of the Company, has suffered or been damaged through alteration, improper installation, mishandling, misuse, neglect, accident, or by removal or defacement of the factory serial number/bar code label(s). THE EXTENT OF THE COMPANY'S LIABILITY UNDER THIS WARRANTY IS LIMITED TO THE REPAIR OR REPLACEMENT PROVIDED ABOVE AND, IN NO EVENT, SHALL THE COMPANY'S LIABILITY EXCEED THE PURCHASE PRICE PAID BY PURCHASER FOR THE PRODUCT.

This Warranty is in lieu of all other express warranties or liabilities. ANY IMPLIED WARRANTIES, INCLUDING ANY IMPLIED WARRANTY OF MERCHANTABILITY, SHALL BE LIMITED TO THE DURATION OF THIS WRITTEN WARRANTY. ANY ACTION FOR BREACH OF ANY WARRANTY HEREUNDER INCLUDING ANY IMPLIED WARRANTY OF MERCHANTABILITY MUST BE BROUGHT WITHIN A PERIOD OF 12 MONTHS FROM DATE OF ORIGINAL PURCHASE. IN NO CASE SHALL THE COMPANY BE LIABLE FOR ANY CONSEQUENTIAL OR INCIDENTAL DAMAGES FOR BREACH OF THIS OR ANY OTHER WARRANTY. No person or representative is authorized to assume for the Company any liability other than expressed herein in connection with the sale of this product.

Some states do not allow limitations on how long an implied warranty lasts or the exclusion or limitation of incidental or consequential damage so the above limitations or exclusions may not apply to you. This Warranty gives you specific legal rights and you may also have other rights which vary from state to state.

Audiovox Electronics Corporation, 150 Marcus Blvd., Hauppauge, New York 11788 • 1-800-645-4994

128-5556G

Audiovox Electronics Corporation
150 Marcus Boulevard
Hauppauge, NY 11788
www.audiovox.com

128-8573 (V1.0)
Printed in China

Free Manuals Download Website

<http://myh66.com>

<http://usermanuals.us>

<http://www.somanuals.com>

<http://www.4manuals.cc>

<http://www.manual-lib.com>

<http://www.404manual.com>

<http://www.luxmanual.com>

<http://aubethermostatmanual.com>

Golf course search by state

<http://golfingnear.com>

Email search by domain

<http://emailbydomain.com>

Auto manuals search

<http://auto.somanuals.com>

TV manuals search

<http://tv.somanuals.com>