

OWNERS MANUAL

by **AUDIOVOX®**

MVDV4A

PORTABLE DVD PLAYER

A. SAFETY PRECAUTIONS



- The lightning flash with arrowhead symbol within an equilateral triangle is intended to alert the user to the presence of uninsulated "dangerous voltage" within the product's enclosure that may be of sufficient magnitude to constitute a risk of electric shock to persons.



- The exclamation point within an equilateral triangle is intended to alert the user to the presence of important operating and maintenance (servicing) instructions in the literature accompanying the product.

WARNING: To reduce the risk of fire or electric shock, do not expose this appliance to rain or moisture. Dangerous high voltages are present inside the enclosure. Do not open the cabinet.

CAUTION: To prevent electric shock, match wide blade plug to wide slot, fully insert.

CAUTION: The unit employs a laser system. To ensure the proper use of the unit, read this manual carefully and keep it for future reference. If the unit requires servicing, contact the seller or our service center- see "troubleshooting". To prevent direct exposure to the laser radiation, do not open the cabinet. In visible laser radiation when the cabinet is opened or the interlocks are defeated. Do not stare into the laser beams. Use of any controls, adjustments, or procedures other than those specified herein may result in hazardous radiation exposure.

WARNING: Not for use where video monitor is visible to driver to avoid risk of serious injury or possible violation of state laws.

B. IMPORTANT SAFETY INSTRUCTIONS

- (1)Read Instructions - All the safety and operating instructions should be read before the product is operated.
- (2)Retain Instructions - The safety and operating instructions should be retained for future reference.
- (3)Heed Warnings - All warnings on the product and in the operating instructions should be adhered to .
- (4)Follow Instructions - All operating and use instructions should be followed
- (5)Cleaning - unplug this product from the wall outlet before cleaning. Do not use liquid cleaners or aerosol cleaners. Use a damp cloth for cleaning.
- (6)Attachments - Do not use attachments not recommended by the product manufacturer as they may cause hazards.
- (7)Water and moisture - Do not use this product near water - for example, near a bath tub, wash bowl, kitchen sink, or laundry tub; in a wet basement; or near a swimming pool; and the like.
- (8)Accessories - Do not place this product on an unstable cart, stand, tripod, bracket, or table. The product may fall, causing serious injury to a child or adult, and serious damage to the product. Use only with a cart, stand, tripod, bracket, or table recommended by the manufacturer, or sold with the product. Any mounting of the product should follow the manufacturer's instructions, and should use a mounting accessory recommended by the manufacturer.
- (9)A product and cart combination should be moved with care. Quick stops, excessive force and uneven surfaces may cause the product and cart combination to overturn.
- (10)Power Sources - This product should be operated only from the type of power source indicated on the rear panel. If you are not sure of the type of power supply to your home consult your product dealer or local power company. For products intended to operate from battery power, or other sources, refer to the operating instructions.
- (11)Grounding or Polarization - This product may be equipped with a polarized alternating-current line plug(a plug having one blade wider than the other). This plug will fit into the power outlet only one way.This is a safety feature. If you are unable to insert the plug fully into the outlet, try reversing the plug. If the plug should still fail to fit, contact your electrician to replace your obsolete outlet. Do not defeat the safety purpose of the polarized plug.
- (12)Power- Cord Protection - Power-supply cords should be routed so that they are not likely to be walked on or pinched by items placed upon or against them, paying particular attention to cords at plugs, convenience receptacles, and the point where they exit from the product.

B. IMPORTANT SAFETY INSTRUCTIONS

- (13) Lightning - For added protection for this product during a lightning storm, or when it is left unattended and unused for long periods of time, unplug it from the wall outlet and disconnect the antenna or cable system. This will prevent damage to the product due to lightning and power-line surges.
- (14) Power Lines - An outside antenna system should not be located in the vicinity of overhead power lines or other electric light or power circuits, or where it can fall into such power lines or circuits. When installing an outside antenna system, extreme care should be taken to keep from touching such power lines or circuits as contact with them might be fatal.
- (15) Overloading - Do not overload wall outlets, extension cords, or integral convenience receptacles as this can result in a risk of fire or electric shock.
- (16) Object and Liquid Entry - Never push objects of any kind into this product through result in a fire or electric shock. Never spill liquid of any kind on the product.
- (17) Servicing - Do not attempt to service this product yourself as opening or removing qualified service personnel.
- (18) Damages Requiring Service - Unplug this product from the wall outlet and refer servicing to qualified service personnel under the following conditions.
 - a) When the power- supply cord or plug is damaged.
 - b) If liquid has been spilled , or objects have fallen into the product.
 - c) If the product has been exposed to rain or water.
 - d) If the product does not operate normally by following the operating instructions. Adjust only those controls that are covered by the operating instructions as an improper adjustment of other controls may result in damage and will often require extensive work by a qualified technician to restore the product to its normal operation.
 - e) If the product has been dropped or damaged in any way.
 - f) When the product exhibits a distinct change in performance - this indicates a need for service.
- (19) Replacement parts - When replacement parts are required, be sure the service technician has used replacement parts specified by the manufacturer or have the same characteristics as the original part. Unauthorized substitutions may result in fire, electric shock or other hazards.
- (20) Safety Check - Upon completion of any service or repair to this product, ask the service technician to perform safety checks to determine that the product is in proper operating condition.
- (21) Heat - The product should be situated away from heat sources such as radiators, heat registers, stoves or other products(including amplifiers)that produce heat.

TABLE OF CONTENTS

A. SAFETY PRECAUTIONS	1
B. IMPORTANT SAFETY INSTRUCTIONS	2-3
C. FEATURES	4
D. ABOUT MANUAL	5
E. PLAYABLE DISCS	5
F. TERMS FOR DISCS	6
G. BEFORE OPERATION	7
H. PRECAUTIONS FOR DISCS	7
I. PREPARATIONS BEFORE OPERATION	8
◦ CHECK ACCESSORIES	8
◦ USE REMOTE CONTROL	8
◦ FRONT PANEL	9
◦ DISPLAY	10
◦ REAR PANEL	10
◦ NAMES AND LAYOUT OF REMOTE CONTROLS	11
◦ CONNECTIONS	12
J. BASIC OPERATIONS	15
◦ SYSTEM SETTING	15
◦ PLAY DISCS	15
◦ PAUSE	16
◦ OSD	16
◦ DVD MENU PLAY	19
◦ AUDIO/ VIDEO IN	19
K. FUNCTION SETTING	20
MENU SETTING	20
L. PLAY DISCS IN VARIOUS WAYS	25
◦ AUDIO MODE	25
◦ MUTE	25
◦ FAST PLAY	26
◦ SLOW PLAY	26
◦ REPEAT PLAY	27
◦ SELECT SUBTITLES	28
◦ ANGLES SELECT	28
◦ ZOOM PLAY	29
M. PLAY MP3 DISCS	29
N. OTHERS	30
◦ TROUBLE SHOOTING	30
◦ TECHNICAL SPECIFICATIONS	31
O. INSTALLATION	32
◦ INSTALLATION GUIDE	32

C. FEATURES

1. OUTSTANDING SOUND QUALITY

Dolby Digital  system developed by Dolby Laboratories features high quality audio which can be played in DVD or CD disc at home.

2. HIGH DEFINITION

The unit adopts MPEG2 coding format and brings the horizontal resolution over 500 lines.

3. UNIQUE FUNCTIONS

Multi-angle and multi-language.
Parental lock makes it easy to control the content of discs.

4. SCREEN

4x3 screen and wide screen (16:9) are available.

5. COMPATIBILITY

The unit can play DVD, CD and MP3 discs.

6. ZOOM

It can enlarge pictures twice or three or four times as large.

It can also shrink pictures 1/2, 1/3, or 1/4 as big.

7. MULTI-FUNCTIONS

Fast forward, fast reverse, slow play, frame (step) play, repeat play.

8. CONTENT DISPLAY

Colored fluorescent display and English OSD, make the disc content clearer.



9. VIDEO OUTPUT

Standard video output mode and easy system change.



This product incorporates copyright protection technology that is protected by method claims of certain U.S. patents and other intellectual property rights owned by Macrovision Corporation and other rights owners. Use of this copyright protection technology must be authorized by Macrovision Corporation, and is intended for home and other limited viewing uses only unless otherwise authorized by Macrovision Corporation. Reverse engineering or disassembly is prohibited.

D. ABOUT MANUAL

- This manual mainly introduces how to use the buttons on the remote control.
- You may operate the unit if the buttons on the unit have the same or similar names as to those on the remote control.
- The marks shown in the right chart are used in the manual.
- "Ⓢ" may appear on the TV screen during operation. This icon means the function explained in the owner's manual is not available on that disc.

MARK	INDICATION
	functions of DVD
	functions of CD

E. PLAYABLE DISCS

TYPE	MARK	CONTENT	SIZE	PLAYING TIME
DVD		audio+video (motion pictures)	12cm	approx. 2hrs (single-side disc) approx. 4hrs (double-side disc)
			8cm	approx. 80mins (single-side disc) approx. 160mins (double-side disc)
CD		audio	12cm	approx. 74mins
			8cm	approx. 20mins
MP3		audio	12cm	600mins

Note: Region codes for DVD disc are printed on the rear panel, only the disc with same code can be played.

F. TERMS FOR DISCS

• **TITLE**

The images or music of a DVD are divided into some units, among which title is the biggest one.

To an image in video software, title is movie; to a piece of music in audio software, it is disk.

Each title has a indication number which makes it easy to locate.

• **CHAPTER**

It is the smallest unit of a DVD. A title is made up of several chapters, and each chapter has a number for search. But some discs may not have numbered chapters.

• **TRACK**

The music in a CD. Each track has a number for search.

STRUCTURE OF DVD

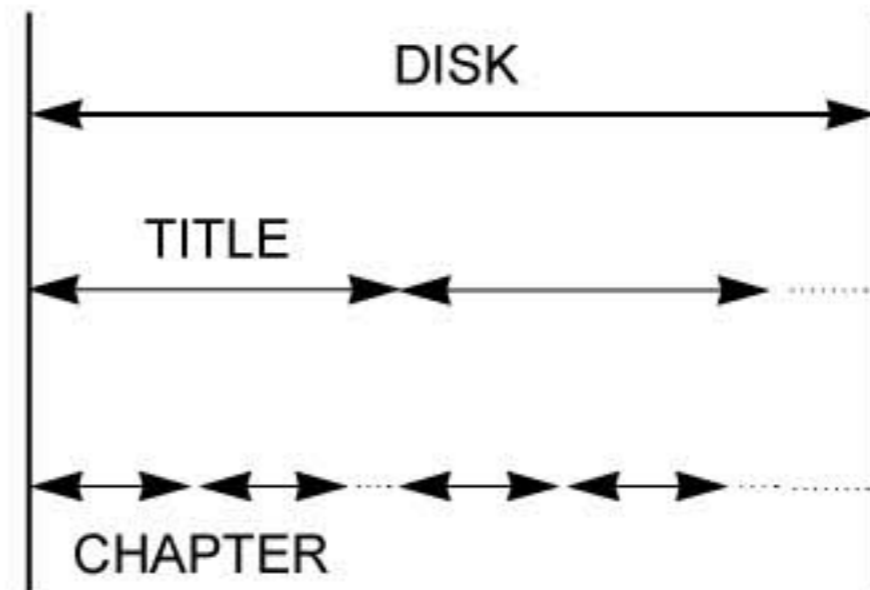

STRUCTURE OF CD

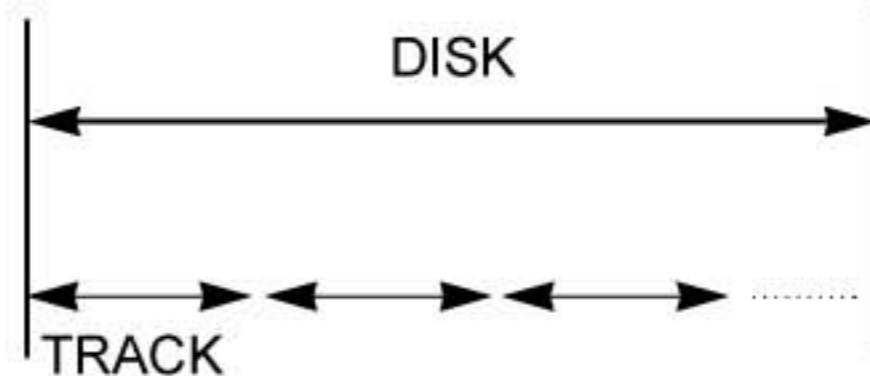

G. BEFORE OPERATION

WHEN DRIVING

- Keep the volume level low enough to be aware of road and traffic conditions.

WHEN CAR WASHING

- Do not expose the product to water or excessive moisture. This could cause electrical shorts, fire or other damage.

WHEN PARKED

- Parking in direct sunlight can produce very high temperatures inside your vehicle.
- Give the interior a chance to cool down before starting playback.

PLACEMENT

- Put the unit where ventilation is good enough to prevent overheating.
- Never put the unit in direct sunlight or near heat sources.
- Put the unit horizontally, never put any heavy object on the unit.
- To protect the laser, do not put the unit where there is most dust. If there is dust on the laser, use a cleaning disc to clean it.
- Refer to the operation instructions of the cleaning disc you bought.

CONDENSATION

Water will appear on the pickup lens in the following cases:

- The unit is suddenly moved a cold place to a warm place.
- The unit is put in a room with a heater, or in the cold air from a air-conditioner.

- Use of the unit in a humid place. In these cases, the unit can not work. Unload the disc and leave the unit on for about one hour to evaporate the water.

CLEANING

- Use soft cloth with a little neutral detergent to wipe the cabinet, panel and controls. Never use abrasive paper, polishing powder or solvent like alcohol and gasoline.

H. PRECAUTIONS FOR DISC

HANDLING DISC

- To keep the disc clean, do not touch the play sides of the disc.
- Do not attach paper or tape to the disc.

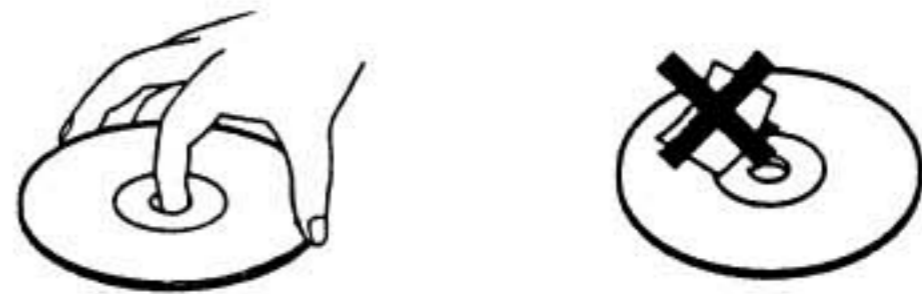

- Keep the disc away from direct sunlight or heat sources.
- Store the disc in a disc case after playback.

CLEANING DISC

- Before playback, wipe the disc outwards from the center with clean cloth.

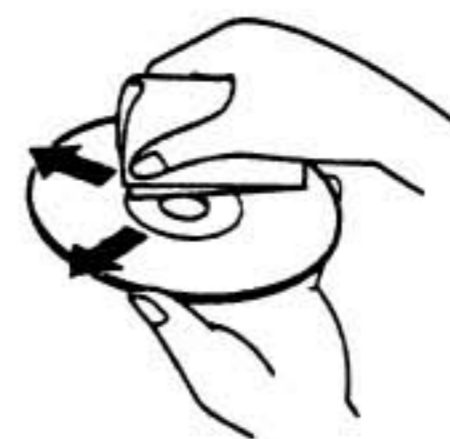

- Do not use any type of solvent such as thinner, benzene, commercially available cleaners or antistatic spray.

I. PREPARATIONS BEFORE OPERATION

This part introduces the work to be done before operating the unit.

CHECK ACCESSORIES

Check if you have all the accessories after the carton is opened.

- ∞ Audio cords 2(L+R channels)
- ∞ Video cord 1
- ∞ Remote control 1
- ∞ AAA batteries 2
- ∞ Owner's manual 1
- ∞ External remote sensor 1
- ∞ Mounting fittings 1
- ∞ DC 12V power source cord 1

USE REMOTE CONTROL

1. Open the battery cover.

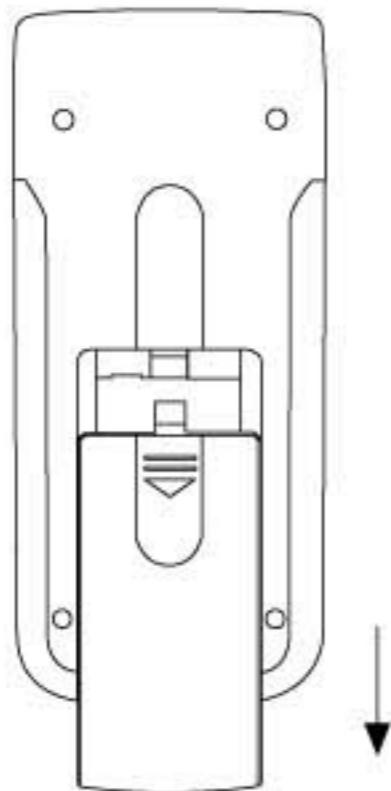

2. Insert two AAA batteries, make sure to match "+" and "-" on the batteries to marks inside the battery compartment.

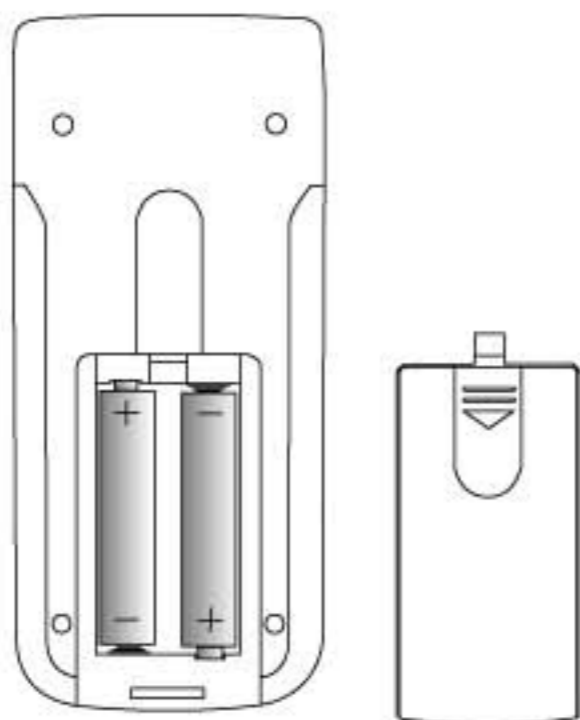

3. Close the battery cover.

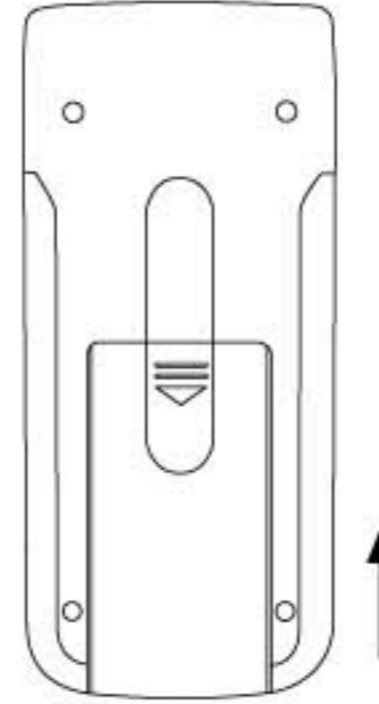

4. Point the remote control at the external remote sensor or point the remote control at the display window, operate in the range of 5 meters and 30° from the front of the remote sensor. Make sure there is no barrier between them.

Notes:

1. The batteries can last about 6 months generally.

Change the batteries if the remote control does not work.

2. If the remote control is not used for a long time, remove the batteries to prevent battery leakage.

I. PREPARATIONS BEFORE OPERATION

FRONT PANEL

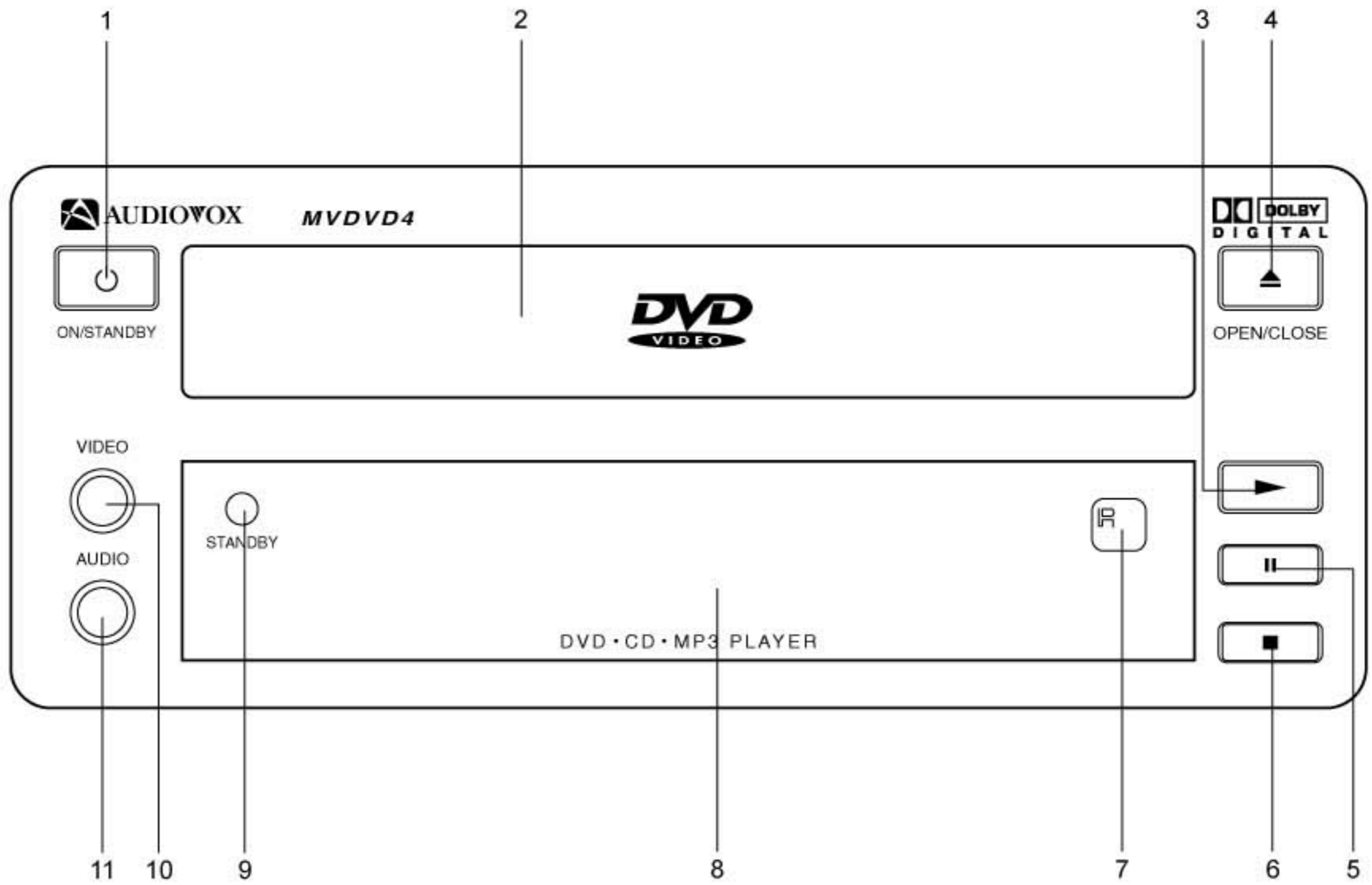

① POWER ON/STANDBY

② DISC TRAY

③ PLAY

④ OPEN/CLOSE

⑤ PAUSE

⑥ STOP

⑦ REMOTE SENSOR

⑧ DISPLAY

⑨ STANDBY INDICATOR

⑩ VIDEO IN

⑪ AUDIO IN

I. PREPARATIONS BEFORE OPERATION

DISPLAY

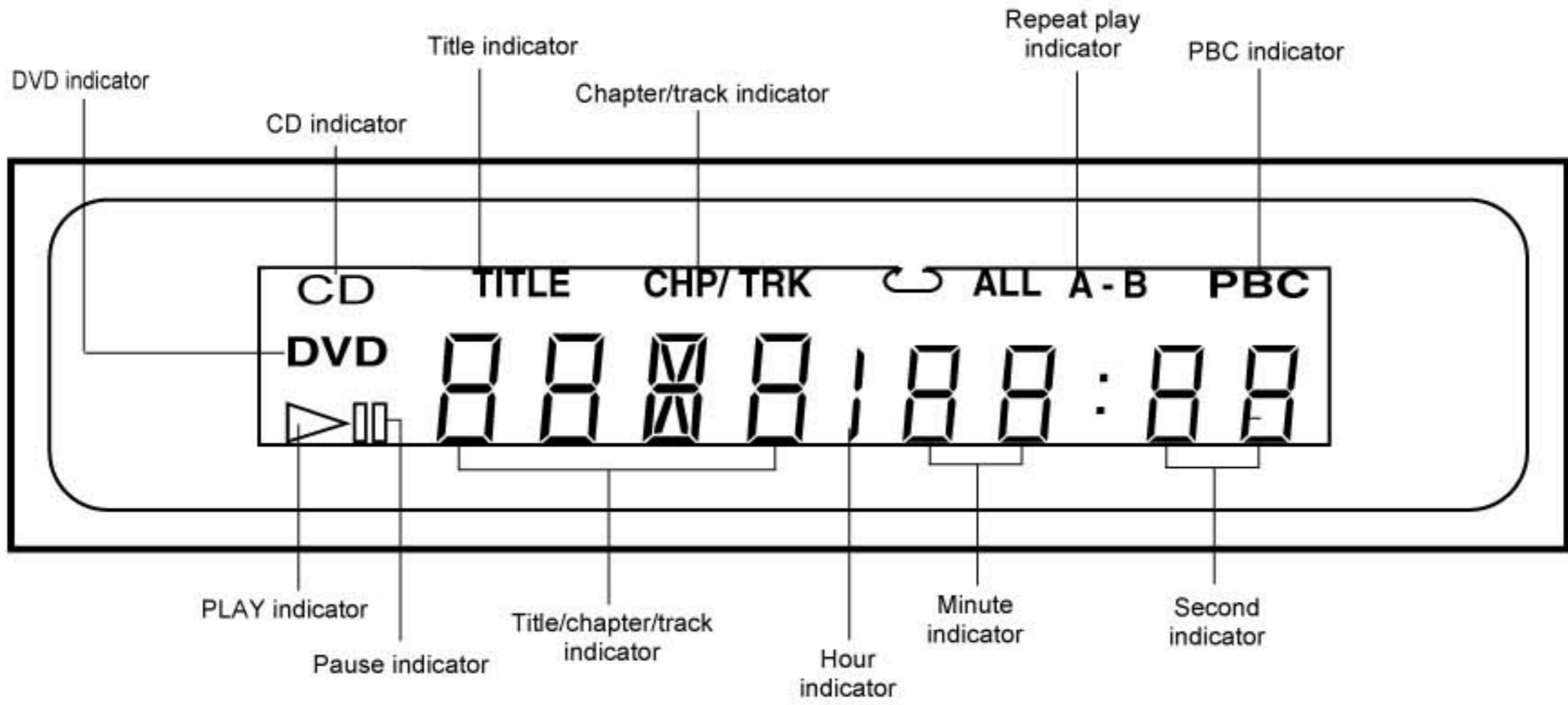

REAR PANEL

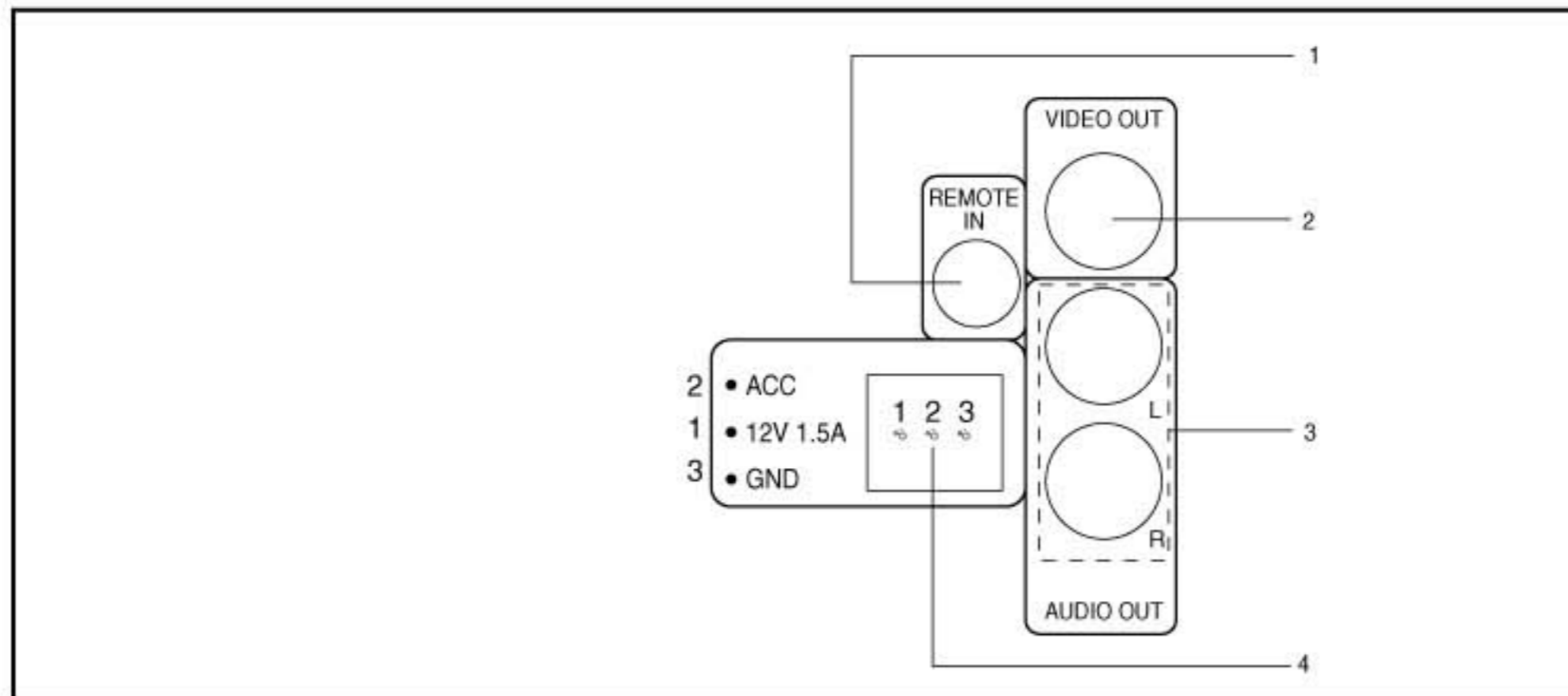

- ① REMOTE IN
- ② VIDEO OUT

- ③ AUDIO OUT
- ④ DC IN

I. PREPARATIONS BEFORE OPERATION

NAMES AND LAYOUT OF REMOTE CONTROLS

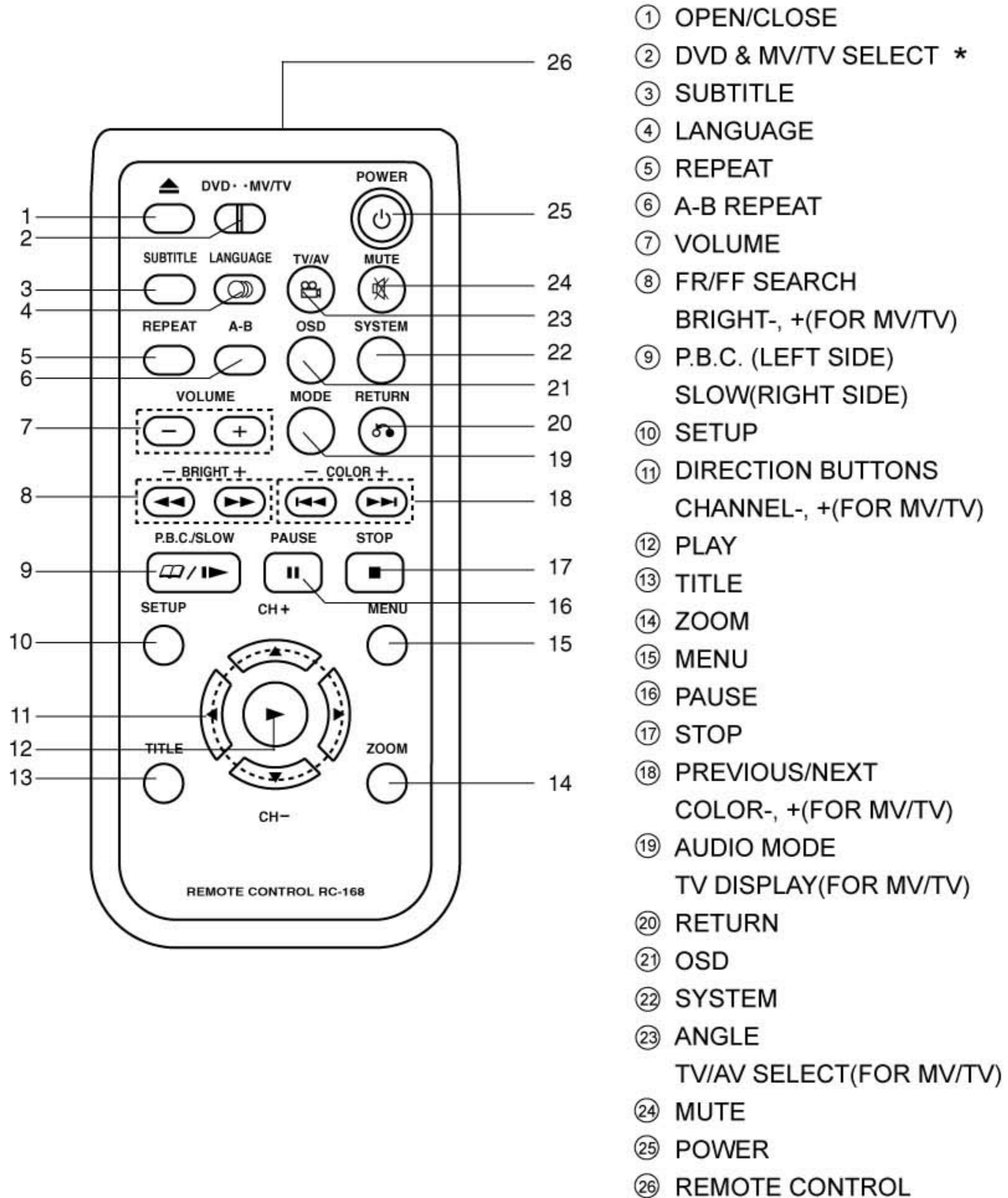

* If you want to operate the MV/TV, optional unit is required.

I. PREPARATIONS BEFORE OPERATION

CONNECTIONS

Turn off all the equipment before connections.

CONNECT TO A TV/MONITOR

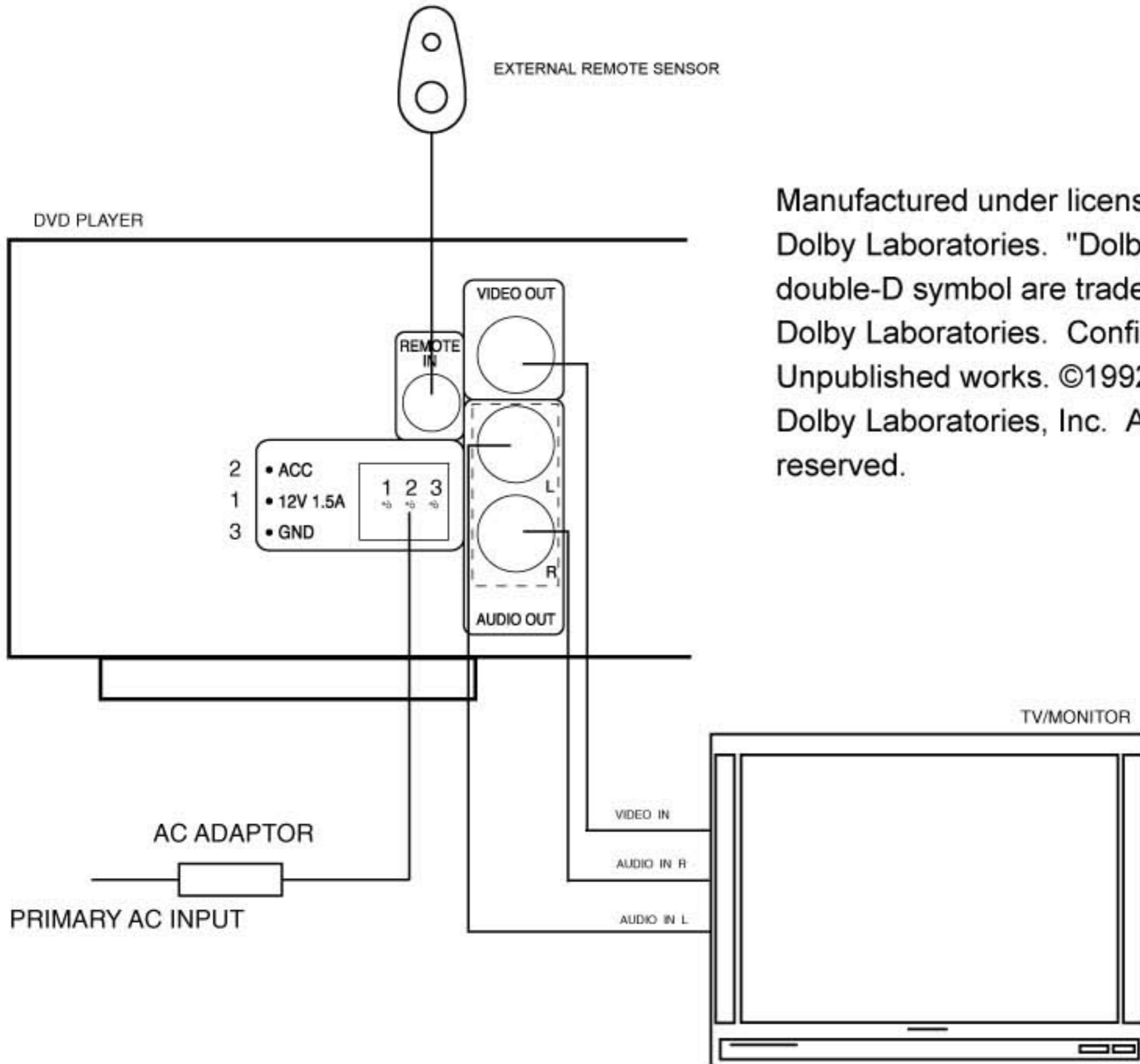

Manufactured under license from Dolby Laboratories. "Dolby" and the double-D symbol are trademarks of Dolby Laboratories. Confidential Unpublished works. ©1992-1997 Dolby Laboratories, Inc. All rights reserved.

System setting: You have to set the unit according to the TV/monitor to be connected.

- If the system of the TV/monitor is PAL, push **SYSTEM** and select PAL.
- If the system of the TV/monitor is NTSC, push **SYSTEM** and select NTSC.
- If the system of the TV/monitor is multi-system, push **SYSTEM** and select MULTI.
- Connect the unit to a wide-screen TV.
Set the "TV DISPLAY" to "WIDE " in the function setting column.
- Connect the unit to an ordinary TV.
Set the "TV DISPLAY" to "NORMAL/PS" or "NORMAL/LB" in the function setting column.

CONNECT TO AC ADAPTOR(not supplied)

1. Connect the output terminal of the AC adaptor to DC IN jack of this unit.
2. Connect the other plug to AC power source.

I. PREPARATIONS BEFORE OPERATION

CONNECT TO AN ORDINARY AMPLIFIER

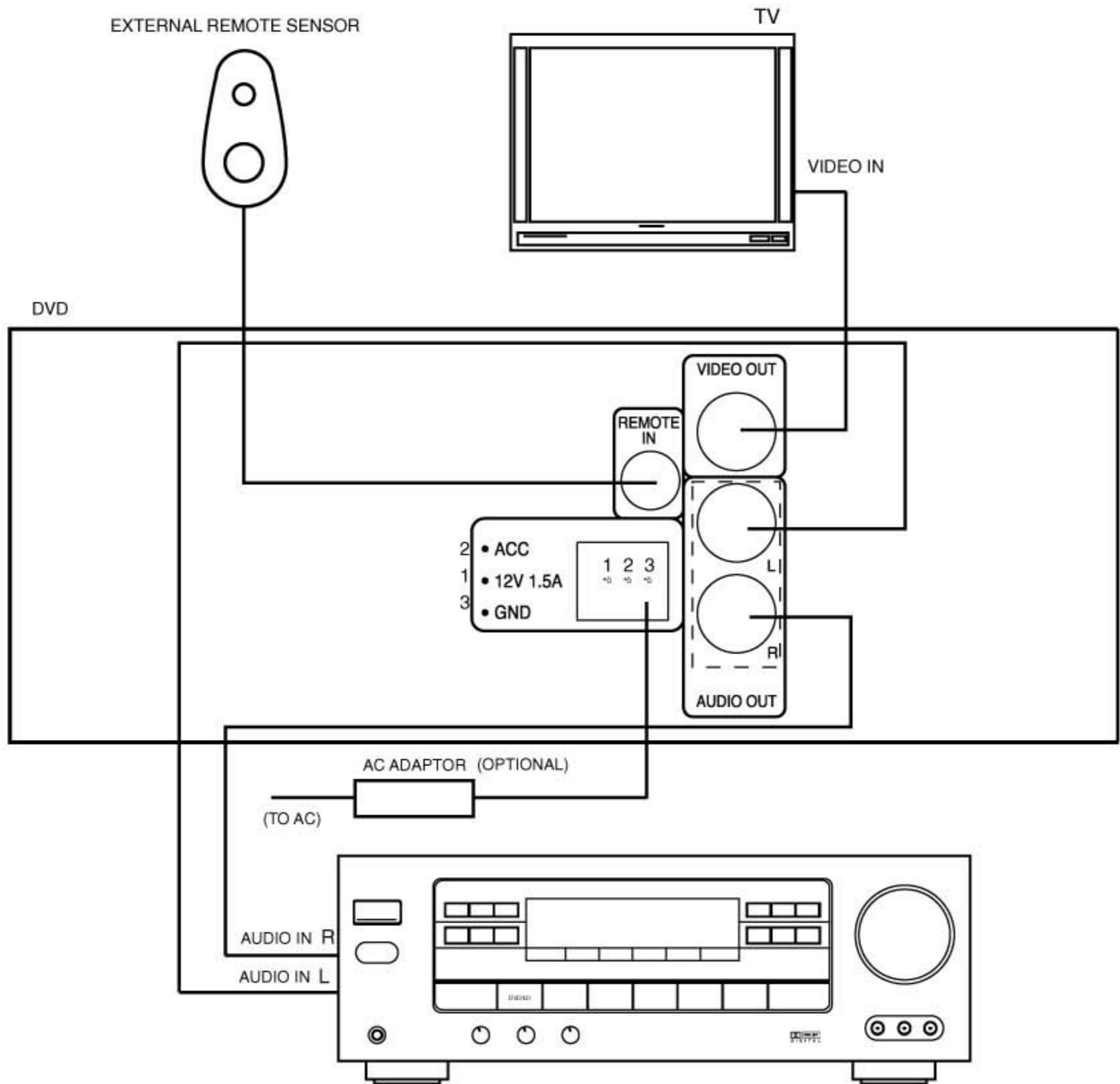

• There is no sound output from the output terminal when a DTS disc is played.

I. PREPARATIONS BEFORE OPERATION

CONNECT TO A MOBILE AMPLIFIER

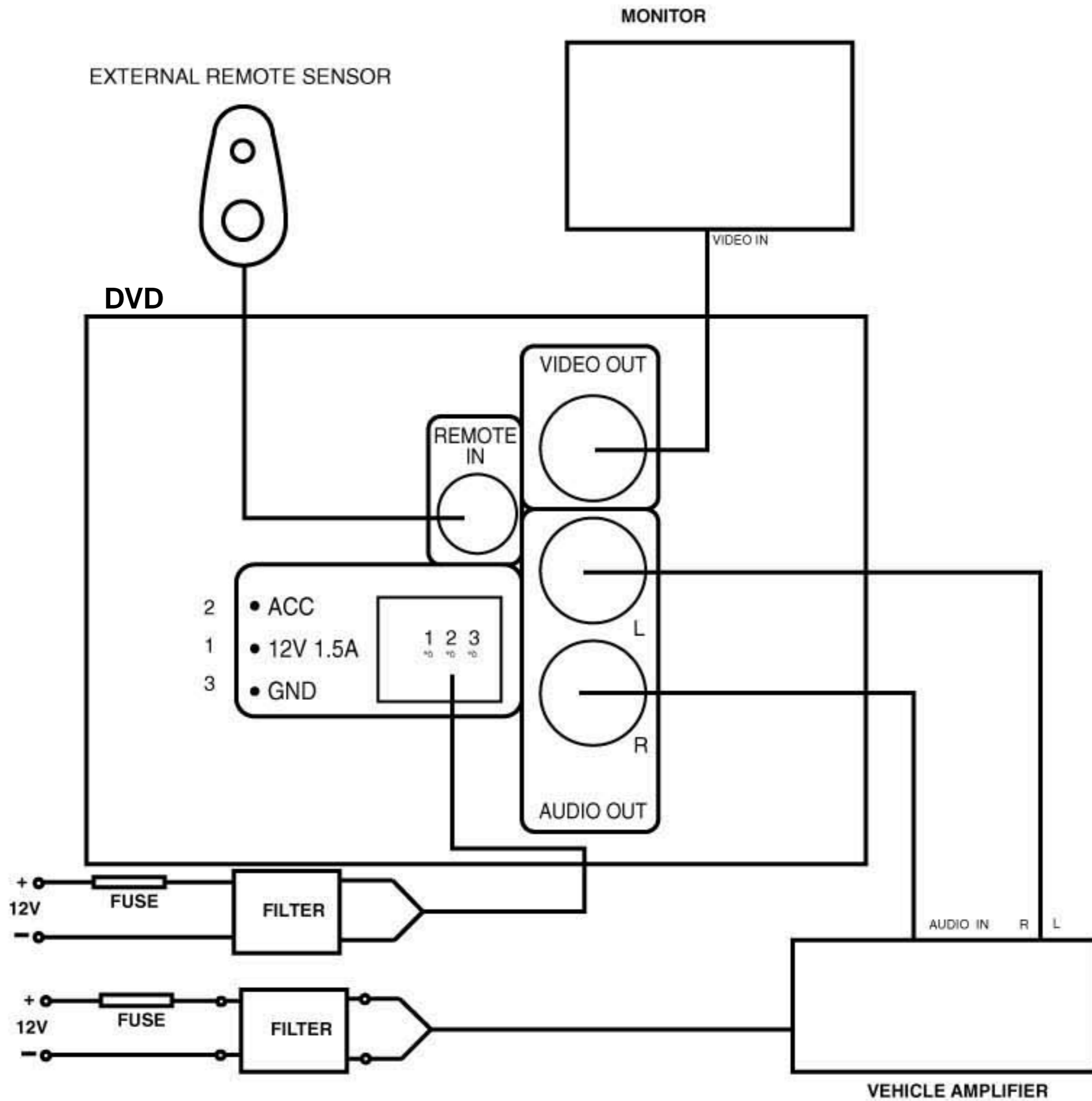

In the connection diagram above, the two "+" polarities can be simultaneously connected to the "+" polarity of the mobile DC 12V. And the two "-" polarities can be simultaneously connected to the "-" polarity of the mobile DC 12V.

J. BASIC OPERATIONS

◦^ SYSTEM SETTING

The unit can recognize color system of the disc automatically and transmit the corresponding signal.

◦§If your TV can only receive PAL system, select the standard of the unit PAL. The unit will keep PAL output in spite of which signal format is used by the disc being played.

◦§If your TV can only receive NTSC system, select the standard of the unit NTSC.

◦§If your TV is multi - system, we advise you to select MULTI to get clearer images.

PLAY DISCS

1. Load a disc and press ► (PLAY) to play the disc.

2. Stop playback.

Press ◦^ .

3. Remove the disc and switch off the unit.

◦§You have to press this "◦^ " button twice to stop the playback of DVD discs.

J. BASIC OPERATIONS

PAUSE

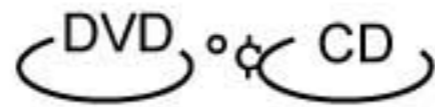

Press **⏸**

◦ WHEN PLAYING MOVIES

If the movies of a DVD is played, press **⏸** to make playback pause.

The unit enters step play status. Each time you press **⏸**, the picture advances one frame.

◦ WHEN PLAYING MUSIC CD

Press **⏸** to make playback pause.

Press **▶** (PLAY) to resume playback.

OSD

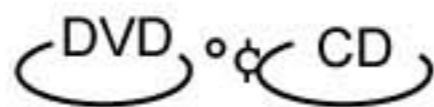

The On-Screen Display (OSD) contains many playback features. To see the Display, press the **OSD** button on the remote while a disc is playing. The Display appears across the top of the screen. Each feature is illustrated with an icon. Use the **◀** or **▶** buttons on the remote to move through the different icons in the Display.

When an icon is highlighted, use the **▼** or **▲** buttons on the remote to scroll through the choices displayed in the text box under the icons.

Remember, you can only access the Display when you're playing a disc. Also, the Display features are only available if the disc was created with that particular feature (i.e., if you select the Subtitle icon, you won't be able to change the subtitle language unless the author of the disc created the disc with subtitles).

The invalid symbol "⊘" appears on the screen when you press a button that doesn't have any function. If one of the icons is "grayed out", that Display feature isn't available for the disc you're playing. To make the Display disappear from the screen, press OSD on the remote.

WHEN PLAYING DVD

DVD discs have the following playback features: Title, Chapter, Audio, Subtitle, Angle and Repeat.

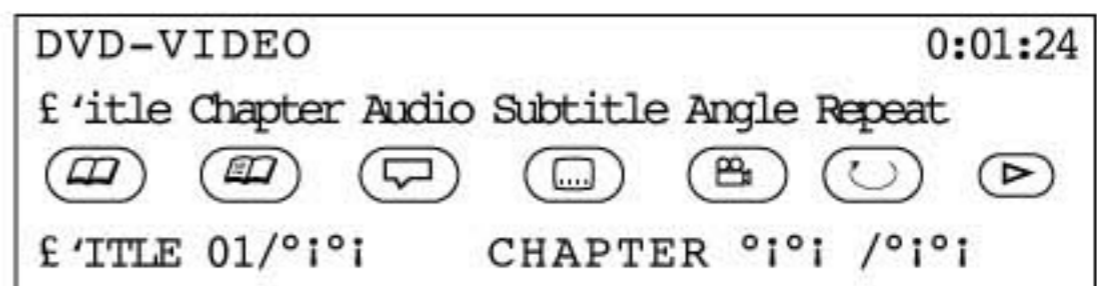

◦ Select a Title

Some discs contain more than one title. For example, there might be four movies on one disc (each movie might be considered a title). Each title is divided into chapters. To select a title:

1. While the disc is playing, press **OSD** on the remote to bring up the Display.
2. If the Title icon on the Display isn't highlighted, use the **◀** or **▶** buttons to highlight it.
3. Press the **▲** or **▼** buttons to go to the next or previous title.

Note: Some discs only have one title.

◦ Select a Chapter

Because DVD discs use digital technology, a title can be divided into individual chapters (similar to tracks on a CD). You can skip to a specific chapter by using the Chapter feature in the Display.

1. While the disc is playing, press **OSD** on the remote to bring up the Display.

J. BASIC OPERATIONS

2. Press the ◀ or ▶ buttons to highlight the Chapter icon.
3. Press the ▲ or ▼ buttons to go to the next or previous chapter.

Notes: The chapter feature won't work if the disc isn't formatted with separate chapters. You can also advance to the next chapter by pressing ▶▶| on the remote and go to the preceding chapter by pressing |◀◀ on the remote.

◦^ Changing the Audio Language

If the disc was created with different language tracks (recorded in different languages), you can use the Display to temporarily change the DVD player's Audio Language setting.

1. While the disc is playing, press **OSD** on the remote to bring up the Display.
2. Press the ◀ or ▶ buttons to highlight the Audio icon. The current audio language appears in the text box below the row of icons.
3. Press the ▲ or ▼ buttons to scroll through the audio languages that are available on the disc until the audio language you want to use appears in the text box. Audio will be played in that language.
4. To make the Display disappear, press the **OSD** button on the remote.

Note: The language feature only works if the disc was created with multiple audio tracks. When you choose an audio language from the Display, you only override the audio language setting in the DVD player's main menu temporarily.

The audio language can also be changed through the DVD player menu.

◦^ Selecting the Subtitle Language

If the disc was created with subtitles, you can use the Display to change the Subtitle language.

1. When the disc is playing, press **OSD** on the remote to bring up the Display.
2. Press the ◀ or ▶ buttons to highlight the Subtitle icon.
3. Press the ▲ or ▼ buttons to scroll through the subtitle languages that are available on the disc until the subtitle language you want to use appears in the text box. The subtitles will be shown in that language.
4. To make the Display disappear, press the **OSD** button on the remote.

Notes: Changing the subtitle language with the Display will only affect the disc currently being played. When the disc is removed or the player is turned off, the subtitle language will revert to the language setting specified through the DVD player main menu.

The subtitle language can also be changed through the DVD player menu.

◦^ Changing the Camera Angle

Some discs contain multiple angles of a particular scene or sequence. If the disc only has one angle, this feature won't work. When multiple angles are available, to change the camera angle:

1. When a disc is playing, press **OSD** on the remote to bring up the Display.
2. The Angle icon will display the number of angles available. For example, if there are 3 different angles, the icon will read 1 of 3. This means angle 1 is currently being played.
3. Press the ▲ or ▼ buttons to scroll through the angle choices. The angle number displayed in the text window is automatically shown.
4. To make the Display disappear, press the **OSD** button on the remote.

◦^ Using the Repeat Feature

The default mode for the Repeat feature is off. There are three Repeat options:

J. BASIC OPERATIONS

- °§ All-repeats the disc that is playing
- °§ Title-repeats the title that is playing
- °§ Chapter-repeats the chapter that is playing

To Use Repeat:

1. While a disc is playing, press **OSD** on the remote to bring up the Display.
2. Highlight the Repeat icon.
3. Press the **▲** or **▼** buttons to scroll through the Repeat options until the Repeat option you want is displayed in the text box.
4. The selected repeat option will loop repeatedly until you turn Repeat off.

How to Cancel Repeat:

There are three ways to cancel Repeat:

- °§ Press STOP twice.
- °§ Go to Repeat icon in the Display and select Off.
- °§ Eject the disc.

WHEN PLAYING CD

CD discs have the following playback features: Track, L/R, Audio (not available) and Repeat.

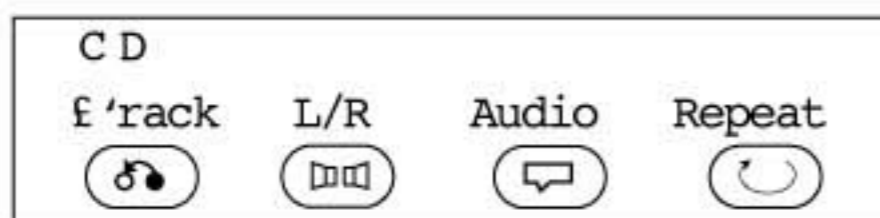

°^ Select a Specific Track

1. While the disc is playing, press **OSD** on the remote to bring up the Display.
2. Highlight the Track icon.
3. Press the **▲** or **▼** buttons to scroll through the track numbers.

°^ Changing the Audio Channel Output

If you are playing a Stereo CD, you can change the channel output from the player.

1. Press **OSD** on the remote to bring up the Display.
2. Highlight the L/R icon on the Display.
3. The audio channel choices appear in the text box. Press the **▲** or **▼** buttons to scroll through the choices: LEFT MONO, RIGHT MONO, MIXED MONO or STEREO.

Whatever choice is displayed becomes the active choice.

°^ Using the Repeat Feature

The default mode for the Repeat feature is off. There are two Repeat options for CDs:

- °§ All-repeats the disc that is playing
- °§ Track-repeats the track that is playing

To Use Repeat:

1. While a disc is playing, press **OSD** on the remote to bring up the Display.
2. Highlight the Repeat icon.
3. Press the **▲** or **▼** buttons to scroll through the Repeat options until the Repeat option you want is displayed in the text box.
4. The selected repeat option will loop repeatedly until you turn Repeat off.

J. BASIC OPERATIONS

DVD MENU PLAY

some DVDs have title menus and chapter menus.

Press ►(PLAY), the screen shows the menu.

Press ►► or ◀◀ to skip the next or previous page, select with number buttons or direction buttons.

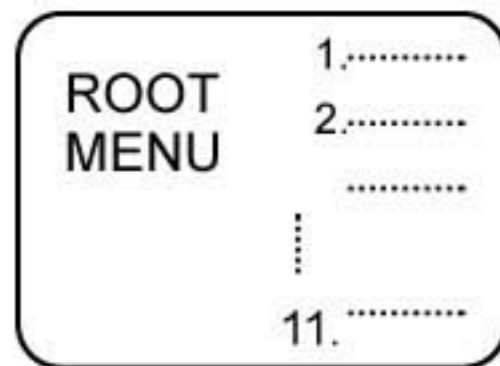

Example: select track 13.

1. Press ►► to enter the next menu.

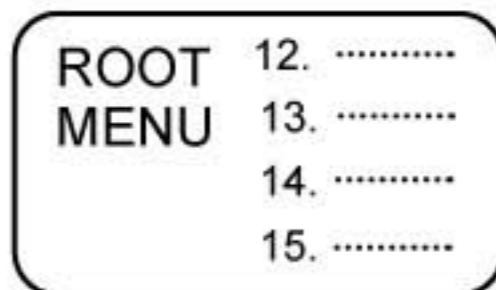

2. Press ▼ to select track 13.

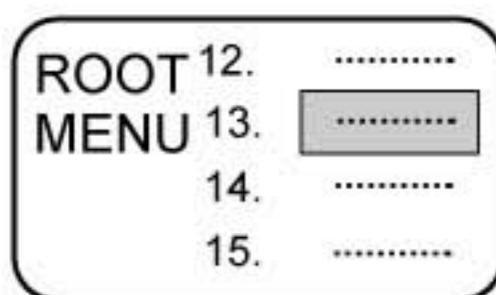

3. Press ► (PLAY) to start playing track 13.

Press **TITLE** once to return to the title menu.

Press **MENU** once to return to the root menu.

AUDIO/VIDEO IN

The unit can supply an auxiliary (AUX) signal to external equipment.

1. Connect the equipment and the unit with A/V cables, the AUDIO OUT of the external equipment is connected to the AUDIO jack on the front panel of the unit, the VIDEO OUT of the external equipment is connected to the VIDEO jack of the unit.
2. Turn on the external equipment and the unit.
3. Select input function by pressing the POWER button on the remote control.
4. The signals are routed through the Video output jack and the Audio output jack of the DVD unit.

K. FUNCTION SETTING

MENU SETTING



According to the recorded information and external equipment, set the following functions for the player to obtain the best playing status.

1. Press **SETUP** to set the main menu.

SETUP



The screen shows:

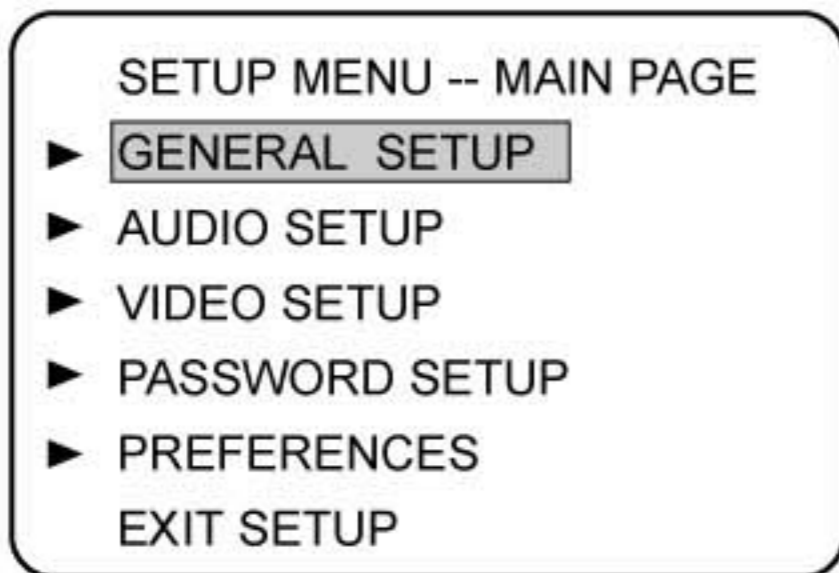

2. Press direction buttons (▶, ▲) to select and press ▶ (PLAY) to confirm.

Example: Select "AUDIO SETUP"

◦ Press direction button ▼ to select.

The screen shows:

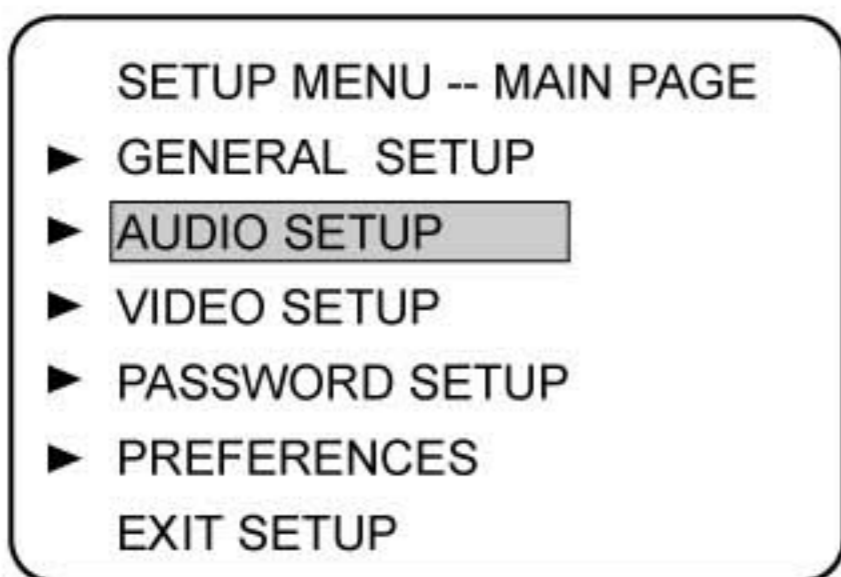

◦ Press ▶ (PLAY) to confirm and enter "AUDIO SETUP". The screen shows the submenu for you selection.

The screen shows:

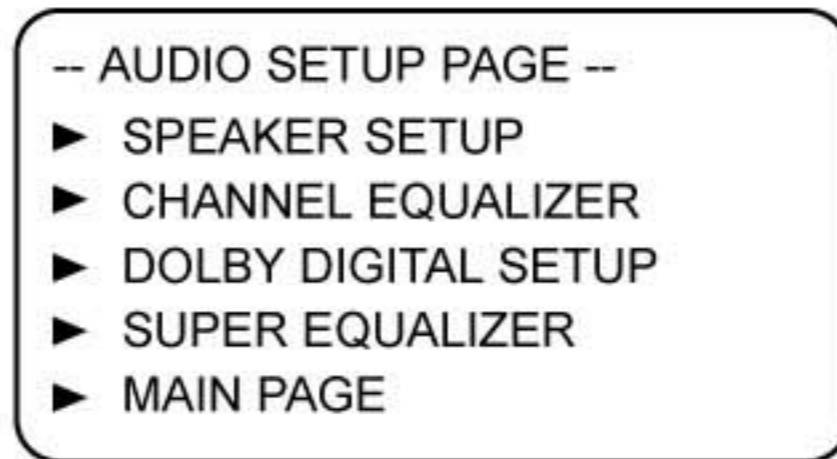

◦ Press the ▼ button and ▶ (PLAY) to confirm and enter "DOLBY DIGITAL SETUP". The screen shows the submenu for your selection.

The screen shows:

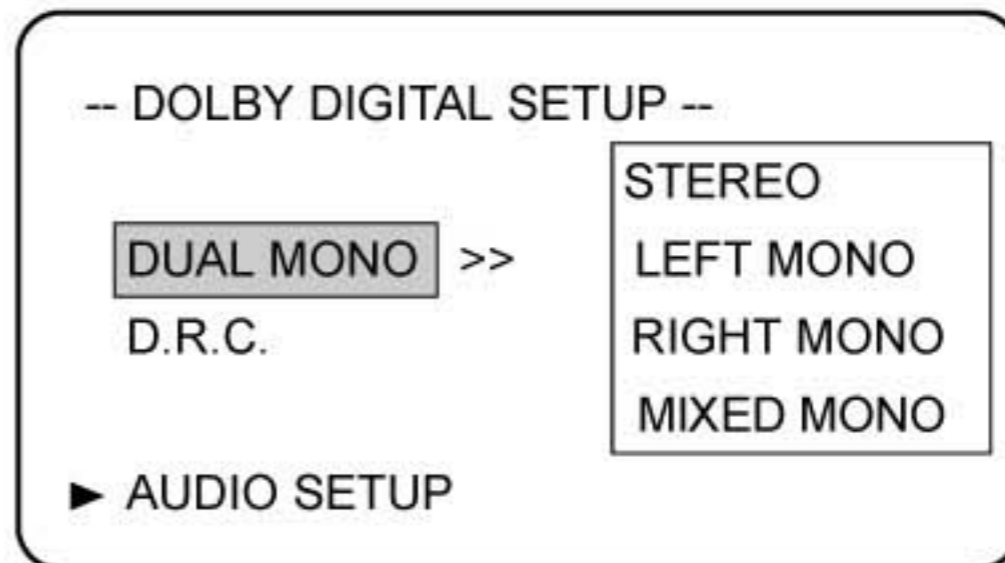

Press direction button ▶ & ▼ to select "LEFT MONO"

The screen shows:

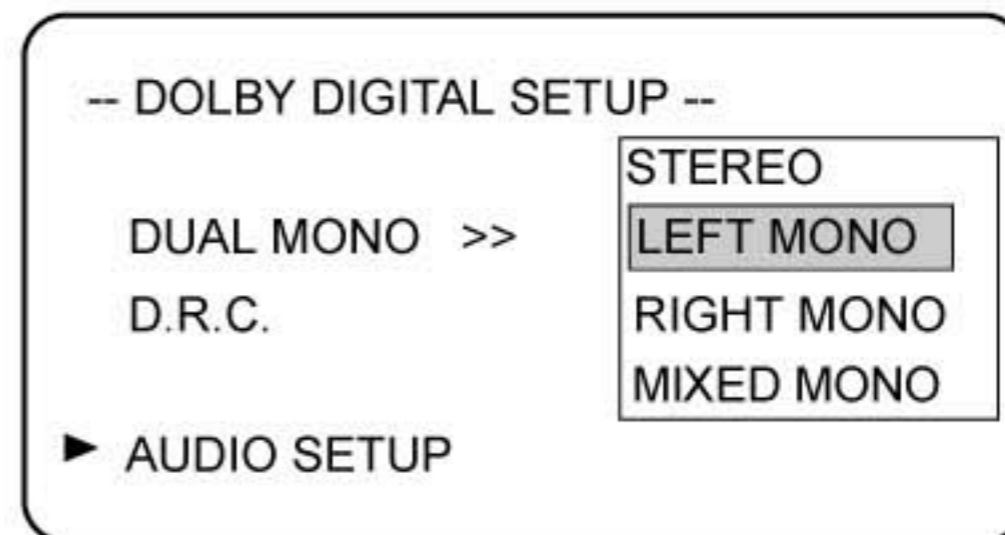

◦ Press ▶ (PLAY) to confirm selection.



Set "DUAL MONO" in "DOLBY DIGITAL SETUP" to "LEFT MONO".

K. FUNCTION SETTING

3. Exit from menus.

Press direction buttons and ► (PLAY) to select the relevant exit column.

- Press the direction buttons ▲ ◦ ◂ to exit from "DUAL MONO".
- Press the direction button ▼ to select "AUDIO SETUP", press ► (PLAY) to exit from the current column and return to the "AUDIO SETUP PAGE".
- Press ▲, ▼ to select "MAIN PAGE", then press ► (PLAY) to return to the main menu.

GENERAL SETUP

The setting structure is as follows:

--GENERAL SETUP PAGE--

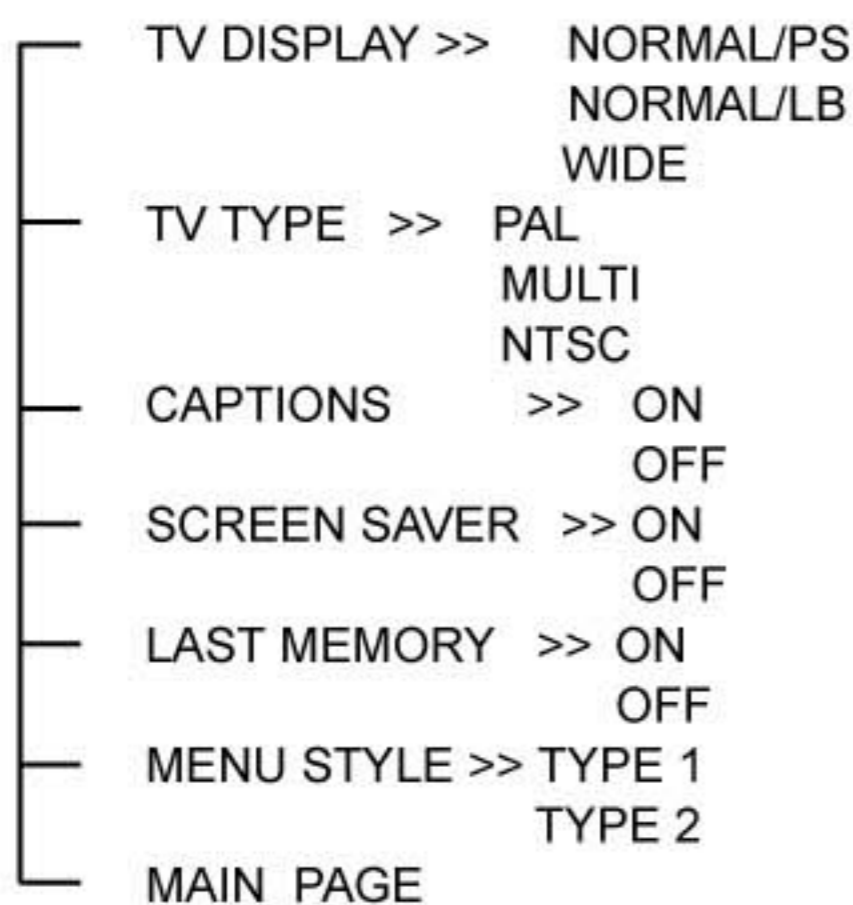

◦^ TV DISPLAY

1. NORMAL/PS

This is selected when the unit is connected to a normal TV.

Wide-screen images are shown on the screen, but with some parts cut automatically.



2. NORMAL/LB

This is selected when the unit is connected to a normal TV. Wide-screen images are shown on the screen, with black belt on the top and bottom.



3. WIDE

This is selected when the unit is connected to a wide-screen TV.



◦^ TV TYPE

You may select according to the color system of the TV to be connected.

- Select "MULTI" for a multi-system TV.
- Select "NTSC" for an NTSC TV.
- Select "PAL" for a PAL TV.

K. FUNCTION SETTING

◦^ CAPTIONS

◦ ON

The hidden subtitle is shown.

◦ OFF

The hidden subtitle is turned off.

◦^ SCREEN SAVER

Start the screen saver, the screen saver image appears when the unit stops or the image is frozen for a few minutes. This saver can keep the screen from being damaged.

◦ ON: Start the screen saver.

◦ OFF: Remove the screen saver.

◦^ LAST MEMORY

The unit can memory the point of a disc where the power is off and play from the point when you turn on the unit again.

◦ ON: This function is on and works.

◦ OFF: This function is off and does not work.

◦^ MENU STYLE

The menu has two types of styles (type 1 and type 2).

You can select one type which you prefer.

AUDIO SETUP

The setting structure is:

--AUDIO SETUP PAGE --

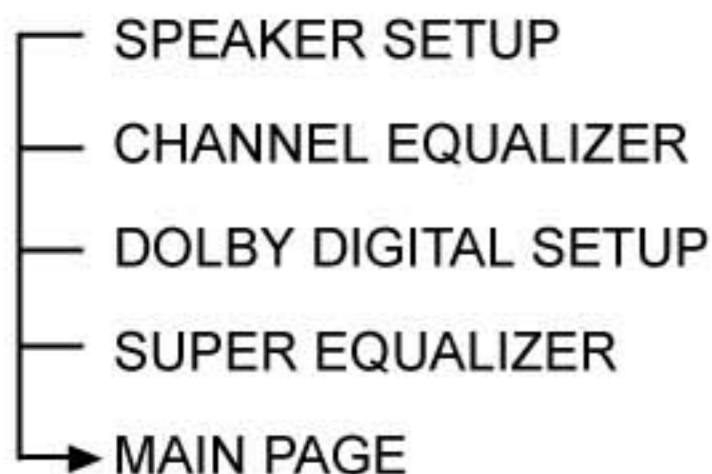

◦^ SPEAKER SETUP

The setting structure is:

-- SPEAKER SETUP PAGE --



◦ LT/RT

A disc recorded multi channel soundtrack, the output signal will be incorporated to left and right channel.

◦ STEREO

A disc recorded multi channel soundtrack, the output signal will be incorporated to stereo.

◦^ CHANNEL EQUALIZER

This option will help you to select graphic equalizer patterns according to the genre of the music being played.

The setting structure is:

--CHANNEL EQUALIZER--

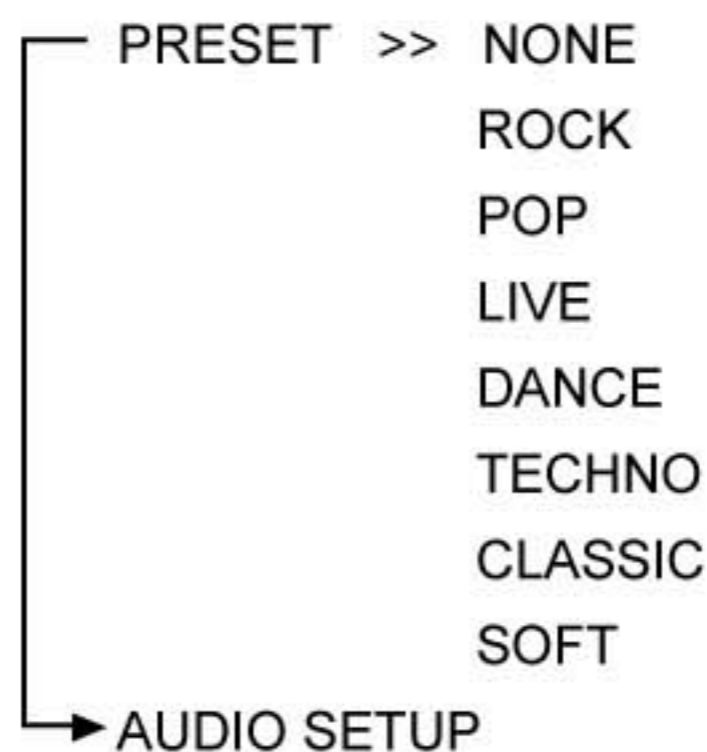

You can select music category by pressing the direction buttons and confirm by pressing the **PLAY** button.

K. FUNCTION SETTING

°^ DOLBY DIGITAL SETUP

The setting structure is:

--DOLBY DIGITAL SETUP --

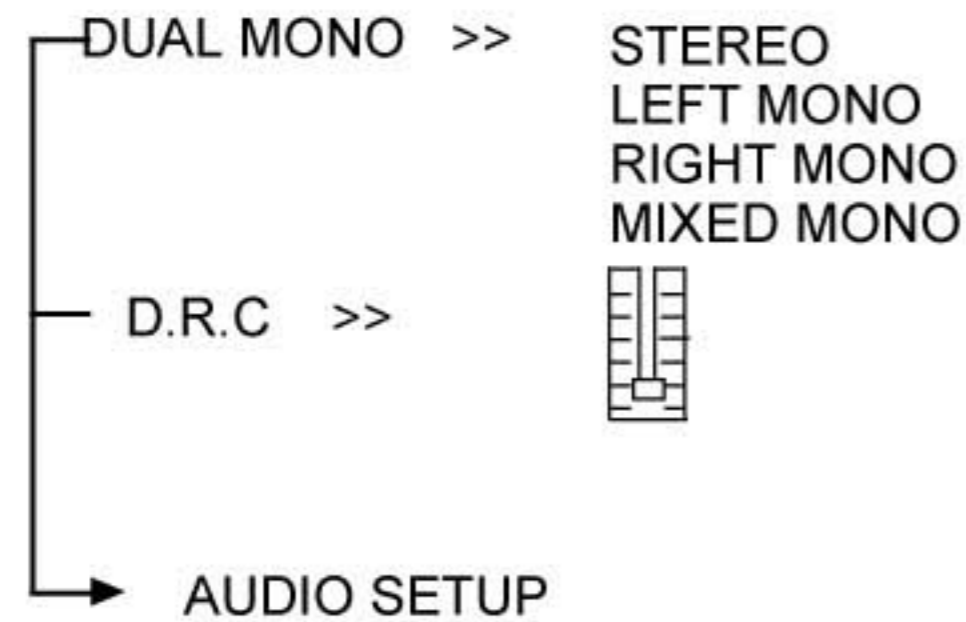

° DUAL MONO

This is the output mode of the L and R signals of the set audio output. If it is set to "MIXED MONO", the function only works when the DVD being played is 5.1-channel.

° D.R.C

This is selected to adjust linear compression rate to obtain the different compression results of the signals.

°^ SUPER EQUALIZER

This option will help you to adjust the bass equalizer.

The setting structure is:

--SUPER EQUALIZER PAGE--



° BASS BOOST

Uses to turn BASS BOOST on and off.

° SUPER BASS

Uses to turn SUPER BASS on and off.

° CLEAR BOOST

Uses to turn CLEAR BOOST on and off.

VIDEO SETUP

The setting structure is:

--VIDEO SETUP PAGE--



°^ SHARPNESS

Uses to select the sharpness level.

° HIGH

The sharpness level is highest.

° MEDIUM

The sharpness level is medium.

° LOW

The sharpness level is lowest.

°^ BRIGHTNESS

You can use the ▲ or ▼ button to adjust the brightness.

°^ CONTRAST

You can use the ▲ or ▼ button to adjust the contrast.

K. FUNCTION SETTING

PASSWORD SETUP

The setting structure is :

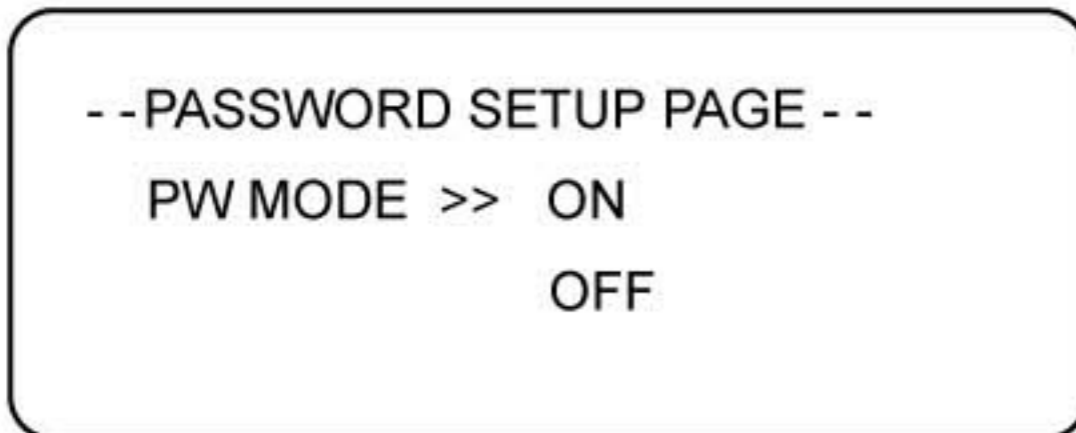

- ^ PASSWORD MODE
- ON: The password works, "PARENTAL" is dim and can not be selected.
- OFF: The password is locked, "PARENTAL" can be selected.

Enter a password according to the screen.

Note: The factory set password is: ►►|, ►►| ... (press the ►►| button 5 times).

PREFERENCES

The setting structure is :

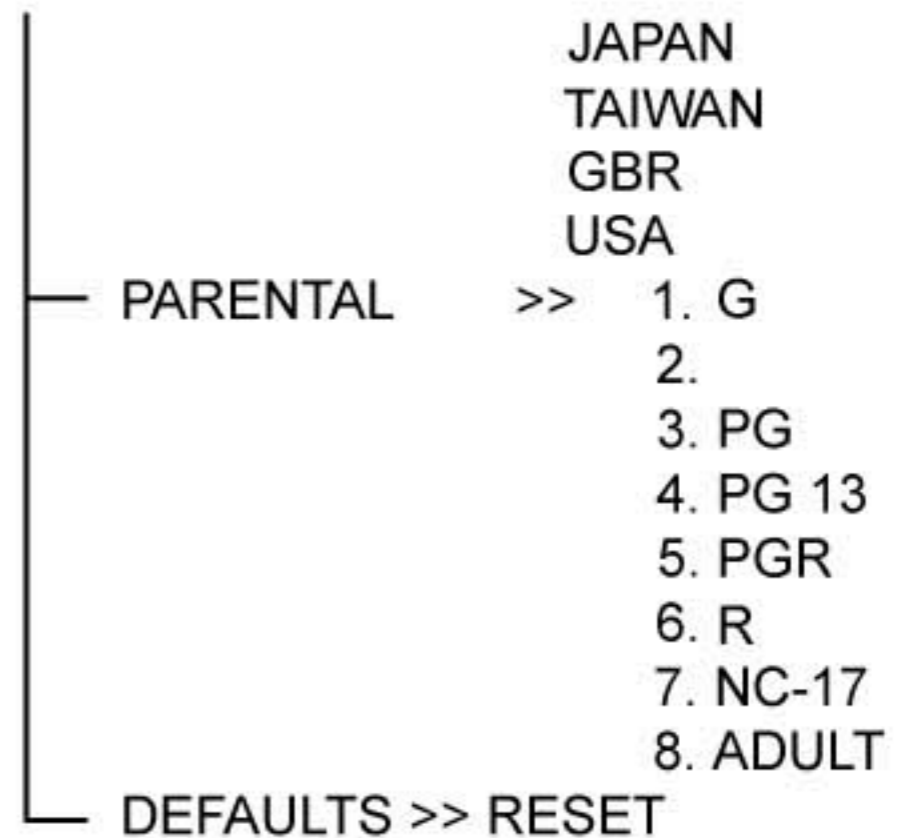
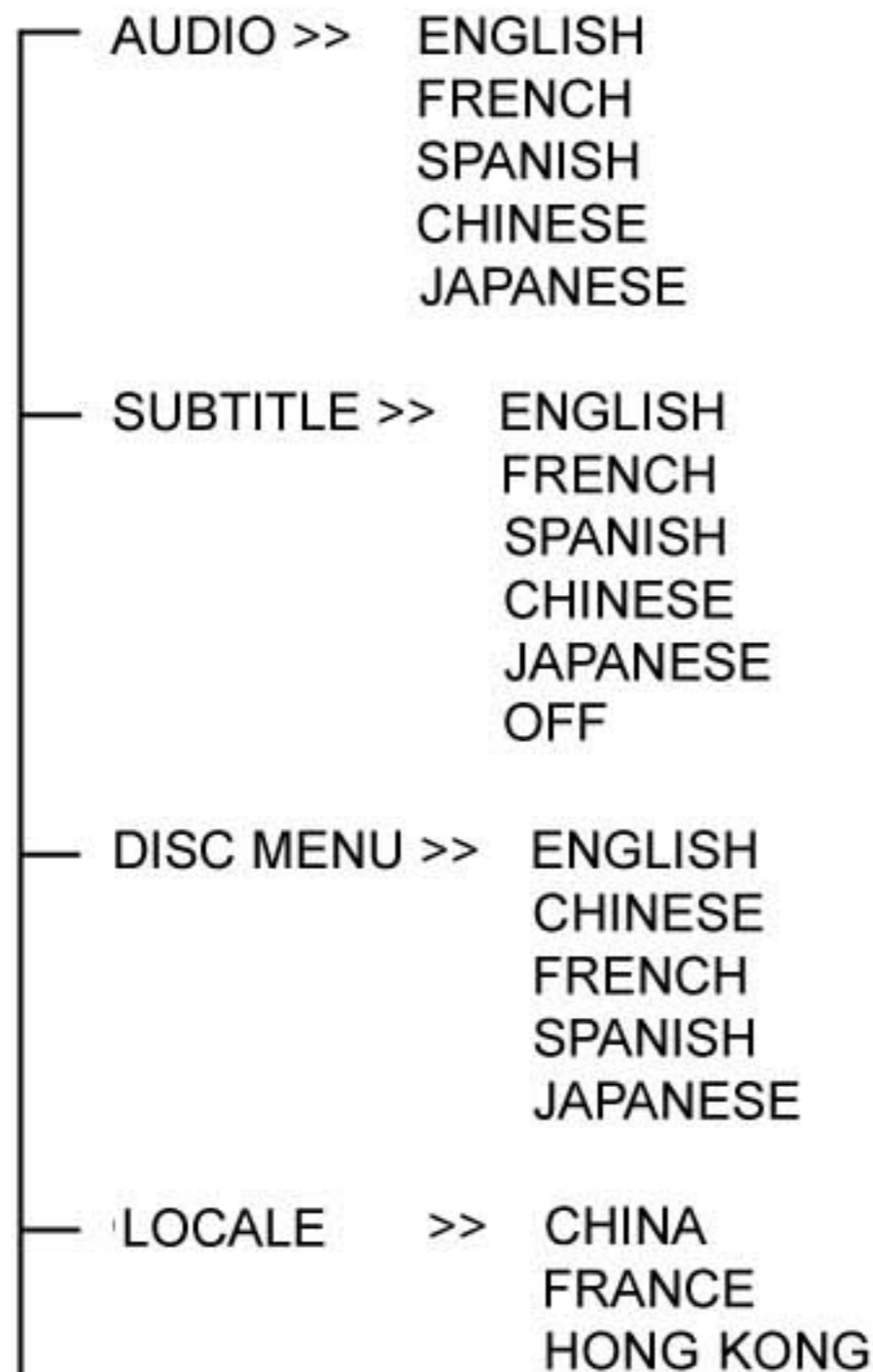

◦^ LANGUAGE SELECTION

If a language mentioned above is recorded on the disc, you can select sounds, subtitles or disc menu languages. If not, the language recorded on the disc is shown.

◦^ PARENTAL LOCK

When playing disc with parental lock function, you may select an age control grade according to rating of disc and your preference.

Example: Select "PG" , you cannot play DVD video disc rated higher than the PG grade.

◦^ DEFAULT >> RESET

Each function setting returns to the initial status in the factory if you select this option.

Note:

- "PREFERENCES" only can be selected after the unit goes into stop mode.

L. PLAY DISCS IN VARIOUS WAYS

AUDIO MODE



- You may select a needed language from a multi-language DVD .
- You may select the right channel or left channel or stereo from a multi-channel CD.

WHEN PLAYING DVD

- Press LANGUAGE, the screen shows orderly:

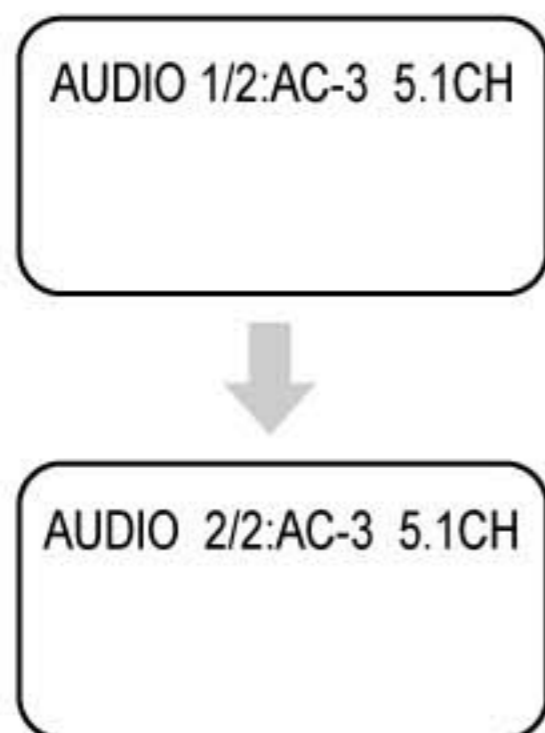

Different discs differ in languages.

- Press **MODE**, the screen shows orderly:

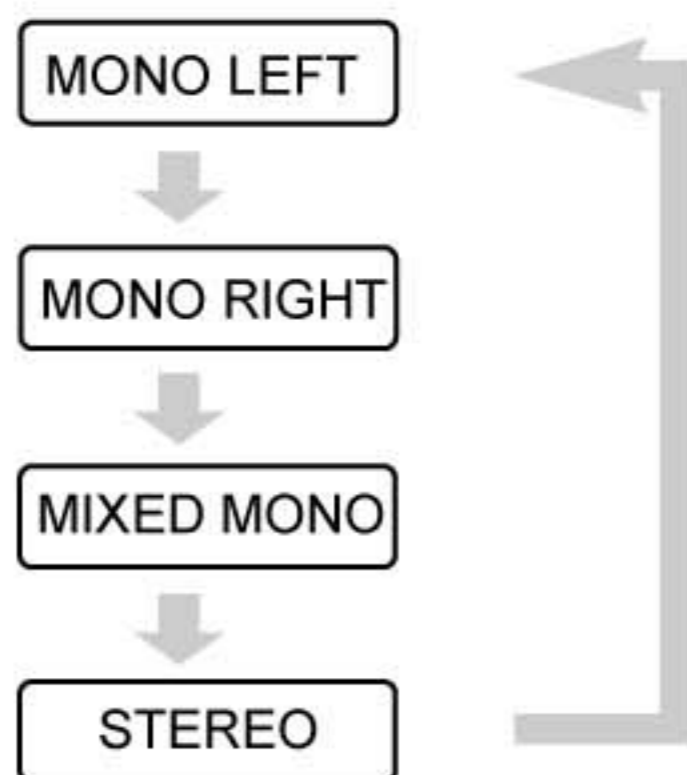

WHEN PLAYING CD

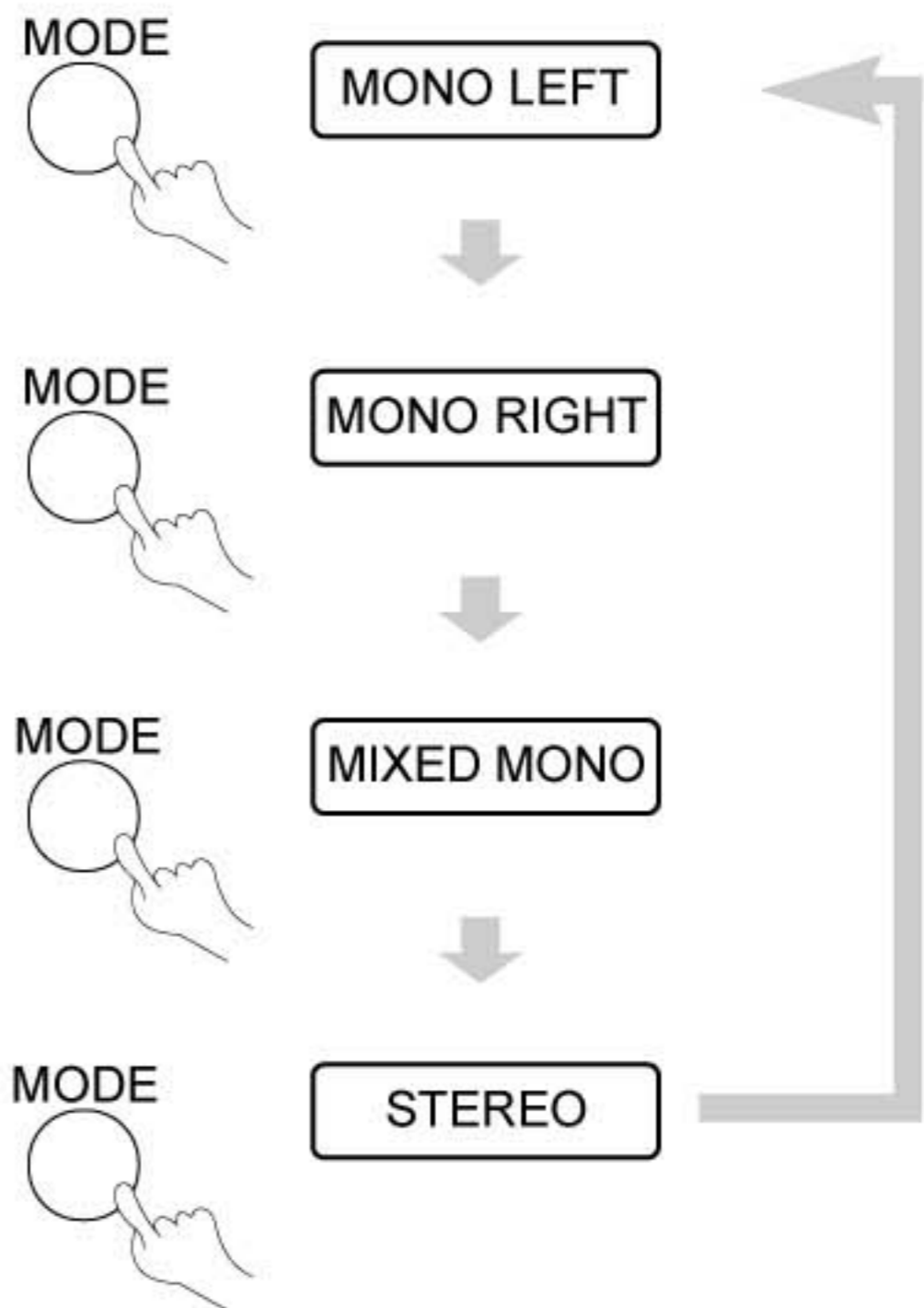

You may select one mode.

Notes:

- Different discs differ in languages.

MUTE



When playing a disc, this function can remove the sound.

1. REMOVE SOUND

Press **MUTE**, the screen shows "MUTE".

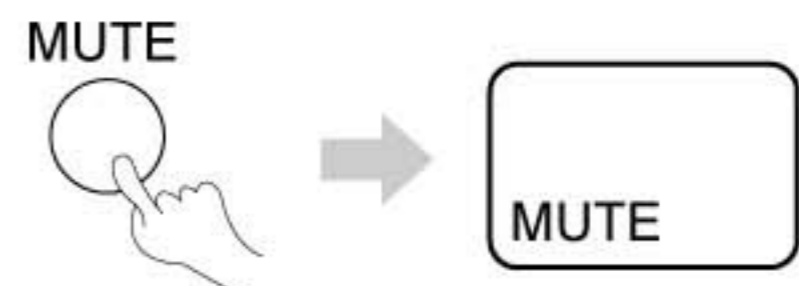

2. RESUME SOUND

Press **MUTE** again, the screen shows "MUTE OFF".

L. PLAY DISCS IN VARIOUS WAYS

FAST PLAY



When playing a disc, you may play it forward fast or reverse it fast to find what you want.

WHEN PLAYING DVD OR CD

1. Press ►► to play forward fast. Each time you press the button, the screen shows orderly:

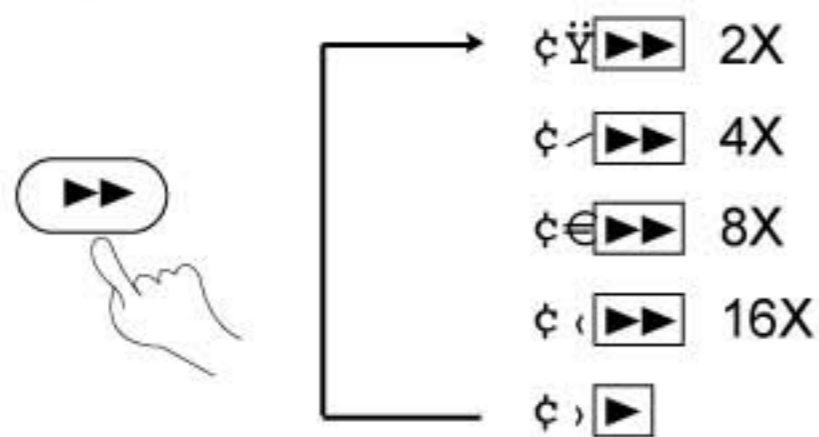

2. Press ◀◀ to reverse the disc fast. Each time you press the button, the screen shows orderly:

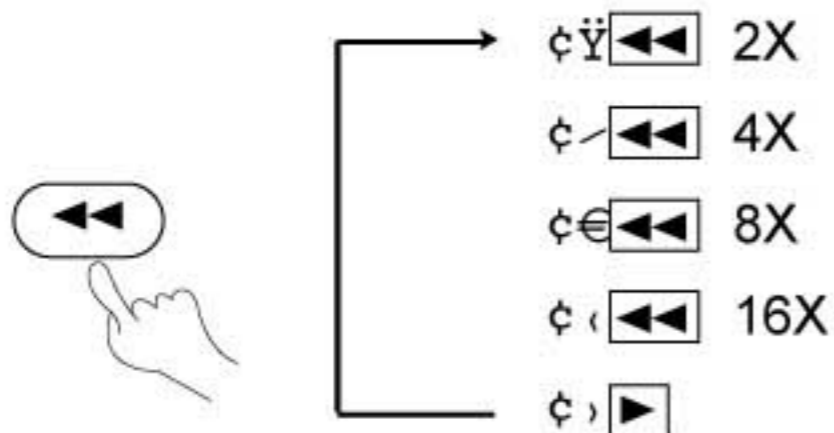

3. Press ► (PLAY) to switch to normal play while FF or FR playing.

SLOW PLAY



Enjoy slow motions by the following steps.

WHEN PLAYING DVD

1. Press SLOW to play slowly.



The screen shows orderly:

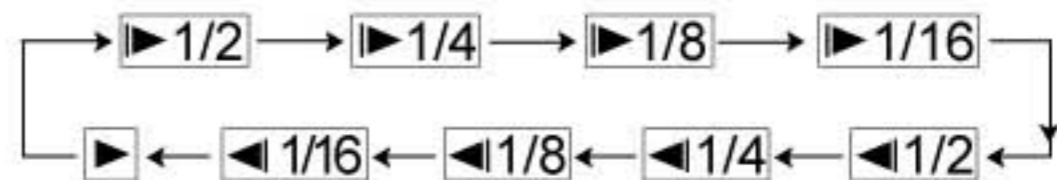

2. Press ► (PLAY) to play normally.

L. PLAY DISCS IN VARIOUS WAYS

REPEAT PLAY



This function can be used to repeatedly play a title, chapter, track, disc, or some part on a disc.

PLAYING A DISC REPEATEDLY

°^ DVD

You may repeat a title or chapter.

1. Repeat a chapter.

Press **REPEAT**, the screen will show

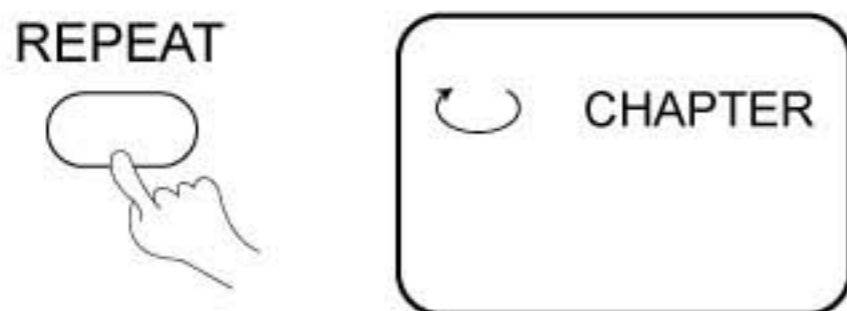

2. Repeat a title

Press **REPEAT** twice, the screen will show

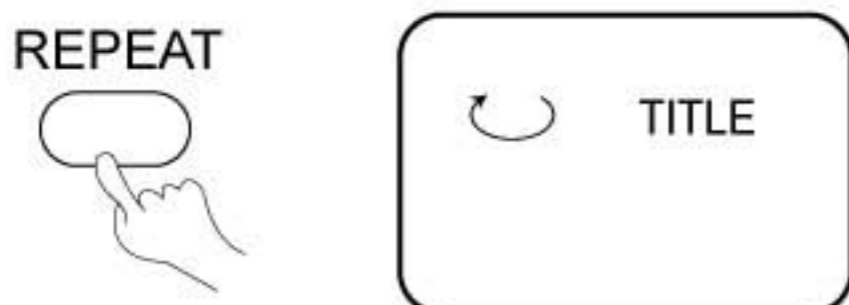

3. Repeat all.

Press **REPEAT** third time, the screen shows "⌚ ALL".

4. Remove "REPEAT" function.

Press **REPEAT** until "⌚ ALL" disappears.

°^ CD

° You may repeat a track, a disc according to the following steps.

1. Repeat a track.

Press **REPEAT**, the screen shows "⌚ TRACK". The unit plays the current track.

REPEAT

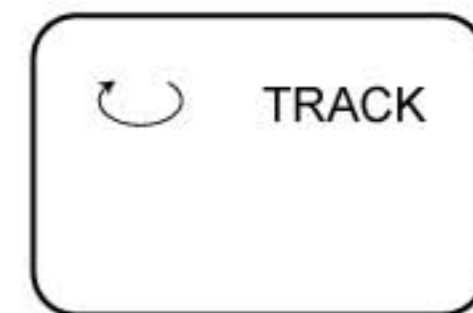

2. Repeat a disc.

Press **REPEAT**, the screen shows "⌚ ALL". The unit plays all the tracks on the disc.

REPEAT

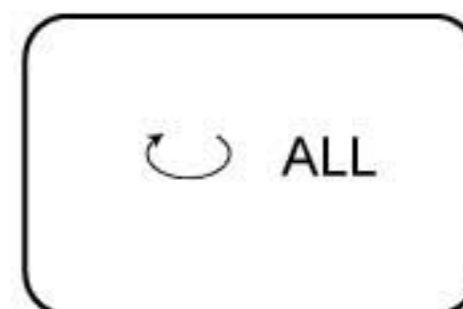

3. Remove "REPEAT" function.

Press **REPEAT** till "⌚ ALL" disappears.

REPEAT SOME PARTS

You may press **A-B** to enjoy some parts repeatedly when playing a disc.

°^ PLAY DVD or CD.

1. Set a starting point A.

The screen shows:



2. Set an end point B.

The screen shows:



Afterwards, the unit plays from A to B.

3. Press **A-B** again till "⌚ AB" disappears.

L. PLAY DISCS IN VARIOUS WAYS

SELECT SUBTITLES



This operation works only with discs on which multiple subtitle language are recorded.

PLAY DVD

1. Press **SUBTITLE** repeatedly until the desired language is selected.

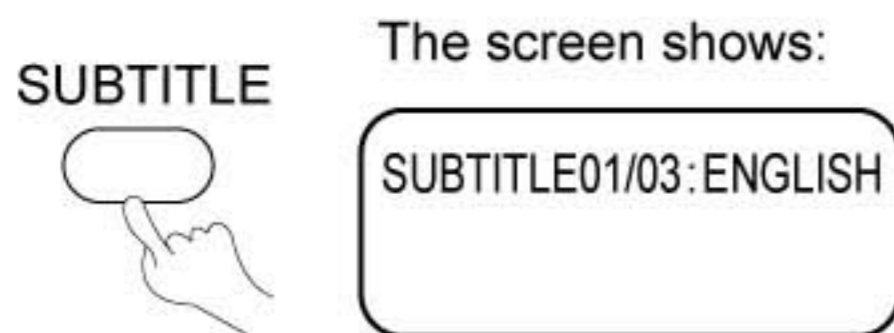

2. Remove the subtitle.

Press **SUBTITLE** until the screen shows "TURN OFF SUBTITLES".

Notes:

- For some discs, subtitles can not be removed.
- Different discs differ in the language of subtitles.
- If the subtitles of discs can not be selected, press **SUBTITLE**, the screen shows "NO SUBTITLE".

ANGLES SELECT



Some discs have images with different viewing angles, you may select among them. For example, when you watch a running train, you may watch it from the front, the left window or the right window without stopping it.

Example:

A DVD has four viewing angles at your option.

1. Press  to select ANGLE1.

SCREEN



2. Press  to select other angles, the screen shows respectively:

 2/4 (select ANGLE2)

 3/4 (select ANGLE3)

 4/4 (select ANGLE4)

3. To resume normal playback, press  to select original angle.

L. PLAY DISCS IN VARIOUS WAYS M. MP3 OPERATION

ZOOM PLAY



This function can be used to watch a motion or motionless picture.

1. Press **ZOOM** during playback, the screen shows:



The picture is enlarged twice the size.

2. Press **ZOOM** again, the screen shows:



The picture is enlarged three times the size.

Note: The unit has six zoom steps:

2X, 3X, 4X, 1/2, 1/3, and

1/4.

3. Push **◀**, **▲**, **▼**, **▶** to move the enlarged picture.
4. To resume the picture, push **ZOOM** until the picture is in normal size.

SELECT TRACKS WITH MENU

1. Insert a disc, the unit will search disc information. The TV screen displays main menu.

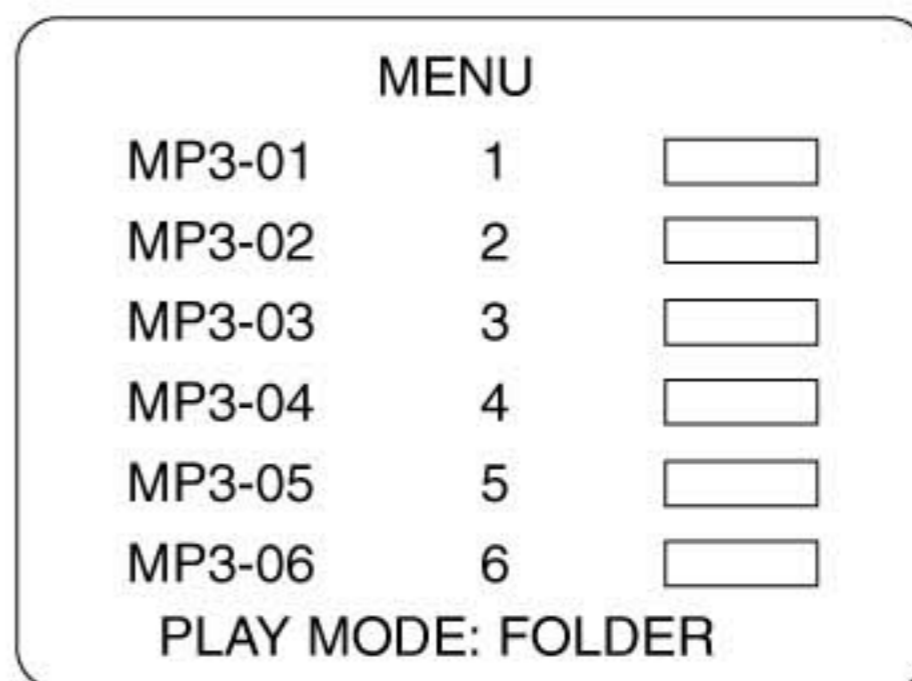

2. Press direction key **▼** to select song folder. Press **▶** (PLAY) to confirm selection. Example: Select MP3-02, the TV screen displays.



3. Press direction buttons to select a song. Press **▶** (PLAY) button to start playback.
4. Press **▲** or **▼** button to select other tracks in stop mode.
5. In stop mode, select the folder icon (UP DIR 1) on the left side, then press **▶** (PLAY) button to return to the main menu.
6. Press **▶▶** or **◀◀** to play previous or next songs.

OTHER FUNCTIONS

During playback MP3 discs, the unit features mute, volume control, repeat play (FOLDER, REP-ONE, FOLDER REPEAT).

N. OTHERS

TROUBLE SHOOTING

If you experience the following problems while using the unit, this troubleshooting guide can help you.

No sound

- Check if the unit is connected securely.
- Make sure you operate the TV/monitor or amplifier correctly.
- Make sure the amplifier is set to receive DVD signal output.

No image

- Check if the unit is connected securely.
- Make sure you operate the TV/monitor correctly.
- Make sure you set the color system correctly.

Bad sound quality

- Make sure the audio output mode is set correctly.
- Make sure the audio connection between the unit and amplifier is right.

Disc can not be played

- There is no disc in the unit.
- Put the disc on the disc tray properly with the label side up.
- Clean the disc.
- Moisture has condensed in the unit. Remove the disc and leave the unit on for about one hour.
- DVD may be wrong region.

The unit doesn't operate normally

- Disconnect the power plug and insert it into the wall outlet again.

Remote control does not work

- Remove barriers between the remote control and the unit.
- Point the remote control at the remote control sensor of the unit.
- Replace the batteries with new ones.

N. OTHERS

TECHNICAL SPECIFICATIONS

Laser	wavelength 650nm	
Video system	NTSC/PAL /MULTI	
Frequency response	30Hz ~ 20KHz \pm 2dB	
Signal/noise ratio	\geq 85dB	
Audio distortion + noise	\leq - 70dB (1KHz)	
Channel separation	\geq 85dB (1KHz)	
Dynamic range	\geq 80dB (1KHz)	
Output	Audio out (analog audio)	output level: $2 \begin{matrix} +0 \\ -1 \end{matrix} V$ Load impedance: 10K
	Video out	output level: $1 \pm 0.2V$ Load impedance: 75
Power supply	DC12V , 1.5A	
Environment temperature	5~35 $^{\circ}E$	
Power consumption	\leq 20W	
Dimensions	200 $^{\circ}$ i 260 $^{\circ}$ i 78mm	
Weight	Approx. 2Kgs	

This manual is only for your reference, any change to the design and specifications will not be advised.

O. INSTALLATION

INSTALLATION GUIDE

◦ Impending installation

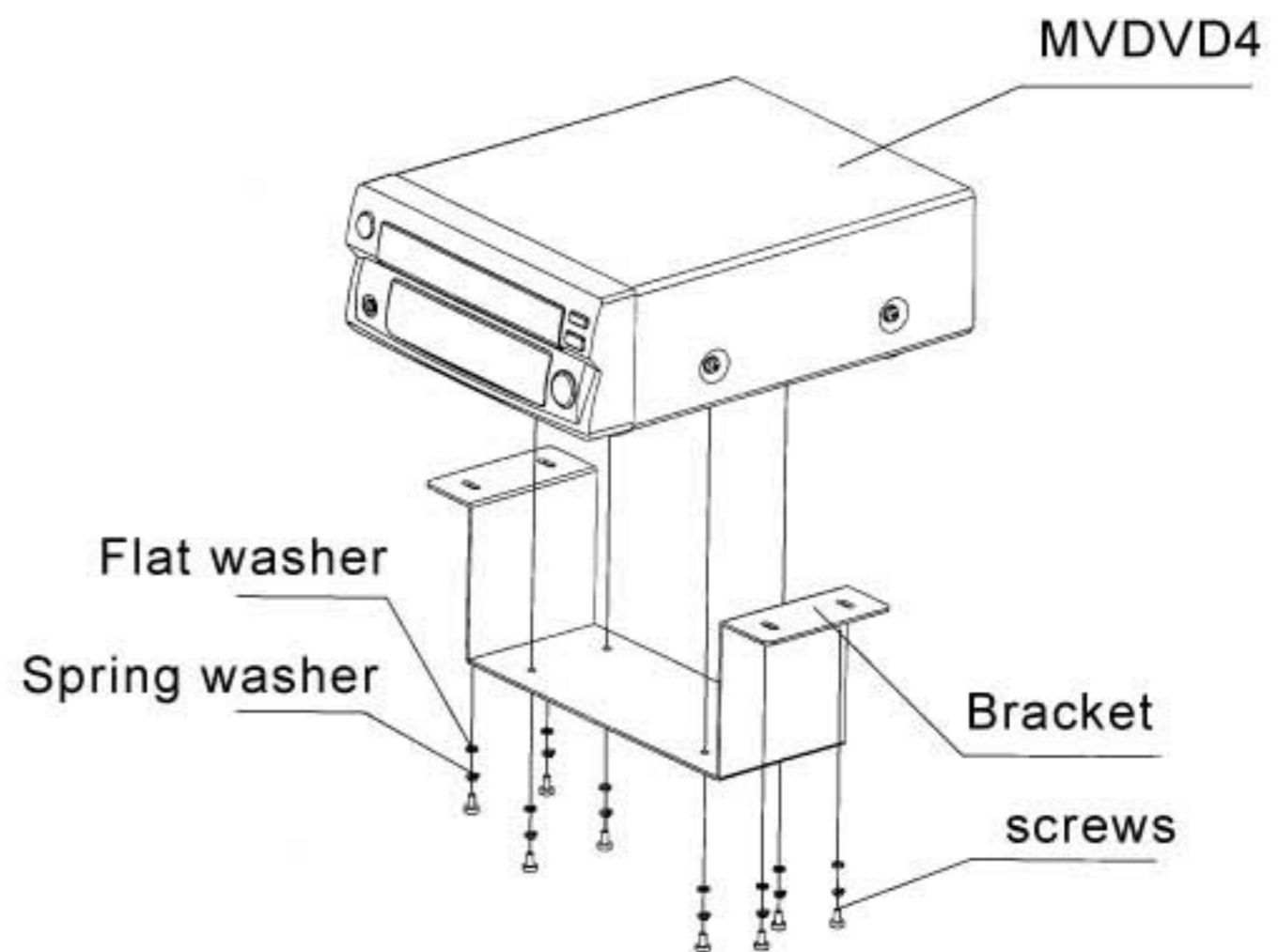

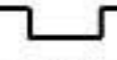
1. Fix the  bracket to the unit with screws.
2. Fix the unit to the car through mounting holes.

◦ Horizontal placement

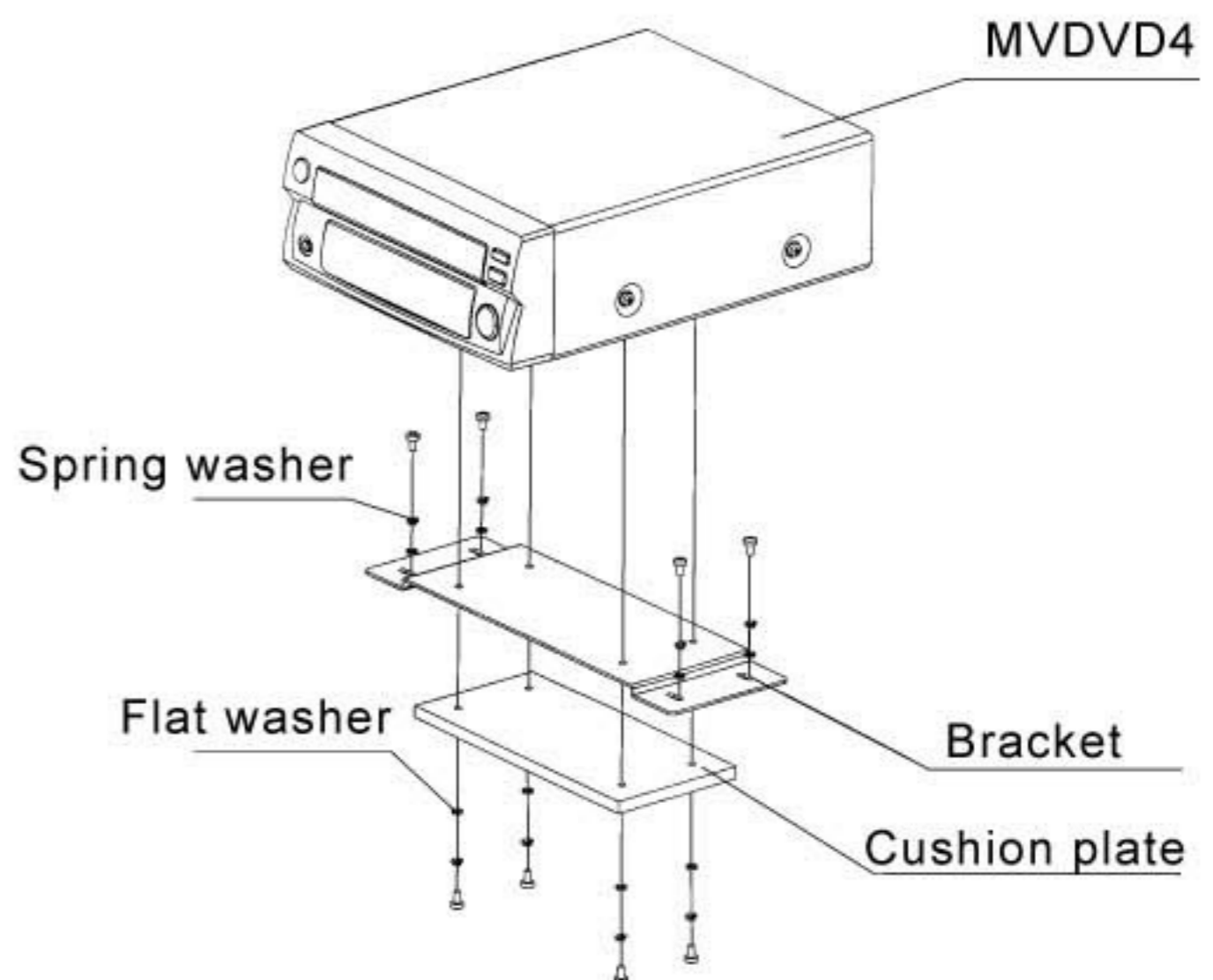

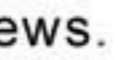
1. Fix the  bracket to the unit with screws.
2. Fix the unit to the car through mounting holes.

Note: Please remove the disc when the unit is not in use.

Free Manuals Download Website

<http://myh66.com>

<http://usermanuals.us>

<http://www.somanuals.com>

<http://www.4manuals.cc>

<http://www.manual-lib.com>

<http://www.404manual.com>

<http://www.luxmanual.com>

<http://aubethermostatmanual.com>

Golf course search by state

<http://golfingnear.com>

Email search by domain

<http://emailbydomain.com>

Auto manuals search

<http://auto.somanuals.com>

TV manuals search

<http://tv.somanuals.com>