

DVD

DVD

DVD

DVD

DVD MICRO SYSTEM



CD-R/RW

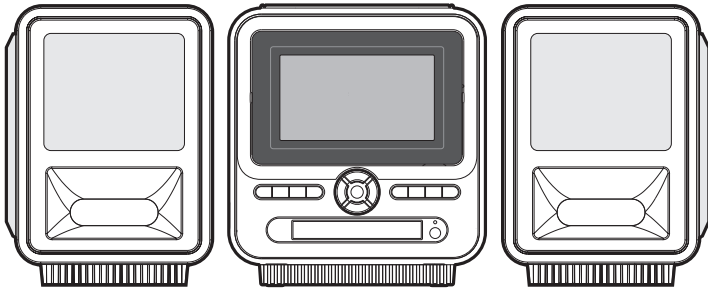

OWNER'S MANUAL

DVD

DVD

DVD

DVD

SAFETY PRECAUTIONS

The following mark and symbols are located on the bottom of the unit.



The lightning flash with an arrowhead symbol, within the equilateral triangle, is intended to alert the user to the presence of uninsulated "dangerous voltage" within the product's enclosure that may be of sufficient magnitude to cause an electric shock.



The exclamation point within the equilateral triangle is intended to alert the user to the presence of important operating and maintenance (servicing) instructions in this owner manual.

WARNING: TO REDUCE THE RISK OF ELECTRIC SHOCK, DO NOT REMOVE COVER (OR BACK). NO USER-SERVICEABLE PARTS INSIDE. REFER SERVICING TO QUALIFIED SERVICE PERSONNEL.

WARNING: TO PREVENT FIRE OR SHOCK HAZARD, DO NOT EXPOSE THIS APPLIANCE TO RAIN OR MOISTURE.

CAUTION: TO PREVENT ELECTRIC SHOCK, MATCH WIDE BLADE OF PLUG TO WIDE SLOT AND FULLY INSERT.

CAUTION: DANGER OF EXPLOSION IF BATTERY IS INCORRECTLY REPLACED. REPLACE ONLY WITH THE SAME OR EQUIVALENT TYPE.

CAUTION: USE OF ANY CONTROLS, ADJUSTMENTS, OR PROCEDURES OTHER THAN THOSE SPECIFIED HEREIN MAY RESULT IN HAZARDOUS RADIATION EXPOSURE.

CAUTION: THE APPARATUS SHALL NOT BE EXPOSED TO RAIN, MOISTURE, DRIPPING OR SPLASHING AND THE NO OBJECTS FILLED WITH LIQUIDS, SUCH AS VASES, SHALL BE PLACED ON THE APPARATUS.



This product contains a low power laser device.



The symbol for Class II (Double Insulation)

On Placement

- Do not use the unit in places which are extremely hot, cold, dusty or humid.
- Place the unit on a flat and even surface.
- Do not restrict the air flow of the unit by placing it in a place with poor air flow, by covering it with a cloth, or by placing it on carpet.
- To avoid magnetized. Do not place the unit near speaker or magnet.
- Do not place any naked flame sources, such as lighted candles, on the apparatus.
- Do not use this unit in direct sunlight or leave the unit in a closed automobile (or yacht, etc.) where it would be exposed to high temperatures above 40°C.
- It also should not be placed in temperatures less than 5°C (41°F) or greater than 35°C (95°F).

SAFETY PRECAUTIONS

On Safety

- When connecting and disconnecting the AC cord, grip the plug and not the cord itself. Pulling the cord may damage it and create a hazard.
- When you are not going to use the unit for a long period of time, disconnect the AC power cord.
- When the cord is plugged in, a small amount of current continues to flow to the unit, even when the power is turned off.
- When the AC power cord is connected, the standby indicator will light up.

Notes on Batteries

- When discarding batteries, environmental problems must be considered and local rules or laws governing the disposal of these batteries must be followed strictly.

On AC Voltage

- Before use, check that the rated voltage of your unit matches your local voltage.

FCC Information

This device complies with Part 15 of FCC Rules.

Operation is subject to the following two conditions:

- (1) This device may not cause harmful interference, and
- (2) This device must accept any interference received, including interference that may cause undesirable operation.

On Condensation

- When left in a heated room where it is warm and damp, water droplets or condensation may form inside the unit. When there is condensation inside the unit, the unit may not function normally. Let the unit stand for 1 to 2 hours before turning the power on, or gradually heat the room up and dry the unit before use.

Ventilation Warning

- Do not block the ventilation openings or holes. (If the ventilation openings or holes are blocked by a newspaper or cloth, etc., the heat may not be able to get out.)

Rating Plate Location

- The rating plate location is on the bottom of the unit.



WARNING:

- Should any trouble occur, disconnect the AC power cord and refer servicing to a qualified technician.
- Do not place anything directly on the top of the unit. Damage to the unit can result.

Notes on Copyright

It is forbidden by law to copy, broadcast, show, broadcast on cable, play in public, rent copyrighted material without permission.

Apparatus Claims of U.S. Patent Nos. 4,631,603; 4,577,216; 4,819,098 and 4,907,093 licensed for limited viewing uses only.

DVD video discs are copy protected, and any recordings made from these discs will be distorted. This product incorporates copyright protection technology that is protected by method claims of certain U.S. patents and other intellectual property rights owned by Macrovision Corporation and other rights owners. Use of this copyright protection technology must be authorized by Macrovision Corporation, and is intended for home and other limited viewing uses only, unless otherwise authorized by Macrovision Corporation. Reverse engineering or disassembly is prohibited.

IMPORTANT SAFETY INSTRUCTIONS

- 1. Read Instructions** - All the safety and operating instructions should be read before the appliance is operated.
- 2. Retain Instructions** - The safety and operating instructions should be retained for future reference.
- 3. Observe All Warnings** - All warnings on the appliance and in the operating instructions should be adhered to.
- 4. Follow Instructions** - All operating and use instructions should be followed.
- 5. Water and Moisture** - The appliance should not be used near water – for example, near a bathtub, washbowl, kitchen sink, laundry tub, in a wet basement, or near a swimming pool, and the like.
- 6. Carts and Stands** - The appliance should be used only with a cart or stand that is recommended by the manufacturer.
- 6A.** An appliance and cart combination should be moved with care. Quick stops, excessive force, and uneven surfaces may cause the appliance and cart combination to overturn.
- 7. Wall or Ceiling Mounting** - The appliance should be mounted to a wall or ceiling only as recommended by the manufacturer.
- 8. Ventilation** - The appliance should be situated so that its location or position does not interfere with its proper ventilation. For example, the appliance should not be situated on a bed, sofa, rug, or similar surface that may block the ventilation openings; or, placed in a built-in installation, such as a book case or cabinet, that may impede the flow of air through the ventilation openings.
- 9. Heat** - The appliance should be situated away from heat sources such as radiators, heat registers, stoves, or other appliances (including amplifiers) that produce heat.
- 10. Power Sources** - The appliance should be connected to a power supply only of the type described in the operating instructions or as marked on the appliance.
- 11. Grounding or Polarization** - Precautions should be taken so that the grounding or polarization means of an appliance are not defeated.
- 12. Power-Cord Protection** - Power-supply cords should be routed so that they are not likely to be walked on or pinched by items placed upon or against them, paying particular attention to cords at plugs, convenience receptacles, and the point where they exit from the appliance.
- 13. Cleaning** - The appliance should be cleaned only as recommended by the manufacturer.
- 14. Power Lines** - An outdoor antenna should be located away from power lines.
- 15. Outdoor Antenna Grounding** - If an outside antenna is connected to the receiver, be sure the antenna system is grounded so as to provide some protection against voltage surges and built up static charges. Section 810 of the National Electrical Code, ANSI/NFPA No.70, provides information with respect to proper grounding of the mast and supporting structure, grounding of the lead-in wire to an antenna discharge unit, size of grounding conductors, location of antenna-discharge unit, connection to grounding electrodes, and requirements for the grounding electrode. (See Figure 1).
- 16. Nonuse Periods** - The power cord of the appliance should be unplugged from the outlet when left unused for a long period of time.
- 17. Object and Liquid Entry** - Care should be taken so that objects do not fall, and liquids are not spilled, into the enclosure through openings.
- 18. Damage Requiring Service** - The appliance should be serviced by qualified service personnel when:
 - A. The power-supply cord or the plug has been damaged; or
 - B. Objects have fallen, or liquid has been spilled, into the appliance; or
 - C. The appliance has been exposed to rain; or
 - D. The appliance does not appear to operate normally or exhibits a marked change in performance; or
 - E. The appliance has been dropped, or the enclosure damaged.
- 19. Servicing** - The user should not attempt to service the appliance beyond that described in the operating instructions. All other servicing should be referred to qualified service personnel.

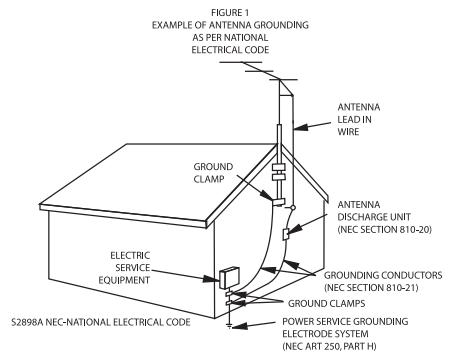

TABLE OF CONTENTS

Safety Precautions	1-2	Repeat Playback	23
Important Safety Instructions	3	Repeating a chapter/title (DVD)	23
Disc Formats	5	Repeating a single track/whole disc (CD)	23
Accessories	6	Repeating a specific section (DVD/CD)	23
Remote Control	6	Playing MP3 and Picture File Disc ..	24-25
Control Reference Guide	7-10	Playing a MP3 file disc	24
Display	11	Playing a Picture file disc	25
Front Panel Display	11	Playing a MP3/Picture file disc	25
Display Information	11	Radio Operation	26
Connections	12-14	Tuning into a station manually	26
Speaker connection	12	FM Stereo	26
AM (MW) loop antenna connection	12	Weak FM stations	26
FM antenna wire connection	12	To search for a station automatically ..	26
Power cord connection	12	Presetting stations	26
Connecting Video Equipment	13	Tuning into a preset station	26
Connecting a TV	13	Customizing the Function Settings ..	27-29
Audio Source Connection	14	LANGUAGE setting	27
Unit Operation	15	VIDEO setting	27
Turning the Unit On	15	AUDIO setting	28
Sound/Tone Adjustment	15	RATING setting	29
Playing a Disc	16-18	Trouble Shooting Guide	30
Playing a Disc	16	Maintenance	31
Pausing playback (still mode)	16	Cleaning Disc	31
Stopping playback	16	Cleaning the unit	31
To skip to a different track	16	Important Note	31
Fast Forward/Fast Reverse	17		
Slow-motion play	17		
Skip (Forward/Reverse)	17		
Zooming into an image	17		
Angle selection	18		
Audio selection	18		
Subtitle selection	18		
Special Functions	19-21		
Display function	19		
Locating a specific title	20		
Locating a specific title/chapter/track ..	20		
Locating a specific time	21		
Angle setting	21		
Audio setting	21		
Subtitle setting	21		
CD/DVD Programmable memory	22		
DVD programmable memory	22		
CD programmable memory	22		

DISC FORMATS

The unit can playback:



DVDs
[8cm(3")/12cm(5") disc]



CD-R CD-RW
Compatible



Audio CDs
[8cm(3")/12cm(5") disc]

Region Management Information:

This unit is designed and manufactured to respond to the Region Management Information that is encoded on DVD discs. If the Region number printed on the DVD disc does not correspond to the Region number of this unit, this unit cannot play that disc.



The region number of this unit is 1.

Disc Function or Operation that is Not Available

When the  symbol appears on the screen, it indicates that the function or operation attempted is not available at that time. This occurs because the DVD disc manufacturer determines the specific functions. Certain functions may not be available on some discs. Be sure to read the documentation provided with the DVD.

Icons Used on DVDs

Sample Icons

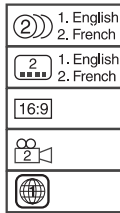

Language selections for audio

Language selections for subtitles

Screen aspect ratio

Multiple camera angles

Region code indicator

Notes:

- This unit supports 2-channel (L/R) audio and 5.1ch (Multi-channel) MPEG Audio 1/2 (only when the DIGITAL AUDIO OUT coaxial jack is used for connection). It does not support 7.1 channel MPEG Audio Version 2.0.
- When playing back a CD-G (Graphics) or CD EXTRA disc, the audio portion will be played, but the graphic images will not be shown.

Title, Chapter and Tracks

- DVDs are divided into "Titles" and "Chapters". If the disc has more than one movie on it, each movie would be a separate "Title". "Chapters" are sections of titles.

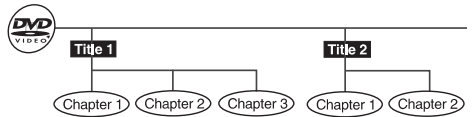

- Audio CDs are divided into "Tracks". A "Track" is usually one song on an Audio CD.



Note :

- Numbers identify each title, chapter, and track on a disc. Most discs have these numbers recorded on them, but some do not.

Notes on Unauthorized Discs

You may not be able to playback some DVD discs on this unit if they were purchased from outside your geographic area or made for business purposes.

ACCESSORIES

Please check and identify the supplied accessories.

Remote control	x1
Audio/Video cable	x1
AM Loop Antenna	x1
FM Antenna	x1
AAA size battery (for remote control)	x2

REMOTE CONTROL

To install Batteries

1. Open the battery door.

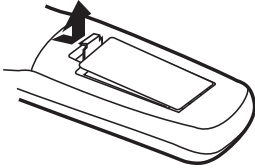

2. Insert Two "AAA" or UM-4 size batteries.

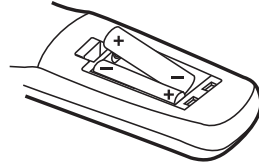

Using the Remote Control

- Point the Remote Control at the REMOTE SENSOR located on the unit.
- When there is a strong ambient light source, the performance of the infrared REMOTE SENSOR may be degraded, causing unreliable operation.
- The recommended effective distance for remote operation is about 16 feet (5 meters).

Battery Replacement

- When batteries become weak, the operating distance of the Remote Control is greatly reduced and you will need to replace the batteries.

Notes:

- If the Remote Control is not going to be used for a long time, remove the batteries to avoid damage caused by battery leakage corrosion.
- Do not mix old and new batteries. Do not mix ALKALINE, standard (CARBON-ZONC) or rechargeable (NICKEL-CADMIUM) batteries.





WARNING:

- Do not dispose of batteries in a fire, batteries may explode or leak.

CONTROL REFERENCE GUIDE

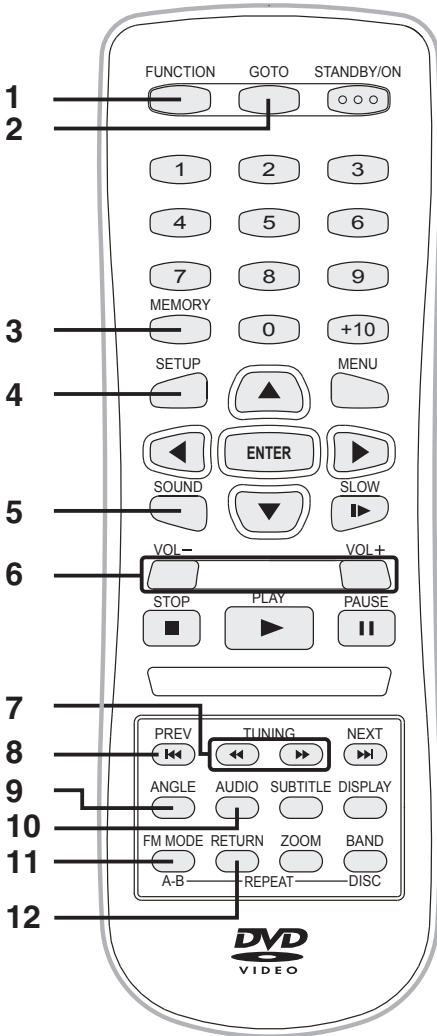
Remote Control



- 1) **FUNCTION button**
Select the source.
- 2) **GOTO button**
Skip directly to a specific location on a DVD/CD disc.
- 3) **MEMORY button**
Enter the number of a selected chapter or track.
Enter the number of a selected radio station.
- 4) **SETUP button**
Open and close the unit's SETUP menu screen.
- 5) **SOUND button**
Selects sound effect for adjustment with the cursor buttons.
- 6) **VOLUME (+/-) buttons**
Adjust the volume.
- 7) **◀◀ / ▶▶ buttons**
◀◀ : Fast reverse playback.
▶▶ : Fast forward playback.
TUNING (◀◀ / ▶▶) : Scan next or previous available radio stations.
- 8) **◀◀ PREV button**
Select previous chapters or tracks on a disc.
- 9) **ANGLE button** 
Switch the camera angle of the video presentation when scenes with multiple camera angles are recorded on a DVD.
- 10) **AUDIO button**
Select one of the audio soundtracks programmed on a DVD or selects the audio output mode on a AUDIO CD.
- 11) **FM MODE button**
Set FM MODE to FM STEREO for FM stereo sound or to FM MONO for mono sound.
REPEAT A-B button
Perform point-to-point repeat playback on a DVD or CD.
- 12) **RETURN button**
Return to the normal operation after using the SETUP menu.

CONTROL REFERENCE GUIDE

Remote Control

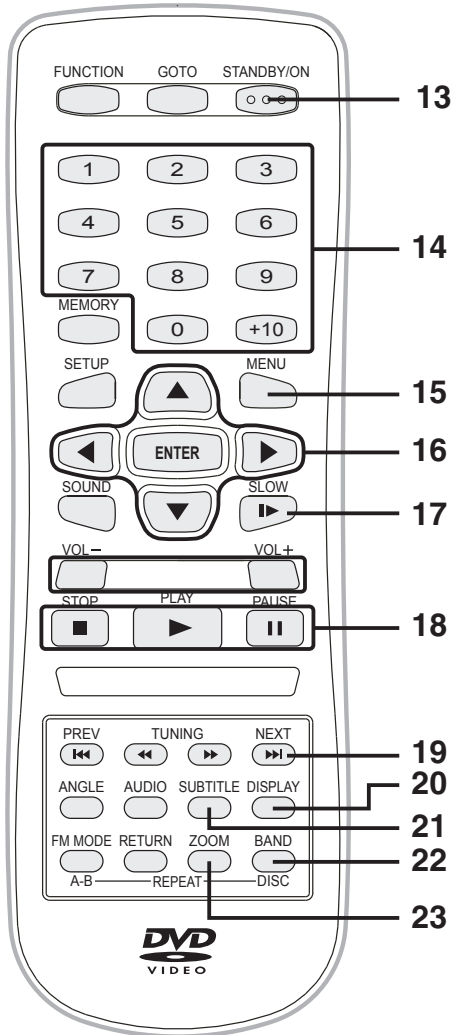

13) STANDBY/ON button

Turns the unit on and puts it in standby mode.

14) Number (0 - 9) and (+10) buttons

Use when creating programs, and entering a parental level password. To select numbers over 9, press +10 button and then the second no. for example, to enter 18, press +10 and then 8.

15) MENU button

Open and close DVD's menu.

16) CURSOR (▲, ▼, ◀, ▶) buttons

Use to highlight selections on a screen and make adjustments to certain settings.

ENTER button

Confirm selections on a menu screen.

17) ► SLOW button

Perform slow forward playback of DVDs.

18) ■ STOP button

Stop playback.

▶ PLAY (PRESET) button

Start playback.

Preset tuner memory up.

■ PAUSE button

Pause playback, frame advance.

19) NEXT ►► button

Select next titles, chapters or tracks on a disc.

20) DISPLAY button

Change disc status information displayed on the screen.

21) SUBTITLE button (⋮)

Select one of the subtitle languages programmed on a DVD.

22) BAND button

Switch between AM (MW) and FM.

REPEAT-DISC button

Repeat chapter or title of a DVD.

Repeat single track or whole CD.

23) ZOOM (TV MODE) button

Zoom into an image of a video playback. In stop mode, select whether to output the video signal. TV shows "AUTO" which means output signal depends on DVD disc (either NTSC or PAL). TV shows "AUTO" or "NTSC" which means output signal fixed to AUTO or NTSC.

CONTROL REFERENCE GUIDE

Unit - (Front , Top, Left & Right Panel)

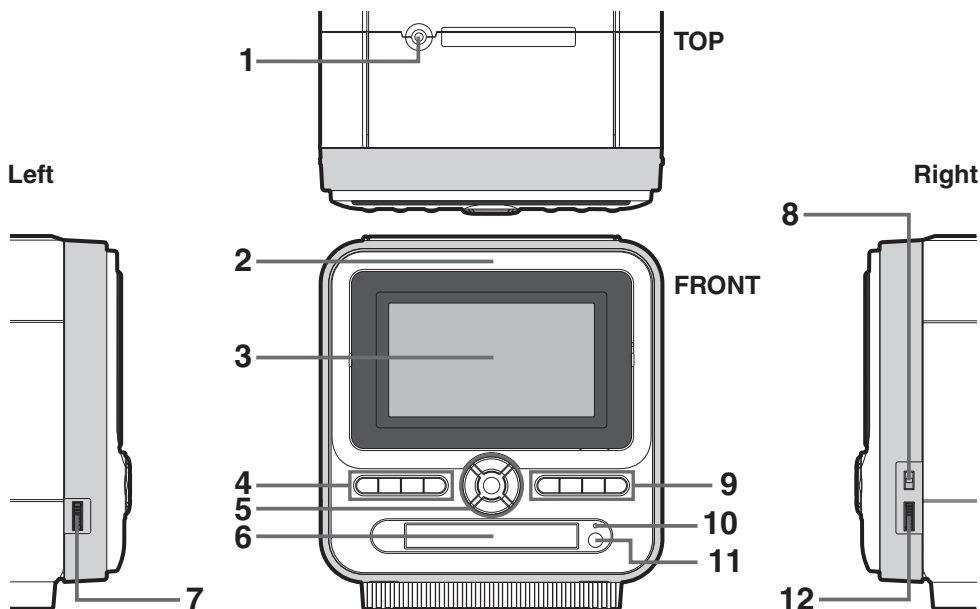

1) Headphone jack

2) Disc door

3) Screen

4) \odot STD.BY/ON (standby/on) button

Turns the unit on and puts it in standby mode.

FUNCTION button

Select the source.

\lll / \ggg SKIP (TUNING) buttons

Press \lll button once instantly to go back to previous chapters / tracks. Press \ggg button once instantly to advance a chapters / tracks. Scan next or previous available radio stations.

5) VOLUME (+/-) buttons

Change the loudness of the sound from the speakers connected to the unit.

■ STOP button

Stop playing a disc.

\blacktriangleright PLAY (PRESET) button

Press to start or resume playback. Preset tuner memory up.

6) Display window

See Display system information (Page 11).

7) COLOR control

Adjust for color intensity.

8) SCREEN (OFF / WIDE / NORMAL) switch

WIDE : Wide-screen.

NORMAL : Pan screen.

9) PAUSE \lll button

Press to pause playback of disc. Each time you press the **PAUSE \lll** button the picture advances one frame. Press the **\blacktriangleright PLAY** button to resume playback.

REPEAT (BAND) button

Repeat chapter or title of a DVD.

Repeat single track or whole CD.

Switch between AM(MW) and FM frequency.

DISPLAY button

Change disc status information displayed on the screen.

SUBTITLE button

Select one of the subtitle languages programmed on a DVD.

10) STANDBY indicator

When the unit is turned on by pressing the \odot STD.BY/ON button. If you press the STANDBY/ON button on the remote control, the unit will turn off and go into standby mode. The light will continue to illuminate.

11) Remote sensor

12) BRIGHTNESS control

Adjust the lightness or darkness of the color.

Note: Screen saver - If no button is pressed within a few minutes, the function will active. If you want to return the normal screen, press any button.

CONTROL REFERENCE GUIDE

Unit - (Rear Panel)

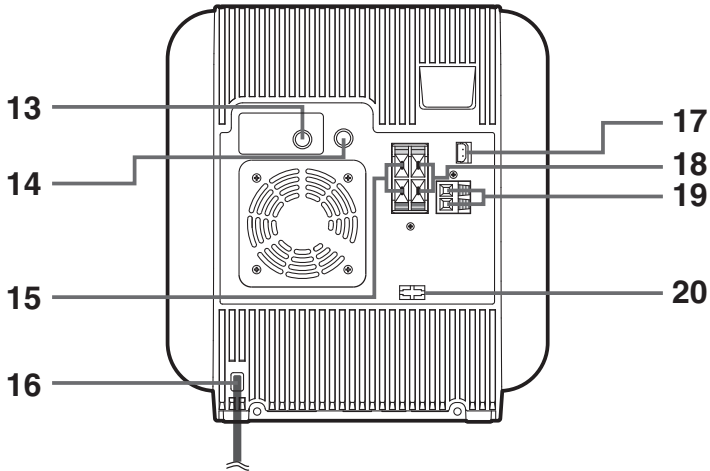

13) AV IN / OUT jack

14) DIGITAL OUT jack

15) RIGHT speaker terminals

16) AC POWER cord

17) AM (MW) LOOP ANTENNA terminal

18) LEFT speaker terminals

19) FM ANTENNA terminals

20) AC VOLTAGE selector

DISPLAY

Front Panel Display

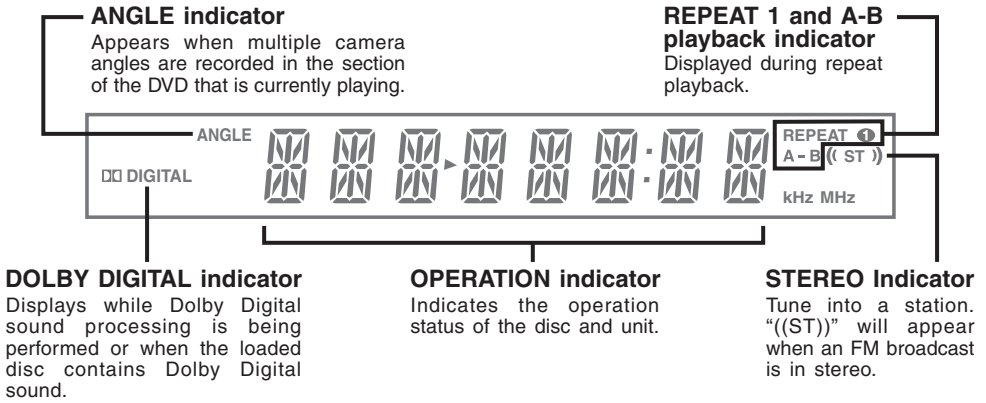

Display Information

The information below is displayed on the screen and fluorescent display during operation.

Display Example

	Screen	Display	Remarks
If no disc is loaded when the Main Unit is switched on.	No Disc	NO DISC	"NO DISC" appears when the disc door is closed and: 1) There is no disc on the disc compartment. 2)The disc is not loaded correctly (upside-down, etc.)
When a invalid disc is loaded when the Main Unit is switched on.	No Valid Disc	BAD DISC	Invalid disc format is detected.
Door open	▲ Open	OPEN	
Loading	⌚ Loading...	LOAD	Unit is verifying disc and reading information.
Stopped	■ Stop		The display changes to show other indicators (total time, etc.)
Playing	▶ Play		
Paused	⏸ Pause II		Freezes the image on the screen or pauses audio playback.
Fast forward	⏩ X 2		The display changes to show other indicators (total time, etc.)
Fast reverse	⏪ X 2		
Slow	⏮ 1/2		Does not function for Audio CDs.
Repeat A - B	Rep A- Rep A-B	REPEAT A - B	Repeat a specific section.
	⊘		The operation is not supported.

Region (Local) Number Error Indicator

If the region (local) number of the disc that you attempt to play differs from the region number of the Unit, "Invalid Region" appears on the screen. (The disc cannot be played).

CONNECTIONS

1. Speaker connection

- Connect the right speaker to the R terminals, and the left speaker to the L terminals.
- Connect the wires with the printed white lines to the red (+) terminals and the plain-black wires to the black (-) terminals.

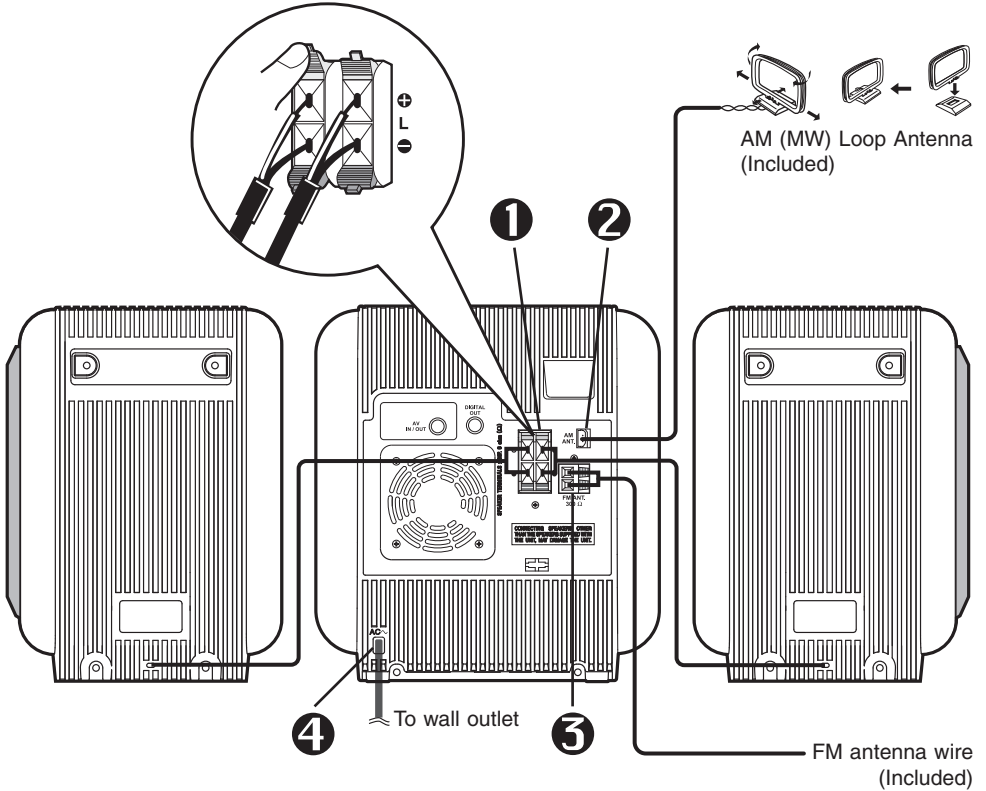

2. AM (MW) loop antenna connection

- Connect the loop antenna (included) to the AM (MW) LOOP ANTENNA terminal.

3. FM antenna wire connection

- Connect FM antenna wire (included) to the FM ANTENNA terminals.

4. Power cord connection

- Make sure that all the components and speakers are connected correctly.
- Be sure the AC power cord is disconnected and all functions are off before making connections.
- When you are not going to use the Unit for a long period of time, disconnect the power cord.

Note:

- Before using the unit, check that the rated voltage matches your local voltage.

CONNECTIONS

Using this Unit with Other Equipment

A. Connecting Video Equipment

- You can connect other Video Equipment for playback through the system.

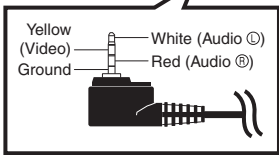
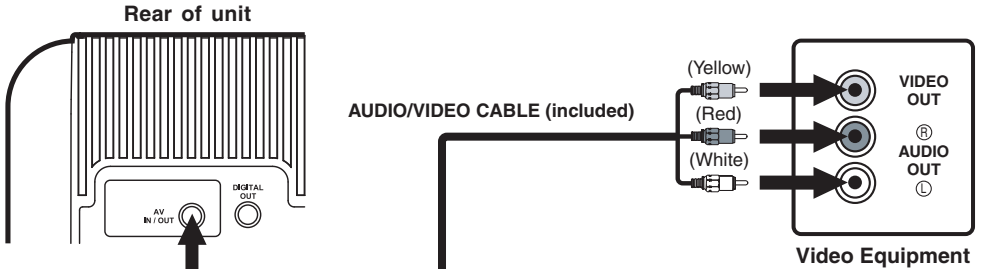

3.5mm plug description

Watching Video Equipment

- Turn on the unit, press the **FUNCTION** button to select "AV IN".
- Turn on the video equipment and follow the instructions provided with it to playback.

Note: If you have a mono VCR, the volume level from the speakers will be low.

B. Connecting a TV

- If your TV has Audio/Video inputs, you can also connect the unit to your TV using the Audio/Video cable. If your TV does not have Audio/Video inputs, you can purchase an RF modulator (sold separately) to connect the unit.

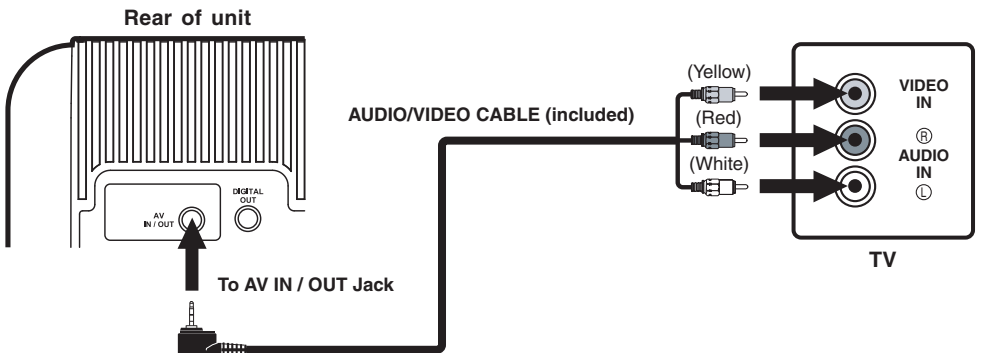

Watching a DVD on your External TV

- Turn on the unit, press the **FUNCTION** button to select "DVD".
- Turn on the TV and follow the instructions included with it to select the proper video in source.

Note: Make sure you use the correct Audio/Video cable.

CONNECTIONS

C. Audio Source Connection

- You can use your unit as an audio source to connect to your stereo amplifier. Using the Audio/Video cable, connect ONLY the red and white plug from AV IN / OUT jack on your Unit to the AUDIO IN jack or use a Coaxial Digital Audio cable to connect to the coaxial in jack on your another equipment. Do not connect the yellow video plug.

Analogue connection

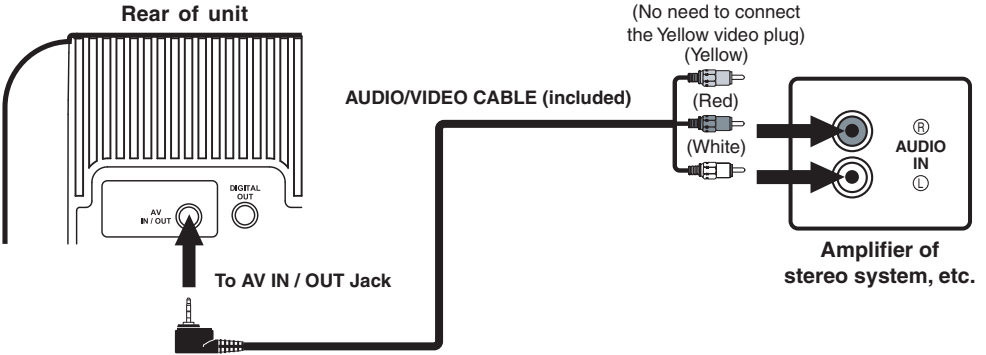

Using External Audio Equipment

1. Turn on the unit.
2. Turn on your audio equipment and follow the instructions included with it to select the AUDIO IN or DIGITAL IN function.

Digital connection

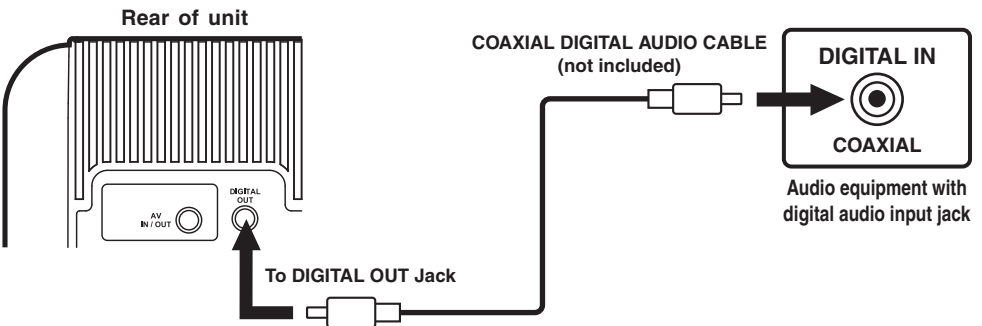

Notes:

- When you connect the unit to other equipment, be sure to turn off the power and unplug all of the equipment from the wall outlet before making any connection.
- You may experience interference if the tuner function is selected while the television is working.
- If you have a stereo VCR, make sure you set it in stereo mode.
- Due to copyright protection, DVD movies cannot be copied. If you copy a DVD movie onto a videotape, the resulting copy will be unclear, with poor sound quality. This is NOT caused by a defective DVD system.
- Refer to the instruction manual of the connected equipment as well.

UNIT OPERATION

Turning the Unit On

The system is in the standby condition (STANDBY indicator lights) when the AC power cord is connected.

1. Press the **⊕ STD.BY/ON** button on the unit or press the **STANDBY/ON** button on the remote control to turn ON the unit.
2. Press the **FUNCTION** button to select the desired feature. The corresponding feature mode will appear on unit's fluorescent display. If DVD is selected, the DVD logo (start-up picture) will appear on the screen.
3. Press the **⊕ STD.BY/ON** button on the unit or press the **STANDBY/ON** button on the remote control to return the unit to standby mode.



Notes:

- Whenever no disc or disc stop for 30 minutes, the system will be turned to standby mode automatically.
- The Standby indicator will be turned on while the unit is at standby mode.

SOUND/TONE ADJUSTMENT

Adjust the Sound Tone

Press the **SOUND** button until a desired sound effect is displayed. Press **▲** or **▼ CURSOR** button to adjust the sound effect.

Using Headphones

- Turn down the volume before connecting headphones to the unit, then adjust the volume to your desired level.
- When headphones are connected to the unit, the speakers will be disabled.

Note:

- Avoid listening to sound at high levels for prolonged periods of time. This may be harmful to you and may cause loss of hearing.

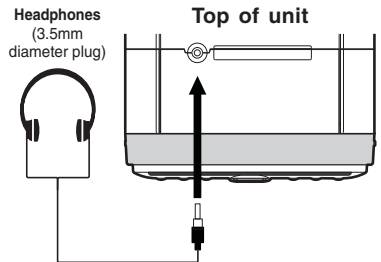

Dolby Digital (for DVD)

Dolby Digital is a sound system developed by Dolby Laboratories Inc. that gives movie theatre ambience to audio output when the unit is connected to a Dolby Digital 5.1 channel processor or amplifier (through the "digital out" audio jack).

This unit automatically recognizes DVDs that have been recorded with Dolby Digital.

Not all Dolby Digital sources are recorded with 6 channels.



Some sources marked Dolby Digital may be recorded in Dolby Surround, a 2 channel system. Look for this logo on your unit.



Manufactured under license from Dolby Laboratories.

'Dolby' and  the double-D symbol are registered trademarks of Dolby Laboratories.

This owner's manual explains the basic instructions of this unit. Some DVD discs are produced in a manner that allows specific or limited operation during playback. As such, the unit may not respond to all operating commands. This is not a defect in the unit. Refer to the instruction notes of discs.

"" may appear on the screen during operation. A "" means that the desired operation is not permitted by the unit or disc.

Playing a Disc

1. Press the  **STD.BY/ON** button on the unit or press the **STANDBY/ON** button on the remote control to turn on the unit.
2. Press the **FUNCTION** button to select the DVD mode.

See **CUSTOMIZING THE FUNCTION SETTINGS** (page 27 to 29) before proceeding to step 3.

3. Open the disc door.
4. Hold the disc by its sides and carefully make it fit onto the central support of compartment with the printed side facing towards you until you hear a "click".
5. Close the disc door gently.



It takes a short while for your unit to load the disc. After loading, for some discs, the unit will automatically start playing most discs.

6. If the disc does not start automatically, press the  **PLAY** button.

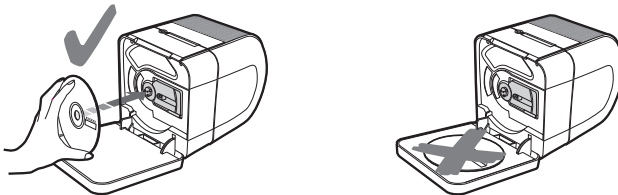

NOTE: With its printed side facing outward, gently push the disc onto the center pivot until it clicks and is held in place securely.





Pausing playback (still mode)



Press the  **PAUSE** button to hold still of a playing disc. To resume normal playback, press the  **PLAY** button.

Stopping playback

Press the  **STOP** button at the location where you want to interrupt playback. To resume playback at the position where the disc was stopped, press the  **PLAY** button again.

If you press the  **STOP** button twice, the unit's memory will be cleared and pressing the  **PLAY** button will reset the disc to the beginning.

To skip to a different track

- Press the  **PREV** button on the remote once to skip to the start of the previous track.
- Press the  **NEXT** button on the remote to skip to the next track.
- For audio CD disc, use the number buttons (remote control only) to jump straight to the desired track number.

PLAYING A DISC

Fast Forward/Fast Reverse

1. Press the **▶▶** or **◀◀** button when a disc is playing.

- The disc begins fast scan at x2 speed.
- Four speeds are available. Each time **▶▶** or **◀◀** button is pressed, the speed of fast scan changes in the following sequence:

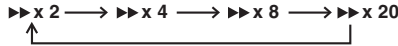

The speed of fast scan



2. Press the **▶ PLAY** button when you reach the desired point to resume playback at normal speed.

Slow-motion play

1. Press the **▶ SLOW** button on the remote in the play mode.

- Two speeds are available. Each time **▶ SLOW** button is pressed, the speed of slow-motion playback changes in the following sequence:

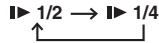

2. Press the **▶ PLAY** button to return to the normal playback speed.

SKIP (Forward /Reverse)

While you are playing a disc, press the **▶▶ NEXT** button of the remote or **▶▶ SKIP** button on the front of unit to move to the beginning of the next chapter or track. Press the **◀◀ PREV** button of the remote or **◀◀ SKIP** button on the front of unit to move to the previous chapter or track and automatically start playing it.

Zooming into an image

While a disc is playing, press the **ZOOM** button.

- While an image is zoomed, you can use **▲**, **▼**, **◀** and **▶** button to shift the view and display the part you want.
- To return to the normal view, press the **ZOOM** button until the “**Qoff**” symbol shows. The screen will return to normal.

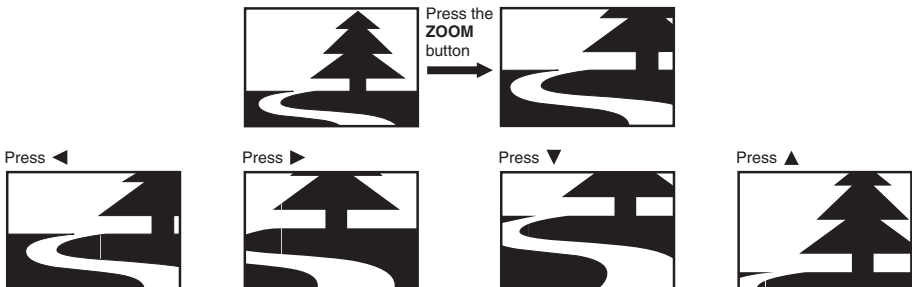

- When you reach the edge of the image, the display will not shift anymore in that direction.

Angle selection

Some DVDs contain scenes which have been shot from a number of different angles. For these discs, the same scene can be viewed from each of these different angles.

1. While you are playing a DVD with different angles recorded, press the **ANGLE** button to view the number of the current angle.
2. Press the **ANGLE** button repeatedly to change the scene to the next angle in those recorded.
 - About two seconds later, playback continues from the new angle you selected.
 - If no button is pressed within a few seconds, playback continues without changing the current angle.

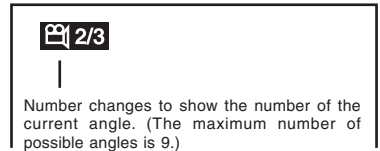

Sequence of angle shots (Example)

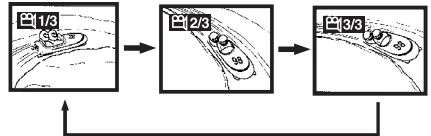

Notes:

- This function can only be used for discs on which scenes shot from multiple angles have been recorded.
- If only one angle is recorded, " 1/1 " is displayed.

Audio selection

On some discs, the sound track is recorded in two or more formats. Follow the directions below to select the type of playback.

1. While a disc is playing, press the **AUDIO** button to show the current audio format number.
2. Press the **AUDIO** button repeatedly to select the desired audio format.

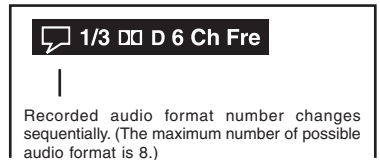

Notes:

- If only one audio format is recorded, the number does not change.
- About two seconds later, playback continues in the new audio format.

Subtitle selection

1. While a DVD is playing, press the **SUBTITLE** button to display the current language setting, as shown in the example below.

1/3 Eng → 2/3 Spa → 3/3 Fre → Off

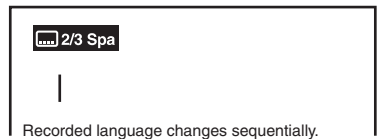

2. Press the **SUBTITLE** button repeatedly to select the desired subtitle language.

Notes:

- If only one language is recorded, the language does not change.
- About two seconds later, playback continues with the new subtitle you selected.
- The number of languages recorded differs depending on the disc.
- If no button is pressed within a few seconds, playback continues without changing the current subtitle setting.
- This function can only be used for discs on which subtitles have been recorded in multiple languages.
- On some DVDs, subtitles are activated from the main menu of the DVD. Press the **MENU** button to activate the main menu.

DISPLAY function

Using DISPLAY, you can check and change the current settings of the following items: ANGLE, AUDIO and SUBTITLE.

- While the disc is playing, press the **DISPLAY** button to display the screen shown below.
Elapsed time: Elapsed time from the beginning of the chapter which is currently playing.
Remaining time: Remaining time of the title which is currently playing.



- Press the **DISPLAY** button twice to display the screen shown as below.
- Press the **ANGLE**, **AUDIO** and **SUBTITLE** button to change the selected item.

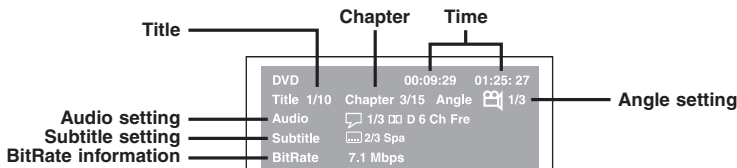

Title skip

- The number of the title currently playing and total titles of disc.
- Press the **GOTO** button to set your desired title, then press the **ENTER** button to confirm.

Chapter skip

- The number of the chapter currently playing and total chapters of the currently played title.
- Press the **GOTO** button to set your desired chapter, then press the **ENTER** button to confirm.

Time skip

- Elapsed time from the beginning of the currently playing chapter and the remaining time from the beginning of the currently playing title.
- Press the **GOTO** button to set your desired point to start playback, then press the **ENTER** button to confirm.

Angle setting

- The current angle is displayed. When a disc with only one angle is played back, "📺 1/1" is displayed.
- Press the **ANGLE** button to select the desired angle.

Audio setting

- The type of audio currently selected is displayed.
- Press the **AUDIO** button to select your desired type of audio.

Subtitle setting

- The subtitle number and language currently selected is displayed. When a disc with only one subtitle is played back, "📄 1/1 Eng" is displayed.
- Press the **SUBTITLE** button to select your desired language.

GOTO function

- This function allows you to skip directly to any part of the disc while a disc is playing.

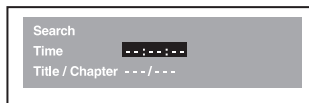

Note:

- After settings, press the **DISPLAY** button again to return to the normal screen.

Locating a specific title 

If a DVD disc contains title numbers, you can locate a specific title directly by selecting a title number.

1. Press the **GOTO** button.
2. Press **▼** , **◀** or **▶** button to highlight a specific field and press the corresponding number button(s) for the title you want.
3. Press the **ENTER** button to confirm. The unit will start playback in a few seconds.

**Locating a specific title / chapter / track**  

If you know the title / chapter / track number you want to play, you can locate a specific title / chapter / track by directly selecting a title / chapter / track number.

1. Press the **GOTO** button to search your desired title / chapter / track.
2. Press **▼** , **◀** or **▶** button to highlight a title / chapter / track and press the corresponding number button(s) for the chapter you want.
3. Press the **ENTER** button to confirm. The unit will start playback in a few seconds.

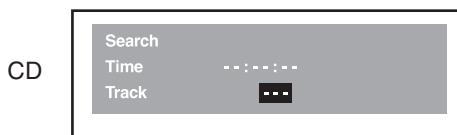
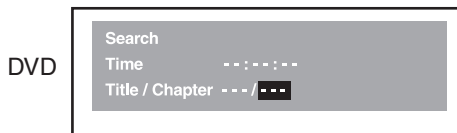

Locating a specific time

You can move to a specific time marker location by entering its corresponding time (hours, minutes, seconds).

1. Press the **GOTO** button.
2. Press **▲** or **▼** button to highlight time.



3. Press the corresponding number buttons for the setting point you want.
 - The first two numbers you entered represent hours.
 - The second two numbers you entered represent minutes.
 - The third two numbers you entered represent seconds.
4. Press the **ENTER** button to confirm. The unit will start playback in a few seconds.

Notes:

- Some discs may not respond to this process.
- Some scenes may not be located as precisely as you specified.
- This method for accessing specific locations is available only within the current title of the DVD disc.
- You can move through the menu by pressing the **▲** and **▼** buttons.

Angle setting

1. Press the **DISPLAY** button twice. The FUNCTION menu is displayed on the screen and you can see how many angles are recorded on the disc.
2. Press the **ANGLE** button repeatedly to select your desired angle.
3. The unit will change to your desired angle in a few seconds.

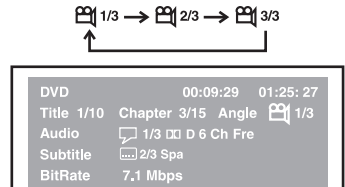

Audio setting

1. Press the **DISPLAY** button twice. The FUNCTION menu is displayed on the screen and you can see how many audio formats are recorded on the disc.
2. Press the **AUDIO** button repeatedly to select your desired type of audio.
3. The unit will change to your desired type audio in a few seconds.

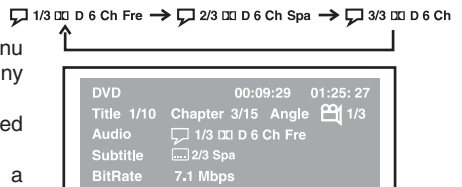

Subtitle setting



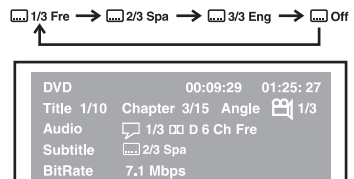

1. Press the **DISPLAY** button twice. The FUNCTION menu is displayed on the screen and you can see how many subtitle formats are recorded on the disc.
2. Press the **SUBTITLE** button repeatedly to select your desired language.
3. The unit will change to your desired language in a few seconds.







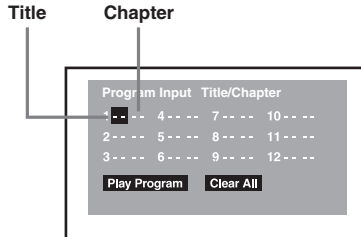

Programmable memory

The two types of programmed playback provided by this unit are title programmed playback and chapter programmed playback.

Title / Chapter programmed playback

1. Press the **MEMORY** button while the disc is stopped.
2. Enter the title numbers in . Use  or  button to move the highlight to chapter and enter the chapter numbers in .



3. Use , ,  or  button to move to the other field.
4. Repeat steps 2 to 3.
5. Press the  **PLAY** button to start the programmed playback.

Note:





- If you press the  **STOP** button twice at programmed playback mode, the programmed playback function will be cancelled.

Programmable memory

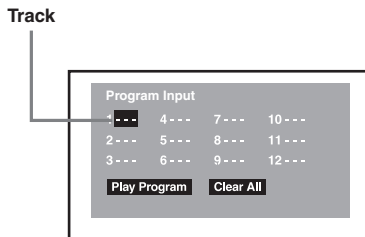
Track programmed playback

1. Press the **MEMORY** button while the disc is stopped.
2. Enter the track numbers in .



3. Use , ,  or  button to other field.
4. Repeat steps 2 to 3.
5. Press the  **PLAY** button to start the programmed playback.

You can play a specific title or chapter repeatedly. (Title repeat, chapter repeat, A-B repeat)

Repeating a chapter

You can play the same chapter repeatedly.

1. While the disc is playing, press the **REPEAT DISC** button until the " **Repeat Chapter** " indicator displays on the screen. The current chapter is played repeatedly.

Repeating a title

You can play the same title repeatedly.

2. While the disc is playing, press the **REPEAT DISC** button until the " **Repeat Title** " indicator displays on the screen. The current title is played repeatedly.

To resume normal playback

3. While the disc is playing, press the **REPEAT DISC** button until the " **Off** " indicator displays on the screen.

You can play a single track and whole disc repeatedly.

Repeating a single track

You can play the same track repeatedly.

1. While the disc is playing, press the **REPEAT DISC** button until the " **Repeat Single** " indicator displays on the screen. The current track is played repeatedly.

Repeating a whole disc

2. While the disc is playing, press the **REPEAT DISC** button until the " **Repeat All** " indicator displays on the screen. The whole disc is played repeatedly.

To resume normal playback

3. Press the **REPEAT DISC** button until the " **Off** " indicator displays on the screen.

Repeating a specific section

You can play a specific section repeatedly.

1. While the disc is playing, press the **REPEAT A-B** button at the beginning of the section (**Rep A -**) is displayed you want to play repeatedly.
2. Press the **REPEAT A-B** button again at the end of the section (**Rep A - B**) is displayed.
3. The unit will immediately begin replaying your selection.

To resume normal playback

4. While the disc is playing, press the **REPEAT A-B** button until the " **Rep Off** " indicator displays on the screen.

Notes:

- A-B repeat can only be used within the same title. If the start and end of the section to be repeated are in different titles, A-B repeat is cancelled.
- The A-B repeat function does not operate in scenes where different camera angles are recorded.

PLAYING MP3 AND PICTURE FILE DISC

This unit will play MP3 and Picture files recorded on CD-R and CD-RW discs.

Playing a MP3 file disc

1. Open the disc door.
2. Hold a MP3 file disc by its sides and carefully make it fit onto the central support of compartment with the printed side facing towards you until you hear a "click".
3. Close the disc door gently.
4. The unit will take a short while to load the disc and automatically begin playback.

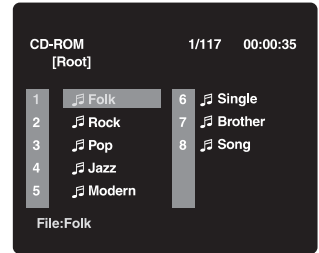

To pause playback

- Press the **|| PAUSE** button. To resume playback again, press the **▶ PLAY** button.

To stop playback

- Press the **■ STOP** button.

To skip to the next or previous file

- Press the **▶▶ NEXT** button on the remote control or **▶▶ SKIP** button on the front panel briefly while playing, to skip ahead to the beginning of the next file. Each time you press the button consecutively, the beginning of the next file is located and played back.
- Press the **◀◀ PREV** (Previous) button on the remote control or **◀◀ SKIP** button on the front panel briefly while playing, to skip back to the beginning of the previous file. Each time you press the button consecutively, the beginning of the previous files is located and played back.
- You also can press the **GOTO** button, set the track number you want and then press the **ENTER** button.

Notes:

- You can not play in Fast reverse of Fast forward during MP3 files.
- During MP3 playback, if you press the **■ STOP** button twice and then press **▶ PLAY** button again, it will start to play from the beginning of the file. If you press the **■ STOP** button once and then press **▶ PLAY** button again. It will resume playback from the location where you stopped playback.

Notes:

The ability of this unit to read MP3 disc is dependent on the following:

- The Bit Rate must be within 64 - 256 kbps.
- The total number of files on the disc should not exceed 254.
- The maximum number of directories should not exceed 32.
- The maximum depth level of directories should not exceed 4.
- File names should be named using 12 or fewer letters and/or numbers, and must incorporate the "MP3" file extension. EXAMPLE: *****. MP3 where each * is a letter or number.
- Use only letters and / or numbers in file names. If you use special characters, the file and / or folder names may not be displayed correctly on the on-screen display.
- When recording on CD-R discs, use 74-minute (650Mb) discs.
- The CD-R or CD-RW discs should be "finalized" in computer by "single session format".
- See your CD/MP3 creation software for details.

PLAYING MP3 AND PICTURE FILE DISC

Playing a Picture file disc

1. Open the disc door.
2. Hold a Picture disc by its sides and carefully make it fit onto the central support of compartment with the printed side facing towards you until you hear a "click".
3. Close the disc door gently.
4. The unit will take a short while to load the disc.
5. Press the ► **PLAY** button. The next picture will automatically display after 6 seconds.

Full-Screen
Review

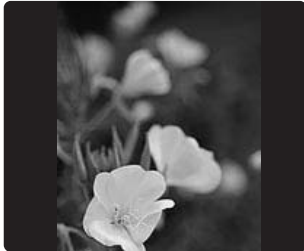

Thumbnail
Review



Notes:

- If you press the **MENU** button on the remote control in full-screen review, the unit will display a menu of 9 thumbnail images.
- Use the **cursor** to highlight the ►► **NEXT** or ◀◀ **PREV** in thumbnail screen and then press **ENTER** button to review other images. If you want to review one image in full-screen, you can use the **CURSOR** ▲, ▼, ◀ or ► buttons to highlight the image and then press the **ENTER** button to confirm. The image you selected will show on the LCD full-screen. The images will automatically display one by one again in about 6 seconds intervals.
- You can press the ||| **PAUSE** button to interrupt playback, and press the ► **PLAY** button to resume playback.
- You also can use **GOTO** function or use the numbered buttons to enter the number to quickly select any image.
- You can press the **ZOOM** button to enlarge the picture in 3 levels.
- Press the **ANGLE** button on the remote control to rotate the picture orientation by 90°.

Playing a MP3 / Picture file disc

1. Open the disc door.
2. Hold a MP3 files/Picture disc by its sides and carefully make it fit onto the central support of compartment with the printed side facing towards you until you hear a "click".
3. Close the disc door gently.
4. The unit will take a short while to load the disc.
5. Use ▲, ▼, ◀ or ► button to select MP3 or Picture files, then press the **ENTER** button.

Note:

- The **SETUP** button does not work during MP3 or Picture Disc playback or stop.

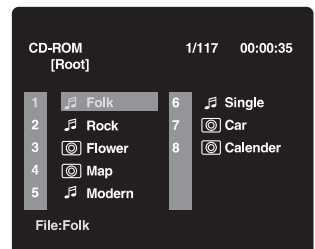

RADIO OPERATION

Tuning into a station manually

1. Press **FUNCTION** button until the frequency band appears on the display.
2. Press the **BAND** button to select the desired band.
3. Press the **◀ TUNING ▶** button to tune in the desired station.



FM Stereo

Press the **FM MODE** button on the remote until "STEREO" appears on the display.



Weak FM stations

- Press the **FM MODE** button on the remote until the "MONO" word appears on the display. Background noise will be reduced but the signal reproduced will be mono. To restore stereo reception, press the **FM MODE** button on the remote to select STEREO.



To search for a station automatically

- Hold down the **◀ TUNING ▶** buttons on the remote or **◀◀ SKIP ▶▶** buttons on the front panel for 1 to 2 seconds, and a station is searched for automatically. After tuning in a station, the search stops.
- The search may not stop at a station with a very weak signal.

Presetting stations

You can tune into a stored station directly by entering the preset number.

20 stations on FM band can be preset.

20 stations on AM(MW) band can be preset.

1. Press **FUNCTION** button until the frequency band appears on the display.
2. Press the **BAND** button to select the desired band.
3. Press the **▶ PLAY (PRESET)** button or number button to select the preset number.
4. Use the **◀ TUNING ▶** button to find your desired station.
5. Press the **MEMORY** button twice on the remote.
6. Repeat steps 2-5 to store other stations

Tuning into a preset station

1. Press **FUNCTION** button until the frequency band appears on the display.
2. Press the **BAND** button to select the desired band.
- Press the **▶ PLAY (PRESET)** button to select the presetted station or use the numbered buttons to enter the number to select the presetted station.

Example: To select preset number 15, press the +10 and 5 buttons.

To select preset number 10, press the +10 and 0 buttons.

CUSTOMIZING THE FUNCTION SETTINGS

LANGUAGE setting

1. Press the **FUNCTION** button until the **DVD** shows up on the screen.
2. Press the **STOP** button to ensure no disc is being played.
3. Press the **SETUP** button.
4. Use **◀** or **▶** button to select **Language**, then press the **ENTER** button.
5. Select the options (**English, Deutsch, Français, Español, Italiano, Svenska** or **Português**) to be adjusted by pressing **▲** or **▼** button, and then press the **ENTER** button. (The screen will change to your desired language).
6. To exit the **FUNCTION SETUP MENU**, press the **RETURN** button once.

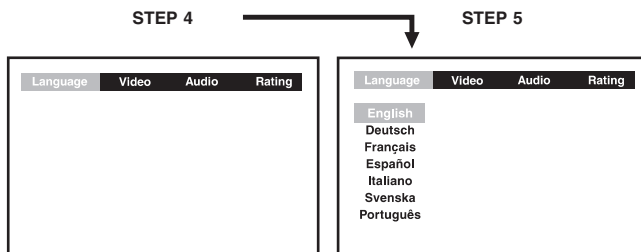

VIDEO setting

1. Press the **FUNCTION** button until the **DVD** shows up on the screen.
2. Press the **STOP** button to ensure no disc is being played.
3. Press the **SETUP** button.
4. Use **◀** or **▶** button to select **Video**, then press the **ENTER** button.
5. Select the options (**TV Shape, Brightness** or **Edges**) to be adjusted by pressing **▲** or **▼** button, and then press the **ENTER** button.
6. Use the **▲** or **▼** button to select the required option, and then press the **ENTER** button.
7. Repeat steps 5 and 6 above to adjust other options.
8. To exit the **FUNCTION SETUP MENU**, press the **RETURN** button once.

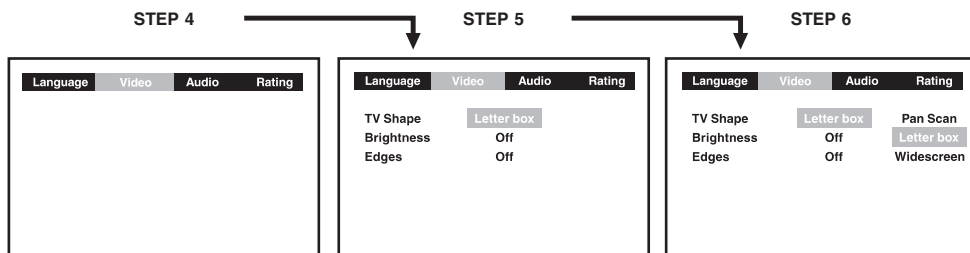

CUSTOMIZING THE FUNCTION SETTINGS

Explanation of Aspect Ratios

Cut off when a wide-screen video image is played.

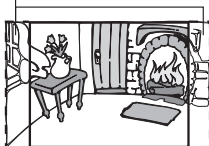

Pan Scan (Normal)

- When wide-screen video is played, this mode clips the right and left sides of the image so that it can be viewed on a conventional screen.
- Some wide-screen DVDs that do not permit Pan Scan mode playback are automatically played in letterbox mode (black bands top and bottom).



Letter Box

- When wide-screen video is played in this mode on a conventional screen, black bands appear at the top and bottom of the screen.



Wide-screen

- This is the correct mode for playing wide-screen videos on a wide-screen.

Notes:

- The displayable picture size is preset on the DVD disc. Therefore the playback picture of some DVD discs may not conform to the picture size you select.
- When you play DVD discs recorded in the 4:3 aspect ratio, the playback picture will always appear in the 4:3 aspect ratio regardless of the TV shape setting.

Brightness (On) : Picture is set brighter.

Brightness (Off) : Picture is set to normal brightness.

Sharpen : Picture is set to finer resolution.

Soften : Softer image effect.

Off : Picture will be returned to default setting.

AUDIO setting

This setting affects the output of the **Digital Out** audio connector and to obtain expansive virtual surround sound effects from just two speakers.

1. Press the **FUNCTION** button until the **DVD** shows up on the screen.
2. Press the **STOP** button to ensure no disc is being played.
3. Press the **SETUP** button.
4. Use **◀** or **▶** button to select **Audio**, then press the **ENTER** button.
5. Select the options (**Digital Out** or **Pink Noise**) to be adjusted by pressing **▲** or **▼** button.
6. Press the **ENTER** button to select the required options.
7. Repeat steps 5 and 6 above to adjust other options.
8. To exit the **FUNCTION SETUP MENU**, press the **RETURN** button once.

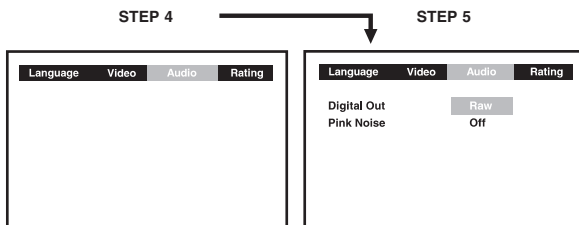

Raw : Use this setting when the unit is connected to an external Dolby Digital decoder.

PCM : Use this setting when the unit is connected to an external surround decoder or stereo.

CUSTOMIZING THE FUNCTION SETTINGS

RATING setting

DVD discs equipped with the password function are rated according to their content. The contents allowed by a parental lock level and the way a DVD disc can be controlled may vary from disc to disc.

For example, if the disc allowed, you could edit out violent scenes unsuitable for children and replace them with more suitable scenes, or you could lock out playback of the disc altogether.

1. Press the **FUNCTION** button until the **DVD** shows up on the screen.
2. Press the **STOP** button to ensure no disc is being played.
3. Press the **SETUP** button.
4. Use **◀** or **▶** button to select **Rating**, then press the **ENTER** button.
5. Select the options (**Password**, **Parental lock** or **Factory Set**) to be adjusted by pressing **▲** or **▼** button, and then press the **ENTER** button.
6. Use **▲** or **▼** button to shift and select the required option, then press the **ENTER** button.

You cannot play DVD discs rated higher than the level you selected unless you cancel the parental lock function.

The parental lock levels are equivalent to the following ratings.

Level 1 : Kid Safe	Level 5 : PG_R
Level 2 : G	Level 6 : R
Level 3 : PG	Level 7 : NC_17
Level 4 : PG_13	Level 8 : Adult

7. Repeat steps 5 and 6 above to adjust other options.
8. To exit the FUNCTION SETUP MENU, press the **RETURN** button once.



The Parental lock is active.



Indicates Parental lock is NOT active.

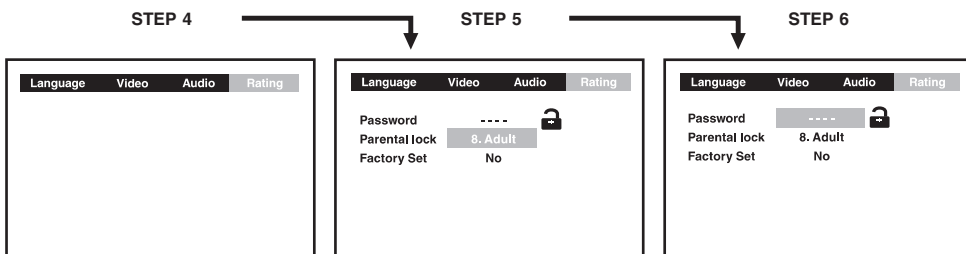

If you forget the password, you can erase your current password by pressing number button 8 on the remote four times, then press the ENTER button to confirm the setting.

PASSWORD : 8 8 8 8

Note:

- It takes 3-5 seconds to reset the unit to the factory default.

TROUBLE SHOOTING GUIDE

SYMPTOM

CAUSE (AND REMEDY)

No power.

- Check that the AC power cord is connected.

The remote does not function.

- Remove any obstacles between the remote and the unit.
- Use the remote near the unit.
- Point the remote at the remote sensor on the unit.
- Replace all the batteries in the remote with new ones.

No sound or only a very low-level sound is heard.

- Check that the speakers and equipment are connected securely.
- Make sure that you've selected DVD mode.
- The system is in pause mode or in Slow-motion Play mode. Press the ► **PLAY** button to return to normal play mode.
- Fast forward or fast reverse is performed. Press the ► **PLAY** button to return to normal play mode.
- Make sure that AUDIO / VIDEO output connections are correct.
- Adjust the speakers volume.
- The DTS DVD disc cannot be decoded to have speaker output.
- This unit is too hot, shut off the unit for 30 minutes to cool down.

No picture

- The region number of the disc does not match the region number of this unit.



- The function is not set to DVD mode.

The picture is not clear.

- Clean the disc.
- The disc is scratched.

Severe hum or noise is heard.

- Check that the speakers and equipment are connected securely.
- The plugs and jacks are dirty. Wipe them with a cloth slightly moistened with alcohol.
- Clean the disc.
- Vibrations from the speakers are affecting the unit.

The disc does not play.

- There is no disc inside ("No Disc" appears on the screen).
- Insert the disc correctly with the playback side facing inward.
- Clean the disc.
- A non-NTSC disc has been inserted. The unit and disc region number are incompatible.
- Condensation may have formed inside the unit due to a sudden change in temperature. Wait about an hour for it to clear and try again.

MAINTENANCE

Cleaning Disc

A defective or soiled disc inserted into the unit can cause sound to drop out during playback. Handle the disc by holding its inner and outer edges.

- Do NOT touch the surface of the unlabeled side of the disc.
- Do NOT stick paper or tape on the surface.
- Do NOT expose the disc to direct sunlight or excessive heat.
- Clean the disc before playback. Wipe the disc from the center outward with a cleaning cloth.
- NEVER use solvents such as benzine or alcohol to clean the disc.
- Do NOT use irregular shape discs (example : heart shaped, octagonal, etc.). They may cause malfunctions.

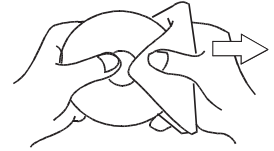

Cleaning the unit

- Be sure to turn the unit off and disconnect the AC power cord before maintaining the unit.
- Wipe the unit with a dry soft cloth.
 - If the surfaces are extremely dirty, wipe clean with a cloth which has been dipped in a weak soap-and-water solution and wrung out thoroughly, then wipe with a dry cloth.
- Never use alcohol, benzine, thinner, cleaning fluid or other chemicals. Do NOT use compressed air to remove dust.

Important Note

Before transporting the unit, remove disc from the disc compartment.

Free Manuals Download Website

<http://myh66.com>

<http://usermanuals.us>

<http://www.somanuals.com>

<http://www.4manuals.cc>

<http://www.manual-lib.com>

<http://www.404manual.com>

<http://www.luxmanual.com>

<http://aubethermostatmanual.com>

Golf course search by state

<http://golfingnear.com>

Email search by domain

<http://emailbydomain.com>

Auto manuals search

<http://auto.somanuals.com>

TV manuals search

<http://tv.somanuals.com>