

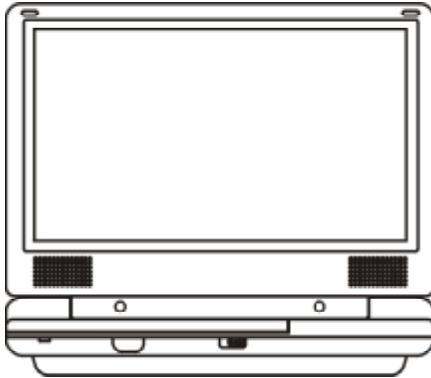

AUDIOVOX®
ELECTRONICS CORP.



D1812PKG

PORTABLE 8" LCD MONITOR AND DVD PLAYER IN A BAG



An LCD panel and/or video monitor may be installed in a motor vehicle and visible to the driver if the LCD panel or video monitor is used for vehicle information, system control, rear or side observation or navigation. If the LCD panel or video monitor is used for television reception, video or DVD play, the LCD panel or video monitor must be installed so that these features will only function when the vehicle is in “park” or when the vehicle’s parking brake is applied.

An LCD panel or video monitor used for television reception, video or DVD play that operates when the vehicle is in gear or when the parking brake is not applied must be installed to the rear of the driver’s seat where it will not be visible, directly or indirectly, to the operator of the motor vehicle.

Notice:

This Product incorporates copyright protection technology that is protected by method claims of certain U.S. Patents and other intellectual property rights owned by Macrovision Corporation and other rights owners. Use of this copyright protection technology must be authorized by Macrovision Corporation, and is intended for home and other limited viewing uses only unless otherwise authorized by Macrovision Corporation. Reverse engineering or disassembly is prohibited.

Content

A. Introduction	4
B. Cautions and Warnings	4
C. Contents	6
D. Powering and Installation	7
E. Vehicle Installation.....	7
F. Controls, Indicators, and Connectors	9
G. Loading and Playing a Disc	10
H. Setup.....	11
I. Basic Operation	20
J. Menu	21
K. Display.....	21
L. Playing Audio CDS	27
M. Playing MP3 Discs	29
N. Playing JPEG files	31
O. Connecting to a TV or another monitor	33
P. Rechargeable Battery Installation and Use	34
Q. Troubleshooting	36
R. Installation and Using.....	38
S. Game Instructions	39
T. Specifications	46

A. Introduction

Thank you for choosing the D1812PKG. The main features include a 8" Wide Screen (16:9 Aspect Ratio) Liquid Crystal Display (LCD) monitor, a DVD player and a game controller with 30 built-in games. The unit applies the latest state of the art electronics and is designed for use in hotels, offices, vehicles or your home. The unit is constructed to provide years of reliable, trouble-free service, and is compact so that you can take it with you anywhere and is designed for quick and easy installation. Please read the entire instruction manual supplied with this product prior to use. The documentation will assist you in installing the system properly to obtain the best equipment performance. Please save this manual for later use.

B. Cautions and Warnings

1. Placement

To prevent fire or electric shock, do not expose this appliance to rain or moisture. Do not place the set on an unstable cart, stand, tripod, bracket or table to prevent it from falling. Keep the unit away from strong magnets, heat sources, direct sunlight, excessive dust. If the unit is brought directly from a cold to a warm location, moisture may condense inside the unit. When you move it from a cold to a warm location, wait for about one hour before operating the unit, or remove the disc and leave the unit turned on until the moisture evaporates.

2. Installation

Ensure that the D1812PKG is installed in accordance with the instructions and illustrations provided in this manual.

3. Caution

Do not push objects of any kind into the unit through openings; do not spill or spray liquid of any kind on or in the system (this may result in a fire or electric shock). Do not place anything heavy on the unit. To ensure proper ventilation and proper operation, never cover or block the slots and openings with a cloth or other material.

Keep the unit away from an open flame such as, fire, candle etc,. It is hazardous to replace the battery incorrectly. Replace the battery only with the same or equivalent type. In order to protect the environment please dispose of the battery properly. Do not use the unit in temperatures higher than 104 degrees Fahrenheit or 40 degrees Celsius.

4. *Disassemble*

Do not attempt to disassemble the cabinet. There is a risk of electric shock and/or exposure to Laser Radiation. Contact qualified service personnel if your system needs repair.

5. *Cleaning Unit*

When cleaning, make sure the system is unplugged from the power source. Do not use liquid cleaners or aerosol cleaners. Use a cloth lightly dampened with water for cleaning the exterior of the system only.

6. *Disc*

Do not use irregularly shaped discs such as heart or star-shaped discs as they may cause the unit to malfunction. Do not stick paper, tape or glue on the disc. Do not expose the disc to direct sunlight or heat sources. Do not touch the surface of disc. Handle the disc by its edge. Clean the disc by wiping the disc from the center out with a cleaning cloth. Remove the disc from the unit and store it in its case after playing. Some playback operations of discs may be intentionally fixed by software producers. Since this unit plays discs according to the disc contents the software producers designed, some playback features may not be available. Also refer to the instructions supplied with the discs.

7. *Regional Coding*

Both the DVD player and disc are coded by region. These regional codes must match in order for the disc to play. If the codes don't match, the disc won't play. This unit's code is region 1. DVD's with other regional codes cannot be played in this unit.

C. Contents

1. 1 x 8" LCD Monitor & DVD Player
2. 1 x AC to DC Adapter
3. 1 x Remote Control with battery (CR2025)
4. 1 x Instruction Manual
5. 1 x Audio/Video Adapter Cable
6. 1 x DC Power Adapter
7. 1 x Rechargeable Battery
8. 1 x Y Connector (for headphones)
9. 2 x Wired headphones
10. 1 x Bag W/ Straps
11. 1 x Game Controller

D. Powering and installation

1. **Powering the system indoors** (Refer to Figure 1)

Plug one end of the AC to DC adapter into the DC 9V jack on the left side of the main unit, then plug the other end into the 120V AC power outlet.

2. **Powering the system in a car** (refer to Figure 1)

Plug one end of the DC Power adapter into the DC 9V jack on the unit, then plug the other end into the vehicle power outlet.



Figure 1

E. Vehicle Installation

Make sure that the unit is placed into the bag with the clear plastic covering on the right side of the unit. Load the disc into the DVD compartment and then adjust the retaining cord across the top portion of the unit. If you are installing the bag onto the seatback you may need to use the Seat Standoff attached to the back of the mounting bag to obtain the proper viewing angle as shown in Figure 2

1. Installing the System onto the seat back in a car

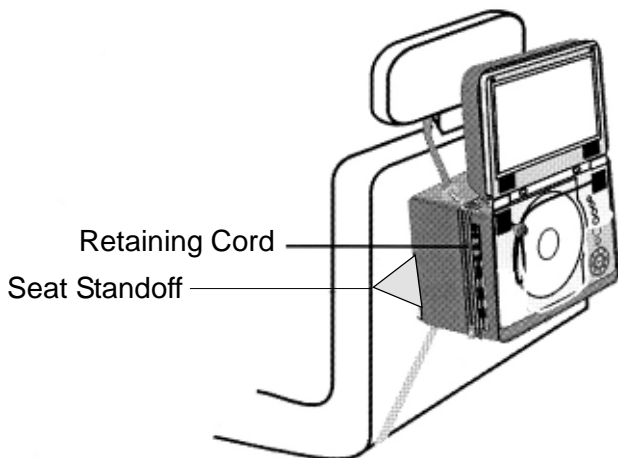

Figure 2

- 1). Take one of the supplied straps from the carrier bag. Connect the latch to one of the upper metal rings on the mounting bag. Connect the “S” hook to the other upper metal ring and place the loop over the headrest. Adjust the strap until the bag is firmly secured.
- 2). Take another strap from the carrier bag, and connect the latch to the lower metal ring on the left side of the bag. Attach the “S” hook to the same ring after looping the strap around the seat rail. Repeat this process for the right side. In some vehicles, it may be necessary to attach the “S” connector to the rail directly, as it may not be long enough to reach back to the ring.
- 3). Adjust the straps tightly so that the bag is secured.

2. Installing the system between the driver/passenger seat
(Refer to Figure 3)

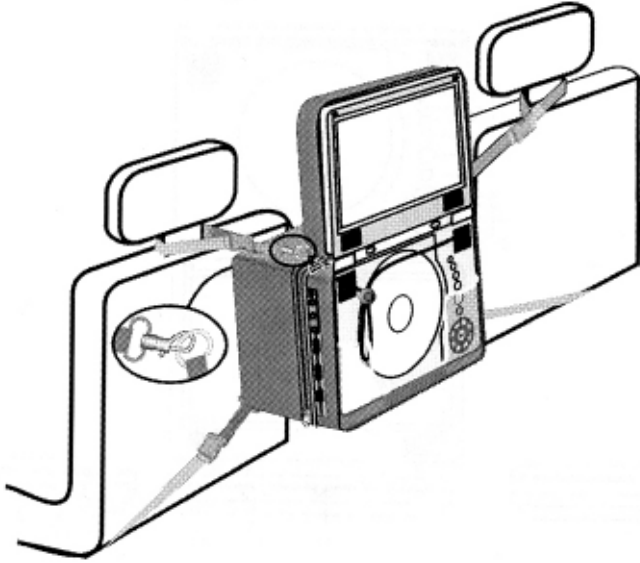

Figure 3

- 1). Take one strap and connect the latch to the upper metal ring on the left side of the bag. Attach the “S” hook to the same ring after looping the strap around the headrest of the driver’s seat. Repeat this process for the right side (Passenger Seat).
- 2). Take another strap and connect the latch to lower metal ring on the left side of the bag. Attach the “S” hook to the same ring after looping the strap around the driver’s seat rail. Repeat this process for the right side. In some vehicles, it may be necessary to attach the “S” connector directly to the rail, as it may not be long enough to reach back to the ring.
- 3). Adjust the straps tightly so that the bag is secured.

F. Controls, Indicators, and Connectors

1. Unit View (Refer to Figure 4)

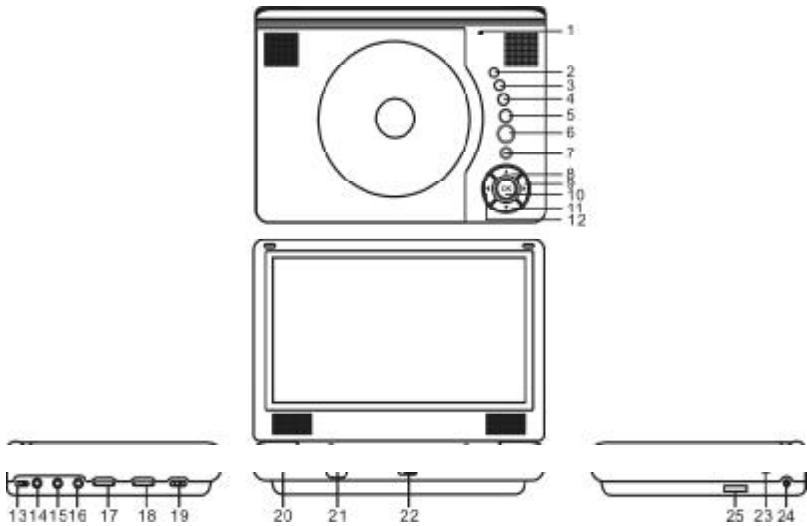

Figure 4

- | | |
|------------------------------|--------------------------------|
| 1) LCD Panel Shut Off Switch | 13) AV IN/OUT Switch |
| 2) Wide Button | 14) Audio Jack |
| 3) Stop Button | 15) Video Jack |
| 4) Previous Button | 16) Headphone Jack |
| 5) Next Button | 17) Volume Up/Down Control |
| 6) Play Button | 18) Brightness Up/Down Control |
| 7) Menu | 19) Power On/Off Switch |
| 8) Up Button | 20) Power LED |
| 9) Right Button | 21) Remote Control Sensor |
| 10) OK/Enter Button | 22) Open Button |
| 11) Down Button | 23) Charge LED |
| 12) Left Button | 24) DC 9V Input Jack |
| | 25) E Port |

2. Remote Control View (Refer to Figure 5)

- 1) Setup Button
- 2) Previous Button
- 3) Reverse Scan Button
- 4) UP/DOWN/LEFT/RIGHT/
ENTER Buttons
- 5) Numeric Keypad
- 6) Play Button
- 7) Pause Button
- 8) Audio Button
- 9) Stop Button
- 10) Menu Button
- 11) Forward Button
- 12) A-B Repeat/1/All
Button
- 13) Next Button
- 14) Subtitle Button
- 15) Zoom Button
- 16) Display Button

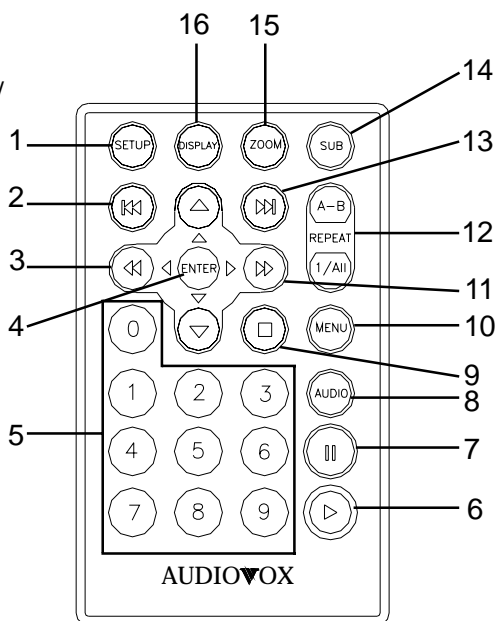

Figure 5

G. Loading and Playing a Disc

- a. After connecting power to the unit, turn on the “DVD player” with the power switch. The power indicator will light.
- b. Open the disc tray by sliding the OPEN button in the direction of the arrow and place a disc into the tray with the label side facing up.
- c. Close the tray by pressing the area marked “PRESS” on the disc door. The unit will read the disc and start playing.
- d. Rotate the BRIGHTNESS and VOLUME controls to adjust the brightness and the volume to the desired levels.
- e. To stop playing a disc, press STOP.

H. Setup

Press 'SETUP' to display the Main screen of the Setup Menu on the screen. Press 'SETUP' again to exit the Setup Menu and the unit will resume it's last playback mode.

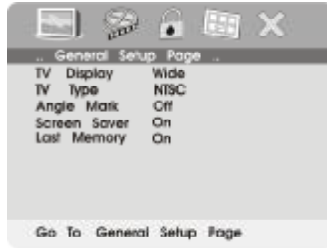

Main Setup Menu Screen

- 1) Press "SETUP", the 'General Setup Page' will be displayed.
 - a). Select 'TV Display' using the UP/DOWN button, and then press RIGHT to enter the submenu. Select the TV display mode desired using UP/DOWN, and press ENTER to confirm the setting. Press LEFT to return.
 - * Normal/PS: When the player is connected to a normal TV, and a wide picture is shown on the full screen.
 - * Normal/LB: When the player is connected to a normal TV, and a wide picture is shown on the screen with a black strip at both the top and bottom of the screen.
 - * Wide: When the player is connected to a wide screen TV, a wide picture is shown on the full screen.

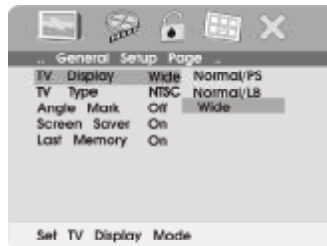

TV Display Screen Display

d). Select 'Screen Saver' using the UP/DOWN button, and then press the RIGHT button to enter the submenu. Choose Screen Saver on or off using the UP/DOWN button and then press ENTER to confirm the setting. Press the LEFT button to return.

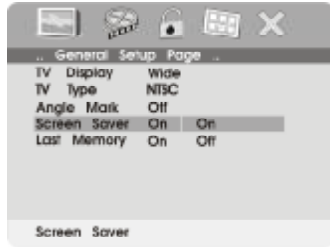

Screen Saver Screen Display

*On: Enables screen saver

*Off: Disables screen saver (off)

***NOTE:** The DVD player will enter the Screen Saver mode after approximately five minutes if the same image remains on the screen.

e. Select "Last Memory" by using the UP/DOWN button.

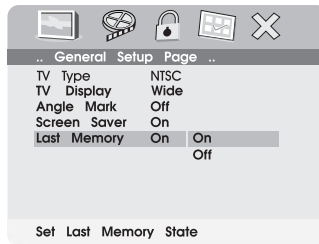

Last Memory Screen Display

*on: The unit will return to the last position on the disc.

*off: The unit will not return to the last position on the disc.

Note: The Last position memory function will only work when the power is on.

b).Select 'TV Type' using the UP/DOWN button, and then press the RIGHT button to enter the submenu. Choose TV Type using the UP/DOWN button and then press ENTER to confirm the setting. Press the LEFT button to return.

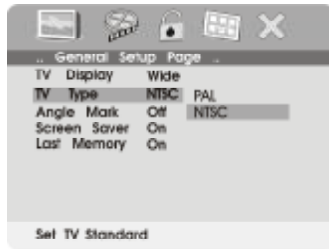

TV Type Screen Display

c).Select 'Angle Mark' using the UP/DOWN button, and then press the RIGHT button to enter the submenu. Choose Angle Mark on or off using the UP/DOWN button and then press ENTER to confirm the setting. Press the LEFT button to return.

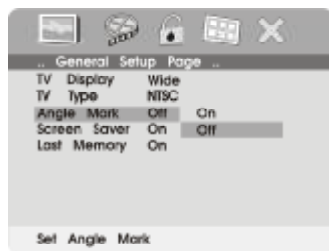

Angle Mark Screen Display

* On: The screen will show the angle mark icon. (*If an angle option is available).

* Off: The screen will not display the Angle Mark

2) Select the “Video Quality Setup” page by using the LEFT/RIGHT buttons. Press “Enter” to enter the video quality set up page.



Main SETUP Menu VIDEO QUALITY

a).Select “Brightness by using the UP or DOWN buttons, then press “Enter”. You can change the Brightness by pressing the LEFT or RIGHT buttons. To exit “Brightness Setting”, press “Enter” again to return to the main Menu.



BRIGHTNESS Screen Display

b).Select “Contrast” by using the UP or DOWN buttons, then press “Enter”. You can adjust the Contrast by pressing the LEFT or RIGHT buttons. To exit “Contrast Setting”, press “Enter” again to return to the main menu.



CONTRAST Screen Display

c).Select “Hue” (Tint) by using the UP or DOWN buttons, then press “Enter”. You can adjust the Hue by pressing the LEFT or RIGHT buttons.



HUE (Tint) Screen Display

To exit “Hue” (Tint) Setting, press “Enter” again to return to the main Menu.

d).Select “Saturation” (color) by using the UP or DOWN buttons, then press “Enter”. You can adjust the Saturation by pressing the LEFT or RIGHT buttons.

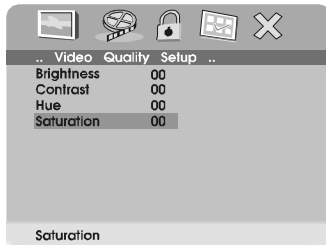

SATURATION (Color)Screen Display

To exit “Saturation” (color), press “Enter” again to return to the main Menu.

3).With no disc inside the player select “password” using the LEFT or RIGHT buttons, press ‘ENTER’ to enter the password setup page, then press the RIGHT button to enter the submenu .



PASSWORD CHANGE Menu

Press ‘ENTER’ to enter the Password Change Page. Input the Old Password or the Default Password, the New Password, and the Confirmed New Password. Press ‘ENTER’ to confirm the change.



PASSWORD VERIFY Input Screen Display

NOTE: The Default Password is **3308**. This password is always effective even after you have selected your own password and changed it. To avoid the possibility of others using the default password to set the parental level and change the password, you can record this default password in another area and delete it from this manual. Some discs can be limited depending on the age of users while some discs cannot.

- 4). With no disc in the player select 'PREFERENCES' using the LEFT or RIGHT buttons, then press 'ENTER' to enter the preferences page.
- a. Select 'AUDIO' using the DOWN button, then press 'RIGHT' to enter the submenu. Select the audio language you desire using the UP or DOWN buttons, then press 'ENTER' to confirm the setting. Press LEFT to return.

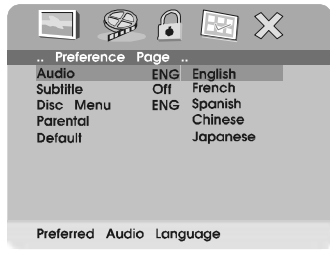

Preference Audio Language

- b. Select 'SUBTITLE' using the DOWN button, then press RIGHT to enter the submenu. Select the desired subtitle language or SUBTITLE OFF using the UP or DOWN buttons , then press 'ENTER' to confirm the setting. Press 'LEFT' to return.

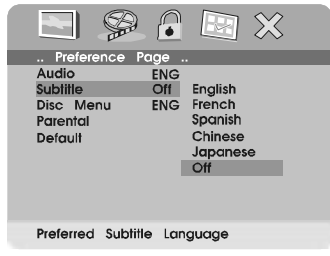

Preference SUBTITLE LANGUAGE

Note: Language and subtitle selection is only available for discs that are recorded in the above listed languages. If the selected, language is not available, the player will play and display on the screen the original recorded language contained in the disc.

- c. Select 'DISC MENU' using the DOWN button, then press 'RIGHT' to enter the submenu. Select the Disc Menu Language you desire using the UP or DOWN buttons, then press 'ENTER' to confirm the setting. Press 'LEFT' to return.



Preference DISC MENU LANGUAGE

- d. Select 'PARENTAL' using the DOWN button, then press RIGHT to enter the submenu.

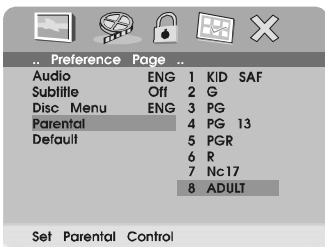

PARENTAL Preference Screen Display

Select the parental level you desire using the UP or DOWN buttons for discs with lock-out feature. These are listed from the lowest level (1 Kid Safe) to the highest level (Adult). Enter a 4 digit password, then press 'ENTER' to confirm the parental level setting.

NOTE: The level of 8 Adult is the factory default.

- e. Select 'DEFAULT' using the DOWN button, then press RIGHT to enter the submenu. Press ENTER to make all of the settings return to the factory-set mode.

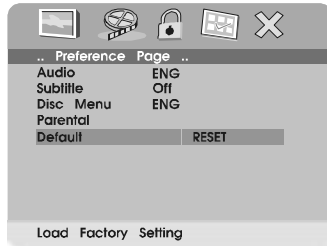

Loading Factory Setting

NOTE: The parental setting is not affected by the default reset function.

I. Basic Operation

POWER	Turn the unit on/off
OPEN	Remove/load the disc
PLAY	Start Play/Execute item or setting
SLOW	Play at 1/2, 1/4, 1/8 or 1/16 times speed
PAUSE	Still Picture
STOP	(1 time) Stop at the present playing point / (2 times) Stop playing
NEXT	Go to the next chapter, track or scene during play back
PREVIOUS	Go back to the previous chapter, track or scene during play back
FORWARD	Scan forward at 2, 4, 8, 16 or 32x times speed
REVERSE	Scan backward at 2, 4, 8, 16 or 32x times speed
LEFT/RIGHT/UP/DOWN	Used for Menu Navigation
ENTER	Execute item or confirm setting
NUMBERS	Select item or setting
RETURN	Return
MENU	Display the main menu of the disc
REPEAT	Repeat playing title, chapter, or track
A-B	Repeat a specific portion from point A to point B of the disc
DISPLAY	Display information (title, chapter, track, time, etc.).
ANGLE	Change the viewing angle of the scene
SUBTITLE	Select the subtitle language and turn it on/off
AUDIO	Select the audio language
ZOOM	Enlarge an image to 2, 3, or 4 times the original size.
SETUP	Display the setup menu to select and set items, and exit the setup menu.

J. MENU

A DVD is divided into sections called titles and chapters. When you play a DVD, a root menu of the disc will appear on the screen of your TV or Monitor. The contents of the menu vary from disc to disc. Press MENU during playback to display the DVD root menu. Some DVDs only allow you to select disc playback options using the DVD root menu.

K. DISPLAY *(Display contents vary from disc to disc.)*

1. PLAYING TIME AND REMAINING TIME

- a. During playback press the 'DISPLAY' button to display the current Title Number (1), the total Number of Titles (2), the current Chapter Number (3), the total Number of Chapters (4), and the Playing elapsed Time for the title (5). The heading will disappear automatically after 3 seconds if no buttons are pressed.

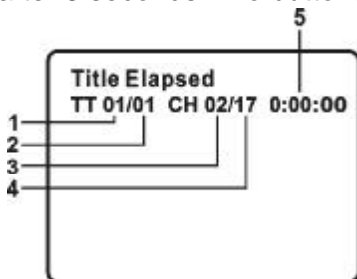

Title, Chapter Number, and Time Screen Display

- b. Press 'DISPLAY' again to display the Remaining Time of the title. The heading will disappear automatically in 3 seconds.

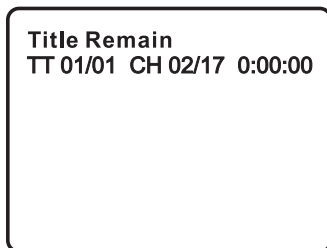

Title Remaining Time Screen Display

- c. Press 'DISPLAY' a 3rd time to display the Elapsed Time for the chapter. The heading will disappear automatically in 3 seconds.

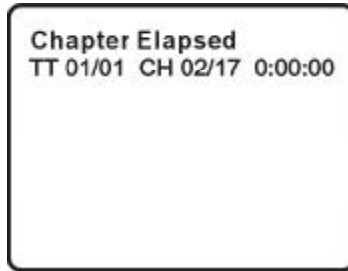

Chapter Elapsed Time Screen Display

- d. Press 'DISPLAY' a 4th time to display the Remaining Time for the chapter. The heading will disappear automatically in 3 seconds.

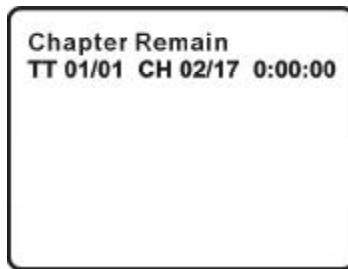

Chapter Remaining Time Screen Display

- e. Press 'DISPLAY' a 5th time to exit, 'DISPLAY OFF' will be displayed and will disappear automatically in 3 seconds.

2. ANGLE

During playback of a disc, press 'ANGLE' to display the available angles for discs containing multi-angles*, with the current angle number (1) and the total number of angles (2) displaying. Press 'ANGLE' to select another angle, then press again to exit and return to the normal viewing angle. The angle display will disappear automatically if the 'ANGLE' button is not pressed again within 3 seconds.

***NOTE:** Not all discs contain this feature.



Angle Screen Display

3. SUBTITLE

During disc playback press 'SUBTITLE' to select the subtitle language you desire*, with the current Subtitle Language Number (1) and the total Number of Subtitle Languages (2) displayed. If there are multiple languages press 'SUBTITLE' again to select another subtitle language. To turn subtitles OFF, press the 'SUBTITLE' button until 'SUBTITLE OFF' is displayed. The Subtitle display will disappear automatically if the 'SUBTITLE' button is not pressed again within 3 seconds.

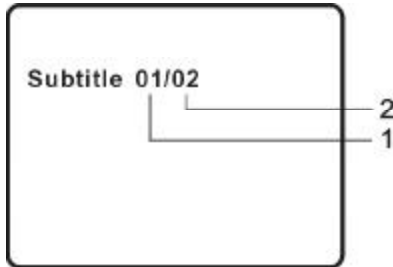

Subtitle Screen Display

* Some DVDs only allow access to this function through the DVD root menu.

4. **AUDIO**

During playback press 'AUDIO' to select the audio language you desire*, with the current Audio Channel Number (1) and the total number of Audio Channels (2) displayed. Press AUDIO again to select another audio language. The audio display will disappear automatically if the 'AUDIO' button is not pressed within 3 seconds.

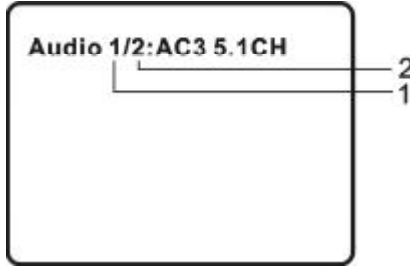

Audio Language Screen Display

* Some DVDs only allow access to this function through the DVD root menu.

5. **ZOOM**

During playback press 'ZOOM' to enlarge the picture by 2x, 3x or 4X. (1) Press "zoom" one time, the picture will be enlarged 2X. (2) Press "zoom a "second time, the picture will be enlarged 3X. (3) Press "zoom" a 3rd time, the picture will be enlarged 4X. (4) Press "zoom" a 4th time, the picture will return to normal size.

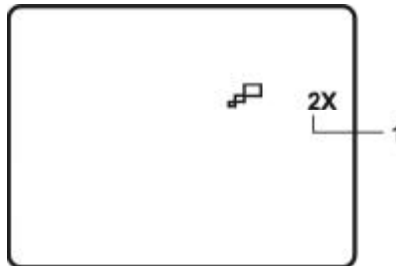

ZOOM Screen Display

6. A-B REPEAT

- a. During playback press 'A-B' once to set the Starting Point A.



A-B Repeat Starting Point Screen Display

- b. Press 'A-B' a second time to set the Ending Point B and the player will repeatedly play the part between Point A and Point B.

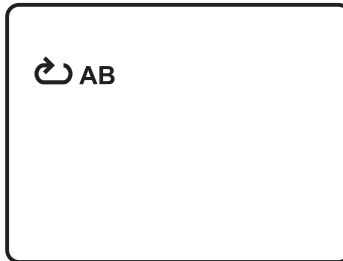

A-B Repeat Ending Point Screen Display

- c. Press A-B a third time to cancel A-B repeat and resume normal playback.

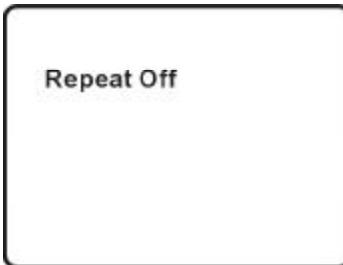

A-B Repeat Off Screen Display

7. REPEAT

- a. During playback press 'REPEAT' once to repeatedly play the current chapter.

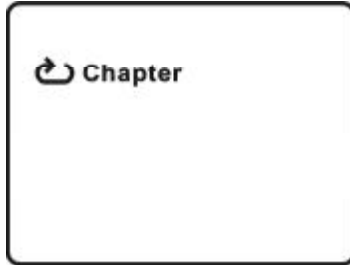

Chapter Repeat ON Screen Display

- b. During playback press 'REPEAT' twice to repeatedly play the current title.



Title Repeat ON Screen Display

- c. During playback press 'REPEAT' three times to repeat All Chapters and Titles.



All Repeat ON Screen Display

d. Press "REPEAT" a 4th time, to resume normal playback.



Repeat Off Screen Display

L. PLAYING AUDIO CD's

When playing an audio CD press the DISPLAY button on the remote to view playback time information. The options below show you what information is available using this function.

a. The current track and playing time of that track will be displayed on the screen.

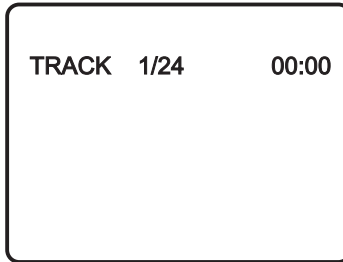

SINGLE ELAPSED Screen Display

b. Press 'DISPLAY' one time and *SINGLE REMAIN* appears along with the current track playing and the amount of time left.



SINGLE REMAIN Screen Display

- c. Press 'DISPLAY' two times and *TOTAL ELAPSED* appears along with the current track playing and the total time that the CD has been playing.

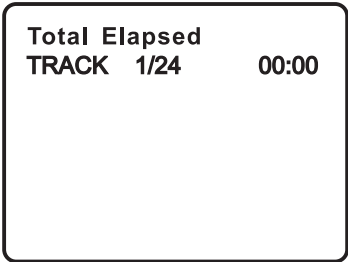

TOTAL ELAPSED Screen Display

- d. Press 'DISPLAY' three times and *TOTAL REMAIN* appears along with the current track playing and the amount of time remaining on the CD.

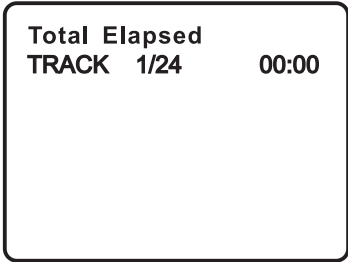

TOTAL REMAIN Screen Display

- e. Press 'DISPLAY' four times and "*DISPLAY OFF*" will appear momentarily then disappear. The CD time Information will not be displayed.

USING THE REPEAT FEATURE

The default mode for the Repeat feature is OFF. Pressing REPEAT consecutively changes the repeat options:

- *TRACK*- repeats the track that is playing.
- *ALL*- repeats the disc that is playing.
- *OFF*

As you toggle through the options, the repeat option changes. The selected repeat option loops repeatedly until you turn it off.

M. PLAYING MP3 DISCS

MP3 is a format for storing digital audio. An audio CD-quality song is compressed into the MP3 format with very little loss of audio quality while taking up much less disc space. CD-R /RW discs that have been encoded in MP3 format are compatible with this system.

Playback modes:

FOLDER (normal playback)

SINGLE

REPEAT ONE (repeat playback of a song)

REPEAT FOLDER (repeat playback of a specific folder)

Insert an MP3 CD, the DVD player will initialize the disc and the directory (folder) will be shown on the screen.

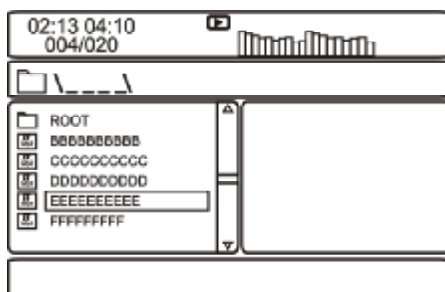

MENU Screen Display

When an MP3 disc is inserted into the unit, the menu screen appears automatically. You can use the menu screen to change folders and songs. The system plays the songs in the order they were burned onto the disc.

1. Press the ▲ or ▼ button to choose a folder from the folder list on the left side of the screen.
2. Press ENTER to select the highlighted folder. The songs available under the folder will be listed.
3. Press STOP and use ▲ or ▼ button to choose a song from the list. Press ENTER to select and begin playback of the highlighted song.

Use the **▶▶** (NEXT) button to move to the next song. Press the **◀◀** (PREVIOUS) button to move to the beginning of the previous song.

Using The Repeat Feature

The default mode for the Repeat feature is OFF. Pressing REPEAT consecutively changes the repeat options:

- SINGLE
- REPEAT ONE
- REPEAT FOLDER
- FOLDER

Pressing REPEAT the 5TH time will resume normal playback. As you toggle through the options, the repeat option changes. The selected repeat option loops repeatedly until you turn it off.

NOTE

- “  ” icon in front of a file name indicates that this is a folder, not an MP3 file.
- “MP3” icon in front of a file name indicates that this is a MP3 file.

N. Playing JPEG file

- 1) Load the JPEG Disc into tray.
- 2) Select JPEG file by pressing “UP/DOWN” button.
- 3) You can preview the JPEG file by pressing “Play” or “ENTER”.
- 4) Pressing the “Left Key“ will rotate the picture counterclockwise.
Pressing the “Right Key“ will rotate the picture clockwise.
- 5) When browsing the photos, you can reverse the photo horizontally by pressing “Up” key, or you can reverse the photos vertically by pressing “Down” key.
- 6) When you browse the JPEG file, pressing “display” will change the refresh mode below.
 - a. Press “display” first time, “WIPE TOP” will display on the screen, the picture will refresh from top to bottom.
 - b. Press “display” 2nd time, “WIPE BOTTOM” will display on the screen, the picture will refresh from bottom to top.
 - c. Press “display ” 3rd time, “WIPE LEFT” will display on the screen, the picture will refresh from left side to right side.
 - d. Press “display ” 4th time, “WIPE RIGHT” will display on the screen, the picture will refresh from right side to left side.
 - e. Press “display” 5th time, “DIAGONAL WIPE LEFT TOP” will display on the screen, the picture will refresh from left top to right bottom.
 - f. Press “ display ” 6th time, “DIAGONAL WIPE RIGHT TOP” will display on the screen, the picture will refresh from right top to left bottom.
 - g. Press “display ” 7th time, “DIAGONAL WIPE LEFT BOTTOM” will display on the screen, the picture will refresh from left bottom to right top.
 - h. Press “display ” 8th time, “DIAGONAL WIPE RIGHT BOTTOM” will display on the screen, the picture will refresh from right bottom to left top.

- i. Press “display” 9th time, “EXTEND FROM CENTER H” will display on the screen, the picture will refresh from horizontal center to both sides.
 - j. Press “display” 10th time, “EXTEND FROM CENTER V” will display on the screen, the picture will refresh from vertical center to both sides.
 - k. Press “display” 11th time, “COMPRESS TO CENTER H” will display on the screen, the picture will refresh from top and bottom to center.
 - l. Press “display” 12th time, “COMPRESS TO CENTER V” will display on the screen, the picture will refresh from right and left to center.
 - m. Press “display” 13th time, “WINDOW H” will display on the screen, the picture will refresh from four window’s top side to bottom side.
 - n. Press “display” 14th time, “WINDOW V” will display on the screen, the picture will refresh from four window’s left side to right side.
 - o. Press “display” 15th time, “WIPE FROM EDGE TO CENTER” will display on the screen, the picture will refresh from 4 edges to center.
- 7) When previewing the file, pressing “ANGLE, SUBTITLE, AUDIO, NUMBER, AB, RETURN, REW/FF, SLOW” a hand icon will appear on the display meaning that these options are not available.
 - 8) Press “Stop” to browse the JPEG file, “SLIDE SHOW MENU” will be displayed on the screen.
 - 9) When browsing the picture, press “Stop” and thumbnail size pictures will be displayed. You can select the picture you desire by using the UP/DOWN/LEFT/RIGHT/ENTER key.
 - 10) Press “Play” or “OK”, to preview the picture.

O. Connecting to a TV or another monitor (Refer to Figure 6)

You can also connect the DVD player to a TV to enjoy high quality stereo audio and video on another monitor. To connect the DVD player to a monitor requires the purchase of an audio/video cable. The cable is readily available at most electronic retailers. The cable consists of three RCA jacks with the colors red and white corresponding to right and left audio channels and the yellow RCA connector is the video signal. The purchased cable can then be connected to the supplied AV adapter cable which then interfaces to the DVD player.

1. Connect one end of the audio/video adapter cable's black (1/8" stereo plug) plug into the unit's DVD AUDIO OUT jack, and connect the other end to the AUDIO INPUT jacks on your TV or Monitor (white = left channel, red = right channel).
2. Connect the audio/video adapter cable's yellow plug into the DVD VIDEO OUT jack on the back of the unit, and the other yellow plug to the VIDEO INPUT jack on your TV or Monitor.

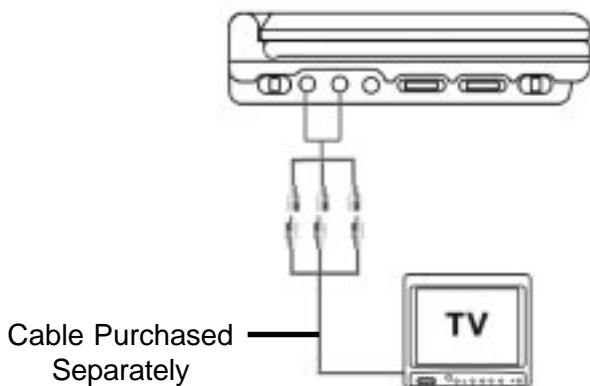

Figure 6

P. Rechargeable Battery Installation and Use

The player utilizes a set of long-life Ni-Mh batteries for a portable power supply. Ni-MH batteries feature high storage capacity and low level of degradation. This means the Ni-MH batteries do not have “Memory Effect” and thus can be recharged safely regardless of whether the battery is fully or only partially discharged. The battery must be charged at least 8 hours prior to first use.

NOTE: If you plan not to use the battery for an extended period of time (one week or longer), we recommend that you first fully charge the battery and store it away properly. For longer periods of storage, please recharge the battery at least once every two months to maintain the battery in optimum condition. Under no circumstances short the battery terminals, store the battery in a metal container, or leave the battery in a humid or damp environment. Ideally, store the battery in an airtight container with desiccant or other dehumidifying agent. Each full recharge takes approximately five-hours and one full charge can provide power to the player for approximately 3 hours.

During recharge, the red indicator will stay on. Once fully recharged, the red light will turn off. At this point you may remove the wall plug and stop charging.

Precautions related to Battery Recharge:

1. Once the battery is fully discharged, immediately recharge (regardless of whether you plan to use battery or not) in order to maximize battery life.
2. To charge the battery, please connect the power jack directly into the DVD player and leave the POWER switch in the off position.

Using and Maintaining your Rechargeable Batteries

1. Please make sure you always use **only** the AC adapter included with the player to recharge your batteries.

- 2.Recharge efficiency will degrade when environmental temperatures drop below 50°F (10°C) or exceed 95°F (35°C).
3. Please remove the battery from the player and store it properly if the player is not to be used for long time. During this period , please recharge the battery at least once every two months to maintain the battery in optimum condition.

Installing the Battery Pack:

1. First, make sure the player is in “Stop” mode and that the AC power supply has been disconnected.
2. Close the player cover.
3. Align the guide pins on the battery with the holes on the back of the unit. Then push the battery towards the rear of the player until it locks into position. The lock position is indicated by a click. The battery will fit snugly to the player.



Figure 7. Installing the DVD Player Battery

Removing the Battery Pack:

1. First, make sure the player is in “Stop” mode and the AC power supply has been disconnected.
2. Press the release button on the left side of battery.
3. Pull the battery from the unit.

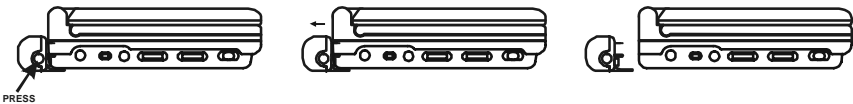



Figure 8. Removing the DVD Player Battery

Q. Troubleshooting

PROBLEM	SOLUTION
No sound or distorted sound	<ul style="list-style-type: none">• Make sure the DVD player is connected properly. Make sure all cables are securely inserted into the appropriate jacks.
Can't advance through a movie	<ul style="list-style-type: none">• You can't advance through the opening credits and warning information that appears at the beginning of movies because the disc is programmed to prohibit that action.
The icon () appears on screen	<p>The feature or action cannot be completed at this time because:</p> <ol style="list-style-type: none">1. The disc's software restricts it.2. The disc's software doesn't support the feature (e.g., angles)3. The feature is not available at the moment.4. You've requested a title or chapter number that is out of range.
Picture is distorted	<ul style="list-style-type: none">• The disc might be damaged. Try another disc.• It is normal for some distortion to appear during forward or reverse scan.
No forward or reverse scan	<ul style="list-style-type: none">• Some discs have sections that prohibit rapid scanning or title and chapter skip.• If you try to skip through the warning information and credits at the beginning of a movie, you won't be able to. This part of the movie is often programmed to prohibit skipping through it.

Troubleshooting (Cont)

PROBLEM	SOLUTION
IR sensor inoperative	<ul style="list-style-type: none">• Verify that the batteries in the remote are fresh.• Verify that the remote sensor eye is not obstructed.
Disc won't play	<ul style="list-style-type: none">• Check the type of disc you put into disc tray. This DVD player only plays DVD's audio CDs and MP3s.
Play starts, but then stops immediately	<ul style="list-style-type: none">• Both the unit and the disc are coded by region. If the regional codes don't match, the disc can't be played. This DVD player is Region Number 1.• The disc is dirty. Clean it.• Condensation has formed. Allow player to dry out.

R. INSTALLATION AND USE

Game Console

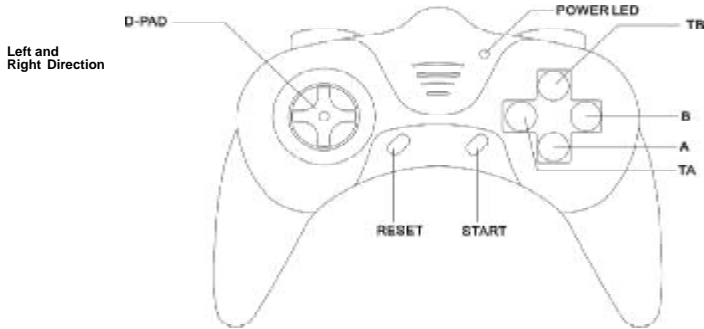

2. Installation

- 1) Turn the DVD player on then plug the jack from the game console into DVD's E Port. The controller POWER LED will light.
- 2) Slide the AV IN/OUT SWITCH on the DVD player to the IN position, and the game picture will be displayed on the screen.
- 3) To remove the game jack from the DVD player press the tabs on both sides of the jack and pull the jack from the DVD player.

3. How to use

- 1) Press the START button to enter the game selection mode. Use the left and right buttons on the directional pad to choose from the different games available. Press the start button to select the displayed game.
- 2) Press START to begin playing the selected game. Press START at anytime to pause the game.
- 3) Press RESET at anytime to return to the game select mode.

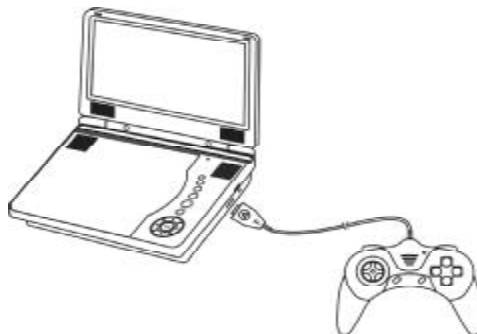

S. GAME INSTRUCTIONS

Features

1. 30 Built-in Games 2. Batteries Not Required

Runner Car You must race down a long city street before running out of fuel. Also you must watch out for other vehicles and road hazards. Pick up moneybags to get bonus points and P blocks to add more fuel.

D-Pad: Left and Right

A: Accelerate

B: Brake and stop

Motor Rally Race your motorcycle against the clock while avoiding other motorcycles and obstacles. If you reach the destination within the time limited, you'll advance to the next level.

D-Pad: Left and Right

A: Accelerate

B: Brake and stop

Ocean Quest You are racing your powerboat along the river while avoiding other boats. You can pick up T blocks for extra points. You move on to the next level when your boat reaches the destination within the time limit.

D-Pad: Left and Right

A: Accelerate

B: Brake and stop

Last Cabra Fly your fighter jet to defeat the enemy air force. Pick up the "S" to shoot scattering bullets. Watch out for the enemy battle station hidden on land. Defeat the enemy planes and win the game.

D-Pad: 8 directions

A: Fire

TA: Continuous fire

- Aero Engine** There is a fierce battle taking place in outer space. You are commanding a battleship flying in between planets fighting against the alien force. Pick up one blue power sphere for double fire, pick up two blue power spheres for triple fire.
- D-Pad: 8 directions
A: Fire
TA: Continuous fire
- Insect Chase** It's a beautiful sunny day. You must use your net to catch all the butterflies. Do not catch anything but butterflies or you will lose.
- D-Pad: 4 directions
- Pinball Track** Roll the pinball through the pipeline, while finding the key to open the gate along the way. Open all the locks to advance to the next round, but avoid falling into the holes along the way.
- D-Pad: 4 directions
- Birdie Nest** Balance the bird on the stick while catching its eggs. Sounds easy? Watch out for the bird droppings! If you get hit by the droppings 10 times, or the bird falls down, you lose!
- D-Pad: Left and Right
- Bingo Zap** Roll the ball into the lighting holes, being careful to avoid the wrong holes. You only have a certain amount of time to complete the task. The time is reduced for each subsequent level. Your remaining time and lives are shown on the screen.
- D-Pad: 8 directions

- Spin Ball Roll the ball down the track to reach the end of the maze within the given time. You must pick up the key to open the door to the next level. During the course you can also pick up objects to gain the extra points.
- D-Pad: 4 directions
- Star Ally Defeat all of the enemy fighter planes which get in your way. Pick up objects along the way.
- D-Pad: 8 directions
A: Fire
TA: Continuous fire
- Valiant
Rescue Huge insects have overrun the jungle. Your mission is to fly your fighter plane and eliminate them all. During the course you can pick up objects for extra points and features.
- D-Pad: 8 directions
A: Shoot at the flying objects
TA: Continuous shoot at the flying objects
B: Shoot at the ground objects
TB: Continuous shoot at the ground objects
- Zero Tiger A lab has created mutant pests that endanger the land. While facing multiple pests, your mission is to fly the fighter plane and eliminate them all. During the course you can pick up objects for extra points and features.
- D-Pad: 8 directions
A: Shoot at the flying objects
TA: Continuous shoot at the flying objects
B: Shoot at the ground objects
TB: Continuous shoot at the ground objects

Bolt fighter A fighter plane is engaging enemy fighter planes in the sky over land and sea . If you defeat the huge enemy fighter planes, you will advance to the next level. During the course you can pick up objects for extra points and features.

D-Pad: 8 directions

A: Fire

TA: Continuous fire

Dragon Fire Guide the dragon to the fireballs. The more fireballs you get, the longer the dragon becomes. If the dragon bumps the barriers, the edge, or itself, the game is over.

D-Pad: 4 directions

Excel Racing Gather all of the flags and return to the starting line before being tagged by one of the other racers. You have a limited supply of bombs that you can use to hold back the other racers. You will lose the game if you run into the bombs or collide with another other racer.

D-Pad: 4 directions

A, B: Position the bomb

Bump Car Jump your car to cross the missing sections of the road to get to your destination within the time allotted. You must avoid hitting other cars and rocks along the course. During the course you can pick up objects for extra points and features.

D-Pad: Left and Right

A: Accelerate

B: Jump

- Move Fun** There are several types of objects on the screen. Move an object to combine three or more of the same objects that are connected in a straight line.
- D-Pad: Select the objects
 A: Confirm the selection
- GP Race** Race your motorcycle along the city street. Pick up fuel along the way to increase the score and to keep from running out of gas. Avoid obstacles and other motorcycles. Reach your destination with the fuel allotted to advance to the next level .
- D-Pad: Left and Right
 A: Accelerate
 B: Normal Speed
- Space Castle** There are 4 rows of space monsters descending upon your colony. Your mission is to use your ground defenses to eliminate all space monsters before they reach the ground. There are 4 mushroom-shaped shelters to help protect you from the space monster's attack, but you cannot fire from behind the shelters. Hit the flying space ship for extra points.
- D-Pad: Left and Right
 A: Fire
- Ultra Doggy** Your dog is trying to cross busy streets. Along the way, the dog must collect keys scattered throughout the roads. Your dog also can pick up other helpful objects to increase its speed and gain extra points. Avoid cars, wagons and other obstacles. When the dog collects all keys, it can unlock the gates and advance to the next level.
- D-Pan: 4 directions

Elfland Destroy the monsters which are the same color as your elf to save Elfland. If you want to eliminate the other monsters, just jump into the corresponding paint bucket and color yourself the same color as the monster, otherwise you will lose.

D-Pad: 4 directions

A: Jump

TA: Continuous Jump

Jewel Master As the jewels fall in groups of three, try to line up the jewels of same color and shape. You must wipe out the jewels of the same shape and color before the game area is filled.

D-Pad: Left, Right and Down

A, TA: Change the Sequence of the three falling jewels

Sea War Control your warship to avoid the attack of the enemy force and eliminate as many enemy ships as possible.

D-Pad: Left and Right

A: Single Depth Charges

TA: Multiple Depth Charges

Catch Egg Catch the eggs, but beware, the evil birds also randomly throw down bombs. Avoid the bombs and you win.

D-Pad: Left and Right

Dart Champion The targets come from different directions. Shoot the targets down when they overlap the square shown on the screen. Try to get more points by shooting the targets within the time allotted.

Shoot the white targets and you will get 100 points.

Shoot the blue targets and you will get 300 points.

A: Shoot at the left square

B: Shoot at the right square

Paint Master Paint the entire runway without leaving any blank spaces within the time allotted but watch out for the enemy. You can move the baffle to block the enemies attack. If you cannot finish within the allotted time, the enclosed enemy will come out and leave his footprint on the screen.

D-Pad: 4 directions

Fish Catcher Fish are jumping randomly. You must catch the red fish, but avoid the black fish or you'll lose power.

D-Pad: Left and Right

A: Catch

TA: Continuous catch

Smart Escape Help the penguin to escape from the deep forest. On the way, you can collect magical weapons. If you eliminate all monsters, you will be granted one key. With the key, you can go to the next level.

Note: Every time you clear one level, you will get a password so that you can go directly to that level from the starting screen.

D-Pad: 4 directions

A: Fire

B: Use the weapon to hold back the monsters' attack

Wisom Select from 54 puzzles using the D-Pad. Place the puzzle pieces in the square so that each piece fits perfectly with the others.

D-Pad: Moves the piece

A: Rotates the piece

B: Selects and place the piece

Start: Abandon the selected piece

T. Specifications

Supported Media formats: DVD/CD/MP3

Color system: NTSC/PAL

Screen size: 8"

DVD video format: Horizontal 720 pixel, vertical 480 pixel (NTSC)

Frequency response: DVD (PCM 96 kHz/24 bits): 20 Hz to 44 Hz

DVD (PCM 48 kHz): 20 Hz to 22 kHz

CD: 20 Hz to 20 kHz

Video output: 1.0 Vp-p/75 Ohm, unbalanced

Video S/N: Better than 35 dB

Audio output: 2 x 0.4 W

Audio S/N: Better than 35 dB

Power source: DC 9V

Power consumption: 12 W

Operating temperature: 5~40°C (41~104°F)

Storage temperature: -20~60°C (4~140°F)

Operating humidity: 10~75%

Dimensions (W x H x D):8.03 X 5.91 X1.42inches

204 x 150 x 36.06 mm

Battery Type: Ni-Mh



AUDIOVOX
ELECTRONICS CORP.

90 DAY LIMITED WARRANTY

Applies to Audiovox Video Products

AUDIOVOX ELECTRONICS CORP. (the Company) warrants to the original retail purchaser of this product that should this product or any part thereof, under normal use and conditions, be proven defective in material or workmanship within 90 days from the date of original purchase, such defect(s) will be repaired or replaced with reconditioned product (at the Company's option) without charge for parts and repair labor.

To obtain repair or replacement within the terms of this Warranty, the product is to be delivered with proof of warranty coverage (e.g. dated bill of sale), specification of defect(s), transportation prepaid, to the Company at the address shown below.

This Warranty does not extend to the elimination of externally generated static or noise, to correction of antenna problems, to costs incurred for installation, removal or reinstallation of the product, or to damage to tapes, discs, speakers, accessories, or electrical systems.

This Warranty does not apply to any product or part thereof which, in the opinion of the Company, has suffered or been damaged through alteration, improper installation, mishandling, misuse, neglect, accident, or by removal or defacement of the factory serial number/ barcode label(s). THE EXTENT OF THE COMPANY'S LIABILITY UNDER THIS WARRANTY IS LIMITED TO THE REPAIR OR REPLACEMENT PROVIDED ABOVE AND, IN NO EVENT, SHALL THE COMPANY'S LIABILITY EXCEED THE PURCHASE PRICE PAID BY PURCHASER FOR THE PRODUCT.

This Warranty is in lieu of all other express warranties or liabilities. ANY IMPLIED WARRANTIES, INCLUDING ANY IMPLIED WARRANTY OF MERCHANTABILITY, SHALL BE LIMITED TO THE DURATION OF THIS WRITTEN WARRANTY. ANY ACTION FOR BREACH OF ANY WARRANTY HEREUNDER INCLUDING ANY IMPLIED WARRANTY OF MERCHANTABILITY MUST BE BROUGHT WITHIN A PERIOD OF 30 MONTHS FROM DATE OF ORIGINAL PURCHASE. IN NO CASE SHALL THE COMPANY BE LIABLE FOR ANY CONSEQUENTIAL OR INCIDENTAL DAMAGES FOR BREACH OF THIS OR ANY OTHER WARRANTY, EXPRESS OR IMPLIED, WHATSOEVER. No person or representative is authorized to assume for the Company any liability other than expressed herein in connection with the sale of this product.

Some states do not allow limitations on how long an implied warranty lasts or the exclusion or limitation of incidental or consequential damage so the above limitations or exclusions may not apply to you. This Warranty gives you specific legal rights and you may also have other rights which vary from state to state.

U.S.A. : AUDIOVOX ELECTRONICS CORPORATION, 150 MARCUS BLVD.
HAUPPAUGE, NEW YORK 11788 1-800-645-4994

CANADA : CALL 1-800-645-4994 FOR LOCATION OF WARRANTY STATION SERVING YOUR AREA

128-5556C

Free Manuals Download Website

<http://myh66.com>

<http://usermanuals.us>

<http://www.somanuals.com>

<http://www.4manuals.cc>

<http://www.manual-lib.com>

<http://www.404manual.com>

<http://www.luxmanual.com>

<http://aubethermostatmanual.com>

Golf course search by state

<http://golfingnear.com>

Email search by domain

<http://emailbydomain.com>

Auto manuals search

<http://auto.somanuals.com>

TV manuals search

<http://tv.somanuals.com>