

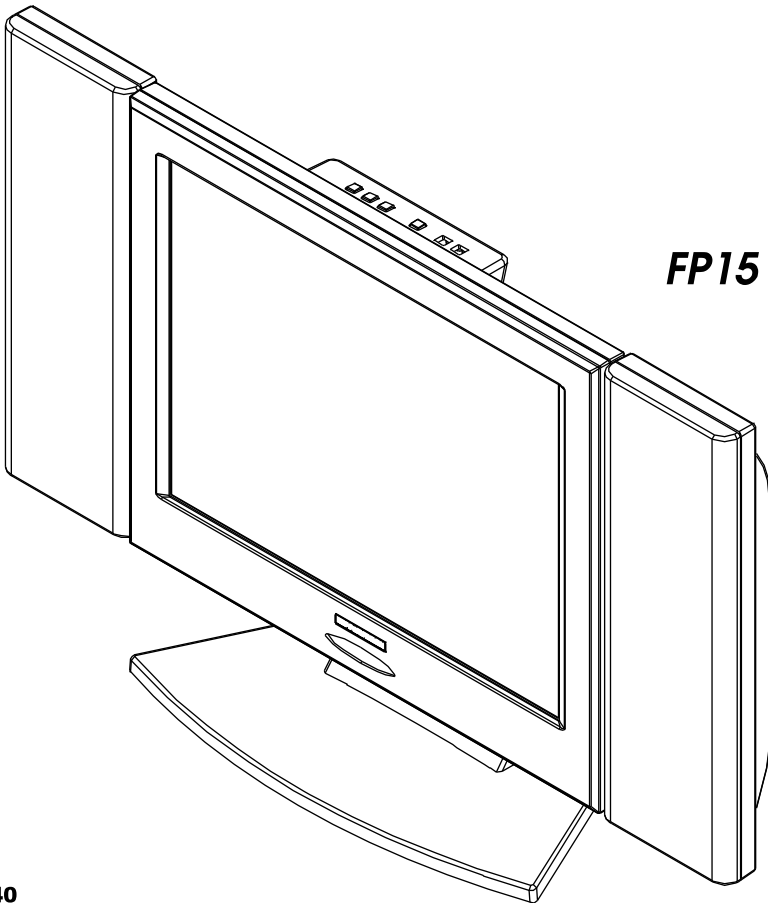

AUDIOVOX[®]
ELECTRONICS CORP.

FP1510 USER MANUAL

Color TFT-LCD TV/MONITOR



FP1510

128-6340

Safety Instructions

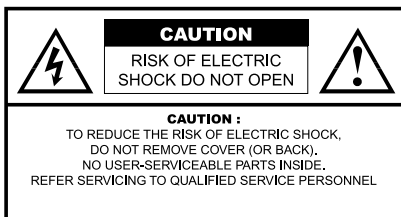

The Lightning flash with the arrowhead symbol within an equilateral triangle is intended to alert the user to the presence of uninsulated "DANGEROUS VOLTAGE" within the product's enclosure that may be of sufficient magnitude to constitute a risk or electric shock to persons.



The Exclamation point within an equilateral triangle is intended to alert the user to the presence of important operating and maintenance (servicing instructions in the literature accompanying the product).

Important Safety Instructions

- Read Instructions - All the safety and operating instructions should be read before the product is operated.
- Retain Instructions - The safety and operating instructions should be retained for future references.
- Heed Warnings - All Warnings on the product and in the operation instructions should be adhered to.
- Follow Instructions - All Operating and user instructions should be followed.
- Cleaning - Unplug this product from the wall outlet before cleaning. DO NOT use liquid cleaners or aerosol cleaners. Use damp Cloth for cleaning.
- Attachments - DO NOT use attachments not recommended by the product manufacturer they may cause hazards.
- Attaching The FP1510 TV To Wall - Use only the wall attachments recommended by the manufacturer. Unapproved attachments may be hazardous to you and the unit.
- Keep Away From Heated Areas - Do not place the FP1510 TV near heat; for example, near a radiator, stove, or other heating device.
- DO NOT use this apparatus near water. For example: Avoid placing it near bathtub, washbowl, kitchen sink, or laundry tub, in a wet basement, or near a swimming pool, etc.
- NEVER push objects or any kind into this unit through the cabinet slots as they may touch dangerous voltage points or short out parts that could result in a fire or electric shock. NEVER spill liquid of any kind on the LCD TV.
- DO NOT block any ventilation openings. Install in accordance with manufacture's instructions. Slots and openings in the cabinet and the back and bottom are provided for ventilation, and to ensure reliable operation of the LCD TV and to protect it from Overheating. These openings must NOT be blocked or covered. There should be at least 10cm of space from these openings. The openings should never be blocked by placing the LCD TV on a bed, rug or other similar surface. This product should NOT be placed in a built-in installation such as a bookcase unless proper ventilation is provided.

- Grounding or Polarization - This product may be equipped with a polarized alternating current line plug (a plug having one blade wider than the other). This plug will fit the power outlet only one way. This is a safety feature. If you are unable to insert the plug fully into the outlet, try reversing the plug. If the plug should still fail to fit, contact your electrician to replace your obsolete outlet. DO NOT defeat the safety purpose of the polarized plug.
- Power - Cord Protection - Power supply cords should be routed so that they are not likely to be walked on or pinched by items placed upon or against them. Pay particular attention to cords at plugs, convenience receptacles, and the point where they exit from the product.
Power Sources - This product should be operated only from the type of power source indicated on the rear panel. If you are not sure of the type of power supply to your home consult your product dealer or local power company.
- UL Safety Remark (AC Adaptor) - This product is intended to be supplied by a Listed power unit marked "class 2", "Limited Power Source" or "LPS" and output rated +12 Vdc, 3.0 A or equivalent statement provided in operating manual, if power unit is not provided with product.
- Power Sources - This product should be operated only from the type of power source indicated on the rear panel. If you are not sure of the type of power supply to your home consult your product dealer or local power company.
- Lightning - For added protection for this product during a lightning storm, or when it is left unattended and unused for this product during a lightning storm, or when it is left unattended and unused for long periods of time, unplug it from the wall outlet and disconnect the antenna or cable system. This will prevent damage to the product due to lightning and power - line surges.
- Power Lines - An outside antenna system should not be located in the vicinity of overhead power lines or other electric light or power circuits, or where it can fall into such power lines or circuits. When installing an outside antenna system, extreme care should be taken to keep from touching such power lines or circuits as contact with them might be fatal.
- Overloading - DO NOT overload wall outlets, extension cords or integral convenience receptacles as this can result in a risk of fire or electric shock.
- Damages Requiring Service - Unplug this product from the wall outlet and refer servicing to qualified service personnel under the following conditions.
 - (a) When the power-supply cord or plug is damaged.
 - (b) If liquid has been spilled, or objects have fallen into the product.
 - (c) If the product has been exposed to rain or water.
 - (d) If the product does not operate normally after following the operating instructions.
Adjust only those controls that are covered by the operating instructions as an improper adjustment of other controls may result in damage and will often require extensive work by a qualified technician to restore the product to its normal operation.
 - (e) If the product has been dropped or damaged in any way.
 - (f) When the product exhibits a distinct change in performance - this indicates a need for service.

- Replacement parts - When replacement parts are required, be sure the service technician has used replacement parts specified by the manufacturer or have the same characteristics as the original part. UNAUTHORIZED substitution may result in fire, electric shock or other hazards.
- Safety Check - Upon completion of any service or repair to this product, ask the service technician to perform safety checks to determine that the product is in proper operating condition.
Heat - The Product should be situated away from heat source such as radiators, heat registers, stoves or other products (including amplifiers) that produce heat.
- DO NOT place this product on an unstable cart, stand, tripod, bracket, or table.
The product may fall, causing serious injury to a child or adult, and serious damage to the product. Use only with a cart, stand, tripod, bracket, or table recommended by the manufacturer or sold with the product. Any mounting of this product should follow the manufacture's instructions, and should use a mounting accessory recommended by the manufacturer.
- Do not apply excessive force to operate the switch, control key and connector. Disconnect the power plug from the AC outlet before you move the unit.
- Do not touch the screen directly with your fingers. You may damage the screen, oil from your skin is difficult to remove.
- Do not apply pressure to screen. The LCD is very delicate.
- Please install the FP1510 in a cool, dry and clean area, avoid heat, or excessive vibration, dust, humidity, extreme cold and magnetic devices.

Important Information Regarding Use of Video Games, Computer, Captions or other Fixed Image Displays.

The extended use of a fixed image program material can cause permanent "Shadow Image" on the LCD Panel.

The background image is viewable on normal programs in the form of stationary fixed image.

This type of irreversible LCD panel deterioration can be limited by observing.

- Reduce the brightness/contrast setting to a minimum viewing level.
- DO NOT display the fixed image for extended periods of time.
- Turn the power off when not in actual use.

This product utilizes tin-lead solder, and has a fluorescent lamp containing a small amount of mercury. Disposal of these materials may be regulated in your community due to environmental considerations. For disposal or recycling information please contact you local authorities, or the Electronics Industries Alliance: <http://www.eiae.org>

CONTENTS

1. INTRODUCTION

Product Description	05
Product Features	06
Package Contents	07

2. SYSTEM SETUP

Top Panel & Remote Controller Function	08-11
Assembly and Connections	12
Input/Output Signal Connections	13-16

3. FP1510 OPERATING INSTRUCTIONS

TV and AV Manual Operating Instructions	17-30
Using the FP1510 as a Computer Monitor	31-36

4. REFERENCE

Display Modes	37
LCD Monitor Display Angle	37
Wall-mounting Operating Instructions	38
Cleaning	38

5. APPENDIX

Troubleshooting	39
Specification	40
Duplicate page by Design	41

1. INTRODUCTION

Product Description

Thank you for choosing the AUDIOVOX FP1510 TFT-LCD Color TV/Monitor and for your continued support and use of our products.

The FP1510 combines the features of a TV/MONITOR with a THIN FILM TRANSISTOR liquid crystal display (TFT-LCD).

This new generation of TFT-LCD incorporates a high quality display in a light weight module.

As such the unit has power-saving capabilities and emits no X-ray radiation. There are many benefits from this TFT-LCD namely comfort, safety, and environmental protection.

The FP1510 features a 15" color-active matrix, Thin-Film-Transistor (TFT) Liquid Crystal Display (LCD) to provide superior display performance. A maximum resolution of 1024x768 is ideal for displaying complex graphics and high definition images from your computer. Other outstanding features include freedom from video oscillations and selection of various choices of digital video and audio signal inputs.

You will get the feeling that the large-sized surface of operation with the Video - On - Video (VOV) feature, together with the high-quality 3D stereo speakers and remote high-level amplifiers connections, provides a coherent, top-of-the-line Audio and Video systems for viewing pleasure.

In addition the TFT-LCD display allows "Plug & Play" connection to your PC and has a built-in On Screen Display (OSD) functions that can operate from the convenience of a remote control.

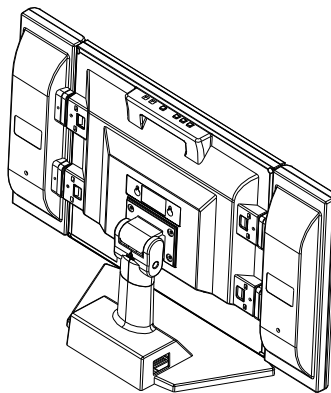
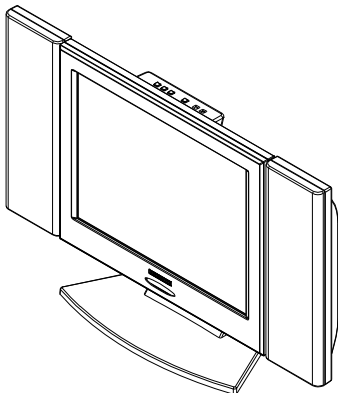
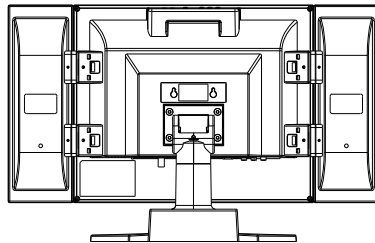
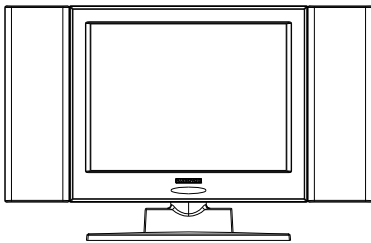

Product Features

- TFT-LCD screen connected with Computer support DDC1/2B for "Plug & Play" compatibility.
- 15-Inch high-resolution LCD Monitor which supports XGA 1024x768 resolution.
- Super 2,359,296 high-resolution pixels to enhance TFT-LCD definition.
- Super 350cd/m² high-brightness for picture enjoyment.
- Super wide viewing angle : Horizontal : 150° , Vertical : 130° .
- Super-low power consumption ; 50% more power saving than conventional TV.
- Super 9300° color temperature for LCD monitor choice of color.
- Internal subtitle decode function to precisely display multi-language capability
- CATV full-frequency channel receive capability
- AV-terminal input and S-Video inputs for high-quality pictures.
- 3D Stereo for realistic acoustics.
- Slim space-saving feature of up to 70% compared with a normal CRT monitor.
- Light design reduces weight by 15% compared with traditional TV monitor.
- High contrast ratio of 500 : 1 provides optimum clear image.
- Multi-digital input terminal provides a host of video and audio choices.
- Supports Video-On-Video ; VOV can display multiple video sources at one time.
- Intelligent screen image setting
Intelligent Window Control Surface to simplify function settings.
- Power saving device ; monitor VESA DPMS automatically enters into power save mode to reduce power consumption to less than 8W in stand by (no-signal) mode.
- Built-in wall mounting ; Detachable stand enhances wall-mounting application.

Package Contents

Please check the FP1510 Package to make sure it contains the following items :

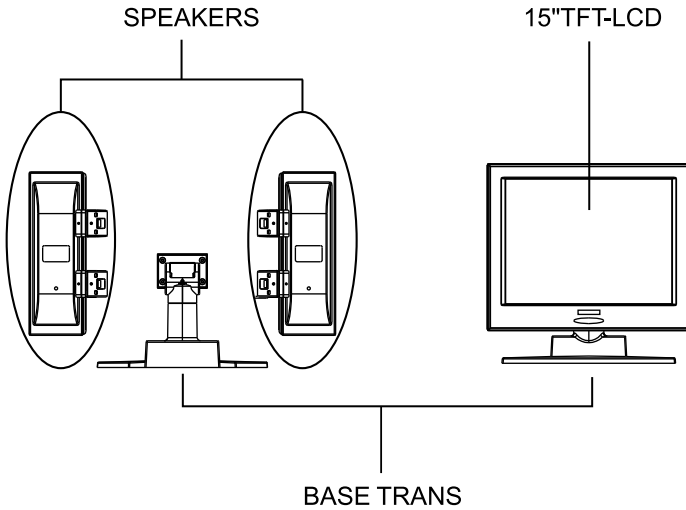

Slim-type Remote Control

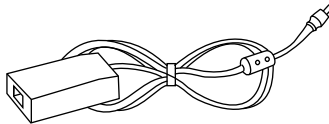

Power Transformer Cord

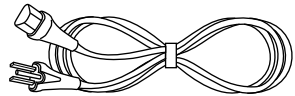

Power Cord

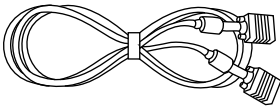

VGA Cable



User Manual

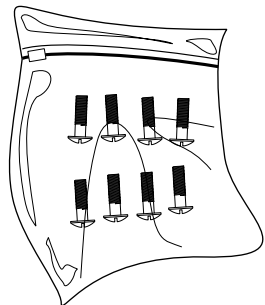

Hardware Kit

2. SYSTEM SETUP

Top Panel & Remote Control Function

TOP PANEL :

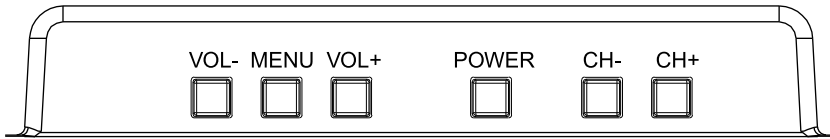



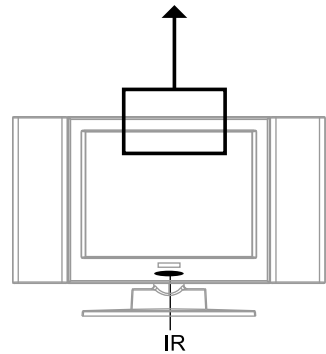



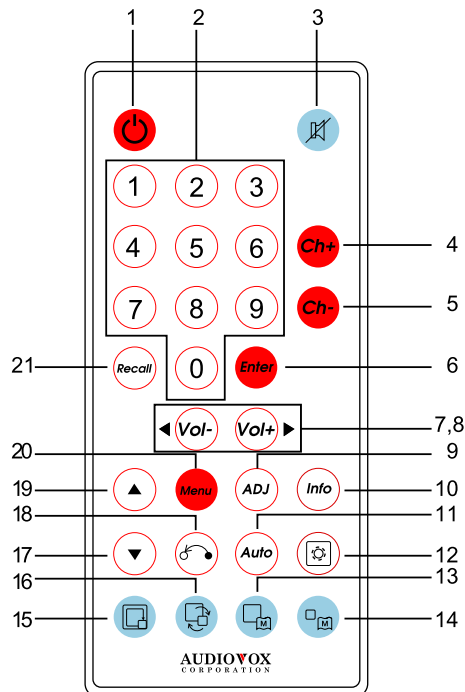













- VOL - : Volume down Button : decreases volume
- MENU : Menu Button : Selects command function
- VOL + : Volume up Button : Increases volume
- POWER : Power Button : Power on/off control
- CH - : Channel down Button : Decreases setting channel
- CH + : Channel up Button : Increases setting channel
- IR : Remote IR detect window : Receives IR signal from remote control



Remote Control Unit :



Remote Control Buttons :

- | | | | | | |
|----|---|---|----|---|---|
| 1 |  | POWER
Power On/Off | 11 |  | AUTO
Scans signal channels TV and CATV |
| 2 |  | KEYPAD
Press number key to select channel of TV | 12 |  | OSD Display
Chooses on-screen subtitle color, including yellow, blue, white and black |
| 3 |  | MUTE
Turns volume off | 13 |  | Main Disp Switch
Chooses Main Display for AV, SV,CATV, TV, PC |
| 4 |  | CH+
Increase TVchannel setting | 14 |  | Sub Disp Switch
Chooses Sub Display for AV, SV,CATV, TV |
| 5 |  | CH-
Decrease TV channel setting | 15 |  | Sub Disp Move
Press to show VOV,sub picture shifts its position to one of four viewing angles in TV |
| 6 |  | ENTER
Enters command keypad functions | 16 |  | VOV Swap
Switches Video-On-Video in the TV window |
| 7 |  | VOL-
Decreases volume setting | 17 |  | BACKWARD
Selects previous menu item |
| 8 |  | VOL+
Increases volume setting | 18 |  | CANCEL
Back to last title |
| 9 |  | ADJ
Adjust the saturation,hue,brightness and contrast functions | 19 |  | FORWARD
Selects next menu item |
| 10 |  | INFO
Displays the signal source of the current channel | 20 |  | Menu
Displays the main menu on screen |
| | | | 21 |  | RECALL
Recalls the last channel viewed |

Remote Control Battery Installation/Removal :

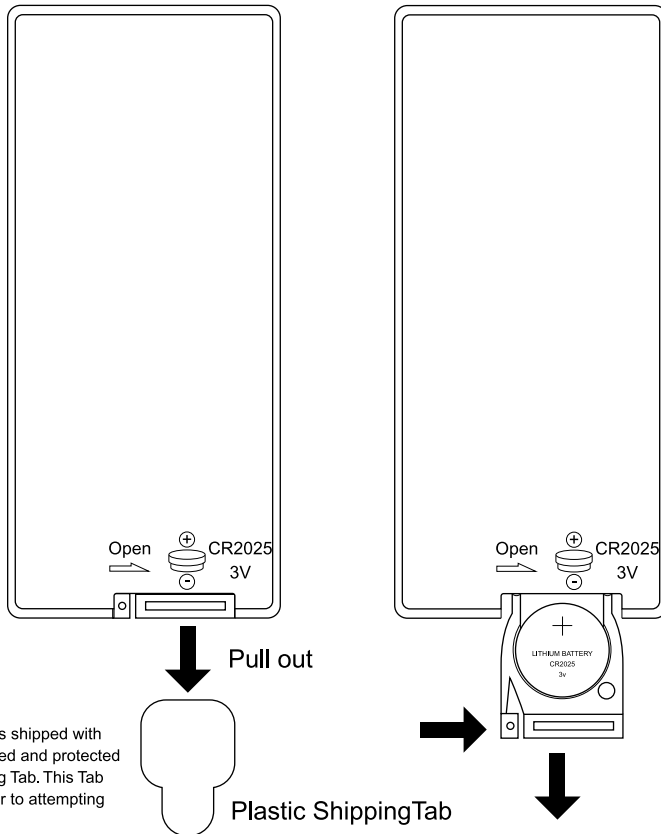

IMPORTANT !!

The Remote Control is shipped with the Battery pre-installed and protected with a Plastic Shipping Tab. This Tab must be removed prior to attempting to operate the unit.

Change the Battery if the Remote Control no longer operates the FP1510.

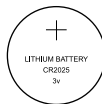

Caution :

Only use CR2025 type Battery.
Confirm the polarity(+/-) of battery before installing
Removal the battery if the Remote Control is not to be used for a long time.

Remote Control Operating Instruction:

The Remote Control Transmission consists of an Infrared (IR) Signal. Make sure the line-of-sight between Remote Control and FP1510 is clear of objects that could interfere with the remote IR signal. Always point the Remote Control directly at the FP1510 sensor.

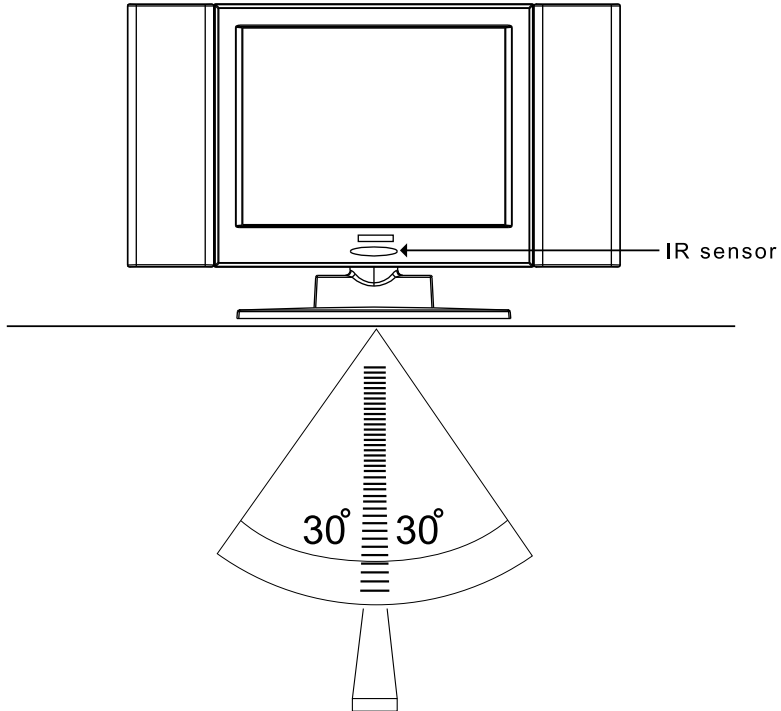

CAUTION !!

Avoid damaging the Remote Control by :

- Applying excessive pressure when pressing buttons
- Exposing to extreme Low or High temperatures
- Exposing to excessive Moisture
- Mishandling to Dropping

Assembly and Connection

Assembly of the TFT-LCD

1.3.Speaker 2.Monitor and 4.Stand

DISPLAY BRACKET MOUNTING

How to unfold the stand on the bottom when you mounting to wall.

Caution :
You must complete assembly prior to power application

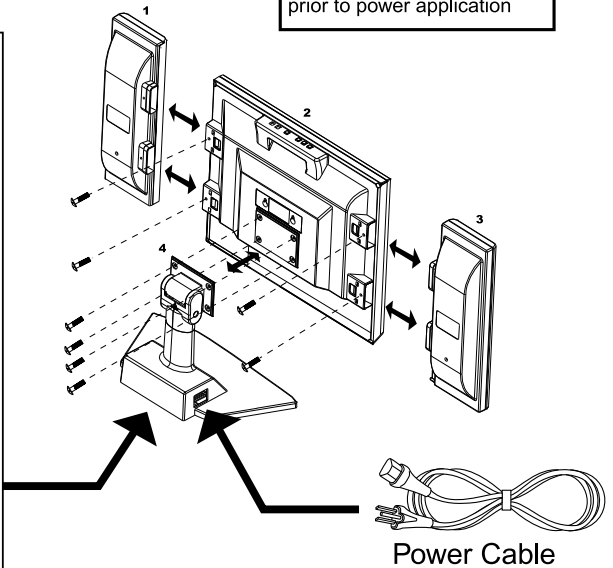
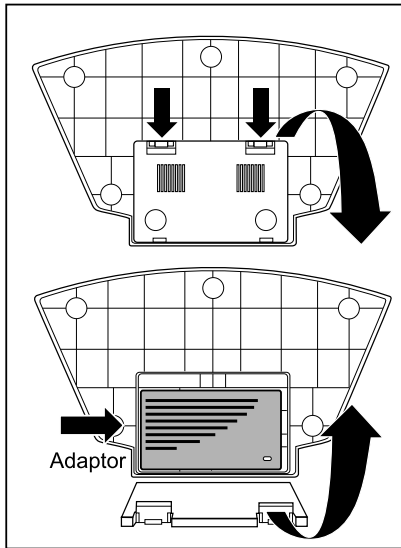

WALL MOUNTING

NOTE :
When mounting to wall please secure to wall stud.

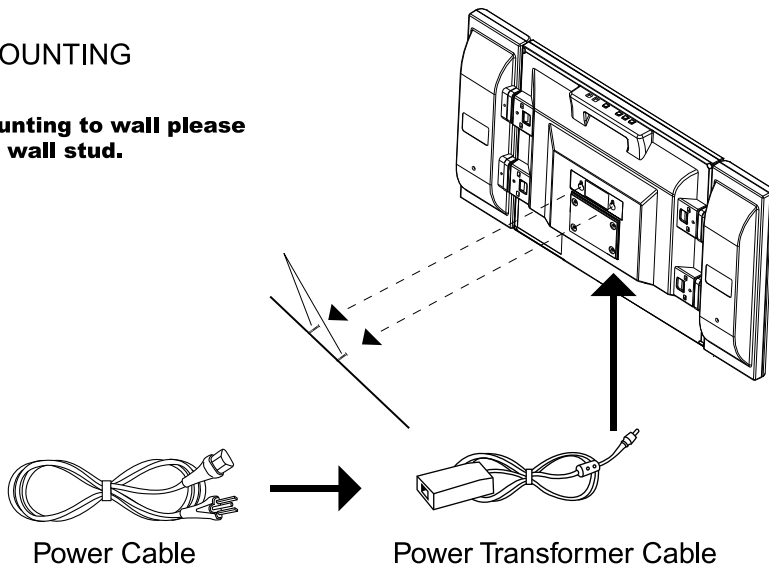

Input/Output Signal Connections

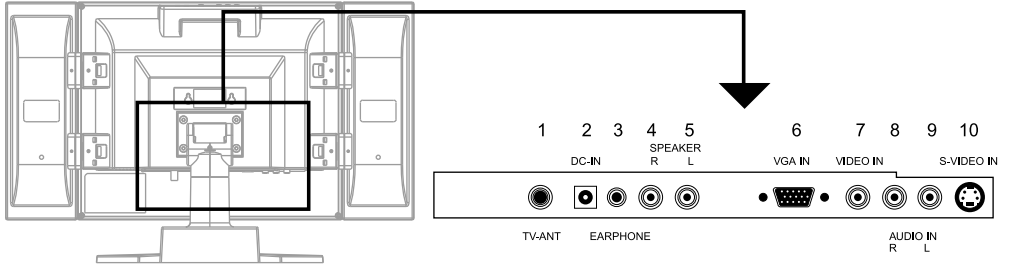

1. ANT CABLE INPUT
2. POWER ADAPTER INPUT
3. HEADPHONE OUTPUT
4. RIGHT SPEAKER OUTPUT
5. LEFT SPEAKER OUTPUT
6. VGA INPUT
7. A-VIDEO INPUT
8. RIGHT AUDIO INPUT
9. LEFT AUDIO INPUT
10. S-VIDEO INPUT

Connecting TV Cable

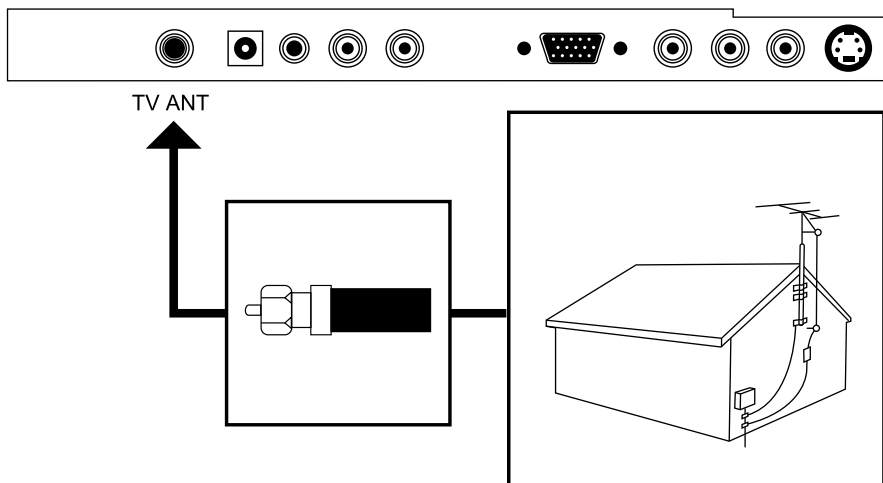

DC Power Socket



DC-IN

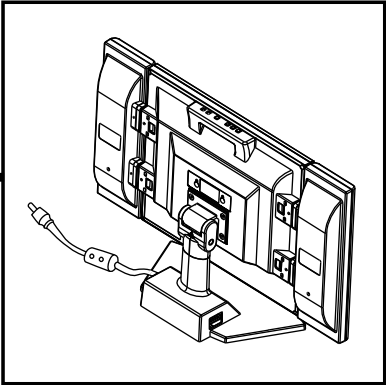

Connecting Left and Right Speakers



SPEAKER
R L

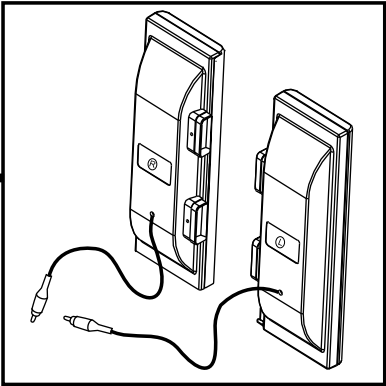

Connecting to S-video terminal equipment such as DVD, VCR or Gaming Console.

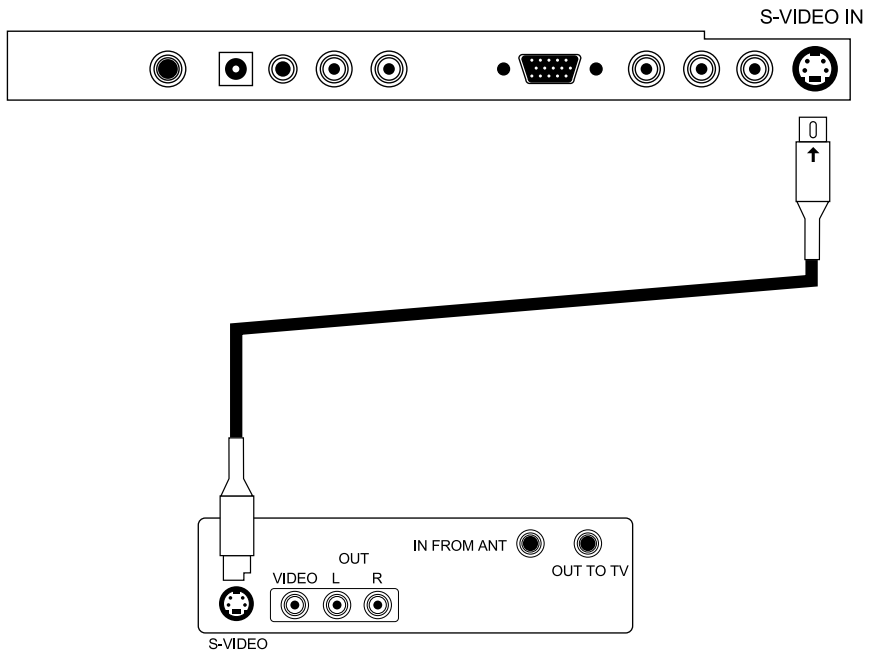

Connecting to 15-PIN VGA from a PC

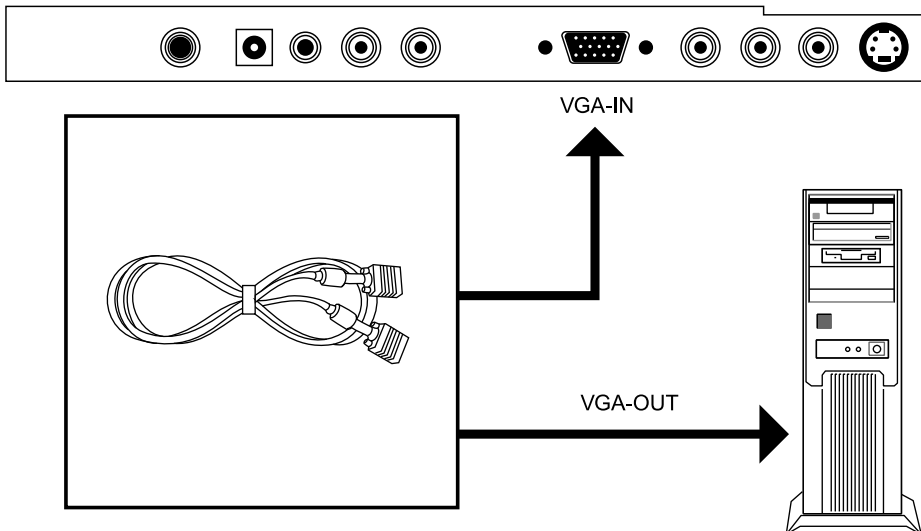

Connecting to AV-terminal equipment such as DVD, VCR, and Gaming Console.

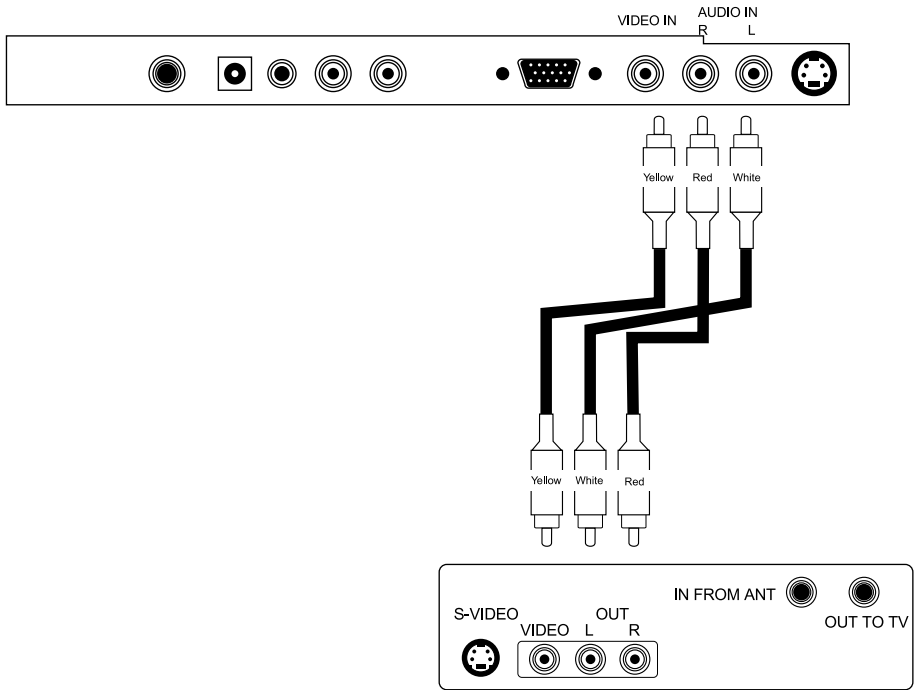

3.FP1510 OPERATING INSTRUCTIONS

TV and AV Operating Instructions

MAIN DISP

Press and release the Menu button to display the following Main Menu for TV and AV functions :

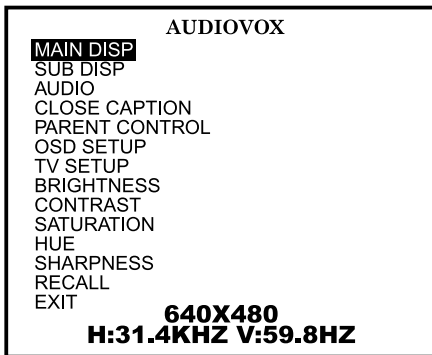

Press and release the Menu button again to access the MAIN DISP menu :

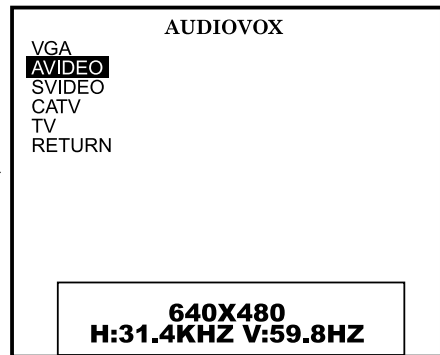

NOTE :
Screen Resolution
(Will vary)

MAIN DISPLAY OPTIONS :

1. Main Display
2. Sub Display
3. Sound Option
4. Close Subtitle
5. Parent Control
6. On-Screen-Display(OSD) Option
7. TV Mode Option
8. Brightness
9. Contrast
10. Saturation
11. Hue
12. Sharpness
13. Recall
14. Exit

INPUT SIGNAL SELECTIONS :

1. VGA-Computer Input Signal
 2. AVIDEO-AV Input Signal
 3. SVIDEO-S-Video Input Signal
 4. CATV-Cable TV Input Signal
 5. TV-TV Input Signal
- RETURN to Previous Menu

SUB DISP (sub display)

SUB DISP has four signal inputs - AVIDEO, SVIDEO, CATV and TV. These inputs are used to connect to a DVD-Player, VCR etc.

1. AVIDEO (AV-Terminal)
2. SVIDEO (S-Terminal)
3. CATV
4. TV
5. Video-On-Video(VOV) OFF
6. RETURN

With the Main Menu displayed, Press and release the  button to highlight SUB DISP

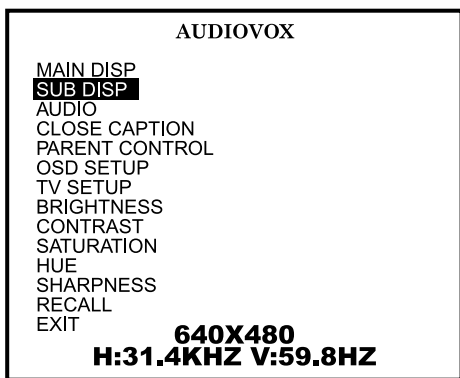

Press and release the MENU button to display the SUB DISP Menu :

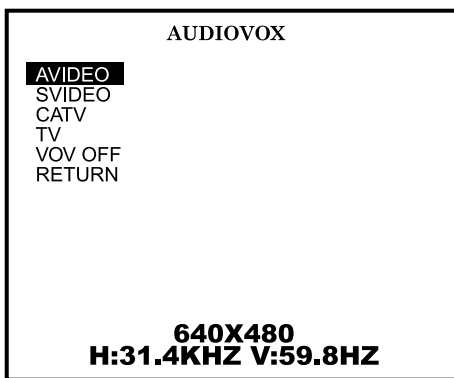

Press and release the  button to highlight AVIDEO. Then Press and release the Menu button to select AVIDEO for (Video-On-Video) viewing.

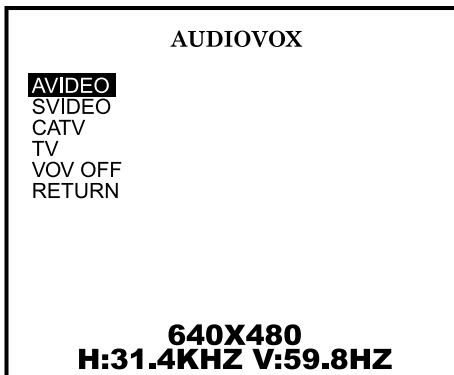

With the Main Menu displayed, use the

⏏ button to select VOV ADJUST

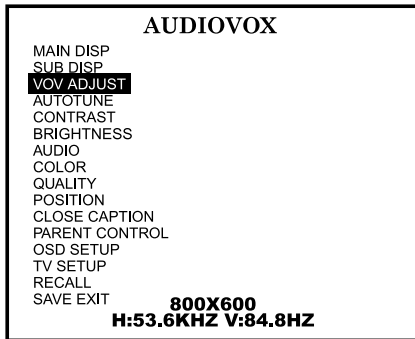

Then Press and release the Menu button to select VOV adjustments :

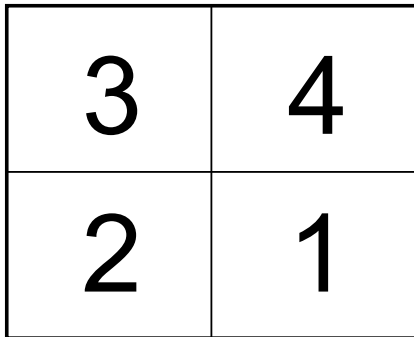
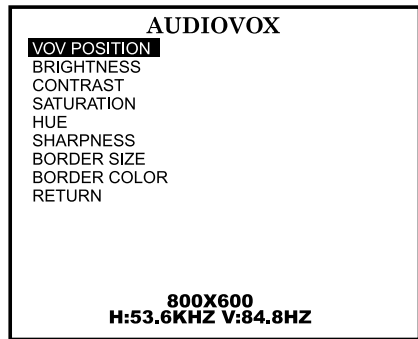

NOTE :

Position 1 - Bottom Right

Position 2 - Bottom Left

Position 3 - Upper Left

Position 4 - Upper Right

With the VOV POSITION Menu displayed, use the ⏏ button to select the VOV POSITION desired then Press Menu to display

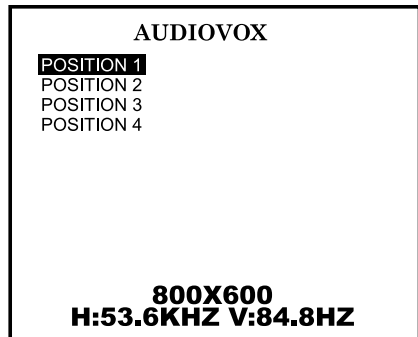

Press the ⏏ button to select Position. Press and release the Menu button to go back to the previous Menu.

NOTE :

The following adjustments will effect the VOV only, not the Main display.

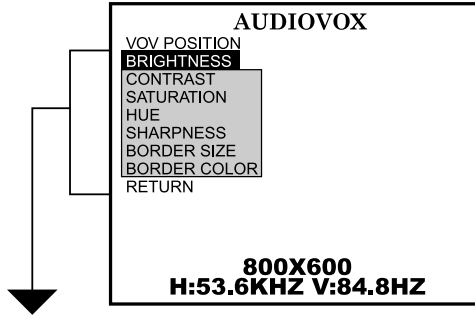

BRIGHTNESS

120

Press the (▲) (▼) button to adjust setting and then Press and release the Menu button to confirm and return to previous page.

CONTRAST

192

Press the (▲) (▼) button to adjust setting and then Press and release the Menu button to confirm and return to previous page.

SATURATION

200

Press the (▲) (▼) button to adjust setting and then Press and release the Menu button to confirm and return to previous page.

HUE

128

Press the (▲) (▼) button to adjust setting and then Press and release the Menu button to confirm and return to previous page.

SHARPNESS

0

Press the (▲) (▼) button to adjust setting and then Press and release the Menu button to confirm and return to previous page.

BORDER SIZE

3

Press the (▲) (▼) button to adjust setting and then Press and release the Menu button to confirm and return to previous page.

BORDER COLOR

124

Press the (▲) (▼) button to adjust setting and then Press and release the Menu button to confirm and return to previous page.

AUDIO

Select the desired level of GAIN, BASS, TREBLE and LOUDNESS.

1. AUDIO CHANNEL - Choose Audio Input Source (A-Video, TV).
2. SPEAKER ON/OFF - Mute Speaker
3. GAIN - Adjusts Audio Gain
4. BASS - Adjusts Bass
5. TREBLE - Adjusts Treble
6. LOUDNESS - On or Off
7. RETURN - Back to Main Menu Display

Access the Main Menu and highlight AUDIO then press and release the Menu button to select.

NOTE :
Use the ▲ and ▼ to move between the options, also use the ▲ and ▼ to adjust progress bar.

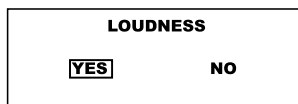
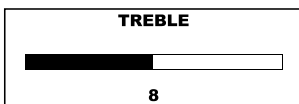
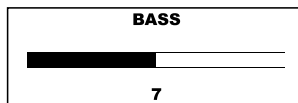
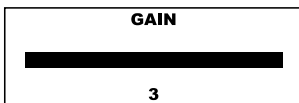
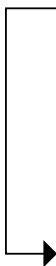
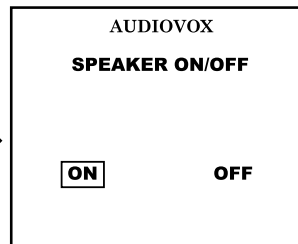
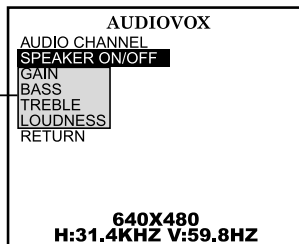
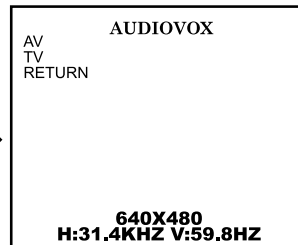
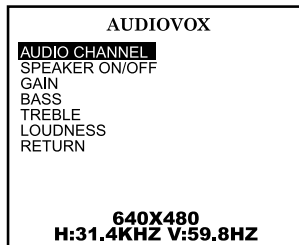
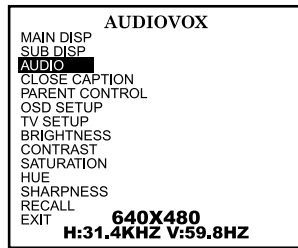

CLOSE CAPTION

The caption can display the spoken audio content of picture.

1. CAPTION - You can choose to show the caption or not.
2. DISPLAY :
 - a. BOX - You can choose to box the caption.
 - b. SHADOW - You can choose to show the caption in shadow (not boxed) format.
3. RETURN - Back to main menu display

NOTE :

Not all channels display CLOSE CAPTION.

With the Main Menu displayed, Press and release the  button to highlight CLOSE CAPTION

Press and release the Menu button to display the CAPTION Menu.

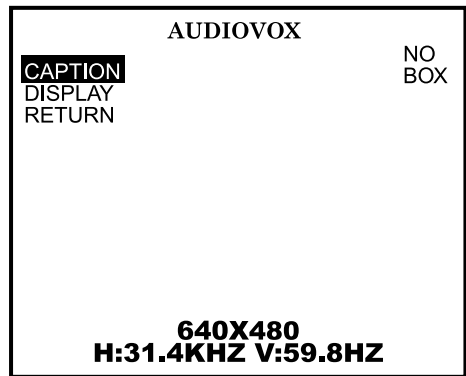
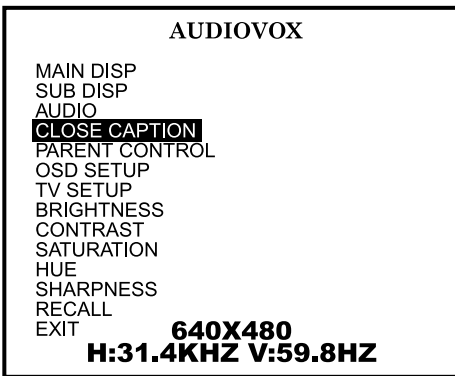

Press and release the Menu button to select CAPTION(1-4)and text (1-4) options.

Press and release the Menu button to select DISPLAY.

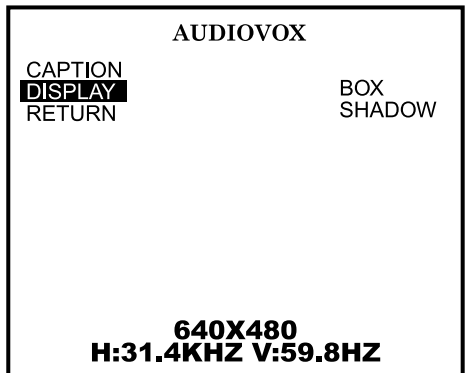
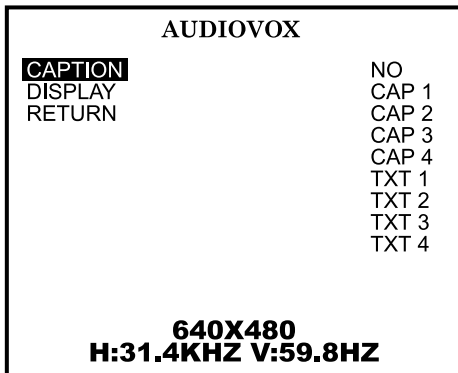

PARENT CONTROL

With the Main Menu displayed,
Press and release the  button
to highlight PARENT CONTROL :



Input the four-digit Parent Control Password
and confirm using the Menu button
(Default Code is 3308)

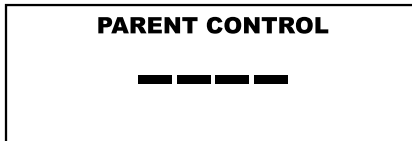

After entering the Password, the following
menu will appear :

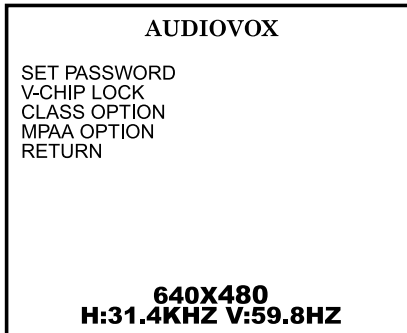

After accessing the Parent Control Menu,
highlight SET PASSWORD and Press and
release the Menu button.
Then enter a 4-digit Password to change
the Parental Control Menu Password.

PARENT CONTROL (continued)

From the PARENT CONTROL Main Menu.
Press and release the  button to highlight V-CHIP lock then Press and release the Menu button :

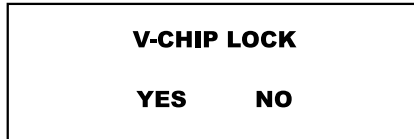

Enable the V-CHIP lock function by Selecting YES and disable by selecting NO.

From the PANRENT CONTROL Main Menu.

Press and release the  button to highlight CLASS OPTION on Main Parental Control Menu :

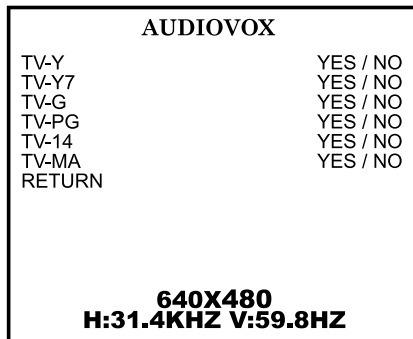

Select the desired age class and Press and release the Menu button.
Select RETURN to go back to the Parental Control Main Menu.

PARENT CONTROL (continued)

PARENTAL CONTROL RATINGS

From the PARENT CONTROL Main Menu.
Press and release the  button to
highlight MPAA OPTION and
press menu :

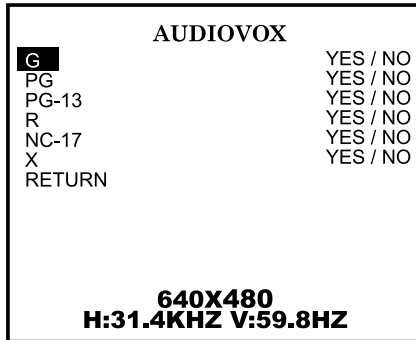

Select the desired rating level and press Menu.
Select RETURN to return to the main parental
control menu.

CLASS OPTION

- | | |
|----------|-----------|
| a. TV-Y | e. TV-14 |
| b. TV-Y7 | f. TV-MA |
| c. TV-G | g. Return |
| d. TV-PG | |

MPAA OPTION

- | | |
|----------|-----------|
| a. G | e. NC-17 |
| b. PG | f. X |
| c. PG-13 | g. RETURN |
| d. R | |

ON SCREEN DISPLAY(OSD) SETUP :

With the Main Menu displayed,
Press and release the (▼) button to
highlight OSD SETUP

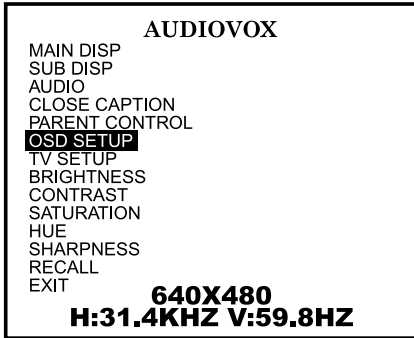

Press and release the Menu button to
select LANGUAGE, OSD COLOR or OSD
TIMER

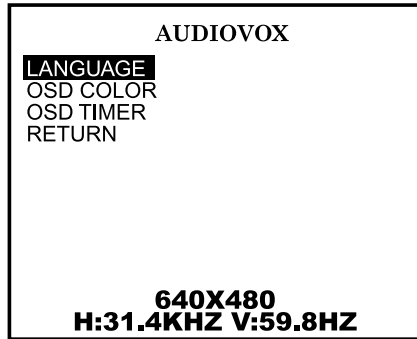

OSD LANGUAGE :

Using the (▼) button, select the desired
LANGUAGE

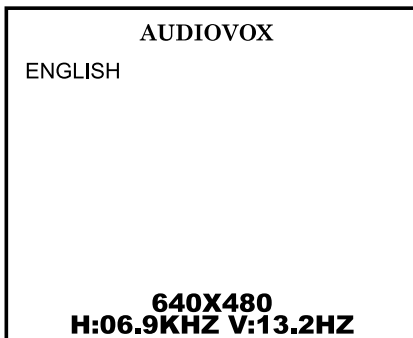

OSD COLOR :

Using the (▼) button, select the desired
OSD Message Color then Press and
release the Menu button to confirm

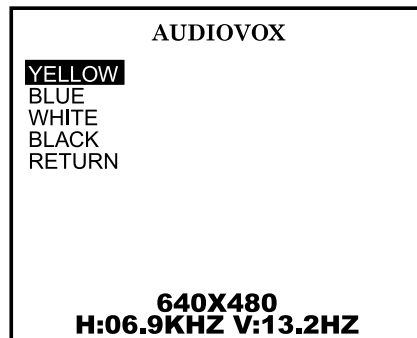

OSD TIMER :

Using the (▼) button, select the amount of
time you would like the OSD Message to
be viewed (5,10,15 seconds) then Press
and release the Menu button to confirm

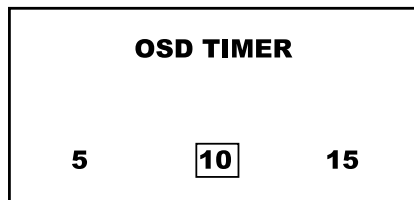

With the MAIN MENU displayed,
Select TV SETUP using the Menu
button :

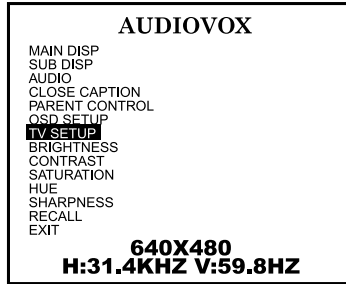

Select TV SETUP and highlight ERASE/
ADD then Press and release the Menu
button.

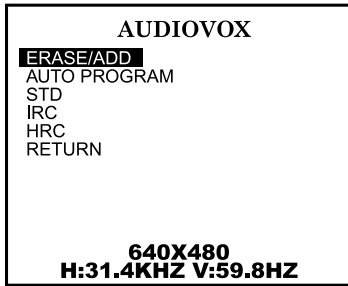

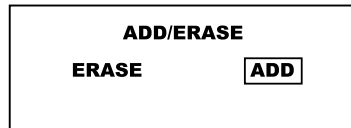

Using the  button, select ERASE or
ADD then Press and release the Menu
button to confirm.

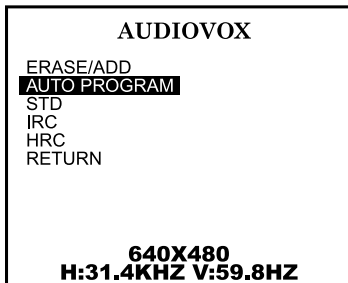

NOTE : this function can ERASE or ADD
the present display's channel.

Select TV SETUP and highlight AUTO
PROGRAM then Press and release the
Menu button.



Using the  button, select YES or NO.
(No need to press Menu button, The
Autoprogram will Autostart).

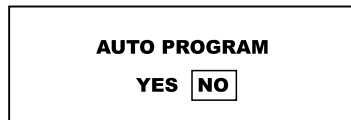

NOTE :

STD, IRC,HRC are Cable system standards.
These options are used to comply with Cable TV formats.

With the MAIN MENU displayed, select BRIGHTNESS, CONTRAST, SATURATION, HUE OR SHARPNESS then Press and release the Menu button to confirm. The following screen(s) will be displayed (see screens below)

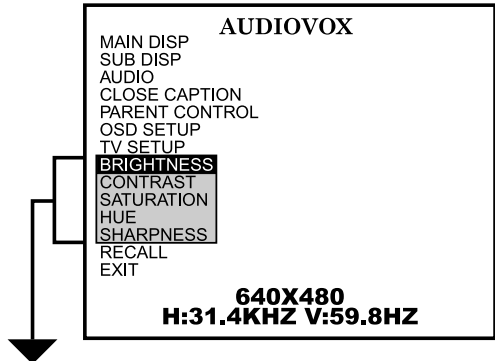

BRIGHTNESS

Adjusts the overall image and background screen brightness.

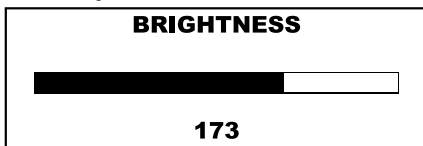

Press the button to adjust setting then press Menu to return to the previous menu.

SATURATION

Adjusts the color gradations in relation to the images and background.

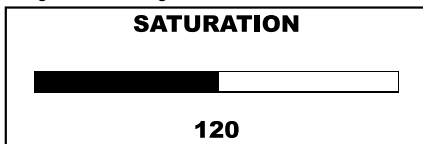

Press the button to adjust setting then press Menu to return to the previous menu.

SHARPNESS

Adjusts the overall image and background screen sharpness.

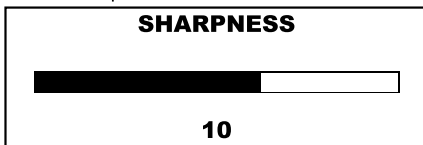

Press the button to adjust setting then press Menu to return to the previous menu.

CONTRAST

Adjusts the image brightness in relation to the background.

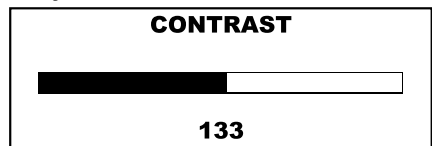

Press the button to adjust setting then press Menu to return to the previous menu.

HUE

Adjusts the color definition in relation to image and background.

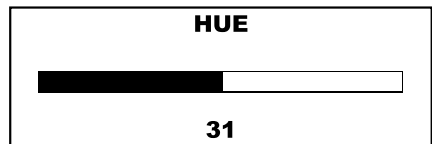

Press the button to adjust setting then press Menu to return to the previous menu.

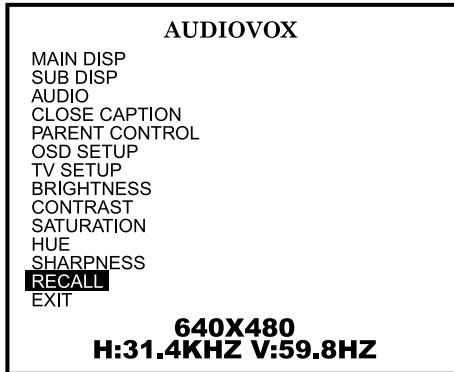

With the MAIN MENU displayed,
Select RECALL using the Menu button

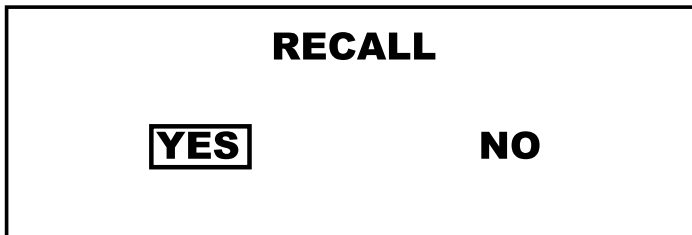

RECALL

Automatically reset setting to factory defaults.



Press the   buttons to select YES or NO option,
(No need to select Menu the RECALL will happen Automatically).

EXIT

Exits the on-screen-menu controls

With the MAIN MENU displayed,
EXIT using the MENU button to
exit the MAIN MENU

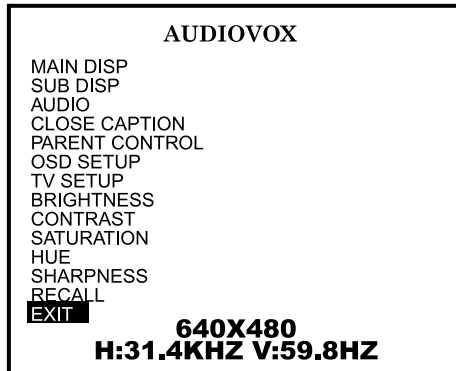

Using the FP1510 as a Computer Monitor

Press the  button to highlight MAIN DISP and Press and release the Menu button.



Select VGA and Press and release the Menu button.

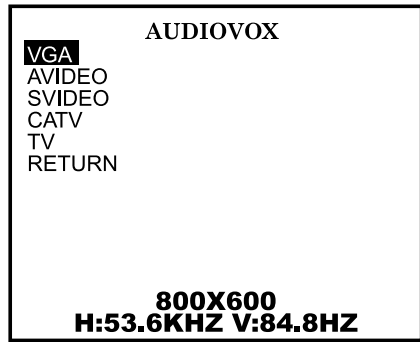

NOTE :

The CLOSE CAPTION and PARENT CONTROL options will not appear in the Main Menu until a TV program has been accessed using the SUB DISP menu.

AUTO TUNE

Automatically optimizes the VGA signal for viewing.

With the Main Menu displayed, use the  button to select AUTOTUNE

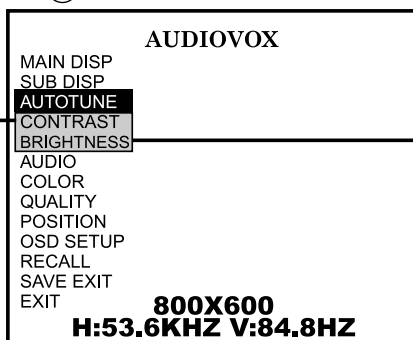

Then Press and release the **Menu** button to display the following screen :





AUTOTUNE :

Only worked when unit is connected to computer and the screen will appear "DOING"

CONTRAST

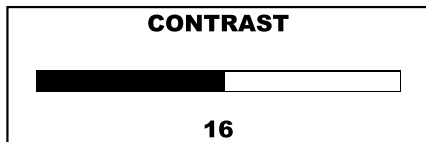
Adjusts the image brightness in relation to the background.





Press the   button to adjust setting then press Menu to return to the previous menu.

BRIGHTNESS

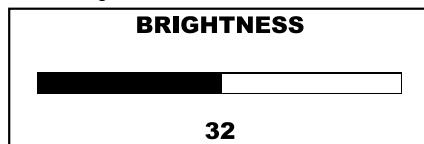
Adjusts the overall image and background screen brightness.



Press the   button to adjust setting then press Menu to return to the previous menu.

With the Main Menu displayed, use the

⏏ button to select COLOR.



Press and release the Menu button to display the COLOR Menu :

Then use the ⏏ button to select USER.

When USER is selected, Color can be manually adjusted by selecting the following displayed colors :

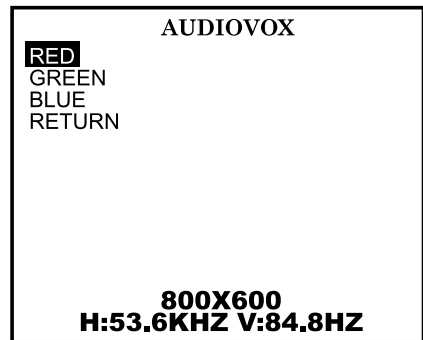
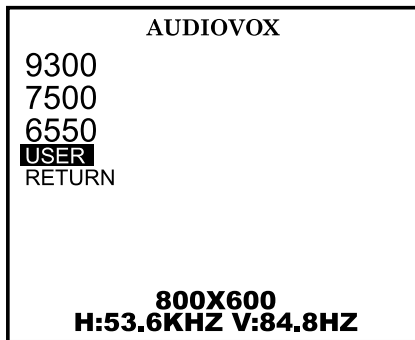

When RED is highlighted, pressing the Menu button will display the following screen :

Use the ⏏ and ⏏ buttons to adjust setting. Do this for each of the COLORS.

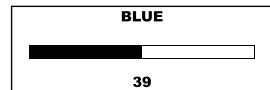
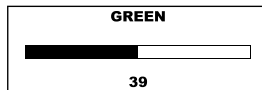
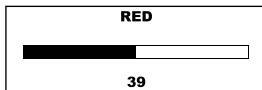

COLOR - Color temperature

1. 9300 - If you are partial to choose the 9300 setting.
2. 7500 - The 7500 setting is less blue than 9300.
3. 6550 - The color temperature setting is standard.
4. USER - Increases or decreases Red, Green or Blue colors. Change in color will be reflected on the screen image.

NOTE :

9300, 7500 and 6550 are Preset at the factory.

ADV.TUNE

With the Main Menu displayed, use the  button to select QUALITY.

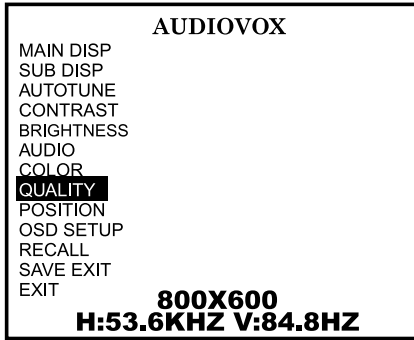

Then Press and release the Menu button to access the following screen ;

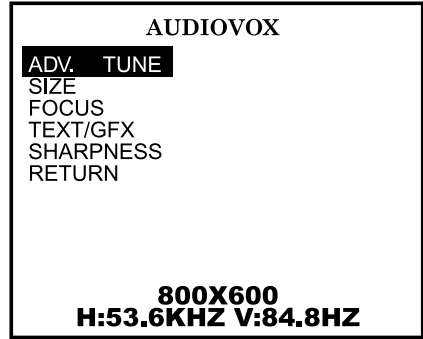

Adjust the picture FOCUS, SIZE and SHARPNESS.

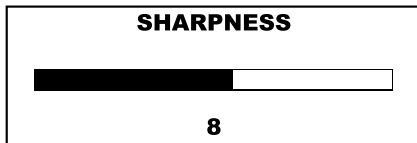
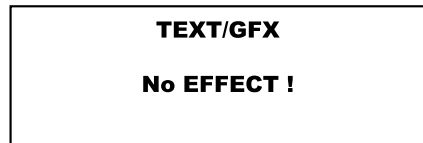
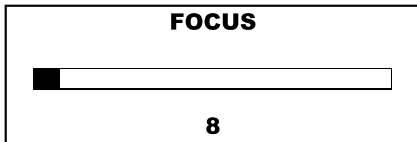
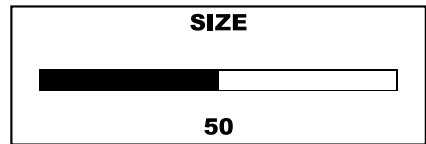
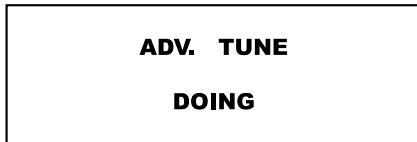

QUALITY

1. ADV. TUNE - Automatically adjusts image clarity and stability.
2. SIZE - Adjusts image size relative to the screen.
3. FOCUS - Controls image clarity.
4. TEXT/GFX - Adjusts text sharpness when PC is in DOS mode.
5. SHARPNESS - Adjusts image sharpness relative to the background.

IMAGE POSITION

With the Main Menu displayed, use the  button to select POSITION.



Then Press and release the Menu button to access the following screen :

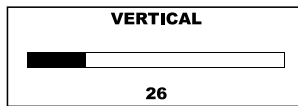
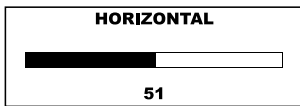
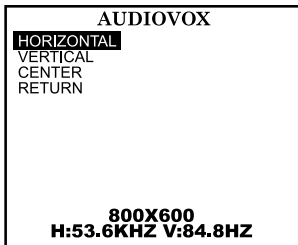
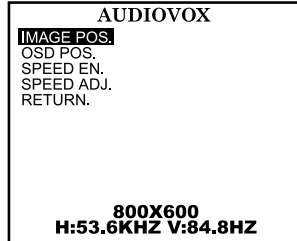

With SPEED EN highlighted, use the Menu button to access following screen :

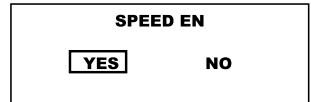

With SPEED ADJ highlighted, use the Menu button to access following screen :

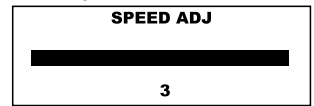

POSITION

1. IMAGE POS.
 - a. HORIZONTAL - Adjusts the horizontal size by increasing or decreasing this setting.
 - b. VERTICAL - Adjusts the vertical size by increasing or decreasing this setting.
 - c. CENTER - Automatic adjusting image to center.
2. OSD POS you can choose where you would like the OSD control window to appear on your screen. Selecting OSD location allows you to manually adjust the position of the OSD control menu left, right, up or down.
You can choose where you would like the OSD control window to appear in the center area on your screen.
3. SPEED EN.
 - a. YES
 - b. NO
4. SPEED ADJ.

SAVE EXIT

Saves your settings then exits main menu

With Main Menu displayed, use the  button to select SAVE EXIT



Then press and release the Menu button to save all settings and exit the Main Menu.

EXIT :

Changes will not be saved.

Use the  button to select EXIT



Then Press and release the Menu button to exit the Main Menu.

Reference Display Modes

Mode	Resolution	Horizontal frequency(KHZ)	Vertical frequency(HZ)
1	640 × 350	31.47	70
2	720 × 400	31.47	70
3	640 × 480	31.47	60
4	640 × 480	37.86	72
5	640 × 480	37.5	75
6	800 × 600	35.16	56.3
7	800 × 600	37.88	60.3
8	800 × 600	48.08	72.2
9	800 × 600	46.87	75
10	1024 × 768	48.36	60
11	1024 × 768	56.47	70
12	1024 × 768	60	75
13	640 × 480	35	66.7
14	832 × 624	49.7	74.55
15	1024 × 768	48.78	60
16	1024 × 768	60.241	74.927

LCD Monitor Display Angle

Vertical : Left 30°/Right 30°
Horizontal : Up 30°/Down 5°

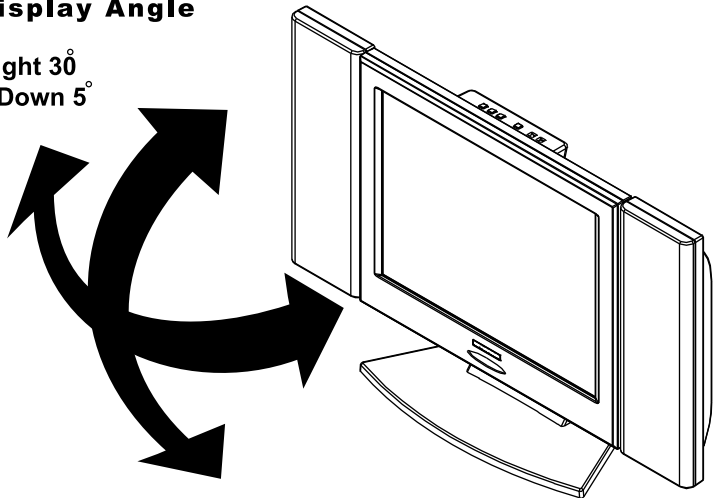

Wall-Mounting Operating Instructions

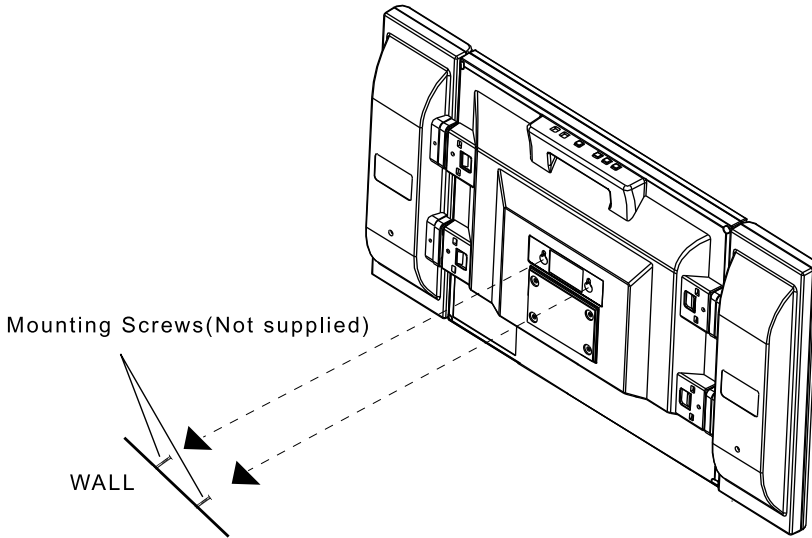

Wall mount template :

Use provided guide to place hole in wall for mounting.

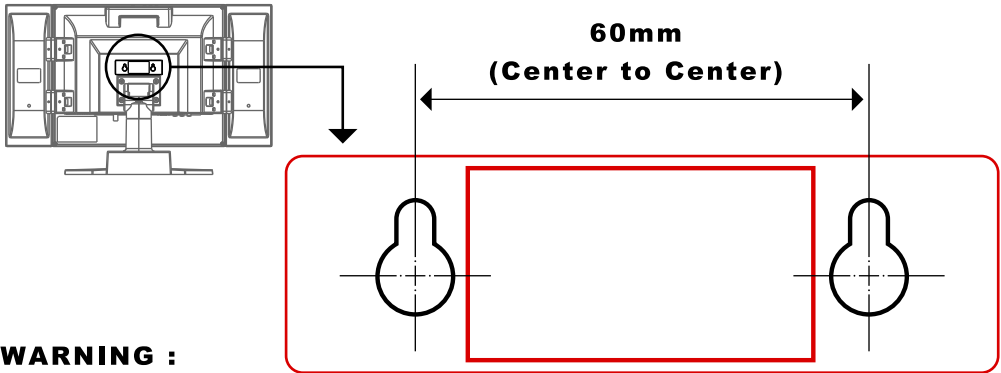

WARNING :

When mounting to wall, please secure mounting screws into a secure wall stud.

Please NOTE when cleaning the LCD Monitor :

1. Gently wipe screen with a clean, soft, lint-free cloth to remove dust and other particles that can scratch the screen.
2. To clean the tough areas, use a soft, lint-free cloth with a few drops of water to remove the stubborn dirt.
3. Do Not apply pressure to the surface of the TFT-LCD.

When you clean the housing :

1. Use a soft, dry cloth to clean housing.
2. To clean tough areas, use a soft, lint-free cloth with a few drops of water to remove the stubborn dirt.

Appendix Troubleshooting

Please use the following table to resolve the most common possible causes of the problem before calling service personnel. A minor adjustment may eliminate the problem and restore your TV reception.

Symptom	Corrective Actions
No picture on screen	<ol style="list-style-type: none"> 1. Check VGA cable connection with computer. 2. Check that power is turned on, or that power adapter lamp is lit. 3. Adjust brightness and contrast. 4. Check input signal of TFT-LCD. 5. Check the power connection to the unit with screen. 6. Check Main Display selection.
Picture is not clear	<ol style="list-style-type: none"> 1. Check that Video cable is plugged in. 2. Refer to the Picture Adjustments Menu in the OPERATING INSTRUCTIONS.
Image is fuzzy	<ol style="list-style-type: none"> 1. The power could be failing, try connecting the unit to another power outlet. 2. Move unit away from the magnetic equipment, such as a Wireless Receiver, AC Transformer,ETC 3. Refer to the Picture Adjustment Procedure Menu in the OPERATING INSTRUCTIONS.
Colors are distorted	<ol style="list-style-type: none"> 1. Check that the Video cable is plugged in securely.
Screen bounces or has wavy oscillations	<ol style="list-style-type: none"> 1. Check Video input range (V-sync : Max 75Hz, H-sync : Max. 62.5KHz). 2. Make sure Video cable connections are secure.
No sound	<ol style="list-style-type: none"> 1. Check speaker connections. 2. Sound might be muted, try adjusting the volume.
Only one speaker operates	<ol style="list-style-type: none"> 1. Check speaker line connections with computer. 2. Check that the unit's speaker wires are securely connected.
Remote Control inoperative	<ol style="list-style-type: none"> 1. Check for light or obstacle interference with remote control signal and move unit to another location. 2. Batteries are dead; replace batteries with new ones.
Poor Picture Reception and/or Poor Sound Quality	<p>Contact your Cable Provider to identify the type of Cable Service that is supplied to you (STD, IRC or HRC). From TV SETUP mode, select the appropriate setting and Re Run AUTO PROGRAM (Page 27).</p>
When all else fails Reset the firmware	<p>Turn off power. Press and hold the VOL+ button on the top of the unit and hit the power button at the same time. Release the VOL+ after you see the volume increasing.</p>

If the unit does not operate normally, after the operating instructions were followed. And the troubleshooting section did not help refer to dealer or qualified service personnel.

SPECIFICATION

SPECIFICATION	
Model No.	FP1510
LCD Panel	15" TFT-LCD Color Display
Pixel Number	2,359,296 pixel RGB
TV System	RF NTSC Only
TV Function	TV CCIR Standard System - NTSC-M TV Auto-install Channel Stereo Audio TV Remote Control Auto-install in advance Auto-scanning CATV 125CH, AIR69CH V-Chip
Brightness	350cd/m ²
Scanning Backlighting Life	50,000hr
View Angle	H-Position 150 ^o V-Position 130 ^o
Audio Amplifier	5W x 2
Input Terminal AV Input	Terminal Input A-Video, S-Video,15Pin D-sub (VGA),Coax
ANT	DIN
H/P (earphone)	3.5 ∅ Hole
Display Language	English
Power Adapter	AC Input 100-240V DC Output 12V/3.0A
Enclosure	Remote Control ∙ Battery ∙ AC Connections ∙ VGA Cable AC Power Cord ∙ User Guide

Duplicate Page by Design
OPTIONAL Wall-Mounting Instructions

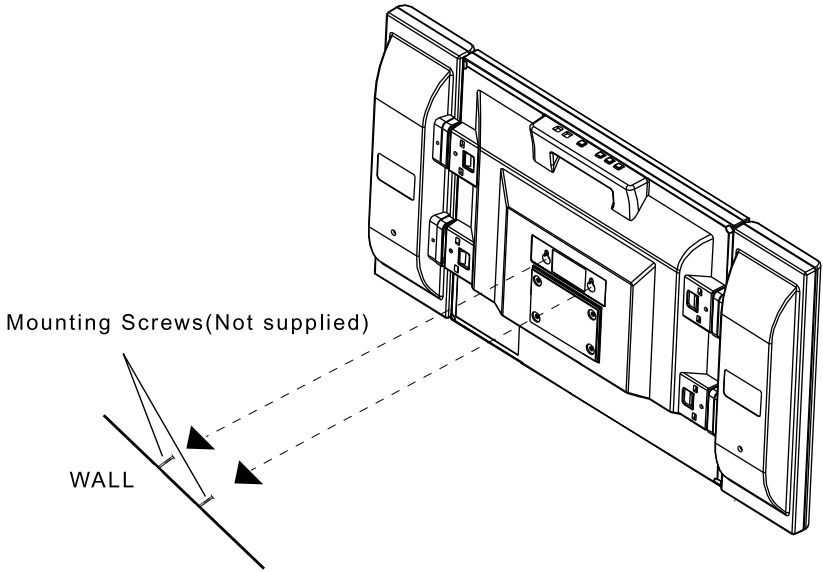

Wall mount template :

Use provided guide to place hole in wall for mounting.

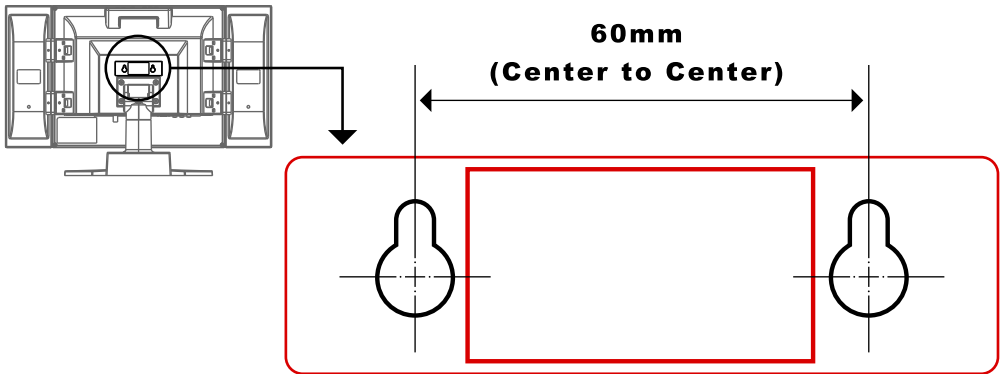

WARNING :

When mounting to wall, please secure mounting screws into a secure wall stud.



AUDIOVOX[®]
CORPORATION

90 DAY LIMITED WARRANTY

Applies to Audiovox Video Products

AUDIOVOX ELECTRONICS CORP. (the Company) warrants to the original retail purchaser of this product that should this product or any part thereof, under normal use and conditions, be proven defective in material or workmanship within 90 days from the date of original purchase, such defect(s) will be repaired or replaced with reconditioned product (at the Company's option) without charge for parts and repair labor.

To obtain repair or replacement within the terms of this Warranty, the product is to be delivered with proof of warranty coverage (e.g. dated bill of sale), specification of defect(s), transportation prepaid, to the Company at the address shown below.

This Warranty does not extend to the elimination of externally generated static or noise, to correction of antenna problems, to costs incurred for installation, removal or reinstallation of the product, or to damage to tapes, discs, speakers, accessories, or electrical systems.

This Warranty does not apply to any product or part thereof which, in the opinion of the Company, has suffered or been damaged through alteration, improper installation, mishandling, misuse, neglect, accident, or by removal or defacement of the factory serial number/bar code label(s). THE EXTENT OF THE COMPANY'S LIABILITY UNDER THIS WARRANTY IS LIMITED TO THE REPAIR OR REPLACEMENT PROVIDED ABOVE AND, IN NO EVENT, SHALL THE COMPANY'S LIABILITY EXCEED THE PURCHASE PRICE PAID BY PURCHASER FOR THE PRODUCT.

This Warranty is in lieu of all other express warranties or liabilities. ANY IMPLIED WARRANTIES, INCLUDING ANY IMPLIED WARRANTY OF MERCHANTABILITY, SHALL BE LIMITED TO THE DURATION OF THIS WRITTEN WARRANTY. ANY ACTION FOR BREACH OF ANY WARRANTY HEREUNDER INCLUDING ANY IMPLIED WARRANTY OF MERCHANTABILITY MUST BE BROUGHT WITHIN A PERIOD OF 30 MONTHS FROM DATE OF ORIGINAL PURCHASE. IN NO CASE SHALL THE COMPANY BE LIABLE FOR ANY CONSEQUENTIAL OR INCIDENTAL DAMAGES FOR BREACH OF THIS OR ANY OTHER WARRANTY, EXPRESS OR IMPLIED, WHATSOEVER. No person or representative is authorized to assume for the Company any liability other than expressed herein in connection with the sale of this product.

Some states do not allow limitations on how long an implied warranty lasts or the exclusion or limitation of incidental or consequential damage so the above limitations or exclusions may not apply to you. This Warranty gives you specific legal rights and you may also have other rights which vary from state to state.

U.S.A. : AUDIOVOX ELECTRONICS CORPORATION, 150 MARCUS BLVD., HAUPPAUGE, NEW YORK 11788 ✆ 1-800-645-4994

CANADA : CALL 1-800-645-4994 FOR LOCATION OF WARRANTY STATION SERVING YOUR AREA

128-5556C

Free Manuals Download Website

<http://myh66.com>

<http://usermanuals.us>

<http://www.somanuals.com>

<http://www.4manuals.cc>

<http://www.manual-lib.com>

<http://www.404manual.com>

<http://www.luxmanual.com>

<http://aubethermostatmanual.com>

Golf course search by state

<http://golfingnear.com>

Email search by domain

<http://emailbydomain.com>

Auto manuals search

<http://auto.somanuals.com>

TV manuals search

<http://tv.somanuals.com>