

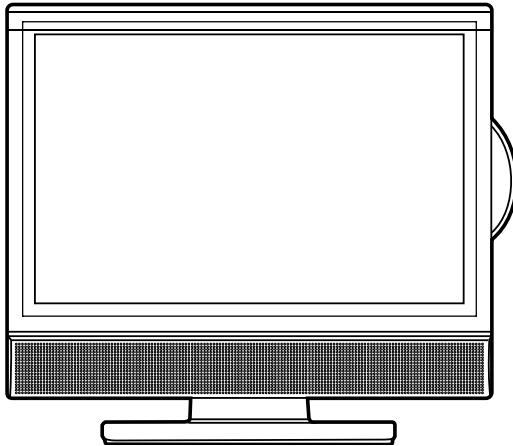

AUDIOVOX®
ELECTRONICS CORP.

FPE1908DV

19" HD FLAT PANEL LCD TV/DVD COMBO



OWNER'S MANUAL



FOR ASSISTANCE CALL CUSTOMER SERVICE AT 1-800-645-4994
OR VISIT US AT WWW.AUDIOVOX.COM

128-8329

SAFETY PRECAUTIONS



WARNING:

TO REDUCE THE RISK OF ELECTRIC SHOCK, DO NOT REMOVE COVER (OR BACK). NO USER-SERVICEABLE PARTS INSIDE. REFER SERVICING TO QUALIFIED SERVICE PERSONNEL. TO PREVENT FIRE OR SHOCK HAZARD, DO NOT EXPOSE THIS UNIT TO RAIN OR MOISTURE. DO NOT PLACE OBJECTS FILLED WITH LIQUIDS ON OR NEAR THIS UNIT.



The lightning flash with arrowhead symbol, within an equilateral triangle, is intended to alert the user to the presence of uninsulated "dangerous voltage" within the product's enclosure that may be of sufficient magnitude to constitute a risk of electric shock to persons.



The exclamation point within an equilateral triangle is intended to alert the user to the presence of important operating and maintenance (servicing) instructions in the literature accompanying the appliance.

CAUTION
INVISIBLE LASER RADIATION WHEN OPEN.
AVOID EXPOSURE TO BEAM.



This product contains a low power laser device.

CLASS 1 LASER
PRODUCT



The symbol for Class II (Double Insulation)



CAUTION:

- DANGER OF EXPLOSION IF BATTERY IS INCORRECTLY REPLACED. REPLACE ONLY WITH THE SAME OR EQUIVALENT TYPE.
- TO PREVENT ELECTRIC SHOCK, MATCH WIDE BLADE OF PLUG TO WIDE SLOT OF WALL OUTLET, THEN FULLY INSERT.
- USE OF CONTROLS OR ADJUSTMENTS OR PERFORMANCE OF PROCEDURES OTHER THAN THOSE SPECIFIED MAY RESULT IN HAZARDOUS RADIATION EXPOSURE.

PLACEMENT INFORMATION

- Do not use this unit in places that are extremely hot, cold, dusty, or humid.
- Do not restrict the airflow of this unit by placing it somewhere with poor airflow, by covering it with a cloth, or by placing it on bedding or carpeting.

SAFETY INFORMATION

- When connecting or disconnecting the AC power cord, grip the plug and not the cord itself. Pulling the cord may damage it and create a hazard.
- When you are not going to use the unit for a long period of time, disconnect the AC power cord.

CONDENSATION INFORMATION

- When left in a heated room where it is warm and damp, water droplets or condensation may form inside the unit. When there is condensation inside the unit, the unit may not function normally. Let the unit stand for 1-2 hours before turning the power on or gradually heat the room and allow the unit to dry before use.

RATING PLATE LOCATION

The rating plate is located on the rear of the unit.

FCC INFORMATION

NOTE: This equipment has been tested and found to comply with the limits for a Class B digital device, pursuant to part 15 of the FCC Rules. These limits are designed to provide reasonable protection against harmful interference in a residential installation. This equipment generates, used in accordance with the instructions, may cause harmful interference to radio communications. However, there is no guarantee that interference will not occur in a particular installation. If this equipment does cause harmful interference to radio or television reception, which can be determined by turning the equipment off and on, the user is encouraged to try to correct the interference by one or more of the following measures:

- Reorient or relocate the receiving antenna.
- Increase the separation between the equipment and receiver.
- Connect the equipment into an AC power outlet on a circuit different from that to which the receiver is connected.
- Consult the dealer or an experienced radio/TV technician for help.



WARNING: Changes or modifications to this unit not expressly approved by the party responsible for compliance could void the user authority to operate the equipment.

IMPORTANT SAFETY PRECAUTIONS

1. Read these instructions.
2. Keep these instructions.
3. Heed all warnings.
4. Follow all instructions.
5. Do not use this apparatus near water.
6. Clean only with a dry cloth.
7. Do not block any ventilation openings. Install in accordance with the manufacturer's instructions.
8. Do not install near any heat sources such as radiators, heat registers, stoves, or other apparatus (including amplifiers) that produce heat.
9. Do not defeat the safety purpose of the polarized or grounding-type plug. A polarized plug has two blades with one wider than the other. A grounding type plug has two blades and a third grounding prong. The wide blade or the third prong are provided for your safety. When the provided plug does not fit into your AC power outlet, consult an electrician for replacement of the obsolete outlet.
10. Protect the AC power cord from being walked on or pinched particularly at the plug, convenience receptacles, and the point where they exit from the apparatus.
11. Only use attachments/accessories specified by the manufacturer.
12. Use only with the cart, stand, tripod, bracket, or table specified by the manufacturer, or sold with the apparatus. When a cart is used, use caution when moving the cart/apparatus combination to avoid injury from tip-over.
13. Unplug this apparatus during lightning storms or when unused for long periods of time.
14. Refer all servicing to qualified service personnel. Servicing is required when the apparatus has been damaged in any way, such as the AC power cord or plug is damaged, liquid has spilled or objects have fallen into the apparatus, the apparatus has been exposed to rain or moisture, does not operate normally, or has been dropped.

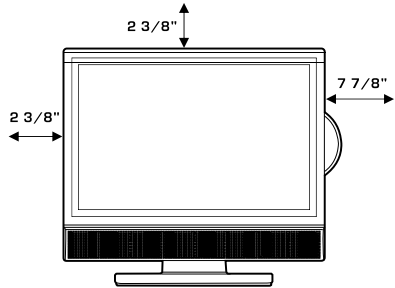

TABLE OF CONTENTS

SAFETY PRECAUTIONS	2	CD/DVD OPERATION	23 - 24
IMPORTANT SAFETY INSTRUCTIONS	3	Playing a Disc	23
TABLE OF CONTENTS	4	Playing a Picture File Disc	23
QUICK INSTALLATION	5	Pausing Playback (Still Mode)	23
DISC FORMATS	6	Stopping Playback	23
ACCESSORIES	7	Skipping to a Different Track	24
GETTING STARTED	7	Fast Forward/Fast Reverse	24
REMOTE CONTROL REFERENCE GUIDE	8 - 9	Slow-motion Play (DVD)	24
UNIT REFERENCE GUIDE	10 - 11	Audio Selection (DVD)	24
CONNECTIONS	12 - 15	Subtitle Selection (DVD)	24
Connecting a TV Antenna/Cable/ Satellite	12	Angle Selection (DVD)	24
Connecting an AV Device	12	SPECIAL FUNCTIONS	25
Connecting Devices with a Composite (Yellow RCA-Type) Video Output	13	Display Function (DVD)	25
Connecting Devices with a Composite (Yellow RCA-Type) Video Input ...	13	Locating a Specific Title (DVD) ...	25
Connecting a High-Definition (HD) Source	14	Locating a Specific Chapter/Track	25
Connecting a PC	14	Locating a Specific Time	25
Connecting an Audio Amplifier External Speaker	15	REPEAT PLAYBACK	26
Connecting the AC Power Cord ..	15	Repeating a Chapter/Title (DVD)	26
INSTALLATION	16	Repeating a Single Track/an Entire Disc (CD)	26
USING HEADPHONES	17	Repeating a Specific Section (DVD/ CD)	26
SOUND SYSTEM	17	DVD PROGRAMMABLE PLAYBACK	27
TV SETUP	18 - 22	Programmable Memory	27
PICTURE Menu	18	Title/Chapter Programmed Playback (DVD)	27
AUDIO Menu	18	CUSTOMIZING THE DVD FUNCTION SETTINGS	27-28
TIME Menu	19	Language Setup	27
SETUP Menu	19-20	Video Setup	28
PARENTAL Menu	20-21	System Setup	28
TV Menu	22	MAINTENANCE	29
		TROUBLE SHOOTING GUIDE	29 - 30

QUICK INSTALLATION

When you turn on your television set for the first time, be sure to place it on a solid stable surface. To avoid danger, do not expose the TV to water, or a heat source (e.g. lamp, candle, radiator). Do not obstruct the ventilation grid at the rear and be sure to leave sufficient gaps around the unit as shown.



TURNING ON THE UNIT FOR THE FIRST TIME

The first time you turn on the unit, the unit will enter SETUP mode. You can easily follow the prompt message on the screen to complete basic TV settings.

Make sure the RF aerial has been connected properly to the **TV ANTENNA** input jack on the rear of the unit.

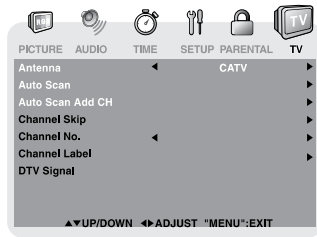
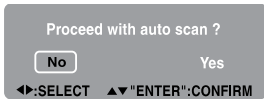

1. Press the ◀/▶ button to select Yes. Press the **ENTER** button to proceed with the initial setup.
2. Use the ▲ / ▼ button to select Antenna, then press the ◀/▶ button to select Air or CATV.

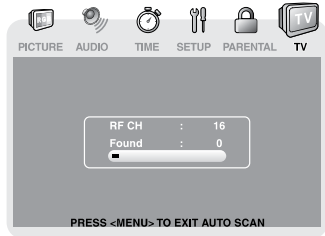
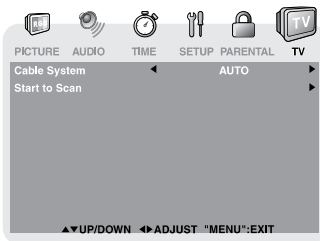

3. Use the ▲ / ▼ button to select Auto Scan, then press the ▶ button to enter auto scan menu. Use the ▲ / ▼ button to select Start to Scan, then press the ▶ button to begin scanning. (If you selected CATV on Step 2, you need to select Cable System before Start to Scan). The system will automatically start to scan and preset all available TV channels.
4. After scanning has finished, the system will return to the first TV channel scanned.

DISC FORMATS

This unit can playback:



DVDS
[8CM/12CM DISC]



AUDIO CDS
[8CM/12CM DISC]



CD-R/CD-RW
Compatible

REGION MANAGEMENT INFORMATION

Region Management Information: This unit is designed and manufactured to respond to the Region Management Information that is encoded on DVDs. If the region number printed on the DVD does not correspond to the region number of this unit, this unit cannot play that disc.

The region number of this unit is .

DISC FUNCTION OR OPERATION THAT IS NOT AVAILABLE

When the symbol appears on the screen, it indicates that the function or operation attempted is not available at that time. This occurs because the DVD manufacturer determines the specific functions. Certain functions may not be available on some discs. Be sure to read the documentation provided with the DVD.

ICONS USED ON DVDS

Sample Icons

Note:

- When playing back a CD-G (Graphics) or CD EXTRA disc, the audio portion will be played, but the graphic images will not be shown.

	1. English 2. French	Language selections for audio
	1. English 2. French	Language selections for subtitles
		Screen aspect ratio
		Multiple camera angles
		Region code indicator

TITLES, CHAPTERS AND TRACKS

- DVDs are divided into “titles” and “chapters”. If the DVD has more than one movie on it, each movie would be a separate “title”. “Chapters” are sections of titles.
- Audio CDs are divided into “tracks”. A “track” is usually one song on an Audio CD.

Note:

- Numbers identify each title, chapter, and track on a disc. Most discs have these numbers recorded on them, but some do not.

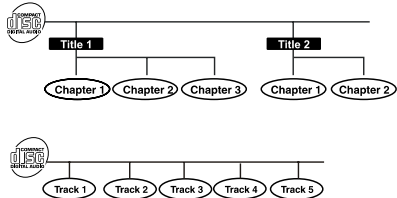

Notes on Unauthorized Discs:

You may not be able to play some DVDs on this unit if they were purchased from outside your geographical area or made for business purposes.

NOTES ON COPYRIGHT

It is forbidden by law to copy, broadcast, show, broadcast on cable, play in public, or rent copyrighted material without permission.

Apparatus Claims of U.S. Patent Nos. 6,836,549; 6,381,747; 7,050,698; 6,516,132; and 5,583,936 licensed for limited viewing uses only.

This product incorporates copyright protection technology that is protected by U.S. patents and other intellectual property rights. Use of this copyright protection technology must be authorized by Macrovision, and is intended for home and other limited viewing uses only unless otherwise authorized by Macrovision. Reverse engineering or disassembly is prohibited.

ACCESSORIES

PLEASE LOCATE THE INCLUDED ACCESSORIES.

- Remote Control x 1
- AAA Batteries x 2

Specifications and appearance are subject to change without notice.

GETTING STARTED

USING THE REMOTE CONTROL

- Point the remote control at the REMOTE SENSOR located on the unit.
- When using this unit in bright light, the infrared REMOTE CONTROL SENSOR may not work properly.
- The recommended effective distance for using the remote control is about 16 feet.

TO CHANGE THE REMOTE CONTROL BATTERIES

1. Open the battery door.
2. Insert two "AAA" batteries.

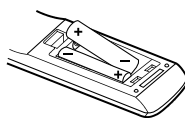
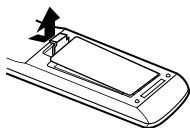

BATTERY REPLACEMENT

When the batteries become weak, the operating distance of the remote control will be greatly reduced and you will need to replace the batteries.

⚠ CAUTION:
Danger of explosion if battery is incorrectly replaced.

- Note:**
- If the remote control is not going to be used for a long time, remove the batteries to avoid damage caused by battery leakage corrosion.
 - Do not mix old and new batteries. Do not mix ALKALINE, standard (CARBON-ZINC) or rechargeable (NICKEL-CADMIUM) batteries.
 - Always remove batteries as soon as they become weak.
 - Weak battery can leak and severely damage the remote control.

⚠ WARNING:
Do not dispose of batteries in a fire. They may leak and/or explode.

Many universal remote controls have a "learning" feature. We recommend you use that feature to program the remote control.

For any questions or problems related to programming a universal remote control, you must contact the customer service department of the universal remote control manufacturer for assistance, or refer to the instructions included with the universal remote control. We cannot offer assistance in programming universal remote controls.

REMOTE CONTROL REFERENCE GUIDE

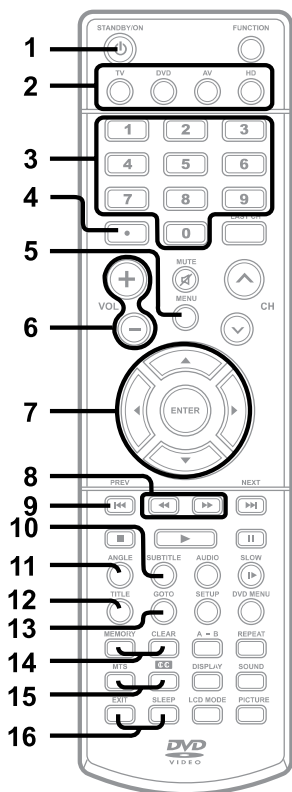



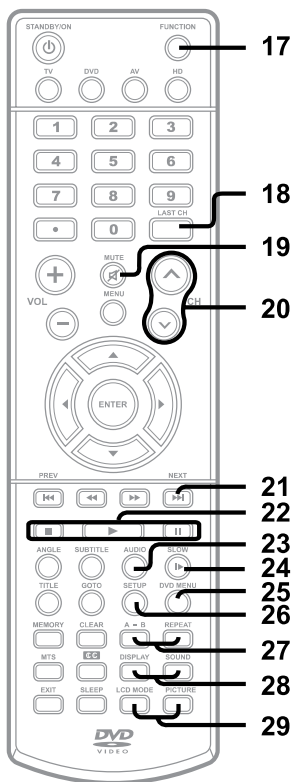

1. **STANDBY / ON Button**
Press to turn ON the unit or put it in STANDBY (OFF) mode.
2. **TV Button**
Press to switch to TV mode.
DVD Button
Press to switch to DVD mode.
AV Button
Press to switch to source connected to AV1 (composite) inputs.
HD Button
Press to switch to source connected to YUV in (component) inputs.
3. **Number (0 - 9) Buttons**
4. **[dot] Button**
Press to enter digital sub-channels (i.e. 11.3 or 12.7)

5. **MENU Button**
Press to display the on-screen TV menu.
6. **VOLUME (- / +) Buttons**
Press to adjust the volume level.
7. **CURSOR (▲, ▼, ◀, ▶) Buttons**
Press to highlight selections on a menu screen and adjust certain settings.
ENTER Button
Press to confirm selections on a menu screen.
8. **◀◀ / ▶▶ Buttons**
◀◀: Fast reverse playback.
▶▶: Fast forward playback.
9. **PREV ◀◀ Button**
Press to select previous chapters or tracks on a disc.
10. **SUBTITLE Button**
Press to select one of the subtitle languages programmed on a DVD.
11. **ANGLE Button**
Press to switch the camera angle of the video presentation when scenes with multiple camera angles are recorded on a DVD.
12. **TITLE Button**
Press to show title menu.
13. **GOTO Button**
Press to skip directly to a specific location on a DVD/CD.
14. **MEMORY Button**
Press to set predetermined playback.
CLEAR Button
Press to clear input selections.
15. **MTS (Multi Channel Television Sound) Button**
Press to select between MONO sound, STEREO sound and Secondary Audio Program (SAP).
CC Button
Press to activate the Closed Captioning feature. This function only works on programs broadcasted with captions.
16. **EXIT Button**
Press to exit the TV SETUP menu and return directly to normal viewing.
SLEEP Button
Press to set the SLEEP timer. The unit will remain on for the time that is set, and will automatically shut off afterwards.

REMOTE CONTROL REFERENCE GUIDE



- 17. FUNCTION Button**
Press to switch between TV / AV In / YUV In / DVD / PC In.
- 18. LAST CH Button**
Press to switch repeatedly between the last two channels displayed.
- 19. MUTE  Button**
Press to turn off the sound.
- 20. CH  / CH  Buttons**
Press to change the TV channels.
- 21. NEXT  Button**
Press to select the next title, chapter or track on a disc.

- 22. ■ Button**
Press to stop playing a disc.
▶ PLAY Button
Press to start and resume playback of a disc.
- || PAUSE Button**
Press to pause playback and single frame advance.
- 23. AUDIO Button**
Press to select audio soundtracks on a DVD or change the output mode of a CD.
- 24.  SLOW Button**
Press to perform slow forward playback of a DVD.
- 25. DVD MENU Button**
Press to enter the main menu of the DVD.
- 26. SETUP Button**
Press to enter and exit the SETUP menu of the DVD.
- 27. A-B Button**
Press to perform point-to-point repeat playback on a DVD or CD.
REPEAT Button
Press to repeat a chapter or title of a DVD.
Press to repeat a single track or whole CD.
- 28. DISPLAY Button**
Press to change disc status information displayed on the screen.
SOUND Button
Press to select from preset sound settings to match the type of show you are watching (Music / Standard / Personal / Movie).
- 29. LCD MODE Button**
Press to set size of LCD display (WIDE / 4:3 / LCD OFF).
PICTURE Button
Press to select from preset screen display settings to match the type of show you are watching (Standard / Soft / Movie / Personal).

UNIT REFERENCE GUIDE

FRONT, LEFT & RIGHT SIDE VIEW

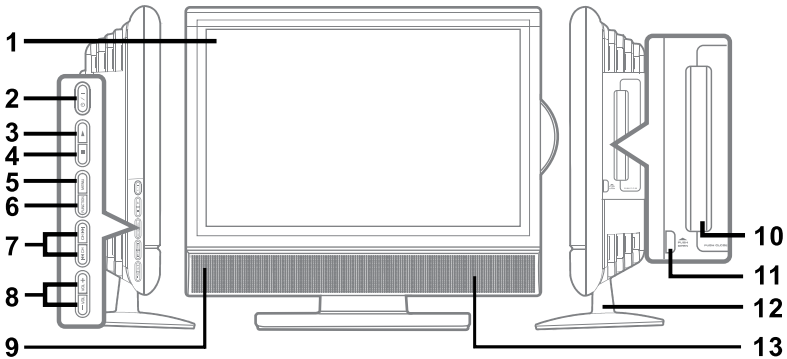

- 1) **Color LCD Screen**
- 2) **⏻/⏻ Button**
Press to turn the unit on and off.
- 3) **▶ PLAY Button**
Press to start or resume playback of a disc.
- 4) **■ STOP Button**
Press to stop playing a disc.
- 5) **MENU Button**
Press to enter and exit the TV menu.
- 6) **FUNCTION Button**
Press to select TV, AV In, YUV In, DVD, or PC In.
- 7) **CH Buttons**
Press to select a TV channel.
◀◀ Button
Press to select previous chapters or tracks on a disc.
▶▶ Button
Press to select the next title, chapter or track on a disc.
- 8) **-VOL + Controls**
Press to adjust the volume level.
- 9) **STANDBY Indicator**
Indicates whether the unit is ON or in STANDBY (OFF) mode.
Light On: The unit is in STANDBY.
Light Off: The unit is turned ON.
REMOTE SENSOR
Do not block this sensor or remote control will not work.
- 10) **Disc Door**
Push gently to close the disc door.
- 11) **▲ PUSH OPEN Button**
Press to open the disc door.
- 12) **Removable Stand**
- 13) **Speakers**

UNIT REFERENCE GUIDE

BACK VIEW

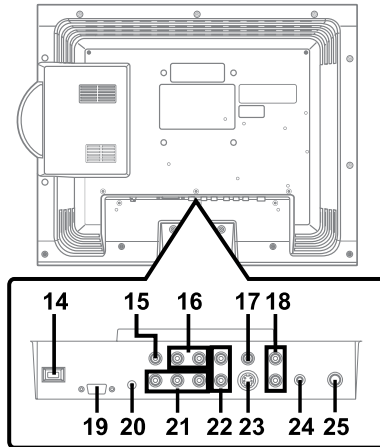

- | | |
|---|---|
| 14) AC Power Cord | 20) AUDIO Jack - PC IN |
| 15) VIDEO OUT Jack - AV OUT | 21) COMPONENT VIDEO IN Jacks (Y/PB/PR) - YUV IN |
| 16) AUDIO OUT Jacks (Left/Right) - AV OUT | 22) AUDIO IN Jacks (Left/Right) - YUV IN |
| 17) VIDEO IN Jack - AV IN | 23) S-VIDEO Jack - AV IN |
| 18) AUDIO IN Jacks (Left/Right) - AV IN | 24) HEADPHONES Jack |
| 19) MONITOR/VGA Jack - PC IN | 25) TV Antenna Terminal |

CONNECTIONS

CONNECTING A TV ANTENNA/CABLE/SATELLITE

To view television channels correctly, a signal must be received from one of the following sources:

- An indoor or outdoor aerial antenna
- A cable system
- A satellite system

Connecting a Digital Antenna

The tuner in this TV receives ATSC TV signals from an antenna. This digital TV can receive standard (SDTV) and high definition (HDTV) over the air broadcasts.

Connecting an Analog Antenna or Device

The tuner in this TV receives NTSC TV signals, analog cable signals or the RF output from a satellite receiver, VCR or cable box.

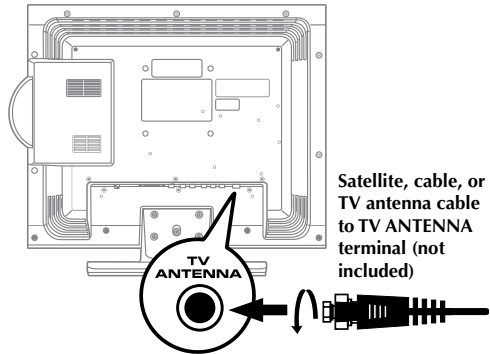

CONNECTING AN A/V DEVICE

Connecting to Devices with an S-Video Output

To connect to A/V devices such as a VCR, camcorder, satellite system or cable, etc.

Connecting to a VCR/ Camcorder / Satellite System / Cable

Connect the AUDIO and S-VIDEO cable (not included) as shown.

Make sure you connect the cable from the other equipment (AUDIO OUT and S-VIDEO OUT) to this unit (AUDIO IN and S-VIDEO IN)

Note:

Please refer to the user manual for the other equipment for more information.

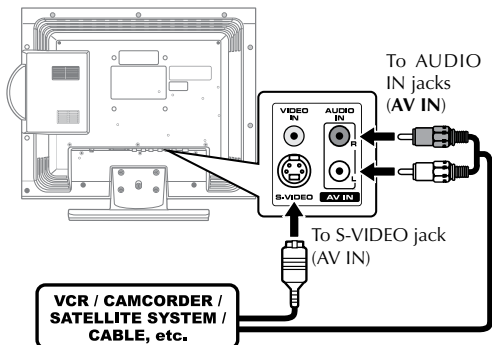

To AUDIO OUT and S-VIDEO OUT jacks

CONNECTIONS

CONNECTING DEVICES WITH A COMPOSITE (YELLOW RCA-TYPE) VIDEO OUTPUT

To connect A/V devices such as a VCR, video game system or camcorder:

Connecting to a VCR / Video Game System / Camcorder

Connect the AUDIO / VIDEO cable (not included) as shown.

Make sure you connect the cable from the other equipment (AUDIO and VIDEO OUT) to this unit (AUDIO and VIDEO IN)

Note: Please refer to the user manual for the other equipment for more information.

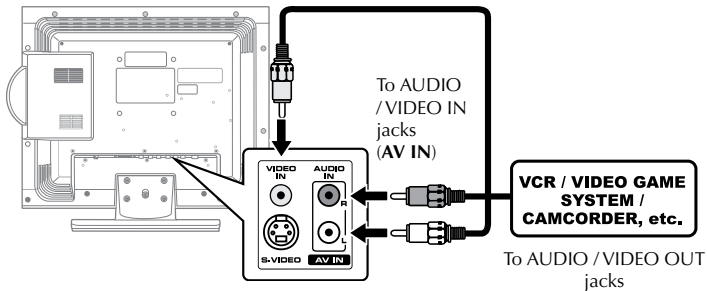

CONNECTING DEVICES WITH A COMPOSITE (YELLOW RCA-TYPE) VIDEO INPUT

To connect A/V devices such as a VCR, PVR or camcorder:

Connecting a VCR / PVR / Camcorder

Connect the AUDIO / VIDEO cable (not included) as shown.

Make sure you connect the cable from the other equipment (AUDIO and VIDEO IN) to this unit (AUDIO and VIDEO OUT).

Note:

- Please refer to the user manual for the other equipment for more information.
- After connection, please operate in TV/AV mode.
- For the reason of copyright protection, the resulting copy may have bad picture and/or sound.

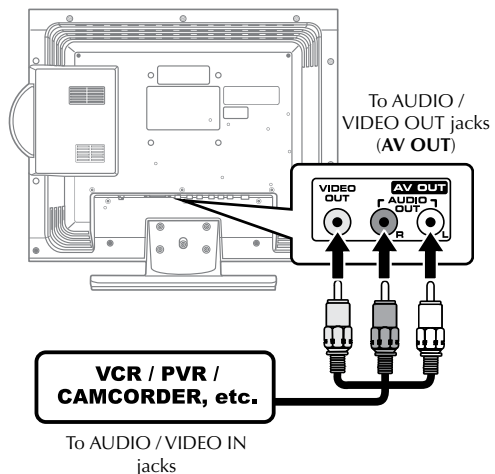

CONNECTIONS

CONNECTING A HIGH-DEFINITION (HD) SOURCE

High-Definition (HD) Devices with component video output must be connected to the YUV input.

Connect the component video cable and audio cable (not included) as shown.

Make sure you connect the component video cable and audio cable from the other equipment (**COMPONENT VIDEO OUT** and **AUDIO OUT**) to this unit (**COMPONENT VIDEO IN** and **AUDIO IN - YUV IN**).

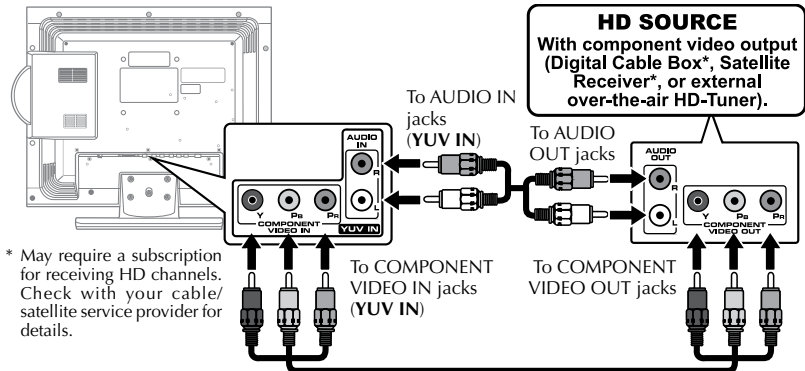

Note:

When connecting a DVD player to the television, the picture resolution is solely dependent upon the resolution supported by the DVD player attached. DVD player resolutions vary from 480i to 1080i, and this television can support DVD players up to a maximum resolution of 1080i.

CONNECTING A PC

Connect the 15-pin D-SUB PC/VGA connector from your computer to the 15-pin D-SUB PC/VGA input on this unit using a monitor cable and audio cable (not included) as shown.

Make sure you connect the cable from the computer (**PC Connector** and **AUDIO - PC OUT**) to this unit (**MONITOR / VGA** and **AUDIO - PC IN**).

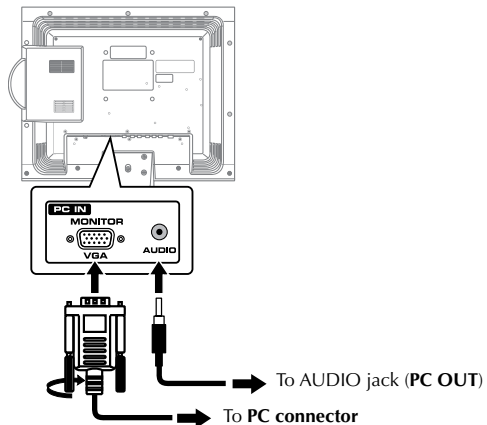

CONNECTIONS

CONNECTING AN AUDIO AMPLIFIER/EXTERNAL SPEAKERS

This connection allows you to use an audio amplifier and external speakers.

Connect the AUDIO cable (not included) as shown.

Make sure you connect the cable from the other equipment (**AUDIO IN**) to this unit (**AUDIO OUT**).

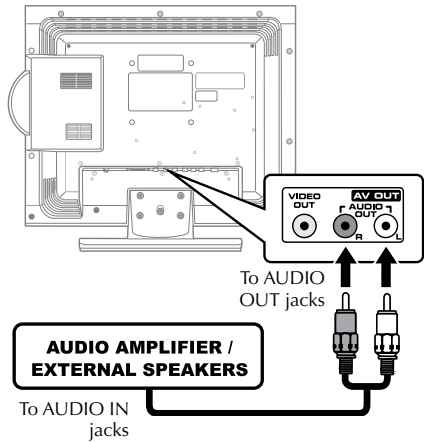

CONNECTING THE AC POWER CORD

- Connect the AC power cord into a wall outlet.
- Press the Φ / \mathbf{I} button on the left side of the unit or use the remote control to turn on the unit.

Note:

- **To prevent electrical shock, match wide blade of AC power cord to wide slot of AC power outlet, then fully insert.**
- Be sure the AC power cord is disconnected and all functions are off before making connections.
- Make sure all components are connected correctly.
- When you are not going to use the unit for a long period of time, disconnect the AC power cord.

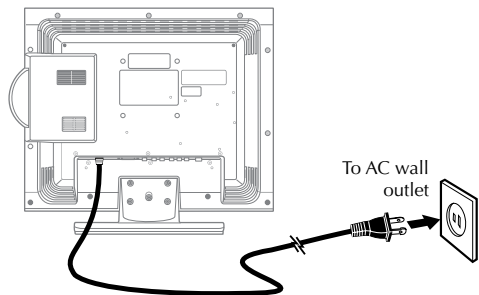

INSTALLATION

REMOVING THE BASE STAND

WARNING: The LCD Display is very fragile, and must be protected at all times when removing the base stand. Be sure that nothing hard or sharp, or anything that could scratch or damage the LCD display, come in contact with it. Do NOT place pressure on the front of the unit at any time because the screen could crack.

1. Disconnect any cables or cords connected to the unit.
2. Lay the unit down on a flat surface, so the back side is facing up, making sure to place a soft cushioned material (such as a pillow or thick piece of foam) beneath the screen.
3. Remove the four screws and then remove the BASE STAND from the unit.

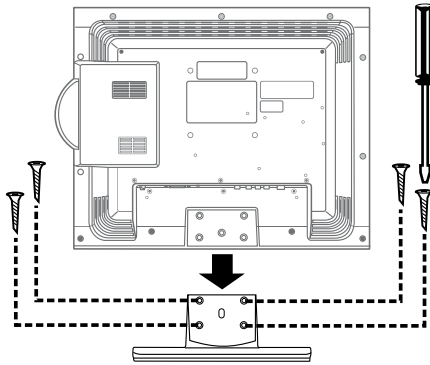

MOUNTING ON THE WALL

This unit is VESA-compliant, and is designed to be wall-mounted with a VESA-compliant 3 15/16" x 3 15/16" (100mm x 100mm) mounting kit designed for flat-panel TVs (sold separately). Mount this unit according to the directions included with the mounting kit.

Note: You must remove the base stand before mounting the unit on the wall.

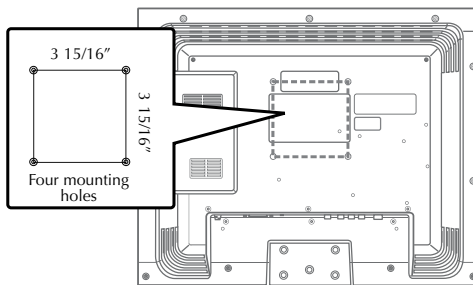

USING HEADPHONES

- Turn down the volume before connecting headphones to the unit, then adjust the volume to your desired level.
- When headphones are connected, no sound will come from the front speakers.

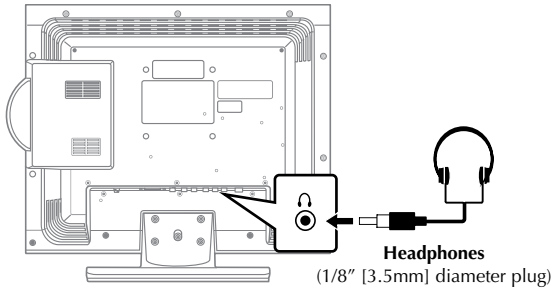

Note:

Avoid listening to sound at high levels for prolonged periods of time. This may be harmful to you and may cause hearing loss.

SOUND SYSTEM

DOLBY DIGITAL (FOR DVD)

Dolby Digital is a sound system developed by Dolby Laboratories Inc. This unit automatically recognizes DVDs that have been recorded with Dolby Digital.

Not all Dolby Digital sources are recorded with 6 channels.

Some sources marked Dolby Digital may be recorded in Dolby Surround, a 2 channel system. Look for this logo on your unit.



Manufactured under license from Dolby Laboratories.

'Dolby' and the double-D  symbol are trademarks of Dolby Laboratories.

TV SETUP

Note: Some setting items on the menu screen may not activate depending on the mode selected (TV / AV in / YUV in / DVD / PC in).

PICTURE MENU

1. Press the **MENU** button.
2. Press the **▼** button to enter PICTURE settings.
3. Use the **▲** or **▼** button to select the options (**Picture Mode**, **Contrast**, **Brightness**, **Sharpness**, **Tint** or **Color**). Adjust them using the **◀** or **▶** button (Screen will change to your desired setting).
4. Repeat step 3 to adjust other options.
5. To exit the MAIN MENU and return to the normal screen, press the **EXIT** or **MENU** button repeatedly.

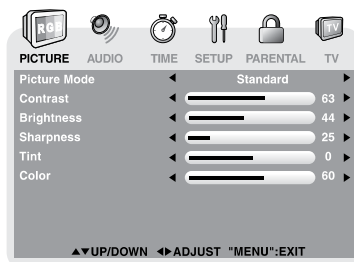

Picture Mode : Select from preset screen display settings to match the type of show you are watching (Standard, Soft, Movie & Personal). Select Personal mode to recall your custom settings on contrast, brightness, sharpness, tint and color.

Contrast : Adjust to sharpen the picture quality. The black portions of the picture become richer in darkness and the white become brighter.

Brightness : Adjust the brightness of the picture. Brighten or darken the whole picture.

Sharpness : Adjust the sharpness level to improve detail in the picture.

Tint : Adjust the tint of the picture (toward purple / toward green).

Color : Adjust the color of the picture.

AUDIO MENU

1. Press the **MENU** button.
2. Use the **◀** or **▶** button to select **AUDIO**, then press the **▼** button to enter the **AUDIO** settings.
3. Use the **▲** or **▼** button to select the options (**Sound Mode**, **Bass**, **Treble**, **Balance**, **Audio Language** or **MTS**). Adjust them using the **◀** or **▶** button.
4. Repeat step 3 to adjust other options.
5. To exit the MAIN MENU and return to the normal screen, press the **EXIT** or **MENU** button repeatedly.

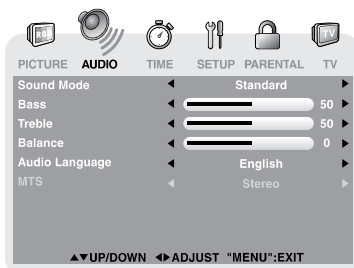

Note:

Experiment with different sound settings until you find the settings you prefer.

Sound Mode : Select from preset sound settings (Standard, Music, Movie or Personal) to match the type of show you are watching. Select Personal mode to recall your custom settings on bass, treble and balance.

Bass : Adjust the bass range.

Treble : Adjust the treble range.

Balance : Adjust the balance level toward the left or right speakers.

Audio Language : Select from English / Spanish / French. (Available for digital channels if multiple audio languages are broadcasted.)

MTS (Multi Channel Television Sound) : Select Stereo / SAP (Secondary Audio Program) or Mono.

Note:

The SAP (Secondary Audio Programs) feature allows a TV station to broadcast other information, which could be audio in another language.

TV SETUP

TIME MENU

1. Press the **MENU** button.
2. Use the ◀ or ▶ button to select **TIME**, then press the ▼ button to enter the **TIME** settings.
3. Use the ▲ or ▼ button to select the options (**OSD Duration**, **Sleep Timer**, **Time Zone** or **Day Saving Time**). Adjust them using the ◀ or ▶ button.
4. Repeat step 3 to adjust other options.
5. To exit the **MAIN MENU** and return to the normal screen, press the **EXIT** or **MENU** button repeatedly.

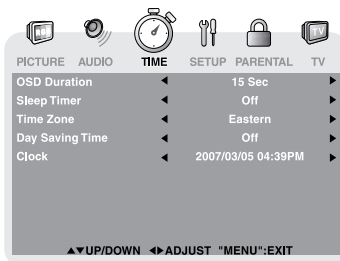

OSD (On Screen Display) Duration : Select the length of time the On screen menu is displayed : 15 Sec / 30 Sec / 45 Sec / 60 Sec.

Sleep Timer : Select the length of time before the unit automatically changes to Standby mode : Off -> 5 Minutes -> 10 Minutes -> 15 Minutes -> 30 Minutes -> 60 Minutes -> 90 Minutes -> 120 Minutes -> Off.

Time Zone : Select the time zone from Eastern / Central / Mountain / Pacific / Alaska / Hawaii.

Day Saving Time : Select On to activate daylight savings time.

Clock : Display the current time.

SETUP MENU

1. Press the **MENU** button.
2. Use the ◀ or ▶ button to select **SETUP**, then press the ▼ button to enter the **SETUP** settings.
3. Use the ▲ or ▼ button to select the options (**OSD Language**, **Color Mode**, **PC Set Up**, **Closed Caption** or **Restore Setting**). Adjust them using the ◀ or ▶ button (The screen will change to your desired setting); or press the ▶ button to go into the detailed settings.
4. Press the **MENU** button to return to the previous menu.
5. Repeat steps 3 and 4 to adjust other options.
6. To exit the **MAIN MENU** and return to the normal screen, press the **EXIT** or **MENU** button repeatedly.

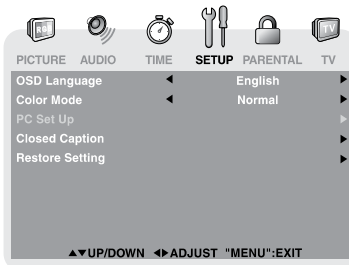

OSD (On Screen Display) Language : Select On-screen menu language from English / French / Spanish.

Color Mode : Adjust the three color temperature of the picture. Choose from Normal (balanced), Warm (red white), or Cool (blue white) modes.

Restore Setting : If you reset the TV to the factory settings, all your present settings on **PICTURE** and **AUDIO** will be erased and replaced by the factory's default settings.

TV SETUP

PC Set Up (in PC mode only)

- Resolution : 1,440 x 900 max
- Refresh Frequency : 60Hz max

H - Pos : Center the image by moving it left or right.

V - Pos : Center the image by moving it up or down.

Clock : Adjusts the display clock to change width of the image.

Phase : Adjusts the image if there is flicker of screen letters, color misalignment, or blurring.

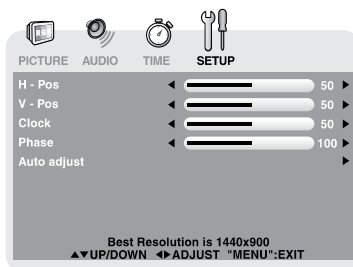

Closed Caption

Note:

This function only works on ATSC programs broadcast with captions.

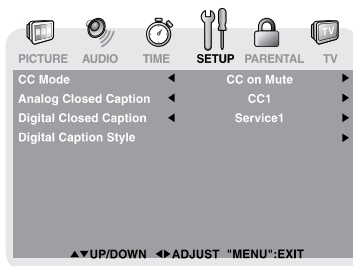

CC Mode

: Select closed caption On, Off or CC on Mute.

Analog Closed Caption

: Select the analog closed caption or turn it off.

Digital Closed Caption

: Select the digital closed caption or turn it off.

Digital Caption Style

: Select As Broadcaster to use the default digital caption style of the broadcaster. Select Custom to activate the caption style items and set your desired detailed settings.

PARENTAL MENU

Password

1. Press the **MENU** button.
2. Use the ◀ or ▶ button to select **PARENTAL**, then press the ▼ button to enter the **PARENTAL** settings. The menu locked screen will be displayed.
3. Enter a 4-digit password. Once entered, the screen will enter the Parental menu. The preset password is 0000.



**If you forget the password,
enter " 8888 " to unlock parental control.**

TV SETUP

Parental

1. Use the ▲ or ▼ button to select various Parental settings. Adjust them using the ◀ or ▶ button, or press the ▶ button to go into the detailed settings.
2. Press the **MENU** button to return to the previous menu.
3. Repeat steps 1 - 2 to adjust other options.
4. To exit the MAIN MENU and return to the normal screen, press the **EXIT** or **MENU** button repeatedly.

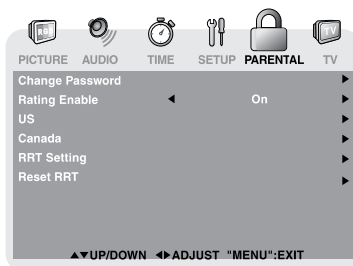

Rating Enable : Select On to edit the following parental items. Select Off to disable parental control.

US : Set TV and MPAA ratings.

Canada : Set Canada English and Canada French ratings.

RRT Setting : Set Rating Region Table.

Reset RRT : Reset Rating Region Table to the default settings.

U.S. TV Ratings	<p>TV-Y : Recommended for all children. TV-Y7 : Recommended for all children age 7 and above. TV-G : General Audience. TV-PG : Parental Guidance Suggested. TV-14 : Parental Strongly Cautioned. TV-MA : Mature Audience Only.</p>
U.S. MPAA Ratings	<p>N/A : Not rated. G : GENERAL AUDIENCES, Suitable for all ages. PG : PARENTAL GUIDANCE SUGGESTED - Some material may not be suitable for children. PG-13 : PARENTS STRONGLY CAUTIONED - Some material may be inappropriate for children under 13. R : RESTRICTED, Under 17 requires accompanying parent or adult guardian for viewing in movie theaters. NC-17 : No one 17 or under admitted in movie theaters, X : Adults Only.</p>
Canadian English Ratings	<p>E : Exempt. C : Children. C8+ : Recommended for children age 8 and older. G : GENERAL AUDIENCES, Suitable for all ages. PG : PARENTAL GUIDANCE SUGGESTED - Some material may not be suitable for children. 14+ : Viewers 14 years and older. 18+ : Adult Programming.</p>
Canadian French Ratings	<p>E : Exempt. G : GENERAL AUDIENCES, Suitable for all ages. 8 ans+ : Not recommended for young children. 13 ans+ : Not suitable for children under the age of 13. 16 ans+ : Not suitable for children under the age of 16. 18 ans+ : Adult Programming.</p>

TV SETUP

TV MENU (For TV Mode Only)

1. Press the **MENU** button.
2. Use the ◀ or ▶ button to select TV, then press the ▼ button to enter the TV settings.
3. Use the ▲ or ▼ button to select the options (**Antenna**, **Auto Scan**, **Auto Scan Add CH**, **Channel Skip**, **Channel No.**, **Channel Label** or **DTV Signal**). Adjust them using the ◀ or ▶ button, or press the ▶ button to go into the detailed settings.
4. Press the **MENU** button to return to the previous menu.
5. Repeat steps 3 and 4 to adjust other options.
6. To exit the MAIN MENU and return to the normal screen, press the **EXIT** or **MENU** button repeatedly.

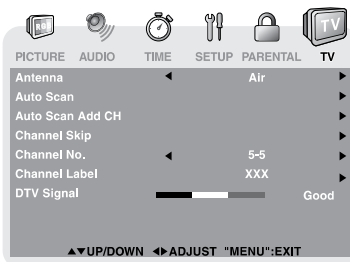

- Antenna** : Air (over-the-air broadcasts, Ch 2-69) or CATV (cable/satellite broadcasts, CH 1-135) mode are available.
- Auto Scan** : Search for usable stations and store them in memory.
- Auto Scan Add CH** : Search for more usable stations and add them in memory. The stations stored before are still kept.
- Channel Skip** : Skip weak channels and the channels you don't like.
- Channel No.** : Select a different TV channel.
- Channel Label** : Display and edit the channel label.
- DTV Signal** : Display the signal strength (for digital TV channels only).

Channel Skip

1. Use the ▲ or ▼ button to select a channel. (Press the ▶ button to select the last channel of the page; press again to go to the next page. Press the ◀ button to select the first channel of the page; press again to return the previous page.)
2. Press the **ENTER** button to shift between On / Off. (Select On to skip the selected channel. The channel will not appear when you press the **CH ▲ / CH ▼** button.)

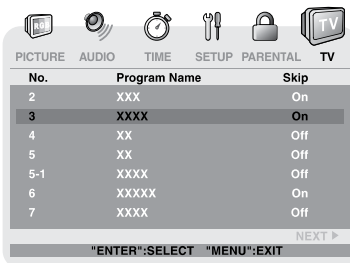

Channel Label

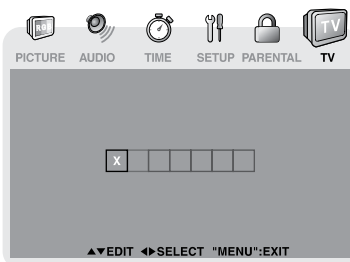

You can edit a label for each channel.

1. Use the ▲ or ▼ button to select the number or letter. Use the ◀ or ▶ button to move and edit the next character. Press the **ENTER** button to confirm.
2. After editing, the Channel and Channel Label will be shown on the screen when you press the **DISPLAY** button.



CD/DVD OPERATION

This owner's manual explains the basic instructions of this unit. Some DVDs are produced to limit operation during playback. For example, many DVDs do not allow users to skip government warnings, or in some cases previews or other features. This is not a defect in the unit. Refer to the instruction notes of discs.

" " may appear on the screen during operation. A " " means that the desired operation is not permitted by the unit or disc.

PLAYING A DISC

1. Press the **STANDBY/ON** button to turn the unit on.
2. Press the **FUNCTION** button to select DVD mode.
See **CUSTOMIZING THE DVD FUNCTION SETTINGS** before proceeding to step 3.
3. Press the **▲ PUSH OPEN** button to open the disc door.
4. Hold the disc by its edge and gently push it onto the spindle, with the label side facing the front, until you hear a "click".
5. Push the disc door gently to close it. It takes a short while for your unit to load the disc. After loading, for most DVDs, the unit will automatically take you main menu or start playing. If the unit does not automatically start playing the DVD, press the **▶ PLAY** button.

PLAYING A PICTURE FILE DISC

This unit can play picture files recorded on CD-R and CD-RW discs.

1. Press the **▲ PUSH OPEN** button to open the disc door.
2. Hold the disc by its edge and gently push it onto the spindle, with the label side facing the front, until you hear a "click".
3. Push the door gently to close it. The picture files on the disc will be displayed one by one automatically.
4. Press the **■ STOP** button to go to the folder list.
5. Press the **▲** or **▼** button to highlight a file to play. Press the **▶ PLAY** button to start playback.

Note:

- You can press the **⏸ PAUSE** button to interrupt playback, and press the **▶ PLAY** button to resume playback.
- You also can use the **GOTO** function or use the numbered buttons to enter the image number to quickly select any image.
- Press the **ANGLE** button on the remote control to rotate the picture orientation by 90°.

PAUSING PLAYBACK (STILL MODE)

Press the **⏸ PAUSE** button. To resume normal playback, press the **▶ PLAY** button. Each time you press the **⏸ PAUSE** button, the picture advances one frame.

STOPPING PLAYBACK

Press the **■ STOP** button at the location where you want to interrupt playback. To resume playback at the position where the disc was stopped, press the **▶ PLAY** button.

If you press the **■ STOP** button twice, the unit's memory will be cleared and pressing the **▶ PLAY** button will reset the disc to the beginning.

SKIPPING TO A DIFFERENT TRACK

- Press the **⏮ PREV** button to go back to previous chapters/tracks.
- Press the **⏭ NEXT** button to advance chapters/tracks.
- For an Audio CD, use the number buttons (remote control only) to go directly to that track number.

CD/DVD OPERATION

FAST FORWARD/FAST REVERSE

1. Press the **SEARCH** ◀◀ or ▶▶ **SEARCH** button when a disc is playing.
 - Each time the **SEARCH** ◀◀ or ▶▶ **SEARCH** button is pressed, the speed of fast scan changes in the following sequence:

▶▶ 2x → ▶▶ 4x → ▶▶ 8x → ▶▶ 16x ◀◀ 2x → ◀◀ 4x → ◀◀ 8x → ◀◀ 16x

2. Press the ▶ **PLAY** button when you reach the desired point to resume playback at normal speed.

SLOW-MOTION PLAY (DVD)

1. In Play mode, press the ▶ **SLOW** button on the remote control. Each time the ▶ **SLOW** button is pressed, the speed of slow-motion playback changes in the following sequence:

▶ 1/2 → ▶ 1/4 → ▶ 1/8 → ▶ 1/16

2. Press the ▶ **PLAY** button to return to normal playback speed.

AUDIO SELECTION (DVD)

On some discs, the sound is recorded in two or more formats. Follow the directions below to select the preferred language and sound system.

1. While a disc is playing, press the **AUDIO** button to show the current audio format number.

Audio 1/3: Dolby D 2ch English

2. Press the **AUDIO** button repeatedly to select the desired audio format.

Note:

- If only one audio format is recorded, the number does not change.
- About two seconds later, playback continues in the new audio format.

SUBTITLE SELECTION (DVD)

1. While a DVD is playing, press the **SUBTITLE** button to display the current language setting, as shown in the example.
2. Press the **SUBTITLE** button repeatedly to select the desired subtitle language.

Subtitle 02/03: Spanish

Note:

- If only one language is recorded, the language does not change.
- About two seconds later, playback continues with the new subtitle selected.
- The number of languages recorded differs depending on the disc.
- This function can only be used for discs on which subtitles have been recorded in multiple languages.
- On some DVDs, subtitles are activated from the main menu of the DVD. Press the **DVD MENU** button to activate the main menu.

ANGLE SELECTION (DVD)

Some DVDs contain scenes that have been shot from a number of different angles. For these discs, the same scene can be viewed from each of these different angles.

1. While you are playing a DVD with different angles recorded, press the **ANGLE** button to view the number of current angles available.
2. Press the **ANGLE** button repeatedly to change the scene to the next angle in those recorded.
 - About two seconds later, playback continues from the new angle selected.
 - If no button is pressed within 10 seconds, playback continues without changing the current angle.

1/3

Sequence of angle shots
(Example)



Note:

- This function can only be used for discs on which scenes shot from multiple angles have been recorded.
- If only one angle is recorded, "1/1" is displayed.

SPECIAL FUNCTIONS

DISPLAY FUNCTION (DVD)

While the disc is playing, press the **DISPLAY** button repeatedly to display information on operation status:

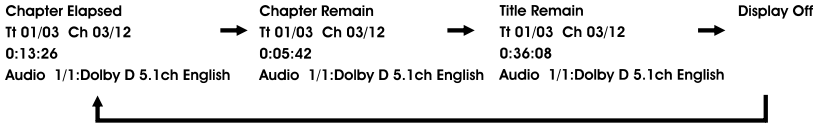

LOCATING A SPECIFIC TITLE (DVD)

If a DVD contains title numbers, you can locate a specific title by directly selecting a title number.

1. In **STOP** mode, press the **GOTO** button. **Title 01/03 Chapter 00/00**
2. Press the **◀** or **▶** button to highlight a specific field and press the corresponding number button(s) for the title you want.
3. Press the **ENTER** button to confirm. Playback starts from the selected title.

LOCATING A SPECIFIC CHAPTER / TRACK

If you know the chapter / track number you want to play, you can locate a specific chapter / track by directly selecting a chapter / track number.

1. Press the **GOTO** button to search for your desired chapter / track. **Title 01/03 Chapter 01/12**
2. Press the **◀** or **▶** button to highlight a chapter / track then press the corresponding number button(s) for the chapter / track you want.
3. Press the **ENTER** button to confirm. Playback starts from the selected chapter / track.

LOCATING A SPECIFIC TIME

You can move to a specific location by entering its corresponding time (hours, minutes, seconds)

1. Press the **GOTO** button twice. **Title 01/03 Time 00:00**
2. Press the corresponding number buttons for the setting point you want.
3. Press the **ENTER** button to confirm. Playback starts from the selected location.

Note:

- Some discs may not respond to this process.
- Some scenes may not be located as precisely as specified.
- This method for accessing specific locations is available only within the current title of the DVD.

REPEAT PLAYBACK

You can play a specific title or chapter repeatedly. (Title repeat, chapter repeat, A-B repeat)

REPEATING A CHAPTER (DVD)

You can play the same chapter repeatedly.

1. While the disc is playing, press the **REPEAT** button until the “ Chapter” indicator displays on the screen. The current chapter is played repeatedly.

REPEATING A TITLE

You can play the same title repeatedly.

2. While the disc is playing, press the **REPEAT** button until the “ Title” indicator displays on the screen. The current title is played repeatedly.

TO RESUME NORMAL PLAYBACK

3. While the disc is playing, press the **REPEAT** button until the “Repeat Off” indicator displays on the screen.

You can play a single track or an entire disc repeatedly.

REPEATING A SINGLE TRACK (CD)

You can play the same track repeatedly.

1. While the disc is playing, press the **REPEAT** button until the “Repeat One” indicator displays on the screen. The current track is played repeatedly.

REPEATING AN ENTIRE DISC



2. While the disc is playing, press the **REPEAT** button until the “Repeat All” indicator displays on the screen. The entire disc is played repeatedly.

TO RESUME NORMAL PLAYBACK

3. Press the **REPEAT** button until the “Off” indicator displays on the screen.

REPEATING A SPECIFIC SECTION (DVD) (CD)

You can play a specific section repeatedly.

1. While the disc is playing, press the **A-B** button at the beginning of the section ( A is displayed) you want to play repeatedly.
2. Press the **A-B** button again at the end of the section ( AB is displayed) you want to play repeatedly.
3. The unit will immediately begin replaying your selection.

TO RESUME NORMAL PLAYBACK

4. While the disc is playing, press the **A-B** button until the “ AB OFF” indicator displays on the screen.

Note:

- A-B repeat can only be used within the same title. If the start and end of the section to be repeated are in different titles, A-B repeat is cancelled.
- The A-B repeat function does not operate in scenes where different camera angles are recorded.

DVD PROGRAMMABLE PLAYBACK

PROGRAMMABLE MEMORY

The two types of programmed playback provided by this unit is title/chapter programmed playback.

TITLE/CHAPTER PROGRAMMED PLAYBACK

1. Press the **MEMORY** button in PLAY mode.
2. Input the title (2 digits) and chapter (2 digits) by pressing the number buttons. (For example : 01 02, 02 05, 02 11) It will move to the next item automatically.
3. Repeat steps 2 to add additional titles and chapters.
4. Press the ► **PLAY** button to start the programmed playback.

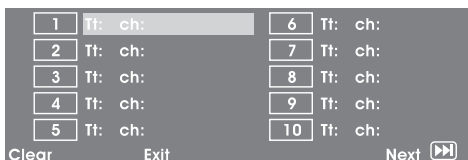

CUSTOMIZING THE DVD FUNCTION SETTINGS

LANGUAGE SETUP

1. In STOP mode, press the **SETUP** button.
2. Use the ▲ or ▼ button to select the option (**OSD Language**, **Audio**, **Subtitle** or **Disc Menu**), then press the ► button.
3. Use the ▲ or ▼ button to select your preferred language, then press the **ENTER** button to confirm.
4. Press the ◀ button to go back to the previous menu. Repeat steps 2 and 3 to adjust other options.
5. To exit the SETUP MENU and return to the normal screen, press the **SETUP** button.

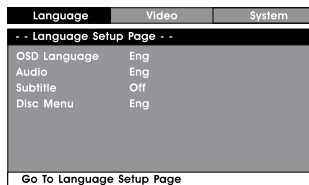

Note:

- Some DVDs may not play in the audio language selected. A prior language may be programmed on the disc.
- Some DVDs may be set to display subtitles in a language other than the one selected. A prior subtitle language may be programmed on the disc.
- Some DVDs allow you to change subtitle selections via the disc menu only. If this is the case, press the **DVD MENU** button and choose the appropriate subtitle from the selection on the disc menu.
- Some DVDs may not included your pre-selected language. In this case, the DVD player automatically displays disc menus consistent with the disc's initial language setting.

CUSTOMIZING THE DVD FUNCTION SETTINGS

VIDEO SETUP

1. In STOP mode, press the **SETUP** button.
2. Press the ◀ or ▶ button repeatedly until VIDEO SETUP appears.
3. Use the ▲ or ▼ button to select the option (**Brightness** or **Contrast**), then press the ▶ button. Use the ◀ or ▶ button to make adjustments, then press the **ENTER** button. (The screen will change to your selected setting).
4. Repeat steps 2 and 3 above to adjust other options.
5. To exit the SETUP MENU and return to the normal screen, press the **SETUP** button.

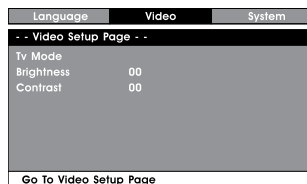

SYSTEM SETUP

1. In STOP mode, press the **SETUP** button.
2. Press the ◀ or ▶ button repeatedly until SYSTEM SETUP appears.
3. Use the ▲ or ▼ button to select the option (**Tv Display** or **Default**), then press the ▶ button. Use the ▲ or ▼ button to make adjustments, then press the **ENTER** button. (The screen will change to your selected setting).
4. Repeat steps 2 and 3 above to adjust other options.
5. To exit the SETUP MENU and return to the normal screen, press the **SETUP** button.

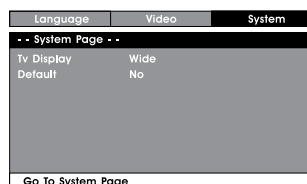

TV TYPE

Pan Scan

- When wide-screen video is played, this mode clips the right and left sides of the image so that it can be viewed on a conventional screen.
- Some wide-screen DVDs that do not permit Pan Scan mode playback are automatically played in letterbox mode (black bands that appear at the top and bottom of the screen).

Letter Box

- When wide-screen video is played in this mode on a conventional screen, black bands appear at the top and bottom of the screen.

Wide screen

- This is the correct mode for playing wide-screen videos on the unit or other external wide-screens.

Note:

- The displayable picture size is preset on the DVD. Therefore the playback picture of some DVDs may not conform to the picture size you select.
- When you play DVDs recorded in the 4:3 aspect ratio, the playback picture will always appear in the 4:3 aspect ratio regardless of the TV TYPE setting.
- If the screen mode is still not correct, press the **LCD MODE** button repeatedly to adjust it.

DEFAULT

It takes 3-5 seconds to reset the DVD settings to the factory default.

Cut off when a wide-screen video image is played.



PAN SCAN



LETTER BOX



WIDE SCREEN

MAINTENANCE

CLEANING THE DISC

A defective or soiled disc inserted into the unit can cause sound to drop out during playback.

Handle the disc by holding its inner and outer edges.

- Do NOT touch the surface of the unlabeled side of the disc.
- Do NOT stick paper or tape on the surface.
- Do NOT expose the disc to direct sunlight or excessive heat.
- Clean the disc before playback. Wipe the disc from the center outward with a cleaning cloth.
- NEVER use solvents such as benzine or alcohol to clean the disc.



- Do NOT use irregular shaped discs (example : heart shaped, octagonal, etc.). They may cause malfunctions.

CLEANING THE UNIT

- Be sure to turn the unit off and disconnect the AC power cord before maintaining the unit.
- Wipe the unit with a dry soft cloth. If the surfaces are extremely dirty, wipe clean with a cloth that has been dipped in a weak soap-and-water solution and wrung out thoroughly. Wipe with a dry cloth.
- Never use alcohol, benzine, thinner, cleaning fluid or other chemicals. Do NOT use compressed air to remove dust.

IMPORTANT NOTE

Before transporting the unit, remove the disc from the disc compartment.

TROUBLE SHOOTING GUIDE

SYMPTOM

CAUSE (AND REMEDY)

No power.

- Ensure the AC power cord is connected.
- Turn on the unit.

The remote does not function.

- Remove any obstacles between the remote and the unit.
- Use the remote near the unit.
- Point the remote at the remote sensor on the unit.
- Replace the batteries in the remote with new ones.

DVD

No sound or only a very low-level sound is heard.

- Make sure that you've selected DVD mode.
- The system is in pause mode. Press the ► **PLAY** button to return to normal play mode.
- Fast forward or fast reverse is performed. Press the ► **PLAY** button to return to normal play mode.
- Make sure the AUDIO / VIDEO output and AV IN input connections are correct.
- The DTS DVD cannot be decoded to have speaker output.
- This unit is too hot. Power off the unit for 30 minutes to cool down.

No picture

- The region number of the disc doesn't match the region number of this unit.



TROUBLE SHOOTING GUIDE

The picture is not clear

- Clean the disc.
- The disc is scratched.

Severe hum or noise is heard.

- The plugs and jacks are dirty. Wipe them with a cloth slightly moistened with alcohol.
- Clean the disc.

The disc does not play.

- There is no disc inside (“No Disc” appears on the screen).
- Insert the disc correctly with the playback side facing forward.
- Clean the disc.
- A non-NTSC disc has been inserted. The unit and disc region number are incompatible.
- Condensation may have formed inside the unit due to a sudden change in temperature. Wait about an hour for it to clear and try again.

TV

Bad Picture (snow, multiple images, distortion, blurry)

- Check the location of the antenna and adjust it if necessary.
- Make sure the antenna cable is firmly connected.
- Make sure all input cables are firmly connected.

No sound.

- Increase the volume.
- Check whether the mute function has been activated on the remote control.

Black and white picture.

- Check the SET UP MENU setting within the TV SETUP menu.
- Check to make sure the program you are watching is broadcast in Color and not Black & White.

No picture or sound.

- Make sure the unit is plugged in and turned on.
- Make sure TV mode is selected.
- Try a new channel to check for possible station trouble.
- Make sure the antenna is connected properly.
- Increase the volume.
- Make sure the antenna or audio/video source device is working properly.
- Make sure all cables are firmly connected.
- Check for local interference.

Colored patches of picture.

- Make sure there are no unshielded electrical devices nearby that are causing interference.
- Turn the TV off for 30 minutes, then try it again.

Unit: INCH

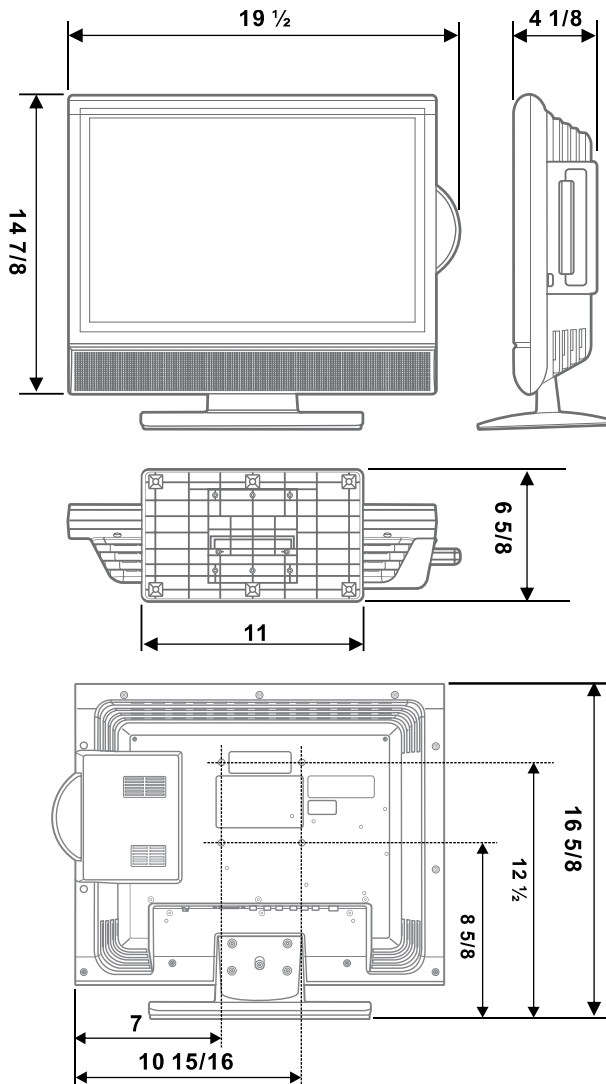

Printed in china
811-319991W150

Free Manuals Download Website

<http://myh66.com>

<http://usermanuals.us>

<http://www.somanuals.com>

<http://www.4manuals.cc>

<http://www.manual-lib.com>

<http://www.404manual.com>

<http://www.luxmanual.com>

<http://aubethermostatmanual.com>

Golf course search by state

<http://golfingnear.com>

Email search by domain

<http://emailbydomain.com>

Auto manuals search

<http://auto.somanuals.com>

TV manuals search

<http://tv.somanuals.com>