



FPE1909DVDC

19 " LCD TV User's Guide

- Please observe all safety precautions when using this product.
- Please read this manual carefully before using this product.

Dear Customers





May we take this opportunity to thank you for purchasing this LCD TV .We strongly recommend that you carefully read the safety and operation instructions before operating your TV. **FOLLOW INSTRUCTIONS AND HEED ALL WARNINGS** on your LCD TV found in this manual.

Safety Information

- **Note:**

Before connecting the AC power cord to the DC adapter outlet, make sure the voltage designation of the DC adapter corresponds to the local electrical supply. **If you are unsure of your power supply, ask your local power company.**

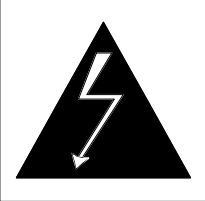
- **CAUTION:**

	CAUTION RISK OF ELECTRIC SHOCK DO NOT OPEN		TO REDUCE THE RISK OF ELECTRIC SHOCK, DO NOT REMOVE COVER. NO USER-SERVICEABLE PARTS INSIDE. REFER SERVICING TO QUALIFIED SERVICE PERSONNEL.
	This symbol indicates "dangerous voltage" inside the product that presents a risk of electric shock or personal injury.		This symbol indicates important instructions accompanying the product.

- To avoid electric shock, never touch the inside of the LCD TV. Only qualified technicians should open the case of the LCD TV

- **WARNING:**

- Do not defeat the safety purpose of grounding-type. A grounding type plug has two blades and a third grounding pin. The third pin is provided for your safety. **If the plug does not fit, ask your electrician to replace your obsolete outlet. Do not modify the plug. To do so will void the safety feature.**
- To reduce the risk of fire or electric shock, and annoying interference, use the recommended accessories only.

Precautions

Please read these precautions before operating this unit.

Power cord protection:

- Never use your LCD TV if the power cord has been damaged. Do not allow anything to rest on the power cord, and keep the cord away from where people can trip over it.
- Be sure to hold the plug, not the cord, when disconnecting the LCD TV from an electric socket.
- Locate your LCD TV near an easily accessible AC outlet.

Placement

- Use only with the cart, stand, tripod, bracket, or table specified by the manufacturer; or sold with the apparatus. When a cart is used, use with caution when moving the cart to avoid injury from tip-over. Follow all instructions regarding their use exactly.
- An appliance and a cart combination should be moved with care. quick stops, excessive force, and uneven surfaces may cause the appliance and cart to overturn.
- Avoid placing the LCD TV in areas of direct sunlight, high temperature or high humidity or high levels of dust. The internal parts may be damaged as a result.
- High temperature can cause problems. Don't use your LCD TV in direct sunlight, and keep it away from it – unplug it immediately and contact an authorized dealer or service center.
- Please put the LCD TV in a location with low humidity and a minimum of dust.
- Place the LCD TV on a solid surface and treat it carefully. The screen is made of thin glass with a plastic front surface and can be damaged if dropped, hit or scratched.

Non-use Periods

- Unplug the LCD TV when it is going to be left unused for an extended period of time.

Foreign Object

- Never insert anything metallic into the cabinet openings of the liquid crystal display (LCD) TV; doing so may create the danger of electric shock.

Keep away from water / magnetic fields

- Do not expose the LCD to rain or use it near water (in kitchens, near swimming pools, etc.). If the LCD accidentally got wet, unplug it and contact an authorized dealer immediately.
- Do not clean the front with ketone-type materials (e.g., Acetone), ethyl alcohol, toluene, ethyl acid, methyl, or chloride-as these may damage the panel.
- Keep the unit away from flower vases, tubs, sinks, etc. If liquids are spilled into the unit, serious damage will occur.

Stacking

Openings in the LCD TV cabinet are provided for ventilation. To prevent overheating, these openings should not be blocked or covered. Also, avoid using the LCD TV on a bed, soft, rug, or other soft surface. Doing so may block the ventilation openings in the bottom of the cabinet. If you put the LCD TV in a bookcase or some other enclosed space, be sure to provide adequate ventilation.

Servicing

- If the LCD TV does not operate normally – in particular, if there are any unusual sounds or smells coming from it – unplug it immediately and contact an authorized dealer or service center.
- Unplug your LCD TV from the AC outlet before any service.
- Be sure the service technician uses authorized replacement parts or their equivalents. Unauthorized parts may cause fire, electrical shock, or other hazards.
- Following any service or repair, be sure the service technician performs safety checks to certify that the LCD TV is in safe operating order.

Table of contents

Safety Information.....2
Precaution.....3
Table of contents.....4
View of the Unit.....5-6
Remote Control.....7-8

For TV operation

Basic operation.....9-10
Menu operation.....11
PICTURE Settings.....12
SOUND Settings.....13
CHANNEL Settings.....14
SETUP15
TIME Settings.....16
LOCK Settings.....17

For DVD operation

Basic operation.....18-20
GENERAL Settings.....21
ANALOG AUDIO Settings.....22
PREFERENCE Settings.....23

Specifications.....24

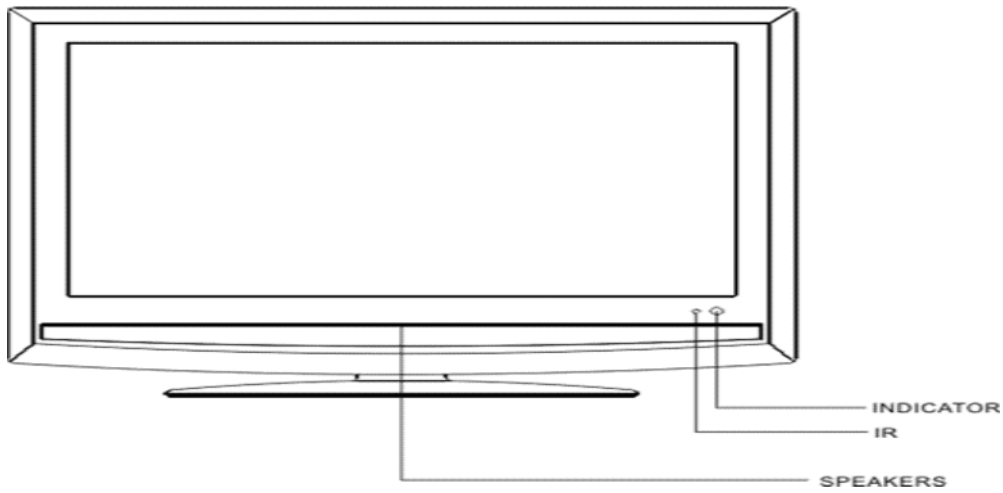

The View of the Unit

Front View

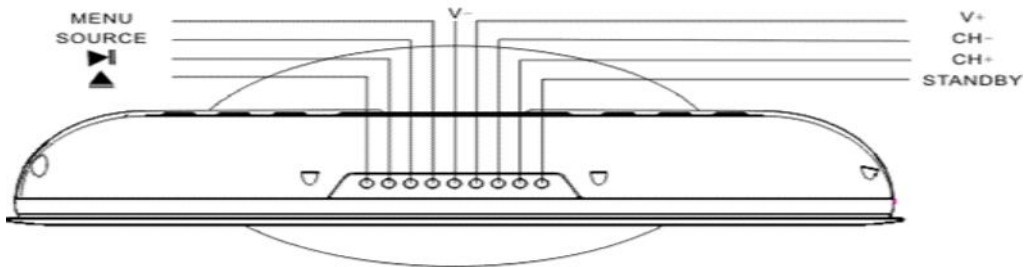

Top View



STATUS LED	The LED will turn red in standby mode, and turn green in the on mode
IR	Infrared Receiver
VOL+/VOL- button	Decrease and increase volume.
MENU button	Press once to display the OSD (on screen display), press again to turn the OSD off.
CH+/CH- button	Decrease and increase channels.
SOURCE button	Press this button to select TV, AV, S-Video, DVD, PC or SCART mode.
STANDBY button	Press this button to turn the LCD on or off. NOTE: Ensure Main Power Switch on back of LCD TV Is set to ON.
	Press this button to open the disc tray
	Press this button to PLAY OR PAUSE the disc

Right View

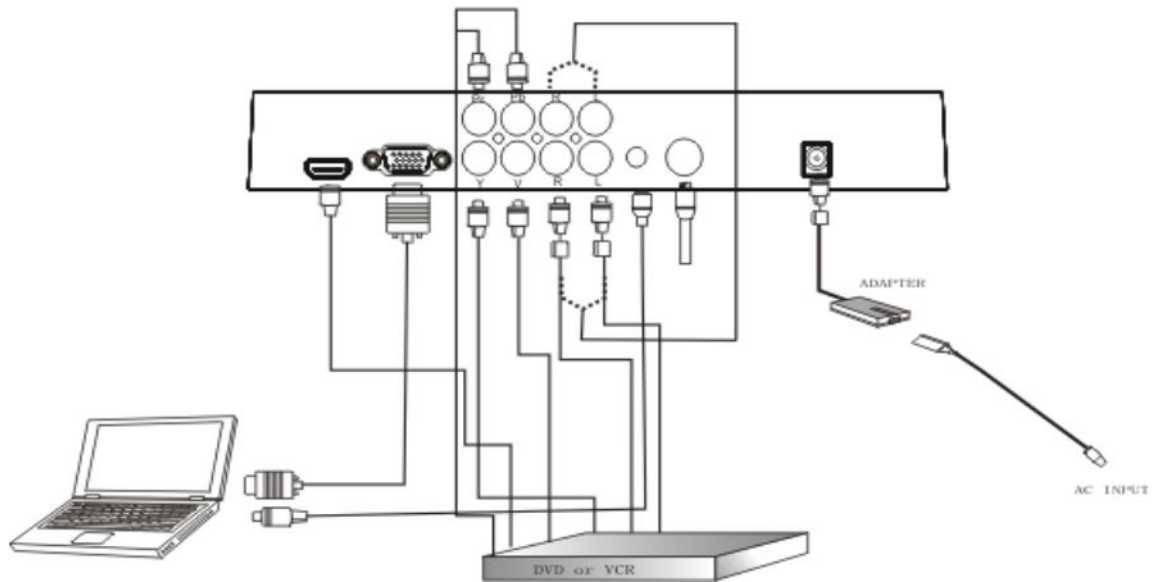
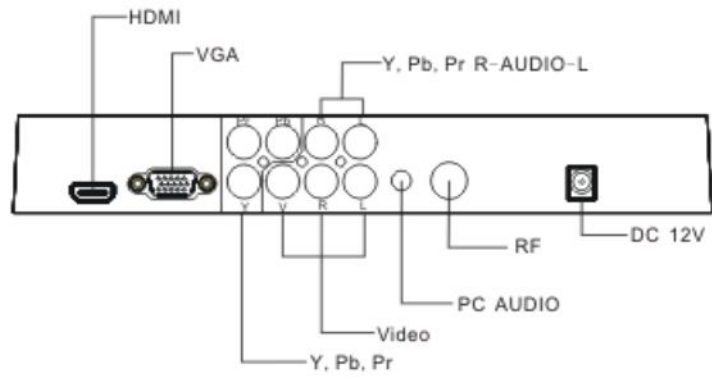

Remote Control

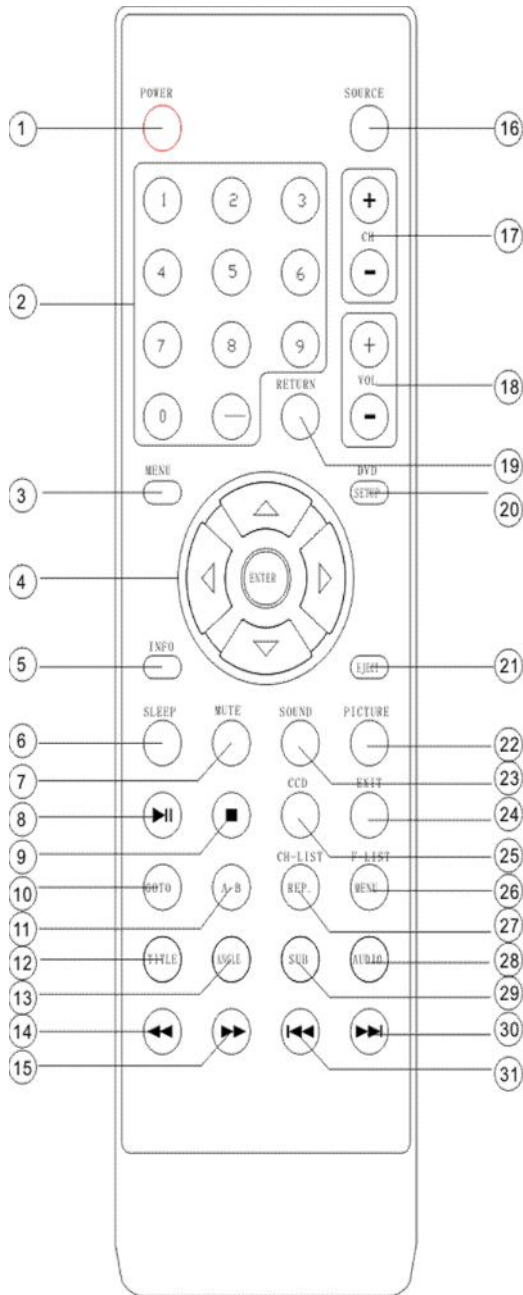

1	POWER button
2	NUMERIC buttons (0-9 and -/-)
3	MENU button
4	DIRECTION and ENTER/PLAY button
5	INFO button
6	SLEEP button
7	MUTE button
8	PLAY/PAUSE button (DVD only)
9	STOP button (DVD only)
10	GOTO button (DVD only)
11	A-B button (DVD only)
12	TITLE button (DVD only)
13	ANGLE button (DVD only)
14	FAST REVERSE button (DVD only)
15	FAST FORWARD button (DVD only)
16	SOURCE button
17	CH+/CH- button
18	VOL+/VOL- button
19	RETURN button
20	DVD SETUP button (DVD only)
21	EJECT button (DVD only)
22	PICTURE button
23	SOUND button
24	EXIT button
25	CCD button (DVD only)
26	MENU button (DVD only)
27	F-LIST button
28	AUDIO button (DVD only)
29	SUB button (DVD only)
30	Chapter Forward button (DVD only)
31	Chapter previous button (DVD only)

Remote Control

Battery installation

Insert the batteries while observing the correct (+) and (-) polarities.

Service life of batteries

- The batteries normally last for about one year although this depends on how often and for what operations the remote control is used.
- If the remote control unit fails to work even when it is operated near the unit, replace the batteries.
- Use 2 x "AA" type batteries

Notes:

- Do not use rechargeable (NI-Cd) batteries.
- Do not attempt to recharge, short-circuit or disassemble batteries. Never place batteries close to a heat source such as radiators or heaters.
- Dispose of batteries in a responsible manner. Never throw batteries into a fire.
- Do not drop or step on the remote control unit. This may damage the parts or lead to malfunction.
- Do not mix old and new batteries.
- If the remote control unit is not going to be used for long time, always remove the batteries to prevent leakage.

Remote control operation range

Point the remote control no more than about 6m for the remote control sensor and within 60° from the Infrared Receiver

- The operating distance may vary according to the brightness of the room.

Notes:

- Do not point bright lights at the remote control sensor.
- Do not place objects between the remote control and the infrared receiver
- Do not use this remote control while simultaneously operating the remote control of any other equipment.

Basic operation (For TV Opeartion)

Connect the power supply.

1. Connect the power, then press the STANDBY button on the front panel to turn on the unit.
2. Press the SOURCE button to select TV mode, then press RIGHT button to confirm.
3. Adjust the volume.

Adjust the volume

Press VOL- button to decrease the volume.

Press VOL+ button to increase the volume.

Mute the volume

Press MUTE on the remote control during playback to turn off the sound, press it again to turn on the sound.

Select Input source

Press SOURCE button:



Use UP/DOWN arrows to select the desired one, then press RIGHT arrow to confirm.

Viewing the TV programs

Press SOURCE button to select TV input mode first.

Select programs

Press CH+ or CH- to select the programs up or down, or press "- / -" button until the screen appears "-" or "--", then press 0-9 numeric buttons to select the programs from 0 to 99.

Select the picture mode

Press PICTURE button to select the picture mode:

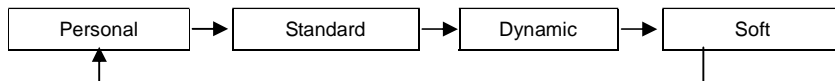

Select the sound mode

Press SOUND button you can select the sound mode:

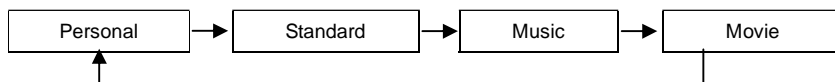

Sleep function

Press SLEEP button to set up the sleep time to shut down your monitor.

You can select 15, 30, 45, 60, 90, or 120 minutes and off by pressing the SLEEP button continually.

Viewing the AV SOURCE such as DVD\VCRCAMCORDER

Press the SOURCE button



Select the suitable input to pickup the AV signal.

Navigating the Menu

1. Press MENU button on the remote control, the on-screen menu will appear on the screen. Use the UP/DOWN buttons to select your main menu option.

PICTURE MENU

Make adjustments to your picture settings.



SOUND MENU

Customize the audio option and effects.

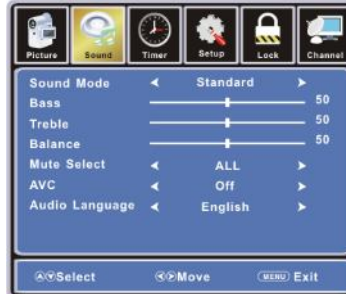

TIME MENU

Set up a variety of time options.



SETUP MENU

Set up a variety of features



LOCK MENU

Set up a variety of features.

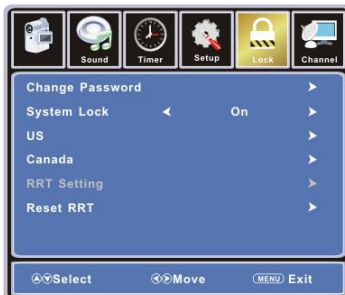

CHANNEL MENU

Edit channels.



2. Use the LEFT/RIGHT/UP/DOWN buttons to select an option of the sub-menu. While in adjustment mode, use the LEFT/RIGHT buttons to change the value of the item.
3. Press the MENU button to exit the menu.

Note:

Not all options are available for every source

PICTURE Settings

1. Press the MENU button on the remote control to display the Main menu, and use the LEFT/RIGHT/UP/DOWN buttons to select the PICTURE menu.
2. Use the LEFT/RIGHT/UP/DOWN buttons to highlight an individual PICTURE option, use the LEFT and RIGHT buttons to change the setting, and press the MENU to exit .

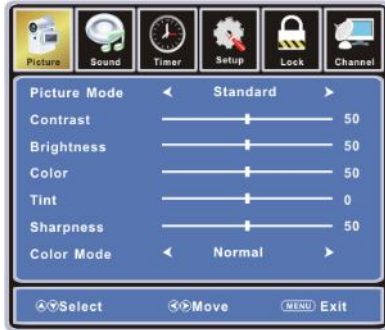

3. The PICTURE menu includes the following options:

Picture Mode	Cycles among picture display modes: Personal, Standard, Dynamic, Soft.
Brightness	Controls the overall brightness of the picture
Contrast	Controls the difference between the brightest and darkest regions of the picture.
Color	Controls the color
Tint	Controls the tint
Sharpness	Increase this setting to see crisp edges in the picture; decrease it for soft edges.
Color Mode	Cycles among color display modes: Normal, Cool, Warm.

SOUND Settings

1. Press the MENU button on the remote control to display the Main menu, and use the LEFT/RIGHT/UP/DOWN buttons to select the SOUND menu.
2. Use the LEFT/RIGHT/UP/DOWN buttons to highlight an individual SOUND option, use the LEFT and RIGHT buttons to change the setting, and press the MENU to exit

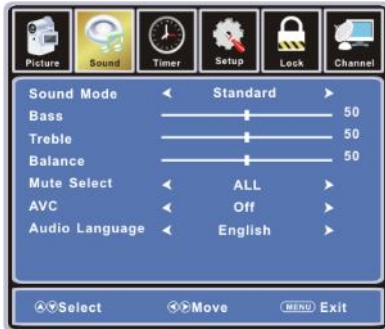

3. The SOUND menu includes the following options:

Sound Mode	Cycles among sound display modes: Personal, Standard, Music, Movie.
Bass	Controls the relative intensity of lower pitched sounds.
Treble	Controls the relative intensity of higher pitched sounds
Balance	To adjust the balance of the left and right sound track, or turn off the volume of the left and right sound track.
Mute Select	You can choose the mute
AVC	Can choose on or off.
Audio Language	Can choose ENGLISH,FRENCH,SPANISH.

CHANNEL Settings

1. Press the MENU button on the remote control to display the Main menu, and use the LEFT/RIGHT/UP/DOWN buttons to select the CHANNEL menu.
2. Use the LEFT/RIGHT/UP/DOWN buttons to highlight an individual CHANNEL option, use the LEFT and RIGHT buttons to change the setting, and press the MENU to exit



3. The CHANNEL menu includes the following options:

Antenna	You can choose between Air and Cable.
Auto Scan	Auto scan the channel
Favorite	Choose your favorite channel.
Channel NO.	Display the channel number.
Channel Label	Display the broadcast channel identification
DTV Signal	Display the DTV Signals.strength

SETUP Settings

1. Press the MENU button on the remote control to display the Main menu, and use the LEFT/RIGHT/UP/DOWN buttons to select the SETUP menu.
2. Use the LEFT/RIGHT/UP/DOWN buttons to highlight an individual SETUP option, use the LEFT and RIGHT buttons to change the setting, and press the MENU to exit.



3. The SETUP menu includes the following options:

MENU Language	Selects to display all on-screen menus in your language of choice
Transparency	Can choose on or off.
Zoom Mode	Allows you to select the zoom Modes: Normal, Cinema, Wide ,and Zoom
Noise Reduction	Allows you to select the Noise Reduction modes: Strong,Off ,Weak, and Middle.
Advance	Advance
Close Caption	Select available closed caption broadcast formats
Audio Only	Turn off LCD,Audio is still present for music playback
Restore Default	Restores all settings to factory settings

TIME Settings

1. Press the MENU button on the remote control to display the Main menu, and use the LEFT/RIGHT/UP/DOWN buttons to select the TIME menu.
2. Use the LEFT/RIGHT/UP/DOWN buttons to highlight an individual TIME option, use the LEFT and RIGHT buttons to change the setting, and press the MENU to exit



3. The TIME menu includes the following options:

Sleep timer	Choose the sleep timer.
Time Zone	Choose the time zone.
Daylight Saving Time	Choose on or off.

LOCK Settings

1. Press the MENU button on the remote control to display the Main menu, and use the LEFT/RIGHT/UP/DOWN buttons to select the LOCK menu.
2. Use the LEFT/RIGHT/UP/DOWN buttons to highlight an individual LOCK option, use the LEFT and RIGHT buttons to change the setting, and press the MENU to exit.



3. The LOCK menu includes the following options:

Change Password	Choose a new password.
System Lock	Allow you to turn on or off.the system lock
Canada	Allow you to choose Canada or Canada French
RRT Setting	
Reset RRT	Allow you to reset the RRT setting

Basic DVD Operation

Connect the power supply.

1. Connect the power ,then press the STANDBY button to turn on the unit.
2. Press SOURCE button to select DVD input mode and press RIGHT button to confirm.
3. Press EJECT on the remote control to open the disc tray, then insert a disc correctly.
4. Press the PLAY button to start play. (some discs may play automatically)

When a menu screen appears on the TV screen.

In case of interactive DVDs with control, a menu screen appears on the screen.

Press UP/DOWN/LEFT/RIGHT buttons and press ENTER to select the desired item. Play of the selected item now begins.

For further information, also refer to the jacket or case of the disc you are playing.

After operation

When the unit is not in use, remove the disc and turn off the unit.

Note:

- When “” appear on the TV screen while a button is pressed, it means that this function is not available on the disc you are playing.
- Depending on the DVD disc, some operations may be different or restricted. Refer to the jacket or case of the disc you are playing.

Stop Play

Temporarily Stop

Press STOP during playback, the unit records the point where STOP was pressed (resume function).

Press PLAY and play will resume from this point.

Fully Stop

Press STOP twice during playback, or press STOP during temporarily stop mode, the unit will fully stop

Press PLAY and play will from the beginning of the disc..

Note:

- The resume function may not be available on some DVD disc

Still picture

Press PAUSE during playback. The player will be placed in the pause mode.

To resume normal playback, press PLAY.

Skipping Chapters and Tracks Forward or Back

Skipping forward

Press NEXT  on the remote control during playback.

- A chapter (DVD) or a track (CD) is skipped each time the button is pressed.

Skipping back

Press PREV  on the remote control during playback.

- A chapter (DVD) or a track (CD) is skipped each time the button is pressed.

Random playback

Press RANDOM during playback. In random mode, if you press **▶▶**, it may be skip to a random chapter instead of next chapter. Press RANDOM again to return normal playback.

To Scan at Fast Forward or Fast Reverse playback

- You can press **◀◀** or **▶▶** button on the remote control during playback.

[Screen display]



The speed of advance (reverse) is relatively slow at first. When the button is pressed again, the speed becomes faster. (Each time the button is pressed, the disc will be played forward or backward at double (x2) speed. With each subsequent press, the disc will be played back at x2, x4, x8, x16 or x32 speed and PLAY. Press PLAY button to return to normal play).

The speed will be retained even after the button is released.

To return to normal playback, press PLAY, or ENTER on the remote control.

Note:

The DVD player does not play back sound during fast forward or fast reverse playback.

Using a Title Menu

Some movie discs may contain two or more titles. If the disc has a title menu recorded on it, the TITLE button can be used to select the movie title. (The details of operation differ depending on the disc used.)

- Select a title may not be possible on certain DVD disc.
- Press TITLE
A list of the title on the disc will be displayed.
 - Press UP/DOWN/LEFT/RIGHT buttons and press ENTER or PLAY, to select desired title.
The selected title now starts playing.

Using a DVD Menu

Some DVD have unique menu structures called DVD menus. For example, DVD programmed with complex contents provide guide menus, and those recorded with various languages provide menus for audio and subtitle language. Although the DVD menu's contents and operation differ from disc to disc, the following explains the basic operation when this feature is used.

- Press MENU
The DVD menu available on the disc will be displayed.
- Press UP/DOWN/LEFT/RIGHT buttons and press ENTER or PLAY, to select desired item.
The selected title now starts playing.

Changing Subtitle Language

It is possible to change the subtitle language. This operation works only with discs on which multiple subtitle languages are recorded. Press SUBTITLE repeatedly until the desired language is selected.

For your reference:

If the power is reset or the disc is removed, subtitles will appear in the default language set by the DVD player.

Changing Audio Soundtrack Language

It is possible to change the audio soundtrack language of the DVD disc. This operation works only with a DVD when multiple audio soundtrack languages are recorded.

Press AUDIO repeatedly until the desired audio language is selected.

Viewing from another Angle

Some DVDs may contain scenes which have been shot simultaneously from a number of different angles. For these discs, the same scene can be viewed from each of these different angles using the ANGLE button. (The recorded angles differ depending on the disc used.)



Press ANGLE repeatedly until the desired angle is selected.

For your reference:

This function only works for discs having scenes recorded at different angle.



Repeat Play

Press REPEAT during playback.

Each time this button is pressed, the screen changes as:  CHAPTER,  TITLE,  ALL and normal playback.

Repeat A-B

Repeating sections between two specific points

Press the A-B button on the remote at the point where you wish the repeat play to start. The display will show  A. Press A-B button again at the point where you wish the repeat play to finish. The display will show  A B. The A-B segment will now repeat continuously until the  A B button is pressed for a third time.

Search a Specific Title, Chapter

You may directly enter a time, title or chapter number to search fast on a disc, the player plays from that point.

GENERAL Settings

1. Press the SETUP button on the remote control to display the Main menu, and use the LEFT/RIGHT/UP/DOWN buttons to select the GENERAL SETUP menu.
2. Use the LEFT/RIGHT/UP/DOWN buttons to highlight an individual GENERAL SETUP option and to change the setting. Press the SETUP to exit the menu.

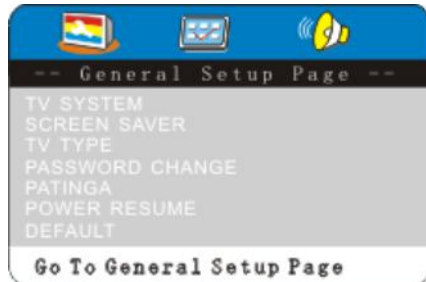

3. The GENERAL menu includes the following options:

TV SYSTEM	Cycles among TV SYSTEM modes: AUTO,PAL,.NTSC
SCREEN SAVER	To turn on or off the SCREEN SAVER.
TV TYPE	Cycles among TV TYPE : 4:3PS , 4:3LS , 16:9.
PASSWORD CHANGE	To CHANGE PASSWORD The default password is 0000.
PANTINGA	Selects to display all on-screen menus
POWER RESUME	To turn on or off the POWER RESUME.
DEFAULT	DEFAULT

PREFERENCE Settings

1. Press the SETUP button on the remote control to display the Main menu, and use the LEFT/RIGHT/UP/DOWN buttons to select the PREFERENCE menu.
2. Use the LEFT/RIGHT/UP/DOWN buttons to highlight an individual PREFERENCE option and to change the setting. Press the SETUP to exit the menu.



3. The PREFERENCE menu includes the following options:

OSD LANGUAGE	Selects to display all on-screen menus in your language of choice
AUDIO LANG	Selects to display all on-screen menus in your language of choice
SUBTITLE LANG	Selects to display all on-screen menus in your language of choice
MENU LANG	Selects to display all on-screen menus in your language of choice

ANALOG AUDIO Settings

1. Press the SETUP button on the remote control to display the Main menu, and use the LEFT/RIGHT/UP/DOWN buttons to select the ANALOG AUDIO SETUP menu.
2. Use the LEFT/RIGHT/UP/DOWN buttons to highlight an individual ANALOG AUDIO option and to change the setting. Press the SETUP to exit the menu.



3. The ANALOG AUDIO menu includes the following options:

Dynamic	Allows you to adjust the Dynamic range compression
---------	--

Specifications

Lcd panel	Size	19 "
	Resolution	1440 x 900
	Brightness	300
	Contrast ratio	800:1
	Viewing angle	170/160 (H/V)
INPUT	VIDEO	1
	COMPONENT	1
	VGA/ VGA AUDIO	1
	RF	1
	AUDIO(L/R)	2
	HDMI	1
Standard	POWER SOURCE	DC-12V

Note : Design and specifications are subject to change without notice.

Weight and Dimensions shown are approximate.



www.asaelectronics.com
www.jensenrvdirect.com



Free Manuals Download Website

<http://myh66.com>

<http://usermanuals.us>

<http://www.somanuals.com>

<http://www.4manuals.cc>

<http://www.manual-lib.com>

<http://www.404manual.com>

<http://www.luxmanual.com>

<http://aubethermostatmanual.com>

Golf course search by state

<http://golfingnear.com>

Email search by domain

<http://emailbydomain.com>

Auto manuals search

<http://auto.somanuals.com>

TV manuals search

<http://tv.somanuals.com>