

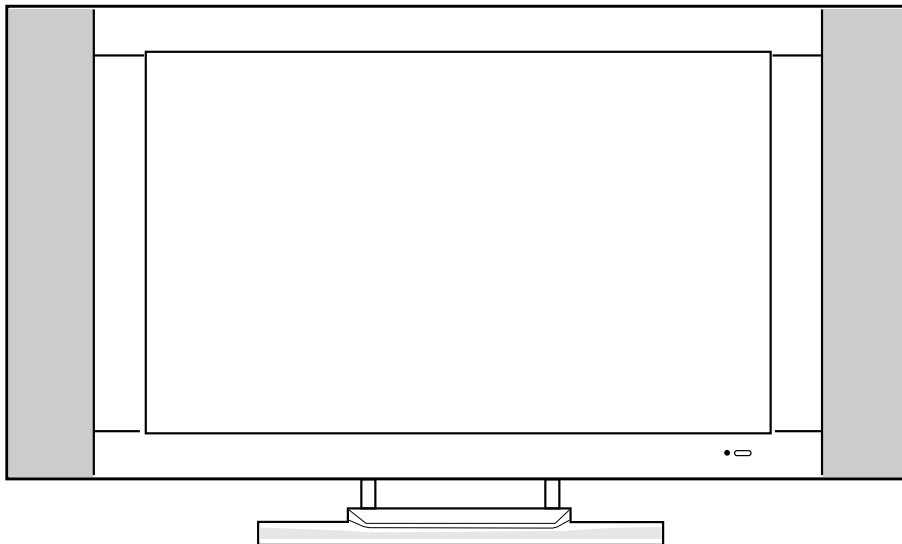

AUDIOVOX®
ELECTRONICS CORP.

Operating Instructions

Model No.: FPE2005
20" LCD TV



For assistance, please call: **1-800-619-3848**
Or visit us at **<http://www.audiovox.com>**



For Customer Service
Visit Our Website At
www.audiovox.com
Product Information, Photos,
FAQ's, Owner's Manuals

128-7354

Congratulations on your purchase of this **LCD TV**.

We recommend that you read this manual thoroughly before use to fully enjoy the many functions and excellent features of this unit.

Keep this manual in an easily accessible location for future reference.

Note:Screen displays and illustrations in this manual may differ from the actual model.

Contents Index

Overview	3	Operations	21
Important safety information	4	Picture adjustment	21
Important safety cautions	5	System setting	22
Accessories	7	Audio setting	27
Identification of controls	8	Channel setting	29
Control buttons	8	Selecting channel	31
Back	9	OSD setting	32
Remote control	10	Timer setting	33
Installation	12	Operations in YbPr mode	34
Basic operations	19	TV troubleshooting	36
Main on-screen-display (OSD) introduction	20	Notices	40
		Maintenance/repair	41
		Specifications	42

Overview

General Description

This Audiovox product is a Color Active Matrix liquid Crystal Display (LCD) with an integral Cold Cathode Fluorescent Lamp (CCFL) backlight system. The matrix employs a Thin Film Transistor (TFT) as the active element. This TFT-LCD has a 20.1 inch diagonally measured active display area with a native 640x480 pixel resolution. Each pixel is divided into red, blue, and green sub-pixels which are arranged in vertical stripes. The color palette is capable of more than 16.7 million colors.

This Audiovox product incorporates a tilt stand that can be removed for easy wall mounting. The wall mounting compatibility of this product is completed by incorporating a VESA 100 wall mount standard bolt configuration. A separate VESA 100 compatible wall mount kit will be required to properly secure the unit to the wall.

This units has a great viewing angle allowing the unit to be seen at almost any viewing angle with minimal loss in picture quality. The high brightness and contrast ratio will make this TV a pleasure to watch.

Important Safety Information

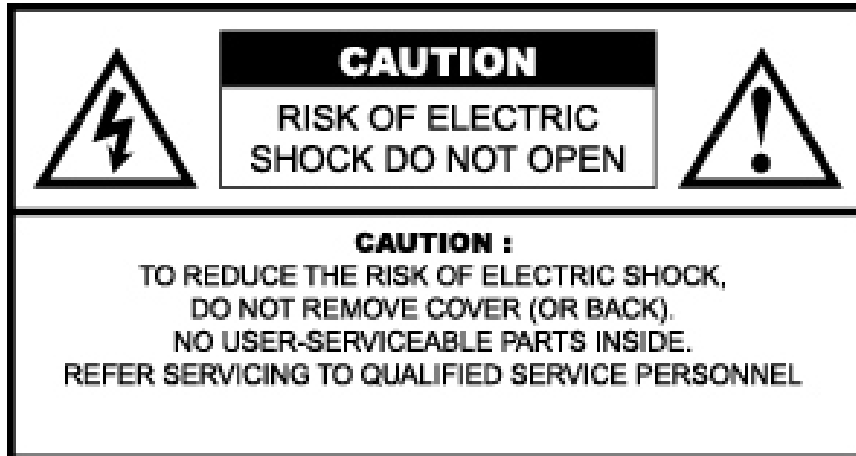

The lightning flash with the arrowhead symbol within an equilateral triangle is intended to alert the user to the presence of uninsulated “**DANGEROUS VOLTAGE**” within the product’s enclosure that may be of sufficient magnitude to constitute a risk of electric shock to persons.



The Exclamation point within an equilateral triangle is intended to alert the user to the presence of important operating and maintenance (Servicing instructions in the literature accompanying the product).

Federal Communication Commission

This Equipment has been tested and found to comply with the limits for a TV Broadcast Receiver, pursuant to Part 15 of the FCC Rules. These limits are designed to provide reasonable protection against harmful interference in a residential installation. This equipment generates, uses and can radiate radio frequency energy and, if not installed and used in accordance with the instructions, may cause harmful interference to radio communications. If this equipment does cause or receive interference, which can be determined by turning equipment off and on, the user is encouraged to try to correct the interference by one of the following measures:

- Reorient or relocate the TV antenna
- Increase the separation between TV and other equipment.
- Connect TV into separate outlet from equipment.
- Consult the dealer or an experienced radio/TV technician for help

FCC Caution: Any changes or modifications not expressly approved by the party responsible for compliance could void the user’s authority to operate this equipment

Important Safety Cautions

When any unusual situation occurs, turn off the power supply at once and remove the plug from the wall outlet. Contact a qualified service department in your local area.

Do not expose this unit in the rain or spatter by liquid. Do not use this product near water - for example, near a bathtub, washbowl, kitchen sink, or laundry tub, in a wet basement, or near a swimming pool, and the like. Do not use immediately after moving from a low temperature to high temperature environment, as this causes condensation, which may result in fire, electric shock, or other hazards.

Heat sources-Keep the product away from heat sources such as radiators, heaters, stoves and other heat generating products (including amplifiers).

Requirement of environment temperature:
0°C~50°C for storage; 5°C~40°C for working

The vents and other openings in the cabinet are designed for ventilation. Do not cover or block these vents and openings since insufficient ventilation can cause overheating and/or shorten the life of the product.

Do not place the product on a bed, sofa, rug or other similar surface, since they can block ventilation openings.

This product is not designed for built-in installation; do not place the product in an enclosed place such as a bookcase or rack, unless proper ventilation is provided or the manufacturer's instructions are followed.

Unplug this product from the wall outlet before cleaning. Do not use liquid cleaners or aerosol cleaners. Use a damp cloth for cleaning.

Do not place the product on an unstable trolley, stand, tripod or table. Placing the product on an unstable base can cause the product to fall, resulting in serious personal injuries as well as damage to the product. Use only a trolley, stand, tripod, and bracket or table recommended by the manufacturer or sold with the product.

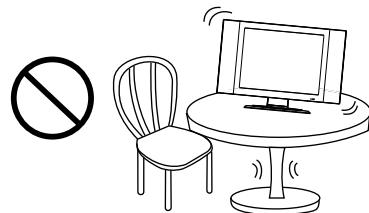
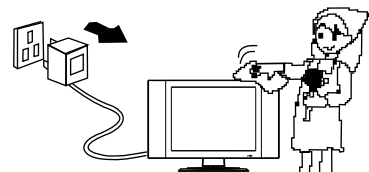
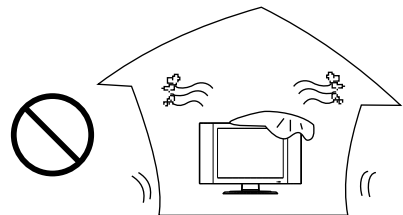
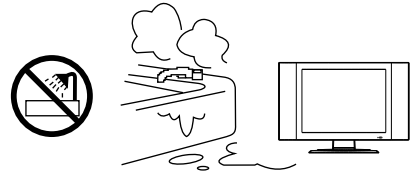

Important Safety Cautions

When relocating the product placed on a trolley, it must be moved with the utmost care. Sudden stops, excessive force and uneven floor surfaces can cause the product to fall from the trolley.



The power cords must be routed properly to prevent people from stepping on them or objects from resting on them. Check the cords at the plugs and product. Power-supply cords should be routed so that they are not likely to be walked on or snagged by items placed upon or against them. Pay particular attention to cords at doors, plugs, receptacles, and the point where they exit from the product. If the power cord or the plug is damaged contact a qualified service department for service.

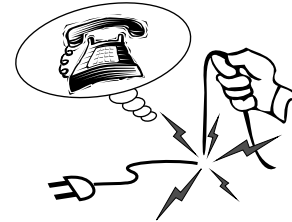

Do not overload wall outlets, extension cords, or convenience receptacles on other equipment as this can result in a risk of fire or electric shock.

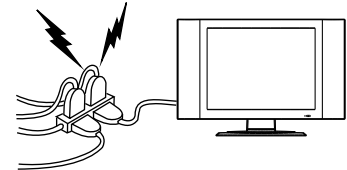

High Voltage exists in this TV set. Do not remove the cover. In case the product needs replacement parts, make sure that the service person uses replacement parts specified by the manufacturer, or those with the same characteristics and performance as the original parts. Use of unauthorized parts can result in fire, electric shock and/or other danger.



The LCD panel used in this product is made of glass. Therefore, it can break when the product is dropped or impacted upon by other objects. Be careful not to be injured by broken glass pieces in case the LCD panel breaks.

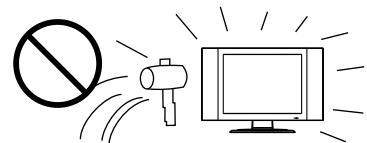

Don't try to push anything into the cabinet or place any vessel with water on the TV set.

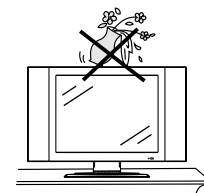

For added protection for this television equipment during a lightning storm, or when it is left unattended and unused for long periods of time, unplug it from the wall outlet and disconnect the antenna. This will prevent damage to the equipment due to lightning and power-line surges.

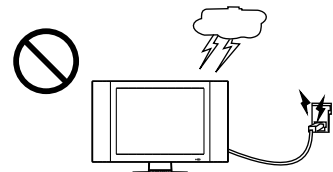

Important Safety Cautions

Important Information Regarding use of Video Games, Computer, captions or other fixed images displays

The extended use of a fixed image program material can cause permanent "Shadow Image" on the LCD panel. The background image is viewable on normal programs in the form of stationary fixed images. This type of irreversible LCD panel deterioration can be limited by observing the following steps:

- * Reduce the Brightness and Contrast settings to a minimum viewing level
- * DO NOT display the fixed image for extended periods of time
- * Turn the power OFF when not in actual use

Recycling

This product utilizes tin-lead solder, and has a fluorescent lamp containing a small amount of mercury. Disposal of these materials may be regulated in your community due to environmental considerations. For disposal or recycling information please contact your local authorities, or the Electronics Industries Alliance Environment at: <http://www.eiae.org/>

Accessories

- 1.. FPE2000 TV unit
- 2.. Power adaptor (AC/DC)
- 3.. AC Power cord
- 4.. Remote Control (Model Specific)
- 5.. Batteries
- 6.. Audio/Video cable (RCA)

Identification of controls

Control buttons

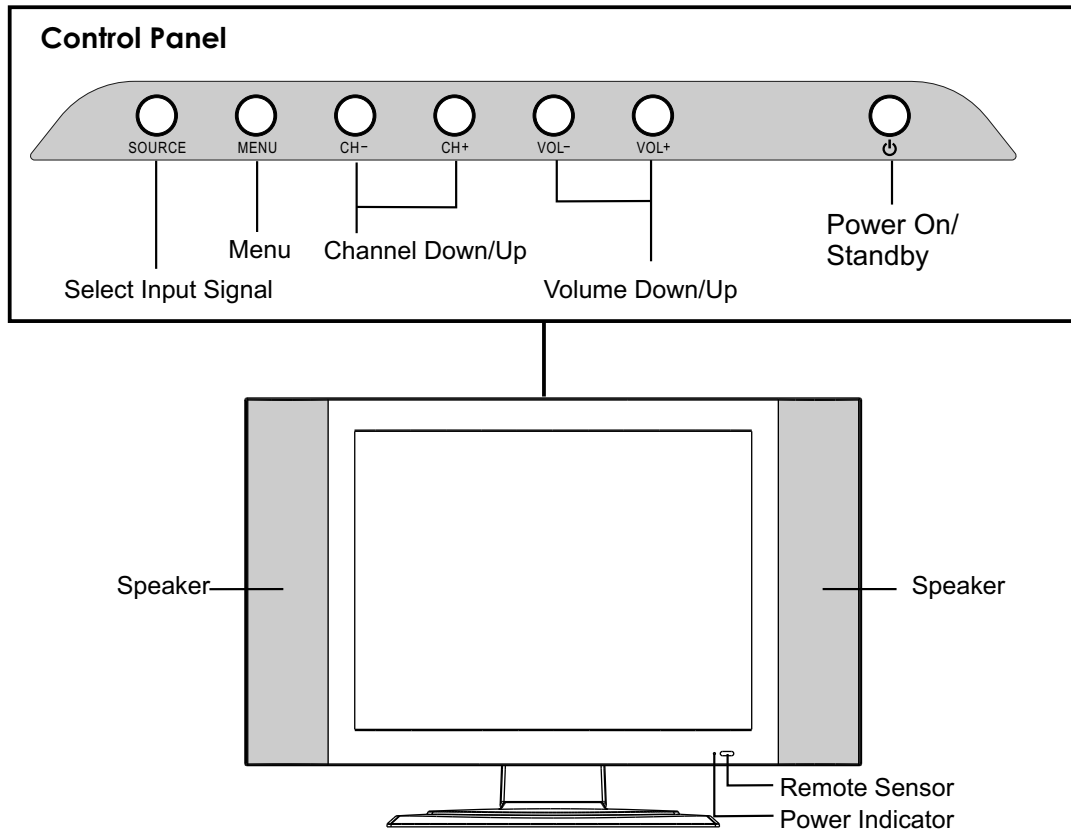

1. SOURCE

To access the SOURCE select menu

2. MENU

Press this button to access the MENU main page.

3. CH +/-

Change the TV channel.

In OSD Menu, press these buttons to choose the OSD items.

4. VOL +/-

Increase or decrease the sound volume level.

In OSD Menu, press these buttons to adjust the value or setting of each item

5. POWER (⏻)

Press this button to turn the unit ON from STANDBY mode. Press it again to turn the set back to STANDBY.

The Power Indicator light will glow yellow when the set is turned on, and glows red when the set is in the standby mode.

Note:

SOURCE, MENU, CH+/-, VOL+/- and POWER (⏻) on the main unit have the same functions as the corresponding buttons on the remote control.

This operation manual provides a description based on operating functions with the remote control.

Identification of controls (continued)

Back

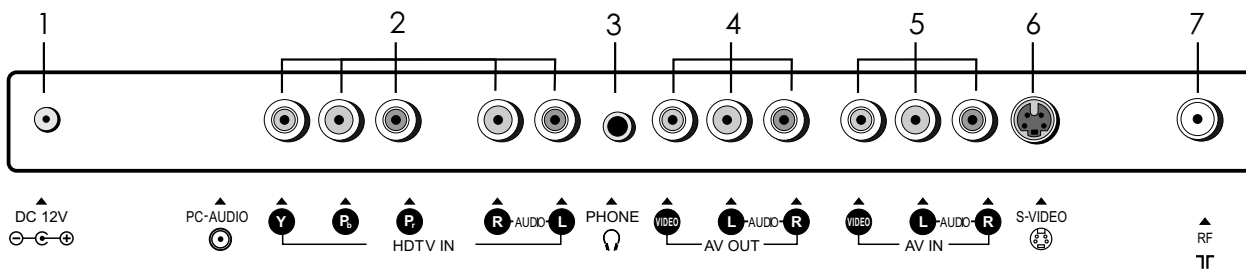
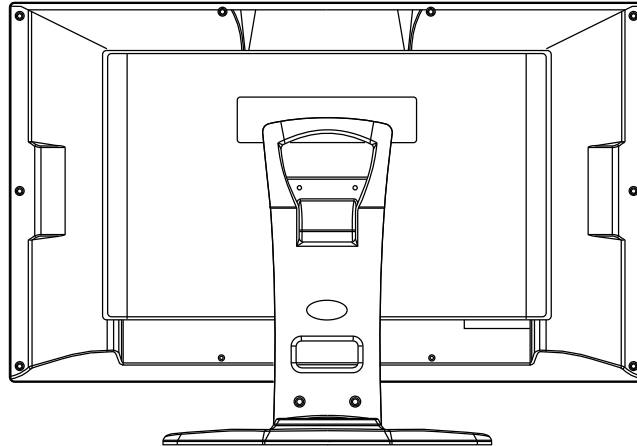

1. DC POWER input

Connect to the DC output of the Power Adapter.

2. HDTV input (Y, Pb, Pr, Audio L, R)

Connect to the Y/Pb/Pr (or Y/Cb/Cr) and audio output jacks of a Set-Top Box or DVD player.

3. Headphone \varnothing 3.5mm jack

4. AV outputs (Video, Audio L, R)

Connect to the VCR input jacks to record programs.

5. AV inputs (Video, Audio L, R)

Receive video/audio signals from external sources such as VCR or DVD player.

6. S-Video input

Receive a S-Video signal from external source such as VCR or DVD player.

7. Coaxial cable & Antenna input

Remote Control

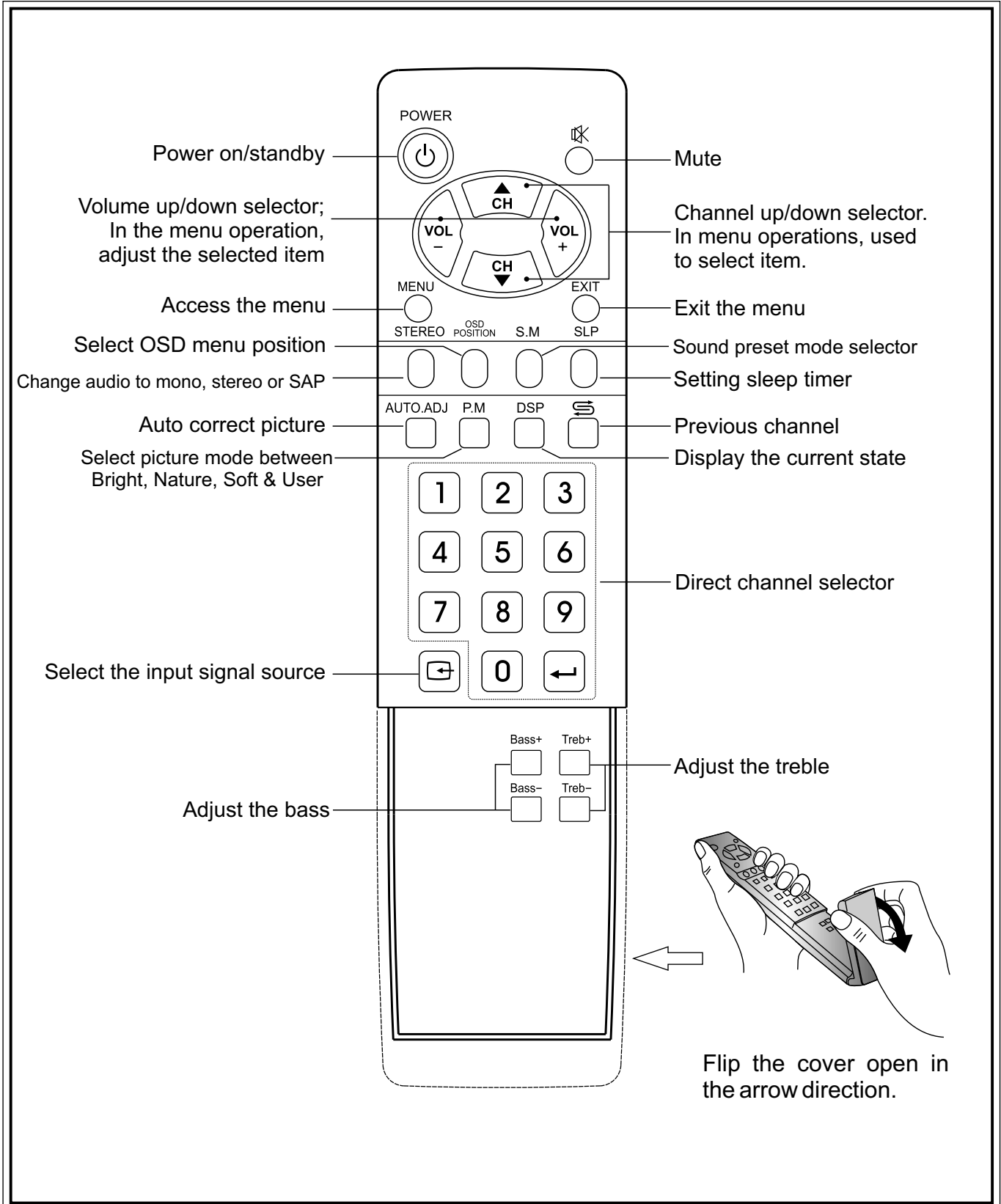

Preparing the Remote Control

Please install the batteries before using the remote control.

Batteries for the Remote Control

If the remote control fails to operate the LCD TV functions, replace the batteries in the remote control.

1 Open the battery cover.

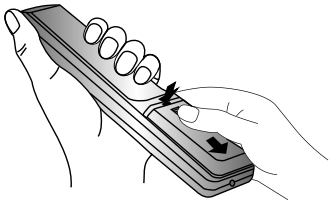

■(Slide the cover while pressing down.)

2 Insert two size-AAA batteries.

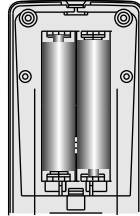

■(Place the batteries with their terminals corresponding to the (+) and (-) indications in the battery compartment.)

3 Replace the cover and slide in reverse until the lock snaps.

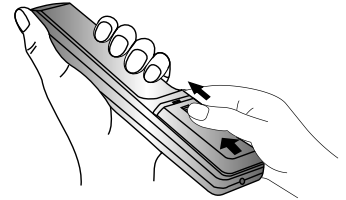

Effective range of the remote control

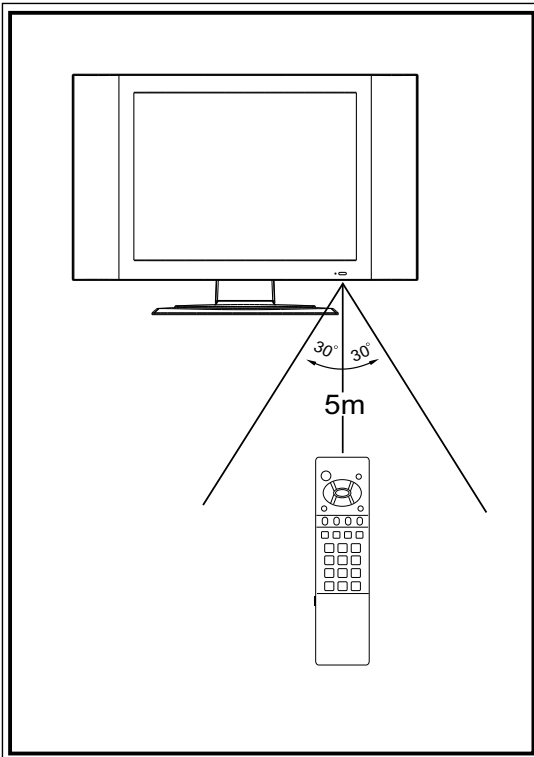

! Notes:

1. When the remote control will not be used for a long period of time or when the batteries are worn out, remove the batteries.
2. Do not drop or dampen the remote control.
3. Do not disassemble the remote control.
4. There should be no obstacle between the TV and the transmitter.
5. Use the remote control within the effective range as shown in the figure on the left.
6. If the remote control does not work, please check whether the batteries are exhausted or if they have been installed properly.
7. When direct sunlight, and incandescent lighting, fluorescent lamp or any other strong light shines on the remote sensor of the TV, the remote operation can become erratic.
8. Do not mix different types of batteries in the remote.

Install the unit in a room where direct light will not fall upon the screen. Total darkness or a reflection on the picture screen may cause eyestrain. Soft and indirect lighting is recommended for comfortable viewing.

Installation

Antenna connections

OUTDOOR VHF/UHF ANTENNA CONNECTION (ANTENNA NOT INCLUDED)

Follow the instructions for the type of antenna system you intend to use. If using Cable or satellite, see the next page.

Combination VHF/UHF Antenna (Single 75 Ohm cable or 300 Ohm twin-lead wire)

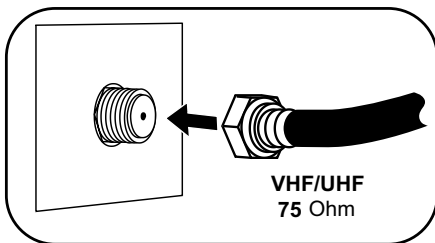

Connect the 75 Ohm cable from combination VHF/UHF antenna to the antenna jack.

OR

If your combination antenna has a 300 Ohm twin-lead wire, use a 300-75 Ohm matching transformer (NOT SUPPLIED).

Combination VHF/UHF Antenna (Separate VHF and UHF 300 Ohm twin-leads)

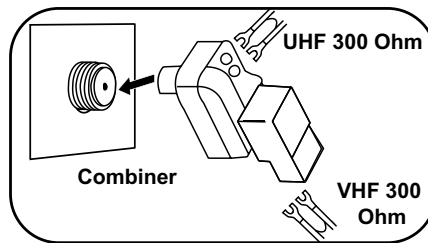

Connect the UHF twin-lead wire to a combiner (NOT SUPPLIED). Connect the VHF twin-lead to a 300-75 Ohm matching transformer (NOT SUPPLIED). Attach the transformer to the combiner. Attach the combiner to the antenna jack.

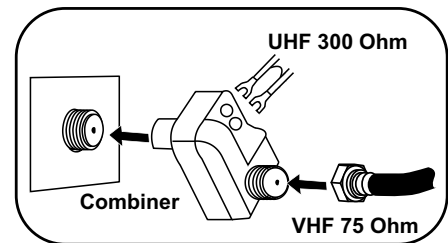

Connect the 75 Ohm cable from the VHF antenna and the UHF antenna twin-lead wire to a combiner (NOT SUPPLIED). Attach the combiner to the antenna jack.

NOTE: If your VHF antenna has a twin-lead wire use a 300-75 Ohm matching transformer, then connect the transformer to the

Installation

Cable (CATV)/satellite connections

This TV has an extended tuning range and can tune most cable channels without using a Cable TV converter box. Some Cable TV companies offer "premium pay channels" in which the signal is scrambled. Descrambling these signals for normal viewing requires the use of a descrambler device which is generally provided by the cable company.

FOR SUBSCRIBERS TO BASIC CABLE TV SERVICE

For basic cable service not requiring a converter/descrambler box, connect the CATV 75 ohm coaxial cable to the VHF/UHF jack on the rear of the TV.

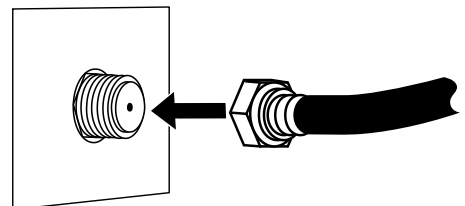

FOR SUBSCRIBERS TO SCRAMBLED CABLE TV SERVICE OR SATELLITE

If you subscribe to a satellite service or a cable TV service which requires the use of a converter/descrambler box, connect the incoming 75 Ohm coaxial cable to the converter/descrambler box. Using another 75 Ohm cable, connect the output of the converter/descrambler or satellite box to the antenna jack on the TV. Follow the connections shown below. Set the TV/VCR to the output channel of the converter/descrambler or satellite box (usually 3 or 4) and use the converter/descrambler or satellite box to select channels.

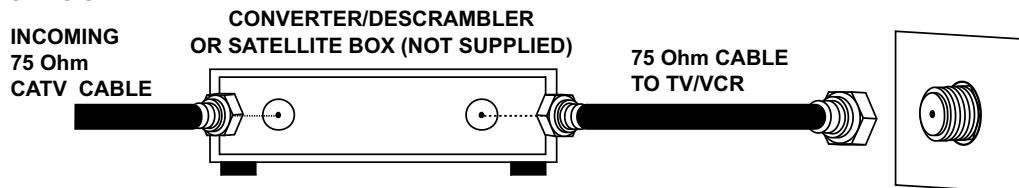

FOR SUBSCRIBERS TO UNSCRAMBLED BASIC CABLE TV SERVICE WITH SCRAMBLED PREMIUM CHANNELS

If you subscribe to a satellite service or a cable TV service in which basic channels are unscrambled and premium channels require the use of a converter/descrambler box, you may wish to use a signal splitter and an A/B switch box (available from the cable company or an electronic supply store). Follow the connections shown below. With the switch in the "B" position, you can directly tune any nonscrambled channels on your TV. With the switch in the "A" position, tune your TV to the output of the converter/descrambler box (usually channel 3 or 4) and use the converter/descrambler box to tune scrambled channels.

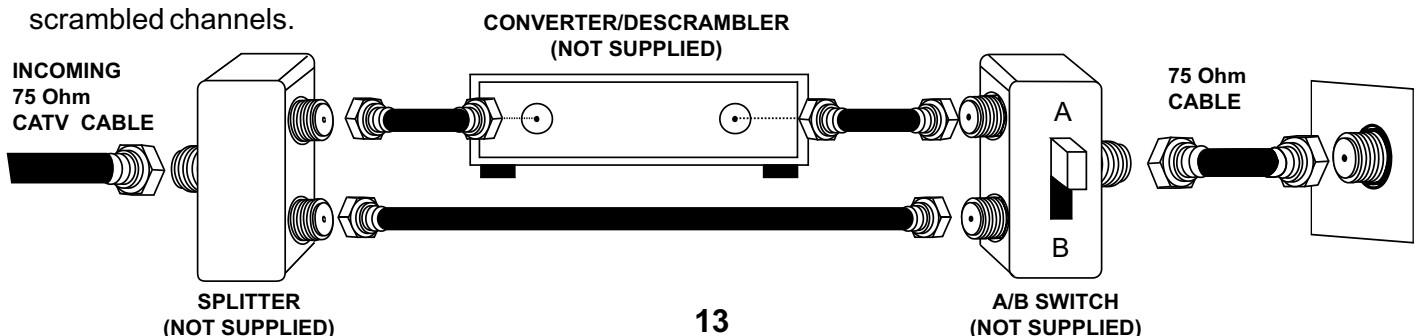

Installation(continued)

Power connection

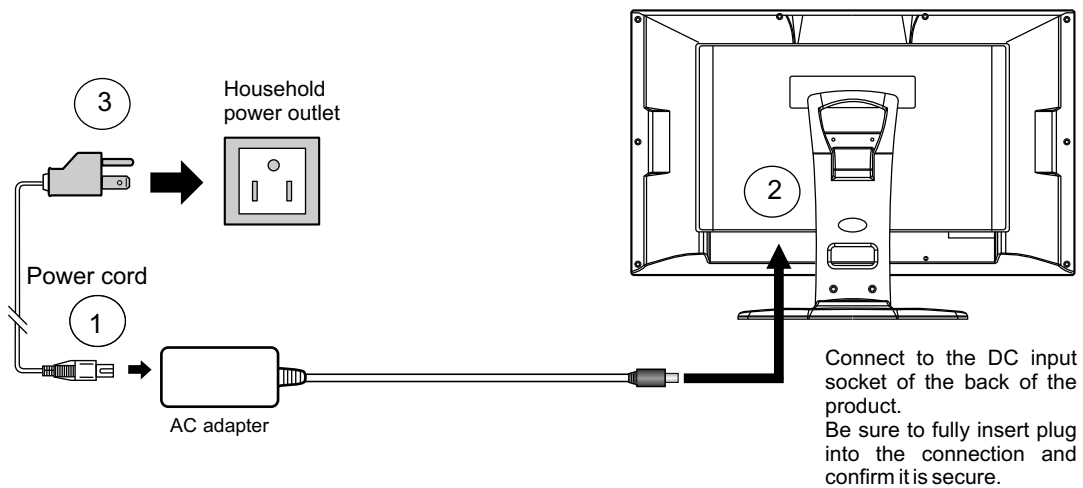

1. Connecting the female plug to the AC socket on AC adapter.
2. Connecting the AC adapter to the DC power input of the set.
3. Connecting the male plug to the wall outlet as illustrated.

Note:

- Always turn off the Power to the LCD TV when connecting the AC adapter.
- This product should only be operated with the type of power source marked on the lable on the unit.
- Always unplug the AC adapter from the product and power outlet when the LCD TV is not in use for an extended period of time of time.
- The illustration of power cord and power outlet is only for your reference and may vary depending on your area.

Installation(continued)

Elevation adjustment

You can adjust the angle of the LCD TV as follows.
The elevation can be adjusted from -5° to $+10^{\circ}$ average.

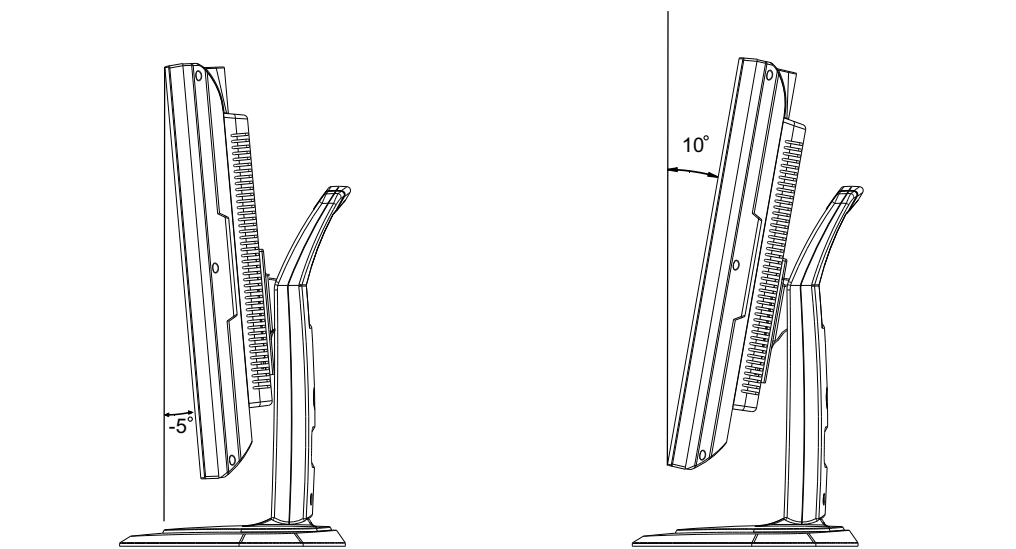

Installation(continued)

Notes about connection

1. Carefully check the terminals for position and type before making any connections.
2. Loose connectors will result in image or color problems. Make sure that all connectors are securely inserted into their terminals.
3. When connecting an external device, turn off the power of the main unit first to prevent any possible damage.

Connecting the Video/Audio equipment

You can connect the unit to a DVD or VCR to enjoy playback with high quality picture and sound. Please refer to the instruction manual of the equipment to be connected.

Composite Video signal connection

Connect the composite video signal terminal on the TV to the output of AV equipment through composite cable. If you select the video signal, please set the input signal source of LCD TV to **AV** mode.

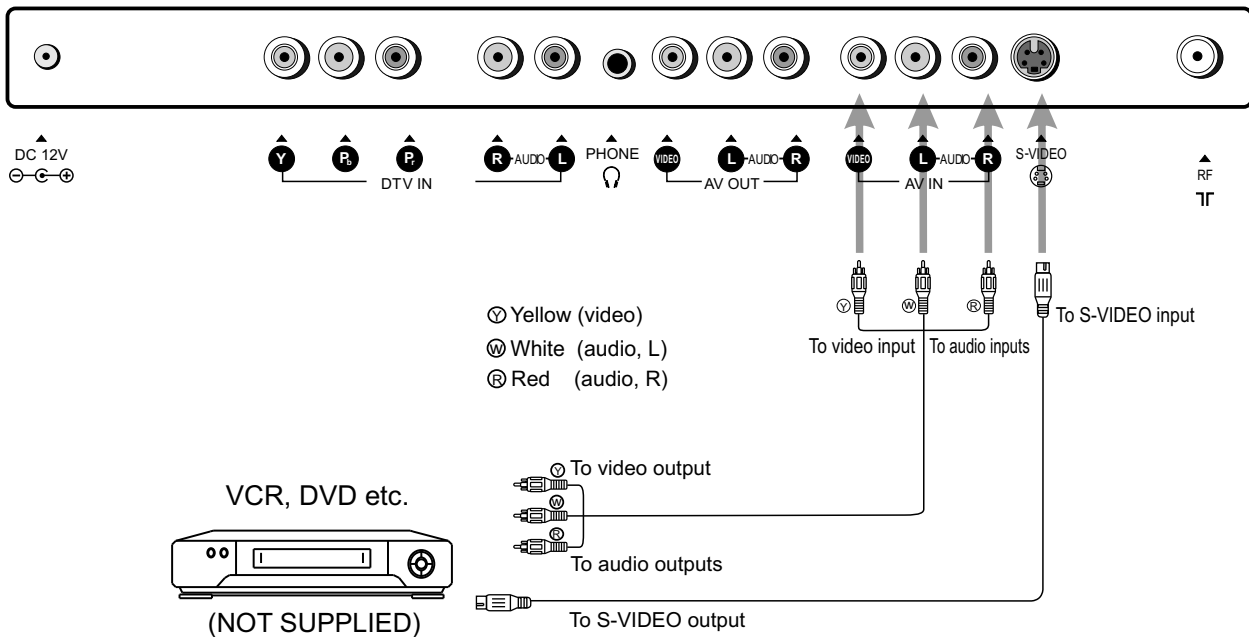

Note: Composite video is the most common used signal, but the picture quality is not as high as S-video.

S-VIDEO Signal Connection

Connect the S-video terminal on the TV to the output of AV equipment using a S-video cable. If you select S-video signal, please set the input signal source of LCD TV to **SVIDEO** mode.

S-Video is a signal format which transfers the color and brightness of the picture with higher quality than a

Installation(continued)

AV OUT connection

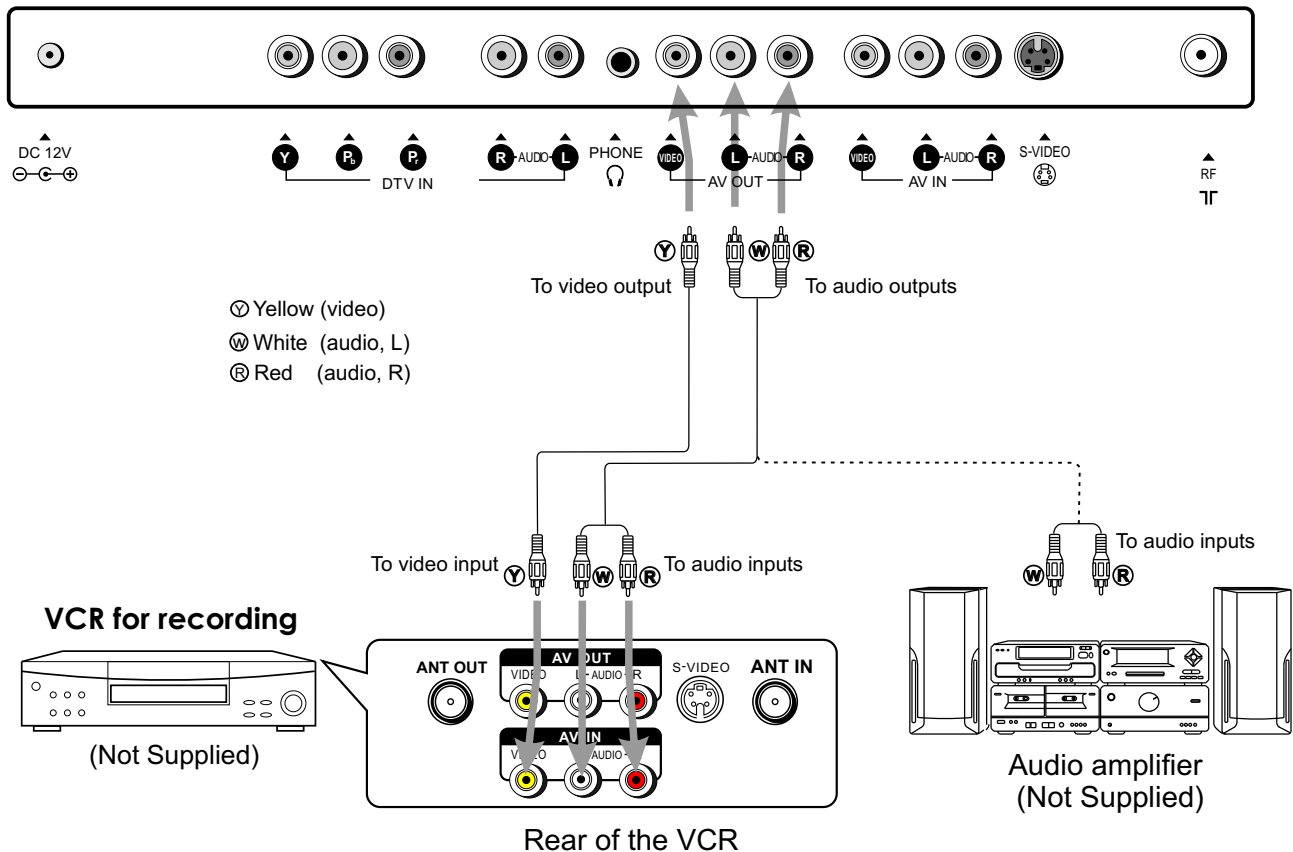

How to connect:

Connect the video/audio output terminals on the TV set to the signal input terminals of the VCR equipment or the video/audio input terminals on other TV set through a video/audio cable.

Connect the audio output terminals on the TV set to the Audio amplifier through audio cable.

How to record the TV program:

1. Connect cables as shown above.
2. Turn on the LCD TV and select source.
3. Turn on the VCR and insert the tape.
4. Select the video input from the VCR menu that corresponds to the AV in on the VCR.
5. Press the "RECORD" button to begin recording.

How to enjoy high quality sound by Audio amplifier:

1. Connect cables as shown above.
2. Turn the volume of the Audio amplifier to minimum.
3. Turn on the LCD TV and select source.
4. Connect the RCA (Red/White) cable from the TV AV OUT to the AUX input on the back of the Audio Amplifier.
5. Set the Audio Amplifier to AUX INPUT.
6. Turn on the audio amplifier and adjust for a proper volume.

Installation(continued)

YPbPr input connection

Please connect the YPbPr input terminals on the TV set for better picture quality. And connect the audio outputs with the corresponding audio input terminals on the TV set.

If you select YPbPr signal, please set the input signal source of the LCD TV to **YPbPr / YCbCr** mode.

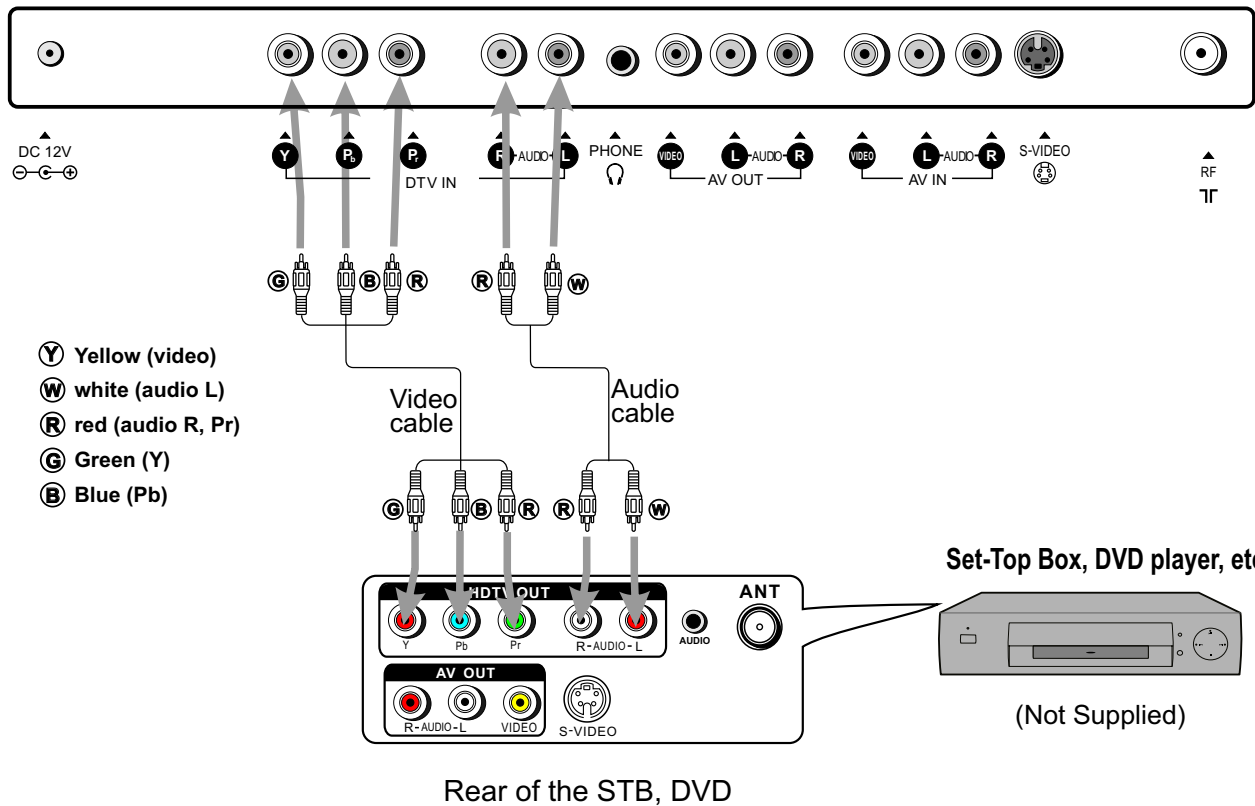

Notes:

The Y, Pb, Pr outputs on your DVD player are sometimes labeled Y, Cb, Cr. If so, connect the cables to like colors.

Basic Operations

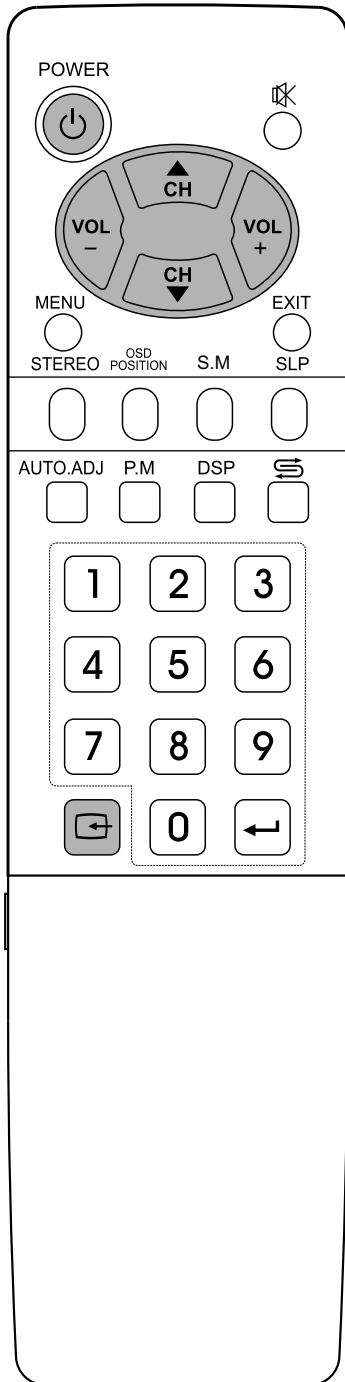

Turning on

- 1 Connect the power correctly, then the red indicator lights up and the unit is in STANDBY mode. (See Page 14.)
- 2 Press the **POWER** (⏻) button on the remote control or on the unit to turn on the TV set. The indicator LED will turn to yellow.

Turning off

- 1 With the power on, press the **POWER** (⏻) button to turn off the TV and put the TV in STANDBY mode, the indicator LED will turn to red.
- 2 If you want to turn off the power completely, unplug the power cord from the wall outlet.

Note: Do not switch the on/off state of the unit quickly. The interval of the turning on and turning off should be more than 5 seconds.

Selecting input signal

- 1 Press the **SOURCE** button on the unit or  button on the remote control. The screen displays the menu as shown on the right.
- 2 Press **CH** \uparrow/\downarrow to highlight your desired input signal source. Press **VOL** $+/-$ or wait for about 4 seconds and the desired signal source will be selected.

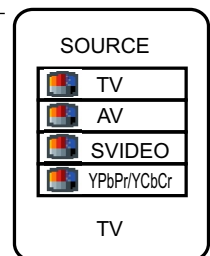

Note: All buttons shown in the manual are located on the remote control unless otherwise indicated.

Main On-Screen-Display (OSD) introduction

- 1 Press **MENU** button to display menu screen.
- 2 Press **VOL+/-** to select the menu.
- 3 Press **CH ▾** to access the menu.
- 4 Press **CH ▲/▾** to select the item.
- 5 Press **VOL+/-** to adjust the item.
6. Press **EXIT** button twice to exit the menu.

TV/AV/S-VIDEO MODE

Picture Setting Menu

brightness	<input type="text" value="50"/>	50
contrast	<input type="text" value="50"/>	50
color	<input type="text" value="18"/>	18
sharpness	<input type="text" value="32"/>	32
tint	<input type="text" value="0"/>	0

System Setting Menu

blue screen	on	
backlight	<input type="text" value="6"/>	6
ccd mode settings	CC 1	
V-chip settings	----	

Audio Setting Menu

SRS	on	off	
MTS	mono	stereo	SAP
bass	<input type="text" value="0"/>	0	
treble	<input type="text" value="0"/>	0	
balance	<input type="text" value="0"/>	0	

Channel Setting Menu

channel number	9	
antenna/cable	antenna	cable
add/erase	add	erase
fine tune	<input type="text" value="48"/>	48
channel search	<input type="text" value=""/>	

OSD Setting Menu

language	English	
OSD position	<input type="checkbox"/> <input type="checkbox"/> <input type="checkbox"/> <input type="checkbox"/> <input type="checkbox"/> <input type="checkbox"/> <input type="checkbox"/> <input type="checkbox"/> <input type="checkbox"/> <input type="checkbox"/>	
OSD background	opaque	translucent
OSD timeout	30 seconds	

Signal Information Menu

video type:	650 X 462/60Hz
mode:	3

YPbPr/YCbCr MODE

Picture Setting Menu

brightness	<input type="text" value="50"/>	50	
contrast	<input type="text" value="50"/>	50	
color temp	5000K	7300K	9300K user
customer temp setting	<input type="text" value=""/>		

Picture Position MENU

h position	<input type="text" value="50"/>	50
v position	<input type="text" value="50"/>	50
phase	<input type="text" value="15"/>	15
frequency	<input type="text" value="866"/>	866

Audio Setting Menu

SRS	on	off
bass	<input type="text" value="0"/>	0
treble	<input type="text" value="0"/>	0
balance	<input type="text" value="0"/>	0

System Setting Menu

sleep time	20	minutes
Back light	<input type="text" value="6"/>	6

OSD Setting Menu

language	English	
OSD position	<input type="checkbox"/> <input type="checkbox"/> <input type="checkbox"/> <input type="checkbox"/> <input type="checkbox"/> <input type="checkbox"/> <input type="checkbox"/> <input type="checkbox"/> <input type="checkbox"/> <input type="checkbox"/>	
OSD background	opaque	translucent
OSD timeout	30 seconds	

Signal Information Menu

resolution:	640 X 480/60Hz
mode:	40

Note: in AV/S-VIDEO mode, **Channel Setting** menu can not be accessed and there is no **MTS** menu item in **Audio Setting** menu.

Note: in YPbPr/YCbCr mode, there are no **color temp** and **customer temp setting** menu items in **Picture Setting** menu.

Operations

Picture adjustment

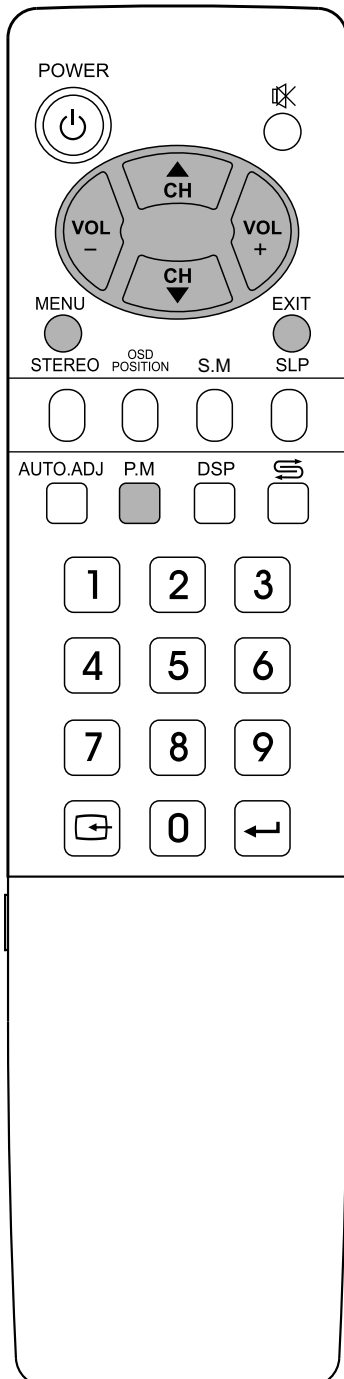

1 Access **Picture Setting** menu by pressing **MENU**.

2 Press **CH ▲/▼** to select the item that you want to adjust.

3 Press **VOL+/-** to adjust selected item.

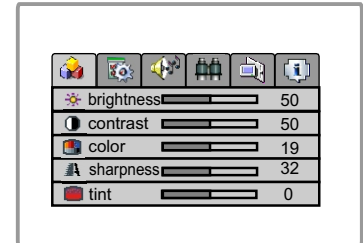

Item	Function	Range
brightness	To adjust picture's brightness	0-100
contrast	To adjust picture's contrast	0-100
color	To adjust picture's color	0-36
sharpness	To adjust picture's sharpness	0-63
tint	To adjust picture's tint	-32-+31

You can select picture mode by **P.M** button. There are four picture modes: **Bright, Nature, Soft** and **User**.

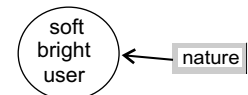

Bright: Select for a bright picture.

Nature: Select for a standard picture.

Soft: Select for a soft picture.

NOTE: Setting the unit to a Bright Picture with high brightness and contrast levels will cause picture quality loss.

Operations (continued)

System setting

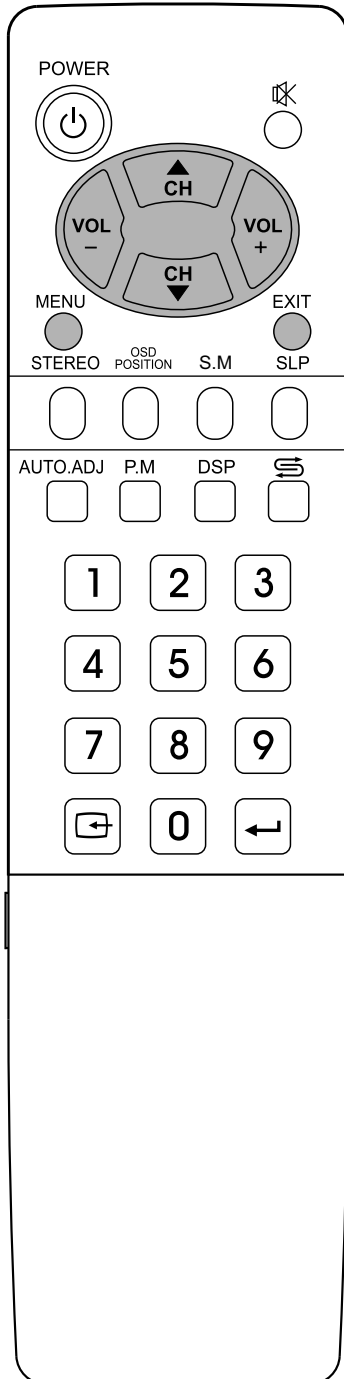

blue screen setting

- 1 Access the **System Setting** menu.
- 2 Press **CH ▲/▼** to select **blue screen** item.
- 3 Press **VOL+/-** to select **off** or **on**.
If you select **on**, the screen displays blue background when there is no signal. If you select **off**, the screen displays static when there is no signal.

! Note: Only when the blue screen is **on**, the set will turn off automatically after 15 minutes if there is no signal.

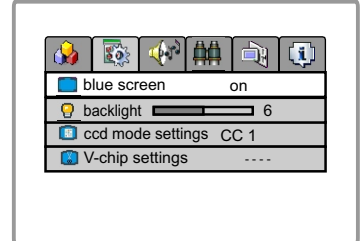

backlight adjustment

- 1 Access the **System Setting** menu.
- 2 Press **CH ▲/▼** to select **backlight** item.
- 3 Press **VOL+/-** to adjust the backlight brightness.

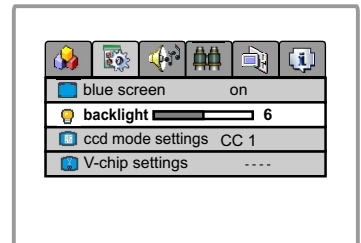

Operations (continued)

System setting

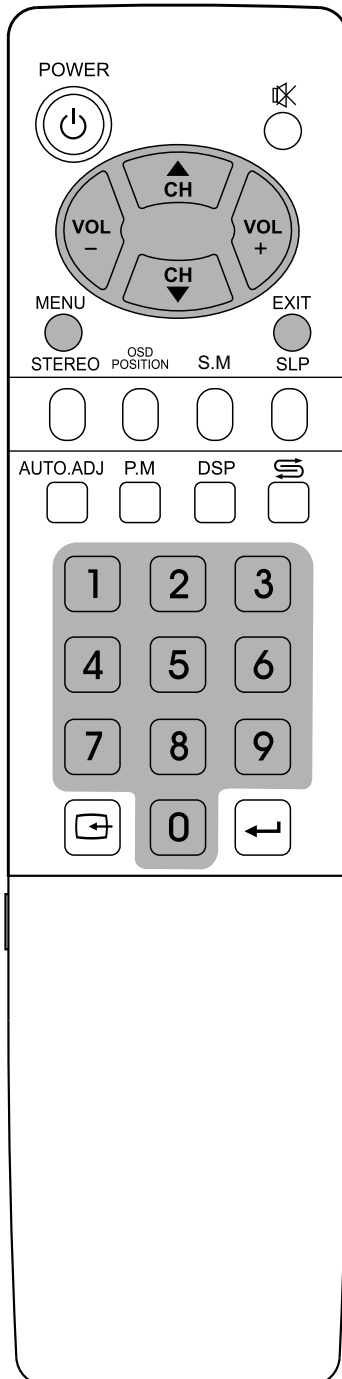

Setting Closed Caption(CCD)

- 1 Access the **System Setting** menu.
- 2 Press **CH▲/▼** to select **ccd mode settings** item.
- 3 Press **VOL+/-** to select . You can select the caption data channel (CC1, CC2, CC3, CC4), the text service channel(text1, text2, text3, text4) or turn off the Closed Caption(Off).

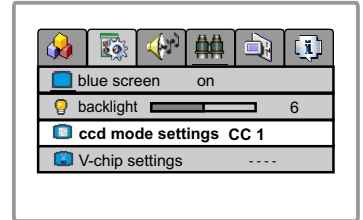

! Note:

1. Some TV programs may not be broadcast with closed caption signals, and therefore the TV will not be able to display captions, Also, text information is not offered by all stations.
2. Some TV programs only provide one channel caption, one channel text, or only caption without text.

Parental Control with V-Chip

- 1 Access the **System Setting** menu.
- 2 Press **CH▲/▼** to select **V-Chip settings** item.
- 3 Enter the password using the keypad to access the V-chip sub-menu.(The default password is 1234 and you should change the password after you access the sub-menu.)
- 4 Press **CH▲/▼** to select **Vchip global setting** item. Use **VOL+/-** to select **disable** or **enable**. If you select **enable**, the function is activated. If you select **disable**, the function is not active.

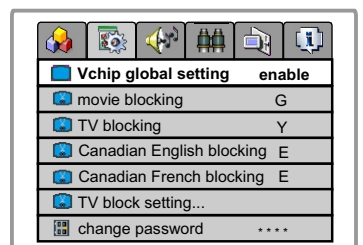
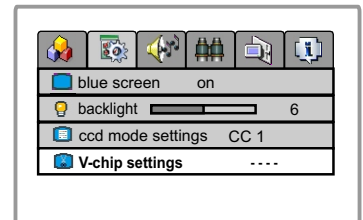

Operations (continued)

System setting (V-Chip Sub-menu)

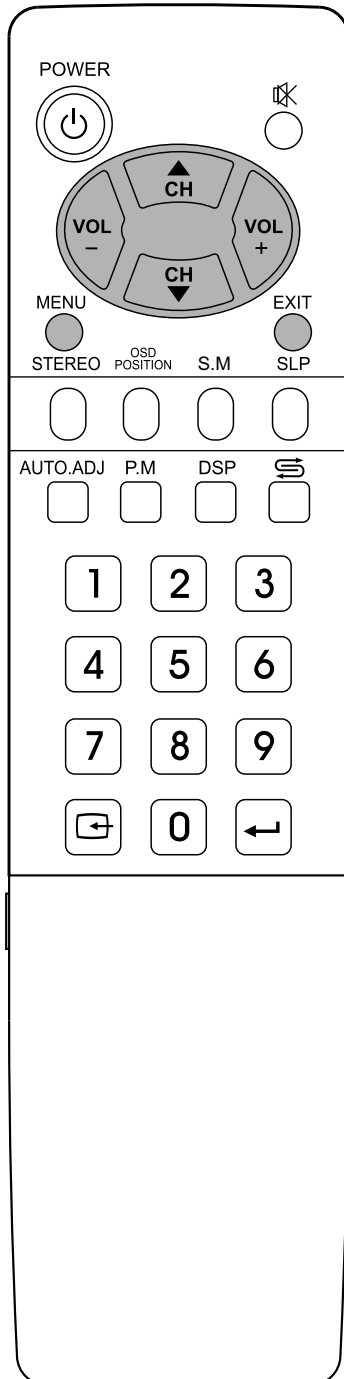

Movie Blocking setting

This function allows programs to be restricted and TV usage to be controlled based on program rating. It prevents children from watching violent or sexual scenes that may be harmful.

Please enter the V-chip sub-menu (previous page).

- 1 Press **CH ▲/▼** button to select **movie blocking** item.
- 2 Press **VOL +/-** button to select desired rating.

Vchip global setting	enable				
movie blocking	G				
TV blocking	Y				
Canadian English blocking	E				
Canadian French blocking	E				
TV block setting...					
change password	****				

Movie Ratings:

- * NONE
- * G and Above (general audience)
- * PG and Above (parental guidance suggested)
- * PG-13 and Above (13 years and up)
- * R and Above (restricted)
- * NC-17 and Above (18 years and up)
- * X (adult)

If you set PG-13, G and PG movies will be available, and PG-13, R, NC-17 and X will be blocked.

TV blocking setting

This function allows TV programs to be restricted and TV usage to be controlled based on age and content. It prevents children from watching violent or sexual scenes that may be harmful.

Age base

Please enter the V-chip sub-menu (previous page).

- 1 Press **CH ▲/▼** button to select **TV blocking** item.
- 2 Press **VOL +/-** button to select the desired rating.

Vchip global setting	enable				
movie blocking	G				
TV blocking	Y				
Canadian English blocking	E				
Canadian French blocking	E				
TV block setting...					
change password	****				

TV Ratings:

- * NONE
- * Y and Above (all children) (individual content categories do not apply)
- * Y7 (7 years and up)
- * G and above (general audience) (individual categories do not apply)
- * PG and Above (parental guidance suggested)
- * 14 and above (14 years and up)
- * MA (mature audience)

V-Chip enables parents to prevent their children from watching inappropriate material on TV. V-Chip reads the ratings for programming (except for news, sports, unedited movies on premium cable, and Emergency System signals), then denies access to programming if the program's rating meets the limitations you select. In this case, the program will be blocked.

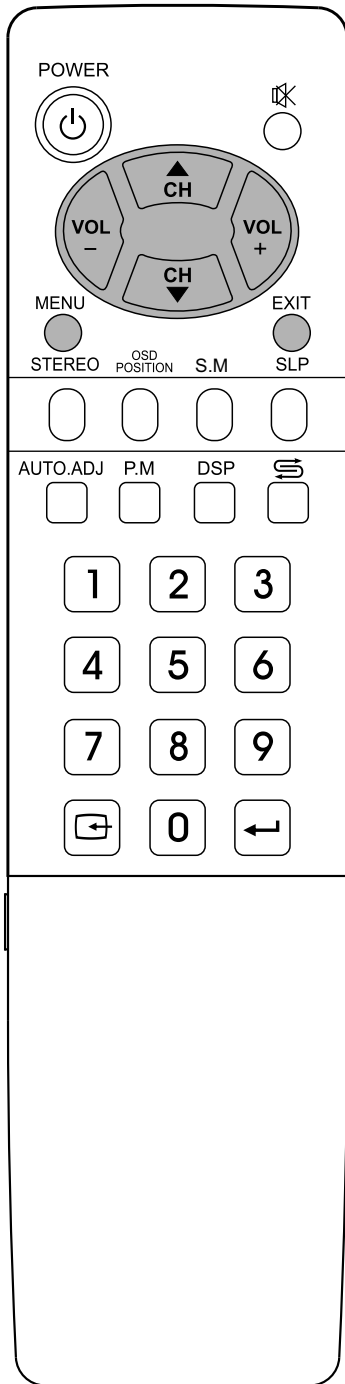

Content based

Please enter the V-chip sub-menu first (page 24).

- 1 Press **CH ▲/▼** button to select **TV blocking setting...** item.
- 2 Press **VOL+** button to access the sub-menu.
- 3 Setting the content with **CH+/-** and **VOL+/-** buttons.

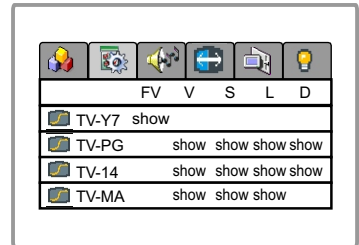
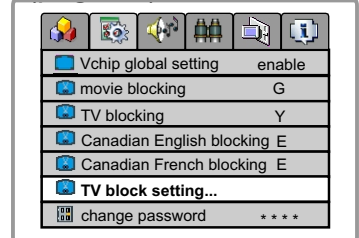

Content Categories:

- * FV: fantasy violence (applies only to TV-Y7)
- * V: violence (applies to TV-PG and above, TV-14 and Above, TV-MA)
- * S: sexual situations (applies to TV-PG and above, TV-14 and Above, TV-MA)
- * L: adult language (applies to TV-PG and above, TV-14 and Above, TV-MA)
- * D: sexual dialogue (applies to TV-PG and Above, TV-14)

Canadian English Blocking setting

Please enter the V-chip menu first (page 24).

- 1 Press **CH ▲/▼** button to select **Canadian English blocking** item.
- 2 Press **VOL+/-** button to select the desired rating.

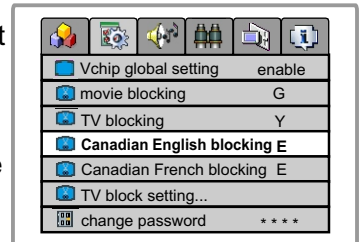

Canadian English Language Ratings:

- * E: Exempt.
- * C: Children.
- * C8+: Children 8 years and older.
- * G: General programming, suitable for all audiences.
- * PG: Parental guidance.
- * 14+: Viewers 14 years and older.
- * 18+: Adult programming.

Operations (continued)

System setting (V-Chip Sub-menu)

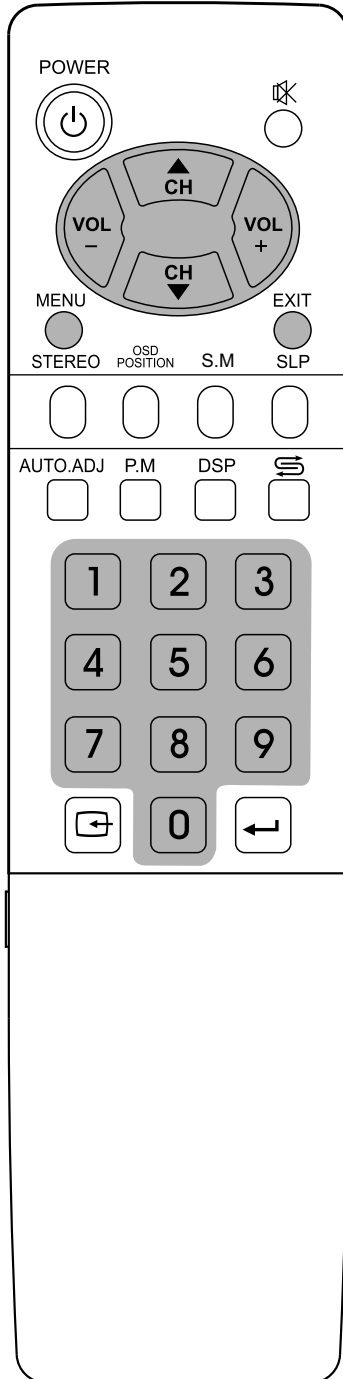

Canadian French blocking setting

Please enter the V-chip sub-menu first (page 24).

- 1 Press **CH ▲/▼** button to select **Canadian French blocking** item.
- 2 Press **VOL +/-** button to select desired rating

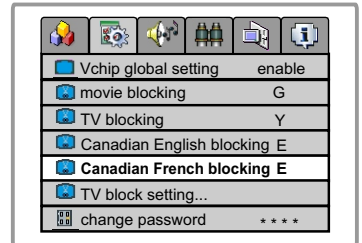

Canadian French Language Ratings:

- * E: Exempt.
- * G: Children.
- * 8 ans+: Children 8 years and older.
- * 13 ans+: Children 13 years and older.
- * 16 ans+: Viewers 16 years and older.
- * 18 ans+: Adult programming.

Changing the password

Please enter the V-chip sub-menu first (page 24).

- 1 Press **CH ▲/▼** button to select **change password** item.
- 2 Input a new 4-digit password by using the keypad on the remote.

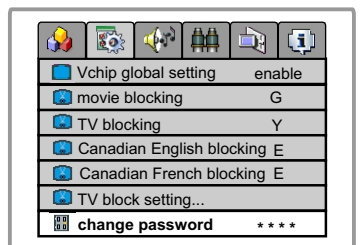

Next time when you want to access the V-chip menu, you will use your new password. Make sure to remember the password.

Operations (continued)

Audio Setting

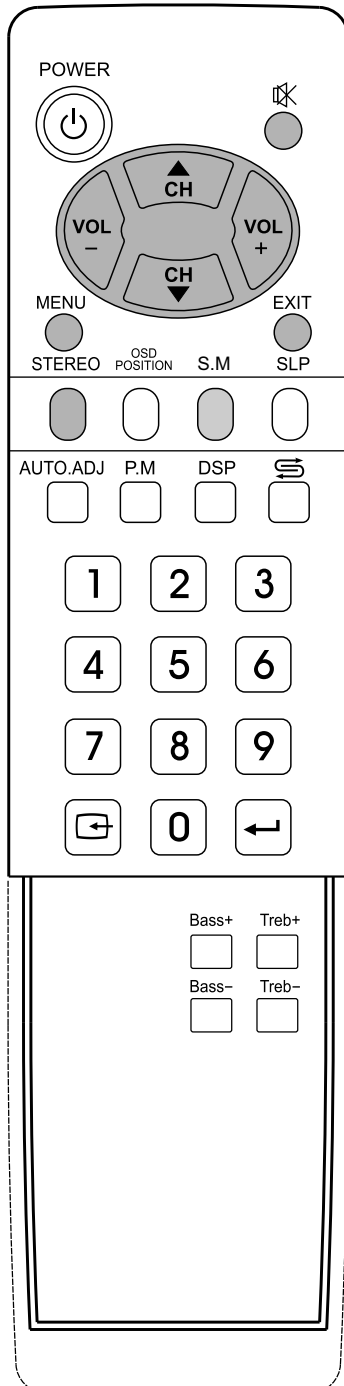

Selecting the MTS

- 1 Access the **Audio Setting** menu.
- 2 Press **CH ▲/▼** to select **MTS** item.
- 3 Press **VOL+/-** to select **mono**, **stereo** or **SAP(secondary audio program)**.

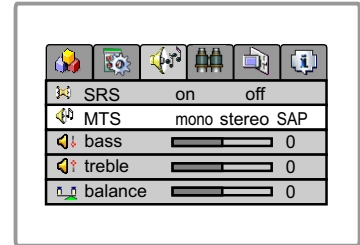

You can also directly press **STEREO** button on the remote control to select the MTS. The MTS mode changes as follows:

MONO ↔ STEREO (If the program is **STEREO**)

MONO ↔ SAP (If the program is **SAP**)

MONO → STEREO → SAP (If the program is **STEREO & SAP**)



NOTE: SAP = Secondary Audio Program.

Adjusting volume

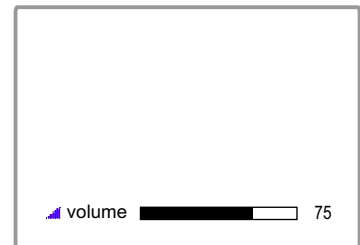
Press **VOL+/-** to adjust volume. Press **VOL+** button, the volume increases. Press **VOL-** button, the volume decreases. (Range:0-100)



Muting the sound

You can press the  button on the remote control to mute the sound. Press the  button again to restore. You can also press **VOL+** to restore the sound.

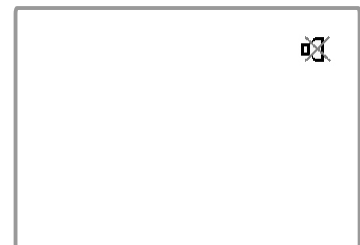

Selecting the sound mode

You can press **S.M** button on the remote control to switch the sound mode between **user**, **movie**, **music**, and **news**.

Movie: Select for a movie program.

Music: Select for a music program.

News: Select for a speech or talk program.

Custom settings mode in the Audio Setting OSD are saved under **USER** mode.

Operations (continued)

Audio Setting

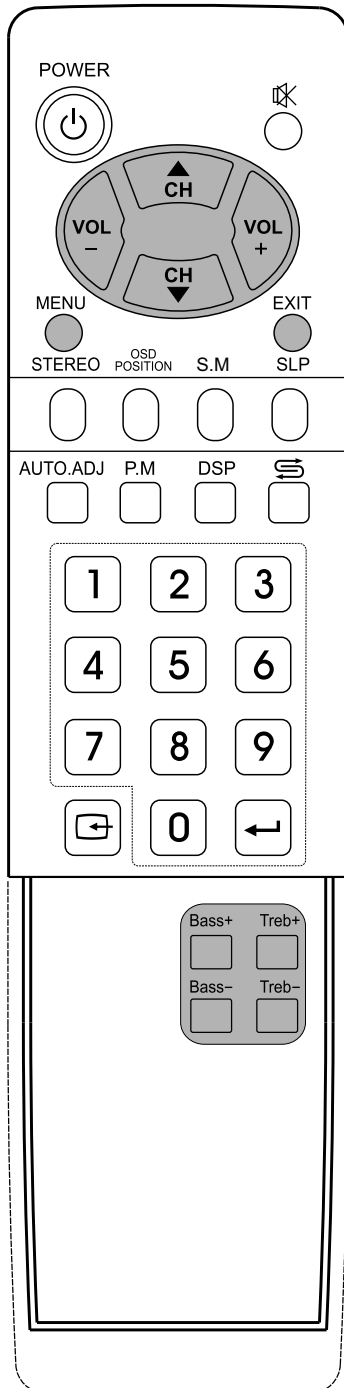

Adjusting the bass/treble

- 1 Access the **Audio Setting** menu.
- 2 Press **CH ▲/▼** to select **bass** or **treble** item.
- 3 Press **VOL+/-** to adjust the bass or treble.

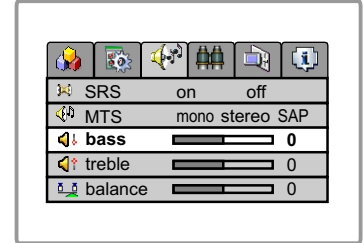

You can press the **Bass+/-** buttons on the remote control to adjust the **bass** directly; and you can also press the **Treb+/-** buttons on the remote control to adjust the **treble** directly.

Adjusting the sound balance

- 1 Access the **Audio Setting** menu.
- 2 Press **CH ▲/▼** to select **balance** item.
- 3 Press **VOL+/-** to adjust the balance of the left track and right track.

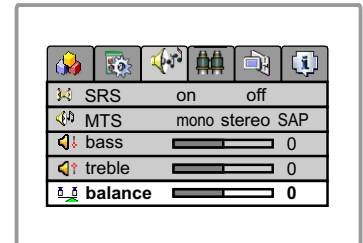

Adjusting the SRS

- 1 Access the **Audio Setting** menu.
- 2 Press **CH ▲/▼** to select **SRS** item.
- 3 Press **VOL+/-** to select **on** or **off**.

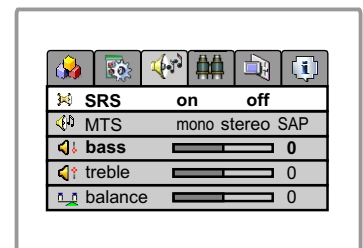

SRS (Sound Retrieval System®) is an audio enhancement technology that restores the spatial cues that are present in a live listening environment and processes it to provide a natural 3D sound field.

* The SRS symbol are trademark of SRS Labs, Inc.
SRS technology is incorporated under license from SRS Labs, Inc.

Operations (continued)

Channel Setting

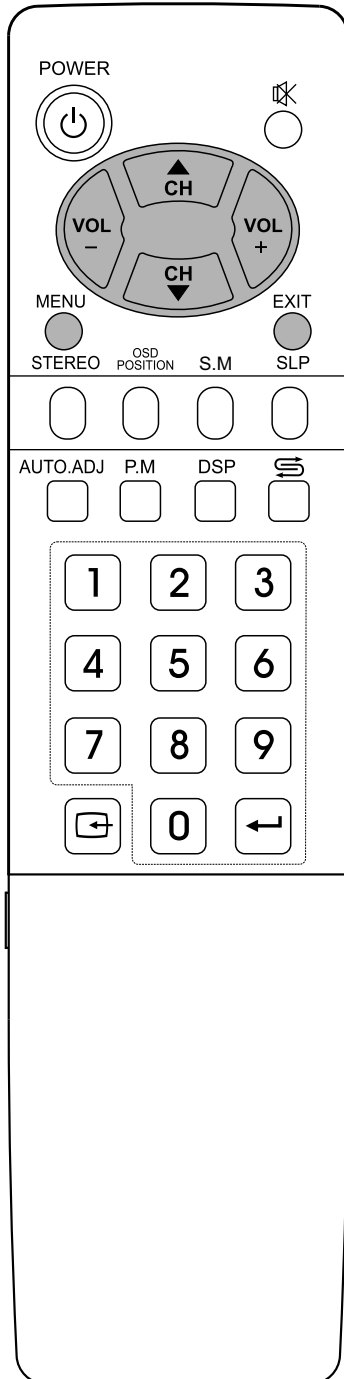

Selecting antenna/cable

- 1 Access **Channel Setting** menu.
- 2 Press **CH ▲/▼** to select **antenna/cable** item.
- 3 Press **VOL+/-** button to select **antenna** or **cable**.

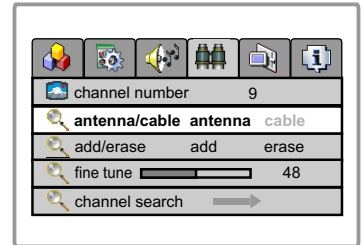

Please select **antenna** or **cable** before you start **Auto Search**. If the TV is connected to antenna, please select **antenna**. If the TV is connected to cable, please select **cable**.

Auto Search

Please access the **Channel Setting** menu first.

- 1 In Channel Setting menu, press **CH ▲/▼** button repeatedly to highlight **channel search** item.
- 2 Press **VOL+/-** to start Auto Search.
All active channels will be preset and stored into the memory automatically.

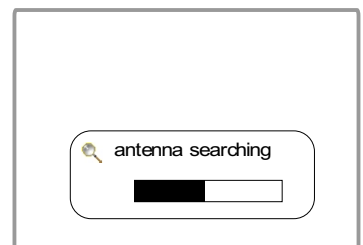
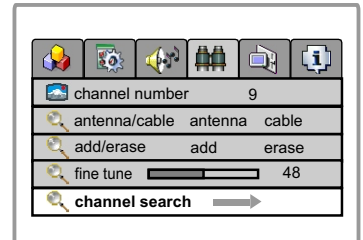

Operations (continued)

Channel Setting

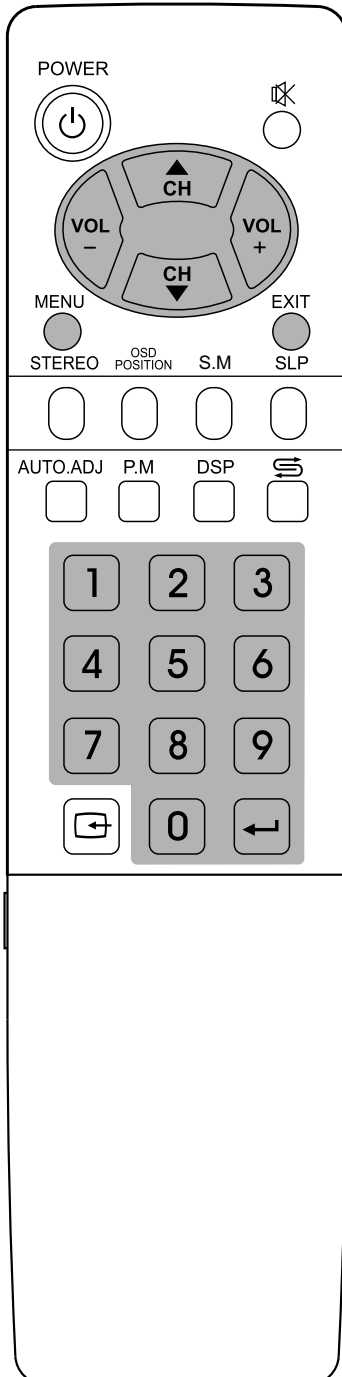

Adding/Erasing Channels

After the Channel SEARCH, you can **Add/Eraser** channels that you watch when you press the **CH▲/▼** to change channels.

1 Select the channel number which you want to erase using the keypad.

2 Access the **Channel Setting** menu.

3 Press **CH▲/▼** to select **add/erase** item.

4 Press **VOL+/-** to select **erase**. When you press **CH▲/▼** to change channels, this channel will be skipped.

If you want to resume a skipped channel, use the keypad buttons to enter the channel, then access the **Channel Setting** menu, press **VOL+/-** to select **add**. When you press **CH▲/▼** to change channels, the channel will be present.

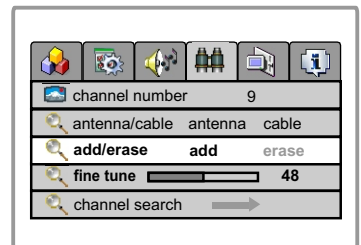
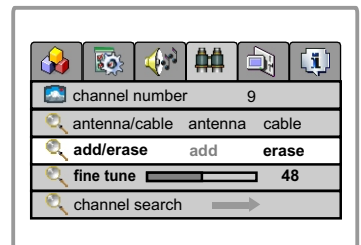

Fine tuning

Please access the **Channel Setting** menu first.

1 In **Channel Setting** menu, press **CH▲/▼** button repeatedly to highlight **Fine tune** item.

2 Press **VOL+/-** to fine tune to achieve best picture and sound.

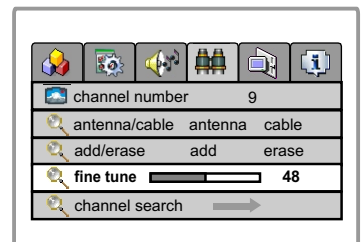

Operations (continued)

Selecting channel

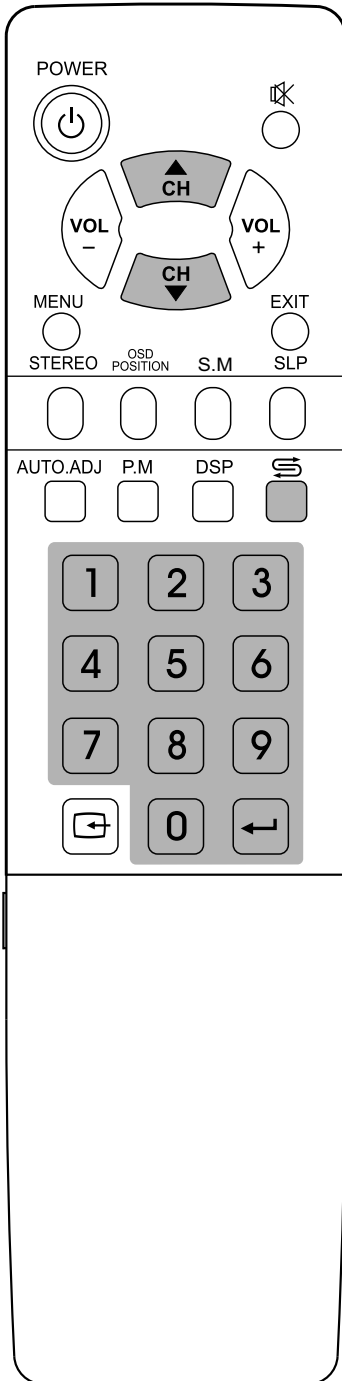

* You can press **DSP** button to Know current channel number information.

Using Keypad buttons

1 To select one-digit channel numbers:

Input the channel using the **0-9 number button**, then press **Channel Enter** ← button to confirm.

2 To select two-digit channel numbers:

Input the channel using the **0-9 number button**, then press **Channel Enter** ← button to confirm.

3 To select three-digit channel numbers:

Input the channel using the **0-9 number button** directly.

Note: The period between presses should be within 2 seconds.

Using Channel up/down buttons

1 Press **CH ▲** button, the channel number increases;

2 Press **CH ▼** button, the channel number decreases.

NOTE: This feature works after a channel search is complete.

Using previous channel button

Press **↔** button to switch between the current channel and previous channel.

Operations (continued)

OSD Setting

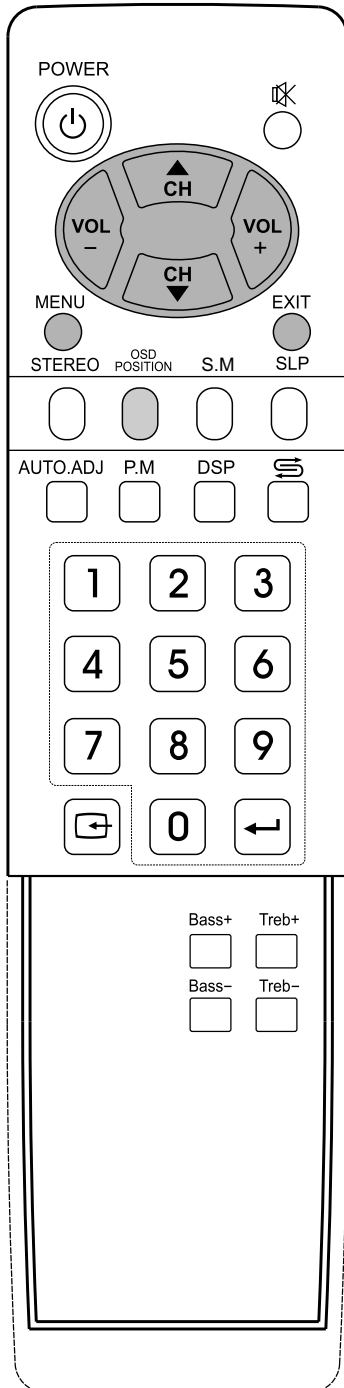

Setting the language of the menu

- 1 Access the **OSD Setting** menu.
- 2 Press **CH ▲/▼** to select the **language** item.
- 3 Press **VOL +/-** to select an OSD language. English, Spanish and French can be selected.

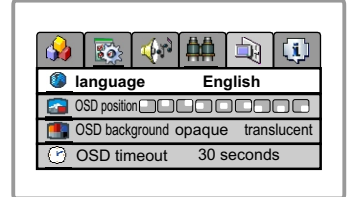

Setting the position of the menu

- 1 Access the **OSD Setting** menu.
- 2 Press **CH ▲/▼** to select the **OSD position** item.
- 3 Press **VOL +/-** to select the position of the menu displaying.

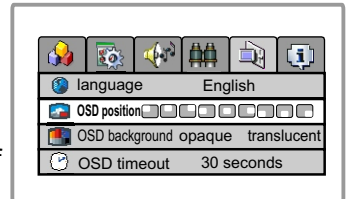

You can also press the **OSD POSITION** button on the remote control to select OSD menu position.

Setting the background of the menu

- 1 Access the **OSD Setting** menu.
- 2 Press **CH ▲/▼** to select the **OSD background** item.
- 3 Press **VOL +/-** to select **opaque** or **translucent**. If you select Opaque, the background of the menu is opaque. If you select translucent, the background of the menu is translucent.

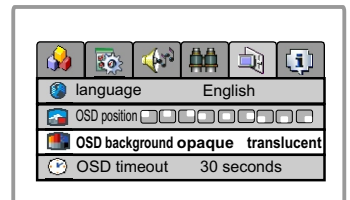

Setting the OSD timeout

- 1 Access the **OSD Setting** menu.
- 2 Press **CH ▲/▼** to select the **OSD timeout** item.
- 3 Press **VOL +/-** to set the timeout: 5, 10, 15, 20, 25, 30, 35, 40, 45, 50, 55, 60 seconds.

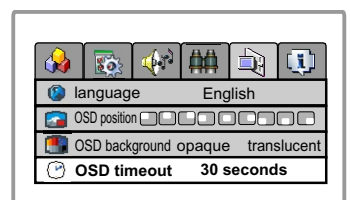

Operations (continued)

Timer setting

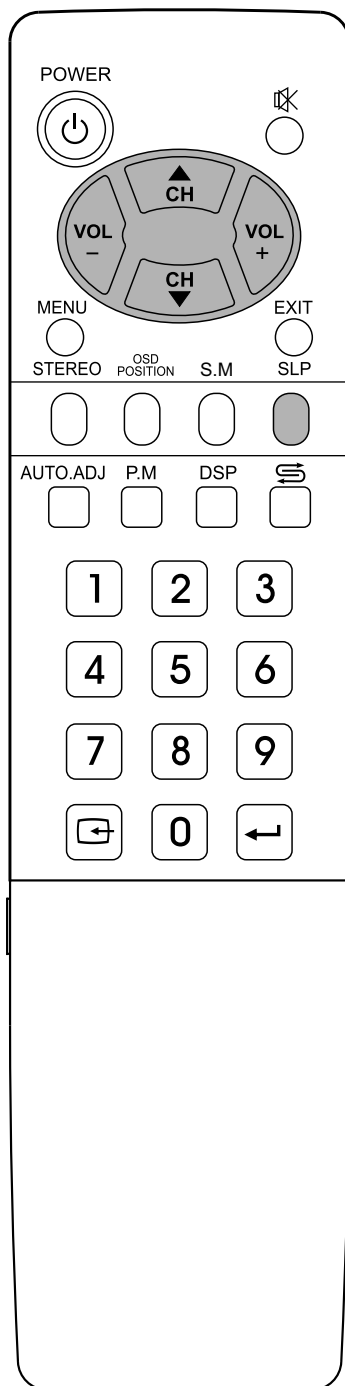

Using Sleep button

Press **SLP** button to display **sleep timer** menu. Press **CH▲/▼** or **VOL+/-** repeatedly to set sleep time between:0, 10, 20, 30, 60, 90, 120, 180, 240 minutes. If you select 0 minute, the sleep timer function is turned off.

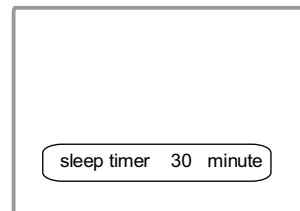

Press the **SLP** button again to exit the menu.

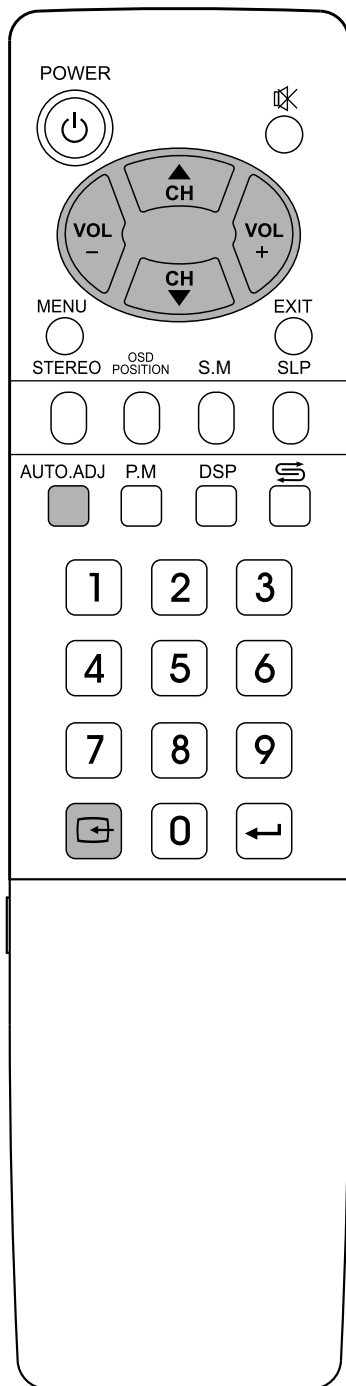

Operations in /YPbPr mode



Select YPbPr mode

- 1 Press the **SOURCE** button on the unit or button  on the remote control. The screen displays the menu shown as right.
- 2 Press **CH**  /  to highlight the **YPbPr/YCbCr** item. Press **VOL+** / **-** or wait about 4 seconds and the signal source is selected.

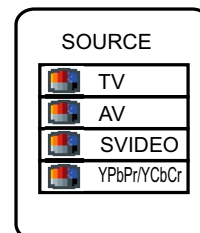

Operations in VGA /YPbPr mode (continued)

Picture Settings

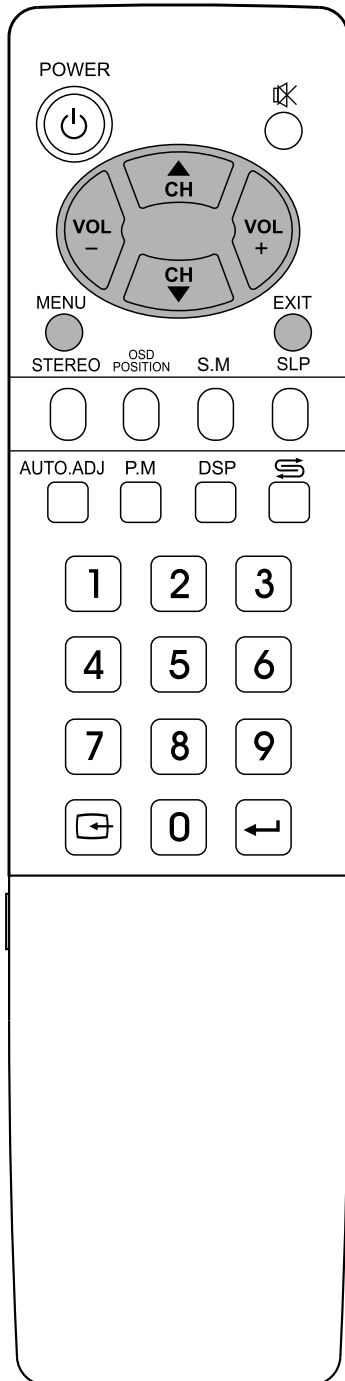

Adjusting Brightness/Contrast

- 1 Access the **PICTURE** menu.
- 2 Press **CH ▲/▼** to select **brightness** or **contrast** item.
- 3 Press **VOL+/-** to adjust the selected item.

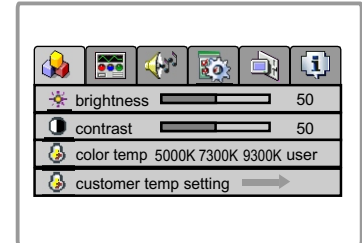

Item	Function	Notes
brightness	Adjust the brightness of the picture.	Will Not affect the display settings in the TV, AV mode
contrast	Adjust the contrast of the picture.	

Setting the color temperature

- 1 Access the **Picture Setting** menu.
- 2 Press **CH ▲/▼** to select **color temp** item.
- 3 Press **VOL+/-** to switch the color temperature between 5000K, 7300K, 9300K and User.
- 4 If you want to change the value of the user mode, set **color temp** to **user** first, then select **customer temp setting** item, and press **VOL+/-** to access the sub-menu.
- 5 Press **CH ▲/▼** to select the item and press **VOL+/-** to adjust it. The value you set will be stored .

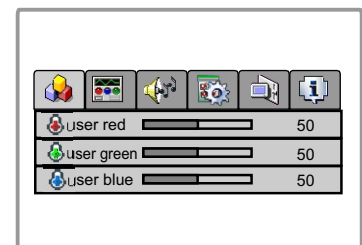
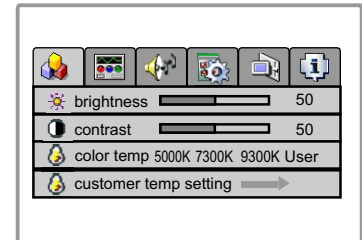

AUDIOVOX[®]

ELECTRONICS CORP.

Troubleshooting

Interference

[Please note the following common TV reception interferences:]



Ignition effect

Black spots or vertical lines may appear. Screen jumps crazily or is very unstable. This is commonly the result of car ignition system interference, neon lights, or other forms of electrical interferences.



Ghost Shadows

This is the result of two signals : One being the original signal from the antenna while the 2nd signal is a slightly delayed signal, normally the result of bouncing off tall buildings or other obstructions. This problem might be corrected by adjusting your outdoor antenna.



Flurries

Lots of tiny dots appears on your screen. This is the result of poor reception signals. You may have to re-enforce your antenna signals.

★ note: note: If interferences occur while you are using a cable system, then the problem could be at the cable source and not from your TV reception.

AUDIOVOX[®] ELECTRONICS CORP.

TV Troubleshooting

You may have problems that can be fixed with a few minor adjustments. Look for the type of problem you are having below and then apply the suggestions to get your TV going again.



Picture with no sound

- Check if you have accidentally pressed the "mute" button
- Check other channels if the same problem exist. If other channels are fine, then problem is with the TV program you are viewing. This shouldn't be a concern
- Verify all connections are firmly attached
- Connect cable to another TV
- If all checks fail, please contact our serviceman



Sound with no picture

- Check if main power is switched on
- Check brightness and contrast level to see if they have been tuned to the minimum level thus making the screen dark
- Unplug the cable and re-plug it in after two minutes
- Check if you have accidentally pressed the "mute" button
- Connect cable to another TV



No Picture No Sound

- Check main power source
- Check other TV channels. If they are okay, problem is just with the TV program you are viewing
- Press the SOURCE button on the remote or on the top of the unit to get to the desired display option
- If you are using outdoor antenna, please check your connections
- Please check if your power cord is connected properly, it may be loose
- Switch off main power, disconnect cable. Reconnect cable after two minutes rest then switch on the main power
- Check if the antenna or cable are well connected
- Check your Remote Control
- Check power adapter and power cord if they have been damaged
- Connect cable to another TV
- If all fails, please contact with serviceman immediately

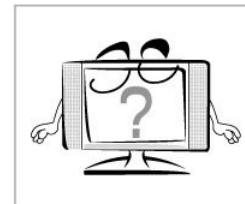

AUDIOVOX[®] ELECTRONICS CORP.

TV Troubleshooting



Picture too dark

- Check your brightness level
- Check your contrast level
- In the on screen display (OSD) select default
- Check your LCD monitor for possible damage

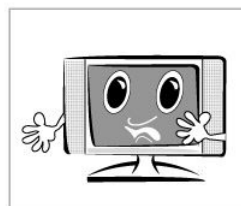

Remote Control Failure

- Check TV main power source
- Check if remote control batteries are weak
- Check if batteries have been correctly installed
- Check if there are obstructions between your remote control and the main TV remote sensor
- Disconnect your cable for two minutes before reinstalling it
- If failure resulted from electrical interferences, lighting or static, disconnect the TV main power for 10 seconds before reinstalling it. Restart your TV
- Try holding remote 2 inches from sensor

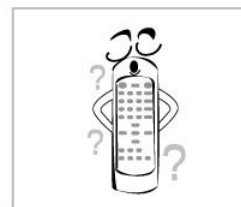

Picture is blurry

- Check other channels. Problem may be an isolated incidence
- If using outdoor antenna, please check connections
- Please check your accessories. Such as Video recorder, VCD, DVD
- Check your cable company or outdoor antenna reception
- RF signal may be too slow
- If all fails, please contact our serviceman immediately

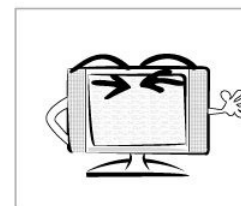

AUDIOVOX[®] ELECTRONICS CORP.

TV Troubleshooting

Before calling our serviceman, please refer to the following chart to see if you can adjust the problems yourself.

Trouble	Checks and Adjustments
TV will not turn on	<ul style="list-style-type: none"> ■ Plug TV in. ■ Plug something else into the outlet to make sure it is working. ■ Make sure batteries in the remote are not dead. ■ Make sure batteries are placed in the remote the right way. ■ Unplug TV for a few minutes and then turn it on again.
Poor sound or no sound	<ul style="list-style-type: none"> ■ Check volume settings and mute settings ■ Check for possible interference sources
Blur picture or no picture	<ul style="list-style-type: none"> ■ Check antenna or TV cable ■ Check for possible outside interferences ■ Check picture settings
Some channels are not clear	<ul style="list-style-type: none"> ■ Check outdoor antenna and make necessary adjustments ■ Check possible outside interferences
Poor Color tone or No color	<ul style="list-style-type: none"> ■ Check memory settings ■ Check Color settings ■ Check if program is in correct channel ■ Check antenna and cable connections ■ Check possible outside interferences
No reception from Cable	<ul style="list-style-type: none"> ■ Check if cable is connected properly ■ Check if channels are selected properly ■ Check if cable company are experiencing technical problems
Channels above 13 cannot receive	<ul style="list-style-type: none"> ■ Check TV channel settings ■ Check antenna and UHF settings
Unable to operate remote	<ul style="list-style-type: none"> ■ Check for low batteries or possible obstructions between remote and TV sensor ■ Check TV main power source
TV shut off	<ul style="list-style-type: none"> ■ Electric power failure ■ Preset sleep mode features are on ■ TV programs ended

AUDIOVOX[®]

ELECTRONICS CORP.

Notices



NOTICES

1. The contents stated in this document and the product may be subject to change without prior notice. Please ask your distributor or go to WWW.AUDIOVOX.COM for the latest information.
2. This product is developed and produced for usage onto normal electronic products (home, office, automation equipment, game machine, etc) and is not suitable for applications which need extremely high reliability and extreme safety (aero- or space-use machines, control equipment for nuclear power, life keeping equipments, etc.)
3. It is strictly prohibited to copy or publish a part or whole of this document without our prior written approval.

Optical Specification

Optical characteristics are determined after the unit has been 'ON' and stable for approximately 30 minutes in a dark environment at 25c.

The values specified are at an approximate distance 50cm from the LCD surface at a viewing angle of 0 degree.

Lamp Life

Lamp life is defined as the time when brightness becomes 50% of the original value under standard condition.

AUDIOVOX[®]

ELECTRONICS CORP.

Maintenance / Repair



Maintenance:

- **DO NOT** wipe LCD with water

Clean the LCD using a dry soft cloth such as gauze. If the LCD is heavily soiled, apply a cleaner for LCD panels to the cloth and wipe off gently. DO NOT use chemical such as acetone, solvents as xylene or toluene.

- **WIPE** the cabinet with a soft cloth

If the cabinet is heavily soiled, wipe with soft cloth dipped in water



REPAIR: (Important)

DO NOT SHIP PRODUCT BACK FOR REPAIR WITHOUT FIRST CONTACTING AUDIOVOX AT 1-800- 619-3848

Specifications

Specifications:

N/A = Not Available

Model Number: FPE2005	ver: 00
UPC number: 0-44476-02740-6	
Display Features	
Display type	TFT LCD
Screen Size	20.1" (diagonal)
Active Area	408 (H) x 306 (V) mm
Aspect Ratio	4:3
Panel Resolution	640x480
Brightness	450 Cd/m ² (typical)
Contrast ratio	500:1
Viewing Angle	160(H) : 140(V)
Dot Pitch	0.2125(H) x 0.6375(V) mm
Maximum Color	16.7 Million
Response time (Tr&Tf)	16ms (typical)
Backlight life	60,000hrs
TV Reception	
TV System	NTSC
Channel CATV - UHF/VHF	181 Channel
Antenna Impedance	75Ohm
Connector type	F
Audio	
Maximum Audio Output	5watt x 2
Total number of speakers	2
Video Connections	Quantity
NTSC Analog TV Tuner	1
ATSC Digital TV Tuner	N/A
Composite Video Input	1
S-Video Input (4pin DIN)	1
Component Input (Y,Pb,Pr)	1 (480p, 720p, 1080i**)
Component Input (Y,Cb,Cr)	N/A
VGA Input (15 pin D-Sub)	N/A
DVI Input (DVI-D, DVI-I)	N/A
HDMI Input	N/A
CableCARD	N/A
Composite Video Output	1
S-Video Output	N/A
Component Output (Y,Pb,Pr)	N/A
Component Output (Y,Cb,Cr)	N/A
VGA Output (15 pin D-Sub)	N/A
DVI Output (DVI-D, DVI-I)	N/A
HDMI Output	N/A
Video Standards Supported	
Composite Video input	PAL/NTSC
S-Video Input	PAL/NTSC
RF	NTSC
Audio Connections	Quantity
Stereo Mini Phono Jack Input (3.5mm)	N/A
RCA Input(Red, White)	1
Optical Digital Input	N/A
Coax Digital Input	N/A
Headphone:(Variable/Fixed) (3.5mm)	1 (variable)
Stereo Mini Phono Jack Output (3.5mm)	N/A
RCA Output(Red, White)	1
Optical Digital Output	N/A
Coax Digital Output	N/A

Features	
VESA wall mount compatible	
EDTV Ready	
Tilt stand with built-in Handle	
User Friendly remote and On Screen Display (OSD)	
Ultra slim design	
181 Channel Cable/AIR TV tuner built in	
High resolution Composite and S-Video input	
Accessories in the box	
Wall mounting Bracket Kit	
AC/DC power supply	
Power cord	
Owners manual	
Warranty Card	
Product Registration card	
Remote Control (model Specific)	
2-AAA batteries	
FPE2005 TV unit	
Power Requirements	
Power Source	AC 100-240V, 50/60Hz
Unit input power	12VDC 5A 60W
Standby consumption	<2W
Dimension (WxHxD)	
Unit W/stand	25.1 x 17.4 x 7.5 inches
Unit W/O stand	25.1 x 14.9 x 2.6 inches
Weight (N.W.)	
Unit W/stand	20.3 lbs
Unit W/O Stand	17 lbs
Warranty	
Parts & Labor	12 Month
Environment	
Operating Temperature	41 - 95°F
Operating Humidity	10% - 95%



PRINTED IN
RECYCLED PAPER

128-7354

Free Manuals Download Website

<http://myh66.com>

<http://usermanuals.us>

<http://www.somanuals.com>

<http://www.4manuals.cc>

<http://www.manual-lib.com>

<http://www.404manual.com>

<http://www.luxmanual.com>

<http://aubethermostatmanual.com>

Golf course search by state

<http://golfingnear.com>

Email search by domain

<http://emailbydomain.com>

Auto manuals search

<http://auto.somanuals.com>

TV manuals search

<http://tv.somanuals.com>