

# AUDIOVOX

## LCD TV Owner's Manual

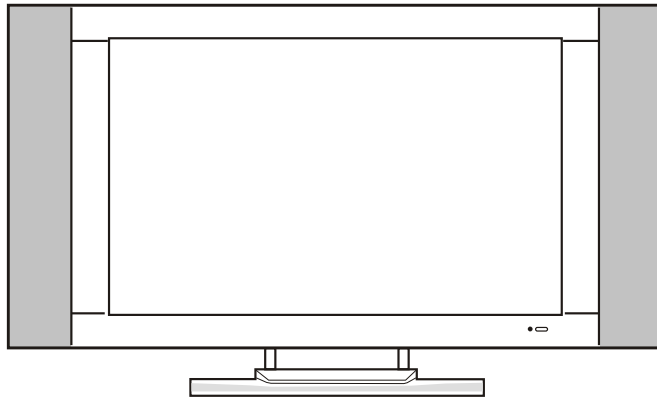

FPE3000

Before operating the unit, please read this manual thoroughly.

# Contents

Congratulations on your purchase of this **LCD TV**.

We recommend that you thoroughly read this manual before use to fully enjoy the many functions and excellent effects of this LCD TV.

Retain this manual in an easily accessible location for future reference.

**Note:** Screen displays and illustrations in this manual may differ from the actual ones for better visibility.

## Contents

<b>Important safety cautions</b> .....	5	<b>Picture adjustment</b> .....	24
<b>Identification of controls</b> .....	8	<b>Sound adjustment</b> .....	25
<b>Antenna connection</b> .....	12	<b>System Setup</b> .....	26
<b>Installation</b> .....	13	<b>Timer setting</b> .....	28
<b>Menu introduction</b> .....	19	<b>CCD setting</b> .....	29
<b>Turning On/Off / Selecting input signal</b> .....	21	<b>V-chip setting</b> .....	30
<b>Operations in TV mode</b> .....	22	<b>Adjustment in YPbPr mode</b> .....	32
<b>Channel Preset</b> .....	22	<b>Adjustment in PC mode</b> .....	33
<b>Channel Select</b> .....	23	<b>Troubleshooting</b> .....	35
		<b>Specifications</b> .....	41

# AUDIOVOX® ELECTRONICS CORP.

## Important Safety Instructions



**CAUTION**  
RISK OF ELECTRIC  
SHOCK DO NOT OPEN



CAUTION  
TO REDUCE THE RISK OF ELECTRIC SHOCK,  
DO NOT REMOVE COVER (OR BACK)  
NO USER-SERVICEABLE PARTS INSIDE  
REFER SERVICING TO QUALIFIED SERVICE  
PERSONNEL



The Lightning flash with the arrowhead symbol within an equilateral triangle is intended to alert the user to the presence of uninsulated **"DANGEROUS VOLTAGE"** within the product's enclosure that may be of sufficient magnitude to constitute a risk of electric shock to persons.



The Exclamation point within an equilateral triangle is intended to alert the user to the presence of important operating and maintenance (servicing instructions in the literature accompanying the product).

### Federal Communication Commission Information (FCC)

This Equipment has been tested and found to comply with the limits for a TV Broadcast Receiver, pursuant to Part 15 of the FCC Rules. These limits are designed to provide reasonable protection against harmful interference in a residential installation.

This equipment generates, uses and can radiate radio frequency energy and, if not installed and used in accordance with the instructions, may cause harmful interference to radio communications if this equipment does cause or receive interference, which can be determined by turning equipment off and on, the user is encouraged to try to correct the interference by one of the following measures:

- Reorient or relocate the TV antenna
- Increase the separation between TV and other equipment
- Connect TV into separate outlet from equipment
- Consult the dealer or an experienced radio/TV technician for help

FCC Caution: Any changes or modifications not expressly approved by the party responsible for compliance could void the user's authority to operate the equipment.

# AUDIOVOX<sup>®</sup>

## ELECTRONICS CORP.

### Overview



#### General Description

This Audiovox product is a Color Active Matrix Liquid Crystal Display with an integral Cold Cathode Fluorescent Lamp (CCFL) backlight system. The matrix employs a Thin Film Transistor as the active element. This TFT-LCD has a 30 inch diagonally measured active display area with WXGA resolution (768 vertical by 1280 horizontal pixel array). Each pixel is divided into Red, Green, and Blue sub-pixels which are arranged in vertical stripes. The color palette is capable of more than 16 million colors.

#### Important Information Regarding Use of Video Games, Computer, Captions or other Fixed Image Displays

The Extended use of a fixed image program material can cause permanent "Shadow Image" on the LCD Panel. The Background image is viewable on normal programs in the form of stationary fixed image. This type of irreversible LCD panel deterioration can be limited by observing the following steps:

Reduce the brightness/contrast setting to a minimum viewing level.

DO NOT display the fixed image for extended periods of time.

Turn the power off when not in actual use.

#### Recycling

This product utilizes tin-lead solder, and has a fluorescent lamp containing a small amount of mercury. Disposal of these materials may be regulated in your community due to environmental considerations. For disposal or recycling information please contact you local authorities, or the Electronics Industries Alliance:

# Important Safety Cautions

When any unusual situation occurs, turn off the power supply at once and remove the plug from the wall outlet. Contact a qualified service department in your local area.

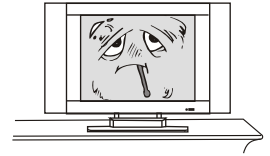

Do not expose this unit in the rain or spatter by liquid. Do not use this product near water - for example, near a bathtub, washbowl, kitchen sink, or laundry tub, in a wet basement, or near a swimming pool, and the like. Do not use immediately after moving from a low temperature to high temperature environment, as this causes condensation, which may result in fire, electric shock, or other hazards.



Heat sources-Keep the product away from heat sources such as radiators, heaters, stoves and other heat generating products (including amplifiers).

Requirement of environment temperature:

- 20°C~50°C for storage; 0°C~40°C for working

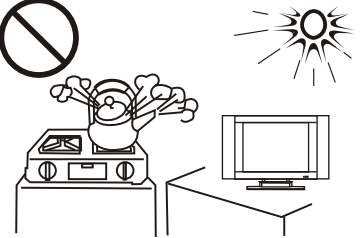

The vents and other openings in the cabinet are designed for ventilation. Do not cover or block these vents and openings since insufficient ventilation can cause overheating and/or shorten the life of the product.

Do not place the product on a bed, sofa, rug or other similar surface, since they can block ventilation openings.

This product is not designed for built-in installation; do not place the product in an enclosed place such as a bookcase or rack, unless proper ventilation is provided or the manufacturer's instructions are followed.

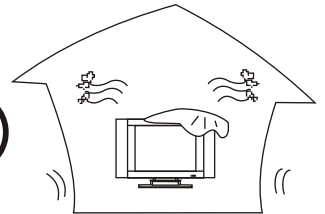

Unplug this product from the wall outlet before cleaning. Do not use liquid cleaners or aerosol cleaners. Use a damp cloth for cleaning.

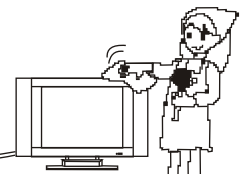

Do not place the product on an unstable trolley, stand, tripod or table. Placing the product on an unstable base can cause the product to fall, resulting in serious personal injuries as well as damage to the product. Use only a trolley, stand, tripod, and bracket or table recommended by the manufacturer or sold with the product.

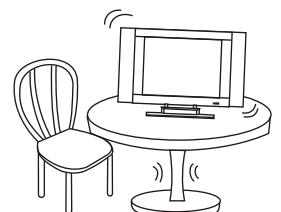

⚠ This TV set operates on power of 120V, 60Hz. You must not use a power supply of any other type.

When relocating the product placed on a trolley, it must be moved with the utmost care. Sudden stops, excessive force and uneven floor surfaces can cause the product to fall from the trolley.



The power cords must be routed properly to prevent people from stepping on them or objects from resting on them. Check the cords at the plugs and product. Power-supply cords should be routed so that they are not likely to be walked on or snagged by items placed upon or against them. Pay particular attention to cords at doors, plugs, receptacles, and the point where they exit from the product. If the power cord or the plug is damaged contact a qualified service department for service.



Do not overload wall outlets, extension cords, or convenience receptacles on other equipment as this can result in a risk of fire or electric shock.

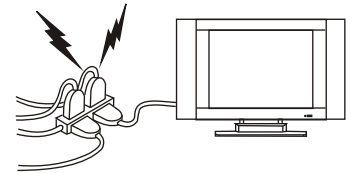

High Voltage exists in this TV set. Do not remove the cover. In case the product needs replacement parts, make sure that the service person uses replacement parts specified by the manufacturer, or those with the same characteristics and performance as the original parts. Use of unauthorized parts can result in fire, electric shock and/or other danger.



The LCD panel used in this product is made of glass. Therefore, it can break when the product is dropped or impacted upon by other objects. Be careful not to be injured by broken glass pieces in case the LCD panel breaks.

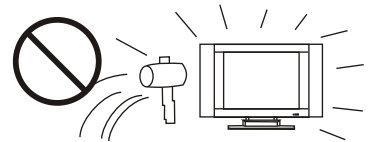

Don't try to push anything into the cabinet or place any vessel with water on the TV set.

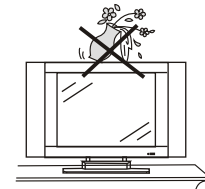

For added protection for this television equipment during a lightning storm, or when it is left unattended and unused for long periods of time, unplug it from the wall outlet and disconnect the antenna. This will prevent damage to the equipment due to lightning and power-line surges.

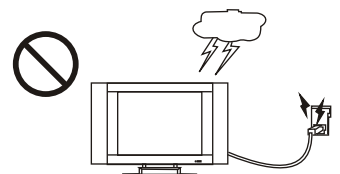

# AUDIOVOX® ELECTRONICS CORP.

## Accessories

Power Adaptor ○



Power Cord ○

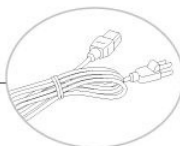

User's Manual ○



Batteries ○

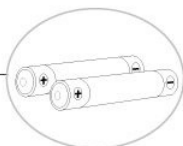

Remote Control



VGA Cable ○

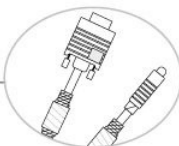

Wall Mount



# Identification of controls

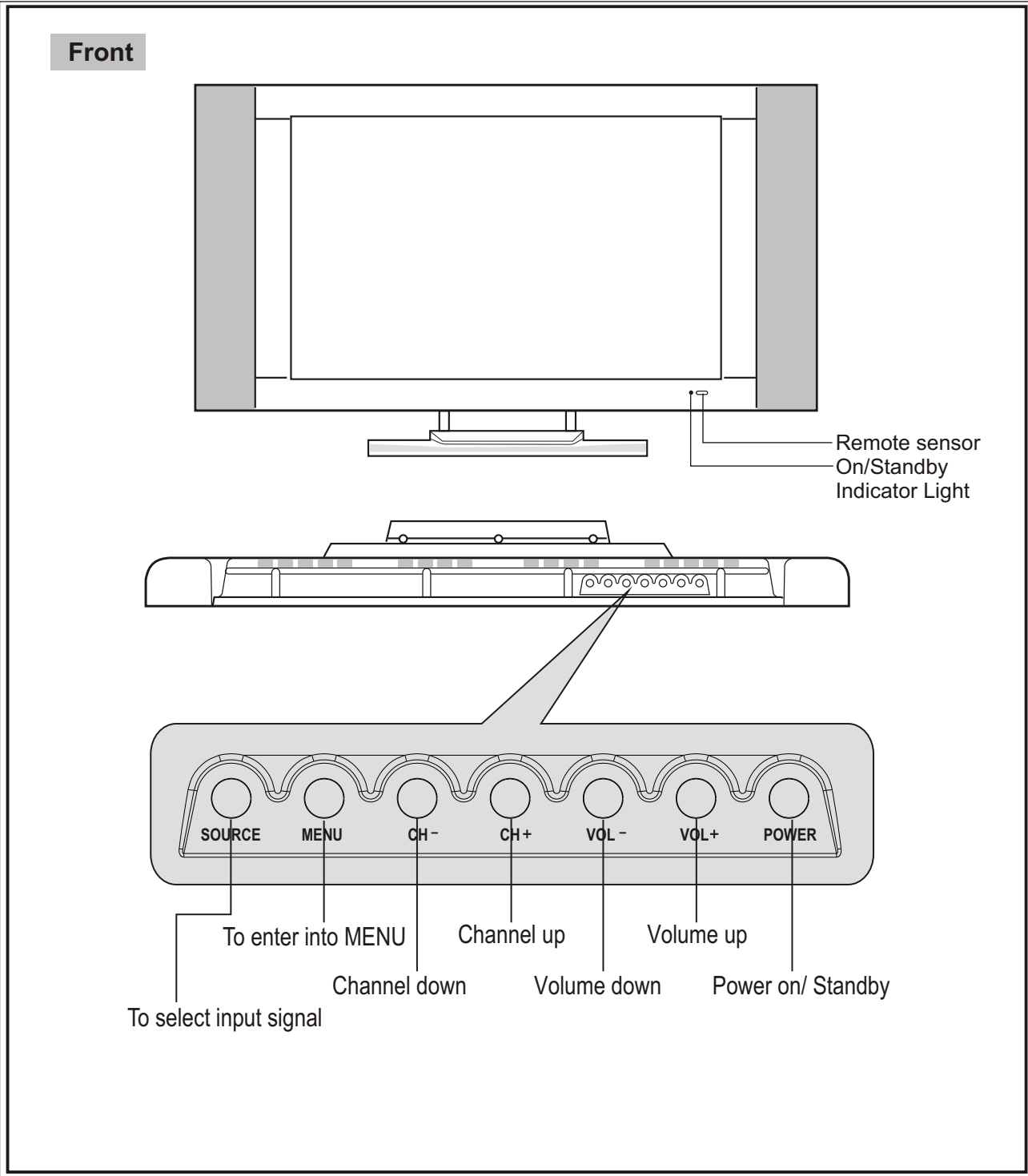



**Back**

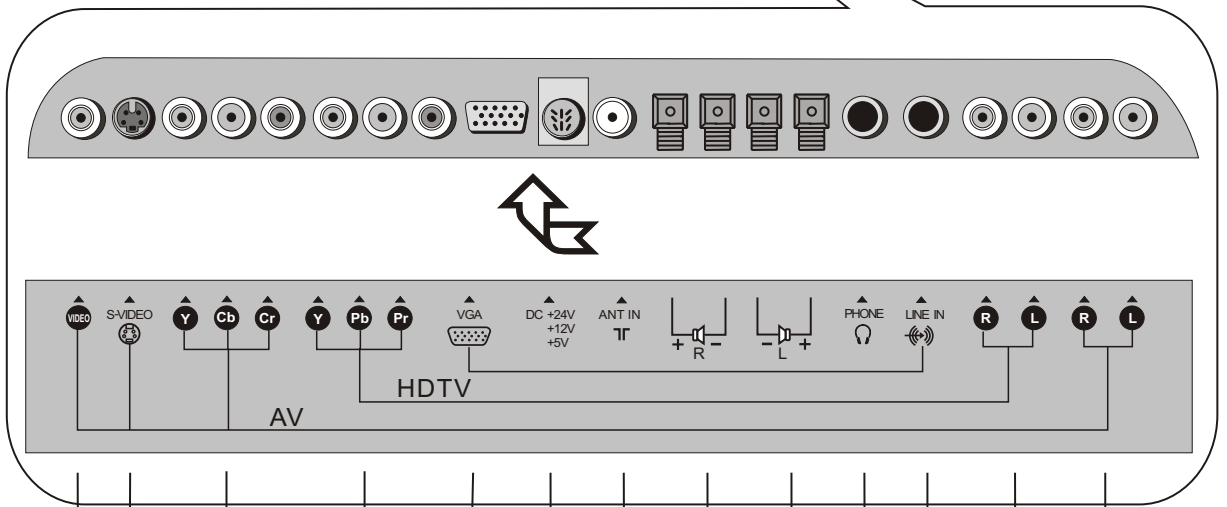
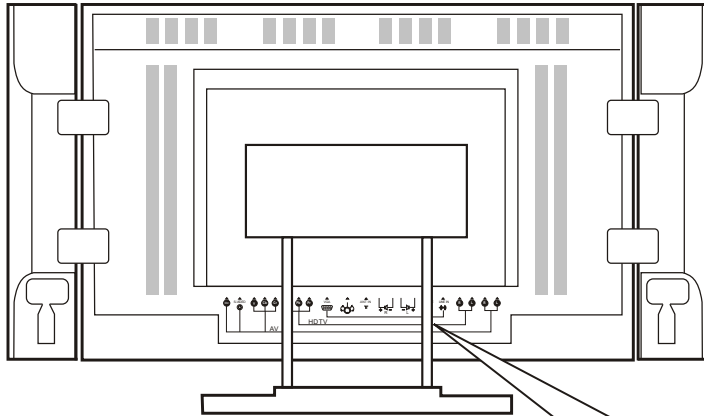

Video input

S-video input

DVD input (480i)

HDTV YPbPr inputs (480p, 720p, 1080i)

VGA input

DC input from power supply

Antenna input

Speaker outputs

Earphone jack

PC audio line in

HDTV Audio inputs

Audio inputs

# Identification of controls (continued)

## Remote Control

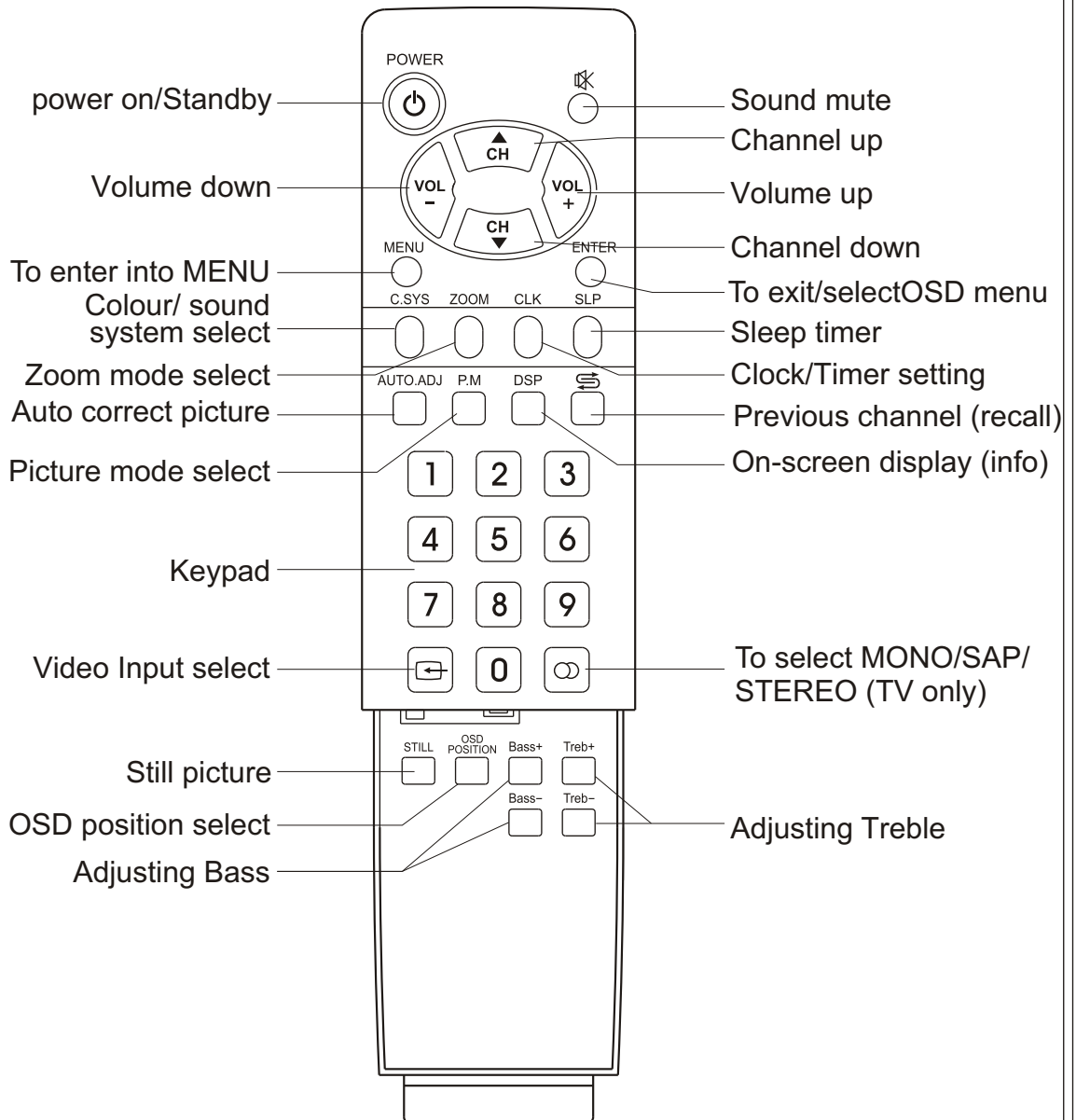

## Battery installation

Please install the batteries before using the remote control unit.

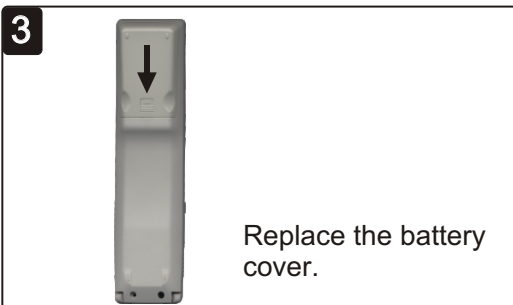
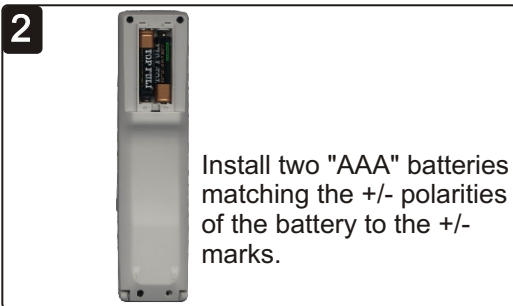
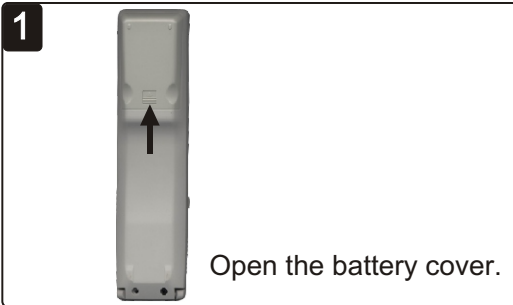

### ! Notes:

- When the remote control will not be used for a long period of time or when the batteries are worn out, remove the batteries.
- Do not throw the batteries into a fire. Dispose of used batteries in the specified manner.
- Do not drop, dampen or disassemble the remote control.

## Effective remote range

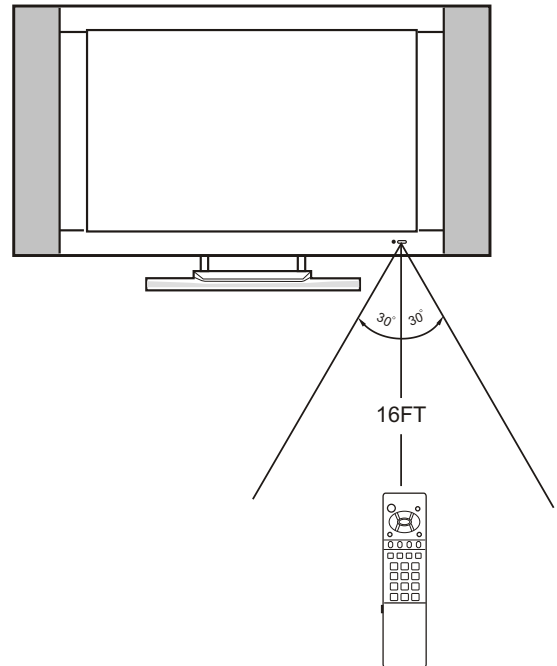

### ! Notes:

- There should be no obstacle between the TV and the transmitter.
- Use the remote control within the effective range as the above figure.
- If the remote control does not work, please check whether the batteries are exhausted or the polarity is wrong.
- When direct sunlight, and incandescent lamp, fluorescent lamp or any other strong light shines on the REMOTE SENSOR of the TV, the remote operation may be unstable.

# Antenna connection

## CABLE TV (CATV) CONNECTION

A 75-ohm coaxial cable connector is built into the set for easy hookup. When connecting the 75-ohm coaxial cable to the set, screw the 75-ohm cable to the ANT. Terminal.

Some cable TV companies offer "premium pay channels". Since the signals of these premium pay channels are scrambled, a cable TV converter/descrambler is generally provided to the subscriber by the cable TV company.

This converter/descrambler is necessary for normal viewing of the scrambled channels. For more specific instructions on installing cable TV, consult your cable TV company. One possible method of utilizing the converter/descrambler provided by your cable TV company is explained below. Please note: An RF switch provided with two inputs (A and B) is required (not supplied).

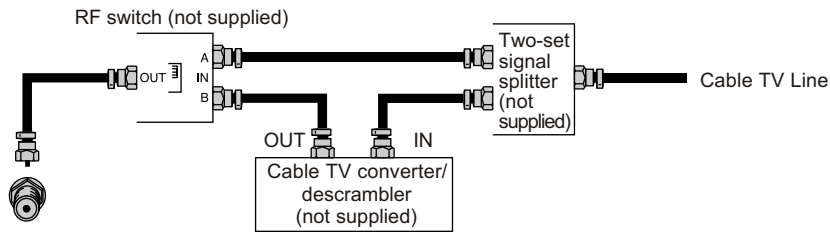

"A" position on the RF switch (not supplied) : You can view all unscrambled channels by using the TV's channel keys.

"B" position on the RF switch (not supplied) : You can view the scrambled channels via the converter/descrambler by using the converter's channel keys.

**Note:** Consult your Dealer or Service Center for the type of splitter, RF switch or combiner that might be required.

## ANTENNAS

The antenna requirements for good color television reception are more important than those for black & white television reception. For this reason, a good quality outdoor antenna is strongly recommended.

The following is a brief explanation of the type of connections that are provided with the various antenna systems.

1. A 75-ohm system is generally a round cable with F-type connector that can easily be attached to a terminal without tools (not supplied).
2. A 300-ohm system is a flat "twin-lead" cable that can be attached to a 75-ohm terminal through a 300-75-ohm adapter (not supplied).

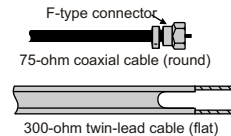

## OUTDOOR ANTENNA CONNECTION

Use one of the following two diagrams if you connect an outdoor antenna.

A: Using a VHF/UHF combination outdoor antenna.

B: Using separate VHF and/or UHF outdoor antennas.

Connect the outdoor antenna cable lead-in to the ANT. terminal on the rear of the TV set.

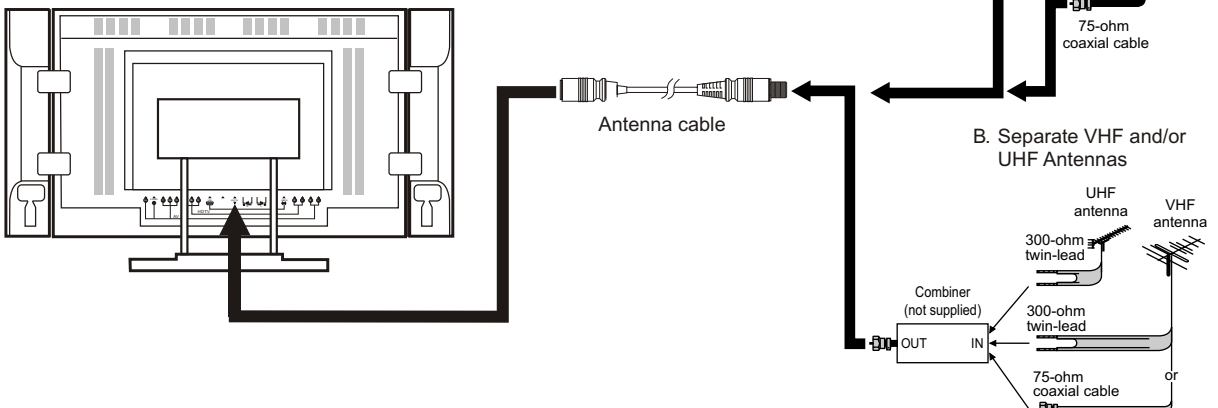

# Installation

## Power connection

Before using this equipment, please connect the AC power adapter correctly.

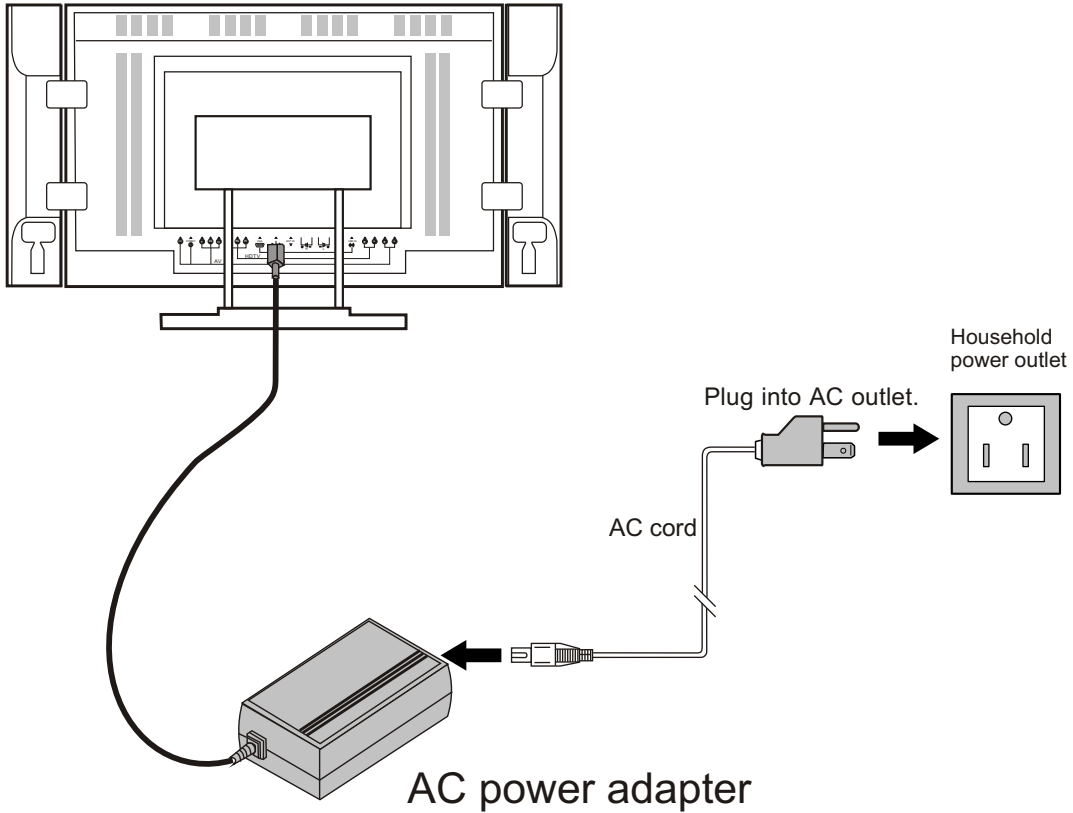

1. Connect the female plug to the AC socket on AC adapter.
2. Connect the AC adapter to the DC power input of the set.
3. Connect the male plug to the wall outlet as illustrated.

## ! Notes:

- ☐ This product should be operated only from the type of power source indicated on the marking label.
- ☐ Always unplug the AC adapter from the product and power outlet when not using for a long period of time.

# Installation (continued)

## Connecting video/audio equipment

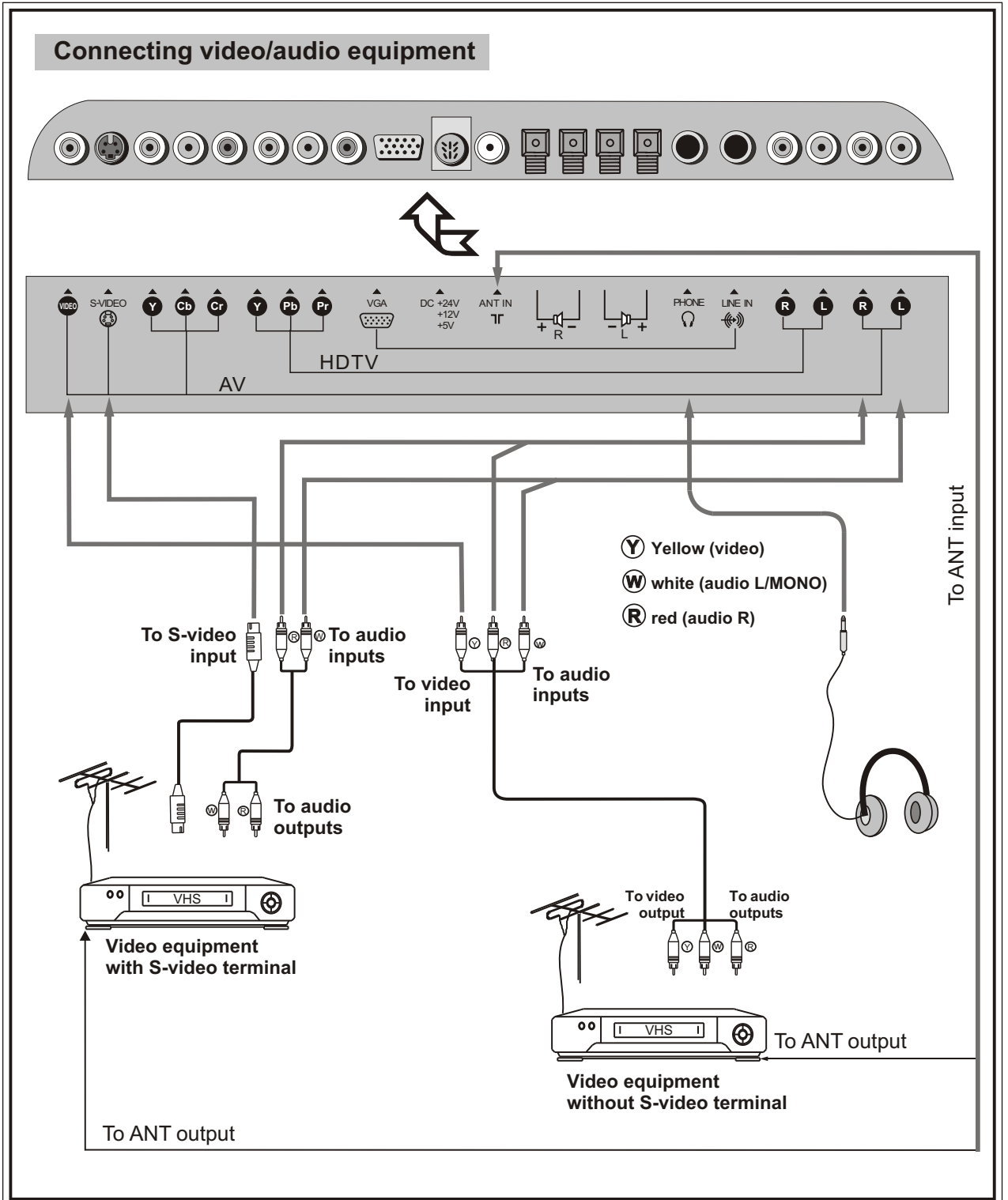

# Installation (continued)

## Connecting DVD player and speakers

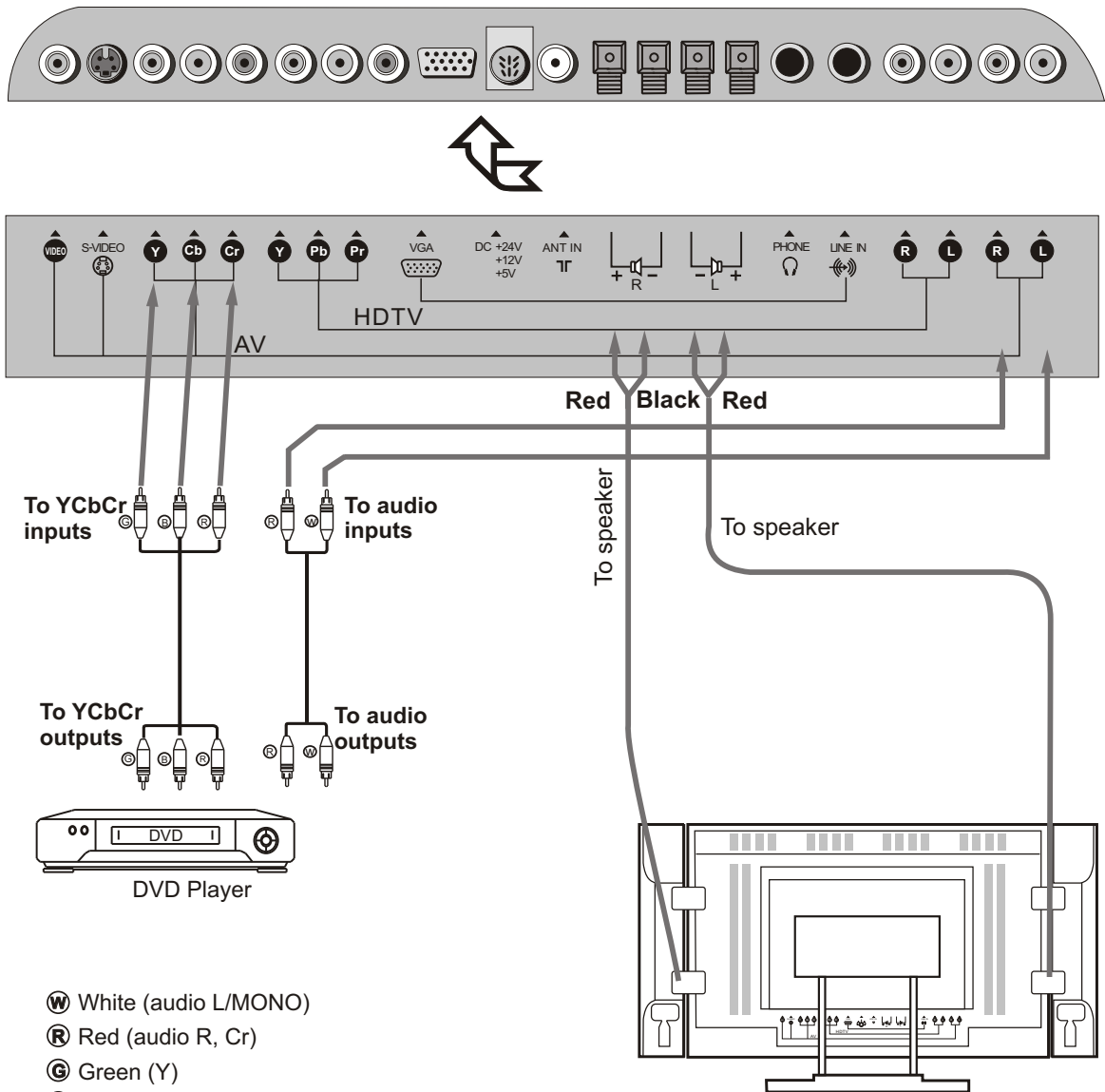

# Installation (continued)

## Connecting YPbPr terminals

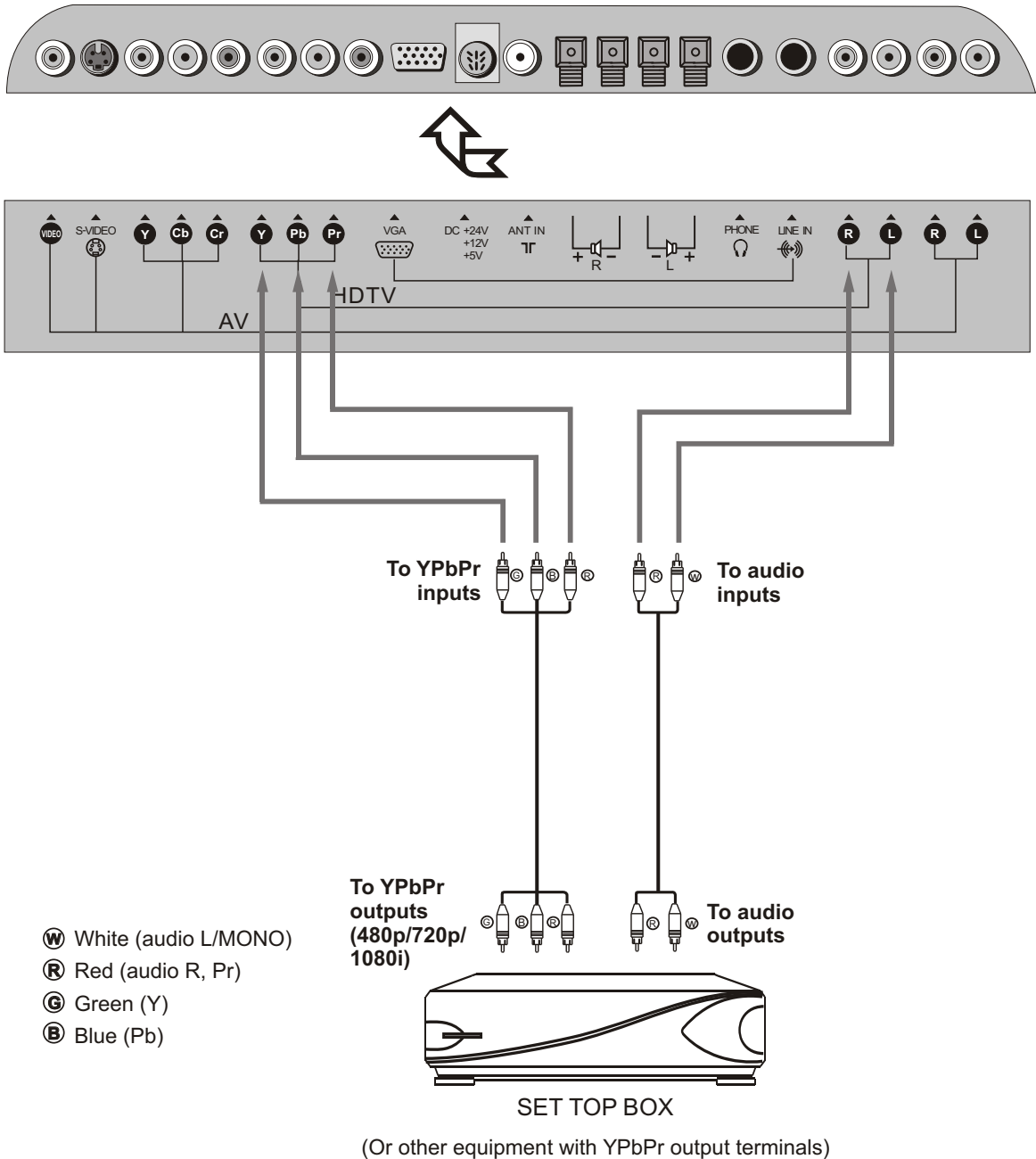



# Installation<sub>(continued)</sub>

## Connecting VGA interface

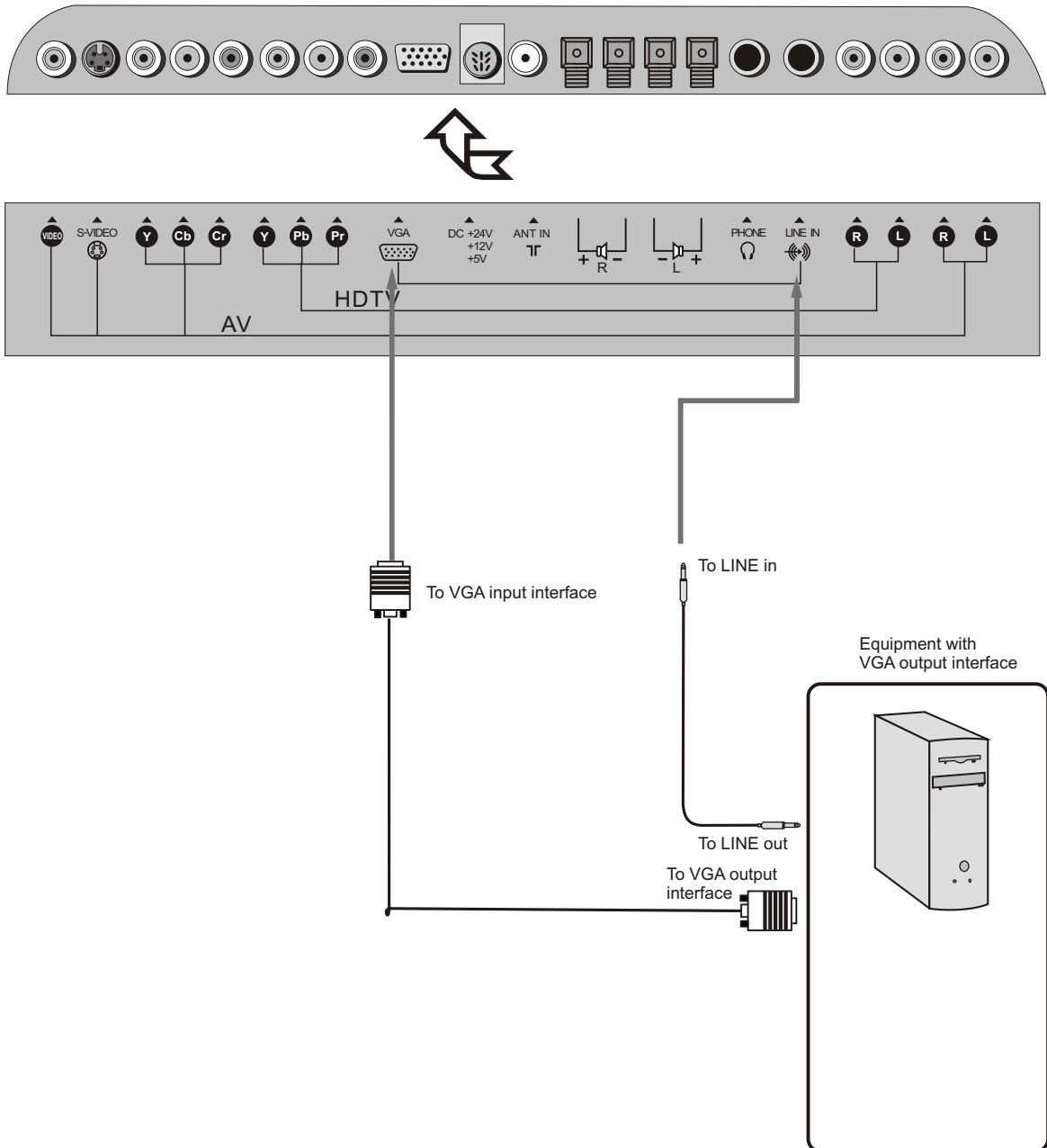

# Installation<sub>(continued)</sub>

## Elevation adjustment

You can adjust the angle of the LCD TV as follows.  
The elevation can be adjusted from  $-5^{\circ}$  to  $+10^{\circ}$ .

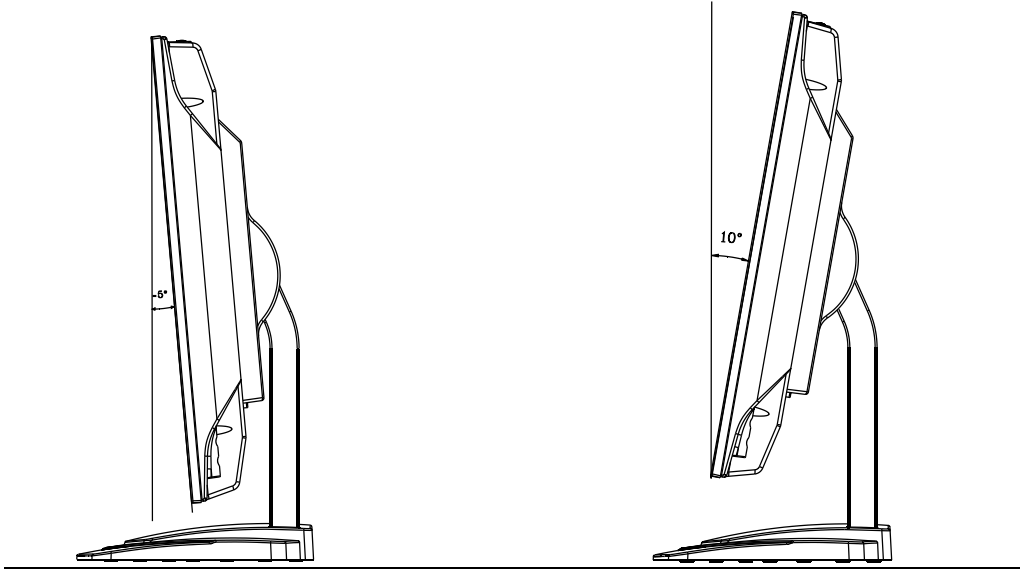

# Menu Introduction

Press **MENU** button to call up menu, press **MENU** button repeatedly to select different menu pages. In **MENU** operations, the **CH ▲/▼** buttons are used to select item upwards or downwards; the **VOL+/-** buttons are used to

## Menu overview in TV mode

### PICTURE setting menu

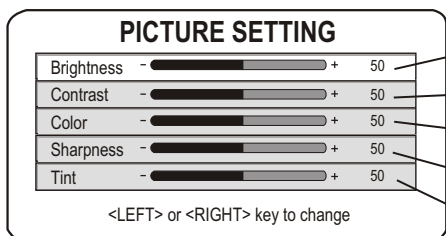

- To adjust the picture's brightness.
- To adjust the picture's contrast.
- To adjust the picture's color saturation.
- To adjust the picture's sharpness.
- To adjust the picture's skin color.

### SOUND menu

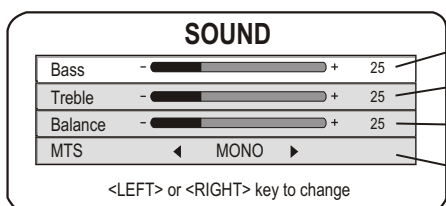

- To adjust the Bass.
- To adjust the Treble.
- To adjust the Balance.
- To select STEREO, SAP or MONO (TV mode only).

### SETUP menu

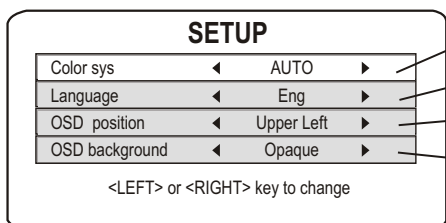

- To select color system. (It is unaccessible in TV mode)
- To select OSD menu language.
- To select OSD menu position.
- To set OSD background texture.

### CHANNEL SETTING menu

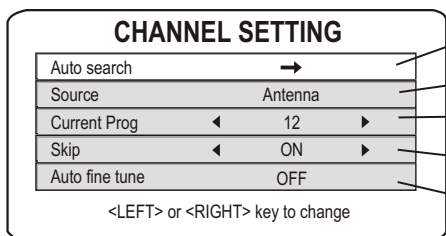

- To start auto search of valid channels.
- To select antenna input or cable input
- To display current channel number.
- To add or skip current channel.
- To turn on or turn off auto fine tune.

# Menu Introduction (continued)

## CCD and Vchip settings menu (in TV mode)

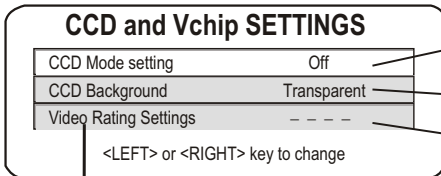

Press to switch between Caption, text and TV modes for Closed-Captioned programs.

To select background for CCD display.

Input a password to enter into Vchip menu.

Input the password

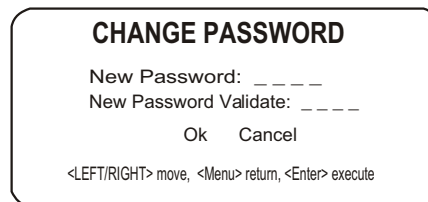
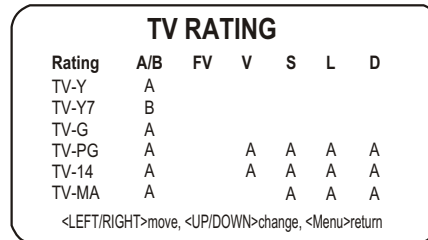
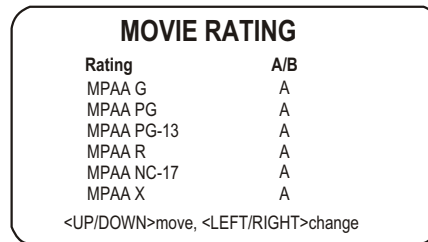
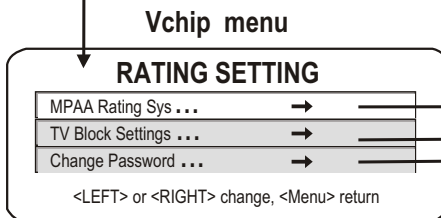

# Turning On/Off / Selecting input signal

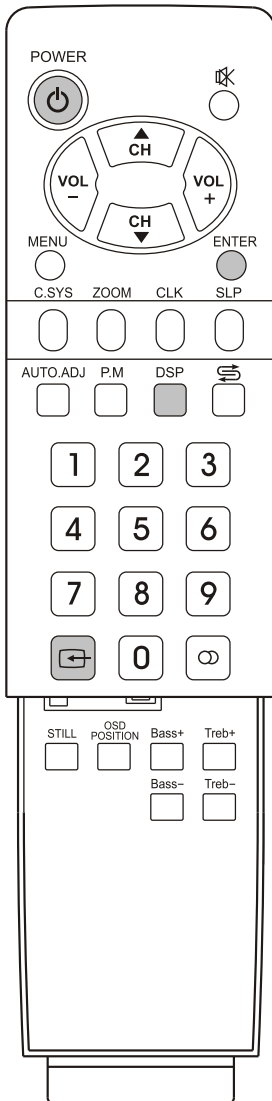
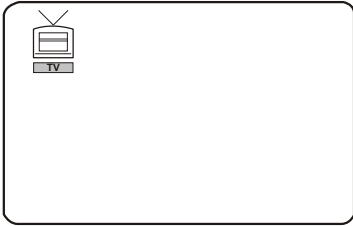

## Turning On

1. Connect the power, the red indicator lights up, the set is in STANDBY mode.
2. Press the **POWER** button on the unit's control panel or the button on the remote control to turn the set on.

## Turning Off

With the power on, press the **POWER** button to turn off the set, and the set is in standby mode.

\* Always unplug the AC adapter from the product and power outlet when not using for a long period of time.

## ! Notes:

This TV set can automatically turn off by:

1. When there is no TV signal input for about 15 minutes;
2. Sleep timer.

## Selecting input signal

1. Press the button on the remote control or **SOURCE** button on the set's panel to select input mode. You can select **TV, AV, S-video, YCbCr, YPbPr** or **PC**.
2. If you want to go to TV mode, press button repeatedly to select TV mode.
3. Press **DSP** button, the screen display current mode. Press **ENTER** to cancel OSD.

# Operations in TV mode

## Channel Preset

CHANNEL SETTING	
Auto search	→
Source	Antenna
Current Prog	◀ 12 ▶
Skip	◀ ON ▶
Auto fine tune	OFF

<LEFT> or <RIGHT> key to change

### To enter into CHANNEL SETTING menu

1. Press **MENU** button repeatedly to display **CHANNEL SETTING** menu.
2. Press **CH▲** or **CH▼** button to select item.
3. Press **VOL+** or **VOL-** button to confirm or adjust selected item.

### Antenna / Cable selection

Enter into **CHANNEL SETTING** menu and select **Source** item.  
Press **VOL-** or **VOL+** button to select **Antenna** or **Cable**.

Antenna: If using a VHF/UHF antenna (2-68).  
Cable: If using Cable TV (2-125).

CHANNEL SETTING	
Auto search	→
Source	Antenna
Current Prog	◀ 12 ▶
Skip	◀ ON ▶
Auto fine tune	OFF

<LEFT> or <RIGHT> key to change

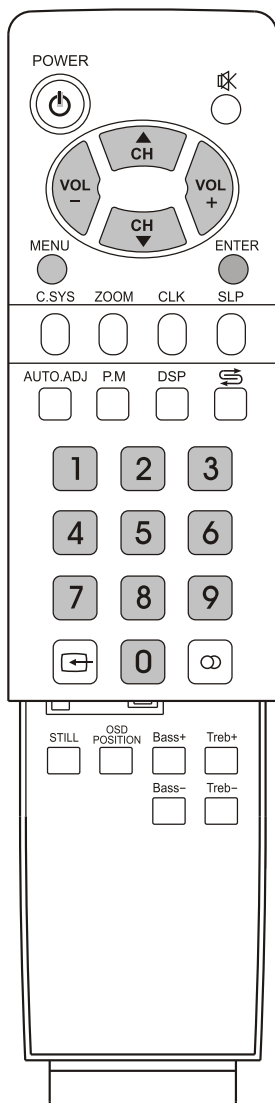

\* To exit the menu, press ENTER button.

### Auto Search

Please enter into **CHANNEL SETTING** menu and select **Auto Search** item.

Press **VOL-** or **VOL+** button to start Auto Search and all active programs will be memorized.

During the process of Auto Search, pressing **MENU** button will stop Auto Search.

Antenna Auto searching	▬
	28 VHFL
Press <Menu> to escape	

### Adding and skipping channels

After auto search, you can add or skip channels as follows:  
Select a channel to be added or skipped by direct channel select buttons.

Enter into **CHANNEL SETTING** menu and select **Skip** item.

Press **VOL-** or **VOL+** button to select **On** or **Off**.

**Skip On:** To skip the current channel.

**Skip Off:** To add the current channel.

CHANNEL SETTING	
Auto search	→
Source	Antenna
Current Prog	◀ 12 ▶
Skip	◀ ON ▶
Auto fine tune	OFF

<LEFT> or <RIGHT> key to change

### Fine tuning

In area of inferior broadcast conditions where adjustment is necessary for a better picture and sound, use Fine tuning.

Use **0~9** digit buttons or **CH▲/▼** buttons to select the desired channel, then enter into **CHANNEL SETTING** menu and select **Auto fine tune** item. Press **VOL+** button to select **ON** to activate the auto fine tune.

CHANNEL SETTING	
Auto search	→
Source	Antenna
Current Prog	◀ 12 ▶
Skip	◀ ON ▶
Auto fine tune	OFF

<LEFT> or <RIGHT> key to change

# Channel Select

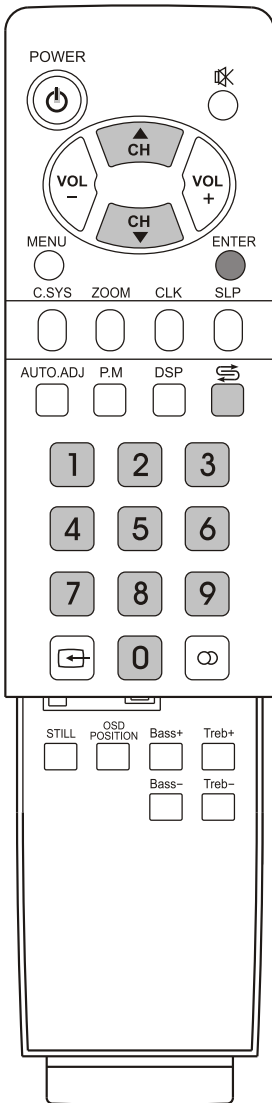
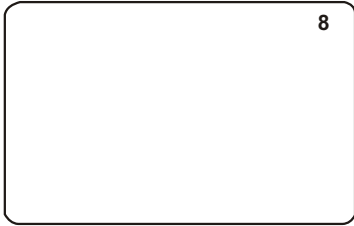

## Use 0-9 digit buttons

- ◆ Use **0-9** digit buttons to select one-digit channel number.

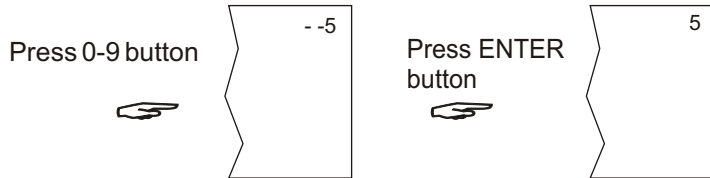

- ◆ To select two-digit channel:

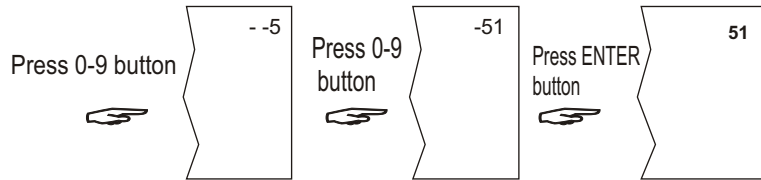

- ◆ To select three-digit channel:

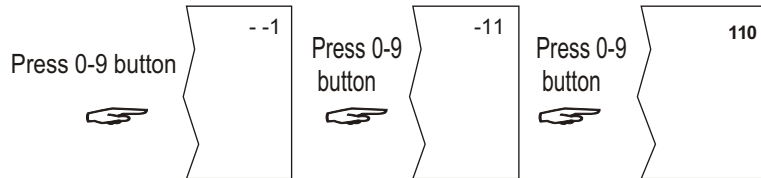

**Note:** the period of two-press should be within 3 seconds.

## Use CH ▲ / ▼ button

Press **CH ▲** button, the channel number increases;  
Press **CH ▼** button, the channel number decreases.

## Use previous channel ↻ button

Press this button to switch between the current channel and previous channel.

# Picture adjustment

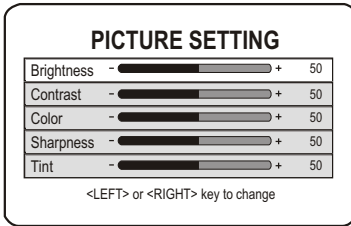

## Adjusting picture

1. Press **MENU** button to display **PICTURE SETTING** menu.
2. Press **CH** ▲ / ▼ button to select item.

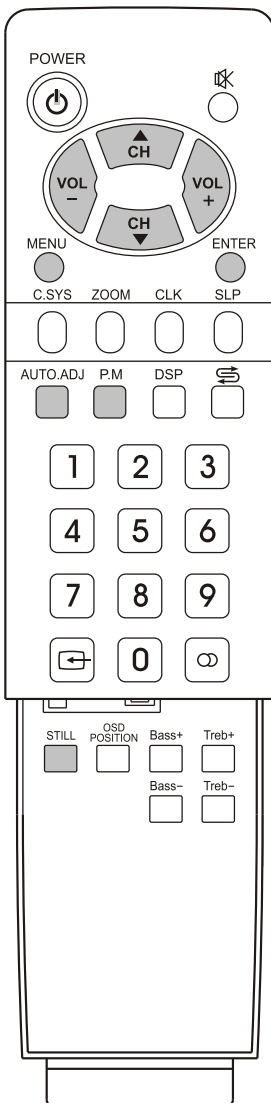

Item	VOL-	VOL+
Brightness	darker	lighter
Contrast	weaker	stronger
Color	paler	deeper
Sharpness	softer	sharper
Tint	purplish	greenish

The adjusted settings are stored in the **User mode**.

There are three preset picture modes and one User-set picture mode. Press the **P.M** button to select a picture mode according to your favorites.

4. Press **P.M** button to select picture mode.

You can quickly select picture mode by **P.M** button. There are four picture mode: **Bright**, **Standard**, **Mild** and **User mode**.

**Bright:** Select for a bright picture.

**Standard:** Select for a normal picture.

**Mild:** Select for a fine/soft picture.

Adjusted settings are stored in **User mode**.

## Using STILL button

You can still current screen picture by pressing **STILL** button on the remote.

## Using AUTO.ADJ button

Press **AUTO.ADJ** button on the remote to adjust picture for best viewing.

\* To exit the menu, press **ENTER** button.



# Sound adjustment

## Adjusting Sound

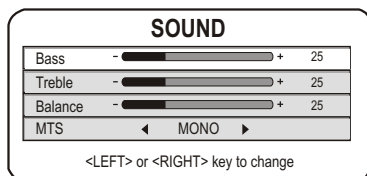

1. Press **MENU** button repeatedly to display **SOUND** menu.
2. Press **CH ▲ / ▼** button to select item.

Item	VOL-	VOL+
Bass	weaker	stronger
Treble	weaker	stronger
Balance	decreases the right channel	decreases the left channel
MTS	MONO/SAP/STEREO	

### ! Notes:

You can quickly adjust Bass and Treble by using **Bass+ / Bass-** and **Treb+ / Treb-** buttons on the remote.

You can quickly select audio mode by **MTS** button.

MONO ↔ STEREO (If the program is **STEREO**)

MONO ↔ SAP (If the program is **SAP**)

MONO → STEREO → SAP (If the program is **STEREO & SAP**)

## Adjusting Volume

You can use **VOL+** or **VOL-** button to adjust volume.

Press **VOL+** button, the volume increase;

## Muting the sound

If you want to mute the sound, press button on the remote.

To resume the sound, press this button again or you can also press **VOL+** or **VOL-** to resume the sound.

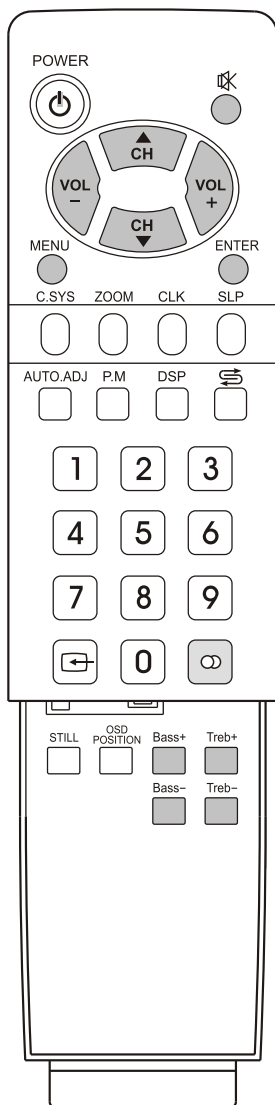

\* To exit the menu, press ENTER button.

# System setup

SETUP		
Color sys	◀ AUTO ▶	
Language	◀ Eng ▶	
OSD position	◀ Upper Left ▶	
OSD background	◀ Opaque ▶	

<LEFT> or <RIGHT> key to change

## To enter into SETUP menu

1. Press **MENU** button repeatedly to display **SETUP** menu.
2. Press **CH▲** or **CH▼** button to select item.
3. Press **VOL+** or **VOL-** button to confirm or adjust selected item.

## Color system

In AV mode, you can select color system. From the **SETUP** menu, press **CH▲/▼** to select **Color sys** item. Press **VOL-** or **VOL+** button to select a proper color system according to the program type. Normally, select **AUTO**.

SETUP		
Color sys	◀ AUTO ▶	
Language	◀ Eng ▶	
OSD position	◀ Upper Left ▶	
OSD background	◀ Opaque ▶	

<LEFT> or <RIGHT> key to change

You can quickly access Color system menu bar by **C.SYS**

\*This is an advanced setting and should not be touched.

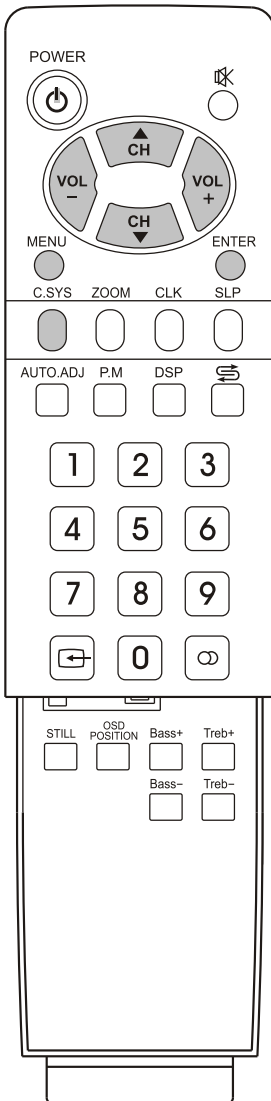

## Setting OSD Language

From the **SETUP** menu, press **CH▲/▼** to select **Language** item. Press **VOL-** or **VOL+** button to select the desired language.

SETUP		
Color sys	◀ AUTO ▶	
Language	◀ Eng ▶	
OSD position	◀ Upper Left ▶	
OSD background	◀ Opaque ▶	

<LEFT> or <RIGHT> key to change

\* To exit the menu, press **ENTER** button.

# System setup<sub>(continued)</sub>

SETUP		
Color sys	◀ AUTO ▶	
Language	◀ Eng ▶	
OSD position	◀ Upper Left ▶	
OSD background	◀ Opaque ▶	

<LEFT> or <RIGHT> key to change

## Setting OSD position

From the **SETUP** menu, press **CH ▲ / ▼** to select **OSD position** item. Press **VOL-** or **VOL+** button to select an **OSD position** in your preference.

### ! Notes:

You can quickly select OSD menu position by using **OSD POSITION** button on the remote.

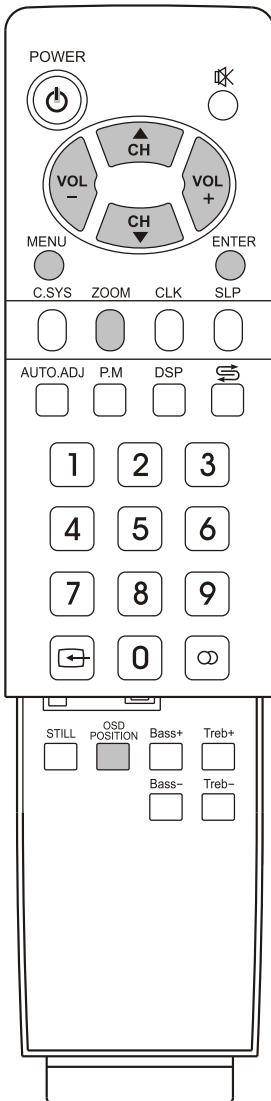

## Setting OSD Background

From the **SETUP** menu, press **CH ▲ / ▼** to select **OSD Background** item. Press **VOL-** or **VOL+** button to select **Opaque** or **Translucent**.

SETUP		
Color sys	◀ AUTO ▶	
Language	◀ Eng ▶	
OSD position	◀ Upper Left ▶	
OSD background	◀ Opaque ▶	

<LEFT> or <RIGHT> key to change

## Setting Scaler mode

This unit allows you to adjust screen aspect ratio in your preference. Press **ZOOM** button on the remote to select a proper screen aspect ratio. **Anamorphic**, **4:3** and **Panorama** can be selected.

Anamorphic

### ! Notes:

You can quickly select screen ratio by using **ZOOM** button on the Remote Control

\* To exit the menu, press **ENTER** button.

# Timer setting

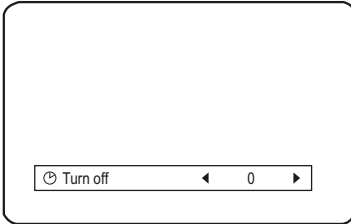

## Use SLP button

Press **SLP** button repeatedly to set sleep time between: 0, 10, 20, 30, 60, 90, 120, 180, 240 minutes. If you select 0 minute, it means the sleep timer function is turned off.

## Use CLK button

Press **CLK** button, the **Current time** menu bar appears. Use **CH ▲/▼** to select hour or minute (the selected item is displayed in white), use **VOL+/-** to set the current time.

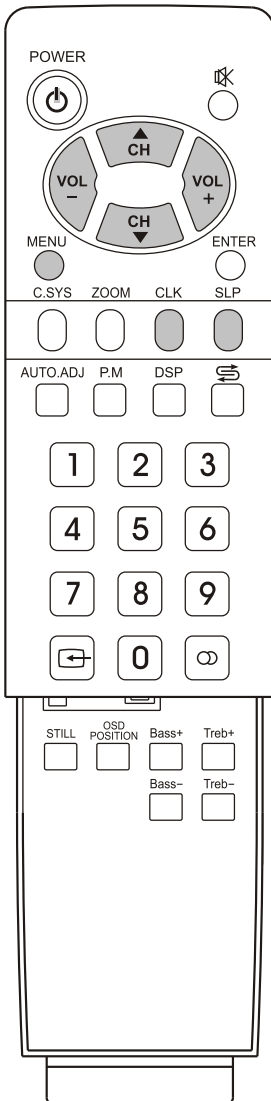
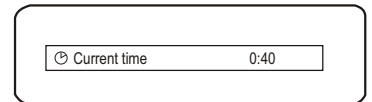

# CCD setting

CCD and Vchip SETTINGS	
CCD Mode setting	Off
CCD Background	Transparent
Video Rating Settings	-----

<LEFT> or <RIGHT> key to change

## To enter into CCD and Vchip SETTINGS menu

1. Press **MENU** button repeatedly to display **CCD and Vchip SETTINGS** menu.
2. Press **CH▲** or **CH▼** button to select item.
3. Press **VOL+** or **VOL-** button to confirm or adjust selected item.

## Closed captions

From the **CCD and Vchip SETTINGS** menu, press **CH▲/▼** to select **CCD Mode setting** item. Press **VOL-** or **VOL+** button to cycle between Captions 1, Captions 2, Text 1, Text 2, XDS (extended data services), Captions 3, Captions 4, Text 3, Text 4 and normal TV. Closed Captioning will display text on the screen for the hearing impaired.

CCD and Vchip SETTINGS	
CCD Mode setting	Off
CCD Background	Transparent
Video Rating Settings	-----

<LEFT> or <RIGHT> key to change

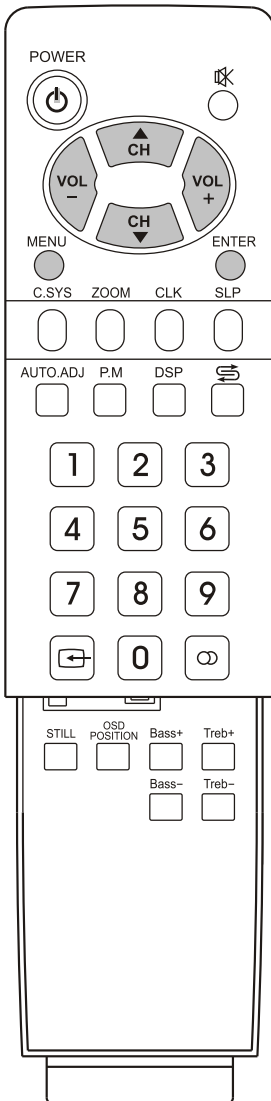

## CCD background

You can select background for CCD display.

From the **CCD and Vchip SETTINGS** menu, press **CH▲/▼** to select **CCD Background** item. Press **VOL-** or **VOL+** button to select **transparent** or **black**.

CCD and Vchip SETTINGS	
CCD Mode setting	Off
CCD Background	Transparent
Video Rating Settings	-----

<LEFT> or <RIGHT> key to change

\* To exit the menu, press **ENTER** button.

# V-chip setting

V-Chip enables parents to prevent their children from watching inappropriate material on TV. V-Chip reads the ratings for programming (except for news, sports, unedited movies on premium cable and Emergency System signals), then denies access to programming if the program's rating meets the limitations you select. In this case, the program will be blocked.

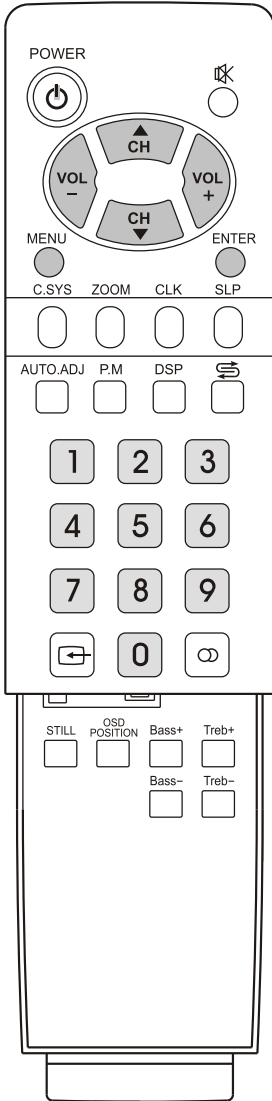

## To enter into RATING SETTING menu

1. Press **MENU** button repeatedly to display **CCD and Vchip SETTINGS** menu.
2. Press **CH▲** or **CH▼** button to select **Video Rating Settings**.
3. Input a 4-digit password to enter **RATING SETTING** menu (the preset password is 1234 and you should change it).

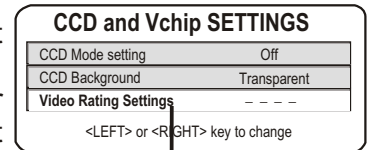

Input the password to enter

## MOVIE RATING setup

1. Enter into **RATING SETTING** menu.
2. Press **CH▲** or **CH▼** button to select **MPAARating Sys ....**
3. Press **VOL +** or **VOL-** button to enter into **MOVIE RATING** sub-menu.
4. Press **CH▲** or **CH▼** button to select the desired rating.
5. Press **VOL +** or **VOL-** button to either block the rating ("B" will appear) or unblock ("A" will appear).

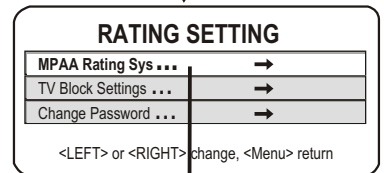

Press VOL +/- to enter

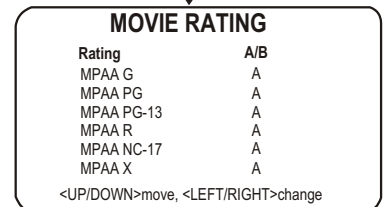

### Movie Ratings:

- \* G and Above (general audience)
- \* PG and Above (parental guidance suggested)
- \* PG-13 and Above (13 years and up)
- \* R and Above (restricted)
- \* NC-17 and Above (18 years and up)
- \* X (adult)

If you set PG-13, G and PG movies will be available, and PG-13, R, NC-17 and X will be blocked.

\* To exit the menu, press **ENTER** button.

# V-chip setting

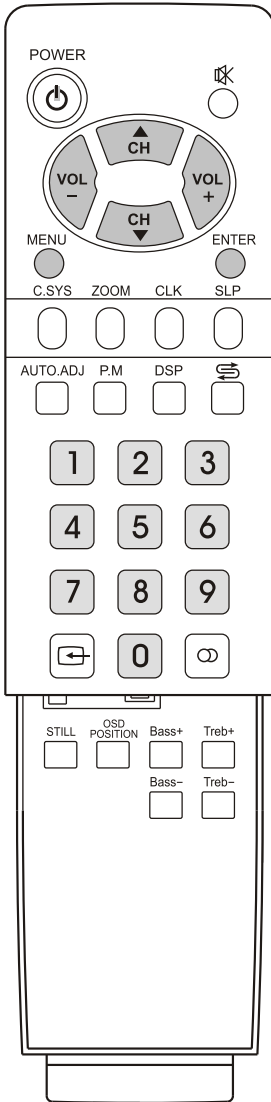

\* To exit the menu, press ENTER button.

## TV RATING setup

TV Parental Guidelines may have one or more letters added to the basic rating to let parents know when a show contains higher levels of violence, sex, adult

1. Enter into **RATING SETTING** menu.
2. Press **CH▲** or **CH▼** button to select **TV Block Settings** item.
3. Press **VOL +** or **VOL-** button to enter into **TV RATING** sub-menu.
4. Press **VOL+** or **VOL-** button to select the desired rating.
5. Press **CH▲** or **CH▼** button to either block the rating ("B" will appear) or unblock ("A" will appear).

- \* Y and Above (all children) (individual content categories do not apply)
- \* Y7 (7 years and up)
- \* G and above (general audience) (individual categories do not apply)
- \* PG and Above (parental guidance suggested)
- \* 14 and above (14 years and up)

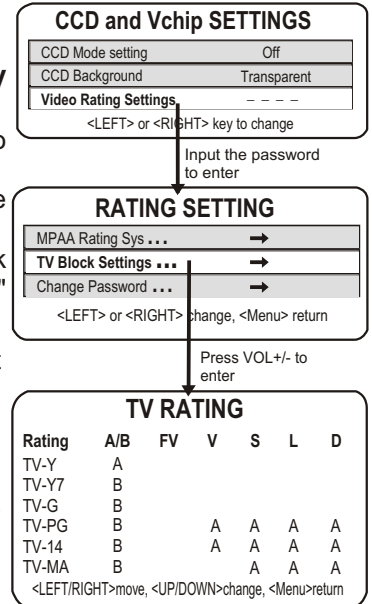

You can also block the criteria for each level for FV, V, S, L, D.

- \* FV: fantasy violence (applies only to TV-Y7)
- \* V: violence (applies to TV-PG and above, TV-14 and Above, TV-MA)
- \* S: sexual situations (applies to TV-PG and above, TV-14 and Above, TV-MA)
- \* L: adult language (applies to TV-PG and above, TV-14 and Above, TV-MA)
- \* D: sexual dialogue (applies to TV-PG and Above, TV-14)

## Changing the password

1. Enter into **RATING SETTING** menu.
2. Press **CH▲** or **CH▼** button to select **Change Password** item.
3. Press **VOL +** or **VOL-** button to enter into the sub-menu.
4. Enter a new 4-digit password and validate again. Then highlight **OK** and press **ENTER**. The password has been modified successfully.

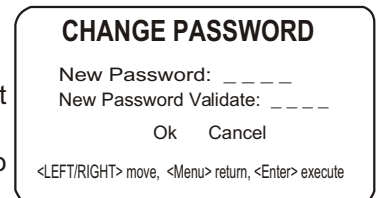

If you have failure in inputting the password, you can move the cursor to highlight Cancel and press ENTER button to cancel it.

# Adjustment in YPbPr mode



## To enter into YPbPr mode

Repeatedly press  button on the remote control or **SOURCE** button on the set's panel until the screen display YPbPr, which indicates that the set is in YPbPr mode. Connect the YPbPr terminals to Set Top Box and make sure there is signal input.

## Adjusting picture

In YPbPr mode when there is correct input signal, press **MENU** button and **PICTURE SETTING** menu appears. Use **CH ▲/▼** to select item and **VOL+/-** to adjust.

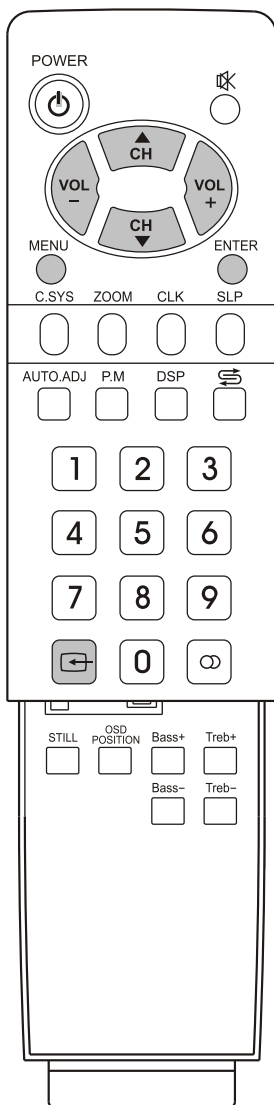

Item	VOL-	VOL+
Brightness	darker	lighter
Contrast	weaker	stronger
Saturation	paler	deeper
Sharpness	softer	sharper

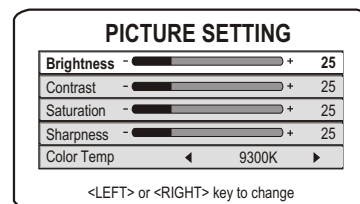

## Adjusting Color temperature

You can select different Color temperature to obtain correct white. Press **MENU** button, use **CH ▲/▼** to select **Color Temp** item, press the **VOL+/-** to select between

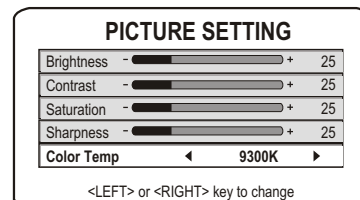

## Adjusting horizontal / vertical position

Press **MENU** button twice and the **PICTURE POSITION** menu appears. Use **CH ▲/▼** to select item and **VOL+/-** to adjust.

When nonstandard signal input to the set and the picture may not be in the screen center. Now you can adjust its **horizontal** and **vertical** position to display correctly.

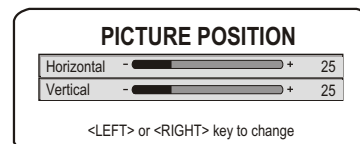

\* To exit the menu, press ENTER button.



# Adjustment in PC mode

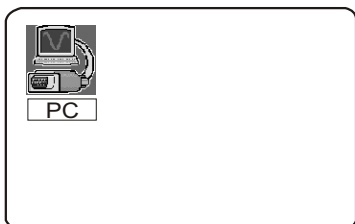

## To enter into PC mode

Repeatedly press  button on the remote control or **SOURCE** button on the set's panel until the screen display **PC**, which indicates that the set is in **PC** mode.

## PC signal format

Please connect VGA input and be sure that there is VGA input signal. The signal format should be one of the follows:

640X480 @60Hz  
800X600 @60Hz  
1024X768 @60Hz  
1280X768@60Hz

We recommend you to use 1024X768 @60Hz (4:3) or 1280X768@60Hz (16:9) so that the set can obtain the best picture.

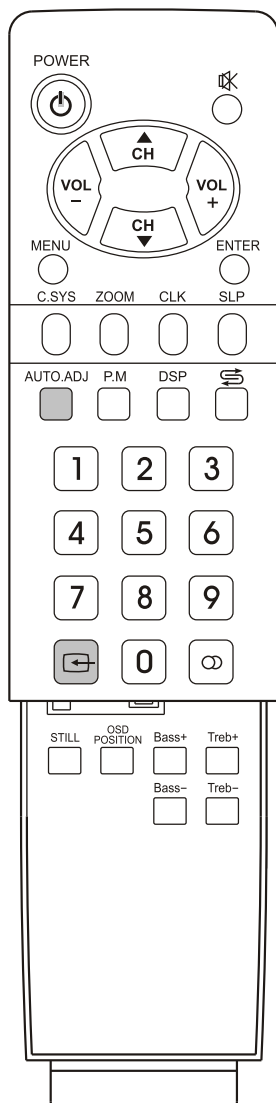

## Use AUTO. ADJ button

When PC signal format changes or when you switch to PC mode by  button, the set corrects picture automatically including frequency and phase to obtain the best display. During the process of auto correction, all buttons on the remote control and set's panel do not work until this process is finished.

When the set displays some signal formats that are nonstandard and can not adjust by itself to the best displaying status, now you can press **AUTO.ADJ** button to correct the displaying again.

# Adjustment in PC mode (continued)

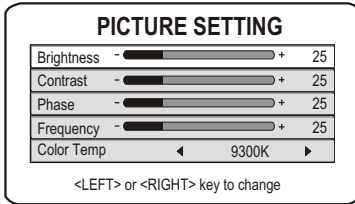

When there is correct input signal, press **MENU** button and **PICTURE SETTING** menu appears. Use **CH ▲/▼** to select item and **VOL+/-** to adjust.

## Adjusting brightness and contrast

You can adjust brightness and contrast in PC mode and this adjustment does not affect the **brightness** and **contrast** in TV and AV mode.

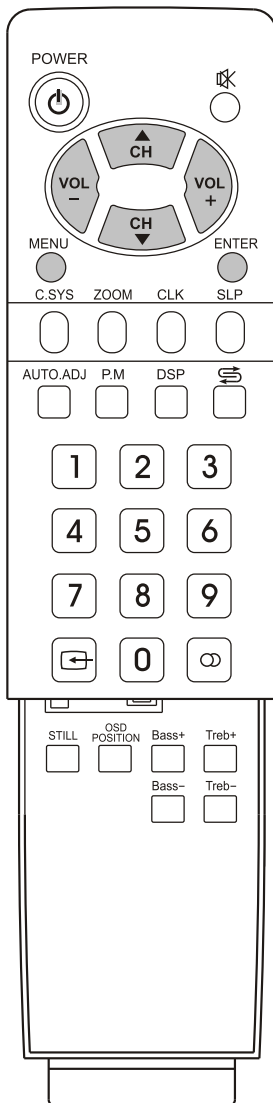

## Adjusting phase and frequency

If you can not obtain the best display after auto correction for many times. Now you can adjust **phase** and **frequency** to obtain the best display.

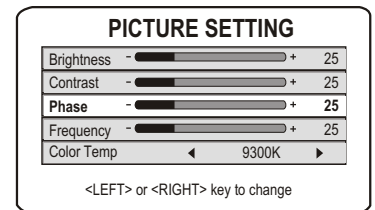

## Adjusting Color temperature

You can select different Color temperature to obtain correct white. Press **MENU** button, use **CH ▲/▼** to select **Color Temp** item, press the **VOL+/-** to select between

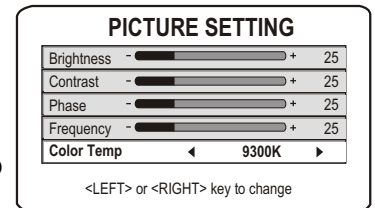

\* To exit the menu, press ENTER button.

# AUDIOVOX® ELECTRONICS CORP.

## Troubleshooting

### Interference

Please note the following common TV reception interferences:



#### Ignition effect

Black spots or vertical lines may appear. Screen jumps crazily or is very unstable. This is commonly the result of car ignition system interference, neon lights, or other forms of electrical interferences.



#### Ghost Shadows

This is the result of two signals : One being the original signal from the antenna while the 2nd signal is a slightly delayed signal, normally the result of bouncing off tall buildings or other obstructions. This problem might be corrected by adjusting your outdoor antenna.



#### Flurries

Lots of tiny dots appears on your screen. This is the result of poor reception signals. You may have to re-enforce your antenna signals.

★note: note: If interferences occur while you are using a cable system, then the problem could be at the cable source and not from your TV reception.

### Troubleshooting

You may have problems that can be fixed with a few minor adjustments. Look for the type of problem you are having below and then apply the suggestions to get your TV going again.



#### Picture with no sound

- Check if you have accidentally pressed the "mute" button
- Check other channels if the same problem exist. If other channels are fine, then problem is with the TV program you are viewing. This shouldn't be a concern
- Verify all connections are firmly attached
- Connect cable to another TV
- If all checks fail, please contact our serviceman

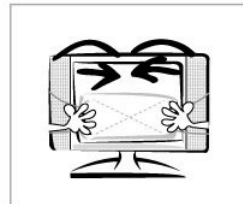

#### Sound with no picture

- Check if main power is switched on
- Check brightness and contrast level to see if they have been tuned to the minimum level thus making the screen dark
- Unplug the cable and re-plug it in after two minutes
- Check if you have accidentally pressed the "mute" button
- Connect cable to another TV



#### No Picture No Sound

- Check main power source
- Check other TV channels. If they are okay, problem is just with the TV program you are viewing
- Press the SOURCE button on the remote or on the top of the unit to get to the desired display option
- If you are using outdoor antenna, please check your connections
- Please check if your power cord is connected properly, it may be loose
- Switch off main power, disconnect cable. Reconnect cable after two minutes rest then switch on the main power
- Check if the antenna or cable are well connected
- Check your Remote Control
- Check power adapter and power cord if they have been damaged
- Connect cable to another TV
- If all fails, please contact with serviceman immediately

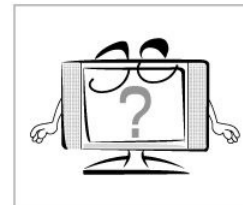

# AUDIOVOX® ELECTRONICS CORP.

## Troubleshooting



### Picture too dark

- Check your brightness level
- Check your contrast level
- In the on screen display (OSD) select default
- Check your LCD monitor for possible damage

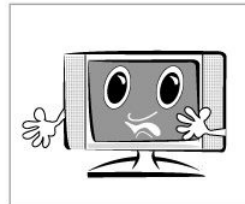

### Remote Control Failure

- Check TV main power source
- Check if remote control batteries are weak
- Check if batteries have been correctly installed
- Check if there are obstructions between your remote control and the main TV remote sensor
- Disconnect your cable for two minutes before reinstalling it
- If failure resulted from electrical interferences, lighting or static, disconnect the TV main power for 10 seconds before reinstalling it. Restart your TV
- Try holding remote 2 inches from sensor

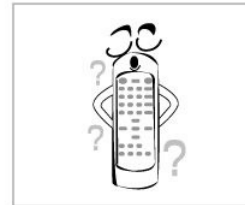

### Picture is blurry

- Check other channels. Problem may be an isolated incidence
- If using outdoor antenna, please check connections
- Please check your accessories. Such as Video recorder, VCD, DVD
- Check your cable company or outdoor antenna reception
- RF signal may be too slow
- If all fails, please contact our serviceman immediately

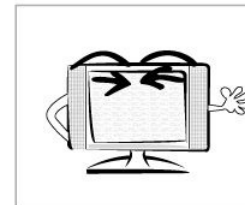

# AUDIOVOX<sup>®</sup>

## ELECTRONICS CORP.

### Troubleshooting

Before calling our serviceman, please refer to the following chart to see if you can adjust the problems yourself.

Trouble	Checks and Adjustments
TV will not turn on	<ul style="list-style-type: none"> <li>■ Plug TV in.</li> <li>■ Plug something else into the outlet to make sure it is working.</li> <li>■ Make sure batteries in the remote are not dead.</li> <li>■ Make sure batteries are placed in the remote the right way.</li> <li>■ Unplug TV for a few minutes and then turn it on again.</li> </ul>
Poor sound or no sound	<ul style="list-style-type: none"> <li>■ Check volume settings and mute settings</li> <li>■ Check for possible interference sources</li> </ul>
Blur picture or no picture	<ul style="list-style-type: none"> <li>■ Check antenna or TV cable</li> <li>■ Check for possible outside interferences</li> <li>■ Check picture settings</li> </ul>
Some channels are not clear	<ul style="list-style-type: none"> <li>■ Check outdoor antenna and make necessary adjustments</li> <li>■ Check possible outside interferences</li> </ul>
Poor Color tone or No color	<ul style="list-style-type: none"> <li>■ Check memory settings</li> <li>■ Check Color settings</li> <li>■ Check if program is in correct channel</li> <li>■ Check antenna and cable connections</li> <li>■ Check possible outside interferences</li> </ul>
No reception from Cable	<ul style="list-style-type: none"> <li>■ Check if cable is connected properly</li> <li>■ Check if channels are selected properly</li> <li>■ Check if cable company are experiencing technical problems</li> </ul>
Channels above 13 cannot receive	<ul style="list-style-type: none"> <li>■ Check TV channel settings</li> <li>■ Check antenna and UHF settings</li> </ul>
Unable to operate remote	<ul style="list-style-type: none"> <li>■ Check for low batteries or possible obstructions between remote and TV sensor</li> <li>■ Check TV main power source</li> </ul>
TV shut off	<ul style="list-style-type: none"> <li>■ Electric power failure</li> <li>■ Preset sleep mode features are on</li> <li>■ TV programs ended</li> </ul>

# AUDIOVOX<sup>®</sup>

## ELECTRONICS CORP.

### Notices



### NOTICES

1. The contents stated in this document and the product may be subject to change without prior notice. Please ask your distributor or go to [WWW.AUDIOVOX.COM](http://WWW.AUDIOVOX.COM) for the latest information.
2. This product is developed and produced for usage onto normal electronic products (home, office, automation equipment, game machine, etc) and is not suitable for applications which need extremely high reliability and extreme safety (aero- or space-use machines, control equipment for nuclear power, life keeping equipments, etc.)
3. It is strictly prohibited to copy or publish a part or whole of this document without our prior written approval.
4. Brightness depends on the temperature. (In lower temperature, it becomes lower)

#### Optical Specification

Optical characteristics are determined after the unit has been 'ON' and stable for approximately 30 minutes in a dark environment at 25c.

The values specified are at an approximate distance 50cm from the LCD surface at a viewing angle of 0 degree.

#### Lamp Life

Lamp life is defined as the time when brightness becomes 50% of the original value under standard condition.

# AUDIOVOX® ELECTRONICS CORP.

## Maintenance / Repair



### Maintenance:

- **DO NOT** wipe LCD with water

Clean the LCD using a dry soft cloth such as gauze. If the LCD is heavily soiled, apply a cleaner for LCD panels to the cloth and wipe off gently.  
DO NOT use chemical such as acetone, solvents as xylem or toluene.

- **WIPE** the cabinet with a soft cloth

If the cabinet is heavily soiled, wipe with soft cloth dipped in water



### REPAIR: (Important)

DO NOT SHIP PRODUCT BACK FOR REPAIR WITHOUT FIRST CONTACTING AUDIOVOX AT 1-800-645-4994.

AUDIOVOX WILL PROVIDE A SPECIALLY DESIGNED TRANSPORT BOX FOR YOUR UNIT. THIS BOX WILL BE PROVIDED TO YOU AT NO CHARGE. THE BOX WILL CONTAIN A PREPAID SHIPPING LABEL SO THE PRODUCT MAY BE RETURNED AT NO EXPENSE.

---

For assistance, please call: 1-800-645-4994  
or visit us at [WWW.AUDIOVOX.COM](http://WWW.AUDIOVOX.COM)



# Specifications

Display Features		Features	
Display type	TFT-LCD	High Definition Ready (HDTV)	
Screen Size		High Contrast Ratio	
Aspect Ratio	15:9	High Brightness (cd/?)	
Resolution (native)	1280 x 768	Excellent Viewing angle	
Brightness *	450cd/?	Digital Comb Filter	
Contrast ratio *	500	Hi-Resolution Component, S-video, Composite, RF, VGA	
Viewing Angle	85/85/85/85	Parental Control with V-Chip	
Dot Pitch	0.1675(H) x 0.5025(V) mm	Closed Captions (CC)	
Maximum Color	16.7M	Sleep (Power/OFF)	
Response time (Tr, Tf)	Tr=15ms, Tf=10ms	Model Specific Remote	
Response time (Gray/Gray)	16.6ms	Unique desktop Stand with Tilt	
Backlight life***	50000hrs	Wall Mounting kit (included)	
Electronics		Built-in NTSC TV tuner	
Digital Comb Filter / Type	4H/BULID IN	181 Channel Cable/Air Ready	
Reception		Personal Computer (PC) support (VGA 15 pin D-Sub)	
TV System	NTSC (only)	On Screen Audio Equalizer	
Channel	181 Channel Cable/Air	Slim-Type design, saves 70% space compared to CRT	
Antenna Impedance	VHF-L, VHF-H, UHF 75 Ohm	Super low power consumption in standby	
Connector type	Coax F-Connector	Anti-glare with anti-reflective coating	
Audio		Hard coating (2H)	
Maximum Audio Output	5 watt x 2	Accessories	
Total number of speakers	2	FPE3000 LCD display	
Connections		Quantity	
RF: TV/CATV 75ohms coaxial	1	Detachable Speakers (x2)	
Composite Video input	1	Model specific Remote Control (Infrared)	
S-Video input (4pin DIN)	1	Manual	
Component input (Y,Pb,Pr)	1 (480p, 720p, 1080i**)	Wall mounting instructions	
Component input (Y,Cb,Cr)	1 (480i only)	Desktop stand (included)	
VGA input 15 pin D-Sub	1	Wall mount bracket (included)	
Stereo mini phone audio jack (3.5mm)	1 (for pc)	Power Supply	
L/R RCA Audio for Composite, S-Video, YCbCr input	1(shared)	Audio Video Cables	
L/R RCA Audio for Component(YPbPr) input	1	Power	
Headphone: mini stereo jack	1	Power Source	100-240V~, 47-63Hz, 4-7A
		Unit input power	12VDC 4A, 24VDC 5A, 5VDC .5A
Video Standards supported		Power ON consumption	<160w
Composite Video input	NTSC	Standby consumption	<2w
S-Video Input	NTSC	Dimension (WxHxD)	
Component video input	480i, 480p, 720p, 1080i	W/Speakers and desktop stand	36.6 x 21.7 x 9.6 inches
RF	NTSC	W/Speakers, W/O desktop stand	36.6 x 19.0 x 3.3 inches
		W/O Speakers and desktop stand	29.6 x 19.0 x 3.3 inches
		Power supply	8.3 x 2.1 x 4.2 inches
		Master Carton	39.1 x 26 x 13.7 inches
		Weight (G.W.)	
		Master Carton	61.2 lbs
		Unit W/Stand	38.5 lbs
		Unit W/O Stand	31.5 lbs

\* - measured at peak

\*\* - 1080i signal downconverted to display resolution

\*\*\* - Based on brightness at 50 percent





PRINTED IN  
RECYCLED PAPER

## Free Manuals Download Website

<http://myh66.com>

<http://usermanuals.us>

<http://www.somanuals.com>

<http://www.4manuals.cc>

<http://www.manual-lib.com>

<http://www.404manual.com>

<http://www.luxmanual.com>

<http://aubethermostatmanual.com>

Golf course search by state

<http://golfingnear.com>

Email search by domain

<http://emailbydomain.com>

Auto manuals search

<http://auto.somanuals.com>

TV manuals search

<http://tv.somanuals.com>