

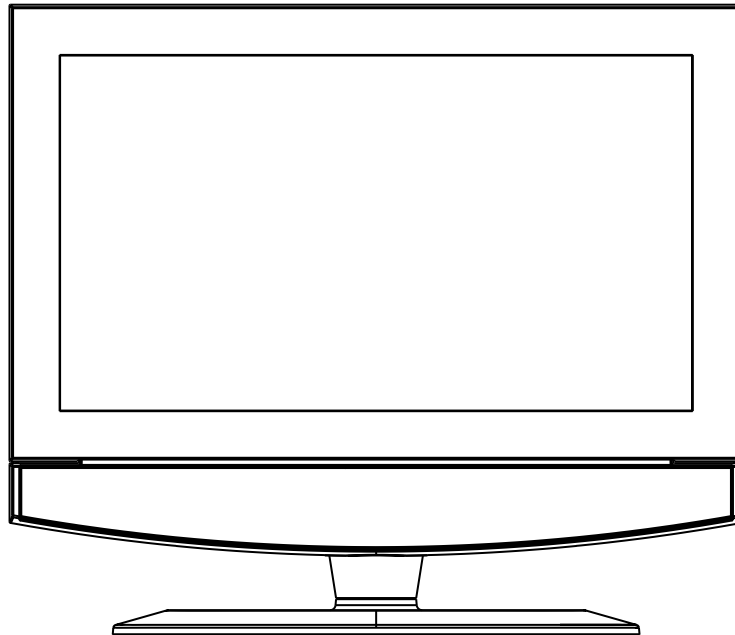

FPE3208

32" HD FLAT PANEL LCD TV



OWNER'S MANUAL



FOR ASSISTANCE CALL CUSTOMER SERVICE AT 1-800-645-4994
OR VISIT US AT WWW.AUDIOVOX.COM

128-XXXX

PLV36320CS11 / AUDIOVOX
I/B <P/N: 811-363291W010> <English>
SIZE : 148 X 210MM
MATERIAL : 80g WOODSFREE PAPER

Printed in China
811-363291W010

SAFETY PRECAUTIONS





CAUTION
RISK OF ELECTRIC SHOCK
DO NOT OPEN



DO NOT EXPOSE THIS UNIT TO RAIN OR MOISTURE
AVIS RISQUE DE CHOC ÉLECTRIQUE – NE PAS OUVRIR

WARNING : TO REDUCE THE RISK OF ELECTRIC SHOCK, DO NOT REMOVE COVER (OR BACK). NO USER SERVICEABLE PARTS INSIDE. REFER SERVICING TO QUALIFIED SERVICE PERSONNEL.

 The lightning flash with arrowhead symbol, within an equilateral triangle, is intended to alert the user to the presence of uninsulated "dangerous voltage" within the product's enclosure that may be of sufficient magnitude to constitute a risk of electric shock to persons.

 The exclamation point within an equilateral triangle is intended to alert the user to the presence of important operating and maintenance (servicing) instructions in the literature accompanying the appliance.

 The symbol for Class II (Double Insulation)

CAUTION

- DANGER OF EXPLOSION IF BATTERY IS INCORRECTLY REPLACED. REPLACE ONLY WITH THE SAME OR EQUIVALENT TYPE.
- **TO PREVENT ELECTRIC SHOCK, MATCH WIDE BLADE OF PLUG TO WIDE SLOT OF WALL OUTLET, THEN FULLY INSERT.**
- USE OF CONTROLS OR ADJUSTMENTS OR PERFORMANCE OF PROCEDURES OTHER THAN THOSE SPECIFIED MAY RESULT IN HAZARDOUS RADIATION EXPOSURE.



WARNING :

- TO PREVENT FIRE OR SHOCK HAZARD, DO NOT EXPOSE THIS UNIT TO RAIN OR MOISTURE. DO NOT PLACE OBJECTS FILLED WITH LIQUIDS ON OR NEAR THIS UNIT.
- SHOULD ANY TROUBLE OCCUR, DISCONNECT THE AC POWER CORD AND REFER SERVICING TO A QUALIFIED TECHNICIAN.



WARNING: Changes or modifications to this unit not expressly approved by party responsible for compliance could void the user authority to operate the unit.

PLACEMENT INFORMATION

- Do not use this unit in places which are extremely hot, cold, dusty or humid.
- Do not restrict the air flow of this unit by placing it somewhere with poor air flow, by covering it with a cloth, by placing it on bedding or carpeting.

SAFETY INFORMATION

- When connecting or disconnecting the AC power cord, grip the plug and not the cord itself. Pulling the cord may damage it and create a hazard.
- When you are not going to use the unit for a long period of time, disconnect the AC power cord.

CONDENSATION INFORMATION

- When left in a heated room where it is warm and damp, water droplets or condensation may form inside the equipment. When there is condensation inside the unit, the unit may not function normally. Let the unit stand for 1-2 hours before turning the power on or gradually heat the room and let the unit dry before use.

RATING PLATE LOCATION

The rating plate is located on the rear of unit.

FCC STATEMENTS

NOTE: This unit has been tested and found to comply with the limits for a Class B digital device, pursuant to Part 15 of the FCC Rules. These limits are designed to provide reasonable protection against harmful interference in a residential installation. This unit generates, uses and can radiate radio frequency energy and, if not installed and used in accordance with the instructions, may cause harmful interference to radio communication. However, there is not guarantee that interference will not occur in a particular installation. If this unit does cause harmful interference to radio or television reception, which can be determined by turning the unit off and on, the user is encouraged to try to correct the interference by one or more of the following measures:

- Reorient or relocate the receiving antenna.
- Increase the separation between the unit and receiver.
- Connect the unit into an outlet on a circuit different from that to which the receiver is connected.
- Consult the dealer or an experienced radio/TV technician for help.

IMPORTANT SAFETY INSTRUCTIONS

- 1) Read these instructions.
- 2) Keep these instructions.
- 3) Heed all warnings.
- 4) Follow all instructions.
- 5) Do not use this apparatus near water.
- 6) Clean only with a dry cloth.
- 7) Do not block any ventilation openings. Install in accordance with the manufacturer's instructions.
- 8) Do not install near any heat sources such as radiators, heat registers, stoves, or other apparatus (including amplifiers) that produce heat.
- 9) Do not defeat the safety purpose of the polarized or grounding-type plug. A polarized plug has two blades with one wider than the other. A grounding type plug has two blades and a third grounding prong. The wide blade or the third prong is provided for your safety. If the provided plug does not fit into your wall outlet, consult an electrician for replacement of the obsolete outlet.
- 10) Protect the power cord from being walked on or pinched particularly at plugs, convenience receptacles, and the point where they exit from the apparatus.
- 11) Only use attachments / accessories specified by the manufacturer.
- 12) Use only with the cart, stand, tripod, bracket, or table specified by the manufacturer, or sold with the apparatus. When a cart is used, use caution when moving the cart / apparatus combination to avoid injury from tip-over. 
- 13) Unplug this apparatus during lightning storms or when unused for long periods of time.
- 14) Refer all servicing to qualified service personnel. Servicing is required when the apparatus has been damaged in any way, such as the power cord or plug is damaged, liquid has been spilled or objects have fallen into the apparatus, the apparatus has been exposed to rain or moisture, does not operate normally, or has been dropped.



CONTENTS

SAFETY PRECAUTIONS	1
IMPORTANT SAFETY INSTRUCTIONS	2
CONTENTS	3
ACCESSORIES	4
GETTING STARTED	4
CONTROL REFERENCE GUIDE	5 - 7
CONNECTIONS	8 - 12
Connecting a TV Antenna / Cable / Satellite	8
Connecting an A / V Device	8
Connecting Devices with a Composite (Yellow RCA-Type) Video Output	9
Connecting Devices with a Composite (Yellow RCA-Type) Video Input	9
Connecting a High Definition (HD) Source	10
Connecting a PC	10
Connecting HDMI	11
Connecting an Audio Amplifier	11
Connecting the AC Power Cord	12
USING HEADPHONES	12
INSTALLATION	13
Removing the Base Stand	13
Mounting on the Wall	13
TV SETUP	14 - 19
Video Menu	14
Audio Menu	15
TV Menu	16
Setup Menu	17 - 18
Parental Menu	18 - 19
TROUBLESHOOTING GUIDE	20



ACCESSORIES

Please check and identify the supplied accessories.

- Remote Control (with batteries) x 1

GETTING STARTED

USING THE REMOTE CONTROL

- Point the remote control at the remote sensor located on the unit.
- When there is a strong ambient light source, the performance of the infrared remote sensor may be degraded, causing unreliable operation.
- The recommended effective distance for remote operation is about 16 feet (5 meters).

TO INSTALL BATTERIES

1. Open the battery door.
2. Insert 2 "AAA" batteries.

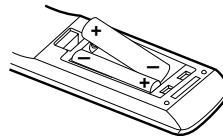
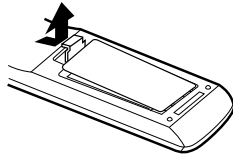

BATTERY REPLACEMENT

When the batteries become weak, the operating distance of the remote control is greatly reduced and you will need to replace the batteries.

CAUTION:
 Danger of explosion if battery is incorrectly replaced.

NOTES

- If the remote control is not going to be used for a long time, remove the batteries to avoid damage caused by battery leakage corrosion.
- Do not mix old and new batteries. Do not mix ALKALINE, standard (CARBON-ZINC) or rechargeable (NICKEL-CADMIUM) batteries.
- Always remove batteries as soon as they become weak.
- Weak batteries can leak and severely damage the remote control.
- **WARNING :** Do not dispose of batteries in a fire. Batteries may explode or leak.

WARNING : Do not dispose of batteries in a fire. Batteries may explode or leak.

Many universal remote controls have a "learning" feature. We recommend you use that feature to program the remote control.

For any questions or problems related to programming a universal remote control, you must contact the customer service department of the universal remote control manufacturer for assistance, or refer to the instructions included with the universal remote control. We cannot offer assistance in programming universal remote controls.

CONTROL REFERENCE GUIDE

REMOTE CONTROL

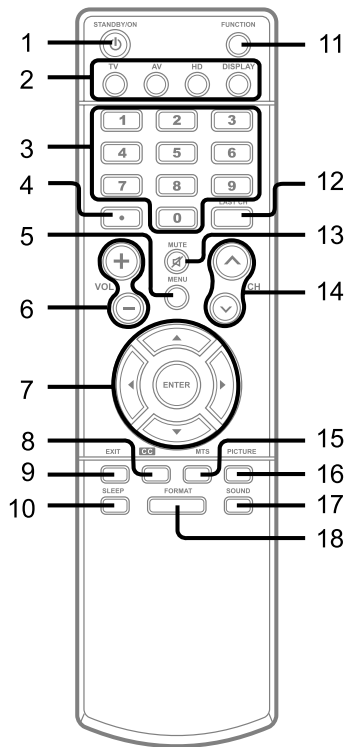

1. **⏻ STANDBY / ON button**
Press to turn ON the unit or put it in STANDBY (OFF) mode.
2. **TV button**
Press to switch to TV mode.
AV button
Press to switch to source connected to AV 1 / AV 2 (composite) inputs.
HD button
Press to switch to source connected to YUV (component) inputs and HDMI 1 / HDMI 2 inputs.
DISPLAY button
Press to change disc status information displayed on the screen.
3. **Number (0 - 9) buttons**
4. **• [dot] button**
Use to enter digital sub-channels. (i.e. 11.3 or 12.7)
5. **MENU button**
Press to display the on-screen TV menu.
6. **VOLUME (- / +) buttons**
Press to adjust the volume level.
7. **CURSOR (▲, ▼, ◀, ▶) buttons**
Press to highlight selections on a menu screen and adjust certain settings.
ENTER button
Press to confirm selections on a menu screen.
8. **CC button**
Press to activate the Closed Captioning feature. This function only works on programs broadcasted with captions.
9. **EXIT button**
Press to exit the TV SET UP menu and return directly to normal viewing.
10. **SLEEP button**
Press to set the SLEEP timer. The unit will remain on for the time that is set, and will automatically shut off afterwards.
11. **FUNCTION button**
Press to switch between TV / AV 1 / AV 2 / YUV in / HDMI 1 / HDMI 2 / PC in.
12. **LAST CH button**
Press to switch repeatedly between the last two channels displayed.
13. **MUTE button**
Press to turn off the sound.
14. **CH ^ / v CH buttons**
Press ^ / v to change the channels.
15. **MTS button**
Press to switch between MONO sound, STEREO sound and Secondary Audio Program (SAP).
16. **PICTURE button**
Select from preset screen display settings to match the type of show you are watching. (Personal / Soft / Movie / Standard / Dynamic)
17. **SOUND button**
Press to select from preset sound settings to match the type of show you are watching. (Standard / Personal / Theater / Voice / Music)
18. **FORMAT Button**
Press to select the picture format.



CONTROL REFERENCE GUIDE

FRONT & SIDE VIEWS

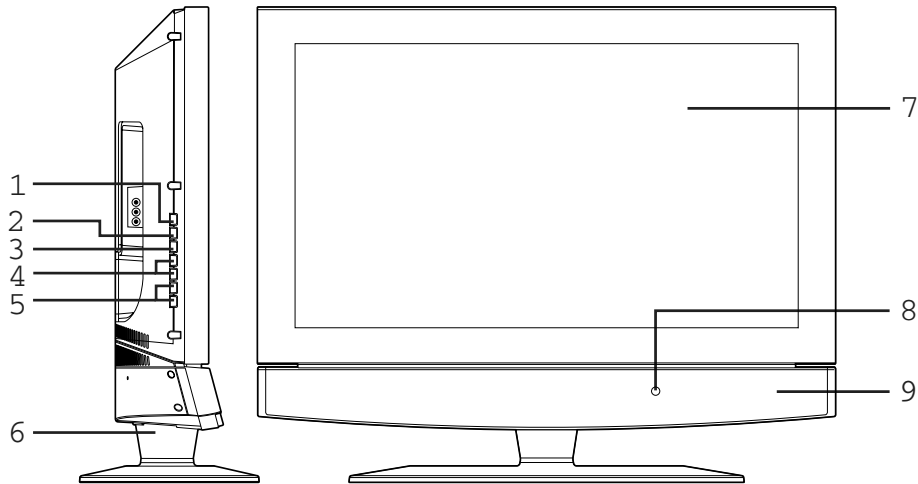

1. STD.BY / ON button

Turns the unit on and off.

2. MENU button

Enters the on-screen TV menu.

3. FUNCTION button

Selects TV / AV 1 / AV 2 / YUV in / HDMI 1 / HDMI 2 / PC in.

4. ^ CH v buttons

Confirms selections on the TV menu screen and changes the TV channels.

5. - VOL + controls

Adjusts the volume level.

6. Removable stand

7. Color LCD screen

8. Remote sensor

Receives the remote control signal.

Standby indicator

9. Speaker

CONTROL REFERENCE GUIDE

REAR VIEW

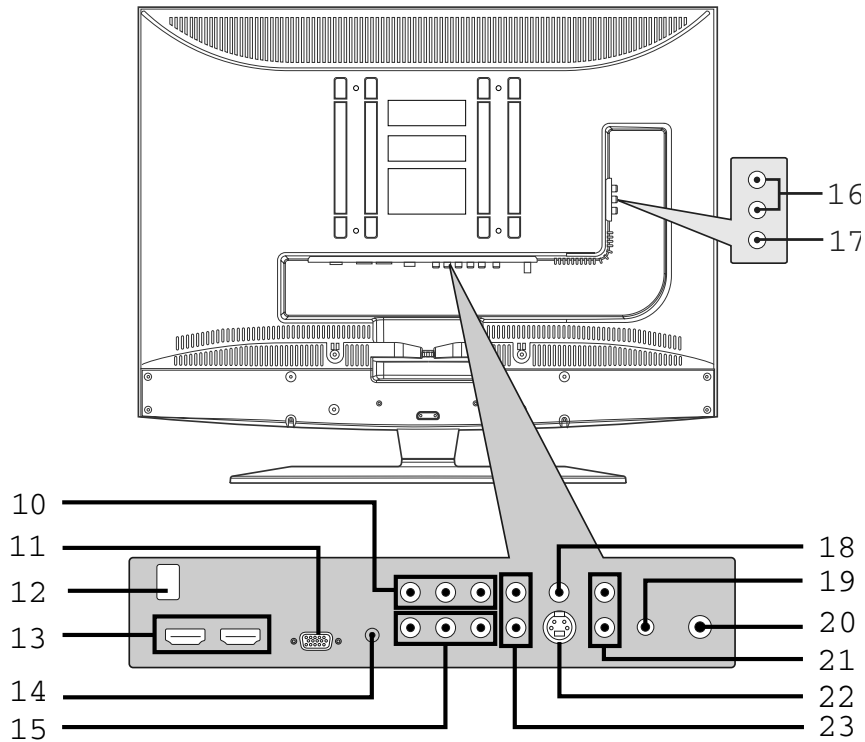

- | | |
|--|--|
| 10. VIDEO OUT jack (AV OUT) | 16. AUDIO IN (Left/Right) jacks (AV IN 2) |
| AUDIO OUT (Left / Right) jacks (AV OUT) | 17. VIDEO IN jack (AV IN 2) |
| 11. MONITOR / VGA jack (PC IN) | 18. VIDEO IN jack (AV IN 1) |
| 12. AC Power Cord | 19. PHONES jack |
| 13. HDMI IN jacks (HDMI IN 1 / HDMI IN 2) | 20. TV ANTENNA terminal |
| 14. AUDIO jack (PC IN) | 21. AUDIO IN (Left / Right) jacks (AV IN 1) |
| 15. COMPONENT VIDEO IN (Y / PB / PR) jacks (YUV IN) | 22. S-VIDEO jack (AV IN 1) |
| | 23. AUDIO IN (Left / Right) jacks (YUV IN) |

CONNECTIONS

CONNECTING A TV ANTENNA / CABLE / SATELLITE

To view television channels correctly, a signal must be received from one of the following sources:

- An indoor or outdoor aerial antenna
- A cable system
- A satellite system

Connecting a Digital Antenna

The tuner in this TV receives ATSC TV signals from an antenna.

This digital TV can receive standard (SDTV) and high definition (HDTV) over the air broadcasts.

Connecting an Analog Antenna or Device

The tuner in this TV receives NTSC TV signals, analog cable signals or the RF output from a satellite receiver, VCR or cable box.

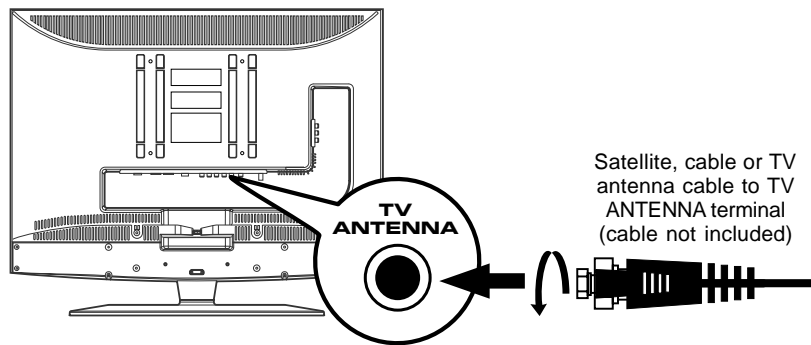

CONNECTING AN A/V DEVICE

To connect to other equipment such as a VCR, camcorder, satellite system or cable, etc.

Connecting to a VCR / Camcorder / Satellite System / Cable

Connect the AUDIO and S-VIDEO cable (not included) as shown:

Make sure you connect the cable from the other equipment (**AUDIO OUT** and **S-VIDEO OUT**) to this unit **AV IN 1 (AUDIO IN and S-VIDEO IN)**.

NOTE

Please refer to the user manual for the other equipment for more information.

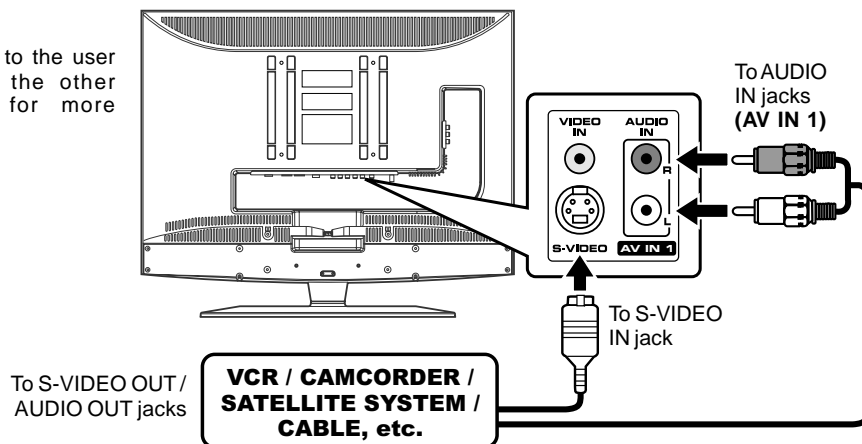

E - 8

CONNECTIONS

CONNECTING DEVICES WITH A COMPOSITE (YELLOW RCA-TYPE) VIDEO OUTPUT

To connect A/V devices such as a VCR, video game system or camcorder:

Connecting to a VCR / Video Game System / Camcorder

Connect the AUDIO / VIDEO cable (not included) as shown:

Make sure you connect the cable from the other equipment (**AUDIO** and **VIDEO OUT**) to this unit **AV IN 1** (**AUDIO** and **VIDEO IN**) or **AV IN 2** (**AUDIO** and **VIDEO IN**).

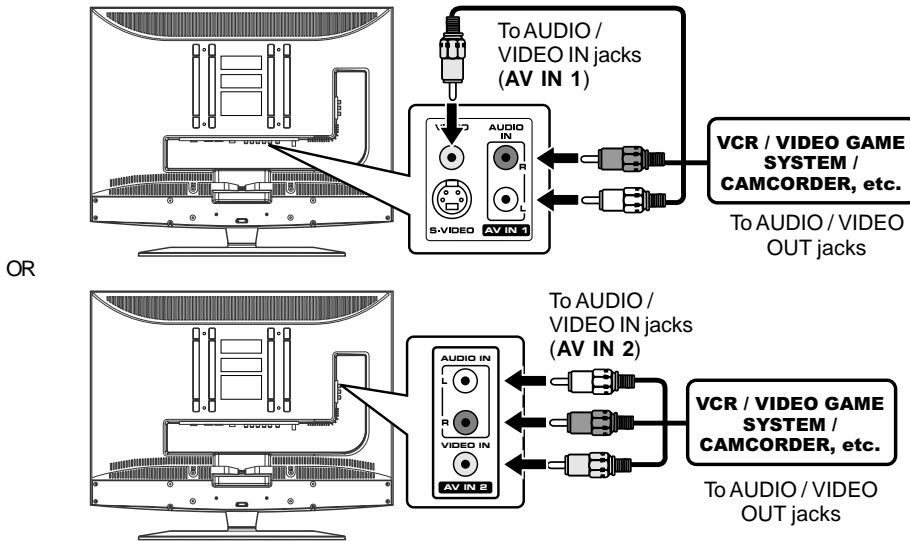

NOTE

Please refer to the user manual for the other equipment for more information.

CONNECTING DEVICES WITH A COMPOSITE (YELLOW RCA-TYPE) VIDEO INPUT

To connect A/V devices such as a VCR, PVR or camcorder:

Connecting to a VCR / PVR / Camcorder

Connect the AUDIO / VIDEO cable (not included) as shown:

Make sure you connect the cable from the other equipment (**AUDIO** and **VIDEO IN**) to this unit (**AUDIO** and **VIDEO OUT**).

NOTE

Please refer to the user manual for the other equipment for more information.

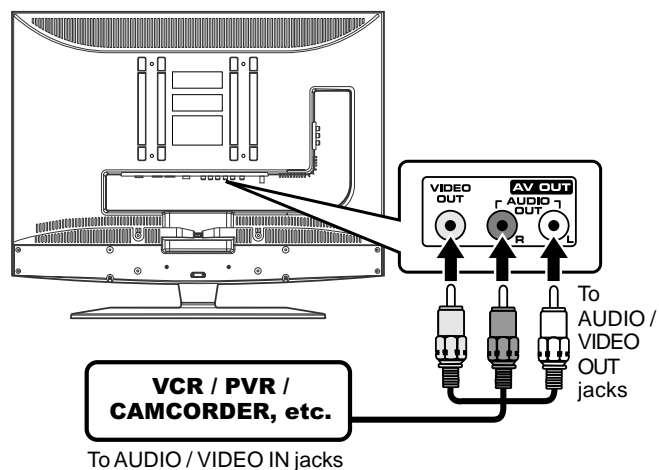

CONNECTIONS

CONNECTING A HIGH-DEFINITION (HD) SOURCE

High-Definition (HD) Devices with component video output must be connected to the YUV input. Connect the component video cable and audio cable (not included) as shown. Make sure you connect the component video cable and audio cable from the other equipment (**COMPONENT VIDEO OUT** and **AUDIO OUT**) to this unit (**COMPONENT VIDEO IN** and **AUDIO IN - YUV IN**).

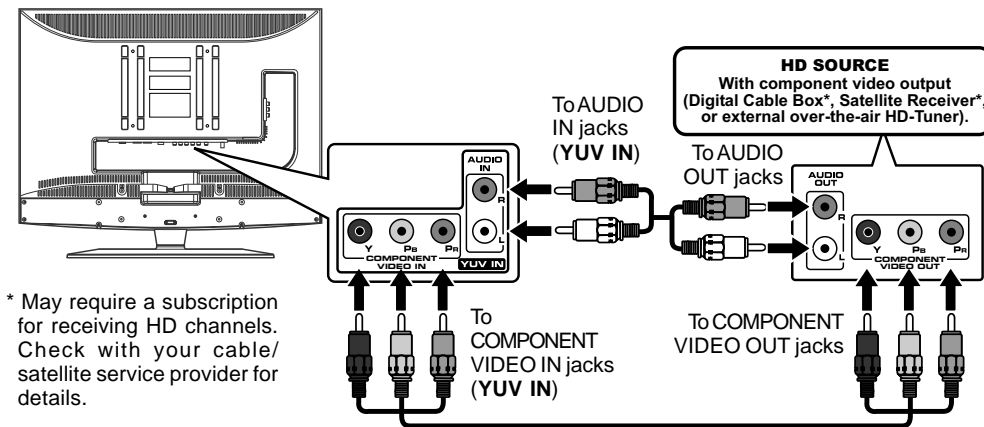

NOTE

When connecting a DVD player to the television, the picture resolution is solely dependent upon the resolution supported by the DVD player attached. DVD player resolutions vary from 480i to 1080i, and this unit can support DVD players up to a maximum resolution of 1080i.

CONNECTING A PC

Connect the 15-pin D-SUB PC/VGA connector from your computer to the 15-pin D-SUB PC/VGA input on this unit using a monitor cable and audio cable (not included) as shown.

Make sure you connect the cable from the computer (**PC Connector** and **PC AUDIO**) to this unit (**PC IN MONITOR / VGA** and **AUDIO**).

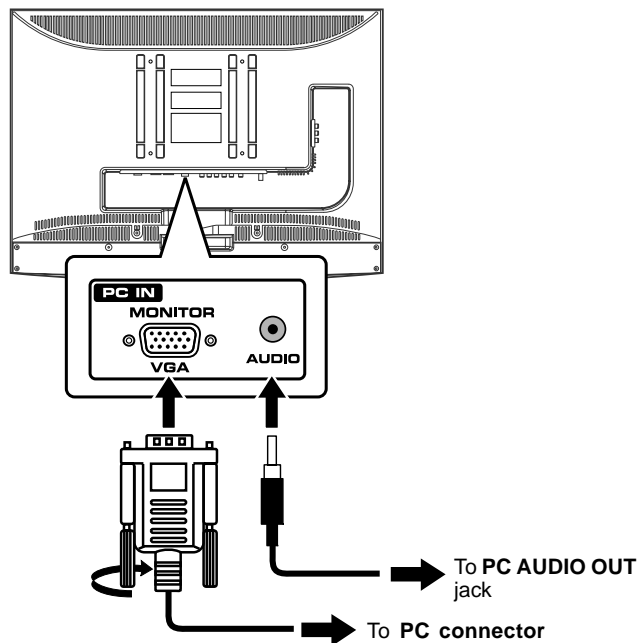

E - 10

CONNECTIONS

CONNECTING HDMI

HDMI (High Definition Multimedia Interface) supports both video and audio on a single digital connection for use with DVD players, DTV, set-top boxes and other digital AV devices. HDMI was developed to provide the technologies of High Bandwidth Digital Content Protection (HDCP) as well as Digital Visual Interface (DVI) in one specification. HDCP is used to protect digital content transmitted and received by DVI-compliant or HDMI-compliant displays.

HDMI has the capability to support standard, enhanced or high-definition video plus standard to multi-channel surround-sound audio. HDMI features include uncompressed digital video, a bandwidth of up to 2.2 gigabytes per second (with HDTV signals), one connector (instead of several cables and connectors), and communication between the AV source and AV devices such as DTVs.

HDMI, the HDMI logo **HDMI** and High-Definition Multimedia Interface are trademarks or registered trademarks of HDMI licensing LLC.

Connect the HDMI cable (not included) as shown:

Make sure you connect the cable from the source equipment (**HDMI OUT**) to this unit (**HDMI IN**).

Press the **HD** button to match the video source output quality.

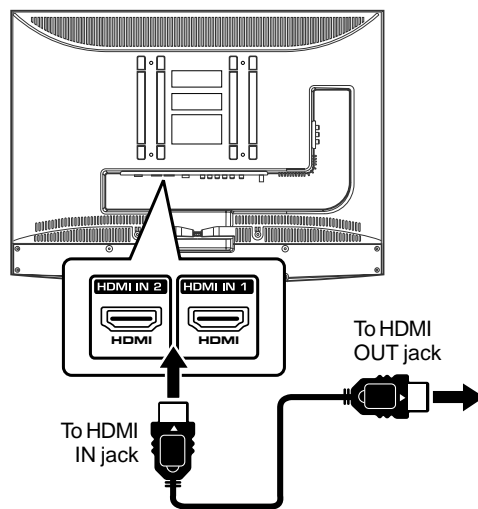

CONNECTING AN AUDIO AMPLIFIER

This connection allows you to use an audio amplifier and external speakers.

Connect the AUDIO cable (not included) as shown:

Make sure you connect the cable from the other equipment (**AUDIO IN**) to this unit (**AUDIO OUT**).

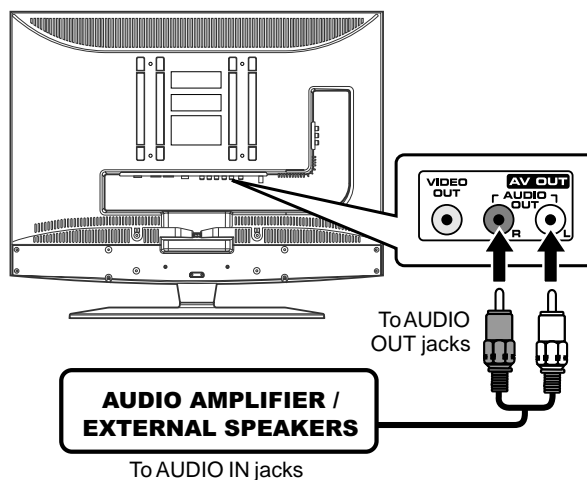

CONNECTIONS

CONNECTING THE AC POWER CORD

- Connect the AC power cord into a wall outlet.
- Press the **STD. BY / ON** button on the left side of the unit or use the remote control to turn on the unit.

NOTES

- **TO PREVENT ELECTRIC SHOCK, MATCH WIDE BLADE OF PLUG TO WIDE SLOT OF WALL OUTLET, THEN FULLY INSERT.**
- When the AC power cord is plugged in, the unit is not completely disconnected from the main power, even when the power is turned off.
- Be sure the AC power cord is disconnected and all functions are off before making connections.
- Make sure that all the components are connected correctly.
- When you are not going to use the unit for a long period of time, disconnect the AC power cord.

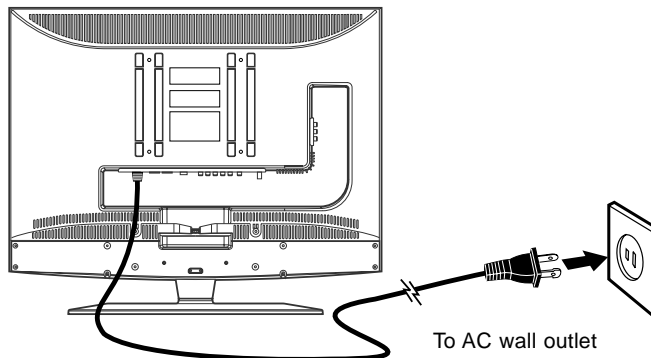

USING HEADPHONES

- Turn down the volume before connecting headphones to the unit, then adjust the volume to your desired level.
- When headphones are connected, no sound will come from the front speakers.

NOTE

Avoid listening to sound at high levels for prolonged periods of time. This may be harmful to you and may cause hearing loss.

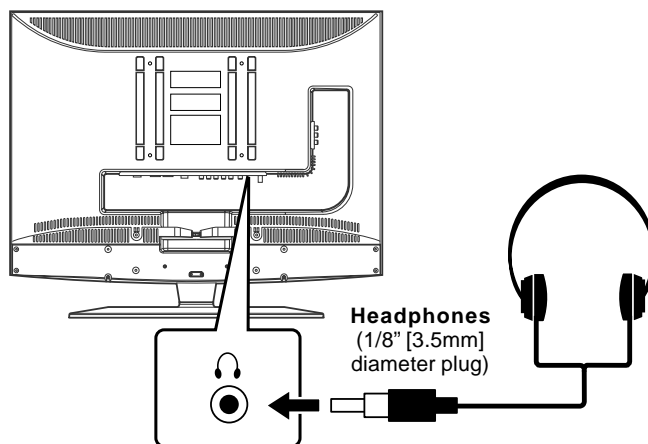

INSTALLATION

REMOVING THE BASE STAND

WARNING: The LCD display is very fragile, and must be protected at all times when removing the base stand. Be sure that no hard or sharp objects, or anything that could scratch or damage the LCD display, come in contact with it. Do NOT place pressure on the rear of the unit at anytime because the screen could crack.

1. Disconnect any cables or cords connected to the unit.
2. Lay the unit down on a flat surface, so the back side is facing up, making sure to place a soft cushioned material (such as a blanket or thick piece of foam) beneath the screen.
3. Remove the 8 screws and then remove the BASE STAND from the unit.

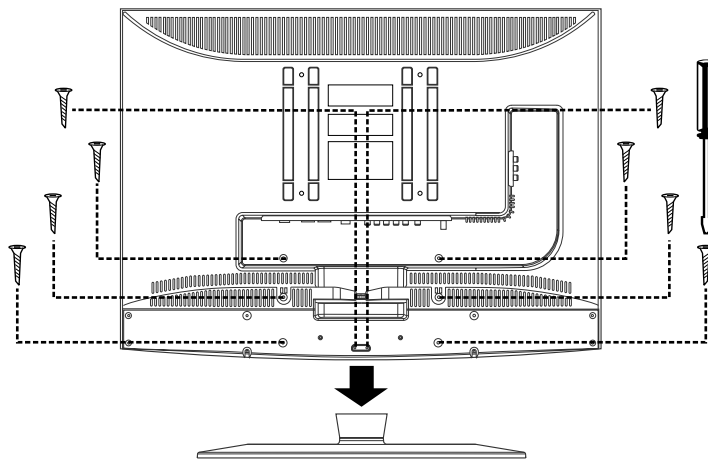

MOUNTING ON THE WALL

This unit is VESA-compliant, and is designed to be wall-mounted with a VESA-compliant 7 7/8" x 7 7/8" (200mm x 200mm) mounting kit designed for flat-panel TVs (sold separately). Mount this unit according to the directions included with the mounting kit.

NOTE

Remove the base stand before mounting the unit on the wall.

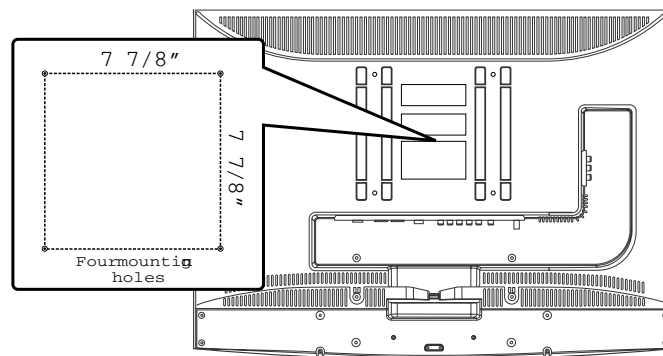



TV SETUP

VIDEO MENU

1. Press the **MENU** button.
2. Press the **ENTER** or **▶** button to select **Video**.
3. Use the **▲** or **▼** button to select the options (**Picture Mode**, **Brightness**, **Contrast**, **Saturation**, **Tint**, **Sharpness** or **Color Temperature**). Adjust them using the **◀** or **▶** button (The screen will change to your desired setting); or press the **ENTER** or **▶** button to go into the detailed settings.
4. Press the **EXIT** button to return to the previous menu.
5. Repeat steps 3 and 4 to adjust other options.
6. To exit the MAIN MENU and return to the normal screen, press the **EXIT** button repeatedly.

TV MODE

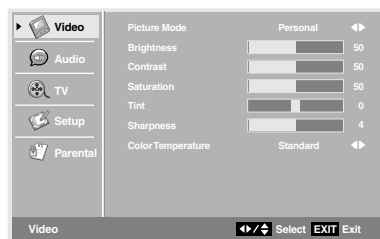

AV / YUV / HDMI MODE

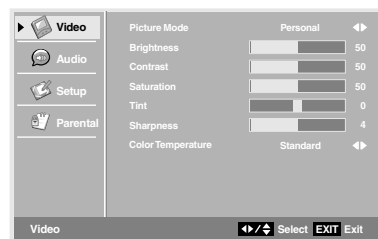

PC MODE



VGA SETTINGS IN PC MODE

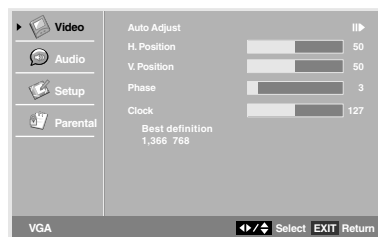

- Picture Mode** : Select from preset screen display settings to match the type of show you are watching (Personal, Soft, Movie, Standard & Dynamic). (Select Personal mode to recall your customized settings on brightness, contrast, saturation, tint, sharpness and color temperature.)
- Brightness** : Adjust the brightness of the picture. Brighten or darken the whole picture.
- Contrast** : Adjust to sharpen the picture quality. The black portions of the picture become richer in darkness and the white become brighter.
- Saturation** : Adjust the color saturation of the picture.
- Tint** : Adjust the tint of the picture. (Toward purple / Toward green)
- Sharpness** : Adjust the sharpness level to improve detail in the picture.
- Color Temperature** : Adjust the three color temperature of the picture. Choose from Standard (balanced), Warm (red white), or Cool (blue white) modes.
- H. Position** : Center the image by moving it left or right.
- V. Position** : Center the image by moving it up or down.
- Phase** : Adjusts the image if there is flicker of screen letters, color misalignment, or blurring.
- Clock** : Adjusts the display clock to change width of the image.

- Resolution : 1,366 x 768 max

TV SETUP

AUDIO MENU

1. Press the **MENU** button.
2. Use the **▲** or **▼** button to select **Audio**, then press the **ENTER** or **▶** button to go into the Audio settings.
3. Use the **▲** or **▼** button to select the options (**Balance**, **Bass**, **Treble**, **Virtual Surround**, **Reverb** or **Sound mode**). Adjust them using the **◀** or **▶** button (The screen will change to your desired setting); or press the **ENTER** or **▶** button to go into the detailed settings.
4. Press the **EXIT** button to return to the previous menu.
5. Repeat steps 3 and 4 to adjust other options.
6. To exit the MAIN MENU and return to the normal screen, press the **EXIT** button repeatedly.

TV MODE

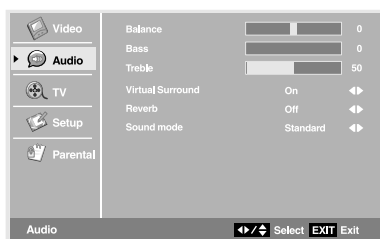

AV / YUV / HDMI / PC MODE

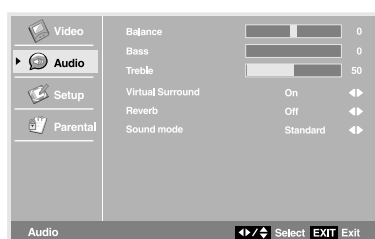

NOTE

Experiment with different sound settings until you find the settings you prefer.

- Balance** : Adjust the balance level toward the left or right speakers.
- Bass** : Adjust the bass range.
- Treble** : Adjust the treble range.
- Virtual Surround** : Switch on or off the virtual surround effect.
- Reverb** : Select from preset sound settings (Concert, Living Room, Hall, Arena, Church, Off) to match the type of show you are watching.
- Sound mode** : Select from preset sound settings (Standard, Personal, Theater, Voice & Music) to match the type of show you are watching. (Select Personal mode to recall your custom settings on bass and treble.)

TV SETUP

TV MENU (For TV Mode Only)

1. Press the **MENU** button.
2. Use the **▲** or **▼** button to select **TV**. Press the **ENTER** or **▶** button to go into the TV settings.
3. Use the **▲** or **▼** button to select the options (**Tuner Mode**, **Auto Scan**, **Auto Scan Add CH**, **Channel Skip**, **MTS** or **Audio Language**). Adjust them using the **◀** or **▶** button (The screen will change to your desired setting); or press the **ENTER** or **▶** button to go into the detailed settings.
4. Press the **EXIT** button to return to the previous menu.
5. Repeat steps 3 and 4 to adjust other options.
6. To exit the MAIN MENU and return to the normal screen, press the **EXIT** button repeatedly.

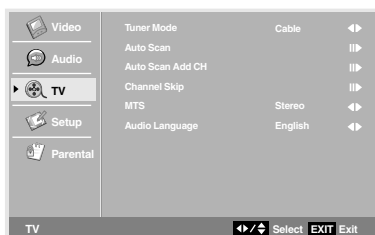

- Tuner Mode** : Antenna (over-the-air broadcasts, Ch 2-69) or Cable (cable/satellite broadcasts, CH 1-135) mode is available.
- Auto Scan** : Searches for usable stations and stores them in memory.
- Auto Scan Add CH** : Searches for more usable stations and adds them in memory. (The stations stored before are still kept.)
- Channel Skip** : Skip weak channels and the channels you do not like.
- MTS** : Select from Stereo / SAP (Secondary Audio Program) / Mono.
- Audio Language** : Select from English / Spanish / French. (Available for digital channels if multiple audio languages are broadcasted.)

NOTE

The SAP (Secondary Audio Program) feature allows a TV station to broadcast other information, which could be audio in another language.

Channel Skip Setting:

1. Use the **▲** or **▼** button to select a channel. (Press the **▶** button to select the last channel of the page, press again to go to the next page. Press the **◀** button to select the first channel of the page, press again to go to the previous page.)
2. Press the **ENTER** button to shift between skip or not skip the channel. ("✓" appears in the square means skip the selected channel. The channel will not appear when you press the **CH ^/CH v** Button.)





TV SETUP

SETUP MENU

1. Press the **MENU** button.
2. Use the **▲** or **▼** button to select **Setup**. Press the **ENTER** or **▶** button to go into the Setup settings.
3. Use the **▲** or **▼** button to select the options (**OSD Language**, **Time Setup**, **Caption** or **Restore setting**). Adjust them using the **◀** or **▶** button (The screen will change to your desired setting); or press the **ENTER** or **▶** button to go into the detailed settings.
4. Press the **EXIT** button to return to the previous menu.
5. Repeat steps 3 and 4 to adjust other options.
6. To exit the MAIN MENU and return to the normal screen, press the **EXIT** button repeatedly.

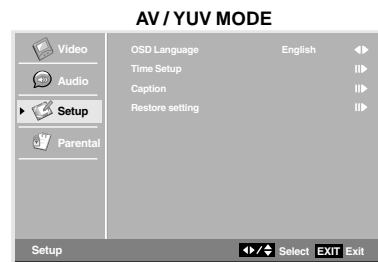
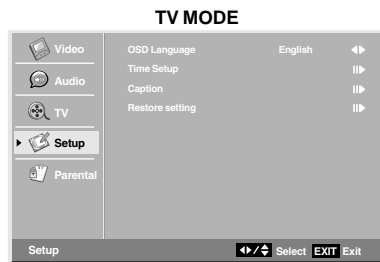

HDMI / PC MODE

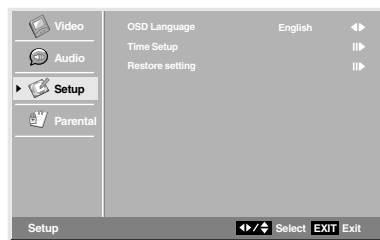

OSD Language :
Select from English / Español / Français.

Time Setup Setting

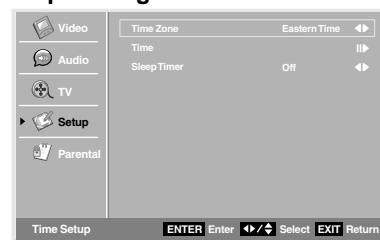

Time Zone : Select the time zone from Eastern Time / Indiana / Central Time / Mountain Time / Arizona / Pacific Time / Alaska / Hawaii.

Sleep Timer : Select the time to turn the unit to Standby mode automatically: Off -> 5 Minutes -> 10 Minutes -> 15 Minutes -> 30 Minutes -> 60 Minutes -> 90 Minutes -> 120 Minutes -> Off.

When you set the **'Time'**, the option will be shown:

Time Update : Select On/Off to activate the following manual settings; Select Auto to synchronize time with the digital TV channel signal.

Date : Press the **◀** or **▶** button to locate the position, and press the number buttons to input date.

Time : Press the **◀** or **▶** button to locate the position, and press the number buttons to input time.

Timer : Select On to activate automatically power on/off.

Power On Time : Press the **◀** or **▶** button to locate the position, and press the number buttons to input power on time.

Power Off Time : Press the **◀** or **▶** button to locate the position, and press the number buttons to input power off time.





TV SETUP

Caption Setting

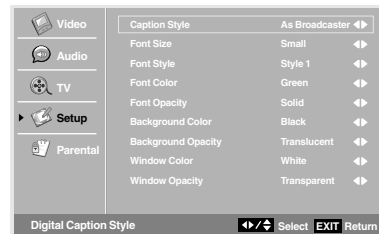
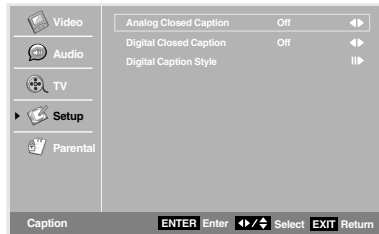

Analog Closed Caption : Select the analog closed caption or turn it off.

Digital Closed Caption : Select the digital closed caption or turn it off.

Digital Caption Style : Select as Broadcaster to use the default digital caption style of the broadcaster. Select Custom to activate the caption style items and set your preferred detailed settings.

NOTE

This function only works on ATSC programs broadcast with captions.

Restore Setting

If you reset the TV to the factory settings, all your present settings on Video & Audio will be erased and replaced by the factory's default settings. However, picture settings in PC mode and Parental settings will not be erased.

PARENTAL MENU

Password

1. Press the **MENU** button.
2. Use the **▲** or **▼** button to select **Parental**. Press the **ENTER** or **▶** button to confirm. The menu locked screen will be displayed.
3. Enter a 4-digit password. Once entered, the screen will enter the Parental menu. The preset password is 0000.

You can edit the parental control level or change the password. See **Parental Control Settings** on the next page.

TV MODE

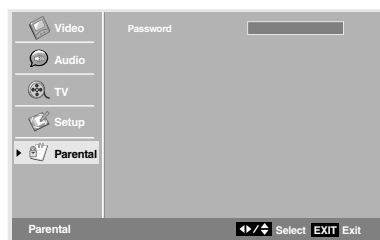

AV / YUV / HDMI / PC MODE

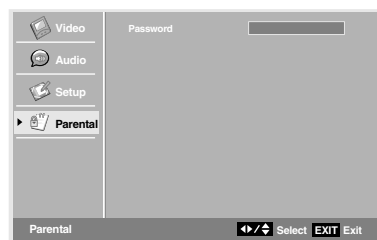

If you forget the password,
enter " 8888 " to unlock parental control.

TV SETUP

Parental Control Setting

1. Use the ▲ or ▼ button to select various Parental settings. Press the **ENTER** or ► button to go into the detailed settings.
2. Use the ▲, ▼, ◀ and ▶ buttons to move among the rating levels. Press the **ENTER** button to change the mode between Blocked and Allowed.
3. Press the **EXIT** button to return to the previous menu.
4. Repeat steps 1 - 3 to adjust other options.
5. To exit the MAIN MENU and return to the normal screen, press the **EXIT** button repeatedly.

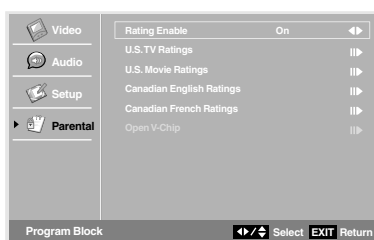
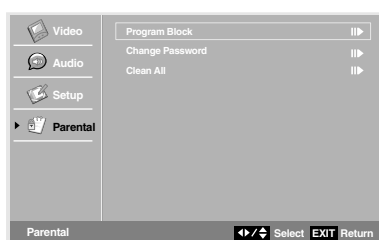

- Rating Enable** : Select On to edit the following parental items. Select Off to disable parental control.
- Open V-Chip** : Reads the ratings from ATSC TV programs if there is rating information broadcasted, and denies the channel when its rating is higher than the ratings you pre-set.

U.S. TV Ratings	<p>TV-Y : Recommended for all children.</p> <p>TV-Y7 : Recommended for all children age 7 and above.</p> <p>TV-G : General Audience.</p> <p>TV-PG : Parental Guidance Suggested.</p> <p>TV-14 : Parental Strongly Cautioned.</p> <p>TV-MA : Mature Audience Only.</p>
U.S. Movie Ratings	<p>G : GENERALAUDIENCES, Suitable for all ages.</p> <p>PG : PARENTAL GUIDANCE SUGGESTED - Some material may not be suitable for children.</p> <p>PG-13 : PARENTS STRONGLY CAUTIONED - Some material may be inappropriate for children under 13.</p> <p>R : RESTRICTED, Under 17 requires accompanying parent or adult guardian for viewing in movie theaters.</p> <p>NC-17 : No one 17 or under admitted in movie theaters.</p> <p>X : Adults Only.</p>
Canadian English Ratings	<p>C : Children.</p> <p>C8+ : Recommended for children age 8 and older.</p> <p>G : GENERALAUDIENCES, Suitable for all ages.</p> <p>PG : PARENTAL GUIDANCE SUGGESTED - Some material may not be suitable for children.</p> <p>14+ : Viewers 14 years and older.</p> <p>18+ : Adult Programming.</p>
Canadian French Ratings	<p>G : GENERALAUDIENCES, Suitable for all ages.</p> <p>8 ans+ : Not recommended for young children.</p> <p>13 ans+ : Not suitable for children under the age of 13.</p> <p>16 ans+ : Not suitable for children under the age of 16.</p> <p>18 ans+ : Adult Programming.</p>

TROUBLESHOOTING GUIDE

SYMPTOM

CAUSE (AND REMEDY)

No power.

- Check that the AC power cord is connected.
- The unit is not turned on.

The remote does not function.

- Remove any obstacles between the remote and the unit.
- Use the remote near the unit.
- Point the remote at the remote sensor on the unit.
- Replace the batteries in the remote with new ones.

TV

Bad Picture (snow, multiple images, distortion, blurry)

- Check the location of the antenna and adjust it if necessary.
- Make sure the antenna cable is firmly connected.
- Make sure all input cables are firmly connected.

Black and white picture.

- Check the VIDEO MENU within the TV SETUP MENU.
- Check to make sure the program you are watching is broadcast in color and not black & white.

No picture or sound.

- Make sure the unit is plugged in and turned on.
- Make sure that TV mode is selected.
- Try a new channel to check for possible station trouble.
- Make sure the antenna is connected properly.
- Increase the volume.
- Make sure the antenna or audio video source device is working properly.
- Make sure all cables are firmly connected.
- Check for local interference.

Colored patches of picture.

- Make sure there are no unshielded electrical devices nearby that are causing interference.
- Turn the unit off for 30 minutes, then try it again.

No sound is output from the HDMI out.

- Check the connection between this unit and the HDMI out jack of other equipment.
- See if the TV supports this 480p/576p/720p/1080i DVD system.
- Check your TV system setup correctly.
- Make sure your TV supports HDCP (High Bandwidth Digital Content Protection).



Unit : INCH

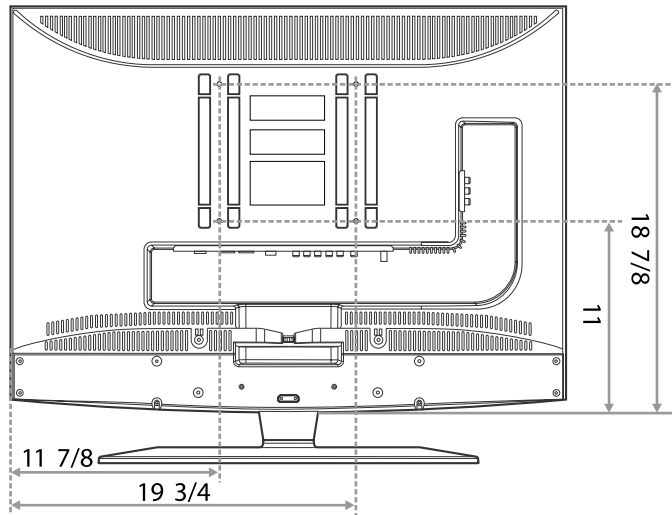
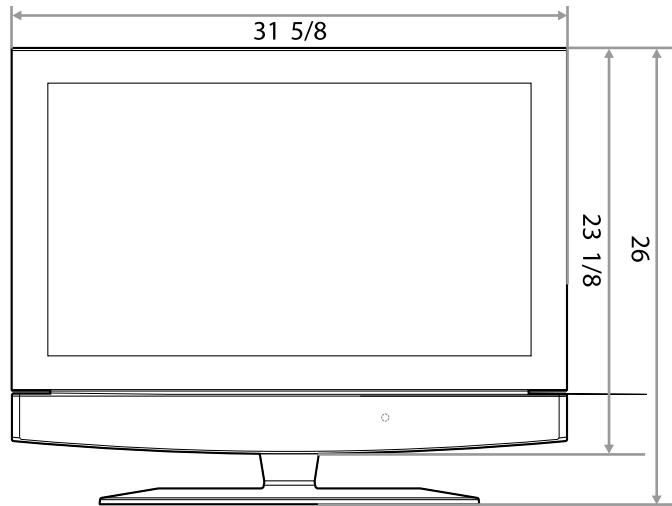
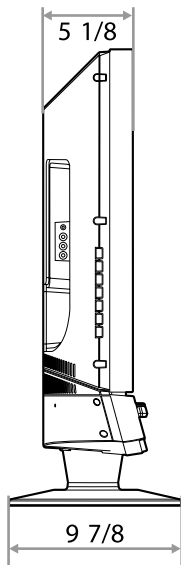

Print in China
811-363291W010

Free Manuals Download Website

<http://myh66.com>

<http://usermanuals.us>

<http://www.somanuals.com>

<http://www.4manuals.cc>

<http://www.manual-lib.com>

<http://www.404manual.com>

<http://www.luxmanual.com>

<http://aubethermostatmanual.com>

Golf course search by state

<http://golfingnear.com>

Email search by domain

<http://emailbydomain.com>

Auto manuals search

<http://auto.somanuals.com>

TV manuals search

<http://tv.somanuals.com>