

Pioneer

MULTI PLAYER

CDJ-2000NXS

CDJ-2000nexus



<http://pioneerdj.com/support/>

The Pioneer website shown above offers FAQs, information on software and various other types of information and services to allow you to use your product in greater comfort.

<http://rekordbox.com/>

For inquiries on rekordbox™, please see the support site indicated above.

Operating Instructions

Contents

How to read this manual

In this manual, names of screens and menus displayed on the computer screen, as well as names of buttons and terminals on the product, etc., are indicated within brackets.

Examples:

- Press the **[CUE]** button.
- The **[UTILITY]** screen is displayed.
- Click on the Windows **[Start]** menu button, then **[All Programs]** > **[Pioneer]** > **[rekordbox 2.x.x]** > **[rekordbox 2.x.x]**.
- Connect the LAN cable properly to the **[LINK]** terminal.

01 Before start

Features 3

02 Before you start

Supported sources 5
Usable media 5
Playable music file formats 7
Functions usable in combination with a computer 8

03 Connections

Descriptions of terminals 12
Basic style 12
Using other brands of DJ software 15
Connections for relay play 15

04 Part names and functions

Control panel 16
Rear panel 19
Front panel 19
Main unit display 20
Jog dial display section 21

05 Basic Operation

Turning the power on 22
Turning the power off 22
Loading and ejecting discs 22
Inserting and ejecting SD memory cards 22
Connecting and disconnecting USB devices 23
Playback 23
Operating the jog dial 25
Adjusting the playback and stopping speeds 25

06 Advanced Operation

Setting Cue 26
Setting Loop 26
Setting Hot Cue 27
Storing cue or loop points 28
Deleting stored cue or loop points 28
Setting the cue point for auto cueing 29
Using the slip mode 29
Playing from the point touched on the **[NEEDLE SEARCH]** pad 30
Using the beat sync function 31
Operating the CDJ-2000NXS in combination with other devices 31
Browsing tracks 31
Other browsing operations 32
Using hot cue banks 33
Checking the playing history (**HISTORY**) 34
Editing tag lists 34
Displaying the details of the currently loaded track 36
Changing track ratings 36
Displaying details of tracks loaded in other DJ players 36

07 Changing the settings

Storing the settings on a storage device (SD, USB) 37
Calling out settings stored on a storage device (SD, USB) 37

Displaying the **[UTILITY]** screen 37
Changing the settings 37
Duplicating the settings onto DJ players connected by PRO DJ LINK 39
About the driver software (Windows) 39

08 Using other brands of DJ software

Operating DJ software by MIDI interface 41

09 Additional information

Troubleshooting 43
About the liquid crystal display 44
About iPods/iPhones/iPads 44
Error messages 45
List of icons displayed on the main unit display section 45
Cautions on use 46
Handling discs 46
About trademarks and registered trademarks 47
Specifications 47

Before start

Features

This unit is a multi player for professional DJs, offering the variety of functions, durability and operability required for working in discos and nightclubs.

MULTI MEDIA, MULTI FORMAT

The CDJ-2000 can play not only discs (CDs and DVDs), but also music files recorded on SD memory cards and USB devices (flash memory drives and hard disks). Supported music file formats include not only music CD (CD-DA) and MP3 but also AAC, WAV and AIFF.

The included rekordbox (Mac/Windows) music management software can be used to prepare playlists, cues, loops, hot cues and beat grids required for DJ play unhurriedly at home. This allows you to devote all your attention to your DJ performance at the disco/nightclub on the day of the performance, with total assurance. From acquiring music files to DJ performances, all steps in the cycle of the DJ's work can be accomplished smoothly.

rekordbox (Mac/Windows)

rekordbox is a software program allowing users who have purchased a Pioneer DJ player supporting rekordbox to manage music files to be used for DJ performances.

The included rekordbox music management software can be used for the management (analysis, settings, creation, history storage) of music files on computers. Using music files managed with rekordbox in combination with this unit makes it possible to achieve outstanding DJ performances.

In these operating instructions, the version of rekordbox for Mac/Windows is referred to as "rekordbox (Mac/Windows)". "rekordbox" is used to indicate the versions of rekordbox (Mac/Windows) and rekordbox (iOS/Android) simultaneously, as well as when referring to rekordbox functions directly.

rekordbox (iOS/Android)

rekordbox (iOS/Android), a smartphone application that can be downloaded free of charge, can be used for the management (analysis, settings, creation, history storage) of music files on mobile devices. Using music files managed with rekordbox (iOS/Android) in combination with this unit makes it possible to achieve outstanding DJ performances.

- In these operating instructions, the version of rekordbox for mobile devices is referred to as "rekordbox (iOS/Android)".

PRO DJ LINK

Two types of PRO DJ LINK functions are provided: "SD & USB Export" using an SD memory card or USB device (flash memory device or hard disk) and "rekordbox LINK Export" using a computer on which rekordbox is installed.

❖ SD & USB Export

rekordbox music files and management data can be exchanged using storage devices (SD, USB). This eliminates the need to take the computer to discos or clubs.

At home or in a studio

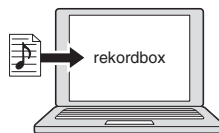

- Add music files to collections and analyze them.
- Make the preparations on rekordbox.



Export the rekordbox data on a storage device (SD, USB).



At the disco or club

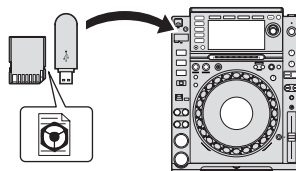

Connect the storage device (SD, USB) to the DJ player.

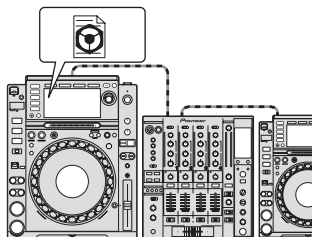

- Use the rekordbox data for the performance.
- Share the rekordbox data using the PRO DJ LINK function.



The playback history is stored on the storage device (SD, USB).



At home or in a studio

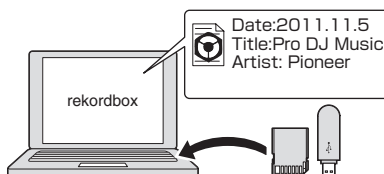

Check and manage the playback history with rekordbox.

❖ rekordbox LINK Export

When this unit and a computer are connected by LAN cable, the rekordbox music files and management data can be exchanged directly. This eliminates the need to export the data to a storage device (SD, USB). Wireless connection using a wireless LAN router (or wireless LAN access point) is also possible.

At home or in a studio



- Add music files to collections and analyze them.
- Make the preparations on rekordbox.



At the disco or club

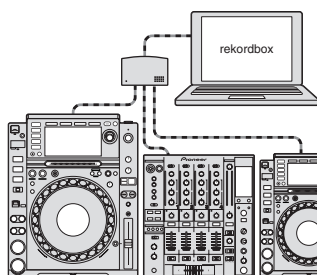

Connect the computer and DJ player.

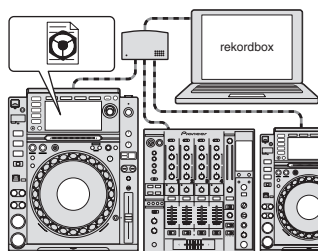

- Use the rekordbox data for the performance.
- Share the rekordbox data using the PRO DJ LINK function.



At home or in a studio

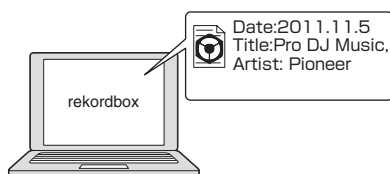

Check and manage the playback history with rekordbox.

BEAT SYNC

The tempo and beat position of the track to be played on this unit can automatically be matched to another DJ player connected by PRO DJ LINK. The assistance to mixing provided by the beat sync function makes it possible to hold performances with mixing, effects, etc., greatly expanding the range of DJ performances. (The tracks must be analyzed ahead of time with rekordbox in order to use the beat sync function.)

MY SETTINGS

Some of this unit's settings can be written onto and called out from storage devices (SD, USB). It is also possible to make this unit's settings using rekordbox. The settings you use at home can be called out immediately, so you can devote all your attention to your performance at the disco/nightclub, with total assurance.

BROWSE

A large 6.1-inch color LCD is used to display not only text data but also jacket photos. The combination of a GUI displaying music file information in easily understandable fashion and a rotary selector with easy operation lets you select tracks with no stress.

WAVE ZOOM

An enlarged waveform of the track that can be enlarged or reduced is displayed. This enlarged waveform is color-coded by band, allowing you to check the track's information visually in greater detail.

BEAT COUNTDOWN

The number of beats remaining to the stored cue points is displayed. When cue points are set and stored in advance at breaks in the tracks, etc., this gives you an accurate account of the number of beats to the set point.

QUANTIZE

The CDJ-2000NXS is equipped with a quantize function for putting a track on beat even when the button is pressed roughly, as long as the track has been analyzed with rekordbox. When setting real time cues and hot cues, the beat is automatically set to the beat closest to the position at which the button was pressed.

On this unit, accurate, on-beat performances are possible without breaking the rhythm of the currently playing track, not only when making settings but also when using such functions as looping, reversing and hot cueing during playback.

SLIP MODE

This unit is equipped with a slip mode function that keeps the track moving in the background while looping, reversing, scratching, hot cueing or pausing. This enables innovative DJ performances while maintaining the original track's development, even after looping, reversing, scratching, hot cueing or pausing are finished.

HIGH SOUND QUALITY

The CDJ-2000NXS is designed for thorough improvement of the sound quality, for both the digital and analog outputs.

For the digital circuitry, a high performance Wolfson D/A converter is used to faithfully reproduce even the most delicate sounds, achieving clear, high quality sound with a rich sense of mass and acoustic field. For the analog circuitry, a hybrid OP amplifier is used to reduce to the utmost limits that inaudible noise of 20 kHz and higher that can blur the original sound. Unwanted digital noise is shut out to achieve clear, highly transparent sound faithful to the original.

SOUND CARD

This unit is equipped with exclusive interface and MIDI interface for controlling the DJ software of other brands. There is also a built-in sound card, so other equipment can be connected easily.

Before you start

Supported sources

This unit supports the sources listed below.

- Discs (page 5)
- USB devices (page 6)
- SD memory card (page 6)
- Computers (page 24)

About the included CD-ROM

This unit can be used in combination with a computer when the software is installed onto the computer from the included CD-ROM.







The included CD-ROM contains the following two software programs.

- rekordbox (Mac/Windows) music management software
- Driver software

Usable media

About discs

This unit can play the discs shown below.

Type	Mark ¹	Compatible formats	Supported file systems
CD		<ul style="list-style-type: none"> • Music CD (CD-DA) 	—
CD-R		<ul style="list-style-type: none"> • Music CD (CD-DA) • CD-ROM 	ISO9660 level 1, ISO9660 level 2, Romeo and Joliet
CD-RW			
CD-TEXT ²		Music CD (CD-DA)	—
DVD-R DVD-R DL (dual layer)			
DVD-RW		DVD-ROM	ISO9660 level 1, ISO9660 level 2, Romeo and Joliet
DVD+R DVD+R DL (dual layer)			
DVD+RW			

¹ Discs on which the marks on this table are indicated on the disc label, package or jacket can be played.

² Titles, album names and artist names recorded in the CD-Text data are displayed. When multiple text data are recorded on the disc, the information for the first text data is displayed.

❖ Discs that cannot be played

- DTS-CD
- Photo CDs
- Video CDs
- CD Graphics (CD-G) discs
- Unfinalized CDs
- DVD-Video discs
- DVD-Audio discs
- DVD-RAM discs
- Unfinalized DVDs

❖ About CD-R/-RW discs

Music files (MP3/AAC/WAV/AIFF) recorded on CD-R/-RW discs can be played.

Folder layers	Max. 8 layers (files in folders beyond the 8th layer cannot be played)
Max. number of folders	2 000 folders
Max. number of files	3 000 files

When there are many folders or files, some time may be required for loading.

❖ Playback of discs created on a computer or DVD recorder

Depending on the application's settings and the computer's environment settings, it may not be possible to play discs created on a computer. Record discs in a format playable on this unit. For details, contact your application's selling agent.

It may not be possible to play discs created on a computer or DVD recorder due to the disc's properties, scratches or dirt, or poor recording quality (dirt on the recording lens, etc.).

See *Handling discs* on page 46 for instructions on handling discs.

❖ Creating backup discs

When CD-R/-RW, DVD-R/-RW, DVD+R/+RW, DVD-R DL (dual layer) and DVD+R DL (dual layer) discs are paused or left in the pause mode at cue points for long periods of time, it may become difficult to play the disc that point, due to the properties of the disc. When a specific point is looped repeatedly an extremely large number of times, it may become difficult to play that point.

When playing valuable discs, we recommend making backup discs.

❖ Regarding copy protected CDs

This unit is designed to CD standards. Operation and performance of discs with standards other than CD standards is not guaranteed.

❖ About playing DualDiscs

A DualDisc is a new two-sided disc, one side of which contains DVD content — video, audio, etc. — while the other side contains non-DVD content such as digital audio material.

The non-DVD, audio side of the disc is not compatible with this player. For more detailed information on the DualDisc specification, please refer to the disc manufacturer or disc retailer.

❖ About 8 cm discs

8 cm discs cannot be played. Do not mount 8 cm adapters on discs and play the discs on this unit. The adapter could come off while the disc is rotating, damaging both the disc and this unit.

About SD memory cards

Music files (MP3/AAC/WAV/AIFF) recorded on SD memory cards conforming to SD standards can be played.

Such data as disc identification information, cue points, loop points and hot cues can be recorded on SD memory cards.

In this manual, "SD memory card" collectively refers to SD memory cards, SDHC memory cards, mini-SD memory cards mounted in SD memory card adapters and micro-SD memory cards mounted in SD memory card adapters.

Folder layers	Max. 8 layers (files in folders beyond the 8th layer cannot be played)
Max. number of folders	Unlimited (folders beyond the 10 000th folder within a single folder cannot be displayed)
Max. number of files	Unlimited (files beyond the 10 000th file within a single folder cannot be displayed)
Supported cards ^[1]	<ul style="list-style-type: none">SD memory cards: 8 MB – 2 GBSDHC memory cards: 4 GB – 32 GB
Compatible formats	<ul style="list-style-type: none">SD memory cards: FAT12 and FAT16 (conforming to SD standards)SDHC memory cards: FAT32 (conforming to SD standards)

[1] CPRM is not supported.

- If an SD memory card not formatted in one of the above compatible formats is inserted, [FORMAT SD] is displayed and the card cannot be used. Re-format the card on a computer, etc., before using it.
- Pioneer does not guarantee that all SD memory cards will operate on this unit.

❖ Cautions on using SD memory cards

- SD memory cards are precision electronic devices. Handle them with care. Bending, dropping or subjecting SD memory cards to strong forces or shocks could break them. Also, do not use or store SD memory cards in environments where static electricity or electric noise tends to be produced. We recommend periodically making copies of valuable data.
- Please note that Pioneer will accept no responsibility whatsoever for loss of data recorded by the customer on SD memory cards or other direct or indirect problems resulting from connection to this unit.
- After ejecting SD memory cards, store them in their dedicated case, etc.
- Depending on the SD memory card you are using, the desired performance may not be achieved.

About USB devices

This unit supports USB mass storage class USB devices (external hard disks, portable flash memory devices, digital audio players, etc.).

Folder layers	Max. 8 layers (files in folders beyond the 8th layer cannot be played)
Max. number of folders	Unlimited (folders beyond the 10 000th folder within a single folder cannot be displayed)
Max. number of files	Unlimited (files beyond the 10 000th file within a single folder cannot be displayed)
Supported file systems	FAT16, FAT32 and HFS+ (NTFS is not supported.)

Tracks managed by rekordbox (iOS/Android) can be played by connecting the mobile device on which rekordbox (iOS/Android) is installed via USB. For supported devices, see the Pioneer DJ website (<http://pioneerdj.com/support/>). For instructions on rekordbox (iOS/Android), see the rekordbox (iOS/Android) user's manual.

When there are many folders or files, some time may be required for loading.

Folders and files exceeding the limits cannot be displayed.

❖ USB devices that cannot be used

- Optical disc type devices such as external DVD/CD drives, etc., are not supported.
- USB hubs cannot be used.
- iPods cannot be used. (Music data on an iPad, iPod touch or iPhone can only be played on this unit if it is added to the rekordbox (iOS/Android) library.)

❖ Cautions on using USB devices

- Some USB devices may not operate properly. Please note that Pioneer will accept no responsibility whatsoever for loss of data stored by the user on USB devices or other direct or indirect problems arising due to connection of USB devices to this unit.
- If a current larger than the allowable value is detected at this unit's USB device insertion slot, it may happen that the [USB STOP] indicator flashes, the supply of power to the USB device is stopped and communications are interrupted. To restore normal operation, disconnect the USB device from this unit. Avoid using USB devices for which excess currents have been detected. If normal operation is not restored using the method above (if communications cannot be established), turn this unit's power off then back on.
- If multiple partitions are set on the USB device, only the first partition can be used. (When rekordbox library information is present, the partition containing the rekordbox library information has priority.)
- USB devices equipped with flash card readers may not operate.
- Depending on the USB device you are using, the desired performance may not be achieved.

Playable music file formats

This unit supports music files in the formats shown below.

Type	File extension	Compatible formats	Bit depth	Bit rate	Sampling frequency	Encoding method
MP3	.mp3	MPEG-1 AUDIO LAYER-3	16 bit	32 kbps to 320 kbps	32 kHz, 44.1 kHz, 48 kHz	CBR, VBR
		MPEG-2 AUDIO LAYER-3	16 bit	8 kbps to 160 kbps	16 kHz, 22.05 kHz, 24 kHz	CBR, VBR
AAC	.m4a, .aac and .mp4	MPEG-4 AAC LC	16 bit	16 kbps to 320 kbps	16 kHz, 22.05 kHz, 24 kHz, 32 kHz, 44.1 kHz, 48 kHz	CBR, VBR
		MPEG-2 AAC LC	16 bit	16 kbps to 320 kbps	16 kHz, 22.05 kHz, 24 kHz, 32 kHz, 44.1 kHz, 48 kHz	CBR, VBR
WAV	.wav	WAV	16 bit, 24 bit	—	44.1 kHz, 48 kHz	Uncompressed PCM
AIFF	.aif, .aiff	AIFF	16 bit, 24 bit	—	44.1 kHz, 48 kHz	Uncompressed PCM

About MP3 files

MP3 files can have a constant bit rate (CBR) or a variable bit rate (VBR). Both types of files can be played on this unit, but the search and super fast search functions are slower with VBR files. If your priority is operability, we recommend recording MP3 files in CBR.

About AAC files

- AAC is the abbreviation of "Advanced Audio Coding", a basic format of audio compression technology used for MPEG-2 and MPEG-4.
- The file format and extension of AAC data depends on the application used to create the data.
- On this unit, in addition to AAC files encoded with iTunes® and with the extension ".m4a", files with the extensions ".aac" and ".mp4" files can also be played. However, AAC files that are copyright-protected, such as those purchased from the iTunes Store, cannot be played. Also, depending on the version of iTunes in which the file was encoded, it may not be possible to play the file.

About ID3 tags

The tag information types which can be registered from a music file are ID3 tags (v1, v1.1, v2.2.0, v2.3.0, and v2.4.0) or meta tags.

About music file artwork

The file format for artwork images that can be added to music files is JPEG (extensions: ".jpg" or ".jpeg").

- Files larger than 800 x 800 dots cannot be displayed.

About character displays

❖ CD-TEXT

This unit is compatible with CD-TEXT. Titles, album names and artist names recorded in CD-TEXT are displayed. When multiple text data is recorded, the first text data is displayed. The supported character codes are listed below.

- ASCII
- ISO-8859
- MS-JIS
- Mandarin Chinese character code

❖ MP3/AAC

When displaying track names, etc., to display characters written in local codes other than Unicode, change the [LANGUAGE] setting.

- ➔ *Changing the language* (p.38)

Functions usable in combination with a computer

About the included CD-ROM

This unit can be used in combination with a computer when the software is installed onto the computer from the included CD-ROM. The included CD-ROM contains the following two software programs.

❖ rekordbox (Mac/Windows) music management software

rekordbox is a software program allowing users who have purchased a Pioneer DJ player supporting rekordbox to manage music files to be used for DJ performances.

- rekordbox (Mac/Windows) may be used for classifying and searching for music files stored on your computer as well as creating playlists, all of which can help improve your DJ performance.
- rekordbox (Mac/Windows) allows the detecting, measuring, and editing of beats, tempos (BPM), and other elements of your music files prior to a performance.
- rekordbox (Mac/Windows) may be used to set and store detailed point information (for cueing, looping, hot cueing, etc.) prior to a performance.

Not only can various types of point information and playlists prepared with rekordbox be used for playback on Pioneer DJ players, the playback history, number of times played, point information, etc., can also be fed back to rekordbox after playback.

❖ Driver software

This driver software is an exclusive ASIO driver for outputting audio signals from the computer. To use this unit connected to a computer on which Windows is installed, install the driver software on the computer beforehand.

There is no need to install the driver software when using Mac OS X.

- For details, see *Installing the driver software* on page 39.

Software end user license agreement

This Software End User License Agreement ("Agreement") is between you (both the individual installing the Program and any single legal entity for which the individual is acting) ("You" or "Your") and PIONEER CORPORATION ("Pioneer").

TAKING ANY STEP TO SET UP OR INSTALL THE PROGRAM MEANS THAT YOU ACCEPT ALL OF THE TERMS OF THIS LICENSE AGREEMENT. PERMISSION TO DOWNLOAD AND/OR USE THE PROGRAM IS EXPRESSLY CONDITIONED ON YOUR FOLLOWING THESE TERMS. WRITTEN OR ELECTRONIC APPROVAL IS NOT REQUIRED TO MAKE THIS AGREEMENT VALID AND ENFORCEABLE. IF YOU DO NOT AGREE TO ALL OF THE TERMS OF THIS AGREEMENT, YOU ARE NOT AUTHORIZED TO USE THE PROGRAM AND MUST STOP INSTALLING IT OR UNINSTALL IT, AS APPLICABLE.

1 DEFINITIONS

- 1 "Documentation" means written documentation, specifications and help content made generally available by Pioneer to aid in installing and using the Program.
- 2 "Program" means all or any part of Pioneer's software licensed to You by Pioneer under this Agreement.

2 PROGRAM LICENSE

- 1 Limited License. Subject to this Agreement's restrictions, Pioneer grants to You a limited, non-exclusive, non-transferable, license (without the right to sublicense):
 - a To install a single copy of the Program in Your computer or mobile device, to use the Program only for Your personal purpose complying with this Agreement and the Documentation ("Authorized Use");

- b To use the Documentation in support of Your Authorized Use; and
 - c To make one copy of the Program solely for backup purposes, provided that all titles and trademark, copyright and restricted rights notices are reproduced on the copy.
- 2 Restrictions. You will not copy or use the Program or Documentation except as expressly permitted by this Agreement. You will not transfer, sublicense, rent, lease or lend the Program, or use it for third-party training, commercial time-sharing or service bureau use. You will not Yourself or through any third party modify, reverse engineer, disassemble or decompile the Program, except to the extent expressly permitted by applicable law, and then only after You have notified Pioneer in writing of Your intended activities.
 - 3 Ownership. Pioneer or its licensor retains all right, title and interest in and to all patent, copyright, trademark, trade secret and other intellectual property rights in the Program and Documentation, and any derivative works thereof. You do not acquire any other rights, express or implied, beyond the limited license set forth in this Agreement.
 - 4 No Support. Pioneer has no obligation to provide support, maintenance, upgrades, modifications or new releases for the Program or Documentation under this Agreement.

3 WARRANTY DISCLAIMER

THE PROGRAM AND DOCUMENTATION ARE PROVIDED "AS IS" WITHOUT ANY REPRESENTATIONS OR WARRANTIES, AND YOU AGREE TO USE THEM AT YOUR SOLE RISK. TO THE FULLEST EXTENT PERMISSIBLE BY LAW, PIONEER EXPRESSLY DISCLAIMS ALL WARRANTIES OF ANY KIND WITH RESPECT TO THE PROGRAM AND DOCUMENTATION, WHETHER EXPRESS, IMPLIED, STATUTORY, OR ARISING OUT OF COURSE OF PERFORMANCE, COURSE OF DEALING OR USAGE OF TRADE, INCLUDING ANY WARRANTIES OF MERCHANTABILITY, FITNESS FOR A PARTICULAR PURPOSE, SATISFACTORY QUALITY, ACCURACY, TITLE OR NON-INFRINGEMENT.

4 DAMAGES AND REMEDIES FOR BREACH

You agree that any breach of this Agreement's restrictions would cause Pioneer irreparable harm for which money damages alone would be inadequate. In addition to damages and any other remedies to which Pioneer may be entitled, You agree that Pioneer may seek injunctive relief to prevent the actual, threatened or continued breach of this Agreement.

5 TERMINATION

Pioneer may terminate this Agreement at any time upon Your breach of any provision. If this Agreement is terminated, You will stop using the Program, permanently delete it from your computer or mobile device where it resides, and destroy all copies of the Program and Documentation in Your possession, confirming to Pioneer in writing that You have done so. Sections 2.2, 2.3, 2.4, 3, 4, 5 and 6 will continue in effect after this Agreement's termination.

6 GENERAL TERMS

- 1 Limitation of Liability. In no event will Pioneer or its subsidiaries be liable in connection with this Agreement or its subject matter, under any theory of liability, for any indirect, incidental, special, consequential or punitive damages, or damages for lost profits, revenue, business, savings, data, use, or cost of substitute procurement, even if advised of the possibility of such damages or if such damages are foreseeable. In no event will Pioneer's liability for all damages exceed the amounts actually paid by You to Pioneer or its subsidiaries for the Program. The parties acknowledge that the liability limits and risk allocation in this Agreement are reflected in the Program price and are essential elements of the bargain between the parties, without which Pioneer would not have provided the Program or entered into this Agreement.
- 2 The limitations or exclusions of warranties and liability contained in this Agreement do not affect or prejudice Your statutory rights as consumer and shall apply to You only to the extent such limitations or exclusions are permitted under the laws of the jurisdiction where You are located.
- 3 Severability and Waiver. If any provision of this Agreement is held to be illegal, invalid or otherwise unenforceable, that provision will be enforced to the extent possible or, if incapable of enforcement, deemed to be severed and deleted from this Agreement,

and the remainder will continue in full force and effect. The waiver by either party of any default or breach of this Agreement will not waive any other or subsequent default or breach.

- 4 No Assignment. You may not assign, sell, transfer, delegate or otherwise dispose of this Agreement or any rights or obligations under it, whether voluntarily or involuntarily, by operation of law or otherwise, without Pioneer's prior written consent. Any purported assignment, transfer or delegation by You will be null and void. Subject to the foregoing, this Agreement will be binding upon and will inure to the benefit of the parties and their respective successors and assigns.
- 5 Entire Agreement. This Agreement constitutes the entire agreement between the parties and supersedes all prior or contemporaneous agreements or representations, whether written or oral, concerning its subject matter. This Agreement may not be modified or amended without Pioneer's prior and express written consent, and no other act, document, usage or custom will be deemed to amend or modify this Agreement.
- 6 You agree that this Agreement shall be governed and construed by and under the laws of Japan.

Cautions on copyrights

rekordbox restricts playback and duplication of copyright-protected music contents.

- When coded data, etc., for protecting the copyright is embedded in the music contents, it may not be possible to operate the program normally.
- When rekordbox detects that coded data, etc., for protecting the copyright is embedded in the music contents, processing (playback, reading, etc.) may stop.

Recordings you have made are for your personal enjoyment and according to copyright laws may not be used without the consent of the copyright holder.

- Music recorded from CDs, etc., is protected by the copyright laws of individual countries and by international treaties. It is the full responsibility of the person who has recorded the music to ensure that it is used legally.
- When handling music downloaded from the Internet, etc., it is the full responsibility of the person who has downloaded the music to ensure that it is used in accordance with the contract concluded with the download site.

Cautions on installing rekordbox (Mac/Windows)

Read *Software end user license agreement* carefully before installing rekordbox.

- The included CD-ROM contains installation programs and operating instructions in the following 12 languages: English, French, German, Italian, Dutch, Spanish, Portuguese, Russian, Chinese (simplified characters), Chinese (traditional characters), Korean, Japanese.
- When using an operating system in any language besides the ones listed above, select **[English]** during the installation procedure.

Supported operating systems

Mac OS X (10.5.8 or later)		✓
Windows® 7 Home Premium/Professional/Ultimate	32-bit version	✓
	64-bit version	✓
Windows Vista® Home Basic/Home Premium/Business/Ultimate (SP2 or later)	32-bit version	✓
	64-bit version	✓
Windows® XP Home Edition/Professional (SP3 or later)	32-bit version	✓

❖ Minimum operating environment for rekordbox (Mac/Windows)

Check that the computer provides the operating environment described below before starting installation.

CPU	For Mac OS X	Macintosh computer equipped with a Dual-Core 1.6 GHz or greater Intel® processor
	For Windows® 7, Windows Vista® and Windows® XP	PC/AT compatible computer equipped with a Dual-Core 2.0 GHz or greater Intel® processor
Required memory	1 GB or more of RAM	
Hard disk	250 MB or more of free space (not including space for storing music files, etc.)	
Optical drive	Optical disc drive on which the CD-ROM can be read	
Sound	Audio output to speakers, headphones, etc. (internal or external audio device)	
Internet connection	For user registration and inquiries, use a web browser supporting 128-bit SSL (Safari 2.0 or greater, Internet Explorer® 6.0 or greater, etc.).	
USB port	A USB port for connection of a USB device (flash memory, hard disc, etc.) is required to transfer music files to the USB device.	
LAN port	To transfer music files to a Pioneer DJ player, an Ethernet LAN adapter (RJ45 port) is required for communicating with the DJ player.	

- Full functionality is not guaranteed on all computers, even those meeting the operating environment requirements described above.
- Even with the required memory capacity indicated for the operating environment above, in the cases described below the software may not provide full functionality and performance due to lack of memory. In this case, take the necessary measures to ensure sufficient free memory. We recommend adding extra memory in order to achieve stable performance.
 - When there are many tracks being managed in the rekordbox library
 - When resident programs and services are running
- Depending on the computer's power settings and other factors, the CPU and hard disk processing capacity may be insufficient. When using laptop computers in particular, always keep the AC power connected and adjust the computer's settings to maximize performance when using rekordbox.
- Note that problems may arise with the functionality of rekordbox depending on other software running on your computer.

Installing rekordbox (Mac/Windows)

Read *Cautions on installing rekordbox (Mac/Windows)* carefully before installing rekordbox.

❖ Installation procedure (Macintosh)

- Authorization of the computer's administrator is required to install and uninstall rekordbox.
Log on as the user which was set as the computer's administrator before installing.

1 When the CD-ROM is inserted into the computer's optical drive, the optical drive opens on the screen. Double-click the [CD_menu.app] icon.

- If the window containing the [CD_menu.app] icon is not displayed when the CD-ROM is inserted, use Finder to open the optical drive manually and double-click the [CD_menu.app] icon.

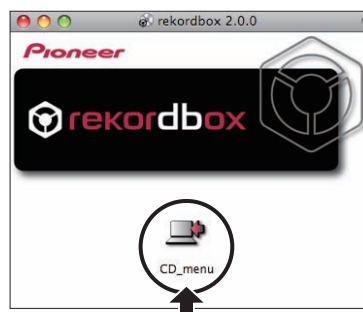

2 When the CD-ROM's menu is displayed, select [rekordbox: Install Music Management Software], then click [Start].

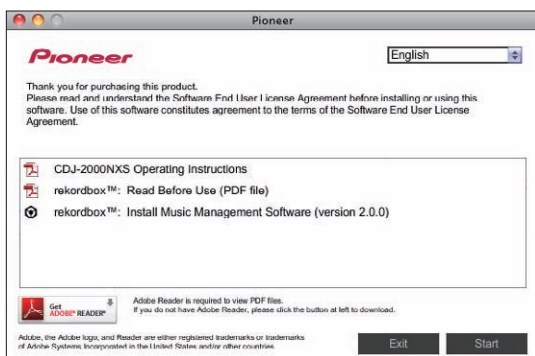

- To close the CD-ROM menu, click [Exit].

3 When the license agreement screen appears, select [English], read the *Software end user license agreement* carefully, then click [Continue].

- You can select the one you desire from multiple languages as long as the language is supported by the system environment of your computer.

4 If you agree to the *Software end user license agreement*, click [Agree].

- If you do not consent to the provisions of the *Software end user license agreement*, click [I disagree] and stop installation.

5 Install rekordbox by following the instructions on the screen.

❖ Installation procedure (Windows)

- Authorization of the computer's administrator is required to install and uninstall rekordbox.
Log on as the user registered as the computer's administrator before installing rekordbox (Mac/Windows).

1 Insert the CD-ROM into the computer's optical drive.

The CD-ROM menu is displayed.

- If the CD-ROM menu does not appear when the CD-ROM is inserted, open the optical drive from [Computer (or My Computer)] in the [Start] menu, then double-click the [CD_menu.exe] icon.

2 When the CD-ROM's menu is displayed, select [rekordbox: Install Music Management Software], then click [Start].

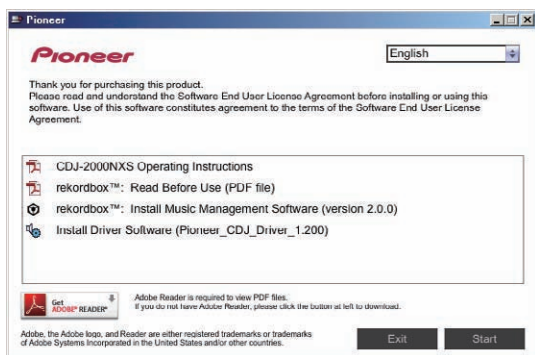

- To close the CD-ROM menu, click [Exit].

3 When the language selection screen appears, select [English] and click [OK].

- You can select the one you desire from multiple languages as long as the language is supported by the system environment of your computer.

4 When the license agreement screen appears, read the *Software end user license agreement* carefully. If you agree to the *Software end user license agreement*, click [Agree].

- If you do not consent to the provisions of the *Software end user license agreement*, click [Cancel] and stop installation.

5 Install rekordbox by following the instructions on the screen.

- Click [Cancel] to cancel installation after it has started.

Launching rekordbox (Mac/Windows)/ Viewing the Operating Instructions

Log on as the user which was set as the computer's administrator before using rekordbox.

- When rekordbox is started up for the first time, the license key must be entered. The license key is affixed to the CD-ROM package.

When rekordbox is started up, the operating instructions can be viewed from the rekordbox [Help] menu.

- The Online manual and online support site can be accessed if the computer is connected to the Internet.

❖ For Mac OS X

Open the [Application] folder with Finder, then double-click [rekordbox 2.x.x.app].

- The 2.x.x indicates the rekordbox version.

❖ For Windows® 7, Windows Vista® and Windows® XP

Click on the Windows [Start] menu button, then [All Programs] > [Pioneer] > [rekordbox 2.x.x] > [rekordbox 2.x.x].

- The 2.x.x indicates the rekordbox version.

Installing rekordbox (iOS/Android)

Install rekordbox (iOS/Android) on the mobile device (smartphone, tablet device, etc.). For instructions on installation and supported operating system versions, see our website (<http://www.rekordbox.com>).

Using the online support site

Before making inquiries on rekordbox operating procedures or technical issues, read the rekordbox (Mac/Windows) operating instructions and online manual and check the FAQ provided on the rekordbox online support site.

<rekordbox online support site>

<http://www.rekordbox.com>

- User registration on the rekordbox online support site is required prior to making inquiries concerning rekordbox.
- You will need to enter your license key during user registration, so please have it handy. Also, be sure not to forget the login name (your e-mail address) and the password specified for your user registration, as well as the license key.
- PIONEER CORPORATION collects your personal information for the following purposes:
 - 1 To provide customer support for your purchased product
 - 2 To inform you of product or event information by e-mail
 - 3 To obtain feedback collected by survey for product planning purposes— Your personal information is kept confidential corresponding to the privacy policy set forth by our company.
— Pioneer's privacy policy can be viewed on the rekordbox online support site.

- When making inquiries regarding rekordbox, please be sure to furnish your computer type and specifications (CPU, installed memory, other connected peripherals, etc.), the operating system and version used, as well as concrete information regarding the issue at hand.
 - To inquire about configuring your computer with non-Pioneer peripheral devices and to obtain the corresponding technical support, contact the specific manufacturer or retailer.
- Further version updates are anticipated for improved functionality and performance of rekordbox. Update programs will be available for download on the rekordbox online support site. We strongly recommend you perform these updates and always use the latest version of rekordbox.

Connections

- Be sure to turn off the power and unplug the power cord from the power outlet whenever making or changing connections.
- Refer to the operating instructions for the component to be connected.
- Connect the power cord after all the connections between devices have been completed.

- When using a LAN cable for connection, be sure to use either the LAN cable included with this product or an STP (shielded twisted pair) cable.
- Do not disconnect the LAN cable when music files and/or information are being shared using PRO DJ LINK.

Descriptions of terminals

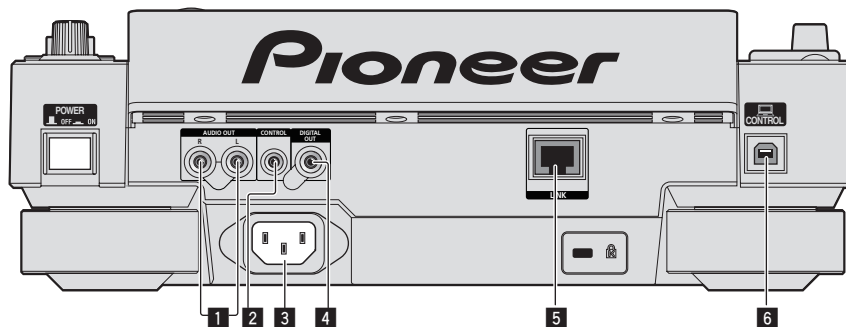

1 AUDIO OUT L/R terminals

Connect the audio cables (included) here.

2 CONTROL terminal

This is used to interconnect DJ players with a monaural mini phone plug (Ø 3.5 mm) cable (commercially available) to send control signals for relay playback.

➡ *Connections for relay play* (p.15)

3 AC IN

Connect this to a power outlet.

Connect the power cord after all the connections between devices have been completed.

Be sure to use the included power cord.

4 DIGITAL OUT terminal

Connect a digital coaxial cable here.

5 LINK terminal

Connect the LAN cable (included) here.

6 USB port

Connect to a computer.

⚠ CAUTION

Operating the switches on this unit or the remote control (if supplied) may turn off all the indicators as if the power plug were unplugged. However, this conforms to the intended specifications and the power supply is not disconnected. To shut off the power supply completely, you need to unplug the power plug (a power disconnecting device) from an AC outlet. Place this unit near an AC outlet with easy access to the power plug (a power disconnecting device). Unplug the power plug from an AC outlet when this unit will be left unused for a prolonged period. Otherwise, it may cause a fire.

Basic style

Playback on this unit is performed mainly using tracks prepared with rekordbox installed on a computer.

- For instructions on operating rekordbox, see rekordbox (Mac/Windows)'s operating instructions. The rekordbox (Mac/Windows) operating instructions can be viewed from the rekordbox (Mac/Windows) [Help] menu.
- Also, for DJ players and DJ mixers, up to four PRO DJ LINK-compatible players can be connected with LAN cables (CAT5e) using PRO DJ LINK connections.
- A switching hub (commercially available) may be necessary, depending on the combination of models used. Use a switching hub of 100 Mbps or greater. Some switching hubs may not operate properly.
- A switching hub (commercially available) is necessary to connect to a mixer equipped with only one LAN port. For mixers with enough LAN ports for all the DJ players and computers in the system, connect directly to the LAN ports on the mixer's rear panel, without using a hub.
- Use a wireless router (commercially available) and access point (commercially available) conforming to either IEEE802.11n or IEEE802.11g standards. Depending on the signal conditions in the usage environment and the wireless router or access point, PRO DJ LINK connections may not operate properly.

Connecting to a mixer with only one LAN port

When connecting to a mixer with only one LAN port using a switching hub, in order to use rekordbox's music file management functions to their maximum, set the channel number of the mixer to which the audio or coaxial digital cable is connected and the player number displayed at the bottom left of the main unit display to the same number.

(Ex.: When the audio cable is connected to channel 1)

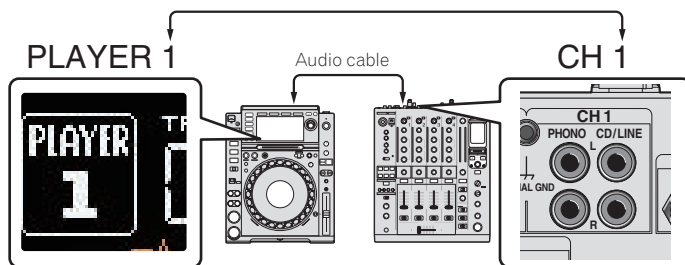

To change the player number, follow the procedure below.

- ① Disconnect the storage device (SD, USB) and LAN cable.
- ② Press the **[MENU/UTILITY]** button for over 1 second to display the **[UTILITY]** screen.
- ③ Turn the rotary selector to select **[PLAYER No.]**, then press the rotary selector.
- ④ Turn the rotary selector to select the player number, then press the rotary selector to enter it.



- ⑤ Press the **[MENU/UTILITY]** button to complete the setting.

PRO DJ LINK (SD & USB Export)

- rekordbox music files and data can be exchanged with this unit using a memory device (flash memory, hard disk, etc.), eliminating the need to take a computer into the DJ booth. Such information as playlists, cues, loops and hot cues set in advance with rekordbox can be used for playback.

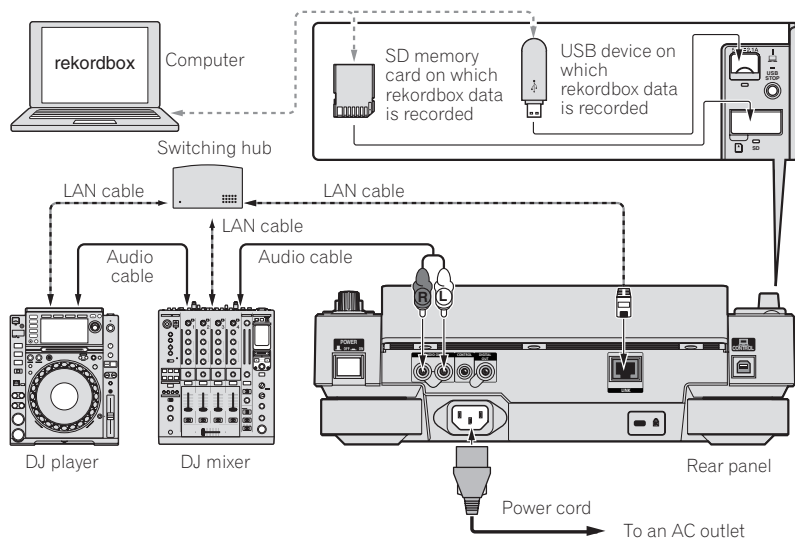

PRO DJ LINK (LINK Export)

- Tracks in rekordbox can be selected and played when the computer is taken into a DJ booth and connected to a computer on which rekordbox is installed by LAN cable (CAT5e) or wireless LAN (Wi-Fi) router. Performances can be held using such information as playlists, cues, loops and hot cues that have been set ahead of time with rekordbox.
- Tracks in rekordbox can be selected and played when connected to a mobile device on which rekordbox (iOS/Android) is installed by USB cable or wireless LAN (Wi-Fi) router. Performances can be held using such information as playlists, cues, loops and hot cues that have been set ahead of time with rekordbox.
- With wired LAN connections, up to two computers on which rekordbox is installed can be connected.
- With wireless LAN (Wi-Fi) connections, up to four computers or mobile devices on which rekordbox is installed can be connected.

iPods/iPhones/iPads that can be connected to this product

- This product supports iPod touch (3rd and 4th generation), iPhone 4S, iPhone 4, iPhone 3GS, iPad (3rd generation), iPad 2 and iPad.
- Visit the Pioneer webpage (<http://pioneerdj.com/support/>) for the latest compatibility information.

❖ Using a switching hub

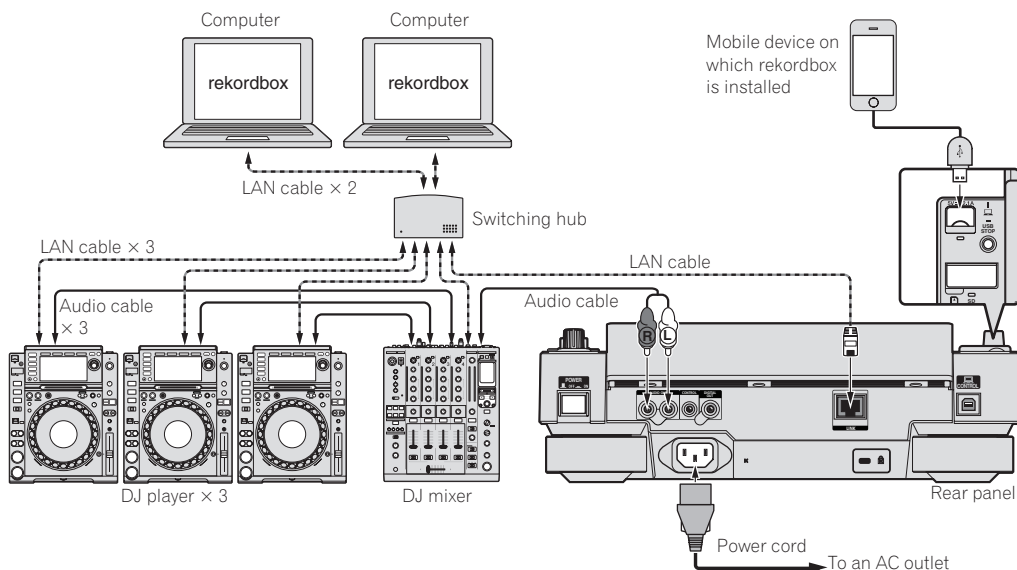

- Use the iPod cable included with this product to connect an iPod, iPhone or iPad to this product.
- A switching hub (commercially available) is necessary to connect to a mixer equipped with only one LAN port. For mixers with enough LAN ports for all the DJ players and computers in the system, connect directly to the LAN ports on the mixer's rear panel, without using a hub.

❖ Using a wireless router and access points

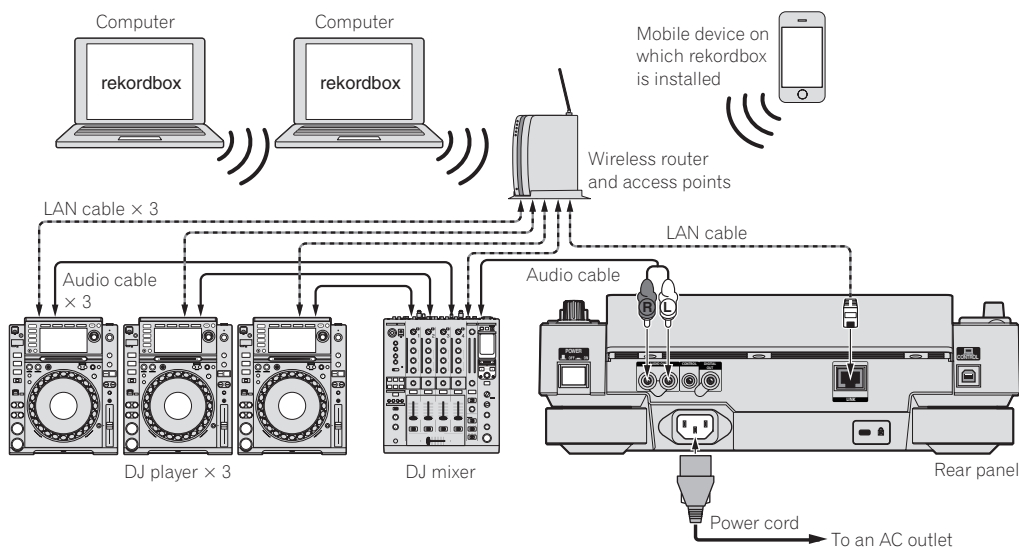

Cautions

To use rekordbox's music file management functions to their maximum, set the channel of the audio or coaxial digital input cable connected to the mixer and the player number to the same number.

If the player number is different, change the [PLAYER No.] setting on the [UTILITY] screen.

- When a storage device is connected to this unit, [PLAYER No.] is displayed in gray and cannot be changed. Disconnect the storage device or LAN cable to turn the link off, then change the setting.

Using other brands of DJ software

With this unit, the operating information of the buttons, tempo adjustment dial, etc., can also be output in universal MIDI format. When connected by USB cable to a computer on which MIDI-compatible DJ software is installed, the DJ software can be operated from the CDJ-2000NXS. The sound of music files being played on the computer can also be output from the CDJ-2000NXS. For details, see *About the driver software (Windows)* on page 39 and *Using other brands of DJ software* on page 41.

- Connect to a computer on which Mac OS X (10.5.8 or later), Windows Vista®, Windows® XP or Windows 7 is installed.

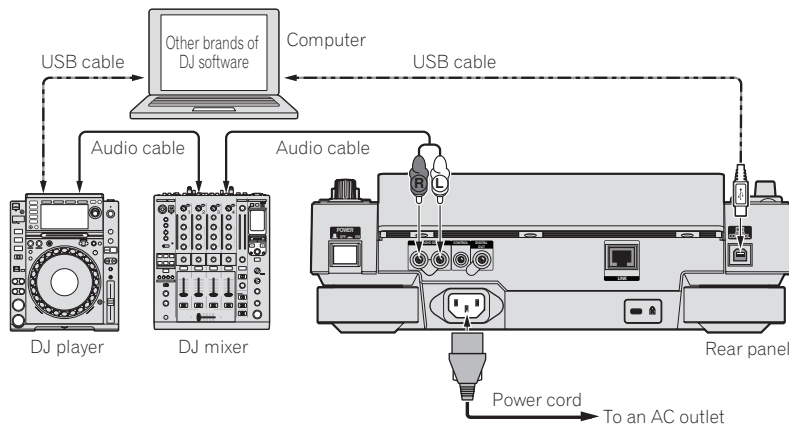
**Connections for relay play**

When this unit and a Pioneer DJ player are interconnected with their [CONTROL] terminals using a mini phone plug cable (Ø 3.5 mm), relay playback between the two DJ players is possible (page 31).

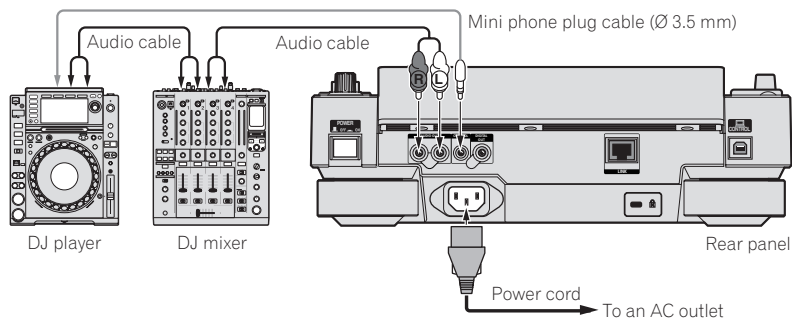

Part names and functions

Control panel

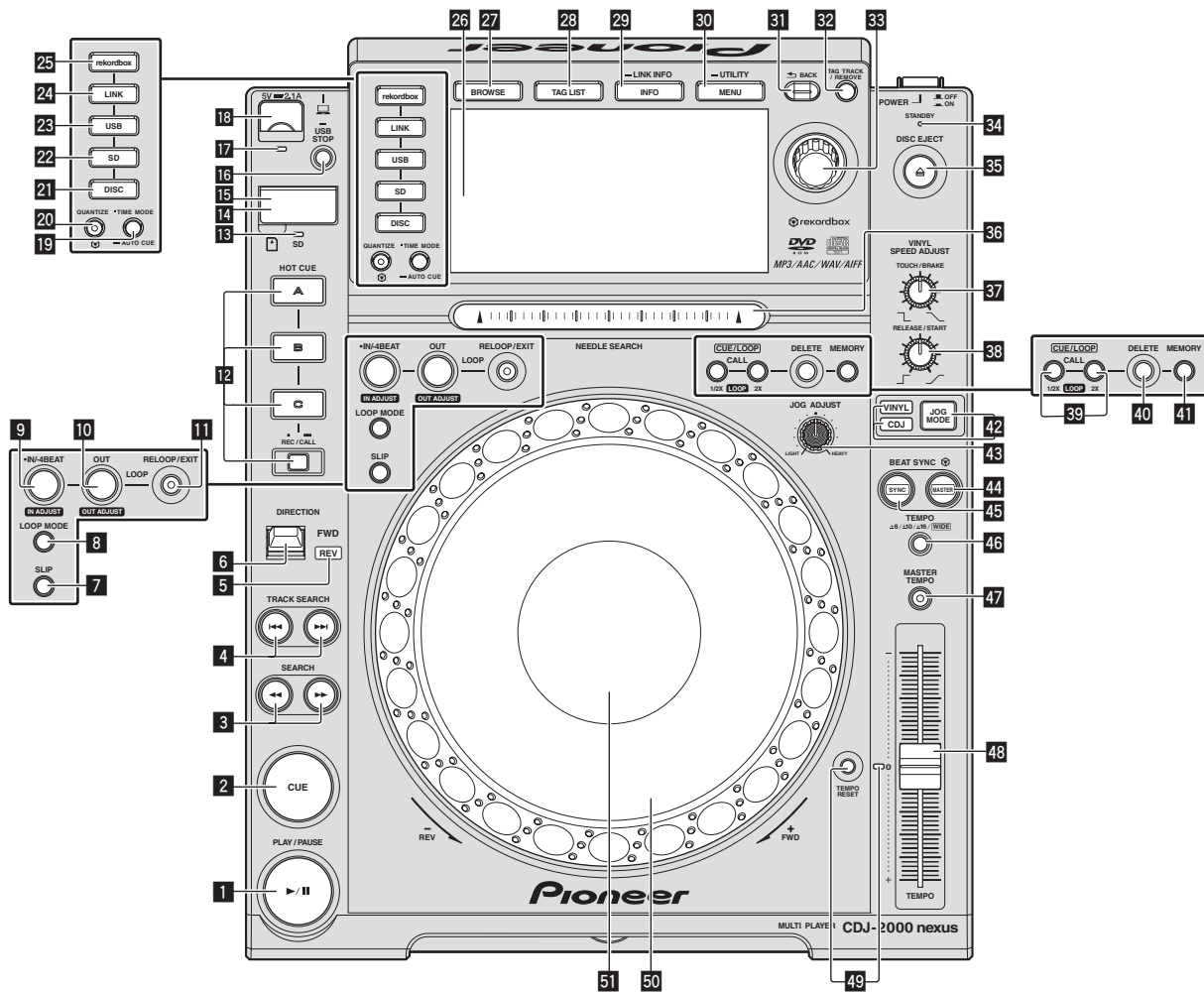

1 PLAY/PAUSE ►/II button

This lights when playing tracks and flashes when in the pause mode.
 ⇨ *Pausing* (p.24)

2 CUE button

This lights when a cue point is set (except during track searching), and flashes when a new cue point can be set in the pause mode.
 ⇨ *Setting Cue* (p.26)

3 SEARCH ◀◀, ▶▶ buttons

The track is forwarded/reversed while the button is held in.
 ⇨ *Forward and reverse scanning* (p.24)

4 TRACK SEARCH ◀◀◀, ▶▶▶ buttons

Use these to search for the beginnings of tracks.
 ⇨ *Finding the beginnings of tracks (Track Search)* (p.24)

5 REV indicator

This lights when playing in the reverse direction.
 ⇨ *Playing in reverse* (p.25)

6 DIRECTION FWD REV lever

Use this to turn reverse playback on and off.
 ⇨ *Playing in reverse* (p.25)

7 SLIP button

⇨ *Using the slip mode* (p.29)

8 LOOP MODE button

⇨ *Setting the loop automatically based on the track's tempo (Auto Beat Loop)* (p.27)

9 IN/4BEAT (IN ADJUST) button

Use this to set and fine-adjust the loop in point.
 ⇨ *Setting Loop* (p.26)

10 LOOP OUT (OUT ADJUST) button

Use this to set and fine-adjust the loop out point.
 ⇨ *Setting Loop* (p.26)

11 RELOOP/EXIT button

Use this to return to loop playback (reloop) or cancel loop playback (loop exit).
 ⇨ *Returning to Loop playback (Reloop)* (p.27)

12 HOT CUE (A, B, C, REC/CALL) buttons

Use this to set, play and call out hot cues.
 ⇨ *Setting Hot Cue* (p.27)

13 SD memory card indicator

This flashes when communicating with the SD memory card.

↪ *Inserting and ejecting SD memory cards* (p.22)

14 SD memory card door

Open and close this door to insert or remove SD memory cards.

↪ *Inserting and ejecting SD memory cards* (p.22)

15 SD memory card insertion slot

Load SD memory cards here.

↪ *Inserting and ejecting SD memory cards* (p.22)

16 USB STOP button

Press for at least 2 seconds before disconnecting the USB device.

↪ *Connecting and disconnecting USB devices* (p.23)

17 USB indicator

This flashes when this unit is communicating with the USB device.

↪ *Connecting and disconnecting USB devices* (p.23)

18 USB device insertion slot

Load the USB device here.

↪ *Connecting and disconnecting USB devices* (p.23)

19 TIME MODE/AUTO CUE button

When pressed once, the main unit display's time display mode (remaining time display or elapsed time display) switches.

When pressed for over 1 second, auto cue turns on and off.

↪ *Setting auto cue* (p.26)

20 QUANTIZE button

Press this to use the quantize function.

When the quantize function is set to on, points are automatically set to the nearest beat position when setting loop in points, loop out points, hot cues and cues.

Also, the hot cue, loop, reverse and slip functions can be used without breaking the beat.

- When the quantize function is set to on, [QUANTIZE] is displayed on the main unit display.

↪ *Main unit display* (p.20)

The quantize function does not work in the following situations ([QUANTIZE] is displayed in gray):

- When playing tracks recorded on discs
- When playing music files that have not been analyzed with rekordbox

21 DISC button

Press this to play music files on CDs, CD-ROMs or DVD-ROMs.

↪ *Playing media connected to or inserted in this unit* (p.23)

22 SD button

Press this to play music files on the SD memory card.

↪ *Playing media connected to or inserted in this unit* (p.23)

23 USB button

Press this to play the music files on a USB device.

↪ *Playing media connected to or inserted in this unit* (p.23)

24 LINK button

Press this to play music files on storage device (SD, USB) loaded in other DJ players.

↪ *Playing storage devices (SD, USB) of other players and mobile devices on which rekordbox is installed* (p.23)

25 rekordbox button

Press this to play music files in rekordbox.

↪ *Playing the rekordbox library on a computer or mobile device* (p.24)

26 Main unit display

The screen switches to the normal playback screen when the [BROWSE], [TAG LIST] and [INFO/LINK INFO] buttons are all turned off.

↪ *Main unit display* (p.20)

27 BROWSE button

Press this to display the [BROWSE] screen.

↪ *Switching to the browse screen* (p.31)

28 TAG LIST button

Press this to display the [TAG LIST] screen.

↪ *Editing tag lists* (p.34)

29 INFO/LINK INFO button

Press this to display the [INFO] screen.

When pressed for over 1 second, the details of the tracks loaded in the DJ player are displayed.

↪ *Displaying the details of the currently loaded track* (p.36)

30 MENU/UTILITY button

When pressed once, the menu screen is displayed.

The [UTILITY] screen is displayed when this is pressed for over 1 second.

↪ *Displaying the [UTILITY] screen* (p.37)

31 BACK button

Press this once to return to the previous screen.

Press for over 1 second to move to the top layer.

↪ *Playing media connected to or inserted in this unit* (p.23)

32 TAG TRACK/REMOVE button

Use these to add and remove tracks from the tag list.

↪ *Editing tag lists* (p.34)

33 Rotary selector

When selecting tracks or setting items, the cursor moves when the rotary selector is turned. Press the rotary selector to enter.

34 STANDBY indicator

This lights when in the standby mode.

↪ *Setting the auto standby mode* (p.38)

35 DISC EJECT button

Use this to eject discs.

↪ *Ejecting discs* (p.22)

36 NEEDLE SEARCH pad

The sound is played from the position at which the pad is touched.

↪ *Playing from the point touched on the [NEEDLE SEARCH] pad* (p.30)

37 VINYL SPEED ADJUST TOUCH/BRAKE control

This adjusts the speed at which playback stops when the top of the jog dial is pressed.

↪ *Adjusting the speed at which playback stops* (p.25)

38 VINYL SPEED ADJUST RELEASE/START control

This adjusts the speed at which playback returns to the normal speed when the top of the jog dial is released.

↪ *Adjusting the speed at which the normal playing speed is reached* (p.25)

39 CUE/LOOP CALL ◀(LOOP 1/2X), ▶(LOOP 2X) buttons

Use these to call out stored cue and loop points.

↪ *Calling out stored cue or loop points* (p.28)

When pressed during loop playback, the loop is cut or extended.

↪ *Cutting loops (Loop Cut)* (p.27)

↪ *Extending loops (loop doubling)* (p.27)

40 DELETE button

Use this to delete cue and loop points.

↪ *Deleting points individually* (p.28)

41 MEMORY button

Use this to store cue and loop points in the memory.

↪ *Storing cue or loop points* (p.28)

42 JOG MODE button, VINYL mode indicator and CDJ mode indicator

The mode switches between VINYL and CDJ each time this is pressed. The indicator for the selected mode lights.

↪ *Switching the jog dial mode* (p.25)

43 JOG ADJUST control

This adjusts the load applied when the jog dial is spun.

↪ *Adjusting the load when the jog dial is spun* (p.25)

44 BEAT SYNC MASTER button

Use this to set the track loaded in this unit as the master for the beat sync function.

➤ *Using the beat sync function* (p.31)

45 BEAT SYNC button

Use this to turn on the beat sync function.

➤ *Using the beat sync function* (p.31)

46 TEMPO ±6/±10/±16/WIDE button

Use this to switch the playing speed adjustment range.

➤ *Adjusting the playing speed (Tempo control)* (p.24)

47 MASTER TEMPO button

Use this to turn the master tempo function on and off.

➤ *Adjusting the playing speed without changing the pitch (Master Tempo)* (p.24)

48 TEMPO slider

Use this to adjust the track playing speed.

➤ *Adjusting the playing speed (Tempo control)* (p.24)

49 TEMPO RESET button and TEMPO RESET indicator

Use this to play the track at the original playing speed as recorded on the disc, etc., regardless of the position of the **TEMPO** slider. When the **TEMPO RESET** button is turned on, the indicator lights.

50 Jog dial (-REV/+FWD) and jog ring illumination

This can be used for such operations as scratching, pitch bending, etc.

➤ *Operating the jog dial* (p.25)

51 Jog dial display section

➤ *Jog dial display section* (p.21)

Rear panel

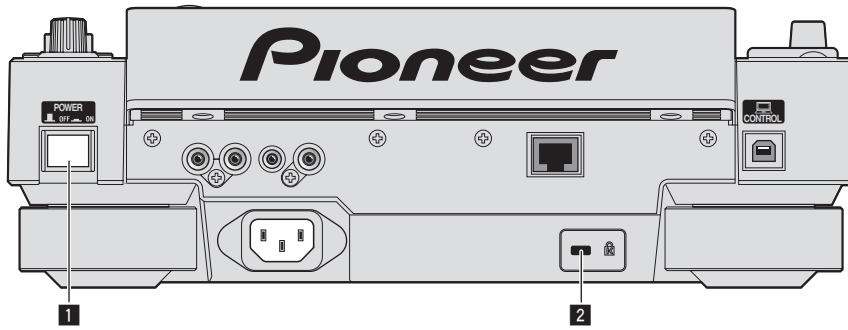

For the terminals used for connections, see *Descriptions of terminals* on page 12.

1 POWER ON/OFF button
Press to turn the power on and off.

2 Kensington security slot

Front panel

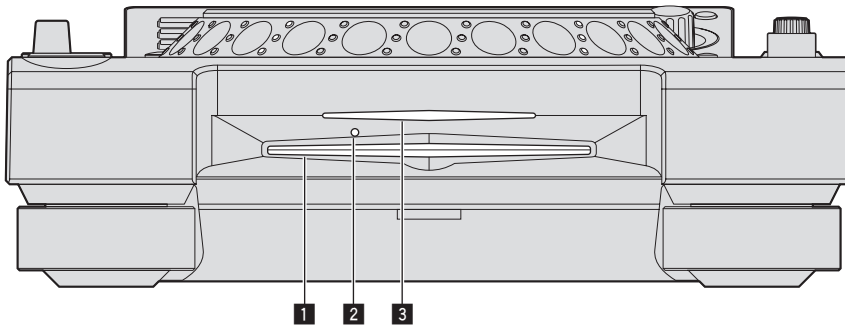

1 Disc insertion slot

2 Disc force eject pin insertion hole

3 Disc insertion slot indicator

About ejecting discs by force

- If the disc cannot be ejected by pressing the **[DISC EJECT▲]** button, the disc can be forcibly ejected by inserting the disc force eject pin into the disc force eject pin insertion hole on the main unit's front panel.
- When forcibly ejecting a disc, be sure to do so following the procedure below.

1 Press the [POWER ON/OFF] button to turn this unit's power off, then wait at least 1 minute.

Never forcibly eject a disc directly after turning off the set's power. Doing so is dangerous for the reasons described below.

The disc will still be spinning when ejected and could hit your fingers, etc., causing injury.

Also, the disc clamp will rotate in an unstable way, and the disc could get scratched.

2 Use the included disc force eject pin. (Do not use anything else.)

The included disc force eject pin is mounted on this unit's bottom panel. When the pin is inserted all the way into the insertion hole, the disc is ejected 5 mm to 10 mm out of the disc insertion slot. Grasp the disc with your fingers and pull it out.

Main unit display

Normal playback screen



1 CUE

The positions of cue points, loop points and hot cues are displayed as marks.

2 MEMORY

Cue points, loop points and hot cues stored on storage devices (SD, USB) are displayed as marks.

3 A. CUE

This lights when auto cue is set.
➡ *Setting auto cue* (p.26)

4 PLAYER

This indicates the player number (1 – 4) assigned to this unit.

5 TRACK

This indicates the track number (01 – 99).

6 REMAIN

This lights when the time display is set to the remaining time.

7 Information display section

The enlarged waveform analyzed with rekordbox, etc., is displayed here.

8 Track name

9 PHASE METER

This indicates the amount of divergence of the bars and beats with the master player when using the beat sync function.

10 BEAT COUNTDOWN

This indicates the number of bars or beats from the currently playing position to the nearest stored cue point.

11 KEY

Indicates the track's key.

12 ZOOM and GRID ADJUST mode display

When the rotary selector is pressed for over 1 second, the mode switches between the [ZOOM] mode and the [GRID ADJUST] mode.

- [ZOOM] mode: When the rotary selector is turned, the waveform is enlarged or reduced in 5 steps.
- [GRID ADJUST] mode: When the rotary selector is turned, the beat grid is adjusted.

The beat grid can be adjusted using the [MENU/UTILITY] button.

— [reset]: Resets the adjusted beat grid.

— [snap grid (CUE)]: Moves the first beat to the position of the currently set cue.

— [SHIFT GRID]: Reflects the results adjusted during synchronization (pitch bend, etc.) on the beat grid.

13 NEEDLE

This lights when needle searching is possible.

14 Time display (minutes, seconds and frames)

There are 75 frames to a second.

15 QUANTIZE

This is displayed when [QUANTIZE] is on.

16 MT

This lights when the master tempo is set.

➡ *Adjusting the playing speed without changing the pitch (Master Tempo)* (p.24)

17 BPM

Displays BPM (Beats Per Minute) of the track currently being played.

- The BPM measured by this unit may differ from the BPM indicated on the disc or that of a Pioneer DJ mixer, etc. This is due to the different methods used for measuring the BPM, and is not a malfunction.

18 Playing speed display

The value changes according to the position of the [TEMPO] slider.

19 Playing speed adjustment range display

This indicates the range in which the playing speed can be adjusted with respect to the original playing speed recorded on the medium.

20 WAVE display

This displays the WAVE display, guidance, etc.

21 Playing address display/scale display (1-minute intervals)

The track is displayed as a bar graph. The current playback position is displayed as a white vertical line. When the elapsed time is displayed, the left edge of the graph lights. When the remaining time is displayed, the display turns off from the left side. The entire graph flashes slowly when there are less than 30 seconds remaining in the track, then begins flashing rapidly when less than 15 seconds remain.

22 Cache meter

This indicates how much of the currently playing track is cached in the memory.

Jog dial display section

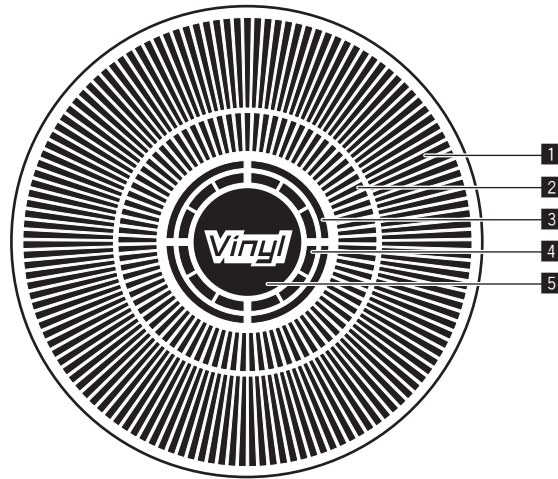

1 Operation display

This indicates the playing position, with one revolution equal to 135 frames. It turns during playback and stops in the pause mode.

2 Cue point display/slip play display

3 Audio memory status display

This flashes when the audio memory is being written. It stops flashing, remaining lit, when writing is completed. It may not be possible to perform the real time cue operation while the audio memory is being written. The display also flashes when there is not enough memory due to scratch play.

4 Jog touch detection display

When the jog mode is set to VINYL, the top of the jog dial lights when pressed.

5 VINYL

This lights when the jog mode is set to VINYL.

➔ *Operating the jog dial* (p.25)

Basic Operation

Turning the power on

1 Make all the connections, then plug the power cord into a power outlet.

➔ *Connections* (p.12)

2 Press the [POWER ON/OFF] button.

This unit's indicators light and the power turns on.

Turning the power off

Press the [POWER ON/OFF] button.

This unit's power turns off.

- Do not pull out the SD memory card or turn off this unit's power while the SD memory card indicator is flashing. Doing so could delete this unit's management data and damage the SD memory card, making it impossible to read.
- Do not disconnect the USB device or turn off this unit's power while the USB indicator is lit or flashing. Doing so could delete this unit's management data and damage the USB device, making it impossible to read.

Loading and ejecting discs

- This unit is a one-disc player. Do not insert multiple discs.
- Do not force discs into the disc insertion slot when this unit's power is off. Doing so could damage the disc and lead to malfunction of this unit.
- When the disc is being drawn in or ejected, do not apply any force to the disc in the direction opposite its movement. Doing so could damage the disc or this unit.

Inserting discs

1 Press the [POWER ON/OFF] button to turn on this unit's power.

2 Insert the disc horizontally into the disc insertion slot, with the printed surface facing up.

Playback starts after the medium's information has been read.

- When a disc containing music files recorded with a hierarchical structure is loaded, playback starts from the tracks in the uppermost layer.

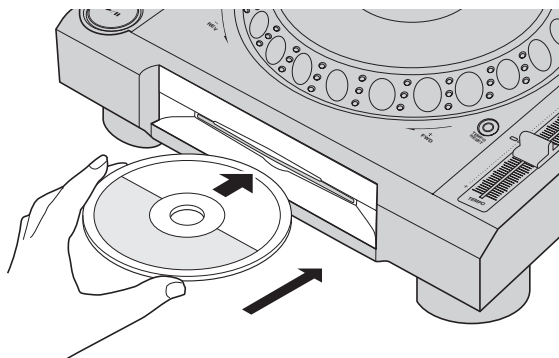

- When auto cue is turned on, the disc pauses at the audio start position. In this case, press the [PLAY/PAUSE>/II] to start playback.
➔ For details on auto cue, see *Setting auto cue* on page 26.
- When a disc is inserted while a storage device (SD, USB) that has previously been inserted into or connected to this unit or another

Pioneer DJ player is connected, the number of discs stored in the disc information memory is displayed for several seconds on the main unit display.

- ➔ For details on storing disc information, see *Procedure for calling out hot cues (for discs)* on page 28.

Ejecting discs

1 Press the [DISC EJECT▲] button to eject the disc.

The disc is ejected from the disc insertion slot.

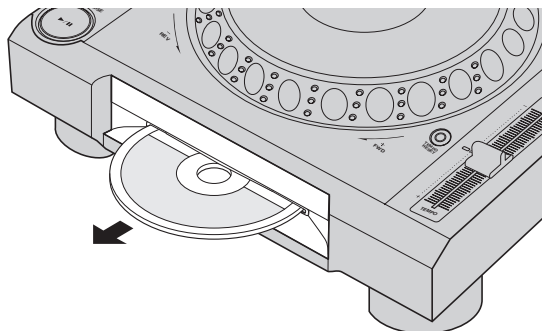

2 Pull the disc out, being careful not to scratch its signal surface.

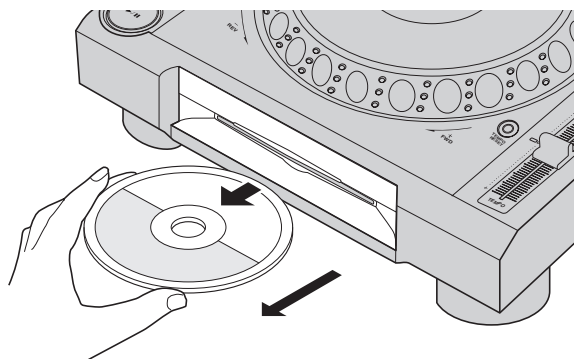

- If the [DISC EJECT▲] button is pressed accidentally, press the [PLAY/PAUSE>/II] button immediately. Disc ejection is canceled and the unit is reset to as it was directly before the [DISC EJECT▲] button was pressed. (No sound is output during the resetting process.)
- When [EJECT/LOAD LOCK] on the [UTILITY] menu is set to [LOCK], discs cannot be ejected during playback. Either set [EJECT/LOAD LOCK] to [UNLOCK] or press the [PLAY/PAUSE>/II] button to pause playback, then press the [DISC EJECT▲] button.

❖ About the resume function

If a disc is ejected during playback, when that same disc is reloaded, playback resumes from the point playing when the disc was ejected. If a disc is ejected while pausing, when that disc is reloaded, it pauses at the same point as when it was ejected. These points are stored in the memory until this unit's power is turned off or a different disc is loaded.

- This function does not work with storage devices (SD, USB).

Inserting and ejecting SD memory cards

- Do not insert any objects other than SD memory cards into the SD memory card insertion slot. Inserting coins or other metal objects could damage the internal circuitry, resulting in malfunction.
- Do not forcibly insert or remove SD memory cards. Doing so could damage the SD memory card or this unit.

Inserting SD memory cards

- 1 Press the [POWER ON/OFF] button to turn on this unit's power.
- 2 Open the SD memory card door.
- 3 Insert the SD memory card.
Insert the SD memory card vertically, with the back side facing forward and the notch facing down. Push the card in slowly until it stops.
- 4 Close the SD memory card door.

Ejecting SD memory cards

- 1 Open the SD memory card door.
The SD memory card indicator flashes for several seconds, then turns off.
 - Do not pull out the SD memory card or turn off this unit's power while the SD memory card indicator is flashing. Doing so could delete this unit's management data and damage the SD memory card, making it impossible to read.

- 2 Press the SD memory card in. When it pops back up, pull it out vertically.
- 3 Close the SD memory card door.

Connecting and disconnecting USB devices

Connecting USB devices

- 1 Press the [POWER ON/OFF] button to turn on this unit's power.
- 2 Connect the USB device to the USB device insertion slot.

Disconnecting USB devices

- 1 Press the [USB STOP] button until the USB indicator turns off.
Do not disconnect the USB device or turn off this unit's power while the USB indicator is lit or flashing. Doing so could delete this unit's management data and damage the USB device, making it impossible to read.
- 2 Disconnect the USB device.

Playback

This section describes basic track selection operations and how to switch the screen.

- *Playing storage devices (SD, USB) of other players and mobile devices on which rekordbox is installed* (p.23)
- *Playing the rekordbox library on a computer or mobile device* (p.24)

Playing media connected to or inserted in this unit

- 1 Load the medium in this unit.
 - *Inserting discs* (p.22)
 - *Inserting SD memory cards* (p.23)

- *Connecting USB devices* (p.23)

2 Press the corresponding medium button ([DISC], [SD] or [USB]).

The tracks or folders are displayed on a list.

The medium whose contents are displayed on the main unit display can be switched.

[DISC] button: Displays the contents on the inserted disc.

[SD] button: Displays the contents on the inserted SD memory card.

[USB] button: Displays the contents of the connected USB or mobile device.

- For details on the [LINK] button, see *Playing storage devices (SD, USB) of other players and mobile devices on which rekordbox is installed* on page 23.
- For details on the [rekordbox] button, see *Playing the rekordbox library on a computer or mobile device* on page 24.
- If the storage device (SD, USB) contains rekordbox library information, the rekordbox library is displayed.
 - For details on rekordbox library browsing, see *Playing the rekordbox library on a computer or mobile device* on page 24.

3 Turn the rotary selector.

Move the cursor and select the item.

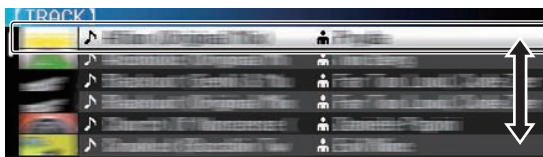

- Press the rotary selector to move to a lower level in the folder. Press the [BACK] button to return to the level above.
- When the [BACK] button is pressed for over 1 second or the medium button for the medium being browsed is pressed, the display moves to the topmost level.
- Tracks in the currently playing track's category/folder of can also be selected using the [TRACK SEARCH ◀▶] buttons.

4 Select the track and press the rotary selector.

When the track is loaded, the screen switches to the normal playback screen.

The track is loaded, playback starts, and the corresponding medium button flashes.

- For details on the normal playback screen, see *Main unit display* on page 20.
- When [EJECT/LOAD LOCK] on the [UTILITY] menu is set to [LOCK], it is not possible to load other tracks during playback. Either set [EJECT/LOAD LOCK] to [UNLOCK] or press the [PLAY/PAUSE ▶/II] button to pause, then load the track.
- When a track has been loaded while pausing, press the [PLAY/PAUSE ▶/II] button to start playback.
- When auto cue is turned on, the disc pauses at the audio start position. In this case, press the [PLAY/PAUSE ▶/II] to start playback.
 - For details on auto cue, see *Setting auto cue* on page 26.

Playing storage devices (SD, USB) of other players and mobile devices on which rekordbox is installed

Display the contents of the storage device (SD, USB) or of the mobile device on which rekordbox is installed that is connected to the other player connected to this unit by PRO DJ LINK on this unit's screen.

- The information of discs inserted on other players cannot be browsed.

1 Connect the storage device (SD, USB) or mobile device on which rekordbox is installed to the other player connected to this unit by PRO DJ LINK.

2 Press the [LINK] button.

The tracks and/or folders on the storage device (SD, USB) or mobile device on which rekordbox is installed that is connected to the other player are displayed.

- When multiple media are connected, a screen for selecting the medium appears.
- If the storage device (SD, USB) contains rekordbox library information, the rekordbox library is displayed.
 - For details on rekordbox library browsing, see *Playing the rekordbox library on a computer or mobile device* on page 24.

3 Turn the rotary selector.

Move the cursor and select the item.

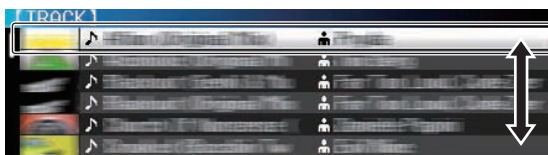

4 Select the track and press the rotary selector.

When the track is loaded, the screen switches to the normal playback screen.

The track is loaded, playback starts, and the corresponding medium button flashes.

- For details on the normal playback screen, see *Main unit display* on page 20.

❖ If the medium contains the rekordbox library

If the SD memory card or USB device inserted into/connected to this unit or another player connected by PRO DJ LINK contains rekordbox library information, the rekordbox library is displayed.

- Music files are displayed in the categories (album, artist, etc.) set with rekordbox.
- The types of items on the category menu can be changed in rekordbox's preferences.

Playing the rekordbox library on a computer or mobile device

Music files are displayed in the categories (album, artist, etc.) set with rekordbox.

1 Press the [rekordbox] button.

The rekordbox library is displayed on this unit's main unit display.

- With wireless LAN (Wi-Fi) connections, if [Please push the rotary selector to permit mobile connection.] appears on this unit's main unit display when connecting, connection is possible by pressing the rotary selector.
- To select a mobile device connected by USB, press the [USB] button. Also, to select a mobile device connected to another player that is connected by PRO DJ LINK, press the [LINK] button.

2 Turn the rotary selector.

Move the cursor and select the item.

3 Select the track and press the rotary selector.

When the track is loaded, the screen switches to the normal playback screen.

The track is loaded, playback starts, and the corresponding medium button flashes.

- For details on the normal playback screen, see *Main unit display* on page 20.

Load previous tracks

The names of the last five tracks that were played are displayed and can be selected.

1 Display the normal playback screen.

2 Press the [MENU/UTILITY] button.

3 Turn the rotary selector to select the track, then press the rotary selector to set playback.

- The display of the track names is canceled by pressing the [MENU] or [BACK] button.

Pausing

During playback, press the [PLAY/PAUSE ►/II] button.

The [PLAY/PAUSE ►/II] and [CUE] buttons flash. When the [PLAY/PAUSE ►/II] button is pressed again, playback resumes.

- When tracks have been loaded from a disc, the disc automatically stops spinning if no operation is performed for 100 minutes while in the pause mode.

Forward and reverse scanning

Press one of the [SEARCH ◀◀, ▶▶] buttons.

The track is scanned in the forward or reverse direction while one of the [SEARCH ◀◀, ▶▶] buttons is pressed.

- It is not possible to move to a different category or folder during forward or reverse scanning.

Finding the beginnings of tracks (Track Search)

Press one of the [TRACK SEARCH I◀◀, ▶▶I] buttons.

Press the [▶▶I] to move to the beginning of the next track.

When [I◀◀] is pressed, playback returns to the beginning of the currently playing track. When pressed twice in a row, playback returns to the beginning of the previous track.

- It is not possible to move to a different category or folder with the track search function.

Adjusting the playing speed (Tempo control)

Press the [TEMPO ±6/±10/±16/WIDE] button.

The [TEMPO] slider's adjustment range switches each time the button is pressed. The adjustment range setting is indicated on the main unit display.

Setting value	Units of adjustment
±6	0.02 %
±10	0.05 %
±16	0.05 %
WIDE	0.5 %

The [WIDE] adjustment range is ±100 %. When set to -100 %, playback stops.

- The adjustment range is set to ±10 % when the power is turned on.

Move the [TEMPO] slider forward or backward.

The tempo increases when moved to the [+] side (down), decreases when moved to the [-] side (up). The rate at which the playing speed is changed is indicated on the playing speed display.

Adjusting the playing speed without changing the pitch (Master Tempo)

Press the [MASTER TEMPO] button.

The [MASTER TEMPO] button and [MT] indicator on the main unit display light.

Move the [TEMPO] slider forward or backward.

The pitch does not change even when the playing speed is changed with the [TEMPO] slider.

- The sound is digitally processed, so the sound quality decreases.

Playing in reverse

- When the quantize function is on, there may be a slight delay in operation of this function in order to synchronize the beat.

Move the [DIRECTION FWD/REV] lever to the [REV] side.
The [REV] indicator lights and the track is played in the reverse direction.

- When the music files are recorded in a folder structure, only tracks within the same category/folder can be played in reverse. Also note that reverse playback may not start immediately.
- The direction in which the playing speed is increased or decreased according to the direction in which the jog dial is turned is reversed.
- When such operations as track searching and loop playback are performed during reverse playback, the audio memory status display on the jog dial display section flashes and scratch play may not be possible.

Operating the jog dial

- The top of the jog dial has an embedded switch. Do not place objects on the jog dial or subject it to strong forces.
- Water or other liquids getting into the set will lead to malfunction.

Switching the jog dial mode

Press the [JOG MODE] button.

The mode switches between VINYL and CDJ each time the button is pressed.

- VINYL mode: When the top of the jog dial is pressed during playback, playback stops, and when the jog dial is spun at this time sound is produced according to the direction in which the jog dial is spun.
- CDJ mode: Playback does not stop even when the top of the jog dial is pressed. Such operations as scratching cannot be performed.

Pitch bend

During playback, spin the outer section of the jog dial without touching the top.

The playing speed increases when spun clockwise, decreases when spun counterclockwise. When spinning is stopped, playback returns to the normal speed.

- When the jog mode is set to the CDJ mode, the same operation can be performed by spinning the top of the jog dial.

Adjusting the load when the jog dial is spun

Turn the [JOG ADJUST] control.

The load gets heavier when turned clockwise, lighter when turned counterclockwise.

Scratch

When the jog mode is set to the VINYL mode, tracks can be played according to the direction and speed at which the jog dial is spun by spinning the top of the jog dial while pressing it.

1 Press the [JOG MODE] button.

Set the jog mode to VINYL.

2 During playback, press the top of the jog dial.

Playback slows then stops.

3 Spin the jog dial in the desired direction and at the desired speed.

The sound is played according to the direction and speed at which the jog dial is spun by spinning the top of the jog dial while pressing it.

4 Release your hand from the top of the jog dial.

Normal playback resumes.

Frame search

In the pause mode, spin the jog dial.

The position at which the track is pausing can be moved in units of 0.5 frames.

- The position is moved in the direction of playback when the jog dial is spun clockwise, in the reverse direction when it is spun counterclockwise. The position moves 135 for one revolution of the jog dial.

Super fast search

Turn the jog dial while pressing one of the [SEARCH ◀▶] buttons.

The track is fast-forwarded/fast-reversed in the direction in which the jog dial is spun.

- When the [SEARCH ◀▶] button is released, this function is canceled.
- When you stop the jog dial from spinning, normal playback resumes.
- The fast-forward/fast-reverse speed can be adjusted according to the speed at which the jog dial is spun.

Super fast track search

Turn the jog dial while pressing one of the [TRACK SEARCH ◀▶] buttons.

The track is advanced at high speed in the direction in which the jog dial was turned.

Adjusting the playback and stopping speeds

Adjusting the speed at which playback stops

The speed at which playback stops when the top of the jog dial is pressed or when playback is stopped by pressing the [PLAY/PAUSE▶/II] button can be changed.

- This function is only valid when the jog mode is set to the VINYL mode.

Turn the [VINYL SPEED ADJUST TOUCH/BRAKE] control.

The speed increases when turned clockwise, decreases when turned counterclockwise.

Adjusting the speed at which the normal playing speed is reached

The speed at which the normal playing speed is reached when the top of the jog dial is released or when the [PLAY/PAUSE▶/II] button is pressed while pausing can be changed.

- This function is only valid when the jog mode is set to the VINYL mode.

Turn the [VINYL SPEED ADJUST RELEASE/START] control.

The speed increases when turned clockwise, decreases when turned counterclockwise.

Advanced Operation

Setting Cue

1 During playback, press the [PLAY/PAUSE ►/II] button.
Playback is paused.

2 Press the [CUE] button.

The point at which the track is paused is set as the cue point. The [PLAY/PAUSE►/II] indicator flashes and the [CUE] indicator lights. No sound is output at this time.

- When a new cue point is set, the previously set cue point is canceled.

Adjusting the cue point position

1 Press the [SEARCH ◀◀, ▶▶] buttons while pausing at the cue point.

The [PLAY/PAUSE►/II] and [CUE] indicators flash.

2 Press one of the [SEARCH ◀◀, ▶▶] buttons.

The cue point can be fine-adjusted in steps of 0.5 frames.

- The same operation is possible using the jog dial.

3 Press the [CUE] button.

The position at which the button was pressed is set as the new cue point.

- When a new cue point is set, the previously set cue point is canceled.

Returning to Cue Point (Back Cue)

During playback, press the [CUE] button.

The set immediately returns to the currently set cue point and pauses.

- When the [PLAY/PAUSE ►/II] button is pressed, playback starts from the cue point.

Checking Cue Point (Cue Point Sampler)

Keep pressing the [CUE] button after returning to the cue point.

Playback starts from the set cue point. Playback continues while the [CUE] button is pressed.

- If the [PLAY/PAUSE ►/II] button is pressed while sampling the cue, playback continues even if the [CUE] button is released.

Setting Cue Point during playback (Real Time Cue)

During playback, press the [IN/4BEAT (IN ADJUST)] button at the point at which you want to set the cue point.

The point at which the button was pressed is set as the cue point.

Setting auto cue

When a track is loaded or the track search operation is performed, the silent section at the beginning of the track is skipped and the cue point is automatically set at the point immediately before the sound starts.

Press the [TIME MODE/AUTO CUE] button for over 1 second.

[A. CUE] lights.

- When [TIME MODE (AUTO CUE)] is pressed again for at least 1 second, auto cue is set to off.

- The auto cue level setting remains in the memory, even when the power is turned off.

Setting Loop

This function can be used to play specific sections repeatedly.

- Loops that include sections in different tracks can only be set for tracks recorded on music CDs (CD-DA).
- When the quantize function is on, there may be a slight delay in operation of this function in order to synchronize the beat. (Reloop and auto beat loop only)

1 During playback, press the [IN/4BEAT (IN ADJUST)] button at the point at which you want to start loop playback (the loop in point).

Loop In Point is set.

- This operation is not necessary if you want to set the currently set cue point as the loop in point.

2 Press the [LOOP OUT (OUT ADJUST)] button at the point at which you want to end loop playback (the loop out point).

The loop out point is set, and loop playback begins.

Fine-adjusting the loop in point (loop in adjust)

1 During loop playback, press the [IN/4BEAT (IN ADJUST)] button.

The [IN/4BEAT (IN ADJUST)] button starts flashing rapidly, and the [LOOP OUT (OUT ADJUST)] button turns off.

The loop in point's time is displayed on the main unit display.

2 Press one of the [SEARCH ◀◀, ▶▶] buttons.

The loop in point can be adjusted in units of 0.5 frames.

- The same operation is possible using the jog dial.
- The loop in point's range of adjustment is ± 30 frames.
- The loop in point cannot be set at a point beyond the loop out point.

3 Press the [IN/4BEAT (IN ADJUST)] button.

Loop playback resumes.

- Normal loop playback also resumes if no operation is performed for over 10 seconds.

Fine-adjusting the loop out point (loop out adjust)

1 During loop playback, press the [LOOP OUT (OUT ADJUST)] button.

The [LOOP OUT (OUT ADJUST)] button starts flashing rapidly, and the [IN/4BEAT (IN ADJUST)] button turns off.

The loop out point's time is displayed on the main unit display.

2 Press one of the [SEARCH ◀◀, ▶▶] buttons.

The loop out point can be adjusted in units of 0.5 frames.

- The same operation is possible using the jog dial.
- The loop out point cannot be set at a point before the loop in point.

3 Press the [LOOP OUT (OUT ADJUST)] button.

Loop playback resumes.

- Normal loop playback also resumes if no operation is performed for over 10 seconds.

Canceling Loop playback (Loop Exit)

During loop playback, press the [RELOOP/EXIT] button.

Playback continues beyond the Loop Out Point without returning to the Loop In Point.

Returning to Loop playback (Re-loop)

After canceling loop playback, press the **[RELOOP/EXIT]** button during playback.

Playback returns to the previously set Loop In Point, and Loop playback resumes.

Setting loops automatically (4-beat Loop)

During playback, press the **[IN/4BEAT (IN ADJUST)]** button for over 1 second.

A loop of 4 beats starting from the point at which the button was pressed is set automatically according to the BPM of the currently playing track, and loop playback starts.

- If the track's BPM cannot be detected, the BPM is set to 130.

Cutting loops (Loop Cut)

During loop playback, press the **[CUE/LOOPCALL◀ (LOOP 1/2X)]** button.

The loop playing time is cut in half each time the button is pressed.

Extending loops (loop doubling)

During loop playback, press the **[CUE/LOOPCALL▶ (LOOP 2X)]** button.

The loop's length is doubled each time the button is pressed.

Setting the loop automatically based on the track's tempo (Auto Beat Loop)

A loop with the specified number of beats is set and loop playback starts.

1 During playback, press the [LOOP MODE] button.

The beat number selection screen appears on the main unit display.

- The beat select screen is also displayed when loops are set and when the slip function is turned on.

2 Touch the [NEEDLE SEARCH] pad at the position corresponding to the number of beats you want to set.

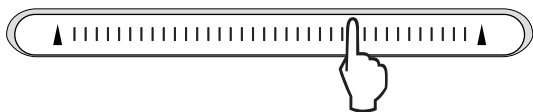

The marker below the number of beats at the touched position lights red, and loop playback with the selected number of beats begins.

3 Press the [LOOP MODE] button.

The beat number selection screen turns off.

- If the **[LOOP MODE]** button is pressed again while the beat number selection screen is displayed, the beat number selection screen turns off.
- The beat select screen also turns off when a track is loaded.
- When a track that has not been analyzed is playing, the loop is set according to the track's BPM.
- If the track's BPM cannot be detected, the BPM is set to 130.

Using active loops

1 Connect a storage device (SD, USB) to this unit.

2 Load a track for which an active loop has been set with rekordbox.

One loop stored in rekordbox can be set as the active loop.

The set active loop points are indicated on the waveform display as shown below.



When the set point is reached, the loop is set automatically and loop playback begins.

Emergency loops

With this unit, a 4-beat loop is set automatically to prevent the sound from being interrupted if a track can no longer continue to play.

- DJ playback is restricted during emergency looping. To cancel emergency looping, load the next track.

Setting Hot Cue

When a hot cue is set, that point can be called out and played instantaneously. Up to 3 hot cues can be set per music track.

- When the quantize function is on, there may be a slight delay in operation of this function in order to synchronize the beat.

1 Connect a storage device (SD, USB) to this unit.

2 Press the [HOT CUE] (REC/CALL) button.

The mode switches to the hot cue recording mode. **[HOT CUE] (A, B and C)** buttons light red.

3 During playback or in the pause mode, press [HOT CUE] (A, B or C) at the point at which you want to set the hot cue.

The point at which the button was pressed is set as the hot cue, and **[HOT CUE] (A, B, C and REC/CALL)** buttons flash.

- During loop playback, the loop is registered as a hot cue. The direction of playback is not recorded for hot cues. While the hot cue is being recorded, it is not possible to record other hot cues, to set cue points, to scan in the forward or reverse direction or to scratch.
- When a storage device (SD, USB) is connected to this unit, the point information is automatically stored on it.
- When a hot cue is set during scratch play, playback may stop temporarily.

Playing hot cues

1 Press the [HOT CUE] (REC/CALL) button.

The hot cue playing mode is set.

Button color when lit	Contents recorded as hot cue
Green	Cue Point
Orange	Loop
Not lit	Nothing is recorded.

2 During playback or in the pause mode, press [HOT CUE] (A, B or C).

The hot cue recorded at that button is called out and playback begins.

- Loop playback recorded at **[HOT CUE]** buttons differs in information from loop playback set using the **[IN/4BEAT (IN ADJUST)]** or **[LOOP OUT (OUT ADJUST)]** buttons.

- After calling out a loop stored at a [HOT CUE] button, loop playback can be canceled using the [RELOOP/EXIT] button and the loop in and out points can be fine-adjusted using the [LOOP IN(IN ADJUST)] and [LOOP OUT(OUT ADJUST)] buttons. The adjustment directly changes the information stored at the [HOT CUE] (A, B or C) button.

Calling out hot cues

❖ Procedure for calling out hot cues (for discs)

To call out hot cues using storage devices (SD, USB), the disc's hot cues must first be stored using the storage device (SD, USB).

1 Connect the storage device (SD, USB) on which the disc's hot cues are stored.

2 Load a disc in this unit.

The unit switches to the hot cue call-out mode and the [HOT CUE] (A, B and C) buttons at which hot cues are recorded flash.

3 Press the [HOT CUE] button (A, B or C) whose hot cue you want to call out.

The hot cue is called out, and the [HOT CUE] (A, B, C) button lights green or orange.

- If you do not want to call out a hot cue, press the [HOT CUE] (REC/CALL) button without pressing one of the [HOT CUE] (A, B or C) buttons. Buttons whose hot cues were not called out turn off.
- When playing tracks recorded on media other than discs, hot cues cannot be called out even when a disc for which hot cues are recorded is loaded in the this unit.
- If the hot cue call-out mode is cancelled accidentally, disconnect the storage device (SD, USB), then reconnect it.

❖ Call-out procedure (storage device (SD, USB))

1 Connect a storage device (SD, USB) to this unit.

2 Load the track whose hot cue you want to call out.

3 Press the [HOT CUE] (REC/CALL) button for over 1 second.

The unit switches to the hot cue call-out mode and the HOT CUE buttons (A, B and C) at which hot cues are recorded flash.

4 Press the [HOT CUE] button (A, B or C) whose hot cue you want to call out.

The hot cue is called out, and the [HOT CUE] (A, B, C) button lights green or orange.

- If you do not want to call out a hot cue, press the [HOT CUE] (REC/CALL) button without pressing one of the [HOT CUE] (A, B or C) buttons. Buttons whose hot cues were not called out turn off.
- If the hot cue call-out mode is cancelled accidentally, press the [HOT CUE] (REC/CALL) button again for more than 1 second.
- rekordbox can be preset so that hot cues are called out automatically when tracks are loaded.



- " " is displayed on the track list for tracks for which auto hot cue loading is set.

❖ Canceling the hot cue call out mode

Perform one of the operations below to cancel the hot cue call out mode. When tracks have been loaded from a disc, the hot cue call-out mode is not canceled even if the track being played is changed.

1 Calling out hot cues A, B and C.

2 Press the [HOT CUE] (REC/CALL) button.

3 Change the track to be played on the storage device (SD, USB).

Storing cue or loop points

1 Connect a storage device (SD, USB) to this unit.

2 Set Cue Point or Loop Point.

3 Press the [MEMORY] button.



[MEMORY] or [MEMORY] is displayed for several seconds on the main unit display, and the point information is stored on the storage device (SD, USB).

Stored cue and loop points are indicated [▼] at the top of the waveform display.



- When a track recorded on a disc is playing, if both an SD memory card and a USB device are connected, the point information is stored with priority on the SD memory card. The storage device can be selected using the [MENU] button. Devices connected to other DJ players connected by PRO DJ LINK can also be selected.
- To store loop points, press the [MEMORY] button during loop playback. The stored loop points are shown on the playing address display.

Calling out stored cue or loop points

1 Connect a storage device (SD, USB) to this unit.

2 Load the track whose cue or loop points you want to call out.

Stored cue and loop points are indicated [▼] at the top of the waveform display.

3 Press the [CUE/LOOP CALL ◀(LOOP 1/2X)] or [CUE/LOOP CALL ▶(LOOP 2X)] button.

Press [CUE/LOOP CALL ◀(LOOP 1/2X)] to call out a point before the currently playing position, [CUE/LOOP CALL ▶(LOOP 2X)] to call out a point after the currently playing position.

The track cues to the called out point and pauses.

- When multiple points are stored, a different point is called out each time the button is pressed.
- Loops set as active loops can also be called out as stored loops.

4 Press the [PLAY/PAUSE ▶/II] button.

Normal or loop playback starts from the point that was called out.

Deleting stored cue or loop points

Deleting points individually

1 Connect a storage device (SD, USB) to this unit.

2 Load the track containing the cue point or loop points you want to delete.

Stored cue and loop points are indicated [▼] at the top of the waveform display.

3 Press the [CUE/LOOP CALL ◀(LOOP 1/2X)] or [CUE/LOOP CALL ▶(LOOP 2X)] button to call out the point to be deleted.

The track cues to the called out point and pauses.

- When multiple points are stored, a different point is called out each time the button is pressed.

4 Press the [DELETE] button.

[ DELETE] or [ DELETE] is displayed on the main unit display, and the selected point information is deleted.

- When a stored loop set as an active loop is deleted, the active loop is also deleted.

Deleting points in units of discs

1 Load a disc in this unit.

When tracks from a medium other than a disc are loaded, load any track from the disc.

2 Connect a storage device (SD, USB) to this unit.

The cue or loop in point is displayed on the playing address display with a mark.

3 Press the [DELETE] button for over 5 second.

[DISC CUE/LOOP DATA-DELETE? PUSH MEMORY] appears on the main unit display.

4 Press the [MEMORY] button.

All cue and loop points for the disc currently loaded in this unit are deleted.

- The delete mode is canceled if any button other than [MEMORY] is pressed.

Deleting all the disc information stored on a storage device (SD, USB)

Connect the storage device (SD, USB) on which the disc information is stored to this unit.

1 With no disc loaded on this unit, press the [DELETE] button for over 5 seconds.

[DISC CUE/LOOP DATA-DELETE ALL? PUSH MEMORY] appears on the main unit display.

2 Press the [MEMORY] button.

All the disc information stored on the storage device (SD, USB) is deleted.

- The delete mode is canceled if any button other than [MEMORY] is pressed.

Setting the cue point for auto cueing

The cue point to be set as the auto cue can be selected using one of the methods below.

Setting the cue point by the acoustic pressure level identified as a silent section (8 levels)

-36 dB, -42 dB, -48 dB, -54 dB, -60 dB, -66 dB, -72 dB and -78 dB

Automatically setting stored cues as cue points

MEMORY: The stored cue point nearest the beginning of the track is set as the cue point for auto cueing.

- When [MEMORY] is set, [A. CUE] lights in white on the main unit display.

The setting of the cue point for auto cueing can be changed using one of the methods below.

Using the [MENU (UTILITY)] button

1 Press the [MENU/UTILITY] button for over 1 second.

The [UTILITY] screen is displayed.

2 Turn the rotary selector then press it.

Select [AUTO CUE LEVEL].

3 Turn the rotary selector then press it.

Select the acoustic pressure level or [MEMORY].

Using the [TIME MODE (AUTO CUE)] button

1 Press the [TIME MODE/AUTO CUE] button for over 5 second.

The currently set value is displayed on the main unit display.

2 Press the [CUE/LOOP CALL ◀(LOOP 1/2X)] or [CUE/LOOP CALL ▶(LOOP 2X)] button.

Select the acoustic pressure level or [MEMORY].

Using the slip mode

When the slip mode is turned on, normal playback with the original rhythm continues in the background while in the pause (vinyl mode), scratch play, loop play, hot cue play and reverse play modes. When the slip mode is canceled, normal playback resumes from the point reached while the slip mode was turned on.

- When the quantize function is on, there may be a slight delay in operation of this function in order to synchronize the beat. (Slip beat loop, slip reverse and slip hot cue only)

Display of the position playing in the background



- When in the slip mode, the currently playing position is indicated by a yellow line on the main unit display's waveform display (overall waveform or enlarged waveform). The position playing in the background is indicated by a white line on the main unit display's waveform display (overall waveform).
- It is also displayed on the jog dial's slip play display.

Slip pausing

1 Press the [JOG MODE] button.

Set the jog mode to VINYL.

2 Press the [SLIP] button.

The mode switches to the slip mode.

3 During playback, press the [PLAY/PAUSE ▶/II] button.

Normal playback continues in the background even while in the pause mode.

The [SLIP] button flashes in beat with the sound playing in the background.

4 Press the [PLAY/PAUSE ▶/II] button to cancel the pause mode.

Normal playback of the sound that was playing in the background resumes.

Slip scratching

1 Press the [JOG MODE] button.

Set the jog mode to VINYL.

2 Press the [SLIP] button.

The mode switches to the slip mode.

3 During playback, press the top of the jog dial.

The scratch play mode is set.

Normal playback continues in the background even while scratching.

The [SLIP] button flashes in beat with the sound playing in the background.

4 Release your hand from the top of the jog dial.

Normal playback of the sound that was playing in the background resumes.

Slip looping

1 Press the [SLIP] button.

The mode switches to the slip mode.

2 Press the [IN/4BEAT (IN ADJUST)] button, then press the [LOOP OUT (OUT ADJUST)] button.

Loop playback starts.

Normal playback continues in the background even during loop playback.

The [SLIP] button flashes in beat with the sound playing in the background.

- Loops of over 8 seconds cannot be set.
- The same operation is performed when the [IN/4BEAT (IN ADJUST)] button is pressed for over 1 second and a loop is set.

3 Press the [RELOOP/EXIT] button.

Looping is canceled, and normal playback of the sound that was playing in the background resumes.

Slip beat looping

1 Press the [SLIP] button.

The mode switches to the slip mode.

2 Press and hold the selected beat on the [NEEDLE SEARCH] pad.

The loop is set automatically and loop playback begins.

Normal playback continues in the background even during loop playback.

The [SLIP] button flashes in beat with the sound playing in the background.

- The beat select screen is displayed when the slip mode is turned on.
- A different beat can also be selected by sliding your finger on the [NEEDLE SEARCH] pad without releasing it.

3 Release your finger from the [NEEDLE SEARCH] pad.

Normal playback of the sound that was playing in the background resumes.

4 Press the [RELOOP/EXIT] button.

The last loop that was set is played and the slip loop mode is set.

- If the slip beat loop was canceled after selecting a different beat without lifting your finger from the [NEEDLE SEARCH] pad, the loop called out with the [RELOOP/EXIT] button is the loop that was first set (during playback).

Slip reverse

1 Press the [SLIP] button.

The mode switches to the slip mode.

2 During playback, move the [DIRECTION FWD REV] lever to the REV side.

The [REV] indicator lights and the track is played in the reverse direction.

Normal playback continues in the background even during reverse playback.

The [SLIP] button flashes in beat with the sound playing in the background.

- At the position 8 beats past the position at which the [DIRECTION FWD REV] lever was moved to the REV side, the slip reverse mode is automatically canceled, normal playback of the sound playing in the background resumes and the [REV] indicator flashes.
- If the [DIRECTION FWD REV] lever is moved to the FWD side before 8 beats have played, the slip reverse mode is canceled and normal playback of the sound that was playing in the background resumes.

Slip hot cue

1 Press the [SLIP] button.

The mode switches to the slip mode.

2 Press and hold a [HOT CUE] (A, B, C, REC/CALL) button.

Hot cueing begins.

Normal playback continues in the background while the [HOT CUE] (A, B, C, REC/CALL) button is pressed.

The [SLIP] button flashes in beat with the sound playing in the background.

- At the point 4 beats after hot cueing began, the slip hot cue mode is automatically canceled and normal playback of the sound that was playing in the background resumes.

3 Release the [HOT CUE] (A, B, C, REC/CALL) button.

When the [HOT CUE] (A, B, C, REC/CALL) button is released before 4 beats have played since hot cueing began, normal playback of the sound that was playing in the background resumes.

Canceling the slip mode

Press the [SLIP] button.

The slip mode is canceled.

- The slip mode is also canceled when a track is loaded.

Playing from the point touched on the [NEEDLE SEARCH] pad

Touch the [NEEDLE SEARCH] pad with a finger to easily play the sound at the position at which the pad is touched. Move your finger while touching the pad to quickly move to the desired position.

The [NEEDLE SEARCH] pad can only be operated in the following cases:

- In the pause mode
- While the jog dial is being pressed with the jog mode set to VINYL

In the pause mode, touch the [NEEDLE SEARCH] pad.

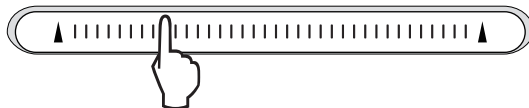

The currently playing position on the playing address display moves to the point directly above the position that was touched.

- The playing position can be moved by sliding your finger along the pad. Note that the playing address display may not be displayed properly if your finger is moved quickly.

Using the beat sync function

When beat sync is turned on, the BPM and beat position of tracks played on this unit can automatically be synchronized with the DJ player connected by PRO DJ LINK that is set as the sync master.

- The beat sync function does not operate for tracks that have not been analyzed with rekordbox.

1 Press the [BEAT SYNC MASTER] button on the DJ player you want to set as the sync master.

Set the DJ player you want to be the sync master.

When the beat sync function is on, the BPM display on the DJ player set as the sync master changes to orange.

- rekordbox can also be set as the sync master.
 - ➔ For instructions on setting rekordbox as the sync master, see the rekordbox (Mac/Windows) operating instructions.

2 Press the [BEAT SYNC] button.

The BPM and beat position of the currently playing track are synchronized to the sync master.

- During synchronization, tempo control with the tempo slider is disabled and the playing speed display switches to the tempo slider position's BPM display, displayed in gray.

Changing the DJ player set as the sync master

The sync master can be changed to another DJ player connected by PRO DJ LINK as described below.

- Change or pause the track on the DJ player set as the sync master.
- Press the [BEAT SYNC MASTER] button on the DJ player set as the sync master.
- Press the [BEAT SYNC MASTER] button on a DJ player other than the one set as the sync master.

Canceling synchronization

Press the [BEAT SYNC] button.

- If the synchronized playing tempo (BPM) and the slider position's tempo (BPM) do not match, the synchronized playing tempo is maintained and tempo control with the tempo slider remains disabled. Normal operation is restored when the position of the tempo slider is moved to the synchronized playing tempo position.

Operating the CDJ-2000NXS in combination with other devices

When connected by LAN cable with a Pioneer DJ mixer, such operations as starting playback on this unit can be controlled with the DJ mixer's fader.

- Connect this unit and the Pioneer DJ mixer ahead of time. For instructions on connections, see *Connections* on page 12.
- For details on player number settings, see *PRO DJ LINK* on page 3.
- Also refer to the description of the fader start function included in the Pioneer DJ mixer's operating instructions.

Starting playback using a DJ mixer's fader (Fader Start)

1 Connect this unit with the Pioneer DJ mixer using a LAN cable.

For instructions on connecting, see *Basic style* on page 12.

- If the Pioneer DJ mixer does not have a LAN port, connect a mini phone plug cable (Ø 3.5 mm) to the CONTROL terminal.

2 Turn on the DJ mixer's fader start function.

3 Set cues on this unit.

4 Move the DJ mixer's channel fader or cross fader.

This unit's pause mode is canceled and the track is played instantaneously.

- When the channel fader or cross fader is set back to its original position, playback cues back to the set cue point and the pause mode is set (Back Cue).

Relay play on two DJ players

1 Connect this unit and a DJ mixer.

For instructions on connecting, see *Connections for relay play* on page 15.

2 Set the DJ mixer's cross fader to the center position.

3 Turn auto cue on for both DJ players.

The DJ players' auto cue indicators light.

4 Start playback on this unit.

The first track on this unit is played, and once it finished playback begins automatically on the other DJ player. This unit cues to the beginning of the next track and pauses. This operation is repeated for relay play between the two DJ players.

- Relay play may not be possible if the two DJ players are not connected to the same DJ mixer.
- If the power of one DJ player is turned off during playback, playback may start on the other DJ player.

Browsing tracks

The various devices and the rekordbox library on the connected computer can be browsed to display a list of the tracks.

- When a storage device (SD, USB) on which no rekordbox library information is stored is browsed, the folders and tracks (music files) are listed in a layer structure.

Switching to the browse screen

Press the device button corresponding to the device you want to display.

When a button is pressed, the contents of the corresponding source are displayed on a list.

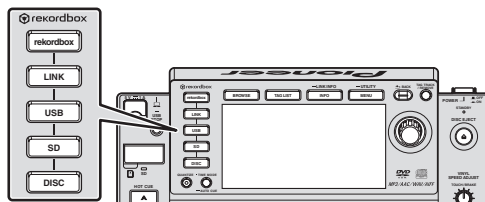

- [DISC] button: Displays the contents on the inserted disc.
- [SD] button: Displays the contents on the inserted SD memory card.
- [USB] button: Displays the contents of the connected USB or mobile device.
- [LINK] button: Displays the contents on the storage device (SD, USB) or mobile device on which rekordbox is installed that is connected to another DJ player by PRO DJ LINK.
- [rekordbox] button: Displays rekordbox connected by PRO DJ LINK (LINK Export).
- When the browse screen is displayed, the [BROWSE] button lights.
- When the [BROWSE] button is pressed while the browse screen is displayed, the browse screen closes and the screen returns to the normal playback screen. When the [BROWSE] button is pressed again, the previous browse screen opens.

❖ Description of the screen

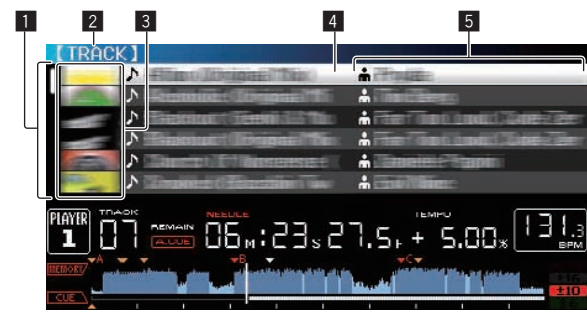

1 List of contents	The contents of the selected medium are displayed.
2 Uppermost level	Displays the name of the upper folder or media of the displayed item.
3 Jacket photo	Part of the artwork registered in rekordbox is displayed here. When the [INFO/LINK INFO] button is pressed, the jacket photo turns off and the track names are displayed along the left edge. For lists of playlists and playing histories, a serial number is displayed. If there is no rekordbox library, the track names are constantly displayed along the left edge.
4 Cursor	Turn the rotary selector to move the cursor up and down.
5 User-set categories	The categories displayed with rekordbox can be selected. When the [INFO/LINK INFO] button is pressed, the details of the track selected with the cursor are displayed. If there is no rekordbox library, the details of the track selected with the cursor are displayed.

❖ Distinguishing the currently playing device

The currently playing device and the device displayed on the browse screen can be distinguished according to how the device buttons are lit.

- Lit: That device is being browsed.
- Flashing: Tracks on that device are loaded.

Basic operations on the browse screen

❖ Selecting items

1 Display the browse screen.

- ☞ *Switching to the browse screen (p.31)*

2 Turn the rotary selector to select an item.

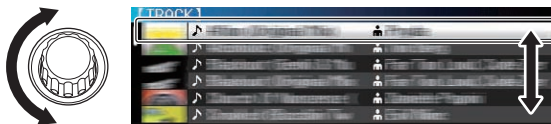

The jump function can be used by pressing the rotary selector for over 1 second.

- ☞ For details on the jump function, see *Searching using the jump function* on page 33.

3 Press the rotary selector to enter the item.



When there is a lower layer, that layer opens. When a menu, etc., is displayed, the selected item is entered.

When the rotary selector is pressed while the cursor is set at a track, that track is loaded in this unit.

❖ Moving back up to a higher layer

Press the **[BACK]** button while the browser screen is displayed.

The screen moves back to the layer above.

- When the **[BACK]** button is pressed for over 1 second or the medium button for the medium being browsed is pressed, the display moves to the topmost level.
- When playing the rekordbox library on a storage device (SD, USB), computer or mobile device, the information below can be displayed by pressing the **[BACK]** button at the topmost level.
 - When there is no rekordbox library information on the storage device (SD, USB): The device's free and used space
 - When there is rekordbox library information on the storage device (SD, USB): The device's free and used space, the number of tracks and playlists in the library information and the date they were last modified
 - rekordbox on a computer or mobile device: The number of tracks and playlists in the library information

Other browsing operations

Rearranging tracks (Sort menu)

While browsing, the sort menu can be used to change the order of the tracks.

- This function only works in the following cases:
 - When browsing the rekordbox library on a computer or mobile device
 - While browsing the rekordbox library on a storage device (SD, USB)
- 1 **Display the rekordbox library.**
 - ☞ *Playing storage devices (SD, USB) of other players and mobile devices on which rekordbox is installed (p.23)*
 - ☞ *Playing the rekordbox library on a computer or mobile device (p.24)*

2 When a list of the tracks is displayed, press the **[MENU/UTILITY]** button.

The sort menu appears on the screen.

3 Use the rotary selector to select and enter the sort item.

The tracks on the list are sorted according to the selected item.

- The sort items displayed on the sort menu can be changed in the rekordbox settings. For rekordbox libraries on storage devices (SD, USB), the settings are reflected after they are changed then re-exported.

Searching for tracks

- This function only works in the following cases:
 - When browsing the rekordbox library on a computer or mobile device
 - While browsing the rekordbox library on a storage device (SD, USB)

❖ Searching using the **[SEARCH]** category

In the library browse mode, tracks can be search for using the **[SEARCH]** category.

1 Display the rekordbox library.

- ☞ *Playing storage devices (SD, USB) of other players and mobile devices on which rekordbox is installed (p.23)*
- ☞ *Playing the rekordbox library on a computer or mobile device (p.24)*

2 Use the rotary selector to select and enter the **[SEARCH]** category.

A character appears at the bottom of the main unit display.

3 Use the [NEEDLE SEARCH] pad to input a character.

Only the tracks including the character you have input are displayed.

➤ *Inputting characters using the [NEEDLE SEARCH] pad* (p.33)

- When more characters are input, only the tracks including the character string you have input are displayed.
- When the [BACK] button is pressed, the category selection screen reappears.

❖ Inputting characters using the [NEEDLE SEARCH] pad

For several of this unit's functions, this pad is used to input characters.

1 Touch the [NEEDLE SEARCH] pad.

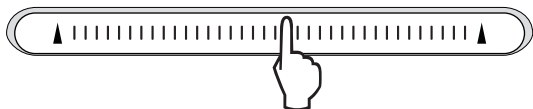

The character directly above the position touched is enlarged.

2 Release your finger from the [NEEDLE SEARCH] pad.

The enlarged character is input.

- To input more characters at this point, repeat the above procedure.
- The letters that can be input are letters A to Z, numbers 0 to 9 and certain symbols. The characters that can be input switch when you press directly below [ABC] and [123].



- When  is input, a single character is deleted. If input again, characters are deleted consecutively.

Searching by using the key of the currently playing track

When KEY category is displayed, the key icon switches to blue for tracks whose keys are good matches to the key of the currently playing track.

Searching using the jump function

The jump function can be used to instantaneously move to the track, category or folder you want to play.

The jump function includes the two modes below.

- Letter jumping: Use this when the tracks are arranged or sorted in alphabetical order.
- Page jumping: Use this when tracks are not in alphabetical order or are not sorted.

❖ In the letter jump mode

1 Display a list sorted in alphabetical order.

Display a list that is sorted in alphabetical order, such as the rekordbox library, the track list on the storage device (SD, USB), etc.

2 Press the rotary selector for at least 1 second.

Switch to the letter jump mode. The first letter of the track or category selected with the cursor is enlarged.

3 Turn the rotary selector to select the character or symbol.

The cursor moves to tracks or categories starting with the selected character or symbol.

- If there are no tracks or categories starting with the selected character on the list, the cursor does not move.
The characters displayed in the letter jump mode are letters A to Z, numbers 0 to 9 and certain symbols.

❖ In the page jump mode

1 Display a list not sorted in alphabetical order.

Display a list that is not sorted in alphabetical order, such as the tracks on a music CD, folders on a storage device (SD, USB) or a disc, etc.

2 Press the rotary selector for at least 1 second.

The mode switches to the page jump mode.

3 Turn the rotary selector to select the page.

The display moves to the selected page.

❖ Using the information jump function

The categories to which tracks belong can be displayed by selecting items displayed in the details. This function is convenient for searching for tracks in the same genre as the loaded track, tracks with similar BPMs, etc.

1 Load a track.

2 At the normal playback screen, press the [INFO] button.

The track's details are displayed.

- For details, see *Displaying the details of the currently loaded track* on page 36.

3 Select and enter the item.

The screen switches to the browse screen and the category for the selected item is displayed.

- To close the browse screen, press the [BROWSE] button.
- It may not be possible to select items, for example for items with nothing to be displayed on the browse screen, items for which only icons are displayed in the details, etc.
- When a track is selected, the browse screen displayed directly before the track was loaded is displayed.
- For tracks on disc and storage devices (SD, USB) that do not contain rekordbox libraries, only the track items can be selected.

Using hot cue banks

Hot cue banks that have been set ahead of time with rekordbox can be loaded as a set into this unit's [HOT CUE] buttons (A, B and C).

1 Connect the storage device (SD, USB) on which the hot cue banks are stored to this unit.

2 Use the rotary selector to select and enter the [HOT CUE BANK] category on the browse screen.

A list of hot cue banks is displayed.

3 Use the rotary selector to select and enter the hot cue bank you want to call out.

The hot cues registered in the hot cue bank are displayed on the screen.

- The cursor is set to hot cue bank A, and cannot be moved with the rotary selector or any other button.

4 Press the rotary selector.

The hot cues set at this unit's [HOT CUE] (A, B and C) buttons are overwritten with the hot cues registered in the hot cue bank. The [HOT CUE] (A, B and C) buttons light.

- When a new hot cue is stored at one of this unit's [HOT CUE] buttons (A, B or C) after loading the hot cue bank, overwriting the hot cue bank's hot cue, the other two hot cues registered from the hot cue bank are also deleted.
- Hot cue banks cannot be edited on this unit. Use rekordbox to edit them. For details, see the rekordbox (Mac/Windows) operating instructions.

Checking the playing history (HISTORY)

The track playing history is stored and displayed at the [HISTORY] category on the browse screen.

- Playlists can be created based on the playing history at [HISTORY] using rekordbox. For details, see rekordbox (Mac/Windows)'s operating instructions.

Storing the playing history

1 Connect a storage device (SD, USB) to this unit.

2 Play tracks.

Tracks that have been played for approximately 1 minute are stored on the playing history list.

- When a storage device (SD, USB) is connected to this unit for the first time or when it is reconnected, a new playing history list is automatically created on the storage device (SD, USB).
- The names of playing history lists can be preset at [UTILITY].
 - ➔ *Setting the playing history list name* (p.38)
- When the same track is played two or more times consecutively, it may not be stored in the history.
- The maximum number of tracks that can be stored on a playing history list is 999. From the 1000th track on, the oldest entries on the playing history are deleted to make room for the new entries. Up to 999 playing history lists can be created.
- When tracks are registered on the playing history list, their track names, etc., are displayed in green (indicating that they have been played).
- Tracks at the [PLAYLIST] category can be changed to green (played) using the [MENU] button. When changed, the tracks are registered on the playing history list.

Deleting the playback history

1 Connect a storage device (SD, USB) to this unit.

2 Display the rekordbox library.

- ➔ *Playing storage devices (SD, USB) of other players and mobile devices on which rekordbox is installed* (p.23)
- ➔ *Playing the rekordbox library on a computer or mobile device* (p.24)

3 Use the rotary selector to select and enter the [HISTORY] category.

A list of the playing history lists is displayed.

4 Turn the rotary selector and select the playing history list to be deleted.

5 Press the [MENU/UTILITY] button.

The remove menu is displayed.

6 Turn the rotary selector to select and enter the range to be deleted.

- [DELETE]: The currently selected playing history list is deleted.
- [ALL DELETE]: All the playing history lists are deleted.
- When playing history lists on a storage device (SD, USB) are imported to rekordbox as playlists, the imported playing history lists are deleted from the storage device (SD, USB).
- For tracks in the [PLAYLIST] category, the track names can be changed from green (played) to white (not played) using the [MENU] button. When this change is made, the tracks are deleted from the playing history list.

7 Use the rotary selector to select and enter [OK].

Editing tag lists

Tracks to be played next or tracks selected according to DJ situations can be marked and collected on lists. The list of collected tracks is called the "tag list". These tag lists can be shared in real time among multiple DJ players connected by PRO DJ LINK.

- Up to 100 tracks per device can be added to a tag list.
- One tag list is created per storage device (SD, USB). It is not possible to collect tracks from different storage devices (SD, USB) on one tag list.
- It is not possible to register the same track in the same folder twice.

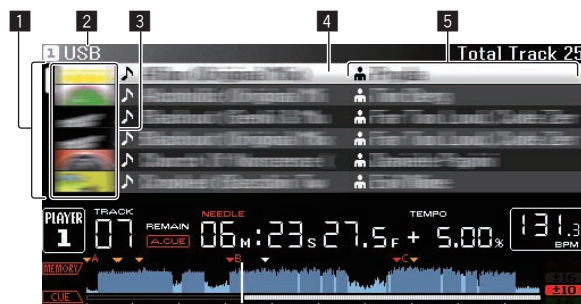

1 List of contents	The contents of the tag list are displayed here.
2 Medium name	The name of the medium on which the track is recorded is displayed here.
3 Jacket photo	Part of the artwork registered in rekordbox is displayed here. When the [INFO/LINK INFO] button is pressed, the jacket photo turns off and serial numbers are displayed.
4 Cursor	Turn the rotary selector to move the cursor up and down.
5 User-set categories	The categories displayed with rekordbox can be selected. When the [INFO/LINK INFO] button is pressed, the details of the track selected with the cursor are displayed.

Adding tracks to the tag list

❖ Selecting tracks and adding them

1 Switch to the browse screen and display the list of tracks.

2 Set the cursor to the track and press the [TAG TRACK/REMOVE] button.

 appears at the left of the track and that track is added to that storage device's (SD, USB) tag list.

- Tracks can be recorded in the tag list ahead of time using rekordbox.
 - ➔ For details on this operation, see the rekordbox (Mac/Windows) operating instructions.

❖ Adding loaded tracks

1 Load a track.

2 At the normal playback screen, press the [INFO] button.

3 Press the [TAG TRACK/REMOVE] button.

The track loaded in this unit is added to the tag list.

- Tracks can be added to the tag list by pressing the [TAG TRACK/REMOVE] button at the normal playback screen as well.

❖ Adding entire categories or folders

All the tracks in a selected category or folder can be added to the tag list.

1 Switch to the browse screen and select a category or folder that has tracks directly under it.

A list of the tracks is displayed on the right half of the information display screen.

2 Set the cursor to the category or folder, then press the [TAG TRACK/REMOVE] button.

The category or folder name flashes, and all the tracks in that category or folder are added to the tag list.

- When folders are added while in the folder browse mode, tracks for which ID3 tags, etc., have not been loaded a single time are registered using the file name as the track name. The artist names are not registered.
- After tracks have been added to the tag list, when the registered tracks are displayed on the track list on the browse screen or are loaded in a player and their ID3 tags, etc., are loaded, the file names switch to the track names and the artist names are also registered.

❖ Adding tracks from playlists

All the tracks on a selected playlist can be added to the tag list.

1 Switch to the browse screen and select and enter the [PLAYLIST] category.

A list of the playlists is displayed, and a list of the tracks is displayed on the right half of the information display screen.

2 Set the cursor to the playlist, then press the [TAG TRACK/REMOVE] button.

The playlist name flashes, and all the tracks on that playlist are added to the tag list.

Loading tracks from the tag list

1 Press the [TAG LIST] button.

The tag list is displayed.

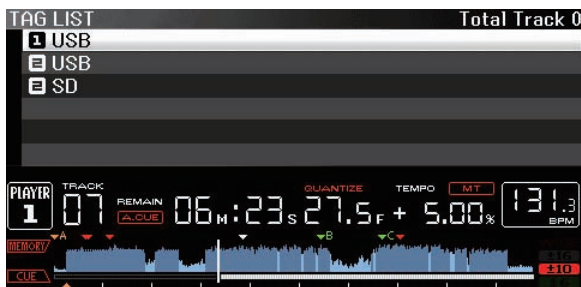

- When multiple storage devices (SD, USB) are connected to the DJ player, the number of the player to which that storage device (SD, USB) is connected is displayed in front of the storage device's (SD, USB) name.

2 Use the rotary selector to select and enter the storage device (SD, USB).

When a storage device (SD, USB) is selected, the tag list on that storage device (SD, USB) is displayed.

3 Use the rotary selector to select and enter the track you want to load.

The track is loaded and playback starts.

Removing tracks from the tag list

Tracks can be removed from tag lists.

- If a track that has been added to the tag list is removed from the tag list while it is playing, the track is played to the end, then the stop mode is set. The next track is not played.

❖ Removing one track at a time

1 Press the [TAG LIST] button.

The tag list is displayed.

2 Use the rotary selector to select and enter the storage device (SD, USB).

When a storage device (SD, USB) is selected, the tag list on that storage device (SD, USB) is displayed.

3 Use the rotary selector to set the cursor to the track you want to remove.

4 Press the [TAG TRACK/REMOVE] button for over 1 second.

Tracks can be removed from tag lists by pressing the [TAG TRACK/REMOVE] button at the screens and in the situations described below.

- When the cursor is set to a track registered in the tag list on the browse screen
- When the normal playback screen or a track's details screen is displayed while a track registered in the tag list is loaded

❖ Removing all the tracks

1 Press the [TAG LIST] button.

The tag list is displayed.

2 Use the rotary selector to select and enter the storage device (SD, USB).

When a storage device (SD, USB) is selected, the tag list on that storage device (SD, USB) is displayed.

3 Press the [MENU/UTILITY] button.

[LIST MENU] is displayed.

4 Use the rotary selector to select and enter [TAGLIST MENU].

[TAGLIST MENU] is displayed.

5 Use the rotary selector to select and enter [REMOVE ALL TRACKS].

6 Use the rotary selector to select and enter [OK].

Transforming the tag list into a playlist

Tracks collected in tag lists can be converted into playlists.

- Converted playlists are displayed as items in the [PLAYLIST] category.

1 Press the [TAG LIST] button.

The tag list is displayed.

2 Use the rotary selector to select and enter the storage device (SD, USB).

When a storage device (SD, USB) is selected, the tag list on that storage device (SD, USB) is displayed.

3 Press the [MENU/UTILITY] button.

[LIST MENU] is displayed.

4 Use the rotary selector to select and enter [TAGLIST MENU].

[TAGLIST MENU] is displayed.

5 Use the rotary selector to select and enter [CREATE PLAYLIST].

6 Use the rotary selector to select and enter [OK].

The contents of the tag list are converted into a playlist with the name [TAG LIST XXX].

- Tag lists cannot be converted into playlists when no rekordbox library information is stored on the storage device (SD, USB).

- When tag lists include both tracks being managed with rekordbox and tracks not being managed with rekordbox, only the tracks being managed with rekordbox are converted into playlists.

2 Press the [INFO] button for over 1 second.

The [LINK INFO] screen appears.

3 Use the rotary selector to select and enter the DJ player whose track details you want to see.

The details of the tracks loaded in the selected DJ player are displayed.

Displaying the details of the currently loaded track

The details of the currently loaded track can be checked.

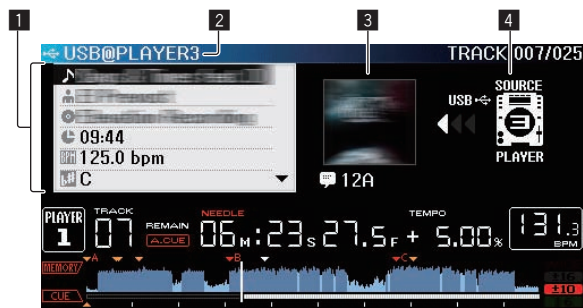

1 Track details	The details of the tracks loaded in the DJ player are displayed here.
2 Medium/player number	The place where the track information is stored is displayed here.
3 Jacket photo and comment	The jacket photo and comment about the track loaded in the DJ player are displayed here.
4 Source indicator	This indicates the location of the currently loaded track.

The source indicator (4) is not displayed when a disc inserted into this unit or a storage device (SD, USB) connected to this unit is loaded.

1 Load a track.

2 At the normal playback screen, press the [INFO] button.

The track's details are displayed.

Changing track ratings

The tracks' ratings can be changed.

1 Select the rating displayed in the detailed information (display example: ☆☆☆☆☆).

2 Press the rotary selector for over 1 second, then turn the rotary selector clockwise or counterclockwise.

The rating of the loaded track is changed.

Displaying details of tracks loaded in other DJ players

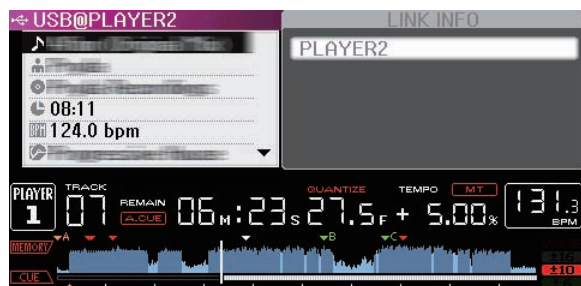

When another DJ player is connected by PRO DJ LINK, the details of the track loaded on the other DJ player can be checked.

1 Connect this unit and the other DJ players by PRO DJ LINK.

Changing the settings

Storing the settings on a storage device (SD, USB)

The [UTILITY] settings and other settings can be stored on a storage device (SD, USB).

The stored settings can be exported to rekordbox.

It is also possible to make this unit's settings with rekordbox then store them on a storage device (SD, USB) and reflect those settings on other DJ players.

- The stored settings are shown below.

— [UTILITY] settings

PLAY MODE, EJECT/LOAD LOCK, AUTO CUE LEVEL, SLIP FLASHING, ON AIR DISPLAY, JOG BRIGHTNESS, JOG INDICATOR, DISC SLOT ILLUMINATION, LANGUAGE, LCD BRIGHTNESS

— Other settings

TIME MODE (how the time is displayed on the main unit display), **AUTO CUE, JOG MODE, TEMPO RANGE, MASTER TEMPO, QUANTIZE, SYNC**

1 Connect the storage device (SD, USB) on which you want to store the settings.

2 Press the device button (SD or USB).

When the storage device (SD, USB) on which you want to store the settings is connected to another DJ player connected by PRO DJ LINK, press the [LINK] button to select the storage device.

3 Press the [MENU/UTILITY] button.

4 Use the rotary selector to select and enter [SAVE] at [MY SETTINGS].

The settings are stored.

Calling out settings stored on a storage device (SD, USB)

The [UTILITY] settings and other settings stored on a storage device (SD, USB) can be called out.

1 Connect the storage device (SD, USB) on which the settings are stored.

2 Press the device button (SD or USB).

When the storage device (SD, USB) on which you want to store the settings is connected to another DJ player connected by PRO DJ LINK, press the [LINK] button to select the storage device.

3 Press the [MENU/UTILITY] button.

4 Use the rotary selector to select and enter [LOAD] at [MY SETTINGS].

The settings are called out.

Displaying the [UTILITY] screen

Press the [MENU/UTILITY] button for over 1 second.

The [UTILITY] screen is displayed.

Description of the screen

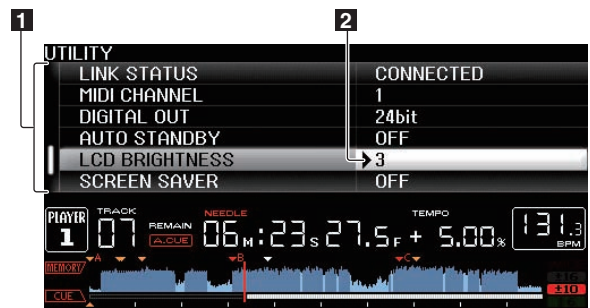

1 Setting item This unit's settings items are displayed here.

2 Setting The settings for the various items are displayed here.

Changing the settings

1 Press the [MENU/UTILITY] button for over 1 second.

The [UTILITY] screen is displayed.

2 Use the rotary selector to select the setting item.

3 Set the cursor to the item you want to change, then press the rotary selector.

The cursor moves to the setting.

4 Turn the rotary selector and change the setting.

5 Press the rotary selector to enter the setting.

The cursor returns to the setting.

- When the [BACK] button is pressed before entering the setting, the change is aborted.

6 Press the [MENU/UTILITY] button.

The screen returns to the screen displayed before the [MENU/UTILITY] button was pressed.

Setting preferences

Options settings	Setting ranges	Descriptions
PLAY MODE	CONTINUE*/SINGLE	Changes the way the tracks loaded in this unit are played. For details, see <i>Changing the play mode</i> on page 38.
EJECT/LOAD LOCK	LOCK/UNLOCK*	Sets whether to disable or enable ejecting of discs during playback and loading of new tracks during playback.
AUTO CUE LEVEL	-36 dB/-42 dB/ -48 dB/-54 dB/-60 dB*/ -66 dB/-72 dB/-78 dB /MEMORY	For details, see <i>Setting the cue point for auto cueing</i> on page 29.
SLIP FLASHING	ON*/OFF	Sets whether or not the indicators of buttons, etc., for which the slip function is activated when the [SLIP] button is pressed flash.

Options settings	Setting ranges	Descriptions
ON AIR DISPLAY	ON*/OFF	Selects the method of display when connected by PRO DJ LINK to an ON AIR DISPLAY compatible mixer. Also refer to the operating instructions of the ON AIR DISPLAY compatible mixer (DJM-2000, etc.).
JOG BRIGHTNESS	OFF/1/2*	Selects the brightness of the JOG RING ILLUMINATION.
JOG INDICATOR	ON*/OFF	Selects whether the JOG RING ILLUMINATION flashes or not when the track's remaining time is low.
DISC SLOT ILLUMINATION	OFF/1/2*	Sets the brightness of the disc insertion slot indicator.
LANGUAGE	—	Sets the main unit display's language.
LIBRARY CREATOR	LIBRARY*/FOLDER	Selects whether or not to display Pioneer MEP-7000 libraries.
HISTORY NAME	—	For details, see <i>Setting the playing history list name</i> on page 38.
PLAYER No.	AUTO*, 1 – 4	Sets this unit's player number. The player number cannot be changed when a medium is loaded in this unit.
LINK STATUS	—	When PRO DJ LINK connections are made, the connection status is displayed here.
MIDI CHANNEL	1* to 16	For details, see <i>Changing the MIDI channel setting</i> on page 41.
DIGITAL OUT	16 bit/24 bit*	This switches the number of bits of the audio signals output from the [DIGITAL OUT] terminal.
AUTO STANDBY	ON*/OFF	For details, see <i>Changing the MIDI channel setting</i> on page 41.
LCD BRIGHTNESS	1 – 3* – 5	Sets the main unit display's brightness.
SCREEN SAVER	ON*/OFF	When set to [ON], the screensaver starts up in the following cases: <ul style="list-style-type: none"> When no track is loaded in this unit for over 5 minutes When no operation is performed for over 100 minutes while in the pause or cue standby mode or when [END] is displayed on the main unit display.
DUPLICATION	DEFAULT*, ALL, PLAYER1-4	For details, see <i>Duplicating the settings onto DJ players connected by PRO DJ LINK</i> on page 39.
VERSION No.	—	Displays this unit's software version.

*: Setting upon purchase

Changing the play mode

1 Display the [UTILITY] screen.

☞ *Displaying the [UTILITY] screen* (p.37)

2 Use the rotary selector to select and enter [PLAY MODE].

3 Use the rotary selector to select and enter [CONTINUE] or [SINGLE].

CONTINUE: Moving to the previous or following track is possible in all modes.

SINGLE: The letters [TRACK] on the main unit display switch to [SINGLE] and it is no longer possible to move to the previous or following track other than with the track search and search buttons.

- For tracks on music CDs, operation is the same as in the [CONTINUE] mode, regardless of this setting.

Setting the auto standby mode

1 Display the [UTILITY] screen.

☞ *Displaying the [UTILITY] screen* (p.37)

2 Use the rotary selector to select and enter [AUTO STANDBY].

3 Use the rotary selector to select and enter [ON] or [OFF].

When [AUTO STANDBY] is set to [ON], the auto standby function is activated and the standby mode is set in the cases described below.

- When no operation has been performed for over 4 hours with no disc inserted, no storage device (SD, USB) connected, no device connected by PRO DJ LINK and no computer connected to the USB port (on the main unit's rear panel).
- When this unit is operated, the standby mode is canceled.
- This unit is shipped with the auto standby function turned on. If you do not want to use the auto standby function, set [AUTO STANDBY] to [OFF].

Setting the playing history list name

The name of the playing history list stored on storage devices (SD, USB) can be preset.

1 Display the [UTILITY] screen.

☞ *Displaying the [UTILITY] screen* (p.37)

2 Use the rotary selector to select and enter [HISTORY NAME].

3 Use the [NEEDLE SEARCH] pad to input a character.

☞ *Inputting characters using the [NEEDLE SEARCH] pad* (p.33)

4 Press the rotary selector to enter.

The name is changed to the name you have input.

- When the name of the playing history list is changed, the number after the playing history list name returns to 001. This number is incremented each time a playing history list is created.
- The maximum number of characters that can be set for the [HISTORY] name is 32, including both letters, numbers and symbols.

Changing the language

Select the language to be used for displaying track names and messages on the screen.

- When the language is changed, the messages on the main unit display are displayed in the selected language.
- When displaying track names, etc., to display characters written in local codes other than Unicode, change the [LANGUAGE] setting.

1 Display the [UTILITY] screen.

☞ *Displaying the [UTILITY] screen* (p.37)

2 Use the rotary selector to select and enter [LANGUAGE].

3 Use the rotary selector to select and enter the language.

The language of the on-screen display is changed.

Duplicating the settings onto DJ players connected by PRO DJ LINK

The [UTILITY] settings and other settings can be duplicated onto DJ players connected by PRO DJ LINK.

- The duplicated settings are as shown below.
 - [UTILITY] settings
 - PLAY MODE, EJECT/LOAD LOCK, AUTO CUE LEVEL, SLIP FLASHING, ON AIR DISPLAY, JOG BRIGHTNESS, JOG INDICATOR, DISC SLOT ILLUMINATION, LANGUAGE, LCD BRIGHTNESS
 - Other settings
 - TIME MODE (how the time is displayed on the main unit display), AUTO CUE, JOG MODE, TEMPO RANGE, MASTER TEMPO, QUANTIZE, SYNC

1 Select [DUPLICATION] and enter.

2 Stop playback on the DJ player(s) on which you want to reflect the settings.

3 Use the rotary selector to select and enter [PLAYER X] or [ALL].

[PLAYER1]–[PLAYER4]: The settings are duplicated on the specified DJ player. Currently playing DJ players cannot be selected.

[ALL]: The settings are duplicated on all the DJ players connected by PRO DJ LINK. The settings cannot be duplicated on currently playing DJ players.

[DUPLICATED] is displayed on the specified player's display and this unit's [UTILITY] settings and other settings are duplicated on the specified player.

[DEFAULT]: Restores this unit's settings to the settings set upon purchase.

About the driver software (Windows)

Installing the driver software

- There is no need to install the driver software when using Mac OS X.

Operating environment

Supported operating systems		
Windows® 7 Home Premium/Professional/Ultimate	32-bit version	✓
	64-bit version	✓ ¹⁾
Windows Vista® Home Basic/Home Premium/Business/Ultimate (SP2 or later)	32-bit version	✓
	64-bit version	✓ ¹⁾
Windows® XP Home Edition/Professional (SP3 or later)	32-bit version	✓

¹⁾ When using a 64-bit version of Windows, the driver software can only be used for 32-bit applications.

Before installing the driver software

- Read *Software end user license agreement* on page 8 carefully.
- If you connect this unit to your computer without installing the driver software first, an error may occur on your computer depending on the system environment.
- If installation of the driver software is interrupted after it has started, start the installation procedure over again from the beginning.

1 Turn off this unit's power switch and disconnect the USB cable connecting this unit to the computer.

2 Log in as the user set as the computer's administrator.

3 Quit any other programs running on the computer.

4 Insert the CD-ROM into the computer's optical drive.

The CD-ROM menu is displayed.

- If the CD-ROM menu does not appear when the CD-ROM is inserted, open the optical drive from [Computer (or My Computer)] in the [Start] menu, then double-click the [CD_menu.exe] icon.

5 When the CD-ROM's menu is displayed, select [Install Driver Software], then click [Start].

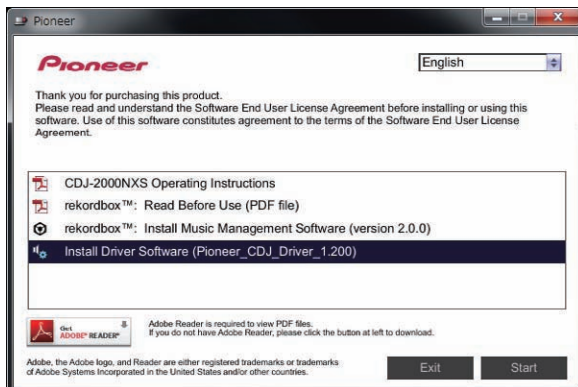

- To close the CD-ROM menu, click [Exit].

6 Proceed with installation according to the instructions on the screen.

If [Windows Security] appears on the screen while the installation is in progress, click [Install this driver software anyway] and continue with the installation.

- When installing on Windows XP
 - If [Hardware Installation] appears on the screen while the installation is in progress, click [Continue Anyway] and continue with the installation.
- When the installation program is completed, a completion message appears.

Connecting this unit and a computer by USB

1 Connect this unit to your computer via a USB cable.

For instructions on connecting, see *Using other brands of DJ software* on page 15.

2 Press the [POWER ON/OFF] button.

Turn on the power of this unit.

- The message [Installing device driver software] may appear when this unit is first connected to the computer or when it is connected to a different USB port on the computer. Wait a while until the message [Your devices are ready for use] appears.
- When installing on Windows XP
 - [Can Windows connect to Windows Update to search for software?] may appear while the installation is in progress. Select [No, not this time], then click [Next] to continue installation.
 - [What do you want the wizard to do?] may appear while the installation is in progress. Select [Install the software automatically (Recommended)], then click [Next] to continue installation.
 - If [Hardware Installation] appears on the screen while the installation is in progress, click [Continue Anyway] and continue with the installation.

Adjusting the buffer size (Windows)

This unit functions as an audio device conforming to the ASIO standards.

- If an application using this unit as the default audio device (DJ software, etc.) is running, quit that application before adjusting the buffer size.

Click the Windows [Start] menu>[All Programs]>[Pioneer]>[Pioneer CDJ]>[Pioneer CDJ ASIO Settings Utility].

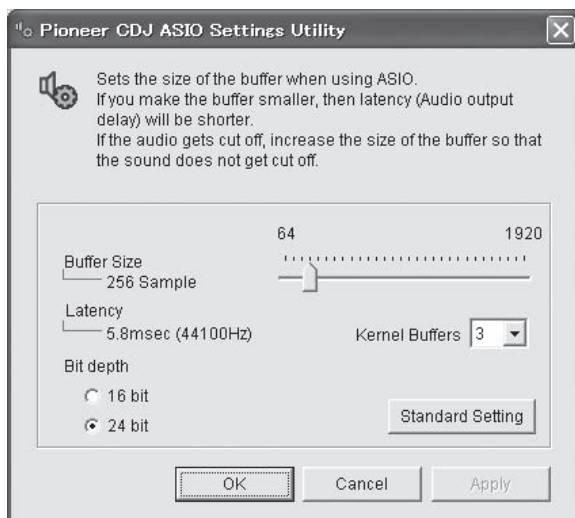

- If the buffer size is made large, drops in audio data (breaks in the sound) occur less easily, but the time lag due to the delay in the transfer of the audio data (latency) increases.
- For the bit number, specify the bit depth during ASIO playback.
- Operate referring to the procedure below to adjust the buffer size and kernel buffer.

❖ If there are no interruptions in the sound with the default settings

1 Gradually decrease the buffer size, setting it to the minimum value at which there are no interruptions in the sound.

2 Set the kernel buffer size to [2] and check whether there are interruptions in the sound.

- If there are interruptions in the sound, set the kernel buffer size to [3].

❖ If there are interruptions in the sound with the default settings

Set the kernel buffer size to [4], then set the buffer size to the minimum value at which there are no interruptions in the sound.

Checking the version of the driver software

- You can check the firmware version of this unit on the screen.

Click the Windows [Start] menu>[All Programs]>[Pioneer]>[Pioneer CDJ]>[Pioneer CDJ Version Display Utility].

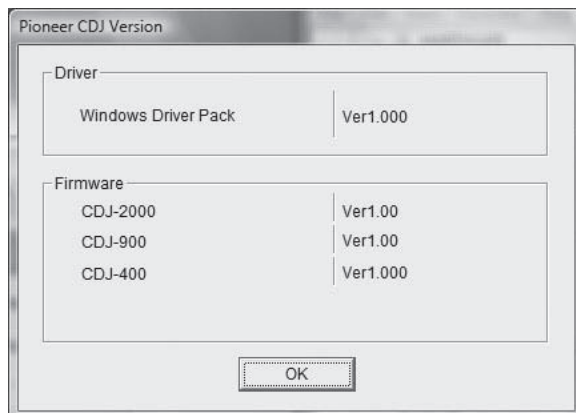

- The firmware version is not displayed when this unit is not connected to the computer or when this unit and computer are not properly communicating.

Checking the latest information on the driver software

For the latest information on the driver software for exclusive use with this unit, visit our website shown below.
<http://pioneerdj.com/support/>

Using other brands of DJ software

Operating DJ software by MIDI interface

This unit also outputs the operating data for the buttons and dials in MIDI format. If you connect a computer with a built-in MIDI-compatible DJ software via a USB cable, you can operate the DJ software on this unit. The sound of music files being played on the computer can also be output from the CDJ-2000NXS.

To use this unit as an audio device, install the driver software on the computer beforehand (page 39). This unit must also be selected in the DJ software's audio output device settings. For details, see your DJ software's operating instructions.

1 Connect the USB port on this unit to your computer.

For instructions on connecting, see *Using other brands of DJ software* on page 15.

2 Press the [BROWSE] button, then press the [LINK] button.

[Control Mode] and [USB-MIDI] appear on the menu screen.

3 Select [Control Mode] and enter.

The connecting screen is displayed.

4 Select [USB-MIDI] and enter.

This unit switches to the control mode.

5 Launch the DJ software.

Communication with the DJ software starts.

- The DJ software on the computer can be operated using the buttons and rotary selector on this unit.
- It may not be possible to use some buttons to operate the DJ software.
- The control mode is canceled when a track is loaded in this unit.
- For messages output by this unit, see *List of MIDI Messages* on page 42.

Changing the MIDI channel setting

1 Press the [MENU/UTILITY] button for over 1 second.

The utility screen appears.

2 Select [MIDI CHANNEL] and enter.

3 Turn the rotary selector.

Select the MIDI channel and change the setting. A setting from 1 – 16 can be selected.

4 Press the rotary selector to enter.

5 Press the [MENU/UTILITY] button.

The previous screen reappears.

List of MIDI Messages

SW Name	SW Type	MIDI Messages			Notes
		MSB			
JOG (TOUCH)	—	Bn	10	dd	A linear value corresponding to the speed, from stop to 4X: 64 for stop, 65 (0.06X) – 127 (4X) in the forward direction, 63 (0.06X) – 0 (4X) in the reverse direction.
TEMPO SLIDER	VR	Bn	1D	dd	0 – 127, 0 on the – side, 127 on the + side
TOUCH/ BRAKE	VR	Bn	1E	dd	0 – 127, 0 (min.) on the left side, 127 (max.) on the right side
RELEASE/ START	VR	Bn	1F	dd	0 – 127, 0 (min.) on the left side, 127 (max.) on the right side
JOG RING	—	Bn	30	dd	A linear value corresponding to the speed from 0.5X to 4X: 64 when stopped (under 0.49X), 65 (0.5X) to 127 (4X) in the forward direction, 63 (0.5X) to 0 (4X) in the reverse direction.
ENCODER	General Purpose Controller	Bn	4F	dd	98 – 127, 1 – 30 Difference of count from previous time is sent ($\pm 1 - \pm 30$) When over ± 30 , set at ± 30
PLAY/PAUSE	SW	9n	00	dd	OFF=0, ON=127
CUE	SW	9n	01	dd	OFF=0, ON=127
SEARCH FWD	SW	9n	02	dd	OFF=0, ON=127
SEARCH REV	SW	9n	03	dd	OFF=0, ON=127
TRACK SEARCH NEXT	SW	9n	04	dd	OFF=0, ON=127
TRACK SEARCH REV	SW	9n	05	dd	OFF=0, ON=127
LOOP IN	SW	9n	06	dd	OFF=0, ON=127
LOOP OUT	SW	9n	07	dd	OFF=0, ON=127
RELOOP	SW	9n	08	dd	OFF=0, ON=127
QUANTIZE	SW	9n	09	dd	OFF=0, ON=127
MEMORY	SW	9n	0A	dd	OFF=0, ON=127
CALL NEXT	SW	9n	0B	dd	OFF=0, ON=127
CALL PREV	SW	9n	0C	dd	OFF=0, ON=127
DELETE	SW	9n	0D	dd	OFF=0, ON=127
TIME/A.CUE	SW	9n	0E	dd	OFF=0, ON=127
TEMPO RANGE	SW	9n	10	dd	OFF=0, ON=127
MASTER TEMPO	SW	9n	11	dd	OFF=0, ON=127
JOG MODE	SW	9n	12	dd	OFF=0, ON=127
HOT CUE A	SW	9n	18	dd	OFF=0, ON=127
HOT CUE B	SW	9n	19	dd	OFF=0, ON=127
HOT CUE C	SW	9n	1A	dd	OFF=0, ON=127
HOT CUE REC/CALL	SW	9n	1C	dd	OFF=0, ON=127
TEMPO RESET	SW	9n	1D	dd	OFF=0, ON=127
MASTER	SW	9n	1E	dd	OFF=0, ON=127
SYNC	SW	9n	1F	dd	OFF=0, ON=127
JOG TOUCH	SW	9n	20	dd	OFF=0, ON=127
REVERSE	SW	9n	21	dd	OFF=0, ON=127
LOOP MODE	SW	9n	2A	dd	OFF=0, ON=127
SLIP	SW	9n	2C	dd	OFF=0, ON=127
EJECT	SW	9n	2F	dd	OFF=0, ON=127
TAG TRACK	SW	9n	30	dd	OFF=0, ON=127

SW Name	SW Type	MIDI Messages			Notes
		MSB			
BACK	SW	9n	32	dd	OFF=0, ON=127
ENCODER PUSH	SW	9n	33	dd	OFF=0, ON=127
NEEDLE	Touch Sensor	Bn	1C	dd	OFF = 0 1 to 127 position data from left to right side

n is the channel number.

Additional information

Troubleshooting

- Incorrect operation is often mistaken for trouble or malfunction. If you think that there is something wrong with this component, check the points below. Sometimes the trouble may lie in another component. Inspect the other components and electrical appliances being used. If the trouble cannot be rectified after checking the items below, ask your nearest Pioneer authorized service center or your dealer to carry out repair work.
- This unit may not operate properly due to such external causes as static electricity. If this happens, normal operation can sometimes be restored by turning the power off, waiting for the disc to stop completely, then turning the power back on.

Problem	Check	Remedy
Disc cannot be ejected.	Is [EJECT/LOAD LOCK] set to [LOCK]?	Press the [PLAY/PAUSE▶/II] button to set the pause mode, then press the [DISC EJECT▲] button.
	—	Set [EJECT/LOAD LOCK] at [UTILITY] to [UNLOCK], then press the [DISC EJECT▲] button. If the [DISC EJECT▲] button does not work, insert the pin into the disc force eject hole to eject the disc.
Playback does not start when disc is loaded.	Is the disc or file playable?	See <i>Usable media</i> on page 5.
	Is the auto cue function activated?	Press [AUTO CUE] for at least 1 second to turn cancel the auto cue function.
File cannot be played.	Is the file copyright-protected (by DRM)?	Copyright-protected files cannot be played.
No sound is produced, or sound is distorted or noisy.	Are you operating the connected DJ mixer properly?	Check the operation of the DJ mixer.
	Is this unit placed near a TV?	Turn the TV's power off or install this unit and TV away from each other.
Loud noise is produced or playback stops when a certain disc is played.	Is the disc scratched?	Scratched discs may not play.
	Is the disc dirty?	Wipe the dirt off the disc. (page 46)
File information is not properly displayed.	Is [LANGUAGE] properly set?	Set [LANGUAGE] to the proper language.
	Is the information recorded in a language not supported by this unit?	When creating files using DJ software, etc., record the information in a language supported by this unit.
Track search operation takes too long.	Is the auto cue function activated?	Track searching may take some time when there are long silent sections between tracks.
	—	If track searching is not possible within 10 seconds, a cue point is set at the beginning of the track.
Back cue function does not work.	Is a cue point set?	Set the cue point (page 26).
Loop play function does not work.	Is a cue point set?	Set the cue point (page 26).
Settings are not stored in the memory.	Has the power been turned off directly after changing the setting?	After changing settings, wait at least 10 seconds before turning the power off.
USB device is not recognized.	Is the USB device properly connected?	Connect the device securely (all the way in).
	Is the USB device connected via a USB hub?	USB hubs cannot be used.
	Is the USB device supported by this unit?	This player only supports USB mass storage class devices. This player supports portable flash memory and digital audio playback devices.
	Is the file format supported by this unit?	Check the file format of the connected USB device. For the file formats supported by this unit, see <i>About USB devices</i> on page 6.
	—	Turn the power off then back on.
Cue or loop points are not stored on storage devices (SD, USB).	Are you trying to store more points than the limit?	The maximum number of cue or loop points that can be stored on storage devices (SD, USB) per disc is 100. For devices other than discs, the maximum limit is 10 points per track. If you try to store more points than the limit, [CUE/LOOPPOINT FULL] is displayed and the points cannot be stored. In this case, delete some points before storing new ones.
	Is the storage device (SD, USB) write-protected?	When an SD memory card is write-protected, [CARD PROTECTED] is displayed and the points cannot be stored. When a USB device is write-protected, [USB FULL] is displayed and the points cannot be stored. Disable write-protection then store the points.
	Is there enough free space on the storage device (SD, USB)?	If there is not enough free space on an SD memory card, [CARD FULL] is displayed and the points cannot be stored. If there is not enough free space on a USB device, [USB FULL] is displayed and the points cannot be stored. Free some space then store the points.
Cue points or loop of tracks stored on a storage device (SD, USB) are not displayed.	Was the USB device properly stopped before it was disconnected the last time?	Points may not be displayed if the SD memory card/USB device is removed without performing the proper stopping procedure or if this unit's power is turned off. Check that the SD memory card or USB indicator is completely off before disconnecting storage devices (SD, USB) or turning this unit's power off.
When buttons are pressed to call out the hot cue storing mode or to reloop, or when the lever is moved to set reverse playback, the operation does not start immediately.	Is the quantize function on?	When the quantize function is on, the operation starts from the nearest beat position from where buttons are pressed or the lever is moved. To start the operation immediately when buttons are pressed or the lever is moved, turn the quantize function off.

Problem	Check	Remedy
The playing address display is not displayed in the remaining time mode.	—	When playing files recorded in VBR, it may happen that the set cannot detect the length of the track immediately and that some time is required for the playing address display to appear.
Much time is required for reading storage devices (SD, USB) (flash memory devices or hard disks).	Is there a large number of folders or files stored on the storage device (SD, USB)?	When there are many folders or files, some time may be required for loading.
	Are files other than music files saved on the storage device (SD, USB)?	When files other than music files are stored in folders, time is required to read them as well. Do not store files or folders other than music files on the USB device.
Library browsing is not possible.	Is a medium on which library information is recorded loaded?	The library browse mode is only set when media on which library information is recorded are loaded. When a medium on which no library information is recorded is loaded, the folder browse mode is set.
[HISTORY] is not displayed.	Is the storage device (SD, USB) connected?	The [HISTORY] function can only be used on the DJ player to which the storage device (SD, USB) is connected.
Nothing is displayed.	Is the auto standby function activated?	This unit is shipped with the auto standby function turned on. If you do not want to use the auto standby function, set [AUTO STANDBY] to [OFF]. (page 38)
The scale is not displayed.	Is the track over 15 minutes long?	The scale is not displayed for tracks whose playing time is over 15 minutes. (page 20)
PRO DJ LINK does not work well.	Are the player numbers properly set?	Set [PLAYER No.] to [AUTO] or to a number different from the number currently set. (page 37)
	Is the LAN cable properly connected?	Connect the LAN cable properly to the [LINK] terminal.
	Is the switching hub's power turned on?	Turn the switching hub's power on.
	Is an unnecessary device connected to the switching hub?	Disconnect the unnecessary device from the switching hub.

About the liquid crystal display

- Small black or shining points may appear on the liquid crystal display. This is a phenomenon inherent to liquid crystal displays; this is not a malfunction.
- When using in cold places, the liquid crystal display may be dark for a while after this unit's power is turned on. It will reach the normal brightness after a while.
- When the liquid crystal display is exposed to direct sunlight, the light will reflect off it, making it difficult to see. Block the direct sunlight.

About iPods/iPhones/iPads

































- This product has been developed and tested based on the iPod/iPhone/iPad software versions indicated on the Pioneer website (<http://pioneerdj.com/support/>).
- Compatibility with this product may be lost if a version other than one indicated on the Pioneer website is installed on your iPod/iPhone/iPad.
- Note that Pioneer does not offer any guarantee regarding operation of iPods/iPhones/iPads.
- Pioneer will accept no responsibility whatsoever for loss of iPod/iPhone/iPad data during use.
- With iPods/iPhones/iPads, material that is not copyrighted or material for which duplication and playback is legally permitted may be duplicated and played by individuals on a private basis. Infringement of copyrights is prohibited by law.

Error messages

When this unit cannot operate normally, an error code appears on the display. Check the table below and take the measures indicated. If an error code not shown on the table below is displayed, or if the same error code is displayed again after taking the indicated action, contact your store of purchase or a nearby Pioneer service station.

Error code	Error type	Description of error	Cause and action
E-7201	CANNOT READ DISC	TOC data cannot be read.	<ul style="list-style-type: none"> Disc is cracked. → Replace the disc. Disc is dirty. → Clean the disc.
E-8301	CANNOT READ DISC	Disc that cannot be played normally is loaded.	<ul style="list-style-type: none"> If operation is normal with other discs, the problem is with that disc. The track data (file) may be corrupt. → Check whether the track (file) can be played on another player, etc., capable of playing the same formats as this unit.
E-8302	CANNOT PLAY TRACK(****)	Track data (file) on the disc or storage device (SD, USB) cannot be read properly.	
E-8303	CANNOT PLAY TRACK	Track data (file) on the disc or storage device (SD, USB) cannot be read properly.	
E-8304 E-8305	UNSUPPORTED FILE FORMAT	Music files that cannot be played normally are loaded.	Format is wrong. → Replace with music files in the proper format.
E-9101	MECHANICAL TIMEOUT	Mechanical error (time out) during loading or ejecting of disc.	Displayed when mechanism operation is not completed within the specified time.

List of icons displayed on the main unit display section

	Genre		Player number (1 – 4)		SD		Open folder		Comment
	Artist		Hot Cue		Computer		Close folder		WAIT
	Album		Disc		Year		Remixer		rekordbox
	Track/file name		Registered in tag list		Label		Original artist		Mixer
	Playlist HISTORY Hot Cue Bank List		Tempo (BPM)		Key		Search		
	Rating		Color		Bit rate		DJ play count		
	Time		USB		Playing		Date library added		

Cautions on use

About condensation

Water droplets (condensation) may form inside the unit (on operating parts and lenses) in the winter, for example, if the unit is moved from a cold place into a warm room or if the temperature in the room in which the unit is installed rises suddenly (through heating, etc.). The unit will not operate properly and will not be playable with condensation inside. Let the unit stand for 1 to 2 hours at room temperature (though this time depends on the conditions of the condensation) without turning on the power. The water droplets will evaporate and the unit will become playable. Condensation can occur in the summer as well if the unit is exposed to the direct wind from an air-conditioner, etc. If this happens, move the unit to a different location.

Cleaning the lens

The player's lens should not become dirty in normal use, but if for some reason it should malfunction due to dust or dirt, consult your nearest Pioneer authorized service center. Although lens cleaners for players are commercially available, we advise against using them since some may damage the lens.

Handling discs

Storing

- Always place discs in their cases and store them vertically, avoiding hot, humid places, places exposed to direct sunlight and extremely cold places.
 - Be sure to read the cautions included with the disc.
-

Cleaning discs

- Discs may not play if there are fingerprints or dust on them. In this case, use a cleaning cloth, etc., to gently wipe the disc from the inside towards the outside. Do not use dirty cleaning cloths.

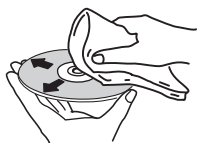

- Do not use benzene, thinner or other volatile chemicals. Also do not use record spray or antistatic agents.
- For tough dirt, apply some water to a soft cloth, wring out thoroughly, wipe off the dirt, then wipe off the moisture with a dry cloth.
- Do not use damaged (cracked or warped) discs.
- Do not let the signal surface of discs get scratched or dirty.
- Do not place two discs in the disc tray, one on top of the other.
- Do not attach pieces of paper or stickers to discs. Doing so could warp discs, making it impossible to play them. Also note that rental discs often have labels attached to them, and the label's glue may have oozed out. Check that there is no glue around the edges of such labels before using rented discs.

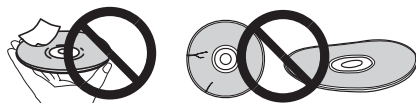

About specially shaped discs

Irregularly shaped discs other than standard 12 cm discs cannot be played on this unit (doing so will lead to damage or accidents). Specially shaped discs (heart-shaped, hexagonal, etc.) cannot be played on this unit. Do not attempt to play such discs, as they could damage the unit.



About condensation on discs

Water droplets (condensation) may form on the surface of discs if they are moved from a cold place (particularly in winter) into a warm room. Discs may not play normally if there is condensation on them. Carefully wipe the water droplets off the surface of the disc before loading it.

About trademarks and registered trademarks

- Pioneer and rekordbox are trademarks or registered trademarks of the PIONEER CORPORATION.
- Microsoft®, Windows Vista®, Windows® and Internet Explorer® are either registered trademarks or trademarks of Microsoft Corporation in the United States and/or other countries.
- Pentium is a registered trademark of Intel Corporation.
- Adobe and Reader are either registered trademarks or trademarks of Adobe Systems Incorporated in the United States and/or other countries.
- ASIO is a trademark of Steinberg Media Technologies GmbH.
- SD Logo is a trademark of SD-3C, LLC.



- SDHC Logo is a trademark of SD-3C, LLC.



- "Made for iPod," "Made for iPhone," and "Made for iPad" mean that an electronic accessory has been designed to connect specifically to iPod, iPhone, or iPad, respectively, and has been certified by the developer to meet Apple performance standards. Apple is not responsible for the operation of this device or its compliance with safety and regulatory standards. Please note that the use of this accessory with iPod, iPhone, or iPad may affect wireless performance.



- Apple, iPad, iPod, iPod touch, iPhone, iTunes, Safari, Finder, Mac, Macintosh and Mac OS are trademarks of Apple Inc., registered in the U.S. and other countries.
- Android™ is a trademark of Google Inc.
- IOS is a registered trademark or trademark of Cisco Systems, Inc. and its affiliates in the United States and certain other countries.
- Wi-Fi® is a registered mark of the Wi-Fi Alliance.

About using MP3 files

This product has been licensed for nonprofit use. This product has not been licensed for commercial purposes (for profit-making use), such as broadcasting (terrestrial, satellite, cable or other types of broadcasting), streaming on the Internet, Intranet (a corporate network) or other types of networks or distributing of electronic information (online digital music distribution service). You need to acquire the corresponding licenses for such uses. For details, see <http://www.mp3licensing.com>.

The names of companies and products mentioned herein are the trademarks of their respective owners.

Specifications

Power consumption.....	37 W
Power consumption (standby).....	0.4 W
Main unit weight.....	4.7 kg
External dimensions.....	320 mm (W) × 106.5 mm (H) × 405.7 mm (D)
Tolerable operating temperature.....	+5 °C to +35 °C
Tolerable operating humidity.....	5 % to 85 % (no condensation)

Analog audio output (AUDIO OUT L/R)

Output terminals.....	RCA terminal
-----------------------	--------------

Digital audio output (DIGITAL OUT)

Output terminals.....	RCA terminal
Output type.....	Coaxial digital (S/PDIF)

USB downstream section (USB)

Port.....	Type A
Power supply.....	5 V/2.1 A or less

USB upstream section (USB)

Port.....	Type B
-----------	--------

LAN (PRO DJ LINK)

Rating.....	100Base-TX
-------------	------------

Control output (CONTROL)

Port.....	Mini-jack
-----------	-----------

SD memory card section

File system.....	Conforming to "SD Specifications Part 2 File System Specification Version 2.00"
Max. memory capacity.....	32 GB

Main display

Display type.....	Active matrix TFT liquid crystal display (LCD)
Screen size.....	6.1-inch, wide
Supported languages.....	18 languages

- The articles concerning free repairs, etc., indicated on the warranty do not apply to the rekordbox music management software. Before installing or using rekordbox, carefully read the articles in *Software end user license agreement* on page 8.
- The specifications and design of this product are subject to change without notice.
- © 2012 PIONEER CORPORATION.
All rights reserved.

PIONEER CORPORATION

1-1, Shin-ogura, Saiwai-ku, Kawasaki-shi, Kanagawa 212-0031, Japan
<DRI1052-A>

Free Manuals Download Website

<http://myh66.com>

<http://usermanuals.us>

<http://www.somanuals.com>

<http://www.4manuals.cc>

<http://www.manual-lib.com>

<http://www.404manual.com>

<http://www.luxmanual.com>

<http://aubethermostatmanual.com>

Golf course search by state

<http://golfingnear.com>

Email search by domain

<http://emailbydomain.com>

Auto manuals search

<http://auto.somanuals.com>

TV manuals search

<http://tv.somanuals.com>