

# Operation Manual

High power CD player with FM/AM tuner

# DEH-1650

# DEH-1650B

# DEH-1690

English

Español

Português (B)

中文

العربية

**SUPER**  **TUNER III** 

## Thank you for buying this Pioneer product.

Please read through these operating instructions so you will know how to operate your model properly. *After you have finished reading the instructions, put them away in a safe place for future reference.*

### 01 Before You Start

- About this manual 3
- Precautions 3
- Protecting your unit from theft 3
  - Removing the front panel 3
  - Attaching the front panel 3

### 02 What's What

- Head unit 4

### 03 Power ON/OFF

- Turning the unit on 5
- Selecting a source 5
- Turning the unit off 5

### 04 Tuner

- Listening to the radio 6
- Storing and recalling broadcast frequencies 6
- Tuning in strong signals 7
- Storing the strongest broadcast frequencies 7

### 05 Built-in CD Player

- Playing a CD 8
- Playing tracks in a random order 8
- Repeating play 8
- Pausing CD playback 9

### 06 Audio Adjustments

- Introduction of audio adjustments 10
- Using balance adjustment 10
- Using the equalizer 10
  - Recalling equalizer curves 10
  - Adjusting equalizer curves 11
  - Fine adjusting equalizer curve 11
- Adjusting loudness 12
- Front image enhancer (F.I.E.) 12
- Adjusting source levels 12

### 07 Initial Settings

- Adjusting initial settings 13
- Setting the clock 13
  - Turning the clock display on or off 13
- Setting the FM tuning step 13
- Setting the AM tuning step 14

### Additional Information

- Understanding built-in CD player error messages 15
- CD player and care 15
- CD-R/CD-RW discs 15
- Specifications 17

## Before You Start

### About this manual

This unit features a number of sophisticated functions ensuring superior reception and operation. All the functions have been designed for the easiest possible use, but many are not self-explanatory. This operation manual will help you benefit fully from this unit's potential and to maximize your listening enjoyment. We recommend that you familiarize yourself with the functions and their operation by reading through the manual before you begin using this unit. It is especially important that you read and observe precautions on this page and in other sections. □

### Precautions

**CAUTION:**  
**USE OF CONTROL OR ADJUSTMENT OR PERFORMANCE OF PROCEDURES OTHER THAN THOSE SPECIFIED HEREIN MAY RESULT IN HAZARDOUS RADIATION EXPOSURE.**

**CAUTION:**  
**THE USE OF OPTICAL INSTRUMENTS WITH THIS PRODUCT WILL INCREASE EYE HAZARD.**

- Keep this manual handy as a reference for operating procedures and precautions.
- Always keep the volume low enough so you can hear sounds outside of the car.
- Protect this unit from moisture.
- If the battery is disconnected or discharged, the preset memory will be erased and must be reprogrammed.
- If this unit does not operate properly, contact your dealer or nearest authorized Pioneer Service Station. □

### Protecting your unit from theft

The front panel can be detached from the head unit and stored in the protective case provided to discourage theft.



#### Important

- Never use force or grip the display and the buttons tightly when removing or attaching.
- Avoid subjecting the front panel to excessive shocks.
- Keep the front panel out of direct sunlight and high temperatures.

### Removing the front panel

#### 1 Press DETACH to release the front panel.

Press **DETACH** and the right side of the panel is released from the head unit.

#### 2 Grab the front panel and remove.

Grab the right side of the front panel and pull away to the left. The front panel will be detached from the head unit.

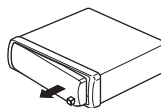

#### 3 Put the front panel into the protective case provided for safe keeping.

### Attaching the front panel

#### 1 Place the front panel flat against the head unit.

#### 2 Press the front panel into the face of the head unit until it is firmly seated. □

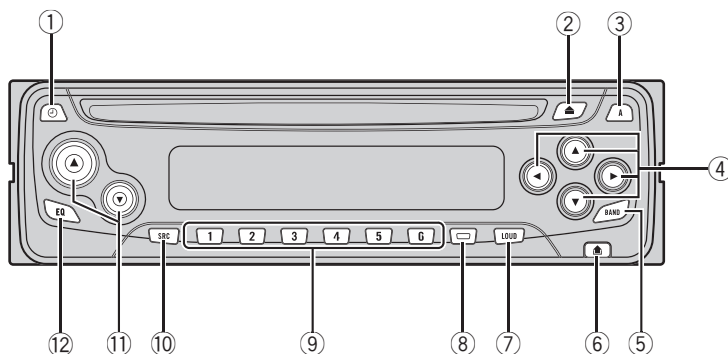

## Head unit

- ① **CLOCK button**  
Press to change to the clock display.
- ② **EJECT button**  
You can eject a CD by pressing **EJECT**.
- ③ **AUDIO button**  
Press to select various sound quality controls.
- ④ **▲/▼/◀/▶ buttons**  
Press to do manual seek tuning, fast forward, reverse and track search controls. Also used for controlling functions.
- ⑤ **BAND button**  
Press to select among three FM and one AM bands and cancel the control mode of functions.
- ⑥ **DETACH button**  
Press **DETACH** to release the front panel.
- ⑦ **LOUDNESS button**  
Press to turn loudness on or off.
- ⑧ **LOCAL/BSM button**  
Press to turn local function on or off.
- ⑨ **1–6 buttons**  
Press for preset tuning.
- ⑩ **SOURCE button**  
This unit is turned on by selecting a source. Press to cycle through all of the available sources.
- ⑪ **VOLUME**  
Press to increase or decrease the volume.
- ⑫ **EQ button**  
Press to select various equalizer curves.

## Power ON/OFF

### Turning the unit on

- **Press SOURCE to turn the unit on.**

When you select a source the unit is turned on. 

### Selecting a source

You can select a source you want to listen to. To switch to the built-in CD player, load a disc in this unit (refer to page 8).

- **Press SOURCE to select a source.**

Press **SOURCE** repeatedly to switch between the following sources:

#### **Built-in CD player—Tuner**



#### **Notes**

- When no disc has been set in the unit, the source will not switch to the built-in CD player.
- When this unit's blue/white lead is connected to the car's auto-antenna relay control terminal, the car's antenna extends when this unit's source is turned on. To retract the antenna, turn the source off. 

### Turning the unit off

- **Press SOURCE and hold until the unit turns off.** 

## Listening to the radio

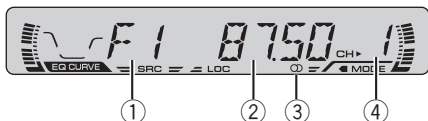

### Important

If you are using this unit in North, Central or South America, reset the AM tuning step (see *Setting the AM tuning step* on page 14).

- ① **Band indicator**  
Shows which band the radio is tuned to, AM or FM.
- ② **Frequency indicator**  
Shows to which frequency the tuner is tuned.
- ③ **Stereo (Ⓢ) indicator**  
Shows that the frequency selected is being broadcast in stereo.
- ④ **Preset number indicator**  
Shows what preset has been selected.

- 1 Press SOURCE to select the tuner.**
- 2 Use VOLUME to adjust the sound level.**
- 3 Press BAND to select a band.**  
Press **BAND** until the desired band is displayed, **F1**, **F2**, **F3** for FM or **AM**.
- 4 To perform manual tuning, press ◀ or ▶ with quick presses.**  
The frequencies move up or down step by step.

- 5 To perform seek tuning, press and hold ◀ or ▶ for about one second and release.**

The tuner will scan the frequencies until a broadcast strong enough for good reception is found.

- You can cancel seek tuning by pressing either ◀ or ▶ with a quick press.
- If you press and hold ◀ or ▶ you can skip broadcasting stations. Seek tuning starts as soon as you release the buttons.

### Note

When the frequency selected is being broadcast in stereo the stereo (Ⓢ) indicator will light. 

## Storing and recalling broadcast frequencies

If you press any of the preset tuning buttons **1–6** you can easily store up to six broadcast frequencies for later recall with the touch of a button.

- **When you find a frequency that you want to store in memory press a preset tuning button 1–6 and hold until the preset number stops flashing.**

The number you have pressed will flash in the preset number indicator and then remain lit. The selected radio station frequency has been stored in memory.

The next time you press the same preset tuning button **1–6** the radio station frequency is recalled from memory.

### Notes

- Up to 18 FM stations, 6 for each of the three FM bands, and 6 AM stations can be stored in memory.

## Tuner

- You can also use ▲ and ▼ to recall radio station frequencies assigned to preset tuning buttons **1–6**. 



### Note

Storing broadcast frequencies with BSM may replace broadcast frequencies you have saved using **1–6**. 

## Tuning in strong signals

Local seek tuning lets you tune in only those radio stations with sufficiently strong signals for good reception.

### 1 Press LOCAL/BSM to turn local seek tuning on.

**LOCAL** appears in the display.

### 2 When you want to return to normal seek tuning, press LOCAL/BSM to turn local seek tuning off.

## Storing the strongest broadcast frequencies

BSM (best stations memory) lets you automatically store the six strongest broadcast frequencies under preset tuning buttons **1–6** and once stored there you can tune in to those frequencies with the touch of a button.

### ● Press LOCAL/BSM and hold until the BSM turns on.

**BSM** begins to flash. While **BSM** is flashing the six strongest broadcast frequencies will be stored under preset tuning buttons **1–6** in order of their signal strength. When finished, **BSM** stops flashing.

- To cancel the storage process, press **LOCAL/BSM**.

## Playing a CD

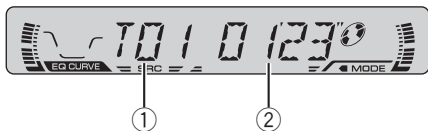

### ① Track number indicator

Shows the track currently playing.

### ② Play time indicator

Shows the elapsed playing time of the current track.

### 1 Insert a CD into the CD loading slot.

Playback will automatically start.

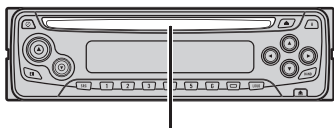

CD loading slot

- You can eject a CD by pressing **EJECT**.

### 2 After a CD has been inserted, press **SOURCE** to select the built-in CD player.

### 3 Use **VOLUME** to adjust the sound level.

### 4 To perform fast forward or reverse, press and hold ◀ or ▶.

### 5 To skip back or forward to another track, press ◀ or ▶.

Pressing ▶ skips to the start of the next track. Pressing ◀ once skips to the start of the current track. Pressing again will skip to the previous track.

## Notes

- The built-in CD player plays one, standard, 12-cm or 8-cm (single) CD at a time. Do not use an adapter when playing 8-cm CDs.
- Do not insert anything other than a CD into the CD loading slot.
- If you cannot insert a disc completely or if after you insert a disc the disc does not play, check that the label side of the disc is up. Press **EJECT** to eject the disc, and check the disc for damage before inserting the disc again.
- If the built-in CD player does not operate properly, an error message such as **ERROR-11** may be displayed. Refer to *Understanding built-in CD player error messages* on page 15.

## Playing tracks in a random order

Random play lets you play back tracks on the CD in a random order.

### 1 Press 4 to turn random play on.

**RDM** appears in the display. Tracks will play in a random order.

### 2 Press 4 to turn random play off.

Tracks will continue to play in order.

## Repeating play

Repeat play lets you hear the same track over again.

### 1 Press 5 to turn repeat play on.

**RPT** appears in the display. The track currently playing will play and then repeat.



## Built-in CD Player

### 2 Press 5 to turn repeat play off.

The track currently playing will continue to play and then play the next track.



#### Note

If you perform track search or fast forward/reverse, repeat play is automatically cancelled. 

## Pausing CD playback

Pause lets you temporarily stop playback of the CD.

### 1 Press 6 to turn pause on.

**PAUSE** appears in the display. Play of the current track pauses.

### 2 Press 6 to turn pause off.

Play will resume at the same point that you turned pause on. 

## Introduction of audio adjustments

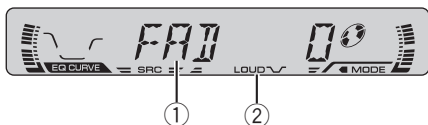

### ① Audio display

Shows the audio adjustments status.

### ② LOUD indicator

Appears in the display when loudness is turned on.

### ● Press AUDIO to display the audio function names.

Press **AUDIO** repeatedly to switch between the following audio functions:

**FAD** (balance adjustment)—**EQ** (equalizer)  
—**LOUD** (loudness)—**FIE** (front image enhancer)—**SLA** (source level adjustment)

- When selecting the FM tuner as the source, you cannot switch to **SLA**.
- To return to the display of each source, press **BAND**.



### Note

If you do not operate the audio function within about 30 seconds, the display is automatically returned to the source display.

## Using balance adjustment

You can select a fader/balance setting that provides an ideal listening environment in all occupied seats.

### 1 Press AUDIO to select FAD.

Press **AUDIO** until **FAD** appears in the display.

- If the balance setting has been previously adjusted, **BAL** will be displayed.

### 2 Press ▲ or ▼ to adjust front/rear speaker balance.

Each press of ▲ or ▼ moves the front/rear speaker balance towards the front or the rear. **FAD F15** – **FAD R15** is displayed as the front/rear speaker balance moves from front to rear.

- **FAD 0** is the proper setting when only two speakers are used.

### 3 Press ◀ or ▶ to adjust left/right speaker balance.

When you press ◀ or ▶, **BAL 0** is displayed.

Each press of ◀ or ▶ moves the left/right speaker balance towards the left or the right.

**BAL L9** – **BAL R9** is displayed as the left/right speaker balance moves from left to right.

## Using the equalizer

The equalizer lets you adjust the equalization to match car interior acoustic characteristics as desired.

## Recalling equalizer curves

There are six stored equalizer curves which you can easily recall at any time. Here is a list of the equalizer curves:

Display	Equalizer curve
<b>SPR-BASS</b>	Super bass
<b>POWERFUL</b>	Powerful
<b>NATURAL</b>	Natural
<b>VOCAL</b>	Vocal
<b>CUSTOM</b>	Custom
<b>EQ FLAT</b>	Flat

- **CUSTOM** is an adjusted equalizer curve that you create.

## Audio Adjustments

- When **EQ FLAT** is selected no supplement or correction is made to the sound. This is useful to check the effect of the equalizer curves by switching alternatively between **EQ FLAT** and a set equalizer curve.

### ● Press EQ to select the equalizer.

Press **EQ** repeatedly to switch between the following equalizers:

**SPR-BASS—POWERFUL—NATURAL—VOCAL—CUSTOM—EQ FLAT**

## Adjusting equalizer curves

You can adjust the currently selected equalizer curve setting as desired. Adjusted equalizer curve settings are memorized in **CUSTOM**.

### 1 Press AUDIO to select EQ.

Press **AUDIO** until **EQ** appears in the display.

### 2 Press ◀ or ▶ to select the equalizer band to adjust.

Each press of ◀ or ▶ selects equalizer bands in the following order:

**EQ-L** (low)—**EQ-M** (mid)—**EQ-H** (high)

### 3 Press ▲ or ▼ to adjust the level of the equalizer band.

Each press of ▲ or ▼ increases or decreases the level of the equalization band.

**+6** — **-6** is displayed as the level is increased or decreased.

- You can then select another band and adjust the level.



### Note

If you make adjustments when a curve other than **CUSTOM** is selected, the newly adjusted curve will replace the previous curve. Then a new curve with **CUSTOM** appears on the display while selecting the equalizer curve.

## Fine adjusting equalizer curve

You can adjust the center frequency and the Q factor (curve characteristics) of each currently selected curve band (**EQ-L/EQ-M/EQ-H**).

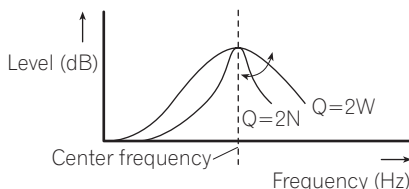

**1 Press AUDIO and hold until frequency and the Q factor (e.g., F- 80 Q 1W) appears in the display.**

**2 Press AUDIO to select the desired band for adjustment.**

Low—Mid—High

**3 Press ◀ or ▶ to select the desired frequency.**

Press ◀ or ▶ until the desired frequency appears in the display.

Low: **40—80—100—160** (Hz)

Mid: **200—500—1k—2k** (Hz)

High: **3k—8k—10k—12k** (Hz)

**4 Press ▲ or ▼ to select the desired Q factor.**

Press ▲ or ▼ until the desired Q factor appears in the display.

**2N—1N—1W—2W**



### Note

If you make adjustments when a curve other than **CUSTOM** is selected, the newly adjusted curve will replace the previous curve. Then a new curve with **CUSTOM** appears on the display while selecting the equalizer curve. □

## Adjusting loudness

Loudness compensates for deficiencies in the low- and high-sound ranges at low volume.

### 1 Press **AUDIO** to select **LOUD**.

Press **AUDIO** until **LOUD** appears in the display.

### 2 Press **▲** to turn loudness on.

**LOUD** indicator is displayed.

- To turn loudness off, press **▼**.

### 3 Press **◀** or **▶** to select a desired level.

Each press of **◀** or **▶** selects level in the following order:

**LOW** (low)—**MID** (mid)—**HI** (high)

#### Note

You can also turn loudness on or off by pressing **LOUDNESS**. 

## Front image enhancer (F.I.E.)

The F.I.E. (Front Image Enhancer) function is a simple method of enhancing front imaging by cutting mid- and high-range frequency output from the rear speakers, limiting their output to low-range frequencies. You can select the frequency you want to cut.

#### Precaution

When the F.I.E. function is deactivated, the rear speakers output sound of all frequencies, not just bass sounds. Reduce the volume before disengaging F.I.E. to prevent a sudden increase in volume.

### 1 Press **AUDIO** to select **FIE**.

Press **AUDIO** until **FIE** appears in the display.

### 2 Press **▲** to turn F.I.E. on.

- To turn F.I.E. off, press **▼**.

### 3 Press **◀** or **▶** to select a desired frequency.

Each press of **◀** or **▶** selects frequency in the following order:

**100—160—250** (Hz)

#### Notes

- After turning the F.I.E. function on, use the balance adjustment (refer to page 10) and adjust front and rear speaker volume levels until they are balanced.
- Turn the F.I.E. function off when using a 2-speaker system. 

## Adjusting source levels

SLA (source level adjustment) lets you adjust the volume level of each source to prevent radical changes in volume when switching between sources.

- Settings are based on the FM tuner volume level, which remains unchanged.

### 1 Compare the FM tuner volume level with the level of the source you wish to adjust.

### 2 Press **AUDIO** to select **SLA**.

Press **AUDIO** until **SLA** appears in the display.

### 3 Press **▲** or **▼** to adjust the source volume.

Each press of **▲** or **▼** increases or decreases the source volume.

**SLA +4 – SLA –4** is displayed as the source volume is increased or decreased.

#### Note

The AM tuner volume level can also be adjusted with source level adjustments. 

## Initial Settings

### Adjusting initial settings



Initial settings lets you perform initial set up of different settings for this unit.

**1 Press SOURCE and hold until the unit turns off.**

**2 Press AUDIO and hold until clock appears in the display.**

Press **AUDIO** repeatedly to switch between the following settings:

Clock—**FM 100** (FM tuning step)—**AM 9** (AM tuning step)

Use the following instructions to operate each particular setting.

- To cancel initial settings, press **BAND**.
- You can also cancel initial settings by holding down **AUDIO** until the unit turns off. 

### Setting the clock

Use these instructions to set the clock.

**1 Press AUDIO to select clock.**

Press **AUDIO** repeatedly until clock appears in the display.

**2 Press ◀ or ▶ to select the segment of the clock display you wish to set.**

Pressing ◀ or ▶ will select one segment of the clock display:

Hour—Minute

As you select segments of the clock display the segment selected will blink.



**3 Press ▲ or ▼ to set the clock.**

Pressing ▲ will increase the selected hour or minute. Pressing ▼ will decrease the selected hour or minute.

### Turning the clock display on or off

You can turn the clock display on or off.

● **Press CLOCK to turn the clock display on or off.**

Each press of **CLOCK** turns the clock display on or off.

- The clock display disappears temporarily when you perform other operations, but the clock display appears again after 25 seconds. 

### Setting the FM tuning step

The FM tuning step employed by seek tuning can be switched between 100 kHz, the preset step, and 50 kHz.

**1 Press AUDIO to select FM 100.**

Press **AUDIO** repeatedly until **FM 100** appears in the display.

**2 Press ◀ or ▶ to select the FM tuning step.**

Pressing ◀ or ▶ will switch the FM tuning step between 100 kHz and 50 kHz. The selected FM tuning step will appear in the display.



#### Note

If seek tuning is performed in 50 kHz steps, stations may be tuned in imprecisely. Tune in the stations with manual tuning or use seek tuning again. 

## Setting the AM tuning step

The AM tuning step can be switched between 9 kHz, the preset step, and 10 kHz. When using the tuner in North, Central or South America, reset the tuning step from 9 kHz (531 – 1,602 kHz allowable) to 10 kHz (530 – 1,640 kHz allowable).

### 1 Press **AUDIO** to select **AM 9**.

Press **AUDIO** repeatedly until **AM 9** appears in the display.

### 2 Press **◀** or **▶** to select the **AM tuning step**.

Pressing **◀** or **▶** will switch the AM tuning step between 9 kHz and 10 kHz. The selected AM tuning step will appear in the display. 

## Additional Information

### Understanding built-in CD player error messages

When problems occur during CD play an error message may appear on the display. If an error message appears on the display refer to the table below to see what the problem is and the suggested method of correcting the problem. If the error cannot be corrected, contact your dealer or your nearest Pioneer Service Center.

Message	Cause	Action
<b>ERROR-11, 12, 17, 30</b>	Dirty disc	Clean disc.
<b>ERROR-11, 12, 17, 30</b>	Scratched disc	Replace disc.
<b>ERROR-10, 11, 12, 17, 30, A0</b>	Electrical or mechanical	Turn the ignition ON and OFF, or switch to a different source, then back to the CD player.
<b>ERROR-44</b>	All tracks are skip tracks	Replace disc.



### CD player and care

- Use only CDs that have the Compact Disc Digital Audio mark as show below.



- Use only normal, round CDs. If you insert irregular, non-round, shaped CDs they may jam in the CD player or not play properly.



- Check all CDs for cracks, scratches or warped discs before playing. CDs that have cracks, scratches or are warped may not play properly. Do not use such discs.
- Avoid touching the recorded (non-printed side) surface when handling the disc.
- Store discs in their cases when not in use.
- Keep discs out of direct sunlight and do not expose the discs to high temperatures.
- Do not attach labels, write on or apply chemicals to the surface of the discs.
- To clean dirt from a CD, wipe the disc with a soft cloth outward from the center of the disc.



- If the heater is used in cold weather, moisture may form on components inside the CD player. Condensation may cause the CD player to not operate properly. If you think that condensation is a problem turn off the CD player for an hour or so to allow the CD player to dry out and wipe any damp discs with a soft cloth to remove the moisture.
- Road shocks may interrupt CD playback. ■

### CD-R/CD-RW discs

- When CD-R/CD-RW discs are used, playback is possible only for discs which have been finalized.
- It may not be possible to play back CD-R/CD-RW discs recorded on a music CD recorder or a personal computer because of disc characteristics, scratches or dirt on the disc, or dirt, condensation, etc. on the lens of this unit.

## Additional Information

- Playback of discs recorded on a personal computer may not be possible depending on the application settings and the environment. Please record with the correct format. (For details, contact the manufacturer of the application.)
- Playback of CD-R/CD-RW discs may become impossible in case of direct exposure to sunlight, high temperatures, or the storage conditions in the car.
- This unit conforms to the track skip function of the CD-R/CD-RW disc. The tracks containing the track skip information are skipped automatically.
- If you insert a CD-RW disc into this unit, time to playback will be longer than when you insert a conventional CD or CD-R disc.
- Read the precautions with CD-R/CD-RW discs before using them. 



## Additional Information

### Specifications

#### General

Rated power source .....	14.4 V DC
	(allowable voltage range: 12.0 – 14.4 V DC)
Grounding system .....	Negative type
Max. current consumption .....	10.0 A
Dimensions (W × H × D):	
DIN	
Chassis .....	178 × 50 × 157 mm
Nose .....	188 × 58 × 19 mm
D	
Chassis .....	178 × 50 × 162 mm
Nose .....	170 × 48 × 14 mm
Weight .....	1.3 kg

#### Audio

Continuous power output is 22 W per channel minimum into 4 ohms, both channels driven 50 to 15,000 Hz with no more than 5% THD.

Maximum power output .....	50 W × 4
Load impedance .....	4 Ω (4 – 8 Ω allowable)
Preout max output level/output impedance .....	2.2 V/1 kΩ

Equalizer (3-Band Parametric Equalizer):

Low	
Frequency .....	40/80/100/160 Hz
Q Factor .....	0.35/0.59/0.95/1.15 (+6 dB when boosted)
Gain .....	±12dB
Mid	
Frequency .....	200/500/1k/2k Hz
Q Factor .....	0.35/0.59/0.95/1.15 (+6 dB when boosted)
Gain .....	±12dB
High	
Frequency .....	3.15k/8k/10k/12.5k Hz
Q Factor .....	0.35/0.59/0.95/1.15 (+6 dB when boosted)
Gain .....	±12dB

Loudness contour

Low .....	+3.5 dB (100 Hz), +3 dB (10 kHz)
Mid .....	+10 dB (100 Hz), +6.5 dB (10 kHz)
High .....	+11 dB (100 Hz), +11 dB (10 kHz) (volume: –30 dB)

#### CD player

System .....	Compact disc audio system
Usable discs .....	Compact disc
Signal format:	
Sampling frequency .....	44.1 kHz
Number of quantization bits .....	16; linear
Frequency characteristics ...	5 – 20,000 Hz (±1 dB)
Signal-to-noise ratio .....	94 dB (1 kHz) (IEC-A network)
Dynamic range .....	92 dB (1 kHz)
Number of channels .....	2 (stereo)

#### FM tuner

Frequency range .....	87.5 – 108.0 MHz
Usable sensitivity .....	8 dBf (0.7 μV/75 Ω mono, S/N: 30 dB)
50 dB quieting sensitivity .....	10 dBf (0.9 μV/75 Ω mono)
Signal-to-noise ratio .....	75 dB (IEC-A network)
Distortion .....	0.3 % (at 65 dBf, 1 kHz, stereo) 0.1 % (at 65 dBf, 1 kHz, mono)
Frequency response .....	30 – 15,000 Hz (±3 dB)
Stereo separation .....	45 dB (at 65 dBf, 1 kHz)

#### AM tuner

Frequency range .....	531 – 1,602 kHz (9 kHz) 530 – 1,640 kHz (10 kHz)
Usable sensitivity .....	18 μV (S/N: 20 dB)
Signal-to-noise ratio .....	65 dB (IEC-A network)



#### Note

Specifications and the design are subject to possible modifications without notice due to improvements. 

# Informações adicionais

## Especificações

### Generalidades

Fonte de alimentação nominal  
 ..... 14,4 V DC  
 (faixa de tensão permissível:  
 12,0 – 14,4 V DC)

Sistema de aterramento ..... Tipo negativo

Consumo máx. de energia  
 ..... 10,0 A

Dimensões (L × A × P):

DIN

Chassi ..... 178 × 50 × 157 mm  
 Face ..... 188 × 58 × 19 mm

D

Chassi ..... 178 × 50 × 162 mm  
 Face ..... 170 × 48 × 14 mm

Peso ..... 1,3 kg

### Áudio

A potência de saída contínua é de 22 W por canal, mínimo a 4 ohms, ambos os canais acionados, 50 a 15.000 Hz com não mais de 5% de THD.

Potência de saída máxima  
 ..... 50 W × 4

Impedância de carga ..... 4 Ω (4 – 8 Ω permissível)

Nível de saída máx. pré-saída/impedância de saída  
 ..... 2,2 V/1 kΩ

Equalizador (Equalizador paramétrico de 3 bandas):

#### Baixo

Frequência ..... 40/80/100/160 Hz  
 Fator Q ..... 0,35/0,59/0,95/1,15 (+6 dB quando intensificado)  
 Ganho ..... ±12 dB

#### Médio

Frequência ..... 200/500/1k/2k Hz  
 Fator Q ..... 0,35/0,59/0,95/1,15 (+6 dB quando intensificado)  
 Ganho ..... ±12 dB

#### Alto

Frequência ..... 3,15 k/8 k/10 k/12,5 k Hz  
 Fator Q ..... 0,35/0,59/0,95/1,15 (+6 dB quando intensificado)  
 Ganho ..... ±12 dB

Contorno de sonoridade

Baixo ..... +3,5 dB (100 Hz), +3 dB (10 kHz)  
 Médio ..... +10 dB (100 Hz), +6,5 dB (10 kHz)  
 Alto ..... +11 dB (100 Hz), +11 dB (10 kHz)  
 (volume: –30 dB)

### CD player

Sistema ..... Sistema de áudio de CDs

Discos utilizáveis ..... CDs

Formato do sinal:  
 Frequência de amostragem ..... 44,1 kHz  
 Número de bits de quantização ..... 16; linear

Características de frequência  
 ..... 5 – 20.000 Hz (±1 dB)

Relação do sinal ao ruído .... 94 dB (1 kHz) (rede IEC-A)

Faixa dinâmica ..... 92 dB (1 kHz)

Número de canais ..... 2 (estéreo)

### Sintonizador de FM

Faixa de frequências ..... 87,5 – 108,0 MHz

Sensibilidade utilizável ..... 8 dBf (0,7 μV/75 Ω mono, Sinal/Ruído: 30 dB)

Sensibilidade de silêncio a 50 dB  
 ..... 10 dBf (0,9 μV/75 Ω mono)

Relação do sinal ao ruído .... 75 dB (rede IEC-A)

Distorção ..... 0,3 % (a 65 dBf, 1 kHz, estéreo)  
 0,1 % (a 65 dBf, 1 kHz, mono)

Resposta de frequência ..... 30 – 15.000 Hz (±3 dB)

Separação de estéreo ..... 45 dB (a 65 dBf, 1 kHz)

### Sintonizador de AM

Faixa de frequências ..... 531 – 1.602 kHz (9 kHz)  
 530 – 1.640 kHz (10 kHz)

Sensibilidade utilizável ..... 18 μV (Sinal/Ruído: 20 dB)

Relação do sinal ao ruído .... 65 dB (rede IEC-A)



### Nota

As especificações e o design estão sujeitos a possíveis modificações sem prévio aviso devido aos avanços.

## 感謝惠購先鋒產品。

請通讀使用說明書以了解本型號的正確操作方法。通讀完畢後，請妥善保存，以備日後參考。

### 01 開始使用之前

- 關於本說明書 53
- 注意事項 53
- 本機之防盜 53
  - 拆卸前面板 53
  - 安裝前面板 53

### 02 按鈕功能

- 主機 54

### 03 電源ON/OFF

- 開啟本機 55
- 選擇播放源 55
- 關閉本機 55

### 04 調諧器

- 收聽收音機 56
- 保存和調出廣播頻率 56
- 收聽強信號 56
- 保存最強之廣播頻率 57

### 05 內置式光碟機

- 播放CD 58
- 按隨機順序播放曲目 58
- 重複播放 58
- 暫停CD播放 58

### 06 音頻調節

- 音頻調節之介紹 59
- 使用平衡調節 59
- 使用等化器 59
  - 調用等化器曲線 59
  - 調節等化器曲線 59
  - 微調等化器曲線 60
- 調節響度 60
- 前座音像增強器 (F. I. E.) 60
- 調節音源電平 61

### 07 初始設定

- 調節初始設定 62
- 設定時鐘 62
  - 打開或關閉時鐘顯示 62
- 設定FM調頻間隔 62
- 設定AM調頻間隔 62

### ● 附加資訊

- 內置式光碟機錯誤訊息之含義 63
- 光碟機及其養護 63
- CD-R/CD-RW碟片 63
- 規格 64

## 開始使用之前

### 關於本說明書

本機具備一系列高級功能，以確保接受效果和操作性能俱佳。所有這些功能均為盡可能方便使用而設計，但其中多數未自帶說明。本使用說明書將助您充分揮本機性能，從而獲得最佳的聽覺享受。

我們建議您在開始使用本機之前先通讀本說明書，熟悉其功能以及相關操作。尤為重要的是要閱讀並遵循本頁以及其他章節中之注意事項。▣

### 注意事項

- 請將本說明書保存於隨手可取之處，以備查閱操作步驟及注意事項。
- 請務必保持在適當的音量，以能聽見車外的聲響為準。
- 請注意本機的防潮。
- 如果電池未接通或電量用完，預設記憶將被抹去，必須重新編序。
- 如果本機無法正常工作，請與經銷商或就近的先鋒授權服務站聯繫。▣

### 本機之防盜

前面板可從主機卸下放入附帶之防盜保險箱以免被盜。

#### 重要

- 拆裝時切勿魯莽或用力抓住顯示幕與按鈕。
- 請避免使前面板受到劇烈撞擊。
- 請將前面板遠離直射陽光下和高溫。

### 拆卸前面板

- 1 按DETACH松脫前面板。

按DETACH，面板右側即從主機松脫。

- 2 抓住前面板將其卸下。

抓住前面板右側並將其向左拔出。前面板將從主機卸下。

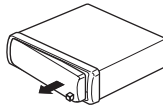

- 3 將前面板放入附帶之防盜保險箱安全存放。

### 安裝前面板

- 1 將前面板平放於主機。
- 2 將前面板按入主機表面直至固定到位。▣

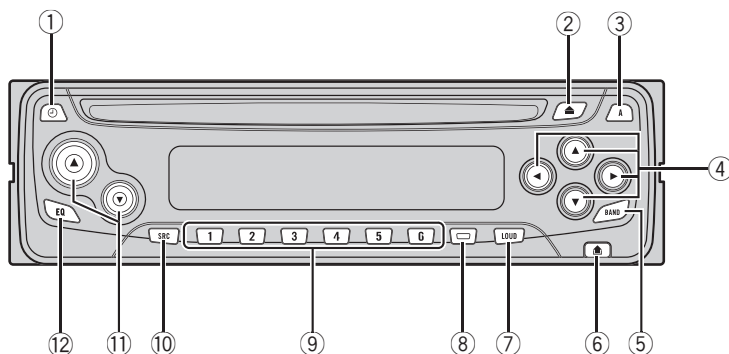

## 主機

### ① CLOCK按鈕

按該按鈕可換至時鐘顯示。

### ② EJECT按鈕

按EJECT可退出CD。

### ③ AUDIO按鈕

按該按鈕可選擇各種音質控制。

### ④ ▲/▼/◀/▶按鈕

按該按鈕可進行手動搜尋調頻，快進，快倒和曲目搜尋控制。同樣亦可用於功能之控制。

### ⑤ BAND按鈕

按該按鈕可從三個FM波段與一個AM波段中選擇，以及取消功能之控制模式。

### ⑥ DETACH按鈕

按DETACH松脫前面板。

### ⑦ LOUDNESS按鈕

按該按鈕可開關響度。

### ⑧ LOCAL/BSM按鈕

按該按鈕可開關本地功能。  
按住該按鈕可開關BSM功能。

### ⑨ 1-6按鈕

按該按鈕可進行預設調頻。

### ⑩ SOURCE按鈕

選擇一個播放源可開啟本機。按該按鈕可在所有播放源之間循環。

### ⑪ VOLUME

按該按鈕可調高或調低音量。

### ⑫ EQ按鈕

按該按鈕可選擇各種等化器曲線。▣

## 電源ON/OFF

### 開啟本機

- 按SOURCE可開啟本機。  
當選擇播放源時，本機開啟。▣

### 選擇播放源

可選擇一個欲收聽之播放源。切換至內置式光碟機時，請在本機中裝入一張碟片（請參見第58頁）。

- 按SOURCE選擇播放源。  
反覆按SOURCE可在以下播放源之間進行切換：  
內置式光碟機－調諧器



#### 注意

- 當本機中無碟片裝入時，播放源將無法切換至內置式光碟機。
- 當本機之藍色／白色引線連接至汽車自動天線中繼控制端子時，汽車天線會在本機播放源啟動時伸出。收回天線時，請關閉播放源。▣

### 關閉本機

- 按住SOURCE直至本機關閉。▣

## 收聽收音機

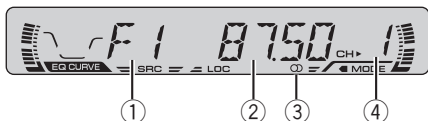

### 重要

如果在北美，中美或南美使用本機，請將AM調頻間隔復位（請參見第62頁上設定AM調頻間隔）。

#### ① 波段指示器

顯示收音機調頻之波段是AM或FM。

#### ② 頻率指示器

顯示調諧器調頻至之頻率。

#### ③ 立體聲 (Ⓞ) 指示器

顯示所選之頻率正用立體聲廣播。

#### ④ 預設號碼指示器

顯示已經選擇之預設號碼。

#### 1 按SOURCE選擇調諧器。

#### 2 使用VOLUME可調節聲音大小。

#### 3 按BAND選擇波段。

按住BAND直至所需的波段顯示，F1，F2，F3為FM或AM。

#### 4 進行手動調頻時，請迅速按◀或▶。

頻率按間隔上下移動。

#### 5 進行搜尋調頻時，請按住◀或▶大約一秒鐘後放開。

調諧器將掃描頻率直至找到一個收聽效果好之強信號廣播節目。

- 迅速按◀或▶可取消搜尋調頻。
- 如果按住◀或▶可在廣播電臺之間跳躍。一旦放開按鈕則搜尋調頻立即開始。



### 注意

當所選頻率正用立體聲廣播時，立體聲 (Ⓞ) 指示器將會亮起。◻

## 保存和調出廣播頻率

如果按任何一個預設調頻按鈕1-6，可輕鬆保存最多六個廣播頻率，以後只需觸摸按鈕即可將其調出。

- 當找到欲保存在記憶體中之頻率時，按住一個預設調頻按鈕1-6直至該預設號碼停止閃爍。

已經按下之號碼將在預設號碼指示器中閃爍，然後持續亮起。所選廣播電臺頻率已經存入記憶體中。

以後按該預設調頻按鈕1-6廣播電臺頻率即從記憶體中調出。



### 注意

- 最多18個FM電臺（三個FM波段各6個）以及6個AM電臺可保存在記憶體中。
- 亦可使用▲與▼調出指定在預設調諧按鈕1-6上之廣播電臺頻率。◻

## 收聽強信號

本地頻道搜尋只能收聽到信號足夠強，接收效果好之廣播電臺。

#### 1 按LOCAL/BSM開啟本地頻道搜尋。

LOCAL在顯示幕中出現。

#### 2 欲返回至正常搜尋調頻時，請按LOCAL/BSM關閉本地頻道搜尋。◻

## 保存最強之廣播頻率

BSM（最佳電臺記憶）可在預設調頻按鈕**1-6**下自動保存六個最強之廣播頻率，一旦保存，則只需觸摸按鈕即可收聽這些頻率。

- 按住**LOCAL/BSM**直至BSM開啟。**BSM**開始閃爍。在**BSM**閃爍時，這六個最強之廣播頻率將按其信號強度順序保存在預設調頻按鈕**1-6**下。當保存完畢時，**BSM**停止閃爍。
  - 取消保存進程時，請按**LOCAL/BSM**。



### 注意

用BSM保存廣播頻率會替換用**1-6**已經保存入之廣播頻率。■



## 播放CD

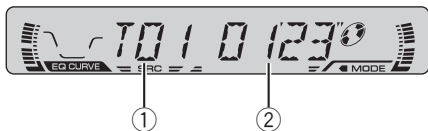

### ① 曲目號碼指示器

顯示當前正在播放之曲目。

### ② 播放時間指示器

顯示當前曲目已播放的時間。

#### 1 將CD插入CD槽。

播放將自動開始。

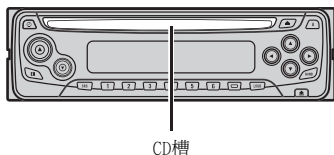

■ 按**EJECT**可退出CD。

2 在CD插入後，請按**SOURCE**選擇內置式光碟機。

3 使用**VOLUME**可調節聲音大小。

4 快進或快倒時，請按住**◀**或**▶**。

5 要向後或向前跳躍至另一曲目，請按**◀**或**▶**。

按**▶**跳躍至下一曲目的開始位置。按**◀**跳躍至當前曲目之開始位置。再按則跳躍至前一曲目。

### 注意

- 內置式光碟機一次播放一張標準12 cm或8 cm（單面）CD。播放8 cm CD時請勿使用適配器。
- CD槽中請勿插入CD以外的任何其他物品。
- 如果不能將碟片完全插入或者碟片在插入後無法播放，請檢查碟片之標籤面是否朝上。

按**EJECT**退出碟片，然後檢查碟片是否損壞，再重新插入碟片。

- 如果內置式光碟機無法正常工作，則會顯示錯誤訊息，例如**ERROR-11**等。請參見第63頁上內置式光碟機錯誤訊息之含義。□

## 按隨機順序播放曲目

隨機播放功能可按隨機順序播放CD之曲目。

#### 1 按4開啟隨機播放。

**RDM**在顯示幕中出現。曲目將按隨機順序播放。

#### 2 按4關閉隨機播放。

曲目將繼續依次播放。□

## 重複播放

重複播放功能可使聽到同一首曲目之反覆播放。

#### 1 按5開啟重複播放。

**RPT**在顯示幕中出現。當前播放之曲目將播放，並再重複。

#### 2 按5關閉重複播放。

當前播放之曲目將繼續播放，然後下一首曲目播放。

### 注意

如果進行曲目搜尋或快進／快倒，則重複播放會自動取消。□

## 暫停CD播放

暫停功能可暫時停止CD之播放。

#### 1 按6開啟暫停。

**PAUSE**在顯示幕中出現。當前曲目之播放暫停。

#### 2 按6關閉暫停。

播放將從暫停開啟的同一位置恢復。□

## 音頻調節

## 音頻調節之介紹

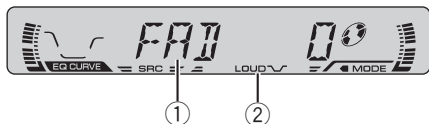

## ① 音頻顯示

顯示音頻調節狀態。

## ② LOUD指示器

當響度開啟時在顯示幕出現。

## ● 按AUDIO顯示音頻功能名稱。

反覆按**AUDIO**可在以下音頻功能之間進行切換：

**FAD**（平衡調節）— **EQ**（等化器）— **LOUD**（響度）— **FIE**（前座音像增強器）— **SLA**（音源電平調節）

- 選擇FM調諧器作為播放源時，將無法切換至**SLA**。
- 返回至各播放源之顯示時，請按**BAND**。

## 注意

如果不在30秒之內操作音頻功能，顯示幕將自動返回至播放源顯示。▣

## 使用平衡調節

可選擇衰減器／平衡設定，它能为所有就座位置提供一個理想聽覺環境。

## 1 按AUDIO選擇FAD。

按住**AUDIO**直至**FAD**在顯示幕中出現。

- 如果平衡設定以前已經調節，則**BAL**將顯示。

## 2 按▲或▼調節前置／後置揚聲器平衡。

每按一次▲或▼會使前置／後置揚聲器平衡向前或向後移動。

**FAD F15**—**FAD R15**隨前置／後置揚聲器平衡從前向後移動時顯示。

- **FAD 0**為只使用兩個揚聲器時之正確設定。

## 3 按◀或▶調節左置／右置揚聲器平衡。

當按◀或▶時，**BAL 0**顯示。每按一次◀或▶會使左置／右置揚聲器平衡向左或向右移動。

**BAL L9**—**BAL R9**隨左置／右置揚聲器平衡從左向右移動時顯示。▣

## 使用等化器

等化器可調節等化使之與車內音響特性實現完美匹配。

## 調用等化器曲線

等化器曲線共存有六條，可隨時輕鬆調出。以下為等化器曲線列表：

顯示	等化器曲線
<b>SPR-BASS</b>	超強低音
<b>POWERFUL</b>	強勁
<b>NATURAL</b>	自然
<b>VOCAL</b>	人聲
<b>CUSTOM</b>	個人設定
<b>EQ FLAT</b>	無效果

- **CUSTOM**為創建經調節之等化器曲線。
- 當選擇**EQ FLAT**時，對聲音不予補充或校正。這有助於通過在**EQ FLAT**與所設等化器曲線之間切換以檢查等化器曲線之效果。

## ● 按EQ選擇等化器。

反覆按**EQ**可在以下等化器之間進行切換：

**SPR-BASS**—**POWERFUL**—**NATURAL**—**VOCAL**—**CUSTOM**—**EQ FLAT**

## 調節等化器曲線

可按要求調節當前所選之等化器曲線。經調節之等化器曲線被存入**CUSTOM**中。

## 音頻調節

## 1 按AUDIO選擇EQ。

按住**AUDIO**直至**EQ**在顯示幕中出現。

## 2 按◀或▶選擇需調節之等化器頻帶。

每按一次◀或▶可按以下順序選擇等化器頻帶：

**EQ-L**（低頻）— **EQ-M**（中頻）— **EQ-H**（高頻）

## 3 按▲或▼調節等化器頻帶之電平。

每按一次▲或▼即增大或減小等化器頻帶之電平。

+6—-6會隨著電平增大或減小顯示。

- 然後可選擇另一頻帶並調節其電平。



## 注意

如果進行調節時所選曲線非**CUSTOM**，則新調節曲線將替換以前之曲線。然後，在選擇等化器曲線時顯示幕上出現帶**CUSTOM**的新曲線。

## 微調等化器曲線

可調節當前所選各曲線頻帶（**EQ-L/EQ-M/EQ-H**）之中心頻率及Q因子（曲線特性）。

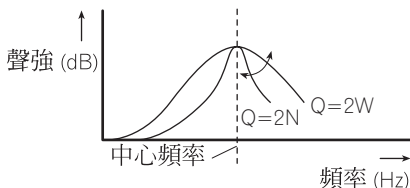

1 按住**AUDIO**直至頻率及Q因子（例如，**F-80 Q 1W**等）出現在顯示幕上。

2 按**AUDIO**選擇所需調節之頻帶。

低頻—中頻—高頻

3 按◀或▶選擇所需頻率。

按◀或▶直至所需頻率出現在顯示幕上。

低頻：40—80—100—160（Hz）

中頻：200—500—1k—2k（Hz）

高頻：3k—8k—10k—12k（Hz）

4 按▲或▼選擇所需Q因子。

按▲或▼直至所需Q因子出現在顯示幕上。

**2N—1N—1W—2W**



## 注意

如果進行調節時所選曲線非**CUSTOM**，則新調節曲線將替換以前之曲線。然後，在選擇等化器曲線時顯示幕上出現帶**CUSTOM**的新曲線。□

## 調節響度

響度可在低音量時補償低音及高音音域中之不足。

1 按**AUDIO**選擇**LOUD**。

按住**AUDIO**直至**LOUD**在顯示幕中出現。

2 按▲開啟響度。

**LOUD**指示器顯示。

- 關閉響度時，請按▼。

3 按◀或▶選擇所需電平。

每按一次◀或▶可按以下順序選擇電平：

**LOW**（低）— **MID**（中）— **HI**（高）



## 注意

亦可通過按**LOUDNESS**開關響度。□

## 前置音像增強器（F.I.E.）

F. I. E.（前置音像增強器）功能乃通過過濾後置揚聲器之中頻和高頻輸出，限制低頻輸出以增強前置音像之簡易方法。所需過濾之頻率可以選擇。



## 注意事項

當F. I. E. 功能無效時，後置揚聲器輸出所有頻率之聲音，而不只低音聲音。解除F. I. E. 功能之前請降低音量，以避免音量驟然升高。

## 音頻調節

### 1 按AUDIO選擇FIE。

按住**AUDIO**直至**FIE**在顯示幕中出現。

### 2 按▲開啟F.I.E。

- 關閉F. I. E. 時，請按▼。

### 3 按◀或▶選擇所需頻率。

每按一次◀或▶可按以下順序選擇頻率：

**100 – 160 – 250** (Hz)

#### 注意

- 開啟F. I. E. 功能之後，使用平衡調節（請參見第59頁）調節前置和後置揚聲器音量電平直至達到平衡。
- 使用雙揚聲器系統時請關閉F. I. E. 功能。◻

## 調節音源電平

SLA（音源電平調節）可調節各播放源之音量電平，以免在播放源之間切換時音量驟然變化。

- 設定以FM調諧器之音量電平為依據，該音量電平保持不變。

### 1 將FM調諧器音量電平與所需調節之播放源音量電平進行對比。

### 2 按AUDIO選擇SLA。

按住**AUDIO**直至**SLA**在顯示幕中出現。

### 3 按▲或▼調節播放源音量。

每按一次▲或▼即調高或調低播放源音量。

**SLA +4 – SLA –4**隨著播放源音量被調高或調低而顯示。

#### 注意

AM調諧器之音量電平亦可隨音源電平調節而調節。◻

## 初始設定

### 調節初始設定



初始設定功能可對本機之各種設定進行初始設置。

- 1 按住**SOURCE**直至本機關閉。
- 2 按住**AUDIO**直至時鐘在顯示幕中出現。  
反覆按**AUDIO**可在以下設定之間切換：  
時鐘 – **FM 100** (FM調頻間隔) – **AM 9** (AM調頻間隔)  
請按照以下說明進行各項設定。
  - 取消初始設定時，請按**BAND**。
  - 亦可通過按住**AUDIO**直至本機關閉以取消初始設定。□

### 設定時鐘

請按照這些說明設定時鐘。

- 1 按**AUDIO**選擇時鐘。  
反覆按**AUDIO**直至時鐘在顯示幕中出現。
- 2 按**◀**或**▶**選擇所需設定之時鐘顯示部分。  
按**◀**或**▶**將選擇時鐘顯示之一部分：  
小時 – 分鐘  
隨著時鐘顯示某部分被選，所選部分將閃爍。

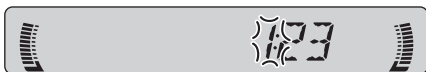

- 3 按**▲**或**▼**設定時鐘。  
按**▲**會增大所選小時或分鐘數。按**▼**會減小所選小時或分鐘數。

### 打開或關閉時鐘顯示

可打開或關閉時鐘顯示。

- 按**CLOCK**可打開或關閉時鐘顯示。  
每按一次**CLOCK**即打開或關閉時鐘顯示。
  - 進行其他操作時，時鐘顯示會暫時消失；但是在25秒後時鐘顯示會再次出現。□

### 設定FM調頻間隔

搜尋調頻所用之FM調頻間隔可在100 kHz，預設間隔及50 kHz之間進行切換。

- 1 按**AUDIO**選擇**FM 100**。  
反覆按**AUDIO**直至**FM 100**在顯示幕中出現。
- 2 按**◀**或**▶**選擇FM調頻間隔。  
按**◀**或**▶**可在100 kHz及50 kHz之間切換FM調頻間隔。所選FM調頻間隔將在顯示幕中出現。



#### 注意

如果搜尋調頻以50 kHz為間隔進行，則會無法準確收聽電臺。請用手动調頻或再次使用搜尋調頻收聽電臺。□

### 設定AM調頻間隔

AM調頻間隔可在9 kHz，預設間隔及10 kHz之間進行切換。在北美，中美或南美使用調諧器時，請將調頻間隔從9 kHz（容許範圍531 – 1,602 kHz）重設至10 kHz（容許範圍530 – 1,640 kHz）。

- 1 按**AUDIO**選擇**AM 9**。  
反覆按**AUDIO**直至**AM 9**在顯示幕中出現。
- 2 按**◀**或**▶**選擇AM調頻間隔。  
按**◀**或**▶**可在9 kHz及10 kHz之間切換AM調頻間隔。所選AM調頻間隔將在顯示幕中出現。□

## 附加資訊

### 內置式光碟機錯誤訊息之含義

在CD播放期間出現故障時，顯示幕中會出現一條錯誤訊息。如果顯示幕中出現錯誤訊息，請參見下表查閱故障之所在及排除故障建議之方法。如果無法糾正錯誤，則請聯繫經銷商或就近之先鋒授權服務中心。

訊息	原因	措施
<b>ERROR-11, 12, 17, 30</b>	碟片變髒	清潔碟片。
<b>ERROR-11, 12, 17, 30</b>	碟片有刮痕	更換碟片。
<b>ERROR-10, 11, 12, 17, 30, A0</b>	電氣或機械故障	打開再關閉點火開關，或切換至其他播放源，然後再回到光碟機。
<b>ERROR-44</b>	所有曲目均為跳躍曲目	更換碟片。



### 光碟機及其養護

- 請僅使用帶如下所示CD數位音頻標記之CD。



- 請僅使用標準，圓形CD。如果插入非標準，非圓形之異形CD，則它們會卡在光碟機中或無法正常播放。

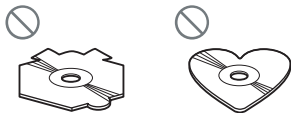

- 播放之前，請檢查所有CD是否有裂紋，刮痕或彎曲。有裂紋，刮痕或彎曲之CD可能無法正常播放。請勿使用此類碟片。
- 操作碟片時請避免觸摸其錄製（非印刷）面。
- 碟片不使用時請存放在其護套中。

- 請將碟片遠離直射陽光，而且請勿將碟片處於高溫之下。
- 請勿在碟片表面粘貼標籤，書寫或使用化學藥品。
- 清除CD塵垢時，請用軟布自碟片中心向外擦拭碟片。



- 如果在寒冷天氣中使用加熱器，光碟機內部組件上會形成濕氣。結露會導致光碟機無法正常運轉。如果發現結露引起故障，請關閉光碟機一小時左右讓光碟機風干，同時用軟布擦拭潮濕碟片以達到去濕目的。
- 道路顛簸會中斷CD之播放。 □

### CD-R/CD-RW碟片

- 使用CD-R/CD-RW碟片時，僅有已最終完成的碟片可進行播放。
- 由於碟片特性，碟片上之刮痕或塵垢，或本機鏡片上之塵垢或結露等，用音樂CD錄製機或個人電腦錄製的CD-R/CD-RW碟片可能無法正常播放。
- 根據應用軟體設定和環境，用個人電腦錄製的碟片可能無法播放。請使用正確的格式錄製。（有關詳情，請與應用軟體製造商聯繫。）
- 由於直射陽光，高溫，或車內的存放條件，CD-R/CD-RW碟片可能會無法播放。
- 本機適用CD-R/CD-RW碟片之曲目跳躍功能。含曲目跳躍資訊之曲目可自動跳過。
- 如果在本機中插入CD-RW碟片，則播放時間將比插入常規CD或CD-R碟片時長。
- 使用CD-R/CD-RW碟片之前，請閱讀注意事項。 □

## 附加資訊

### 規格

#### 一般

額定電源 .....	14.4 V DC (容許電壓範圍：12.0— 14.4 V DC)
接地系統 .....	負極型
最大電流消耗 .....	10.0 A
尺寸(寬×高×深)：	

#### DIN

機身 .....	178×50×157 毫米
前端部分 .....	188×58×19 毫米

#### D

機身 .....	178×50×162 毫米
前端部分 .....	170×48×14 毫米

重量 .....	1.3 公斤
----------	--------

#### 音頻

各聲道連續輸出功率為22 W，最小負荷4 歐姆，兩個聲道範圍50至15,000 Hz，僅5% THD。

最大輸出功率 .....	50 W × 4
負載阻抗 .....	4 Ω (容許範圍4—8 Ω)
前輸出最大輸出電平/輸出阻抗 .....	2.2 V/1 kΩ

等化器(3頻段參數等化器)：

#### 低頻

頻率 .....	40/80/100/160 Hz
Q因子 .....	0.35/0.59/0.95/1.15 (加強後+6 dB)
增益 .....	±12 dB

#### 中頻

頻率 .....	200/500/1k/2k Hz
Q因子 .....	0.35/0.59/0.95/1.15 (加強後+6 dB)
增益 .....	±12 dB

#### 高頻

頻率 .....	3.15k/8k/10k/12.5k Hz
Q因子 .....	0.35/0.59/0.95/1.15 (加強後+6 dB)
增益 .....	±12 dB

響度等高線

低頻 .....	+3.5 dB (100 Hz)，+3 dB (10 kHz)
中頻 .....	+10 dB (100 Hz)，+6.5 dB (10 kHz)
高頻 .....	+11 dB (100 Hz)，+11 dB (10 kHz) (音量：-30 dB)

#### 光碟機

系統 .....	CD音頻系統
----------	--------

可用CD .....	CD
信號格式：	
取樣頻率 .....	44.1 kHz
量化位元數 .....	16，線性
頻率特性 .....	5—20,000 Hz (±1 dB)
信噪比 .....	94 dB (1 kHz) (IEC-A網路)
動態範圍 .....	92 dB (1 kHz)
聲道數 .....	2 (立體聲)

#### FM調諧器

頻率範圍 .....	87.5—108.0 MHz
有效靈敏度 .....	8 dBf (0.7 μV/75 Ω，單聲道，S/N：30 dB)
50dB靜噪靈敏度 .....	10 dBf (0.9 μV/75 Ω，單聲道)
信噪比 .....	75 dB (IEC-A網路)
失真 .....	0.3% (65 dBf，1 kHz，立體聲時)
	0.1% (65 dBf，1 kHz，單聲道時)
頻率響應 .....	30—15,000 Hz (±3 dB)
立體聲分離度 .....	45 dB (65 dBf，1 kHz時)

#### AM調諧器

頻率範圍 .....	531—1,602 kHz (9 kHz)
	530—1,640 kHz (10 kHz)
有效靈敏度 .....	18 μV (S/N：20 dB)
信噪比 .....	65 dB (IEC-A網路)



#### 注意

因產品改進，規格及設計若有變更，恕不另行通知。 □

## **PIONEER CORPORATION**

4-1, MEGURO 1-CHOME, MEGURO-KU, TOKYO 153-8654, JAPAN

### **PIONEER ELECTRONICS (USA) INC.**

P.O. Box 1540, Long Beach, California 90801-1540, U.S.A.

TEL: (800) 421-1404

### **PIONEER EUROPE NV**

Haven 1087, Keetberglaan 1, B-9120 Melsele, Belgium

TEL: (0) 3/570.05.11

### **PIONEER ELECTRONICS ASIACENTRE PTE. LTD.**

253 Alexandra Road, #04-01, Singapore 159936

TEL: 65-6472-1111

### **PIONEER ELECTRONICS AUSTRALIA PTY. LTD.**

178-184 Boundary Road, Braeside, Victoria 3195, Australia

TEL: (03) 9586-6300

### **PIONEER ELECTRONICS OF CANADA, INC.**

300 Allstate Parkway, Markham, Ontario L3R OP2, Canada

TEL: (905) 479-4411

### **PIONEER ELECTRONICS DE MEXICO, S.A. de C.V.**

Bldv.Manuel Avila Camacho 138 10 piso

Col.Lomas de Chapultepec, Mexico, D.F. 11000

TEL: 55-9178-4270

### **先鋒股份有限公司**

總公司：台北市中山北路二段44號13樓

電話：(02) 2521-3588

### **先鋒電子（中國）有限公司**

香港辦事處：香港銅鑼灣告士打道280號世界貿易中心

17樓 1704-06室

電話：(0852) 2848-6488

Published by Pioneer Corporation.

Copyright © 2003 by Pioneer Corporation.

All rights reserved.

Printed in

<YRD5005-B/JS> ES, ID

<KMMZX> <03100000>



## Free Manuals Download Website

<http://myh66.com>

<http://usermanuals.us>

<http://www.somanuals.com>

<http://www.4manuals.cc>

<http://www.manual-lib.com>

<http://www.404manual.com>

<http://www.luxmanual.com>

<http://aubethermostatmanual.com>

Golf course search by state

<http://golfingnear.com>

Email search by domain

<http://emailbydomain.com>

Auto manuals search

<http://auto.somanuals.com>

TV manuals search

<http://tv.somanuals.com>