

Multi-CD control DSP High power  
CD/MD player with FM/AM tuner

ENGLISH

MDLP



**SUPER TUNER III**

## Owner's Manual

# FH-P8900MD

This product conforms to new cord colors.

**Pioneer**

## Key Finder ..... 3

## Before Using This Product ..... 4

About this manual .....	4
Precaution .....	4
Playback of MDs featuring long recordings .....	4
Resetting the microprocessor .....	5
About the demo mode .....	5
About basic displays .....	5
Remote controller and care .....	6
Using the remote controller .....	7

## Basic Operation ..... 8

Turning a source on or off .....	8
Setting the display angle .....	8
SOFT KEY operation .....	9
Key guidance indicator .....	11
PGM button functions .....	11

## Tuner ..... 12

Display and indicators .....	12
Basic operation .....	12
Storing and recalling broadcast stations .....	13
Tuner function menu .....	13
Storing the strongest broadcast stations .....	13
Selecting stations from the preset channel list .....	14
Tuning in strong signals .....	14

## Built-in CD Player ..... 15

Display and indicators .....	15
Basic operation .....	15
Switching and scrolling the title .....	16
Built-in CD player function menu .....	16
Repeating play .....	16
Playing tracks in random order .....	17
Scanning tracks of a CD .....	17
Selecting tracks from the track title list .....	17
Pausing CD playback .....	18
Entering disc titles .....	18

## Built-in MD Player ..... 19

Display and indicators .....	19
Basic operation .....	19
Switching and scrolling the title .....	20
Built-in MD player function menu .....	20
Repeating play .....	20
Playing tracks in random order .....	21
Scanning tracks of an MD .....	21
Selecting tracks from the track title list .....	21
Pausing MD playback .....	22

## Multi-CD Player ..... 23

Display and indicators .....	23
50-disc multi-CD player .....	23
Basic operation .....	23
Selecting a disc directly .....	23
Switching and scrolling the title .....	24
Multi-CD player function menu .....	24
Repeating play .....	24
Playing tracks in random order .....	25
Scanning CDs and tracks .....	25
Selecting tracks from the track title list .....	25
Selecting discs from the disc title list .....	26
Pausing CD playback .....	26
Entering disc titles .....	26
Using compression and dynamic bass emphasis .....	27
Using ITS memory .....	27

<b>TV Tuner .....</b>	<b>29</b>	<b>Initial Settings .....</b>	<b>40</b>
Display and indicators .....	29	Initial settings menu .....	40
Basic operation .....	29	Using reverse mode .....	40
Storing and recalling broadcast stations .....	29	Using the feature demo .....	40
Changing a band .....	30	Switching the auxiliary setting .....	40
TV tuner function menu .....	30	Switching the telephone muting/attenuation setting .....	41
Selecting channels from the preset channel list .....	30	Setting preout output .....	41
<b>Audio Adjustments .....</b>	<b>31</b>	Setting the FM tuning step .....	41
Adjusting the audio easily .....	31	Setting the AM tuning step .....	41
Adjusting the audio finely .....	31	<b>Other Functions .....</b>	<b>42</b>
Extra functions .....	31	Attenuating volume .....	42
Recalling equalizer curves .....	31	Displaying and setting the clock .....	42
Audio menu .....	32	Changing the display form .....	43
Using balance adjustment .....	32	Adjusting the brightness .....	43
Using loudness .....	32	Switching the dimmer setting .....	43
Using sound field control, octaver and BBE sound .....	32	Selecting the wall paper pattern .....	43
Adjusting equalizer curves .....	33	Setting the entertainment display .....	43
Adjusting 13-band graphic equalizer .....	33	Using the AUX source .....	44
Using position selector .....	34	<b>Additional Information .....</b>	<b>45</b>
Using time alignment .....	35	CD player and care .....	45
Using subwoofer output .....	35	MD player and care .....	46
Using the high pass filter .....	36	Understanding built-in CD player error messages .....	47
Adjusting source levels .....	37	Understanding built-in MD player error messages .....	47
Using the auto-equalizer .....	37	Understanding auto-equalizing error messages .....	48
Switching the digital attenuator .....	37	Connecting the units .....	49
Creating the auto-equalizer curve .....	37	Installation .....	53
		Specifications .....	55

## Head unit

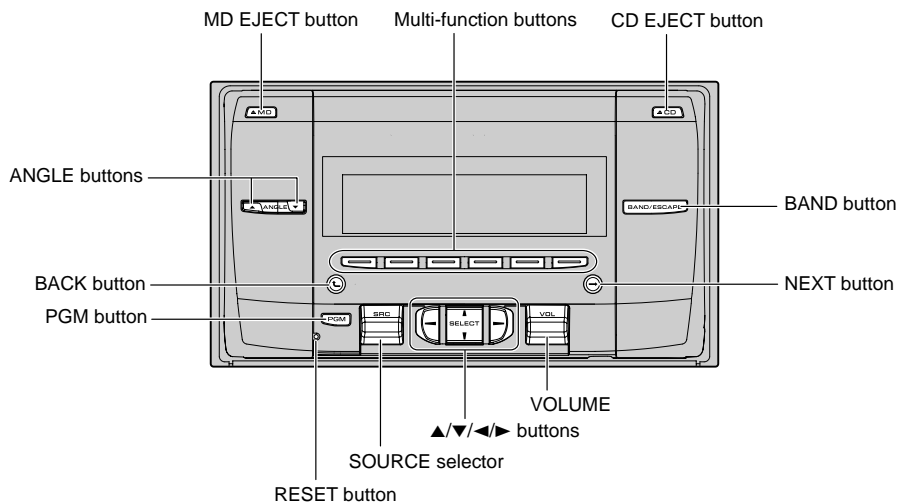

## Remote Controller

A remote controller that enables remote operation of the head unit is supplied. Operation is the same as when using buttons on the head unit.

### ATT button

This lets you quickly lower volume level (by about 90%). Press once more to return to the original volume level.

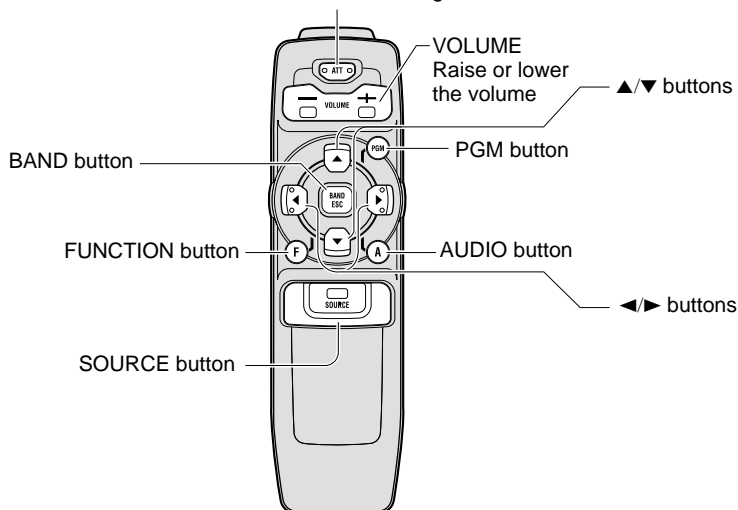

## About this manual

This product features a number of sophisticated functions ensuring superior reception and operation. All are designed for the easiest possible use, but many are not self-explanatory. This operation manual is intended to help you benefit fully from their potential and to maximize your listening enjoyment.

We recommend that you familiarize yourself with the functions and their operation by reading through the manual before you use this product. It is especially important that you read and observe the "Precaution" on this page and in other sections.

This manual explains head unit operation. You can perform the same operations with the remote controller.

## Precaution

- |          |   |
|----------|---|
| CAUTION: | USE OF CONTROL OR ADJUSTMENT OR PERFORMANCE OF PROCEDURES OTHER THAN THOSE SPECIFIED HEREIN MAY RESULT IN HAZARDOUS RADIATION EXPOSURE. |
| CAUTION: | THE USE OF OPTICAL INSTRUMENTS WITH THIS PRODUCT WILL INCREASE EYE HAZARD.  |

- Keep this manual handy as a reference for operating procedures and precautions.
- Always keep the volume low enough for outside sounds to be audible.
- Protect the product from moisture.
- If the battery is disconnected, the preset memory will be erased and must be reprogrammed.
- Should this product fail to operate properly, contact your dealer or nearest authorized Pioneer Service Station.

## Playback of MDs featuring long recordings

This product is MDLP\* compatible, so you can playback MDs featuring long recordings.

\* MDLP is a data compression system that lets you record on regular MDs for 2 or 4 times the length of time previously possible.

## Resetting the microprocessor

The microprocessor must be reset under the following conditions:

When using this product for the first time after installation.

When the machine fails to operate properly.

When strange (incorrect) messages appear on the display.

- To reset the microprocessor, press **RESET** on the head unit with a pen tip or other pointed instrument.

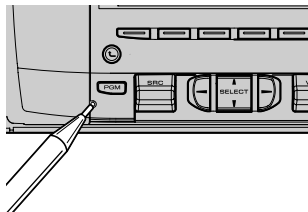

## About the demo mode

This product features two demonstration modes. One is the reverse mode and the other is the feature demo mode.

### Reverse mode

If you do not carry out an operation within about 30 seconds, screen indications will start to reverse, and then continue reversing every 10 seconds. Pressing the button 5 when power to this product is switched off while the ignition switch is set to ACC or ON cancels the reverse mode. Press the button 5 again to start the reverse mode.

### Feature demo

The feature demo automatically starts when power to this product is switched off while the ignition switch is set to ACC or ON. Pressing the button 6 during feature demo operation cancels the feature demo mode. Press the button 6 again to start the feature demo mode.

Remember that if the feature demo continues operating when the car engine is switched OFF, it may drain battery power.

### Note:

- The red lead (ACC) of this product should be connected to a terminal coupled with ignition switch ON or OFF operations. If this is not done, the vehicle battery may be drained.
- When the source is off, you can check the location of “5” and “6” by turning on the feature demo.



## About basic displays

This product is equipped with two forms of basic display. You can select the desired display.

### FORM 1



### FORM 2



### Note:

- For details, refer to “Changing the display form” on page 43.

# Remote controller and care

## Batteries

- Remove the cover on the back of the remote controller and insert the batteries with the (+) and (-) poles pointing in the proper direction.

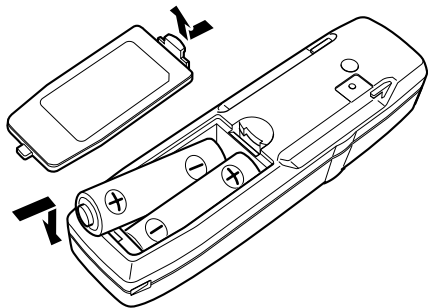

### Precaution:

- Use only AAA or IEC R03 1.5 V batteries.
- Remove the batteries if the remote controller is not used for a month or longer.
- Do not attempt to recharge the supplied batteries.
- Do not mix new and used batteries.
- If the event of battery leakage, wipe the remote controller completely clean and install new batteries.
- When disposing of used batteries, please comply with governmental regulations or environmental public institution's rules that apply in your country/area.

## Using the remote controller

This product is equipped with a remote controller for convenient operation.

- Point the remote controller in the direction of the front panel to operate.

### Precaution:

- Do not store the remote controller in high temperatures or direct sunlight.
- The remote controller may not function properly in direct sunlight.
- Do not let the remote controller fall onto the floor, where it may become jammed under the brake or accelerator pedal.
- If you press the FUNCTION button on the remote controller while pressing the BAND button on it, the remote controller will not function properly. To cancel this setting, press the AUDIO button on the remote controller while pressing the BAND button on it to return to the previous setting.

## FUNCTION button and AUDIO button

Operation of the FUNCTION button and the AUDIO button on the remote controller differs from the operation of the FUNC button and the AUDIO button on the head unit. When operating the head unit, use the FUNC button and the AUDIO button to select the appropriate menu, then use the multi-function buttons to select the mode. When operating the remote controller, however, switch through the modes as described below to select the mode.

## FUNCTION button operation

- Press **FUNCTION** to select the desired mode (e.g., built-in CD player).

Press FUNCTION repeatedly to switch between the following modes:

RPT → RDM → SCAN → T.LIST → PAUSE  
→ TTLin

### Note:

- Refer to “Built-in CD player function menu” on page 16.

## AUDIO button operation

- Press **AUDIO** to select the desired mode.

Press AUDIO repeatedly to switch between the following modes:

F/B → LOUD → SFC → EQ1 → EQ2  
→ POS1 → T.AL1 → T.AL2 → SW1  
→ SW2 → HPF F → HPF R → SLA  
→ A.EQ → D.ATT

### Note:

- Refer to “Audio menu” on page 32.



## Turning a source on or off

You can select the source you want to listen to. To switch to built-in CD/MD player, load a CD/MD in this product. (Refer to "Basic operation" on page 15 and 19.)

### 1. Press (up or down) SOURCE to select the desired source (e.g., tuner).

Press (up or down) SOURCE repeatedly to switch between the following sources:

- Built-in CD player ↔ TV tuner ↔ Tuner
- ↔ Built-in MD player ↔ Multi-CD player
- ↔ External unit 1 ↔ External unit 2
- ↔ AUX ↔ SOURCE OFF



### 2. Press (up or down) VOLUME to adjust the volume.



### 3. Press (up or down) SOURCE to select the source off.

You can also turn the source off by pressing and holding SOURCE button on the remote controller.

#### Note:

- External unit refers to a Pioneer product (such as one available in the future) that, although incompatible as a source, enables control of basic functions by this product. Two external units can be controlled by this product, although "External" is displayed whether you select external unit 1 or external unit 2. When two external units are connected, the allocation of them to external unit 1 or external unit 2 is automatically set by this product.
- In the following cases, the sound source will not change:
  - \* When no product corresponding to the source is connected to this product.
  - \* No disc is set in this product.
  - \* No magazine is set in the multi-CD player.
  - \* AUX (auxiliary setting) is set to off. (Refer to page 40.)

- When this product's blue lead is connected to the car's Auto-antenna relay control terminal, the car's Auto-antenna extends when this product's source is selected the tuner. To retract the antenna, switch the sources other than tuner.

## Setting the display angle

You can adjust front panel angle for easier operation.

- Select the desired angle.

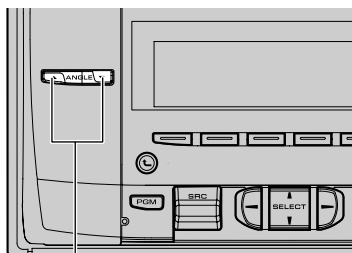

Each press changes the angle.

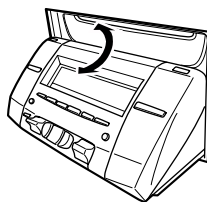

#### Note:

- Pressing and holding ANGLE (▼) fully opens the front panel. Pressing and holding ANGLE (▲) completely closes the front panel.



#### WARNING:

- Do not use with the front panel left fully open. If you do leave it open, it may result in injury in the event of an accident.
- Be careful not to catch your finger in the front panel when it is opening or closing.

## SOFT KEY operation

SOFT KEY operation means that the function of a button changes as indicated on the display. The multi-function buttons provide SOFT KEY operation; the functions performed by the buttons change according to the function or setting that has been selected.

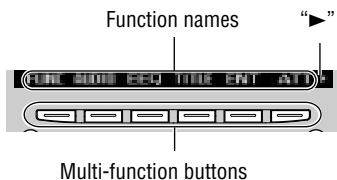

The explanations given in this manual are based on FORM 1 display. If you have selected FORM 2, the functions of some of the multi-function buttons may be different from those indicated in the manual.

### Important

In this manual, for operations using the multi-function buttons the function displayed is used as the name of the function button.

## Switching the function of the multi-function buttons

The "▶" indicator shows that the multi-function buttons have functions other than those currently displayed. When this indicator is visible, press NEXT to switch through the functions of the multi-function buttons.

- Press NEXT to display the desired functions (e.g., built-in CD player).

Press NEXT repeatedly to switch between the following functions:



### Note:

- The number of functions or displays switched through will differ according to the source or menu selected.
- When no function is indicated for a button, that button is not currently active.

## Example of multi-function button operation

Here the “random play” function of the built-in CD player is used as an example to illustrate operation of the multi-function buttons.

### 1. Press NEXT to display “FUNC”.

Press NEXT repeatedly until “FUNC” appears.

FUNC MIDD EEQ TITLE ENT ATT

### 2. Press FUNC to enter the function menu.

With the switch to the function menu, the functions of the multi-function buttons also change simultaneously.

RPT RDM SCAN T.LIST PAUSE

### 3. Press RDM to select the random mode.



### 4. Press RDM to turn random play on.



The light illuminates.

- Press RDM again to turn random play off. The light goes off.

## Display example (e.g., built-in CD player)

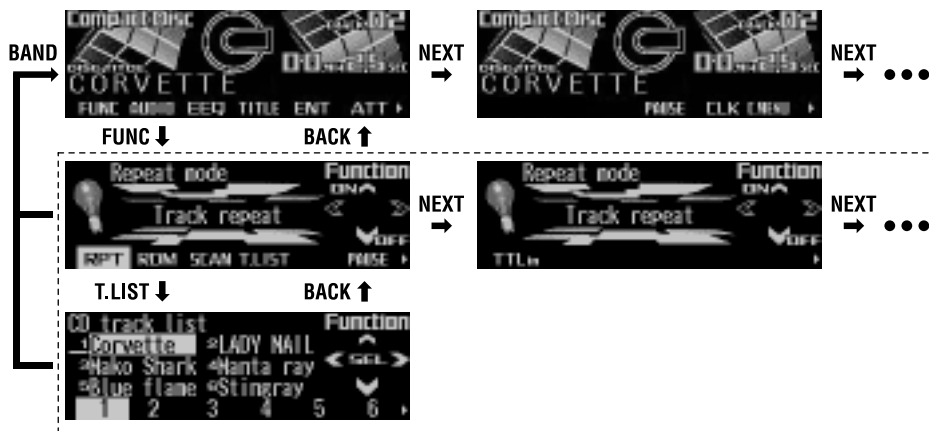

## Key guidance indicator

This product's display features key guidance indicators. These light to indicate which of the ▲/▼/◀/▶ buttons you can use. When you are in the function menu, audio menu or the other menus, they also make it easy to see which ▲/▼/◀/▶ buttons you can use to switch functions on/off, switch repeat selections and perform other operations.



Key guidance indicators

### Note:

- In this manual, operation for each mode is given mainly in terms of the multi-function buttons. However, in each mode, when the key guidance indicators are lit it is also possible to use ▲/▼/◀/▶ to operate the mode.

## PGM button functions

The following chart shows functions for each source by pressing PGM.

For more details, or when you want to know about an operation, refer to the page number indicated in the chart.

Source	Function name	Page
Tuner	Best Stations Memory (OFF)	13
	Best Stations Memory (ON)	
	(Hold for 2 seconds)	13
Built-in MD player	Pause	22
Built-in CD player	Pause	18
Multi-CD player	Pause	26
TV	Best Station Sequential Memory (OFF)	30
	Best Station Sequential Memory (ON)	
	(Hold for 2 seconds)	30

## Display and indicators

### FORM 1



### FORM 2

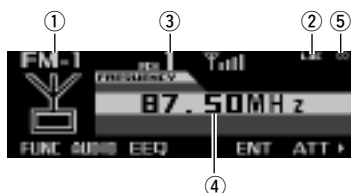

- ① Band
- ② LOC indicator
- ③ Preset number
- ④ Frequency
- ⑤ Stereo indicator

## Basic operation

Reset the AM tuning step from 9 kHz (the factory preset step) to 10 kHz when using the tuner in North, Central or South America. (Refer to page 41.)

1. Press (up or down) **SOURCE** to select the tuner.

Press (up or down) SOURCE until "Tuner" appears.

2. Press (up or down) **VOLUME** to adjust the volume.

3. Press **BAND** to select the desired band.

Press BAND repeatedly to switch between the following bands:  
FM-1 → FM-2 → FM-3 → AM

4. Press ◀ or ▶ to tune in to a station.

The frequencies move up or down step by step.

- If you press and hold ◀ or ▶ for about one second and release, you can perform seek tuning. Seek tuning lets you skip broadcasting stations until a broadcast strong enough for good reception is found.
- If you press and hold ◀ or ▶, you can skip broadcasting stations. Seek tuning starts as soon as you release the button.

### Note:

- The stereo indicator "◐" lights when a stereo station is selected.

## Storing and recalling broadcast stations

If you press any of the buttons 1 – 6, you can easily store up to six broadcast stations for later recall.

### Storing broadcast stations

1. **Press NEXT to display “1” – “6”.**

Press NEXT until “1” – “6” appears.

2. **When you find a station that you want to store in memory, press and hold any of the buttons 1 – 6 until the preset number stops flashing.**

The station is stored in memory under the selected button.

#### Note:

- Up to 18 FM stations, six for each of the three FM bands, and six AM stations can be stored in memory.

### Recalling broadcast stations

1. **Press NEXT to display “1” – “6”.**

Press NEXT until “1” – “6” appears.

2. **Press any of the buttons 1 – 6 to recall a station preset under that button.**

#### Note:

- You can also use ▲ or ▼ to recall broadcast stations memorized in the buttons 1 – 6.

## Tuner function menu

The tuner function menu has the following functions:

### FM/AM

BSM  JUST LOC

#### Note:

- If you do not operate the function within about 30 seconds, the display is automatically returned.

## Storing the strongest broadcast stations

BSM (best stations memory) lets you automatically store the six strongest broadcast stations under the buttons 1 – 6.

1. **Press FUNC to select the BSM mode.**

2. **Press BSM to turn the BSM on.**

“Searching” appears. The six strongest broadcast stations will be stored under the buttons 1 – 6 and in order of their signal strength.

When finished, “Searching” disappears and the display switches to the preset channel list mode.

- To cancel the storage process before it is completed, press BSM again while “Searching” appears.

#### Note:

- You can also turn BSM off by pressing PGM.

## Selecting stations from the pre-set channel list

The preset channel list lets you see the list of preset stations and select one of them to receive.

1. Press **FUNC** and then press **chLIST** to select the preset channel list mode.
2. Press any of the buttons **1 – 6** to recall the desired station.

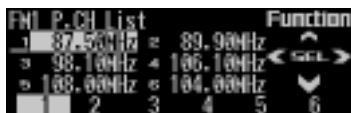

### Note:

- You can also use **◀**, **▶** and **▲** to select and recall the desired station.

## Tuning in strong signals

Local seek tuning lets you tune in only those broadcast stations with sufficiently strong signals for good reception.

1. Press **FUNC** and then press **LOC** to select the local mode.
2. Press **LOC** to set the local seek sensitivity.

Press **LOC** repeatedly to switch between the following settings:

FM: Local OFF → Level 1 → Level 2  
→ Level 3 → Level 4

AM: Local OFF → Level 1 → Level 2

- When the local mode is exited except for “Local OFF” is selected, “LOC” appears on the basic display.

### Note:

- The “Level 4” setting allows reception of only the strongest stations, while lower settings let you receive progressively weaker stations.

## Display and indicators

### FORM 1

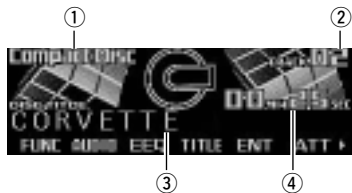

### FORM 2

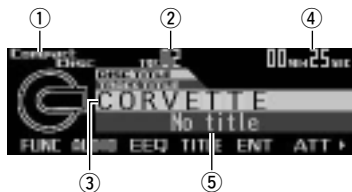

- ① Source name
- ② Track number
- ③ Disc title
- ④ Play time
- ⑤ Track title

## Basic operation

The built-in CD player plays one standard 12 cm or 8 cm (single) CD at a time. Do not use an adapter when playing an 8 cm CD.

1. Press **CD EJECT** to open the front panel.
2. Insert a CD into the CD loading slot.

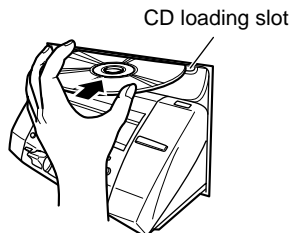

When a CD is inserted, the front panel closes automatically.

3. Press (up or down) **VOLUME** to adjust the volume.

4. Press **◀** or **▶** to select a track.

Pressing **▶** skips to the start of the next track.

Pressing **◀** once skips to the start of the current track. Pressing again will skip to the previous track.

- If you press and hold **◀** or **▶**, you can perform fast forward or reverse.

5. Press **CD EJECT** to eject the CD.

The front panel opens and the CD is ejected.

- Be sure to close the front panel by pressing **CD EJECT** after removing the CD.

### Note:

- You can select CD as the source by pressing (up or down) **SOURCE** when a disc is loaded in this product.
- Do not insert anything other than a CD into the CD loading slot.
- A CD left partially inserted after ejection may incur damage or fall out.
- If a CD cannot be inserted fully or playback fails, make sure the recorded side is down. Press the **CD EJECT** and check the disc for damage before reinserting it.
- If the built-in CD player cannot operate properly, an error message (such as "ERROR-14") appears on the display. Refer to "Understanding built-in CD player error messages" on page 47.
- You can eject the CD by pressing and holding **CD EJECT** with opening the front panel when the CD loading or ejecting cannot operate properly.
- When you load a CD TEXT disc or switch from another source to the built-in CD player when a CD TEXT disc is loaded, disc and track titles are automatically scrolled once in the display. When you select a track, the track title is also automatically scrolled once in the display. (The title of the track you are currently listening to is not scrolled if you return to the start of that track.)



## Switching and scrolling the title

When playing a CD TEXT disc, you can switch text display such as artist name and track title. With text longer than 32 letters, you can scroll to see the rest of the text.

1. Press **TITLE** to switch the title mode.
2. Press the corresponding button to display the desired title.

### FORM 1

Button	Operation
D.TTL	Displays disc title.
D.ART	Displays disc artist name.
T.TTL	Displays track title.
T.ART	Displays track artist name.
THNDR	Displays thunderbolt animation.
SCROLL	Scrolls the displayed title.

### FORM 2

Button	Operation
TTL1	Displays disc title and track title.
TTL2	Displays disc title and disc artist name.
TTL3	Displays track title and track artist name.
SCROLL	Scrolls the displayed title.

#### Note:

- If you do not operate the function within about eight seconds, the display is automatically returned.
- You cannot use ◀ or ▶ to select a track in title mode.
- When you select the display form 2, the titles are displayed up to 24 letters long.
- A CD TEXT disc is a CD featuring recorded text information such as disc title, artist name and track title.
- If certain text information is not recorded on a CD TEXT disc, "No ~" (e.g., "No title") is displayed.
- If you have not input disc titles, "No title" is displayed.

## Built-in CD player function menu

The built-in CD player function menu has the following functions:

RPT SPM SCAN TLIST PAUSE

TTLin

#### Note:

- If you do not operate the function within about 30 seconds, the display is automatically returned. (When you select the disc title input mode (TTLin), the display is not returned automatically.)
- "T.LIST" is displayed only when playing a CD TEXT disc.

## Repeating play

Repeat play lets you hear the same track over again.

1. Press **FUNC** to select the repeat mode.
2. Press **RPT** to turn the repeat play on.

The light illuminates. The track currently playing will play and then repeat.

- Press RPT again to turn repeat play off.
- When the repeat mode is exited while repeat play is on, "T.RPT" appears on the basic display.

#### Note:

- If you perform track search or fast forward/reverse, repeat play is automatically canceled.

## Playing tracks in random order

Random play lets you play back tracks on the CD in random order.

1. Press **FUNC** and then press **RDM** to select the random mode.

2. Press **RDM** to turn random play on.

The light illuminates. Tracks will play in random order.

- Press **RDM** again to turn random play off.
- When the random mode is exited while random play is on, "RDM" appears on the basic display.

## Scanning tracks of a CD

Scan play lets you hear the first 10 seconds of each track on the CD.

1. Press **FUNC** and then press **SCAN** to select the scan mode.

2. Press **SCAN** to turn scan play on.

The light illuminates. The first 10 seconds of each track are played.

- When the scan mode is exited while scan play is on, "SCAN" appears on the basic display.

3. When you find the desired track, press **SCAN** to turn scan play off.

The light goes off. The track will continue to play.

- If the scan mode is automatically canceled, select the scan mode again.

### Note:

- After scanning of a CD is finished, normal playback of the tracks will begin again.

## Selecting tracks from the track title list

The track title list lets you see the list of track titles on a CD TEXT disc and select one of them for playback.

1. Press **FUNC** and then press **T.LIST** to select the track title list mode.

2. Press **NEXT** to display the desired track title.

Press **NEXT** until the desired track title appears.



3. Press the corresponding number button to select the desired track title.

That selection will begin to play.

### Note:

- You can also use ◀, ▶ and ▲ to select and play the desired track title.
- Only when playing a CD TEXT disc, you can switch to this mode.

## Pausing CD playback

Pause lets you temporarily stop playback of the CD.

1. Press **FUNC** and then press **PAUSE** to select the pause mode.
2. Press **PAUSE** to turn the pause on.

The light illuminates. Play of the current track pauses.

- Press **PAUSE** again to turn the pause off.
- When the pause mode is exited while pause is on, "PAUSE" is displayed in the basic display.

### Note:

- You can also turn pause on or off by pressing **PAUSE** in the following display.



- You can also turn pause on or off by pressing **PGM**.

## Entering disc titles

Disc title input lets you input up to 48 CD titles up to 10 letters long into the built-in CD player. If you input a CD title, the entered title is displayed.

For details of operation, refer to "Entering disc titles" on page 26 under "Multi-CD Player".

### Note:

- When playing a CD **TEXT** disc, if you switch to this mode, "No title input" is displayed and you cannot input the title.
- After the titles for 48 discs have been entered, the data for a new disc will overwrite the oldest one.
- If you connect a multi-CD player, you can input disc titles for up to 100 discs.

## Display and indicators

### FORM 1



### FORM 2

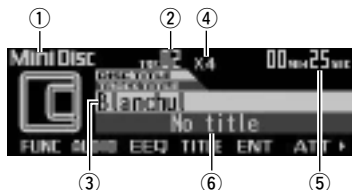

- ① Source name
- ② Track number
- ③ Disc title
- ④ MDLP indicator (X2 or X4)
- ⑤ Play time
- ⑥ Track title

## Basic operation

You can only load one MD at a time in the Built-in MD player. Load the MD in the direction of the arrow, with the label side facing up.

1. Press **MD EJECT** to open the front panel.
2. Insert an MD into the MD loading slot.

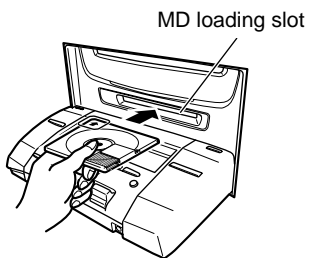

When an MD is inserted, the front panel closes automatically.

3. Press (up or down) **VOLUME** to adjust the volume.

4. Press **◀** or **▶** to select a track.

Pressing **▶** skips to the start of the next track.

Pressing **◀** once skips to the start of the current track. Pressing again will skip to the previous track.

- If you press and hold **◀** or **▶**, you can perform fast forward or reverse.

5. Press **MD EJECT** to eject the MD.

The front panel opens and the MD is ejected.

- Be sure to close the front panel by pressing **MD EJECT** after removing the MD.

### ! WARNING:

- Do not use with the front panel left fully open. If the front panel is left open, it may result in injury in the event of an accident.

### Note:

- You can select MD as the source by pressing (up or down) **SOURCE** when a disc is loaded in this product.
- Do not insert anything other than an MD into the MD loading slot.
- An MD left partially inserted after ejection may incur damage or fall out.
- Load an MD after confirming the MD shutter (refer to page 46) is closed.
- When you load a disc, this product reads information recorded on the disc such as the number of tracks. While the disc is being read, "TOC read" is indicated in the display.
- If the Built-in MD player cannot operate properly, an error message (such as "ERROR-11") appears on the display. Refer to "Understanding built-in MD player error messages" on page 47.
- When you play MDs featuring long recordings, the MDLP indicator is displayed. (Refer to "Display and indicators" on this page.)
- When you load an MD or switch from another source to the built-in MD player when an MD is loaded, disc and track titles are automatically scrolled once in the display. When you select a track, the track title is also automatically scrolled once in the display. (The title of the track you are currently listening to is not scrolled if you return to the start of that track.)

## Switching and scrolling the title

When playing an MD, you can switch text display such as disc title and track title. With text longer than 32 letters, you can scroll to see the rest of the text.

1. Press **TITLE** to switch the title mode.
2. Press the corresponding button to display the desired title.

### FORM 1

Button	Operation
D.TTL	Displays disc title.
T.TTL	Displays track title.
THNDR	Displays thunderbolt animation.
SCROLL	Scrolls the displayed title.

### FORM 2

Button	Operation
SCROLL	Scrolls the displayed title.

#### Note:

- If you do not operate the function within about eight seconds, the display is automatically returned.
- You cannot use ◀ or ▶ to select a track in title mode.
- When you select the display form 2, the titles are displayed up to 24 letters long.
- If you have not input disc titles, "No title" is displayed.
- With this product, "LP:" is not displayed before track titles regardless of the MD recording method. (On some MDs featuring long recordings, "LP:" is previously input before track titles.)
- This product is not compatible with the MD Group function. When you play MDs with groups registered, disc title indications include group names.

## Built-in MD player function menu

The built-in MD player function menu has the following functions:

RPT RDM SCAN TLIST PAUSE

#### Note:

- If you do not operate the function within about 30 seconds, the display is automatically returned.

## Repeating play

Repeat play lets you hear the same track over again.

1. Press **FUNC** to select the repeat mode.
2. Press **RPT** to turn the repeat play on.

The light illuminates. The track currently playing will play and then repeat.

- Press RPT again to turn repeat play off.
- When the repeat mode is exited while repeat play is on, "T.RPT" appears on the basic display.

#### Note:

- If you perform track search or fast forward/reverse, repeat play is automatically canceled.

## Playing tracks in random order

Random play lets you play back tracks on the MD in random order.

1. Press **FUNC** and then press **RDM** to select the random mode.
2. Press **RDM** to turn random play on.  
The light illuminates. Tracks will play in random order.
  - Press **RDM** again to turn random play off.
  - When the random mode is exited while random play is on, "RDM" appears on the basic display.

## Scanning tracks of an MD

Scan play lets you hear the first 10 seconds of each track on the MD.

1. Press **FUNC** and then press **SCAN** to select the scan mode.
2. Press **SCAN** to turn scan play on.  
The light illuminates. The first 10 seconds of each track are played.
  - When the scan mode is exited while scan play is on, "SCAN" appears on the basic display.
3. When you find the desired track, press **SCAN** to turn scan play off.  
The light goes off. The track will continue to play.
  - If the scan mode is automatically canceled, select the scan mode again.

### Note:

- After scanning of an MD is finished, normal playback of the tracks will begin again.

## Selecting tracks from the track title list

The track title list lets you see the list of track titles on the MD and select one of them for playback.

1. Press **FUNC** and then press **T.LIST** to select the track title list mode.
2. Press **NEXT** to display the desired track title.

Press **NEXT** until the desired track title appears.



3. Press the corresponding number button to select the desired track title.

That selection will begin to play.

### Note:

- You can also use **◀**, **▶** and **▲** to select and play the desired track title.

## Pausing MD playback

Pause lets you temporarily stop playback of the MD.

1. Press **FUNC** and then press **PAUSE** to select the pause mode.
2. Press **PAUSE** to turn the pause on.

The light illuminates. Play of the current track pauses.

- Press **PAUSE** again to turn the pause off.
- When the pause mode is exited while pause is on, "PAUSE" is displayed in the basic display.

### Note:

- You can also turn pause on or off by pressing **PAUSE** in the following display.



PAUSE CLK MEM

- You can also turn pause on or off by pressing **PGM**.

## Display and indicators

### FORM 1



### FORM 2

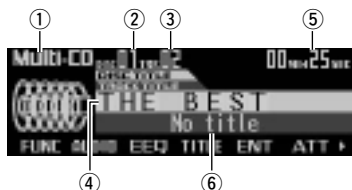

- ① Source name
- ② Disc number
- ③ Track number
- ④ Disc title
- ⑤ Play time
- ⑥ Track title

## 50-disc multi-CD player

Only those functions described in this manual are supported for 50-disc multi-CD players.

## Basic operation

This product can control a multi-CD player, which is sold separately.

### 1. Press (up or down) SOURCE to select the multi-CD player.

Press (up or down) SOURCE until “Multi-CD” appears.

### 2. Press (up or down) VOLUME to adjust the volume.

### 3. Press ▲ or ▼ to select a disc.

A disc number for which there is no disc will be skipped.

- You can use the buttons 1 – 6 (or 7 – 12) to select a disc directly.

### 4. Press ◀ or ▶ to select a track.

Pressing ▶ skips to the start of the next track.

Pressing ◀ once skips to the start of the current track. Pressing again will skip to the previous track.

- If you press and hold ◀ or ▶, you can perform fast forward or reverse.

### Note:

- When the multi-CD player is performing the preparatory operations, “Ready” is displayed.
- If the multi-CD player cannot operate properly, an error message such as “ERROR-14” is displayed. Refer to the multi-CD player owner’s manual.
- If there are no discs in the multi-CD player magazine, “No disc” is displayed.
- When you load a CD TEXT disc or switch from another source to the built-in CD player when a CD TEXT disc is loaded, disc and track titles are automatically scrolled once in the display. When you select a track, the track title is also automatically scrolled once in the display. (The title of the track you are currently listening to is not scrolled if you return to the start of that track.)

## Selecting a disc directly

You can use the buttons 1 – 6 (or 7 – 12) to select a disc directly.

### 1. Press NEXT to display “1” – “6” (or “7” – “12”).

Press NEXT until “1” – “6” (or “7” – “12”) appears.



### 2. Press any of the buttons 1 – 6 (or 7 – 12) to select a disc located at 1 to 6 (or 7 to 12).

### Note:

- You cannot display “7” – “12” when a 6-disc multi-CD player is connected.



## Switching and scrolling the title

When playing a CD TEXT disc on a CD TEXT compatible multi-CD player, you can switch text display such as artist name and track title.

With text longer than 32 letters, you can scroll to see the rest of the text.

1. Press **TITLE** to switch the title mode.
2. Press the corresponding button to display the desired title.

### FORM 1

Button	Operation
D.TTL	Displays disc title.
D.ART	Displays disc artist name.
T.TTL	Displays track title.
T.ART	Displays track artist name.
THNDR	Displays thunderbolt animation.
SCROLL	Scrolls the displayed title.

### FORM 2

Button	Operation
TTL1	Displays disc title and track title.
TTL2	Displays disc title and disc artist name.
TTL3	Displays track title and track artist name.
SCROLL	Scrolls the displayed title.

#### Note:

- If you do not operate the function within about eight seconds, the display is automatically returned.
- You cannot use ▲/▼/◀/▶ to select a disc or track in title mode.
- When you select the display form 2, the titles are displayed up to 24 letters long.
- A CD TEXT disc is a CD featuring recorded text information such as disc title, artist name and track title.
- If certain text information is not recorded on a CD TEXT disc, "No ~" (e.g., "No title") is displayed.
- If you have not input disc titles, "No title" is displayed.

## Multi-CD player function menu

The multi-CD player function menu has the following functions:

RPT SOM SCAN TLIST OLIST PAUSE ■

TTL COMP ITS.M ITS.W ■

#### Note:

- If you do not operate the function within about 30 seconds, the display is automatically returned. (When you select the disc title input mode (TTLin) or ITS memory mode (ITS.M), the display is not returned automatically.)
- "T.LIST" is displayed only when playing a CD TEXT disc on a CD TEXT compatible multi-CD player.

## Repeating play

There are three repeat play ranges for the multi-CD player: one-track repeat, disc repeat and multi-CD player repeat.

1. Press **FUNC** to select the repeat mode.
2. Press **RPT** to select the repeat range.

Press RPT repeatedly to switch between the following repeat ranges:

Magazine repeat (multi-CD player repeat)

→ Track repeat (one-track repeat)

→ Disc repeat (disc repeat)

- When the repeat mode is exited, either "T.RPT" or "D.RPT" may appear on the basic display.
  - "T.RPT" appears while the one-track repeat is selected.
  - "D.RPT" appears while the disc repeat is selected.

#### Note:

- If you select other discs during repeat play, the repeat range changes to multi-CD player repeat.
- If you perform track search or fast forward/reverse during one-track repeat, the repeat range changes to disc repeat.

## Playing tracks in random order

Random play lets you play back tracks in random order within the repeat range: multi-CD player repeat and disc repeat.

### 1. Select the repeat range.

Refer to "Repeating play" on page 24.

### 2. Press **FUNC** and then press **RDM** to select the random mode.

### 3. Press **RDM** to turn random play on.

The light illuminates. Tracks will play in random order within the selected repeat range.

- Press **RDM** again to turn random play off.
- When the random mode is exited while random play is on, "RDM" appears on the basic display.

#### Note:

- If you turn random play on during one-track repeat, the repeat range changes to disc repeat.

## Scanning CDs and tracks

When you select disc repeat, scan play lets you hear the first 10 seconds of each track on the selected CD. When you select multi-CD player repeat, scan play lets you hear the first 10 seconds of the first track on each CD.

### 1. Select the repeat range.

Refer to "Repeating play" on page 24.

### 2. Press **FUNC** and then press **SCAN** to select the scan mode.

### 3. Press **SCAN** to turn scan play on.

The light illuminates. The first 10 seconds of each track of the current disc (or the first track of each disc) are played.

- When the scan mode is exited while scan play is on, "SCAN" appears on the basic display.

### 4. When you find the desired track (or disc), press **SCAN** to turn scan play off.

The light goes off. The track (or disc) will continue to play.

- If the scan mode is automatically canceled, select the scan mode again.

#### Note:

- After track or disc scanning is finished, normal playback of the tracks will begin again.
- If you turn scan play on during one-track repeat, the repeat range changes to disc repeat.

## Selecting tracks from the track title list

The track title list lets you see the list of track titles on a CD TEXT disc and select one of them for playback.

### 1. Press **FUNC** and then press **T.LIST** to select the track title list mode.

### 2. Press **NEXT** to display the desired track title.

Press **NEXT** until the desired track title appears.



### 3. Press the corresponding number button to select the desired track title.

That selection will begin to play.

#### Note:

- You can also use ◀, ▶ and ▲ to select and play the desired track title.
- Only when playing a CD TEXT disc on a CD TEXT compatible multi-CD player, you can switch to this mode.

## Selecting discs from the disc title list

The disc title list lets you see the list of disc titles and select one of them for playback. Displayed disc titles are those which have been entered into the multi-CD player or recorded on a CD TEXT disc.

1. Press **FUNC** and then press **D.LIST** to select the disc title list mode.
2. Press **NEXT** to switch between “1” – “6” and “7” – “12”.



3. Press any of the buttons 1 – 6 (or 7 – 12) to select the desired disc title.

That selection will begin to play.

### Note:

- You can also use **◀**, **▶** and **▲** to select and play the desired disc title.
- “No D.Title” is displayed for a disc whose title has not been input.
- “No disc” is displayed next to the disc number when no disc is set in the magazine.
- You cannot display “7” – “12” when a 6-disc multi-CD player is connected.

## Pausing CD playback

Pause lets you temporarily stop playback of the CD.

1. Press **FUNC** and then press **PAUSE** to select the pause mode.

2. Press **PAUSE** to turn pause on.

The light illuminates. Play of the current track pauses.

- Press **PAUSE** again to turn pause off.
- When the pause mode is exited while pause is on, “PAUSE” is displayed in the basic display.

### Note:

- You can also turn pause on or off by pressing **PAUSE** in the following display.



- You can also turn pause on or off by pressing **PGM**.

## Entering disc titles

Disc title input lets you input up to 100 CD titles up to 10 letters long (with ITS memory) into the multi-CD player. If you input a CD title, the entered title is displayed.

1. Press **▲** or **▼** to play a disc you want to enter the title.
2. Press **FUNC** and **NEXT** and then press **TTLin** to select the disc title input mode.
3. Press **ABC** to switch the character mode. Press **ABC** repeatedly to switch between the following modes: Alphabet (upper case), numbers and symbols → Alphabet (lower case)
  - Press **012** to switch to the numbers and symbols mode.
4. Press **▲** or **▼** to select letters, numbers and symbols.



- To insert a space, select the flashing cursor “\_”.

Continued overleaf.

5. Press **▶** to move the cursor to the next character position.
  - Press **◀** to move backwards in the display.
6. Press **▶** to move the cursor to the last position and then press **▶** one more time after entering the title.
7. Press **BAND** to cancel the disc title input mode.

#### Note:

- When playing a CD TEXT disc on a CD TEXT compatible multi-CD player, if you switch to this mode, "No title input" is displayed and you cannot input the title.
- Titles remain in memory even after the disc has been removed from the magazine, and are recalled when the disc is reinserted.
- After the titles for 100 discs have been entered, the data for a new disc will overwrite the oldest one.

## Using compression and dynamic bass emphasis

Using the COMP (compression) and DBE (dynamic bass emphasis) functions enables multi-CD player sound quality adjustment. Each of the functions enables two-step adjustment. The COMP function adjusts imbalances between loud and subdued sounds at higher volumes. DBE boosts bass levels to give a fuller sound.

1. Press **FUNC** and **NEXT** and then press **COMP** to select the compression and dynamic bass emphasis mode.
2. Press **COMP** to select the desired setting.

Press COMP repeatedly to switch between the following settings:  
COMP OFF → COMP 1 → COMP 2  
→ COMP OFF → DBE 1 → DBE 2

  - When this mode is exited except for "COMP OFF" is selected, "COMP" appears on the basic display.

#### Note:

- If the multi-CD player does not support these functions, "No COMP" is displayed when you attempt to select it.

## Using ITS memory

The ITS (instant track selection) lets you make a program of favorite tracks from those in the multi-CD player magazine. After you have added your favorite tracks to the ITS memory, you can turn on ITS play and play just those selections.

### Programming tracks in ITS memory

You can use ITS to enter and play back up to 24 tracks per disc for up to 100 discs (with the disc title).

1. Press **▲** or **▼** to play the CD you want to program.
2. Press **FUNC** and **NEXT** and then press **ITS.M** to select the ITS memory mode.
3. Press **◀** or **▶** to select the desired track.
4. Press **MEMO** to store the currently playing track in the ITS memory.

"Memory complete" is displayed briefly and the currently playing track is added to ITS memory.
5. Press **BAND** to cancel the ITS memory mode.

#### Note:

- In this mode, you can also use **▲** to store the currently playing track in the ITS memory.
- After 100 discs have been programmed, the data for a new disc will overwrite the oldest one.

## Playback from ITS memory

ITS play lets you listen to the tracks that you have entered into ITS memory. When you turn on ITS play, tracks from ITS memory in the multi-CD player will begin to play.

### 1. Select the repeat range.

Refer to "Repeating play" on page 24.

### 2. Press **FUNC** and **NEXT** and then press **ITS.P** to select the ITS play mode.

### 3. Press **ITS.P** to turn ITS play on.

The light illuminates. Playback begins of those tracks from ITS memory within the selected repeat range: multi-CD player repeat or disc repeat.

- Press **ITS.P** again to turn ITS play off.
- When the ITS play mode is exited while ITS play is on, "ITS" appears on the basic display.

#### Note:

- If no track in the current play range is programmed for ITS play, "ITS empty" is displayed.

## Erasing a track from ITS memory

When you want to erase a track from ITS memory, you can do so when ITS play is on.

### 1. Turn ITS play on while playing a CD from which you want to erase a track program from ITS memory.

Refer to "Playback from ITS memory" on this page.

### 2. Press **FUNC** and **NEXT** and then press **ITS.M** to select the ITS memory mode.

### 3. Press **◀** or **▶** to select the desired track.

### 4. Press **CLEAR** to erase the currently playing track from ITS memory.

The currently playing track is erased from ITS memory and playback of the next track from ITS memory begins. If there are no tracks from ITS memory in the current play range, "ITS empty" is displayed and normal play resumes.

### 5. Press **BAND** to cancel the ITS memory mode.

#### Note:

- In this mode, you can also use **▼** to erase the currently playing track from ITS memory.

## Erasing a CD from ITS memory

When you want to erase all tracks of a CD from ITS memory, you can do so when ITS play is off.

### 1. Press **▲** or **▼** to select the CD you want to erase from ITS memory.

If ITS play is on, turn ITS play off. Refer to "Playback from ITS memory" on this page.

### 2. Press **FUNC** and **NEXT** and then press **ITS.M** to select the ITS memory mode.

### 3. Press **CLEAR** to erase all tracks on the currently playing CD from ITS memory.

"Memory deleted" is displayed briefly and all tracks on the currently playing CD are erased from ITS memory.

### 4. Press **BAND** to cancel the ITS memory mode.

#### Note:

- In this mode, you can also use **▼** to erase all tracks on the currently playing CD from ITS memory.

The following explains how to use this product to control a TV tuner, which is sold separately. For details of TV tuner-specific operation/features, see your TV tuner's manual.

- With this product, you can operate preset channel list as one additional function.

## Display and indicators

FORM 1

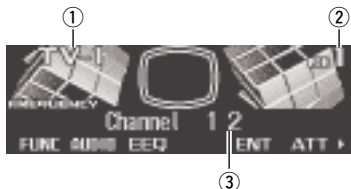

FORM 2

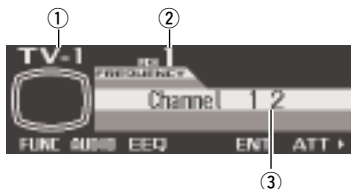

- ① Band
- ② Preset number
- ③ Channel

## Basic operation

1. **Press SOURCE to select the TV tuner.**  
Press SOURCE until "Television" appears.
2. **Press (up or down) VOLUME to adjust the volume.**
3. **Press ◀ or ▶ to tune in to a station.**
  - If you press and hold ◀ or ▶ for about one second and then release, you can perform seek tuning.

## Storing and recalling broadcast stations

If you press any of the buttons 1 – 6 (or 7 – 12), you can easily store up to 12 broadcast stations for later recall.

### Storing broadcast stations

1. **Press NEXT to display "1" – "6" (or "7" – "12").**  
Press NEXT until "1" – "6" (or "7" – "12") appears.
2. **When you find a station that you want to store in memory, press and hold any of the buttons 1 – 6 (or 7 – 12) until the preset number stops flashing.**  
The station is stored in memory under the selected button.

#### Note:

- Up to 12 stations can be memorized in one band.
- This product allows you to store and recall directly using preset channels 7 – 12.

## Recalling broadcast stations

1. Press **NEXT** to display “1” – “6” (or “7” – “12”).  
Press **NEXT** until “1” – “6” (or “7” – “12”) appears.
2. Press any of the buttons 1 – 6 (or 7 – 12) to recall the station preset under that button.

### Note:

- You can also use ▲ or ▼ to recall broadcast stations memorized under the buttons 1 – 12.

## Changing a band

- Press **BAND** to select the desired band.

Press **BAND** repeatedly to switch between the following bands:

TV 1 → TV 2

## TV tuner function menu

The TV tuner function menu has the following functions:



①

②

### ① BSSM (best stations sequential memory)

Press **BSSM** repeatedly to turn BSSM on or off.

When finished, the display switches to the preset channel list mode.

### ② chLIST (preset channel list)

For operation of the preset channel list, refer to “Selecting channels from the preset channel list” on this page.

### Note:

- If you do not operate the function within about 30 seconds, the display is automatically returned.
- You can also turn BSSM off by pressing **PGM**.

## Selecting channels from the preset channel list

The preset channel list lets you see the list of preset channels and select one of them to receive.

1. Press **FUNC** and then press **chLIST** to select the preset channel list mode.
2. Press **NEXT** to switch between “1” – “6” and “7” – “12”.



3. Press any of the buttons 1 – 6 (7 – 12) to recall the desired channel.

### Note:

- You can also use ◀, ▶ and ▲ to select and recall the desired channel.

## Adjusting the audio easily

The following functions let you easily adjust your audio system to match the car interior acoustic characteristics which vary depending on the type of car.

- Recalling equalizer curves (EEQ)
- Using position selector (POSI)
- Using time alignment (T.AL1)
- Adjusting equalizer curves (EQ1)

## Adjusting the audio finely

By carrying out the following settings/adjustments in order, you can create a finely-tuned sound field effortlessly.

- Using position selector (POSI)
- Using time alignment (T.AL1)
- Adjusting time alignment (T.AL2)
- Using subwoofer output (SW1)
- Adjusting subwoofer settings (SW2)
- Setting the high pass filter for front speakers (HPF F)
- Setting the high pass filter for rear speakers (HPF R)
- Using balance adjustment (F/B)
- Creating the auto-equalizer curve (A.EQ)
- Recalling equalizer curves (EEQ)
- Adjusting equalizer curves (EQ1)
- Adjusting 13-band graphic equalizer (EQ2)

## Extra functions

These functions are helpful in adjusting the sound to suit your system or your personal preferences.

- Using loudness (LOUD)
- Using sound field control, octaver and BBE sound (SFC)
- Adjusting source levels (SLA)
- Switching the digital attenuator (D.ATT)

## Recalling equalizer curves

The graphic equalizer lets you adjust equalization to match the car interior acoustic characteristics as desired. There are seven stored equalizer curves which you can easily recall at any time.

1. Press **EEQ** to switch to the easy equalizer mode.
2. Press **NEXT** to switch between “CSTM2” and the other selections (curves).
3. Press the corresponding button to select the desired equalizer curve.

Button	Equalizer curve
S.BASS	Super bass
PWRFL	Powerful
NATRL	Natural
VOCAL	Vocal
FLAT	Flat
CSTM1	Custom1
CSTM2	Custom2

- “CUSTOM1” and “CUSTOM2” are adjusted equalizer curves that you can create for yourself. (Refer to “Adjusting 13-band graphic equalizer” on page 33.)
- When “FLAT” is selected the equalizer makes no supplement or correction to the sound. This is useful for checking the effect of the equalizer curves by switching alternatively between “FLAT” and a set equalizer curve.

### Note:

- You can also use ◀ and ▶ to select the desired equalizer curve.
- If you do not operate the function within about eight seconds, the display is automatically returned.



## Audio menu

The audio menu has the following functions:

F/B LOUD SFC EQ1 EQ2

POS1 T.AL1 T.AL2 SW1 SW2 HFFF

MPR SLA A.EQ DATT

### Note:

- If you do not operate the function within about 30 seconds, the display is automatically returned. (When you select the 13-band graphic equalizer mode (EQ2) or the time alignment adjustment mode (T.AL2), the display is not returned automatically.)
- “T.AL2” is displayed only when you select “FL” or “FR” in the position selector mode (POS1).
- “SW1” and “SW2” are displayed only when you select “SW” in the preout output setting mode (refer to page 41).
- “SW2” is displayed only when the subwoofer output is on in the subwoofer output mode (SW1).
- “SLA” is not displayed when you select FM tuner as the source.
- “A.EQ” is displayed after the auto-equalizer curve has been set.

## Using balance adjustment

You can select a fader/balance setting that provides an ideal listening environment in all occupied seats.

1. Press **AUDIO** to select the fader/balance mode.
2. Press **▲** or **▼** to adjust front/rear speaker balance.

Each press of **▲** or **▼** moves the front/rear speaker balance towards the front or the rear.

- “FADER F25” – “FADER R25” is displayed as the front/rear speaker balance moves from front to rear.
- “FADER FR00” is the proper setting when only two speakers are used.

3. Press **◀** or **▶** to adjust left/right speaker balance.

Each press of **◀** or **▶** moves the left/right speaker balance towards the left or the right.

- “BALANCE L25” – “BALANCE R25” is displayed as the left/right speaker balance moves from left to right.

## Using loudness

Loudness compensates for deficiencies in the low- and high-sound ranges at low volume.

1. Press **AUDIO** and then press **LOUD** to select the loudness mode.
2. Press **LOUD** to turn the loudness on.
  - “LOUDNESS ON” appears in the display.
  - Press **LOUD** again to turn loudness off.

## Using sound field control, octaver and BBE® sound

SFC (sound field control) incorporates four programs reproducing the typical sound field of a studio, club, concert hall or dome. This function makes it possible to reproduce the realistic sound fields of the four programs in your car. Octaver makes the bass sound louder. BBE sound processing technology makes music sound “live”. Highs are clearer, naturally brilliant and more finely detailed. Lows are tight, well defined and harmonically rich.

### Note:

- Manufactured under license from BBE Sound, Inc. The mark BBE is a trademark of BBE Sound, Inc.

## Recalling sound field programs

1. Press **AUDIO** and then press **SFC** to select the sound field control mode.
2. Press the corresponding button to select the desired sound field program.

Button	Effect
STUDIO	Studio
CLUB	Club
HALL	Concert hall
DOME	Dome
OCT	Octaver 1 and 2
BBE	BBE

- Press the same button again to cancel the selected sound field program.

## Switching the octaver setting

You can switch the octaver setting. "OCTAVER2" has a stronger effect "OCTAVER1".

1. Press **AUDIO** and **SFC** and then press **OCT** to select octaver.
2. Press **▲** or **▼** to switch the octaver setting.

Each press of **▲** or **▼** switches the octaver setting between 1 and 2.

## Adjusting BBE sound level

For BBE sound processing technology, you can adjust the level of BBE.

1. Press **AUDIO** and **SFC** and then press **BBE** to select BBE.
2. Press **▲** or **▼** to adjust the level of BBE.

Each press of **▲** or **▼** increases or decreases the level of BBE.

- "+4" – "-4" is displayed as the level is increased or decreased.

## Adjusting equalizer curves

The factory supplied equalizer curves, with the exception of "FLAT", can be adjusted to a fine degree (nuance control).

1. Press **AUDIO** and then press **EQ1** to select the graphic equalizer mode.
2. Press **▲** or **▼** to adjust the equalizer curve.

Each press of **▲** or **▼** increases or decreases the equalizer curve respectively.

- "+6" – "-5" (or "-6") is displayed as the equalizer curve is increased or decreased.

### Note:

- The actual range of the adjustment differs depending on which equalizer curve is selected.
- The equalizer curve with all frequencies set to 0 cannot be adjusted.
- You can use **◀** and **▶** to select the desired equalizer curve.

## Adjusting 13-band graphic equalizer

For "CUSTOM1" and "CUSTOM2" equalizer curves, you can adjust the level of each band.

- A separate "CUSTOM1" curve can be created for each source. (The built-in CD and the multi-CD players are set to the same equalizer adjustment setting automatically.) If you make adjustments when a curve other than "CUSTOM2" is selected, the equalizer curve settings will be memorized in "CUSTOM1".
- A "CUSTOM2" curve can be created common to all sources. If you make adjustments when the "CUSTOM2" curve is selected, the "CUSTOM2" curve will be updated.

**1. Recall the equalizer curve you want to adjust.**

Refer to “Recalling equalizer curves” on page 31.

**2. Press AUDIO and then press EQ2 to select the 13-band graphic equalizer mode.**

**3. Press ◀ or ▶ to select the equalizer band to be adjusted.**

Each press of ◀ or ▶ selects equalizer bands in the following order:

50 ↔ 80 ↔ 125 ↔ 200 ↔ 315 ↔ 500  
 ↔ 800 ↔ 1.25k ↔ 2k ↔ 3.15k ↔ 5k  
 ↔ 8k ↔ 12.5k (Hz)

**4. Press ▲ or ▼ to adjust the level of the equalizer band.**

Each press of ▲ or ▼ increases or decreases the level of the equalizer band.

- “+6” – “-6” is displayed as the level is increased or decreased.
- You can then select another band and adjust the level.

## Using position selector

One way to assure a more natural sound is to clearly position the stereo image, putting you right in the center of the sound field.

The position selector function lets you automatically adjust the speakers' output levels and inserts a delay time to match the number and position of occupied seats.

The result is a natural sound regardless of where you are seated.

**1. Press AUDIO and NEXT and then press POSI to select the position selector mode.**

**2. Press the corresponding button to select a listening position.**

Button	Position
FL	Front seat left
FR	Front seat right
FRONT	Front seats
ALL	All seats

- Press the same button again to cancel the selected listening position.

**Note:**

- You can also use ▲, ▼, ◀ or ▶ to select the listening position.

Button	Position
◀	Front seat left
▶	Front seat right
▲	Front seats
▼	All seats

## Using time alignment

The time alignment lets you adjust the distance between each speaker and the listening position to match the type of car. There are five types of car stored which you can easily recall at any time.

1. Press **AUDIO** and **NEXT** and then press **T.AL1** to select the time alignment mode.
2. Press the corresponding button to select the type of car.

Button	Type of car
SEDAN	Sedan
WAGON	Wagon
M.VAN	Mini van
SUV	Sports utility vehicle
CUSTM	Custom

- “Custom” is an adjusted time alignment that you can create for yourself.

## Adjusting time alignment

For “Custom” time alignment, you can adjust the distance between each speaker and the selected position.

1. Press **AUDIO** and **NEXT** and then press **T.AL2** to select the time alignment adjustment mode.
2. Press the corresponding button to select a unit of distance.

Button	Unit of distance
cm	Centimeter
inch	Inch

3. Press **◀** or **▶** to select the speaker to be adjusted.

Each press of **◀** or **▶** selects speakers in the following order:

Front Left (front left) ↔ Front Right (front right) ↔ Rear Right (rear right) ↔ Rear Left (rear left) ↔ Sub. W (subwoofer)

- You cannot select “SUB.W” when the subwoofer output is off.
- You cannot select “Sub. W” when you select “REAR” in the preout output setting mode (refer to page 41).

4. Press **▲** or **▼** to adjust the distance between the selected speaker and the listening position.

Each press of **▲** or **▼** increases or decreases the distance.

- “400.0cm” – “0.0cm” is displayed as the distance is increased or decreased, if you have selected centimeters (cm).
- “160inch” – “0inch” is displayed as the distance is increased or decreased, if you have selected inches.
- You can adjust the distance for the other speakers in the same way.

### Note:

- “T.AL2” is not displayed when neither “FL” or “FR” is selected in the position selector mode (POS1). If “FL” or “FR” is not selected, “T.AL2” is inactive.

## Using subwoofer output

This product is equipped with a subwoofer output which can be switched on or off. When a subwoofer is connected to this product, turn the subwoofer output on.

The subwoofer output phase can be switched between normal and reverse.

1. Press **AUDIO** and **NEXT** and then press **SW1** to select the subwoofer output mode.

2. Press **SW1** to turn the subwoofer output on.

“SUB. W ON” appears in the display.

- Press **SW1** again to turn subwoofer output off.

3. Press **◀** or **▶** to select the subwoofer output phase.

Press **◀** to select reverse phase. Press **▶** to select normal phase.

## Adjusting subwoofer settings

When the subwoofer output is on, you can adjust the cut-off frequency and the output level of the subwoofer.

1. Press **AUDIO** and **NEXT** and then press **SW2** to select the subwoofer setting mode.
2. Press **◀** or **▶** to select the cut-off frequency.  
Each press of **◀** or **▶** selects cut-off frequencies in the following order:  
50 ↔ 63 ↔ 80 ↔ 100 ↔ 125 (Hz)
3. Press **▲** or **▼** to adjust the output level of the subwoofer.  
Each press of **▲** or **▼** increases or decreases the level of the subwoofer.
  - “+6” – “-24” is displayed as the level is increased or decreased.

### Note:

- “SW2” is not displayed when the subwoofer output is off in the subwoofer output mode (SW1). In this case, this mode is inactive.

## Using the high pass filter

When the subwoofer is connected and you do not want low sound to play from the front or rear speakers, turn the high pass filter on. Only frequencies higher than those in the selected range will be output from the front or rear speakers.

### Setting the high pass filter for front speakers

1. Press **AUDIO** and **NEXT** and then press **HPF F** to select the high pass filter mode.
2. Press **HPF F** to turn the high pass filter on.  
“HPF ON” appears in the display.
  - Press **HPF F** again to turn the high pass filter off.

3. Press **◀** or **▶** to select a high pass filter range.

Each press of **◀** or **▶** selects frequencies in the following order:  
50 ↔ 63 ↔ 80 ↔ 100 ↔ 125 (Hz)

### Setting the high pass filter for rear speakers

1. Press **AUDIO** and then press **NEXT** twice.
2. Press **HPF R** to select the high pass filter mode.
3. Press **HPF R** to turn the high pass filter on.  
“HPF ON” appears in the display.
  - Press **HPF R** again to turn the high pass filter off.
4. Press **◀** or **▶** to select a high pass filter range.

Each press of **◀** or **▶** selects frequencies in the following order:  
50 ↔ 63 ↔ 80 ↔ 100 ↔ 125 (Hz)

## Adjusting source levels

SLA (source level adjustment) lets you adjust the volume level of each source to prevent radical changes in volume when switching between sources.

- Settings are based on the FM tuner volume level, which remains unchanged.
1. **Compare the FM tuner volume level with the level of the source you want to adjust (e.g., built-in CD player).**

2. **Press AUDIO and then press NEXT twice.**
3. **Press SLA to select the SLA mode.**

4. **Press ▲ or ▼ to adjust the source volume.**

Each press of ▲ or ▼ increases or decreases the source volume.

- “+4” – “-4” is displayed as the source volume is increased or decreased.

### Note:

- Since the FM tuner volume is the control, it is not possible to apply source level adjustments to the FM tuner.
- The AM tuner volume level can also be adjusted using source level adjustment.
- The built-in CD and the multi-CD players are both set to the same source level adjustment volume automatically.

## Using the auto-equalizer

The auto-equalizer is the equalizer curve created by auto-equalizing. (Refer to “Creating the auto-equalizer curve” on this page.)

You can turn the auto-equalizer on or off.

1. **Press AUDIO and then press NEXT twice.**
2. **Press A.EQ to select the auto-equalizer on/off mode.**

3. **Press A.EQ to turn the auto-equalizer on.**  
“AUTO EQ ON” appears in the display.
  - Press A.EQ again to turn auto-equalizer off.

### Note:

- “A.EQ” is not displayed if auto-equalizing has not been carried out. In this case, this mode is inactive.

## Switching the digital attenuator

When listening to a CD or other source on which the recording level is high, setting the equalizer curve level to high may result in distortion.

You can switch the digital attenuator to low to reduce distortion.

- Sound quality is better at the high setting, so this is the setting usually used.

1. **Press AUDIO and then press NEXT twice.**
2. **Press D.ATT to select the digital attenuator mode.**
3. **Press the corresponding button to select the digital attenuator level.**

Button	Level
LOW	Low
HIGH	High

## Creating the auto-equalizer curve

The auto-equalizer automatically measures car interior acoustic characteristics, and then creates the auto-equalizer curve based on that information.

### WARNING:

- To prevent accidents, never carry out auto-equalizing while driving. When this function measures the car interior acoustic characteristics to create an auto-equalizer curve, a loud measurement tone (noise) may be output from the speakers.

## PRECAUTION:

- Carrying out auto-equalizing under the following conditions may damage the speakers. Be sure to check conditions thoroughly before carrying out auto-equalizing.
  - When speakers are incorrectly connected. (e.g., When a rear speaker is connected to a subwoofer output.)
  - When a speaker is connected to a power amp delivering output higher than the speaker's maximum input power capability.
- If the microphone is placed in an unsuitable position the measurement tone may become loud and measurement may take a long time, resulting in a drain on battery power. Be sure to place the microphone in the specified location. (Refer to "Carrying out auto-equalizing.")

## Before operating the auto-equalization function

- Carry out auto-equalizing in as quiet a place as possible, with the car engine and air conditioning switched off. Also cut power to car phones or portable telephones in the car, or remove from the car before carrying out auto-equalizing. Sounds other than the measurement tone (surrounding sounds, engine sound, telephones ringing etc.) may prevent correct measurement of car interior acoustic characteristics.
- Be sure to carry out auto-equalizing using the supplied microphone. Using another microphone may prevent measurement, or result in incorrect measurement of car interior acoustic characteristics.
- Neither front nor rear speaker is connected, auto-equalizing cannot be carried out.
- When this product is connected to a power amp with input level control, auto-equalizing may not be possible if you lower power amp input level. Set the power amp's input level to the standard position.

- Auto-equalizing changes the audio settings as below:
  - The fader/balance settings return to the center position. (Refer to page 32.)
  - The graphic equalizer curve switches to "FLAT". (Refer to page 31.)
  - When a subwoofer is connected to this product, it will be adjusted automatically either subwoofer output and high pass filter setting for rear speaker.
- If you carry out auto-equalizing when an auto-equalizer curve already exists, the previous curve will be erased.
- If you change the preout output setting after you performed Auto equalizing, Auto-equalizer curve is erased. In this case, perform Auto-equalizing again.

## Carrying out auto-equalizing

1. **Stop the car in a place that is as quiet as possible, close all doors, windows and the sun roof, and then turn the engine off.**

If the engine is left running, engine noise may prevent correct auto-equalizing.

2. **Fix the supplied microphone in the center of the headrest of the driver's seat, facing forward, using the belt (sold separately).**

The auto-equalizer curve may differ depending on where you place the microphone. If desired, place the microphone on the front passenger seat to carry out auto-equalizing.

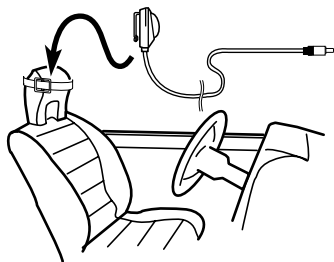

Continued overleaf.

# Audio Adjustments

### 3. Turn the ignition switch to ON or ACC.

If the car's air conditioner or heater is turned on, turn it off. Noise from the fan in the air conditioner or heater may prevent correct auto-equalizing.

- Press (up or down) SOURCE to turn the source on if this product is turned off.

### 4. Select the position for the seat on which the microphone is placed.

Refer to "Using position selector" on page 34.

- If no position is selected before you start auto-equalizing, "FL" is selected automatically.

### 5. Press (up or down) SOURCE to turn the source off.

### 6. Press and hold **↔2** to enter the auto-equalizer measurement mode.

The front panel opens automatically.

- When the source is off, you can check the location of "**↔2**" by turnig on the feature demo.

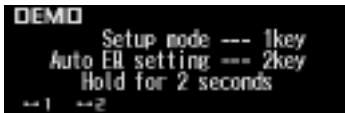

- You can also enter the auto-equalizer measurement mode by pressing and holding AUDIO on the remote controller.

### 7. Plug the microphone into the microphone input jack on this product.

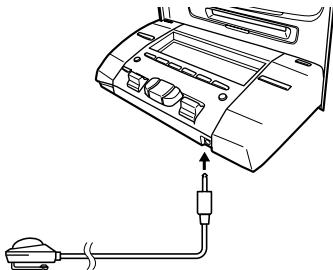

### 8. Press A.EQ to start the auto-equalizing.

### 9. Get out of the car and close the door within 10 seconds when the 10-second count-down starts.

The measurement tone (noise) is output from the speakers, and auto-equalizing (acoustic characteristics measurement and compensation) begins.

- When all speakers are connected, auto-equalizing is completed in about four minutes.
- To cancel auto-equalizing part way through, press any button.

### 10. When auto-equalizing is completed, "Complete" is displayed.

When correct measurement of car interior acoustic characteristics is not possible, an error message is displayed. (Refer to "Understanding auto-equalizing error messages" on page 48.)

### 11. Press any button to cancel the auto-equalizer mode.

### 12. Store the microphone carefully in the glove compartment.

Store the microphone carefully in the glove compartment or other safe place. If the microphone is subjected to direct sunlight for an extended period, high temperatures may cause distortion, color change or malfunction.



## Initial settings menu

The initial settings menu has the following functions:



REV DEMO AUX NOTES



F.DEMO FUNCTION

### Initial settings menu operation

You can operate the initial settings menu only when the source is off.

1. Press (up or down) **SOURCE** to turn the source off.
2. Press and hold **↔1** to enter the initial settings menu.

- When the source is off, you can check the location of “↔1” by turning on the feature demo.



DEMO  
Setup mode --- 1key  
Auto ER setting --- 2key  
Hold for 2 seconds  
↔1 ↔2

- You can also enter the initial settings menu by pressing and holding **FUNCTION** on the remote controller.

#### Note:

- Press **BAND** to cancel the initial settings menu.

## Using reverse mode

If you do not carry out an operation within about 30 seconds, screen indications will start to reverse, and then continue reversing every 10 seconds.

You can turn the reverse mode on or off.

1. With the source turned off, press and hold **↔1** to select the reverse mode.
2. Press **REV** to turn the reverse mode on.  
“ON” appears in the display.
  - Press **REV** again to turn the reverse mode off.

## Using the feature demo

The feature demo automatically starts when power to this product is switched off while the ignition switch is set to ACC or ON.

You can turn the feature demo on or off.

1. With the source turned off, press and hold **↔1**.
2. Press **F.DEMO** to select the feature demo mode.
3. Press **F.DEMO** to turn the feature demo on.

“ON” appears in the display.

- Press **F.DEMO** again to turn the feature demo off.

#### Note:

- The red lead (ACC) of this product should be connected to a terminal coupled with ignition switch ON/OFF operations. If this is not done, the vehicle battery may be drained.

## Switching the auxiliary setting

It is possible to use auxiliary equipment with this product.

Turn the auxiliary setting on when using external equipment connected to this product.

1. With the source turned off, press and hold **↔1**.
2. Press **AUX** to select the AUX mode.
3. Press **AUX** to turn AUX on.

“ON” appears in the display.

- Press **AUX** again to turn AUX off.

## Switching the telephone muting/attenuation setting

Sound from this product is muted or attenuated automatically when a call is made or received using a connected cellular telephone.

1. With the source turned off, press and hold **↔** 1.
2. Press **MUTE.S** to select the telephone muting/attenuation mode.
3. Press **MUTE.S** to select the desired setting.

Press **MUTE.S** repeatedly to switch between the following settings:

TEL mute → 10dB ATT → 20dB ATT

- “20dB ATT” has a stronger effect than “10dB ATT”, and “TEL mute” has a stronger effect than “20dB ATT”.

### Note:

- The sound turns off, “MUTE” or “ATT” is displayed and no audio adjustments, except volume control, are possible.
- Operation returns to normal when the phone call is ended.

## Setting preout output

This product is equipped with a preout output. It can be used for subwoofer or rear output. Initially, it is set for SW (subwoofer). When connecting a rear speaker to this output, set for REAR (rear speaker).

1. With the source turned off, Press and hold **↔** 1.
2. Press **NEXT** and then press **PREOUT** to select the preout output setting mode.
3. Press **SW** (subwoofer) or **REAR** (rear speaker) to switch your desired preout output type.

## Setting the FM tuning step

The FM tuning step employed by seek tuning can be switched between 100 kHz, the preset step, and 50 kHz.

1. With the source turned off, press and hold **↔** 1.
2. Press **NEXT** and then press **FMstep** to select the FM tuning step mode.
3. Press the corresponding button to select the desired tuning step.

Button	Tuning step
50K	50 kHz
100K	100 kHz

### Note:

- If seek tuning is performed in 50 kHz steps, stations may be tuned in imprecisely. Tune in the stations with manual tuning or use seek tuning again.

## Setting the AM tuning step

The AM tuning step can be switched between 9 kHz, the preset step, and 10 kHz. When using the tuner in North, Central or South America, reset the tuning step from 9 kHz (531 – 1,602 kHz allowable) to 10 kHz (530 – 1,640 kHz allowable).

1. With the source turned off, press and hold **↔** 1.
2. Press **NEXT** and then press **AMstep** to select the AM tuning step mode.
3. Press the corresponding button to select the desired tuning step.

Button	Tuning step
9K	9 kHz
10K	10 kHz

## Attenuating volume

The attenuator lets you lower the volume level quickly (by about 90%).

- Press **ATT** to turn the attenuator on.  
“ATT” appears in the display.
- Press **ATT** again to turn the attenuator off and return to the original volume level.

## Displaying and setting the clock

You can turn the time display on or off and set the time.

### Setting the time display on or off

1. Press **NEXT** to display “CLK”.  
Press **NEXT** until “CLK” appears.
2. Press **CLK** and then press **ON/OFF** to turn the time display on.  
The light illuminates. When the time display is turned on, “TIME”, “DATE” and “JUST” appear simultaneously.
  - Press **ON/OFF** again to turn the time display off.
  - If you press **BAND** and exit the calendar and time mode, the time display will appear instead of the source name.



Time display

#### Note:

- If you do not operate the function within about 60 seconds, the display is automatically returned.

### Off clock display

When the time display is turned on, the calendar display appears with the time display when sources and the feature demo are off.

## Setting the date

The calendar display adjusted in this mode appears only when sources and the feature demo are off.

1. Press **NEXT** to display “CLK”.  
Press **NEXT** until “CLK” appears.
2. Press **CLK** and then press **DATE** to set the date.
3. Press **◀** or **▶** to switch between day, month and year.
4. Press **▲** or **▼** to correct the date.  
Pressing **▲** advances the day, month or year.  
Pressing **▼** turns back the day, month or year.

## Setting the time

1. Press **NEXT** to display “CLK”.  
Press **NEXT** until “CLK” appears.
2. Press **CLK** and then press **TIME** to set the time.
3. Press **◀** or **▶** to switch between hour and minute.
4. Press **▲** or **▼** to adjust the time.  
Pressing **▲** advances the hour or minute.  
Pressing **▼** turns back the hour or minute.

## Matching the time to a time signal

1. Press **NEXT** to display “CLK”.  
Press **NEXT** until “CLK” appears.
2. Press **CLK** and then press **JUST** to match the time to a time signal.
  - If the minute is “00” – “29”, the minutes are rounded down. (e.g., “10:18” becomes “10:00”.)
  - If the minute is “30” – “59”, the minutes are rounded up. (e.g., “10:36” becomes “11:00”.)

#### Note:

- During date adjustment, “JUST” is not displayed.

### Changing the display form

This product is equipped with two basic displays. You can select the desired display.

1. **Press NEXT to display “C.MENU”.**  
Press NEXT until “C.MENU” appears.
2. **Press C.MENU and then press D.FORM to select the display form mode.**
3. **Press either FORM 1 or FORM 2 to select the desired display form.**

### Adjusting the brightness

Display brightness adjustment lets you adjust the display for easier viewing when lighting conditions change.

1. **Press NEXT to display “C.MENU”.**  
Press NEXT until “C.MENU” appears.
2. **Press C.MENU and then press BRGHT to select the brightness mode.**
3. **Press ◀ or ▶ to adjust the brightness.**  
Each press of ◀ or ▶ increases or decreases the brightness.
  - “00” – “31” is displayed as the brightness is increased or decreased.

### Switching the dimmer setting

To prevent the display from being too bright at night, the display is automatically dimmed when the car’s headlights are turned on. You can switch the dimmer on or off.

1. **Press NEXT to display “C.MENU”.**  
Press NEXT until “C.MENU” appears.
2. **Press C.MENU and then press DMMER to select the dimmer mode.**
3. **Press DMMER to turn the dimmer on.**  
“ON” appears on the display.
  - Press DMMER again to turn the dimmer off.

### Selecting the wall paper pattern

The wall paper pattern is only for display form 2 “FORM 2”, and there are three patterns to choose from.

- When you select “FORM 1”, “PTRN” is not displayed and this mode is inactive.

1. **Press NEXT to display “C.MENU”.**  
Press NEXT until “C.MENU” appears.
2. **Press C.MENU and then press PTRN to select the wall paper pattern mode.**
3. **Press any of the buttons A – C to select the desired pattern.**

### Setting the entertainment display

You can change the display to the movie screens, the spectrum analyzer displays, etc., while listening to any source.

#### Setting the movie screen

There are two stored movie screens to select from.

1. **Press ENT and then press MOVIE to select the movie mode.**
2. **Press any of the buttons MOVIE1, MOVIE2 or ALL to select the desired movie.**
  - When you press ALL, you can display movies 1 and 2 sequentially.

#### Note:

- The movie screen will disappear temporarily when you perform other operations, but will be displayed again after three seconds.

#### Setting the spectrum analyzer display

There are two stored spectrum analyzer displays to select from.

1. **Press ENT and then press S/A to select the spectrum analyzer mode.**
2. **Press S/A1 or S/A2 to select the desired spectrum analyzer.**

#### Note:

- The spectrum analyzer display will disappear temporarily when you perform other operations, but will be displayed again after three seconds.

#### Setting the background visual

The background visuals are only for display form 1 “FORM 1”. There are five stored background visuals to select from.

- When you select “FORM 2”, “BG” is not displayed and this mode is inactive.

1. Press **ENT** and **BG** and then press **BGV** to select the background visual mode.
2. Press any of the buttons **BGV1 – BGV5** to select the desired visual.

### Setting the background still picture

The background still pictures are only for the display form 1 "FORM 1". There are three stored background still pictures to select from.

- When you select "FORM 2", "BG" is not displayed and this mode is inactive.

1. Press **ENT** and **BG** and then press **BGP** to select the background still picture mode.
2. Press any of the buttons **BGP1 – BGP3** to select the desired picture.

### Canceling the entertainment display

You can cancel the entertainment display (the movie screens, the spectrum analyzer displays, etc.).

- Press **ENT** and then press **OFF** to cancel the entertainment display.

## Using the AUX source

An IP-BUS-RCA interconnector such as the CD-RB20 or CD-RB10 (sold separately) lets you connect this product to auxiliary equipment featuring RCA output. For more details, refer to the IP-BUS-RCA interconnector's owner's manual.

### Selecting AUX as the source

- Press (up or down) **SOURCE** to select **AUX** as the source.

Press (up or down) **SOURCE** until "AUX" appears.

### Entering the AUX title

The title displayed for the AUX source can be changed.

1. Press (up or down) **SOURCE** to select **AUX** as the source.

Press (up or down) **SOURCE** until "AUX" appears.

2. Press **FUNC** and then press **TTLin** to select the AUX title input mode.

Refer to "Entering disc titles" on page 26, and perform procedures 3 to 7 in the same way.

#### Note:

- Even if you do not press **TTLin** you can enter the title, but you will not be able to change the character types.

### CD player and care

- Use only CDs that carry either of the two Compact Disc Digital Audio marks shown below.



- Use only normal, round CDs. If you insert irregular, non-round, shaped CDs they may jam in the CD player or not play properly.

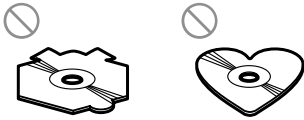

- Check all CDs for cracks, scratches or warping before playing. CDs that are cracked, scratched or warped may not play properly. Do not use such discs.
- Avoid touching the recorded (non-printed side) surface when handling the disc.
- Store discs in their cases when not in use.
- Keep discs out of direct sunlight and do not expose the discs to high temperatures.
- Do not attach labels, write on or apply chemicals to the surface of the discs.
- To clean dirt from a CD, wipe the disc with a soft cloth outward from the center of the disc.



- If the heater is used in cold weather, moisture may form on components inside the CD player. Condensation may cause the CD player not to operate properly. If you think that condensation is a problem, turn off the CD player for an hour or so to allow the CD player to dry out and wipe any damp discs with a soft cloth to remove the moisture.
- Road shocks may interrupt CD playback.

### CD-R and CD-RW discs

- CD-R (CD-Recordable)/CD-RW (CD-ReWritable) discs recorded on CD recorder units other than a music CD recorder may not play properly on this CD player.
- Music CD-R/CD-RW discs, even when recorded on a music CD recorder, may not play properly on this CD player because of differing disc characteristics, scratches or dirt on the disc. Dirt or condensation on the lens inside this product may also prevent playback.
- Titles and other text information recorded on a CD-R/CD-RW disc may not be displayed by this product.
- This product conforms to the track skip function of the CD-R/CD-RW disc. The tracks containing the track skip information are skipped over automatically.
- If you insert a CD-RW disc into this product, load time to playback will be longer than for a conventional CD or CD-R disc.
- Read the precautions accompanying the CD-R/CD-RW discs before use.

## MD player and care

- Use MDs bearing this mark. Using a disc other than a music MD may result in damage to this product.



- Do not open the MD shutter by hand. Forcing it open may result in damage.



- Be sure to stick labels supplied with MDs in the specified location. Failing to do this, or sticking one label on top of another may make it impossible for the MD to be removed.

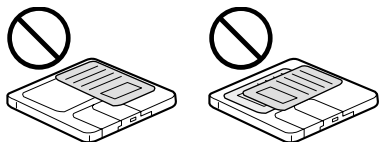

- Do not use MDs with labels that are not affixed correctly. Labels like this may catch on something, preventing removal of the MD. Before using an MD, remove the label if it is not correctly affixed, and replace it with a new label.

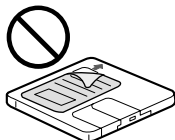

- Keep MDs out of direct sunlight and high temperatures.
- If the surface of an MD cartridge is dirty, wipe it gently with a clean, soft cloth.
- Do not apply benzene, thinner or other volatile liquids to MDs.
- When using an MD cleaning disc, be sure to read the disc's instructions carefully. Cleaning discs may result in damage to this product.
- When it's cold, if you start playing an MD immediately after switching the heater in a room on, condensation on the optical lens inside the player or on the MD may prevent normal play. If this happens, turn off the player for about an hour to allow the condensation to evaporate, and wipe damp MD cartridge surfaces with a soft cloth.

### Understanding built-in CD player error messages

When problems occur during CD play, an error message may appear on the display. If an error message appears on the display, refer to the table below to see what the problem is and the suggested method of correcting the problem. If the error cannot be corrected, contact your dealer or your nearest Pioneer service center.

Display	Cause	Remedy
ERROR- 11, 12, 17, 30	Dirty disc.	Clean disc.
ERROR- 11, 12, 17, 30	Scratched disc.	Replace disc.
ERROR- 14	Unrecorded disc.	Check the disc.
ERROR- 10, 11, 12, 14, 17, 30, A0	Electrical or mechanical problem.	Turn the ignition ON and OFF, or switch to a different source, then back to the CD player.
ERROR- 44	All tracks are skip tracks.	Replace disc.
HEAT	CD player overheated.	Turn off the CD player and wait until the CD player cools down.

### Understanding built-in MD player error messages

When problems occur during MD play, an error message may appear on the display. If an error message appears on the display, refer to the table below to see what the problem is and the suggested method of correcting the problem. If the error cannot be corrected, contact your dealer or your nearest Pioneer service center.

Display	Cause	Remedy
BLANK DISC	Blank disc is inserted.	Replace disc.
TEMP	MD player overheating. temperature drops.	Discontinue play until the machine
ERROR- 11, 12, 17, 30	Dirty disc.	Clean disc.
ERROR- 11, 12, 17, 30	Scratched disc.	Replace disc.
ERROR- 01, 11, 12, 17, 30, A0	Electrical or mechanical problem.	Turn the ignition ON and OFF, or switch to a different source, the back to the MD player.
ERROR- 20, 21	Track information cannot be read.	Reload the MD.
ERROR- 20, 21, 24	There is something wrong with the MD.	Replace disc.
ERROR- 23	The MD contains recorded information other than music.	Replace disc.
ERROR- A1	Electrical or mechanical problem.	Press RESET.
ERROR-	MD play not possible.	Replace the MD with another disc, or press RESET.



## Understanding auto-equalizing error messages

When correct measurement of car interior acoustic characteristics is not possible using the auto-equalizer, an error message may appear on the display. If an error message appears on the display, refer to the table below to see what the problem is and the suggested method of correcting the problem. After checking, try again.

Display	Cause	Remedy
ERROR CHECK MIC	Microphone is not connected.	Plug the supplied microphone securely into the jack.
ERROR CHECK SPEAKER	The microphone cannot pick up the measuring tone of the front and rear speakers.	<p>Confirm that the speakers are connected correctly.</p> <p>Correct the input level setting of the power amp connected to the speakers.</p> <p>Set the microphone correctly.</p>
ERROR CHECK SYSTEM	The surrounding noise level is too high.	<p>Stop your car in a place that is as quiet as possible, and switch off the engine, air conditioner or heater.</p> <p>Set the microphone correctly.</p>

### Connecting the units

**Note:**

- This unit is for vehicles with a 12-volt battery and negative grounding. Before installing it in a recreational vehicle, truck or bus, check the battery voltage.
- To avoid shorts in the electrical system, be sure to disconnect the ⊖ battery cable before beginning installation.
- Refer to the owner's manual for details on connecting the power amp and other units, then make connections correctly.
- Secure the wiring with cable clamps or adhesive tape. To protect the wiring, wrap adhesive tape around them where they lie against metal parts.
- Route and secure all wiring so it cannot touch any moving parts, such as the gear shift, handbrake and seat rails. Do not route wiring in places that get hot, such as near the heater outlet. If the insulation of the wiring melts or gets torn, there is a danger of the wiring short-circuiting to the vehicle body.
- Don't pass the yellow lead through a hole into the engine compartment to connect to the battery. This will damage the lead insulation and cause a very dangerous short.
- Do not shorten any leads. If you do, the protection circuit may fail to work when it should.
- Never feed power to other equipment by cutting the insulation of the power supply lead of the unit and tapping into the lead. The current capacity of the lead will be exceeded, causing overheating.
- When replacing fuse, be sure to use only fuse of the rating prescribed on the fuse holder.
- Since a unique BPTL circuit is employed, never wire so the speaker leads are directly grounded or the left and right ⊖ speaker leads are common.
- The black lead is ground. Please ground this lead separately from the ground of high-current products such as power amps. If you ground the products together and the ground becomes detached, there is a risk of damage to the products or fire.
- If the RCA pin jack on the unit will not be used, do not remove the caps attached to the end of the connector.
- Speakers connected to this unit must be high-power types with minimum rating of 50 W and impedance of 4 to 8 ohms. Connecting speakers with output and/or impedance values other than those noted here may result in the speakers catching fire, emitting smoke, or becoming damaged.
- When an external power amp is being used with this system, be sure not to connect the blue/white lead to the amp's power terminal. Likewise, do not connect the blue lead to the power terminal of the auto-antenna. Such connection could cause excessive current drain and malfunction.
- To prevent incorrect connection, the input side of the IP-BUS connector is blue, and the output side is black. Connect the connectors of the same colors correctly.

- If this unit is installed in a vehicle that does not have an ACC (accessory) position on the ignition switch, the red lead of the unit should be connected to a terminal coupled with ignition switch ON/OFF operations. If this is not done, the vehicle battery may be drained when you are away from the vehicle for several hours. (Fig. 1)



ACC position

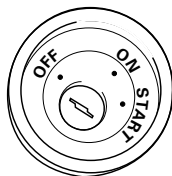

No ACC position

**Fig. 1**

- Cords for this product and those for other products may be different colors even if they have the same function. When connecting this product to another product, refer to the supplied Installation manuals of both products and connect cords that have the same function.

# Additional Information

## Connection Diagram

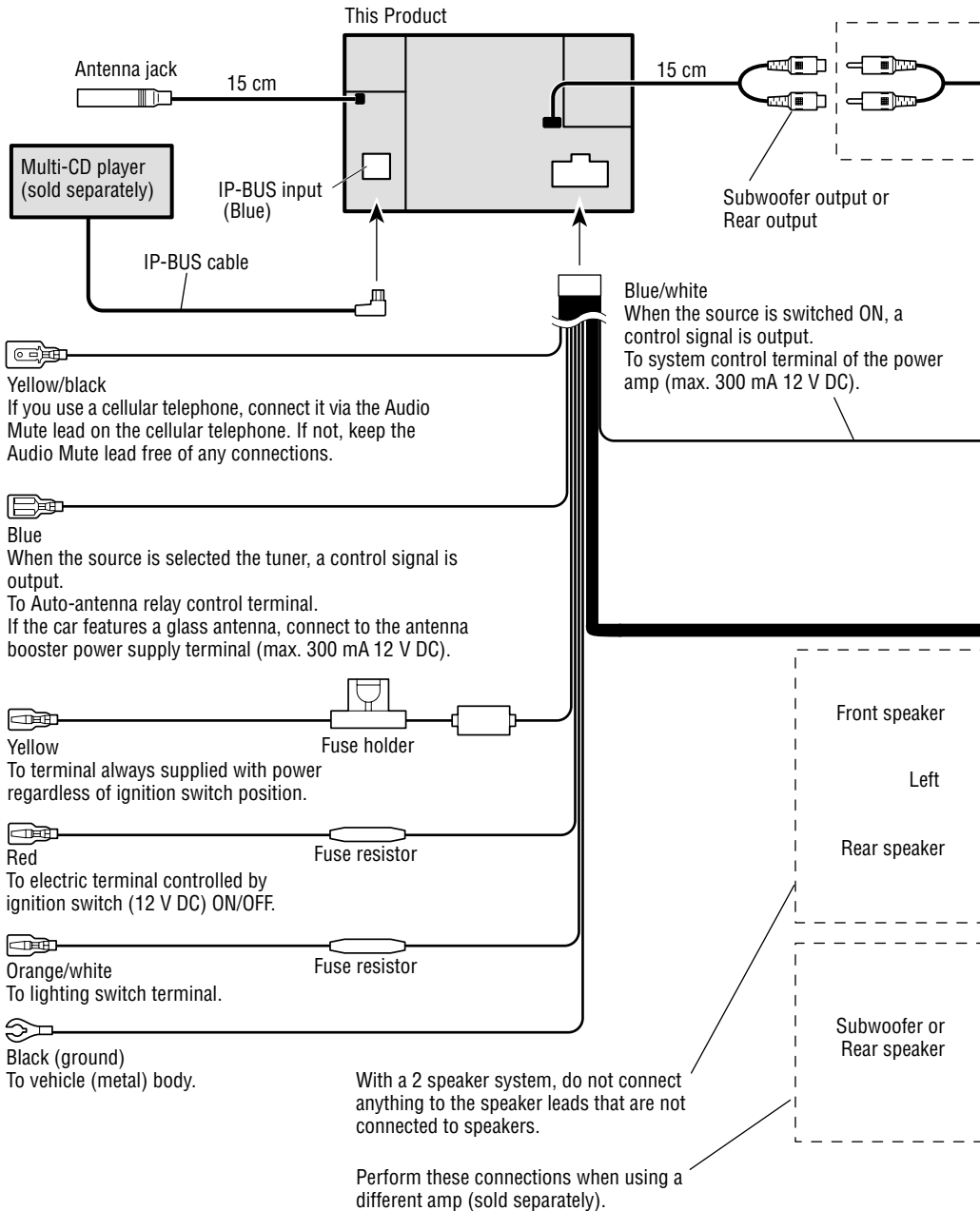

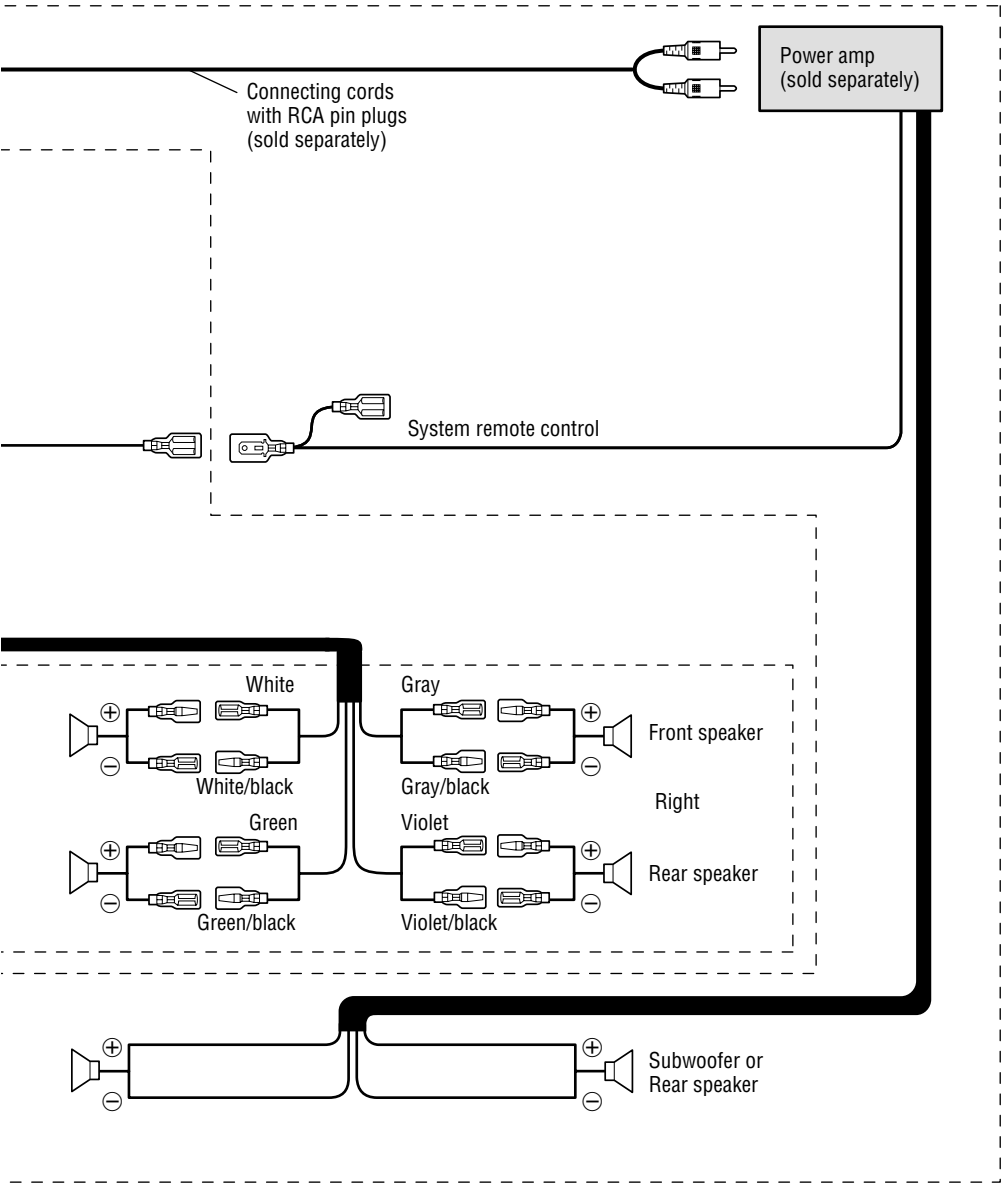

Fig. 2

## Installation

### Note:

- Before finally installing the unit, connect the wiring temporarily, making sure it is all connected up properly, and the unit and the system work properly.
- Use only the parts included with the unit to ensure proper installation. The use of unauthorized parts can cause malfunctions.
- Consult with your nearest dealer if installation requires the drilling of holes or other modifications of the vehicle.
- Install the unit where it does not get in the driver's way and cannot injure the passenger if there is a sudden stop, like an emergency stop.
- The semiconductor laser will be damaged if it overheats, so don't install the unit anywhere hot — for instance, near a heater outlet.

- If installation angle exceeds  $30^\circ$  from horizontal, the unit might not give its optimum performance. (Fig. 3)

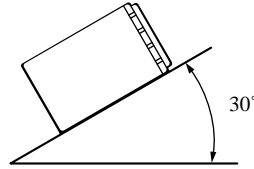

**Fig. 3**

- The cords must not cover up the area shown in the figure below. This is necessary to allow the amplifiers to radiate freely. (Fig. 4)

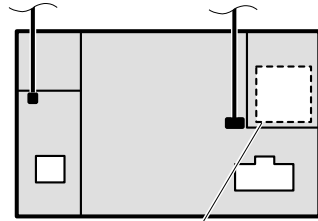

Do not close this area.

**Fig. 4**

## Installation using the screw holes on the side of the unit

### Fastening the unit to the factory radio mounting bracket. (Fig. 5) (Fig. 6)

Select a position where the screw holes of the bracket and the screw holes of the head unit become aligned (are fitted), and tighten the screws at 3 or 4 places on each side. Use either binding screws ( $5 \times 6$  mm) or flush surface screws ( $5 \times 6$  mm), depending on the shape of the screw holes in the bracket.

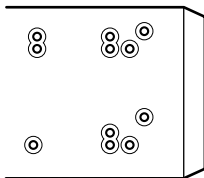

Fig. 5

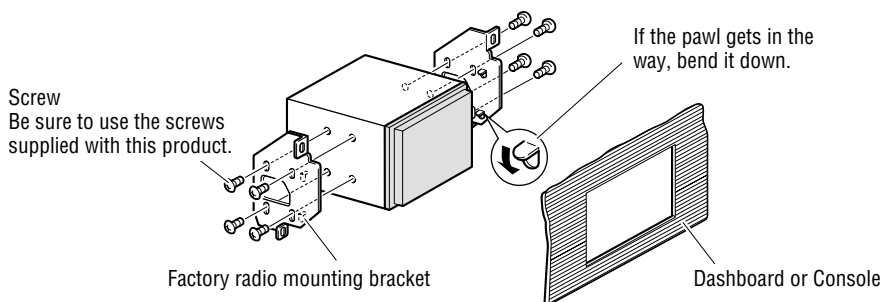

Fig. 6

## Specifications

### General

Power source	14.4 V DC (10.8 – 15.1 V allowable)
Grounding system	Negative type
Max. current consumption	10.0 A
Dimensions	
(mounting size)	178 (W) × 100 (H) × 160 (D) mm
(front face)	170 (W) × 95 (H) × 16 (D) mm
Weight	2.7 kg

### Audio/DSP

Continuous power output is 22 W per channel min. into 4 ohms, both channels driven 50 to 15,000 Hz with no more than 5% THD.	
Maximum power output	50 W × 4
Load impedance	4 Ω (4 – 8 Ω allowable)
Preout maximum output	
level/output impedance	2.0 V/1 kΩ
Loudness contour	+10 dB (100 Hz), +7 dB (10 kHz) (volume: –30 dB)
Equalizer (13-Band Graphic Equalizer)	
Frequency	50/80/125/200/315/500/800 1.25k/2k/3.15k/5k/8k/12.5k Hz
Equalization range	±12 dB
HPF	
Frequency	50/63/80/100/125 Hz
Slope	–12 dB/oct.
Subwoofer	
Frequency	50/63/80/100/125 Hz
Slope	–18 dB/oct.
Gain	+6 — –24 dB
Phase	Normal/Reverse

### CD player

System	Compact disc audio system
Usable discs	Compact disc
Signal format	
Sampling frequency	44.1 kHz
Number of quantization bits	16; linear
Frequency characteristics	5 – 20,000 Hz (±1 dB)
Signal-to-noise ratio	94 dB (1 kHz) (IEC-A network)
Dynamic range	92 dB (1 kHz)
Number of channels	2 (stereo)

### MD player

System	Mini disc digital audio system
Usable discs	Mini disc
Signal format	
Sampling frequency	44.1 kHz
Number of quantization bits	16; linear
Frequency characteristics	20 – 20,000 Hz (±1 dB)
Signal-to-noise ratio	90 dB (1 kHz) (IEC-A network)
Dynamic range	90 dB (1 kHz)
Number of channels	2 (stereo)

### FM tuner

Frequency range	87.5 – 108 MHz
Usable sensitivity	9 dBf (0.8 μV/75 Ω, mono, S/N: 30 dB)
50 dB quieting sensitivity	15 dBf (1.5 μV/75 Ω, mono)
Signal-to-noise ratio	70 dB (IEC-A network)
Distortion	0.3% (at 65 dBf, 1 kHz, stereo)
Frequency response	30 – 15,000 Hz (±3 dB)
Stereo separation	40 dB (at 65 dBf, 1 kHz)

### AM tuner

Frequency range	531 – 1,602 kHz (9 kHz) 530 – 1,640 kHz (10 kHz)
Usable sensitivity	18 μV (S/N: 20 dB)
Selectivity	50 dB (±9 kHz) 50 dB (±10 kHz)

#### Note:

- US and foreign patents licensed from Dolby Laboratories.
- Specifications and design are subject to modification without notice for the sake of improvements.











**PIONEER CORPORATION**

4-1, MEGURO 1-CHOME, MEGURO-KU, TOKYO 153-8654, JAPAN

**PIONEER ELECTRONICS (USA) INC.**

P.O. Box 1760, Long Beach, California 90801, U.S.A.  
TEL: (800) 421-1404

**PIONEER EUROPE NV**

Haven 1087, Keetberglaan 1, B-9120 Melsele, Belgium  
TEL: (0) 3/570.05.11

**PIONEER ELECTRONICS AUSTRALIA PTY. LTD.**

178-184 Boundary Road, Braeside, Victoria 3195, Australia  
TEL: (03) 9586-6300

**PIONEER ELECTRONICS OF CANADA, INC.**

300 Allstate Parkway, Markham, Ontario L3R OP2, Canada  
TEL: (905) 479-4411

**PIONEER ELECTRONICS DE MEXICO, S.A. de C.V.**

San Lorenzo 1009 3er. Piso Desp. 302  
Col. Del Valle Mexico, D.F. C.P. 03100  
TEL: 5-688-52-90

Published by Pioneer Corporation.  
Copyright © 2001 by Pioneer Corporation.  
All rights reserved.

Publication de Pioneer Corporation.  
Copyright © 2001 Pioneer Corporation.  
Tous droits de reproduction et de traduction  
réservés.

## Free Manuals Download Website

<http://myh66.com>

<http://usermanuals.us>

<http://www.somanuals.com>

<http://www.4manuals.cc>

<http://www.manual-lib.com>

<http://www.404manual.com>

<http://www.luxmanual.com>

<http://aubethermostatmanual.com>

Golf course search by state

<http://golfingnear.com>

Email search by domain

<http://emailbydomain.com>

Auto manuals search

<http://auto.somanuals.com>

TV manuals search

<http://tv.somanuals.com>