

Pioneer

COMPACT DISC RECORDER

PDR-509

Operating Instructions

IMPORTANT



The lightning flash with arrowhead symbol, within an equilateral triangle, is intended to alert the user to the presence of uninsulated "dangerous voltage" within the product's enclosure that may be of sufficient magnitude to constitute a risk of electric shock to persons.

CAUTION

**RISK OF ELECTRIC SHOCK
DO NOT OPEN**

CAUTION:
TO PREVENT THE RISK OF ELECTRIC SHOCK, DO NOT REMOVE COVER (OR BACK). NO USER-SERVICEABLE PARTS INSIDE. REFER SERVICING TO QUALIFIED SERVICE PERSONNEL.



The exclamation point within an equilateral triangle is intended to alert the user to the presence of important operating and maintenance (servicing) instructions in the literature accompanying the appliance.

IMPORTANT SAFETY INSTRUCTIONS

READ INSTRUCTIONS — All the safety and operating instructions should be read before the product is operated.

RETAIN INSTRUCTIONS — The safety and operating instructions should be retained for future reference.

HEED WARNINGS — All warnings on the product and in the operating instructions should be adhered to.

FOLLOW INSTRUCTIONS — All operating and use instructions should be followed.

CLEANING — Unplug this product from the wall outlet before cleaning. The product should be cleaned only with a polishing cloth or a soft dry cloth. Never clean with furniture wax, benzene, insecticides or other volatile liquids since they may corrode the cabinet.

ATTACHMENTS — Do not use attachments not recommended by the product manufacturer as they may cause hazards.

WATER AND MOISTURE — Do not use this product near water — for example, near a bathtub, wash bowl, kitchen sink, or laundry tub; in a wet basement; or near a swimming pool; and the like.

ACCESSORIES — Do not place this product on an unstable cart, stand, tripod, bracket, or table. The product may fall, causing serious injury to a child or adult, and serious damage to the product. Use only with a cart, stand, tripod, bracket, or table recommended by the manufacturer, or sold with the product. Any mounting of the product should follow the manufacturer's instructions, and should use a mounting accessory recommended by the manufacturer.

CART — A product and cart combination should be moved with care. Quick stops, excessive force, and uneven surfaces may cause the product and cart combination to overturn.



VENTILATION — Slots and openings in the cabinet are provided for ventilation and to ensure reliable operation of the product and to protect it from overheating, and these openings must not be blocked or covered. The openings should never be blocked or covered by placing the product on a bed, sofa, rug, or other similar surface. This product should not be placed in a built-in installation such as a bookcase or rack unless proper ventilation is provided or the manufacturer's instructions have been adhered to.

POWER SOURCES — This product should be operated only from the type of power source indicated on the marking label. If you are not sure of the type of power supply to your home, consult your product dealer or local power company.

LOCATION — The appliance should be installed in a stable location.

NONUSE PERIODS — The power cord of the appliance should be unplugged from the outlet when left unused for a long period of time.

GROUNDING OR POLARIZATION

- If this product is equipped with a polarized alternating current line plug (a plug having one blade wider than the other), it will fit into the outlet only one way. This is a safety feature. If you are unable to insert the plug fully into the outlet, try reversing the plug. If the plug should still fail to fit, contact your electrician to replace your obsolete outlet. Do not defeat the safety purpose of the polarized plug.

- If this product is equipped with a three-wire grounding type plug, a plug having a third (grounding) pin, it will only fit into a grounding type power outlet. This is a safety feature. If you are unable to insert the plug into the outlet, contact your electrician to replace your obsolete outlet. Do not defeat the safety purpose of the grounding type plug.

POWER-CORD PROTECTION — Power-supply cords should be routed so that they are not likely to be walked on or pinched by items placed upon or against them, paying particular attention to cords at plugs, convenience receptacles, and the point where they exit from the product.

OUTDOOR ANTENNA GROUNDING — If an outside antenna or cable system is connected to the product, be sure the antenna or cable system is grounded so as to provide some protection against voltage surges and built-up static charges. Article 810 of the National Electrical Code, ANSI/NFPA 70, provides information with regard to proper grounding of the mast and supporting structure, grounding of the lead-in wire to an antenna discharge unit, size of grounding conductors, location of antenna-discharge unit, connection to grounding electrodes, and requirements for the grounding electrode. See Figure A.

LIGHTNING — For added protection for this product during a lightning storm, or when it is left unattended and unused for long periods of time, unplug it from the wall outlet and disconnect the antenna or cable system. This will prevent damage to the product due to lightning and power-line surges.

POWER LINES — An outside antenna system should not be located in the vicinity of overhead power lines or other electric light or power circuits, or where it can fall into such power lines or circuits. When installing an outside antenna system, extreme care should be taken to keep from touching such power lines or circuits as contact with them might be fatal.

OVERLOADING — Do not overload wall outlets, extension cords, or integral convenience receptacles as this can result in a risk of fire or electric shock.

OBJECT AND LIQUID ENTRY — Never push objects of any kind into this product through openings as they may touch dangerous voltage points or short-out parts that could result in a fire or electric shock. Never spill liquid of any kind on the product.

SERVICING — Do not attempt to service this product yourself as opening or removing covers may expose you to dangerous voltage or other hazards. Refer all servicing to qualified service personnel.

DAMAGE REQUIRING SERVICE — Unplug this product from the wall outlet and refer servicing to qualified service personnel under the following conditions:

- When the power-supply cord or plug is damaged.
- If liquid has been spilled, or objects have fallen into the product.
- If the product has been exposed to rain or water.
- If the product does not operate normally by following the operating instructions. Adjust only those controls that are covered by the operating instructions as an improper adjustment of other controls may result in damage and will often require extensive work by a qualified technician to restore the product to its normal operation.

- If the product has been dropped or damaged in any way.
- When the product exhibits a distinct change in performance — this indicates a need for service.

REPLACEMENT PARTS — When replacement parts are required, be sure the service technician has used replacement parts specified by the manufacturer or have the same characteristics as the original part. Unauthorized substitutions may result in fire, electric shock, or other hazards.

SAFETY CHECK — Upon completion of any service or repairs to this product, ask the service technician to perform safety checks to determine that the product is in proper operating condition.

WALL OR CEILING MOUNTING — The product should not be mounted to a wall or ceiling.

HEAT — The product should be situated away from heat sources such as radiators, heat registers, stoves, or other products (including amplifiers) that produce heat.

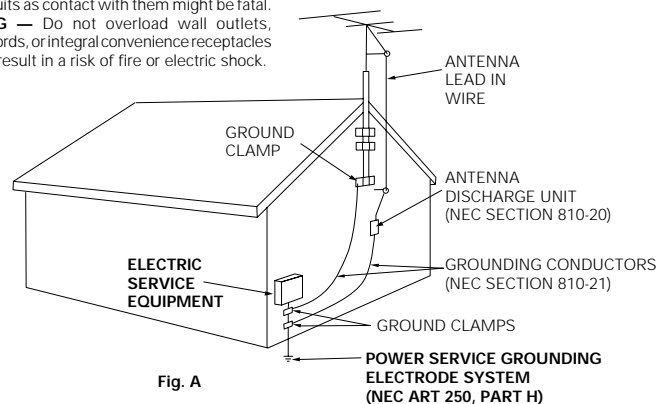

Fig. A

NEC — NATIONAL ELECTRICAL CODE

WARNING: TO PREVENT FIRE OR SHOCK HAZARD, DO NOT EXPOSE THIS APPLIANCE TO RAIN OR MOISTURE.

IMPORTANT NOTICE [For U.S. model]

The serial number for this equipment is located on the rear panel. Please write this serial number on your enclosed warranty card and keep it in a secure area. This is for your security.

[For Canadian model]

This Class B digital apparatus complies with Canadian ICES-003.

[Pour le modèle Canadien]

Cet appareil numérique de la classe B est conforme à la norme NMB-003 du Canada.

[For Canadian model]

CAUTION: TO PREVENT ELECTRIC SHOCK DO NOT USE THIS (POLARIZED) PLUG WITH AN EXTENSION CORD, RECEPTACLE OR OTHER OUTLET UNLESS THE BLADES CAN BE FULLY INSERTED TO PREVENT BLADE EXPOSURE.

ATTENTION: POUR PREVENIR LES CHOCS ELECTRIQUES NE PAS UTILISER CETTE FICHE POLARISEE AVEC UN PROLONGATEUR, UNE PRISE DE COURANT OU UNE AUTRE SORTIE DE COURANT, SAUF SI LES LAMES PEUVENT ETRE INSEREES A FOND SANS EN LAISSER AUCUNE PARTIE A DECOUVERT.

[For U.S. model]

**DANGER – LASER RADIATION WHEN OPEN.
AVOID DIRECT EXPOSURE TO BEAM.**

This caution can be found on the rear panel of the unit.

CAUTION:

- Use of controls or adjustments or performance of procedures other than those specified herein hazardous radiation exposure.
- The use of optical instruments with this product will increase eye hazard.

This equipment has been tested and found to comply with the limits for a Class B digital device, pursuant to Part 15 of the FCC Rules. These limits are designed to provide reasonable protection against harmful interference in a residential installation. This equipment generates, uses, and can radiate radio frequency energy and, if not installed and used in accordance with the instructions, may cause harmful interference to radio communications. However, there is no guarantee that interference will not occur in a particular installation. If this equipment does cause harmful interference to radio or television reception, which can be determined by turning the equipment off and on, the user is encouraged to try to correct the interference by one or more of the following measures:

- Reorient or relocate the receiving antenna.
- Increase the separation between the equipment and receiver.
- Connect the equipment into an outlet on a circuit different from that to which the receiver is connected.
- Consult the dealer or an experienced radio/TV technician for help.

CAUTION:

This product satisfies FCC regulations when shielded cables and connectors are used to connect the unit to other equipment. To prevent electromagnetic interference with electric appliances such as radios and televisions, use shielded cables and connectors for connections.

Information to User

Alteration or modifications carried out without appropriate authorization may invalidate the user's right to operate the equipment.

IMPORTANT

FOR USE IN THE UNITED KINGDOM

The wires in this mains lead are coloured in accordance with the following code:

Blue : Neutral
Brown : Live

If the plug provided is unsuitable for your socket outlets, the plug must be cut off and a suitable plug fitted.

The cutoff plug should be disposed of and must not be inserted into any 13

amp socket as this can result in electric shock. The plug or adaptor of the distribution panel should be provided with a 5 amp fuse. As the colours of the wires in the mains lead of this appliance may not correspond with coloured markings identifying the terminals in your plug, proceed as follows:

The wire which is coloured blue must be connected to the terminal which is marked with the letter N or coloured black.

The wire which is coloured brown must be connected to the terminal which is marked with the letter L or

coloured red.

Do not connect either wire to the earth terminal of a three-pin plug.

NOTE

After replacing or changing a fuse, the fuse cover in the plug must be replaced with a fuse cover which corresponds to the colour of the insert in the base of the plug or the word that is embossed on the base of the plug, and the appliance must not be used without a fuse cover. If lost, replacement fuse covers can be obtained from your dealer.

Only 5 A fuses approved by B.S.I. or A.S.T.A. to B.S. 1362 should be used.

This product complies with the Low Voltage Directive (73/23/EEC), EMC Directives (89/336/EEC, 92/31/EEC) and CE Marking Directive (93/68/EEC).

INFRINGEMENT OF COPYRIGHT [For U.K. model]

Recording and playback of copyrighted material may require consent. See the Copyright Design and Patent Act 1988.

[For U.K. model]

Location: Rear of the unit.

CAUTION

This product contains a laser diode of higher class than 1. To ensure continued safety, do not remove any covers or attempt to gain access to the inside of the product.

Refer all servicing to qualified personnel.

The following caution label appears on your unit.



**CLASS 1
LASER PRODUCT**

Before You Start

Features of the PDR-509 CD Recorder

Create your own audio CDs

At last, there's a convenient and affordable way to make your own audio CDs. Create your own original recordings, or put together compilations of favorite tracks from your existing CDs. You might also want to put your vinyl collection on to CD to take advantage of the superior portability, convenience and durability of CDs over vinyl records. Other uses include making high-quality recordings from radio or satellite broadcasts, and making personal copies of CDs, MDS, etc. to leave in the car, keeping the originals safe at home.

Make digital recordings from any source

The PDR-509 can accept digital input via optical or coaxial cable, meaning that you can connect it to almost any other digital audio component. Also, thanks to the built in sampling rate converter, you can make direct digital recordings from satellite (usually 32kHz), DCC and DAT (up to 48kHz), as well as CD and MD (both 44.1kHz). A sampling rate converter 'through' feature (for 44.1kHz sources only) enables you to record HDCD and DTS encoded CDs, too.

Analog sources are also provided for with the analog line inputs, suitable for connection to standard audio components such as cassette decks and turntables. High-quality analog-to-digital conversion, paired with CD's excellent dynamic range and broad frequency capabilities, results in recordings that are virtually indistinguishable from the original.

Use both ordinary recordable CDs and rewritable CDs

Ordinary recordable CDs (CD-R) can be recorded on just once, but the relatively cheap cost of blank discs and the ability to play the recorded discs on any ordinary CD player* make them ideal for many applications. Compact Disc Rewritable, or CD-RW, is a more recent type of recordable CD that allows erasing and re-recording of the disc. Although the blank discs are more expensive, this ability to use the discs over and over gives them the edge in terms of flexibility over CD-R**.

* Before CD-Rs can be played on ordinary CD players, they must be 'finalized' (a process that fixes the contents of the disc so that no further recording is possible). While most CD players should have no problems with CD-R discs, if the laser pickup is dirty (from prolonged exposure to tobacco smoke, for example), the player may not be able to read some CD-R discs.

** At the time of writing, most ordinary CD players cannot play CD-RW discs. Check in the instructions that came with the player for compatibility.

Contents

Before You Start	6
Checking What's in the Box	6
Using This Manual	6
Putting the Batteries in the Remote Control	6
Hints on Installation	7
Maintaining Your CD Recorder	7
About CD, CD-R and CD-RW Discs	8
Connecting Up	10
Connecting Up for Digital Playback & Recording	10
Connecting Up for Analog Playback & Recording	11
What's What	12
Front Panel	12
Remote Control	13
Display	14
Basic Playback and Recording	15
Switching On for the First Time	15
Choosing a Track to Play	16
Skipping Tracks	16
Repeating Tracks	16
Showing Disc Information	17
Introduction to CD Recording	18
Recording One Track from a Digital Source	20
Recording All Tracks from a Digital Source	21
Automatically Recording and Finalizing a Disc	22
Manually Recording a Digital Source	23
Setting the Digital Recording Level	24
Recording an Analog Source	25
Additional Playback Features	26
Programming the Track Order	26
Fading In and Fading Out	27
Playing Tracks at Random	27
Playing a Disc with Skip IDs	27
Additional Recording Features	28
Skipping Unwanted Tracks	28
Numbering Tracks	30
Recording Fade Ins and Fade Outs	30
Checking What's at the End of a Disc	31
Recording Blank Sections	31
Monitoring a Source	32
Checking for Digital Copy Protection	32
Finalizing a Disc	33
Erasing a CD-RW Disc	34
Additional Information	36
Understanding Display Messages	36
Troubleshooting	37
Specifications	39

Checking What's in the Box

Make sure that you've received the following supplied accessories with your PDR-509 CD Recorder:

Two sets of audio cords

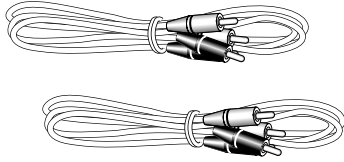

AC power cord

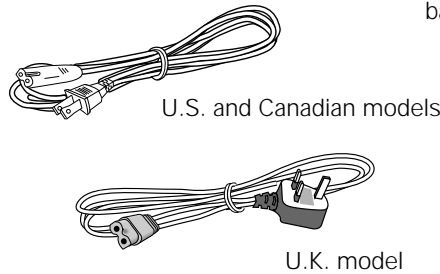

Two 'AA' size R6P batteries



Remote control unit



❖ Also included in the box is your warranty card and this.

Using This Manual

This manual is for the PDR-509 CD Recorder. It is split into two sections: the first shows how to set up the CD recorder; the second takes you through each stage of operation.

Set Up

This section, which starts here, shows you how to get your new CD recorder up and running with the rest of your stereo system, including hints and precautions on installation and connecting it to your amplifier and other components. If this is the first time you've used recordable CDs, we recommend reading the *About CD-R and CD-RW Discs* section starting on page 8 before moving onto the second section of the manual.

Operation

In this section, starting on page 12, you'll learn how to use every feature of the PDR-509, including basic playback and recording using both digital and analog connections, advanced recording features, such as recording fades and creating pauses between tracks, and special CD-RW only operations.

Finally, the *Additional Information* section, starting on page 36, provides reference information on display messages you might encounter during use, a troubleshooting section, and technical specifications.

Putting the Batteries in the Remote Control

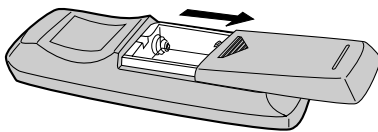

- Turn over the remote control, then press and slide the battery compartment cover off.

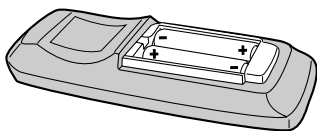

- Put in the batteries supplied, taking care to match the plus and minus ends of each battery with the markings inside the compartment.

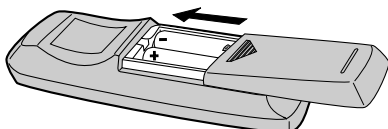

- Slide the cover back on, and your remote is ready for use.

CAUTION!

Incorrect use of batteries can result in hazards such as leakage and bursting. Please observe the following:

- ❖ Don't mix new and old batteries together
- ❖ Don't use different kinds of battery together—although they may look similar, different batteries may have different voltages.
- ❖ Make sure that the plus and minus ends of each battery match the indications in the battery compartment.
- ❖ Remove batteries from equipment that isn't going to be used for a month or more.

Hints on Installation

We want you to enjoy using the PDR-509 for years to come, so please bear in mind the following points when choosing a suitable location for it:

DO...

- ❖ Use in a well-ventilated room.
- ❖ Place on a solid, flat, level surface, such as a table, shelf or stereo rack.

Avoiding condensation problems

Condensation may form inside the player if it is brought into a warm room from outside, or if the temperature of the room rises quickly. Although the condensation won't damage the player, it may temporarily impair its performance. For this reason you should leave it to adjust to the warmer temperature for about an hour before switching on and using.

DON'T...

- ❖ Use in a place exposed to high temperatures or humidity, including near radiators and other heat-generating appliances.
- ❖ Place on a window sill or other place where the player will be exposed to direct sunlight.
- ❖ Use in an excessively dusty or damp environment.
- ❖ Place directly on top of an amplifier, or other component in your stereo system that becomes hot in use.
- ❖ Use near a television or monitor as you may experience interference—especially if the television uses an indoor antenna.
- ❖ Use in a kitchen or other room where the player may be exposed to smoke or steam.
- ❖ Place on an unstable surface, or one that is not large enough to support all four of the unit's feet.

Maintaining Your CD Recorder

Cleaning external surfaces

To clean the compact disc recorder, wipe with a soft, dry cloth. For stubborn dirt, wet a soft cloth with a mild detergent solution made by diluting one part detergent to 5 or 6 parts water, wring well, then wipe off the dirt. Use a dry cloth to wipe the surface dry. Do not use volatile liquids such as benzene and thinner which may damage the surfaces.

Moving the unit

If you need to move the unit, first switch it off and unplug from the wall outlet. **Never lift or move the unit during playback or recording**—the disc rotates at a high speed and may be damaged.

POWER-CORD CAUTION

Handle the power cord by the plug. Do not pull out the plug by tugging the cord and never touch the power cord when your hands are wet as this could cause a short circuit or electric shock. Do not place the unit, a piece of furniture, etc., on the power cord, or pinch the cord. Never make a knot in the cord or tie it with other cords. The power cords should be routed such that they are not likely to be stepped on. A damaged power cord can cause fire or give you an electrical shock. Check the power cord once in a while. When you find it damaged, ask your nearest PIONEER authorized service center or your dealer for a replacement.

CD lens cleaner

The compact disc recorder's pickup lens should not become dirty in normal use, but if for some reason it should malfunction due to dirt or dust, consult your nearest Pioneer authorized service center. Although lens cleaners for compact disc recorders are commercially available, we do not recommend using them since some may damage the lens.

Storing Optical Cable

When storing optical cable, coil loosely as shown below. The cable may be damaged if bent around sharp corners.

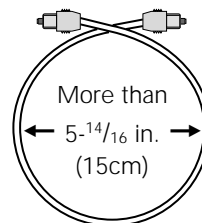

About CD, CD-R and CD-RW Discs

The PDR-509 is compatible with three different types of compact disc:

Playback-only CDs

This unit will playback any ordinary audio CDs carrying the Compact Disc Digital Audio mark shown right.



CD-Recordable discs

Recordable CDs, or CD-R, carry the mark shown right, and are 'write once'. This means that having recorded something on the disc it is permanent—it can't be re-recorded or erased.



CD-Rewritable discs

Rewritable CDs, or CD-RW, carry the mark shown right. As the name indicates, you can erase and re-record material on these discs so that they can be used over and over again.



Consumer-use discs

The PDR-509 is only compatible with special consumer-use CD-R and CD-RW discs. These are clearly marked **For Music Use Only, For Consumer**, or **For Consumer Use**. Other types of CD-R or CD-RW discs, such as those available for computer-based CD recorders, will not work with this recorder.

Pioneer has checked the following branded discs for compatibility with this recorder (as of May 1999):

- Eastman Kodak Company
- FUJI PHOTO FILM CO., LTD.
- Hitachi Maxell, Ltd.
- MITSUI CHEMICALS, INC.
- TDK CORPORATION
- VERBATIM CORPORATION
- PIONEER ELECTRONIC CORPORATION

Sample discs from the following makers have also been checked for compatibility (as of May 1999):

- Mitsubishi Chemical Corporation*
- RICOH COMPANY, LTD.*
- TAIYO YUDEN CO., LTD.*

* At the time of writing, discs branded under these names are not available.

Note: Discs from all of the above makers may also be sold under different brand names.

Recording copyright material

The price of a consumer-use disc includes a copyright fee that has been paid to the copyright owner (in countries where the copyright fee collection system has been established based on their respective copyright laws). This means that you can use these discs to record music and other material for your personal use. If you want to use a disc for anything other than personal use, you must get permission from the copyright owner (note that copyright laws vary from country to country; check the copyright-related laws in your particular country for more information). Broadcast programs, CDs, other recorded media (cassettes, vinyl records, etc.) and musical performances are all protected by copyright laws. You must get permission from the copyright owner if you sell, transfer, distribute or lease a disc recorded from the above mentioned sources, or if you use it as part of a business (such as for background music in a store).

Recording and finalizing discs

Unlike other recording media, recordable CDs have a number of distinct states, and what you can do with a disc depends on the current state of the disc. The figure below shows the three states—blank, partially recorded, and finalized—and summarizes what's possible (✓) and impossible (✗) in each.

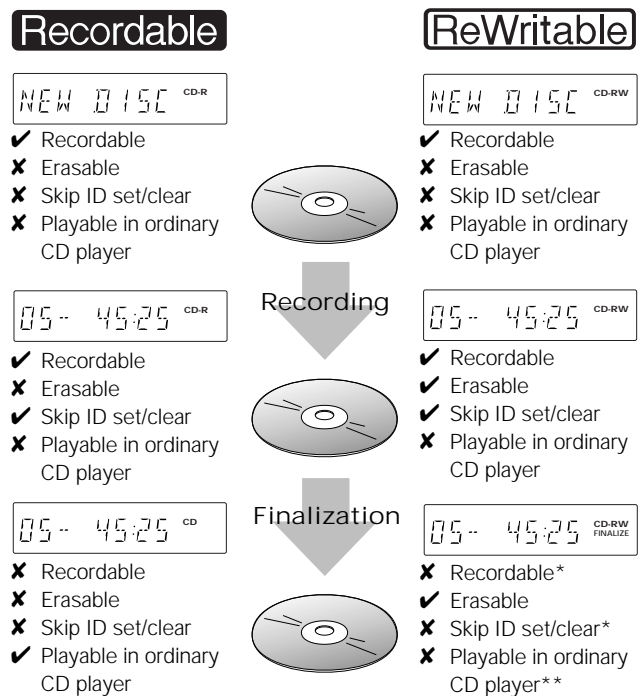

* Once the CD-RW has been erased, it becomes recordable again and skip IDs can be set and cleared.

** In general, current CD players cannot play CD-RW discs. However, this situation may change.

The process of finalization fixes the contents of a CD-R in place for good by creating a Table of Contents (TOC, for short) at the beginning of the disc which tells other players exactly what's on the disc and where to find it. Once a CD-R is finalized, further recording and other changes become impossible. The CD recorder and other CD players treat a finalized disc as an ordinary playback-only CD. (See page 33 for more information on finalizing CD-recordable discs.)

CD-rewritable discs can be finalized in the same way as CD-R discs, but even after finalization, the disc can still be erased and used over again. Remember that CD-RW discs can only be played on players that are specifically designed to play CD-RW discs: most home CD players will not play these discs, even after the disc has been finalized. (See page 33 for more information on finalizing CD-rewritable discs.)

Handling discs

When holding CDs of any type, take care not to leave fingerprints, dirt or scratches on the disc surface. Hold the disc by its edge or by the center hole and edge. Damaged or dirty discs can affect playback and/or recording performance. Take care also not to scratch the label side of the disc. Although not as fragile as the recording side, scratches can still result in a disc becoming unusable.

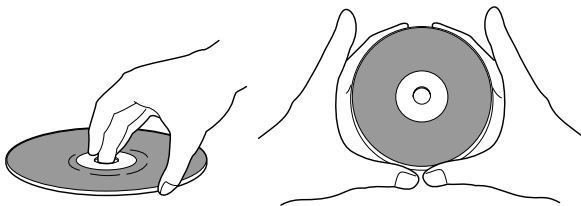

Should a disc become marked with fingerprints, dust, etc., clean using a soft, dry cloth, wiping the disc lightly from the center to the outside edge as shown in the diagram below. If necessary, use a cloth soaked in alcohol, or a commercially available CD cleaning kit to clean a disc more thoroughly. Never use benzine, thinner or other cleaning agents, including products designed for cleaning vinyl records.

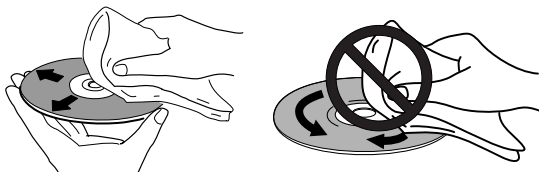

Wipe lightly from the center of the disc using straight strokes.

Don't wipe the disc surface using circular strokes.

Storing discs

Although CD, CD-R and CD-RW discs are more durable than vinyl records, you should still take care to handle and store discs correctly. When you're not using a disc, return it to its case and store upright. Avoid leaving discs in excessively cold, humid, or hot environments (including under direct sunlight).

When labeling discs, use a felt-tip pen sold for marking CDs. Don't glue paper or put stickers onto the disc, or use a pencil, ball-point pen or other sharp-tipped writing instrument. These could all damage the disc.

For more detailed care information see the instructions that come with discs.

Discs to avoid

CDs spin at high speed inside the player during playback and recording. If you can see that a disc is cracked, chipped, warped, or otherwise damaged, don't risk using it in your CD recorder or player—you could end up damaging the unit.

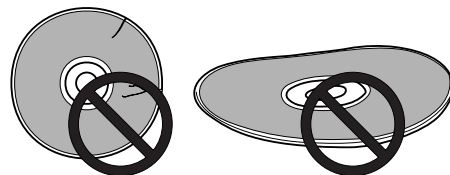

The PDR-509 is designed for use with conventional, fully circular CD's only. Use of shaped CD's is not recommended for this product. Pioneer disclaims all liability arising in connection with the use of shaped CD's.

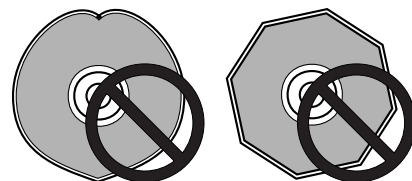

Connecting Up for Digital Playback & Recording

The diagrams on this and the following page show possible connections with various other components in your system. Before you start connecting your system, make sure that all the components are switched off and disconnected from the wall outlet.

About optical and coaxial jacks

The PDR-509 has both optical and coaxial jacks for both digital input and output. This is for convenience only; there's no need to connect both, but since some equipment has only one type of connector—and you can only connect like with like—having both on this unit can be an advantage. If your other component(s) also have both, connect whichever is more convenient.

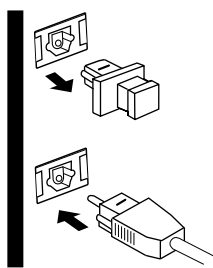

To use the optical jack, you'll need an optical cable. These are readily available at audio dealers. When buying, check that the cable is no longer than 10ft. (3m).

Pull out the dust cap and store it in a safe place for future use. Check that both optical plug and socket are free from dust—if necessary, clean with a

soft, dry cloth. The optical lead will only go in one way, so

match up the jack and the plug before inserting fully. When connecting optical leads, take care not to bend the cable around sharp corners as this can damage the cable. Likewise, when storing optical cable, coil loosely.

If you're using one of the coaxial-type digital connectors you'll need a lead with an RCA/phono plug at each end (the same type of connector as the audio cables supplied). Push the plug home in the socket.

Using the digital inputs

To make direct digital recordings on the PDR-509 you'll need to connect the digital output of a source (like a CD, MD or DAT player) to one of the digital inputs on this unit. To make recordings from analog sources (like a turntable or cassette deck) it's usually easiest to connect this player to your amplifier/receiver's tape inputs and outputs—see the following page for more on this.

Using the digital outputs

If you have another digital recorder, such as a MD or DAT recorder, you might want to use the PDR-509 as a digital source. In this case, connect one of the digital outputs of the PDR-509 to a similar digital input of your other digital recorder.

PDR-509 CD-Recorder

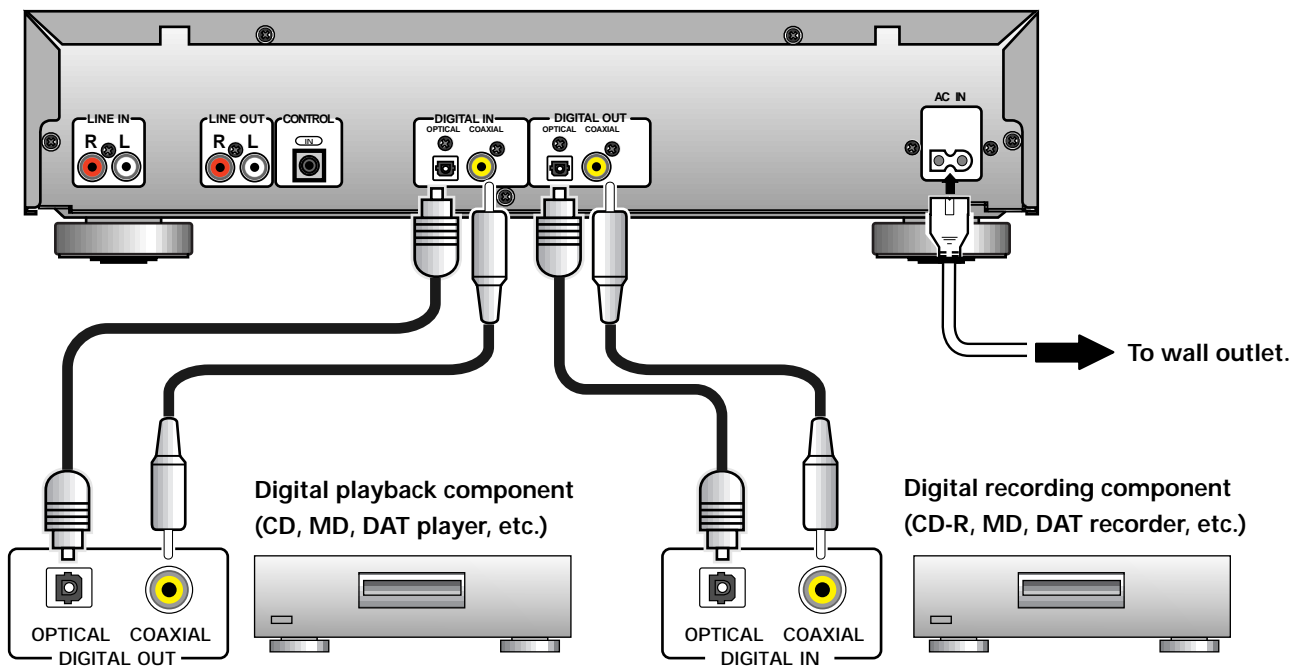

Note: Rear panel show is that of U.S. model; others may look slightly different.

Note: It is not possible to daisy-chain several units together for digital duplication.

Connecting Up for Analog Playback & Recording

Before you start, make sure that all the components are switched off and disconnected from the wall outlet.

Next, connect this unit to your amplifier/receiver using the two sets of supplied audio leads—one set for playback, the other for recording. On the rear panel of your amplifier find an unused set of inputs/outputs for a tape/MD

recorder (check the instruction manual that came with your amplifier if you're unsure about which terminals to use).

Using this set up you can make recordings from any other component connected to the amplifier, via the analog inputs of this unit.

PDR-509 CD-Recorder

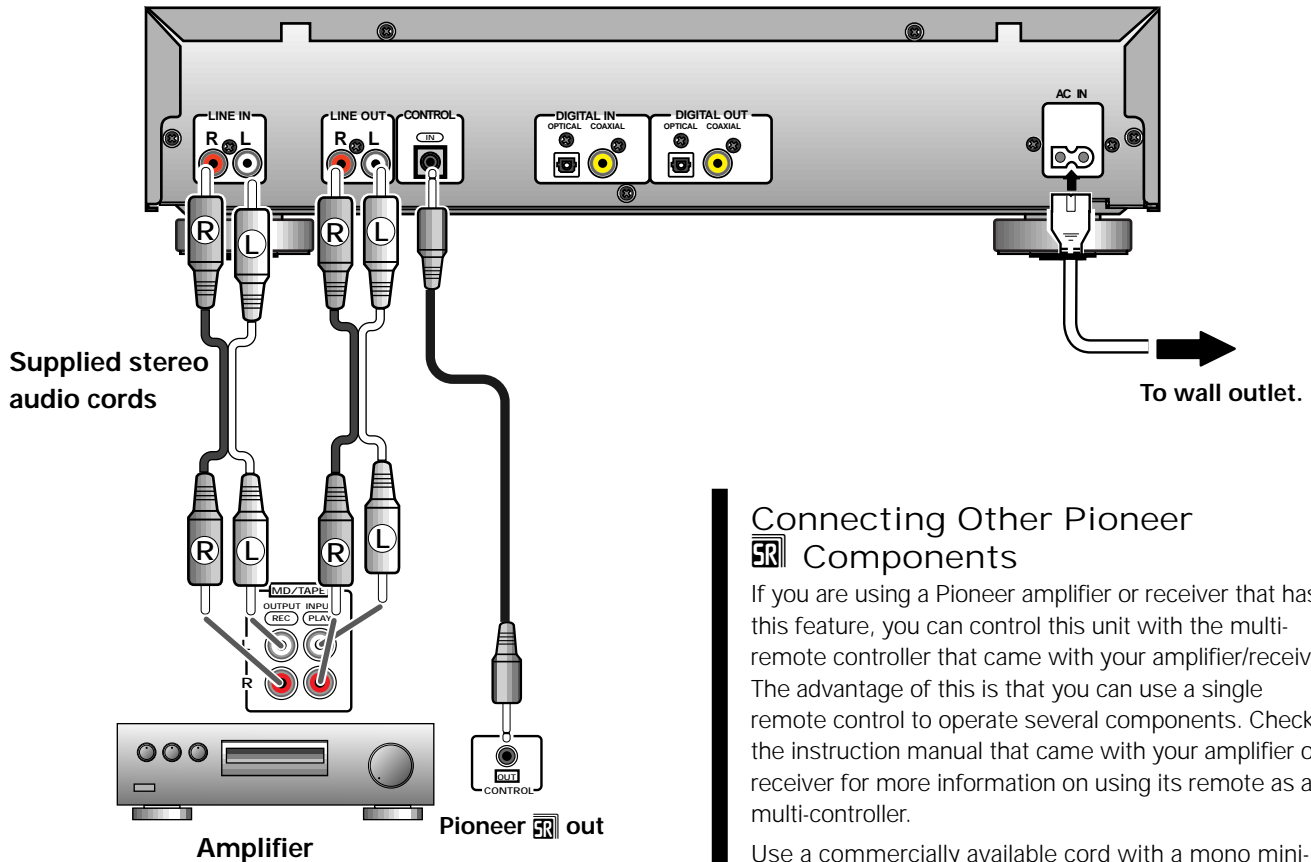

Connecting Other Pioneer SR Components

If you are using a Pioneer amplifier or receiver that has this feature, you can control this unit with the multi-remote controller that came with your amplifier/receiver. The advantage of this is that you can use a single remote control to operate several components. Check the instruction manual that came with your amplifier or receiver for more information on using its remote as a multi-controller.

Use a commercially available cord with a mono mini-plug at either end to connect the **CONTROL OUT** terminal of the amplifier/receiver to the **CONTROL IN** terminal of this unit.

Make sure that at least one set of analog terminals is connected to the amplifier when using SR control cords.

Note: Rear panel show is that of U.S. and Canadian models; others may look slightly different.

Front Panel

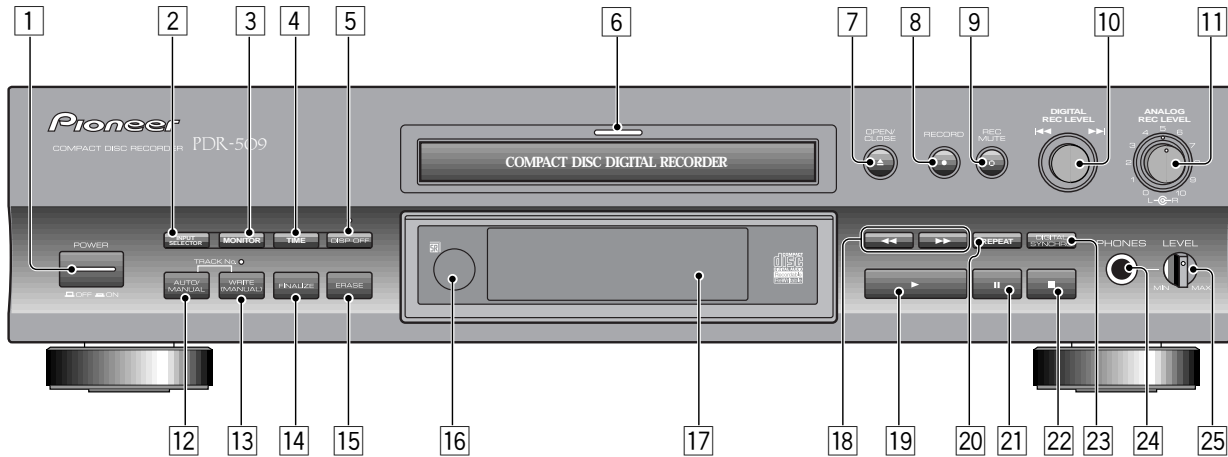

The illustration shows the U.S. and Canadian models.

- 1 POWER switch (p.15)**
Switches power to the unit on and off.
- 2 INPUT SELECTOR (pp.20-25)**
Switches between the analog, optical digital and coaxial digital inputs.
- 3 MONITOR (p.24,25,32)**
Press to monitor the selected input and display digital source information.
- 4 TIME (p.17)**
Switches the display mode (elapsed track time, remaining track time, total disc playing time, etc.)
- 5 DISP OFF (p.17)**
Press to switch the character display off. The indicator above the button lights to remind you that the display is switched off.
- 6 Function indicator**
Indicates the current function of the unit:
Lit – recording a CD-R/CD-RW, or erasing a CD-RW disc.
Blinking – record-mute and PMA-record modes.
- 7 OPEN/CLOSE ▲ (p.15)**
Press to open or close the disc tray.
- 8 RECORD ● (pp.23-25)**
Press to enter record-pause mode for setting input levels, etc.
- 9 REC MUTE ○ (p.31)**
Records a blank section on a disc (for space between tracks, etc.)
- 10 DIGITAL REC LEVEL / ◀◀ ▶▶**
Turn the jog dial to set the digital recording level (p.24) and skip tracks (p.16).
Push the jog dial to: start playback (stop mode only) (p.15); input track number (during programming) (p.26); display the digital recording level (monitor, record, record-pause modes) (p.24).
- 11 ANALOG REC LEVEL (p.25)**
Sets the recording level for analog-input recording. Outside ring controls left input level; inside dial controls right input level.
- 12 TRACK NUMBER AUTO/MANUAL (p.30)**
Switches between automatic and manual track numbering when recording a disc. Indicator lights to remind you when manual track numbering has been turned on.
- 13 TRACK NUMBER WRITE [MANUAL] (p.30)**
Press during recording to start a new track number (when in manual track numbering mode).
- 14 FINALIZE (p.33)**
Press to start the disc finalization process (to make recordable CDs playable on ordinary CD players).
- 15 ERASE (CD-RW discs only) (pp.34-35)**
Press to start erasing tracks, or to re-initialize a disc.
- 16 Remote sensor (p.14)**
- 17 Character display (p.14)**
- 18 ◀◀ and ▶▶ (p.15)**
Press and hold for fast-reverse and fast-forward playback.
- 19 ▶ (p.15)**
Press to play, or resume playing, a disc. Also use to start recording from record-pause mode.
- 20 REPEAT (p.16)**
Use to set the repeat mode (current track, disc, or repeat off).
- 21 || (p.15)**
Press to pause playback or recording.
- 22 ■ (p.15)**
Press to stop playback or recording.
- 23 DIGITAL SYNCHRO (pp.20-22)**
Press to start recording on detection of a digital input signal.
- 24 PHONES jack**
Plug in a pair of stereo headphones for private listening or monitoring.
- 25 LEVEL**
Use to adjust the phones volume level.

Remote Control

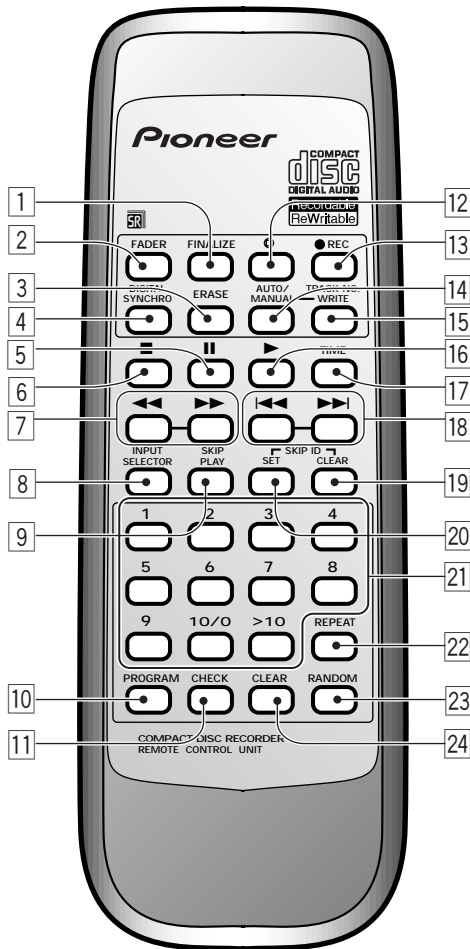

- 1 **FINALIZE (p.33)**
Press to start the disc finalization process (to make recordable CDs playable on ordinary CD players).
- 2 **FADER (p.27, 30)**
Press to fade in or fade out during playback or recording.
- 3 **ERASE (CD-RW discs only) (pp.34–35)**
Press to start erasing tracks, or to re-initialize a disc.
- 4 **DIGITAL SYNCHRO (pp.20–22)**
Press to start recording on detection of a digital input signal.
- 5 **⏸ (p.15)**
Press to pause playback or recording.
- 6 **■ (p.15)**
Press to stop playback or recording.
- 7 **⏮ and ⏭ (p.15)**
Press and hold for fast-reverse and fast-forward playback.
- 8 **INPUT SELECTOR (pp.20-25)**
Switches between the analog, optical digital and coaxial digital inputs.
- 9 **SKIP PLAY (p.27)**
Press to switch skip play on and off. When on, the player will skip tracks that skip IDs have been set for.
- 10 **PROGRAM (p.26)**
Use to program the playback order of tracks on a disc.
- 11 **CHECK (p.26)**
Press repeatedly to step through the programmed tracks in program-play mode.
- 12 **○ REC MUTE (p.31)**
Records a blank section on a disc (for space between tracks, etc.)
- 13 **● REC (pp.23-25)**
Press to enter record-pause mode.
- 14 **TRACK NUMBER AUTO/MANUAL (p.30)**
Switches between automatic and manual track numbering when recording a disc. Front panel indicator lights to remind you when manual track numbering has been turned on.
- 15 **TRACK NUMBER WRITE [MANUAL] (p.30)**
Press during recording to start a new track number (when in manual track numbering mode).
- 16 **▶ (p.15)**
Press to play, or resume playing, a disc. Also use to start recording from record-pause mode.
- 17 **TIME (p.17)**
Switches the display mode (elapsed track time, remaining track time, total disc playing time, etc.)
- 18 **⏮ and ⏭ (p.16)**
Press to skip forward or backward tracks.
- 19 **SKIP ID CLEAR (p.29)**
Clears the above setting.
- 20 **SKIP ID SET (p.28)**
Instructs the player to skip a particular track on playback.
- 21 **Number buttons (p.16,26)**
Use to select track numbers on a disc directly.
- 22 **REPEAT (p.16)**
Use to set the repeat mode (current track, disc, or repeat off).
- 23 **RANDOM (p.27)**
Press to start random playback.
- 24 **CLEAR (p.26)**
Press to clear the last programmed track in program-play mode.

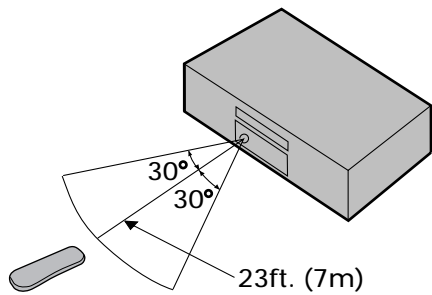

Keep in mind the following when using the remote control unit:

- ❖ Make sure that there are no obstacles in between the remote and the remote sensor on the unit.
- ❖ Use within the operating range and angle, as shown in the diagram left.
- ❖ Remote operation may become unreliable if strong sunlight or fluorescent light is shining on the unit's remote sensor.
- ❖ Remote controllers for different devices can interfere with each other. Avoid using remotes for equipment located near this unit while using the PDR-509.
- ❖ Replace the batteries when you notice a fall off in the operating range of the remote.

Display

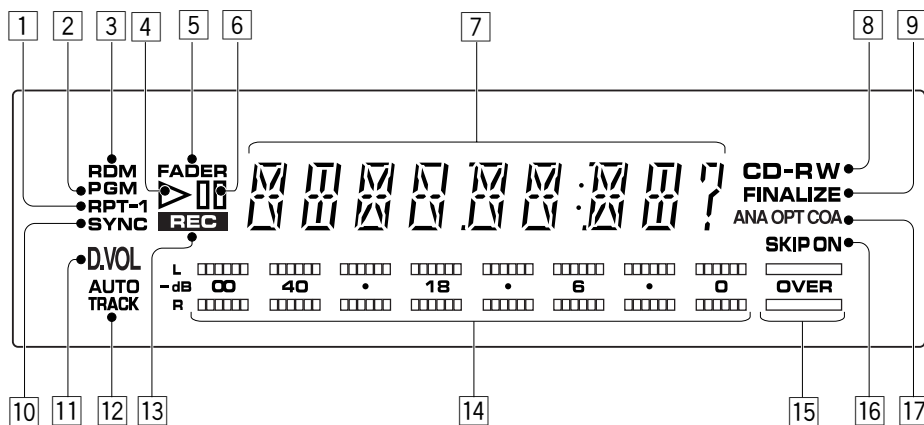

- 1 RPT / RPT-1 (p.16)**
Lights when disc repeat / track repeat mode is on.
- 2 PGM (p.26)**
Lights when program-play mode is active.
- 3 RDM (p.27)**
Lights when random-play mode is active.
- 4 ► (p.15)**
Lights during playback.
- 5 FADER (p.27, 30)**
Blinks during fade in or fade out.
- 6 || (p.15)**
Lights when the recorder is in either play-pause or record-pause mode.
- 7 Message/time display**
- 8 CD / CD-R / CD-RW**
Indicates the type of disc currently loaded.
- 9 FINALIZE (p.33)**
Lights if the CD-RW currently loaded has been finalized. Also blinks during Automatic Finalization Recording (p.22)
- 10 SYNC (pp.20-22)**
Lights when the recorder is in automatic synchro recording mode.
- 11 D.VOL (p.24)**
Lights when the digital volume control function is active.
- 12 AUTO TRACK (p.30)**
Lights when automatic track numbering is on during recording.
- 13 REC (pp.20-23,25,31)**
Lights to indicate recording or record-pause mode. Blinking display indicates record muting.
- 14 Recording level meter (pp.20-25)**
Displays the input level during recording, or the recorded level during playback.
- 15 OVER indicator (p.25)**
Indicates that the input signal overloaded the disc during recording.
- 16 SKIP ON (p.27, 29)**
Lights to indicate that a disc contains skip IDs. When setting or clearing skip IDs, the word **SKIP** blinks.
- 17 ANA (p.25)**
Lights when the analog input is selected.
OPT (pp.20-24)
Lights when the optical digital input is selected.
COA (pp.20-24)
Lights when the coaxial digital input is selected.

Switching On for the First Time

The next few pages take you through switching on the PDR-509, playing discs and using the basic playback controls, as well as basic recording. Before proceeding with this section you should have at least connected your recorder to an amplifier. (If you haven't, turn to pages 10 and 11 for more on connecting the PDR-509 to other components in your system.)

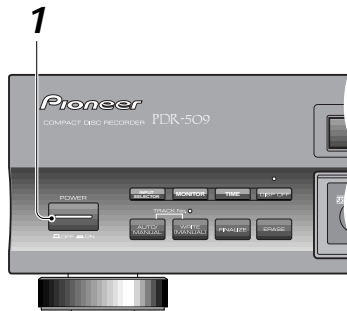

1 Switch the POWER to **ON**.

The function indicator flashes, and the main display panel lights.

- ❖ Also make sure that your amplifier is switched on and the input function set to the PDR-509.

2 Press OPEN/CLOSE **▲** to open the disc tray.

3 Load a pre-recorded audio CD.

Place the disc in the disc tray label-side up.

- ❖ The disc tray has guides for both CD singles (8cm/ 3 inch) and regular CDs (12cm/ 5 inch). Do not use an adaptor when playing CD singles: it could damage the recorder.
- ❖ Never load more than one disc at a time.

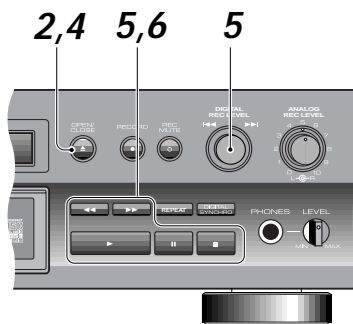
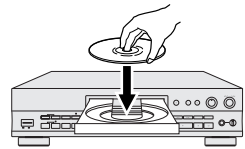

4 Press OPEN/CLOSE **▲** to close the disc tray.

Once the recorder has found out what's on the disc you should see a display that looks something like this:

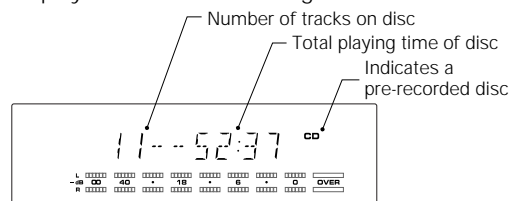

- ❖ Lightly pushing the tray or pressing **▶** (play) will also close the disc tray. (If you press **▶** to close the tray, you won't see the above display.)

5 Press **▶** (play) to start the disc playing.

- ❖ Pressing the jog dial on the front panel also starts playback.
- ❖ To temporarily pause playback, press **||** (pause). To resume playback, press either **||** (pause) again, or **▶** (play). *If the recorder remains paused for 10 minutes, it reverts to stop mode.*
- ❖ Press and hold the **◀◀** (fast reverse) and **▶▶** (fast forward) buttons to search through tracks in either direction at high speed.

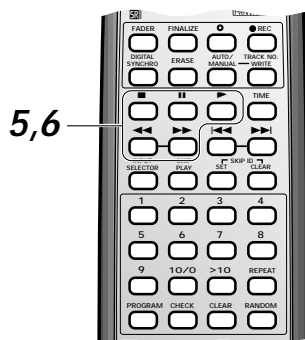

6 When you're done, press **■** (stop).

- ❖ Take out the CD from the disc tray before switching off the unit.

Choosing a Track to Play

Pressing the ► (play) button starts the disc playing from track one. If you want to start from a different track just enter the number of the track using the remote control's number buttons. If you do the same thing during playback, the recorder immediately jumps to that track on the disc.

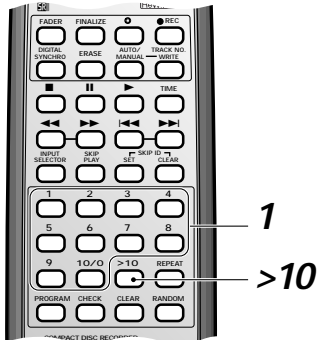

1 While a disc is stopped, paused or playing, enter the track number you want to play.

The recorder jumps directly to that track. If the recorder was in stop mode, the track then starts playing.

- ❖ For track numbers 1 to 10, use the corresponding number button.
- ❖ For track numbers over 10, press the >10 button, then enter the track number. For example, to select track 28:



Skipping Tracks

You can skip forwards or back to the start of other tracks on the disc without having to worry about the track numbers.

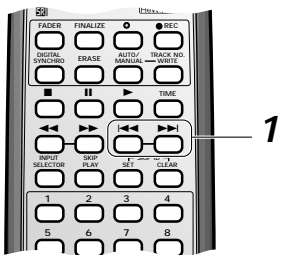

1 Press ◀◀ or ▶▶ on the remote, or turn the jog dial on the recorder to skip a track.

- ❖ If the disc is already playing, skipping forward always takes you to the start of the next track. Skipping backwards takes you first to the beginning of the current track, then to the beginning of previous tracks.
- ❖ If the disc is stopped, pressing the jog dial after skipping tracks starts playback.

When you get to the end or beginning of the disc, the track numbers wrap around as you continue skipping tracks. In other words, skipping forward a track when you're already on the last track takes you back to the first track on the disc.

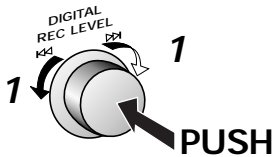

Repeating Tracks

Using the repeat play function you can repeat either the current track over and over, or the entire disc.

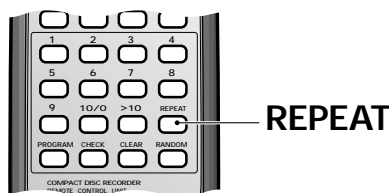

1 To repeat the current track, press REPEAT once.

The RPT-1 indicator lights in the display and the current track repeats until you either press ■ (stop), or press REPEAT twice. Either way, repeat mode is cancelled.

- ❖ You can use repeat track in normal, program or random play modes.

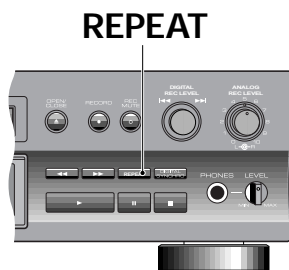

1 To repeat the whole disc, press REPEAT twice.

The RPT indicator lights in the display and the CD repeats until you press either ■ (stop) or REPEAT again (in which case the disc continues playing to the end, then stops).

- ❖ You can use repeat disc in normal, program or random play modes.

Showing Disc Information

The PDR-509 can display various kinds of disc and track information in both playback and recording modes. The **TIME** button switches between the different display modes. Additionally, in stop mode, individual track information is available from the track skip buttons (◀◀ and ▶▶), or by turning the jog dial. Finally, you have the option to switch off the display completely.

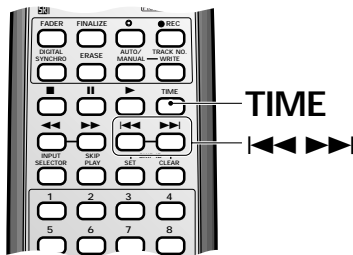

During playback, press **TIME** to switch the display mode.

There are four different displays. Press **TIME** repeatedly to switch between them:

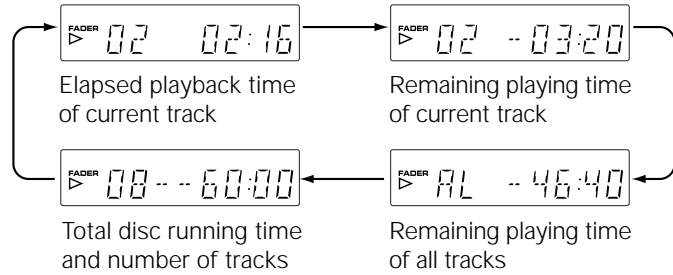

TIME DISP OFF



During recording, press **TIME** to switch the display mode.

There are three different displays. Press **TIME** repeatedly to switch between them:

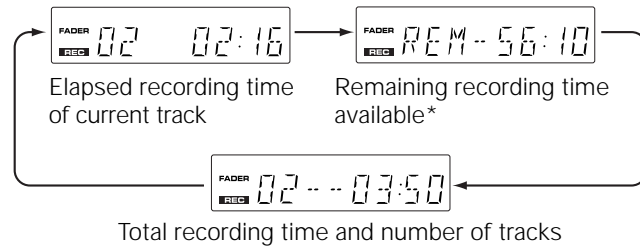

* Although compatible with 80 minute discs, the remaining recording time display will not accurately show 80 minutes for blank discs.

JOG DIAL



In stop mode, press ◀◀ or ▶▶ or turn the jog dial to display individual track length information.

Each press or turn moves forward or back one track on the disc and shows the length of that track.

Press **DISP OFF** to switch between display modes.

Each press switches the display mode as follows:

Level meter only off → display off → normal display

- ❖ In display off mode the indicator above the button lights to remind you that the display is switched off.
- ❖ Pressing the **TIME** button with the display switched off will display disc information for a few seconds.
- ❖ You can't switch the display off during recording, or during record-pause mode.

Introduction to CD Recording

The PDR-509 is designed to let you make extremely high quality digital recordings onto recordable compact discs. For flexibility, you can use either rewritable discs (CD-RW) or write-once discs (CD-R). For more general information on the discs you can and can't use with this recorder, see *About CD, CD-R and CD-RW Discs* on page 8. The overview on this and the following page gives you some idea of what the PDR-509 is capable of, and also provides guidance on what to avoid and things to be careful of when recording. **We strongly recommend that you read these pages fully before proceeding to the more detailed instructions on the following pages.**

Recording modes

The recorder is equipped with a set of analog input terminals, as well as both optical and coaxial digital inputs. This means that the PDR-509 is compatible with almost all audio sources— analog or digital. It even has a built in sampling rate converter making it ideal for recording DAT tapes or satellite broadcasts, for example, which are often at sampling rates different to that of CD. Since CDs are always recorded at a sampling rate of 44.1kHz, sample rate conversion is completely automatic—if the recorder senses a digital signal at either 32 or 48kHz, it will convert it to 44.1kHz. *Note that this recorder can't convert 96kHz digital sources (such as some DAT tapes and DVD discs).*

There are five recording modes available—four for digital-input recording, and one analog-input record mode. The table below provides a brief summary of each.

Digital recording restrictions

This unit has been designed exclusively for recording and playback of audio discs—**you can't record other CD formats, such as computer CD-ROMs or Dolby Digital (AC-3).** If you record from a disc format such as CD+GRAPHICS, VIDEO-CD, or other format that includes both digital audio and video or text, you will only be able to record the audio part of the disc.

In addition to standard audio CDs, this recorder will record DTS encoded audio CDs and HDCD format CDs, however.

Almost all commercial digital source material is protected by copyright laws. For this reason, the PDR-509 uses special consumer-use blank CD-R and CD-RW discs on which a copyright fee has already been paid. A further restriction comes in the form of SCMS (an acronym for Serial Copy Management System). This generally allows just one generation of digital recording. In other words, you can make a digital recording from an original source (such as a commercial CD), but you can't then make further digital recordings from that copy. Most digital recording equipment uses the SCMS system, including CD and MD recorders, and DAT decks. You may also find that you can't record certain DVD discs as the digital output of the DVD player can be disabled by the disc.

Of course, if you do encounter SCMS or other digital-copy restrictions, you can always record through the analog inputs of the PDR-509. To check whether a source is digital-copy protected, see *Checking for Digital Copy Protection* on page 32.

Mode	Description	Uses
Automatic digital-input 1-track synchro recording	Recording starts after the recorder senses an input signal. Once the track has finished, the recorder stops recording	Good for recording edited versions of CDs, MDS, DATS or DCC tapes. Full instructions on page 20.
Automatic digital-input all-track synchro recording	Recording starts after the recorder senses an input signal, and continues until all tracks on the source have finished. The recorder then stops automatically	Good for recording complete CDs, MDS, DATS or DCC tapes. Full instructions on page 21.
Automatic finalization recording	As automatic digital-input all-track synchro recording, above, with automatic finalization of the disc after all tracks have been recorded	Good for recording complete CDs, MDS, DATS or DCC tapes when you don't want to record anything else on the disc afterwards. Full instructions on page 22.
Manual digital-input recording	Recording start and stop is completely under the user's control	Useful for recording digital sources other than CD, MD, DAT or DCC, which may not have track numbers (digital satellite broadcasts, for example). Full instructions on page 23.
Analog-input recording	Records any analog audio source through the analog inputs. Unlike digital-input recording, you must set the recording levels, as you would with analog tape.	As well as analog sources, such as vinyl records, this mode can be used for digital sources that are digital-copy protected. Full instructions on page 25.

Digital recording from DAT

If you're recording a DAT tape that was recorded using the DAT machine's auto ID function, the IDs on the tape are slightly after the beginning of the actual recording. This can cause problems for the CD recorder:

- ❖ The start of the track may not be recorded.
- ❖ The track number will be recorded on the disc after the start of the track
- ❖ The beginning of the next track on the DAT is unintentionally recorded

To avoid these problems, we recommend recording start IDs on the DAT manually, if possible. Refer to the instructions for your DAT recorder for more information.

You might also encounter problems if you try to synchro-record all tracks from a DAT that is set to program play. If you want to record a DAT in program play mode, use the 1-track synchro recording mode—see page 20 for how to do this.

Digital signal interruptions

There are a couple of situations where a signal arriving at the digital input of the recorder might be interrupted. The first is if the sampling rate of the signal suddenly changes. This is most likely when recording from DAT, which can record at a number of different sampling rates. If one track on the DAT is recorded at, say, 44.1kHz, but the next at 48kHz, this will cause an interruption of the recording on the PDR-509 while it adjusts to the new sampling rate. During this time, a short blank section will be recorded on the disc.

Other sources of signal interruption include power or source component failure, accidental disconnection of the interconnect cord, and interruption of digital satellite broadcasts. In all these cases, if the signal resumes within about five seconds, the result will just be a blank section on the disc. If the interruption is longer than five seconds, the recorder displays the error message: **CAN NOT REC** and recording is paused.





Power interruptions

Never switch off the PDR-509 while it's recording, or while the display shows **PMA REC** (Program Memory Area Recording). If there's a power failure, or you accidentally disconnect the power from the wall outlet while recording is in process, you'll lose at least part of the recording. When power is restored, the recorder will show the message **RESUME** until it's finished recording the PMA.

After recording, always remove the disc from the recorder before switching the power off. Failure to do this could result in you losing some of the recorded material on the disc.

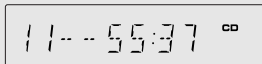
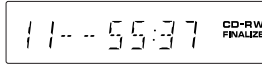
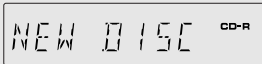
Disc type display

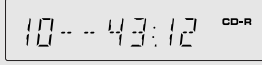
When you load a disc, the first thing the recorder does is to ascertain what kind of disc it is, what (if anything) is recorded on the disc, and whether or not it's been finalized. Once it's done this, the display changes to one of those shown in the table below. If the disc is a CD-R or CD-RW, the recorder makes a series of automatic adjustments to ensure the best quality recording. These adjustments take a little longer if the unit is cold or has just been switched on.

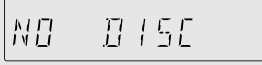
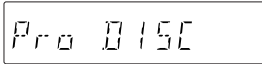
	A pre-recorded CD or finalized CD-R, with 11 tracks and a running time of 55 min. 37 sec.
	A finalized CD-RW with 11 tracks and a running time of 55 min. 37 sec.
	Display for a blank consumer-use CD-R disc.
	Display for a blank consumer-use CD-RW disc.
	A partially recorded CD-R with 10 tracks and a total recorded time of 43 min. 12 sec.
	A partially recorded CD-RW with 10 tracks and a total recorded time of 43 min. 12 sec.
	The disc is not recognized by the recorder, or you pressed ► (play) without a disc loaded.
	The disc is a professional-use CD-R or CD-RW disc and cannot be used with this recorder.

Miscellaneous information

- ❖ The minimum recordable time is four seconds. Even if you try and record something shorter than this, the track that the recorder creates will be four seconds.
- ❖ Usually, track numbers are recorded onto the disc automatically when recording. If you decide to switch off this feature (for example, when you're recording from a satellite broadcast), be sure to input track markers as recording is taking place—you can't add them after recording is complete. See page 30 for more on manual and automatic track numbering.
- ❖ The maximum number of tracks on a disc is 99.

Recording One Track from a Digital Source

If you want to record just a single track, or a few selected tracks, from a CD, MD, DCC or DAT, this mode is ideal. The recorder starts and stops automatically, and there's no need to worry about recording levels—you'll get a perfect digital copy of the original (if you want to change the digital recording level, see page 24). Before you start, make sure that your digital source is properly connected to one of the recorder's digital inputs—see *Connecting Up for Digital Playback & Recording* on page 10 for more on this.

If you're recording all the tracks on the source, see *Recording All Tracks from a Digital Source* on the next page. If you're recording from some other digital source, turn to *Manually Recording a Digital Source* on page 23. If you're recording from any source through the analog inputs, see *Recording an Analog Source* on page 25.

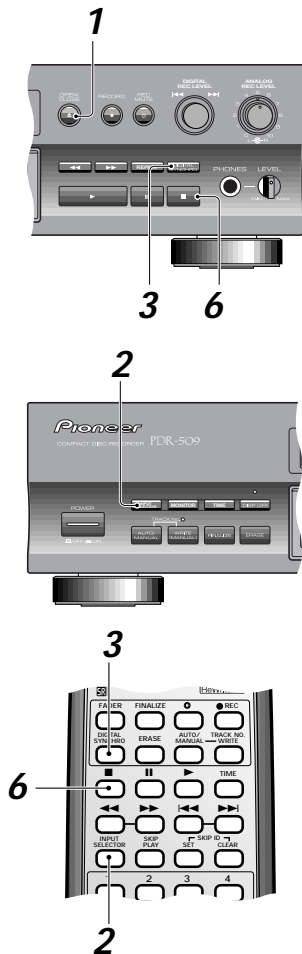

1 Load a CD-R or CD-RW disc.
Check the display to make sure that there's enough space on the disc for what you want to record.

2 Press INPUT SELECTOR to choose one of the digital inputs.
Pressing **INPUT SELECTOR** repeatedly switches the active input:
ANA (Analog) - OPT (Optical) - COA (Coaxial)
The recorder's display indicates the current input.

3 Make sure that the source is not playing, then press DIGITAL SYNCHRO.
Digital synchro recording will not work if the source is already playing!
The **SYNC** indicator will start to blink when the recorder is ready.

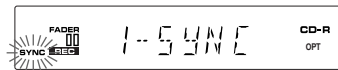

The display shows the 1-track sync mode, with the sync indicator blinking to show that recording can start.

4 Play the source.
The recorder starts recording automatically.

5 The recorder enters record-pause mode after recording one track.

- ❖ If you're recording a CD or MD, recording stops automatically when the track changes or there is more than five seconds of silence on the source.
- ❖ If you're recording from DCC or DAT tape, recording stops when the recorder encounters a new start ID or there is more than five seconds of silence on the source. (See also *Notes on Digital recording from DAT* on page 19.)

6 If you're done, press ■ (stop).
To record further tracks, simply repeat steps 3 to 5.

- ❖ After pressing **■** (stop), the display shows **PMA REC** while it records the track information to the disc.

Press **DIGITAL SYNCHRO** repeatedly to change the recording mode:

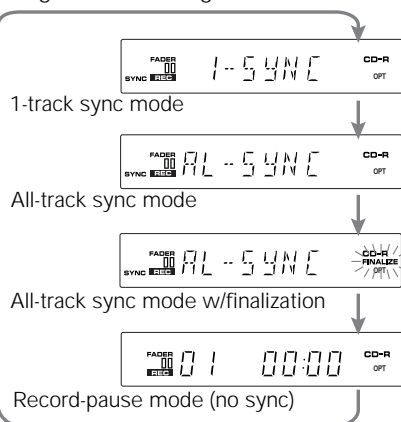

Note: If you find that synchro recording does not seem to work, see the troubleshooting section on page 37 for possible remedies.

Recording All Tracks from a Digital Source

If you want to copy all the tracks from a CD, MD, DCC or DAT, use this mode. Like the 1-track synchro recording mode, the recorder starts and stops automatically. When recording from MD or CD, you can play the source in either normal play mode, or program play if you'd like the recorded tracks in a different order to the original. We do not recommend recording from a DAT in program play mode—use the 1-track synchro recording mode if you want to record the tracks in a different order.

If you are simply duplicating a source disc or tape, you'll probably want to finalize the CD-R (or CD-RW) after all-track sync recording so that it's ready to be played on other CD players. To finalize the disc automatically once recording has finished, see *Automatically Recording and Finalizing a Disc* on the following page. If you're recording from a digital source other than CD, MD, DCC or DAT, see *Manually Recording a Digital Source* on page 23. If you're recording from any source through the analog inputs, see *Recording an Analog Source* on page 25.

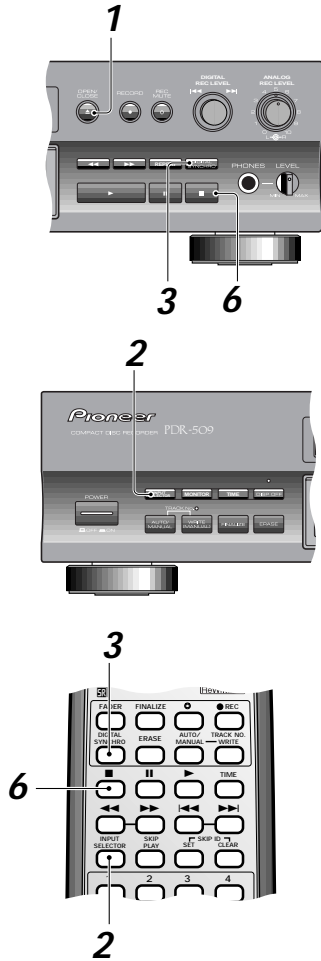

1

Load a CD-R or CD-RW disc.

Check the display to make sure that there's enough space on the disc for what you want to record.

2

Press INPUT SELECTOR to choose one of the digital inputs.

Pressing **INPUT SELECTOR** repeatedly switches the active input:

ANA (Analog) - OPT (Optical) - COA (Coaxial)

The recorder's display indicates the current input.

3

Make sure that the source is not playing, then press DIGITAL SYNCHRO twice.

Digital synchro recording won't work if the source is already playing!

The recorder goes into all-sync record pause mode and the **SYNC** indicator starts to blink.

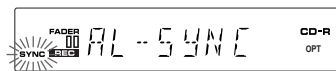

The display shows the all-track sync mode, with the sync indicator blinking to show that recording can start.

4

Play the source.

The recorder starts recording automatically.

5

After recording all tracks from the source, the recorder goes into all-sync record-pause mode.

After the recorder encounters about five seconds of continuous silence, it assumes the end of the source has been reached and goes into record-pause mode and the display shows the **AL-SYNC** message again.

Be careful: if the recorder detects another signal (CD or MD) or start ID (DAT or DCC) it will start recording again!

❖ The recorder will enter record-pause mode if the digital signal is interrupted for more than 5 seconds—see *Digital signal interruptions* on page 19.

6

Press ■ (stop) to finish recording.

❖ After pressing **■** (stop), the display shows **PMA REC** while it records the track information to the disc.

Press **DIGITAL SYNCHRO** repeatedly to change the recording mode:

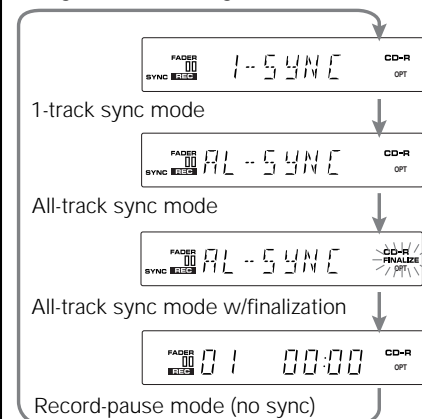

Note: If you find that synchro recording does not seem to work, see the troubleshooting section on page 37 for possible remedies.

Automatically Recording and Finalizing a Disc

This is a variation on all-track synchro recording on the previous page. After all tracks on the source material has been recorded, the recorder automatically finalizes the disc. If you're recording onto a CD-R, this means that the disc will be playable on an ordinary CD player, but you won't be able to record any further tracks onto the disc. If you're using a CD-RW disc, the disc will be playable on a CD-RW player after finalizing, and you can still erase or record new material on the disc. Like the other synchro modes, you can only use this mode when recording from CD, MD, DCC or DAT. If you're recording from a digital source other than CD, MD, DCC or DAT, see *Manually Recording a Digital Source* on the following page.

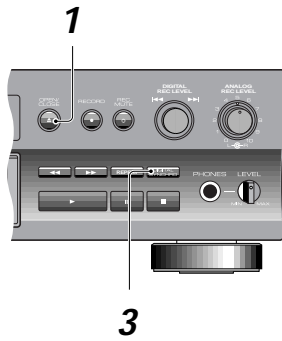

1

Load a CD-R or CD-RW disc.

Check the display to make sure that there's enough space on the disc for what you want to record.

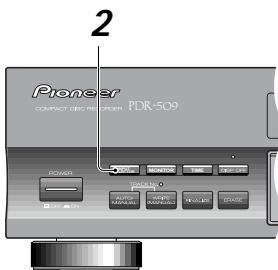

2

Press INPUT SELECTOR to choose one of the digital inputs.

Pressing **INPUT SELECTOR** repeatedly switches the active input:

ANA (Analog) - OPT (Optical) - COA (Coaxial)

The recorder's display indicates the current input.

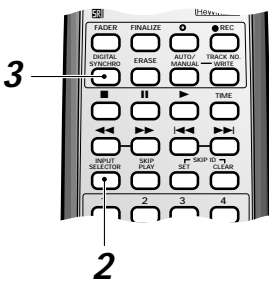

3

Make sure that the source is not playing, then press DIGITAL SYNCHRO three times.

Digital synchro recording won't work if the source is already playing!

The recorder goes into all-synch record pause mode and the **SYNC** indicator starts to blink.

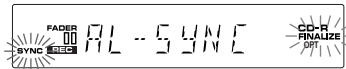

The display shows the all-track sync mode w/finalization, with the sync indicator blinking to show that recording can start.

4

Play the source.

The recorder starts recording automatically.

5

After recording all tracks on the source, the recorder starts finalizing the disc.

After the recorder encounters about five seconds of continuous silence, it assumes the end of the source has been reached and goes into all-synch record-pause mode.

If the recorder detects no signal for one minute, finalization starts (no more recording is possible after this so make sure that there aren't any spaces of more than one minute during the source you're recording).

Be careful: if the recorder detects another signal (CD or MD) or start ID (DAT or DCC) it will start recording again!

Finalization takes about four minutes, during which time none of the buttons are operative. **Never turn the power off during finalization!**

- ❖ If the digital signal is interrupted, the recorder continues recording. However, if no signal has been detected within five seconds, the recorder stops recording and will not finalize the disc—see *Digital signal interruptions* on page 19.

- ❖ If the recorder reaches the end of the disc, or if there are more than 99 tracks, the recorder stops recording without finalizing the disc.

Press **DIGITAL SYNCHRO** repeatedly to change the recording mode:

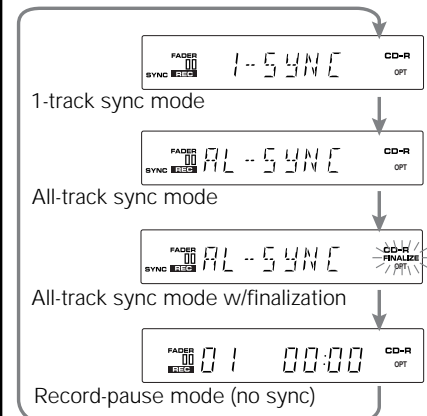

Note: If you find that synchro recording does not seem to work, see the troubleshooting section on page 37 for possible remedies.

Manually Recording a Digital Source

If you are recording from a digital source other than CD, MD, DCC or DAT—digital satellite, for example—synchro recording is not possible since there are no track numbers or start IDs to signal the start and end points of the recording. For these sources, use the manual recording method described here.

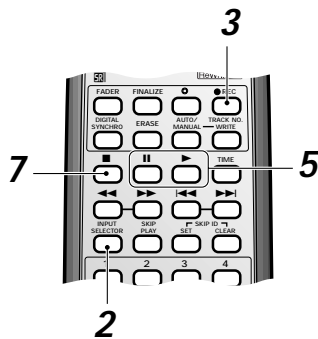
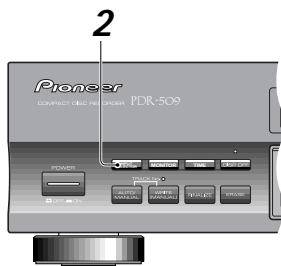
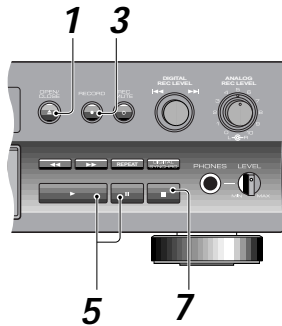

1 Load a CD-R or CD-RW disc.
Check the display to make sure that there's enough space on the disc for what you want to record.

2 Press INPUT SELECTOR to choose one of the digital inputs.

Pressing **INPUT SELECTOR** repeatedly switches the active input:

ANA (Analog) - OPT (Optical) - COA (Coaxial)

The recorder's display indicates the current input.

3 Press RECORD ● (● REC on the remote control).

The recorder goes into record-pause mode.

4 Start playing the source to check it's recordable.

If the recorder does not recognize the digital format, or the source is copy-protected using SCMS, the message **CAN NOT REC** or **CAN NOT COPY** appears. In either case, you won't be able to record digitally—use the analog inputs instead (see *Recording an Analog Source* on page 25).

If necessary, set the recording level (see the following page).

If the signal appears OK, stop the source.

5 Check that the time display reads 00:00, then press || (pause) or ► (play) to start recording.

6 Restart playback of the source material.

If the **AUTO TRACK** indicator is lit in the display then the recorder will start a new track each time it detects a signal after at least two seconds of continuous silence. (To switch off auto track numbering see page 30.)

7 When you're done, press ■ (stop).

❖ After pressing **■ (stop)**, the display shows **PMA REC** while it records the track information to the disc.

Setting the Digital Recording Level

One of the advantages of digital-to-digital recording is that you don't have to set recording levels—and risk distortion by overloading the disc. If you're recording commercial material from CDs or other MDS, the digital level has already been optimized and you don't need to change it. If you're making a digital copy of a CD, DAT or MD that was not commercially produced and that was consistently under-recorded, you can boost the overall level by up to +12dB. Remember though, that any peaks in the original recording run the risk of distorting the copy.

If you record digital satellite broadcasts, you may also have cause to boost the digital recording volume since the digital volume of some broadcasts is relatively low. Again, remember that if there are any peaks in the broadcast, you run the risk of momentary distortion.

It's also possible to reduce the digital recording volume so that you end up with a recording that is quieter than the original. In most cases, this is not desirable since the recording quality will suffer very slightly. However, if you're putting together a mix CD (various tracks compiled from different sources), and there is a track which stands out as generally louder than the others (peak volumes are usually similar, but the average level of some recordings might be higher than others so they sound louder), then you might want to reduce the level of that track.

Note that this feature will not get rid of distortion on the source material.

You can adjust the digital recording volume while the unit is in monitoring mode, record-pause mode or while it is actually recording. Once changed, the new digital recording level remains until you change it again, or reset it. Each digital input has it's own level which can be set independently.

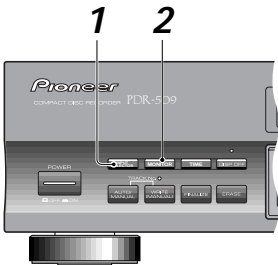

1

Press INPUT SELECTOR to choose one of the digital inputs.

Pressing **INPUT SELECTOR** repeatedly switches the active input:

ANA (Analog) - OPT (Optical) - COA (Coaxial)

The recorder's display indicates the current input.

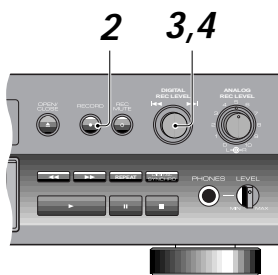

2

If the recorder is stopped, press MONITOR or RECORD ● (● REC on the remote control).

If there is nothing connected to the selected digital input, the message **CAN NOT REC** appears in the display.

3

To display the current digital recording level, press the jog dial (DIGITAL REC LEVEL).

You can display the current digital recording level at anytime in monitor, record-pause, or recording mode. The level is displayed for about four seconds.

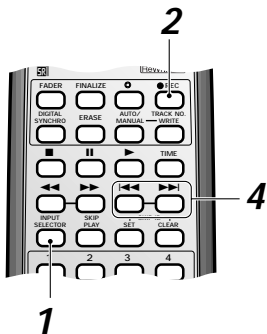

4

Turn the jog dial or press ◀◀ or ▶▶ on the remote control to adjust the recording level up or down.

- ❖ The maximum adjustment possible is between -48dB and +12dB.

- ❖ From +12dB down to -25dB, adjustment is in steps of 1dB. Below this, there are four preset levels: -30dB, -36dB, -42dB and -48dB.

- ❖ If you set the level at anything other than 0dB, the **D.VOL** indicator in the display lights to remind you of the fact.

Digital volume level adjusted down 5 dB.

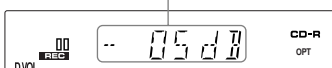

Recording an Analog Source

Recording through the analog inputs follows much the same procedure as recording via a digital input. The only difference is that you have to set the recording level. This determines how loud the recording will be when you play it back (for any given amplifier volume level). If you're used to recording on analog cassette, the idea is exactly the same, but with CD-R you have to be much more careful not to overload the signal. Compared to analog tape, the distortion that you get from overloading a CD is much less tolerable, and something you'll definitely want to avoid. On the other hand, recording the signal very quietly will result in lower sound quality than CD is capable of, so that's not very good either—although it is better to under-record a CD than to over-record it.

What you want to aim for is a level where the loudest sound from your source material is recorded onto the CD at a level just below the point where it overloads (producing an unpleasant, buzzy distortion).

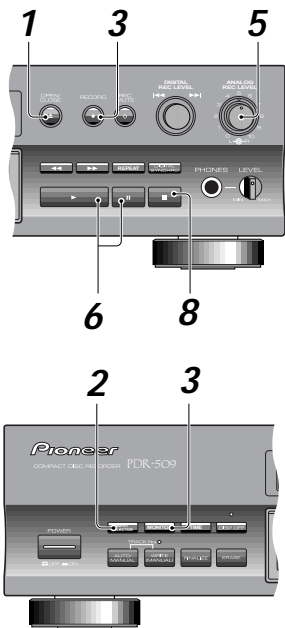

5 The outer ring controls the left record level; the inner dial controls the right. Usually, set both at the same level so that the relative levels match the source.

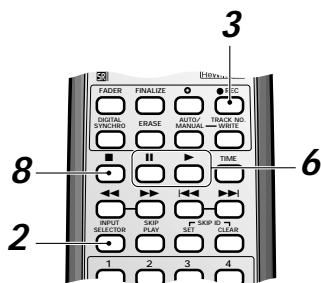

1

Load a CD-R or CD-RW disc.

Check the display to make sure that there's enough space on the disc for what you want to record.

2

Press INPUT SELECTOR to choose analog input.

Pressing INPUT SELECTOR repeatedly switches the active input:

ANA (Analog) - OPT (Optical) - COA (Coaxial)

The display indicates the current input.

3

Make sure the disc is stopped, then press RECORD ● (● REC on the remote control).

The recorder goes into record-pause mode.

You can also press MONITOR.

4

Start playing the source.

5

Adjust the recording level using the REC LEVEL controls.

Don't let the recording level reach the red OVER indicator!

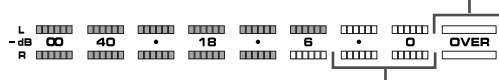

The maximum recording level should be in this area.

When you're happy with the recording level, stop the source material.

6

Check that the time display reads 00:00, then press || (pause) or ► (play) to start recording.

If the recorder was in monitor mode, you'll need to press RECORD ● here, then || (pause) or ► (play) to start recording.

7

Restart playback of the source material.

If the **AUTO TRACK** indicator is lit in the display then the recorder will start a new track each time it detects a signal after at least two seconds of continuous silence. (To switch off auto track numbering see page 30.)

8

When you're done, press ■ (stop).

❖ After pressing ■ (stop), the display shows **PMA REC** while it records the track information to the disc.

Programming the Track Order

Programming the track order means telling the player precisely which tracks, and in what order, you want played. You can program a sequence of up to 24 steps (each step can contain either a track or a pause in the program), playing tracks more than once if you like.

The sequence you program applies only to the disc in the player at the time: as soon as you eject that disc the program memory is lost.

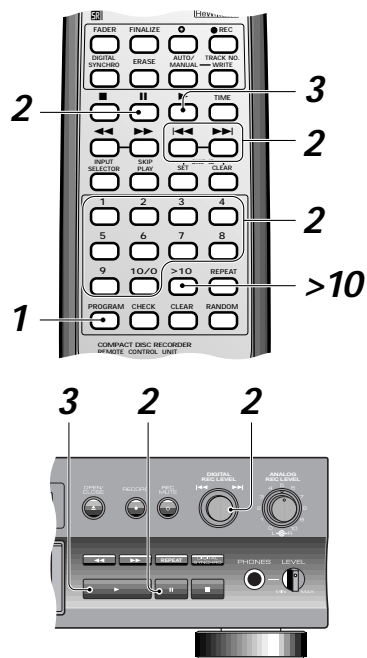

As you program tracks, the total running time of the program is displayed here.

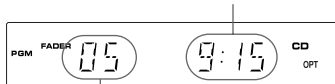

This shows the track number just programmed.

1 During playback or stop mode, press PROGRAM.

The PGM indicator lights and the display prompts you to enter the first track in the program:

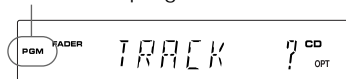

2 Enter the track numbers in the order you want them played.

Use the number buttons to select tracks:

- ❖ For track numbers 1 to 10, use the corresponding number button.
- ❖ For track numbers over 10, press the >10 button, then enter the track number. For example, to select track 28: >10 2 8

If the player is stopped, you can use the ◀◀ and ▶▶ (track skip) buttons to select tracks, pressing PROGRAM after each to enter it into the program. Alternatively, use the jog dial to select tracks (push to enter).

- ❖ **When programming in stop mode only:** To program a pause, press the || (pause) button instead of a track number (you can't program a pause as the first item). Instead of a track number, the display shows PA.

3 Press ▶ (play) to start playback.

- ❖ If you started programming while the disc was playing, the program starts right after the current track has played out. If you want the program to start right away, press ▶ (play).

Clearing a program

Since the program only applies as long as the disc is in the player, you can clear it by simply ejecting the disc. Alternatively, stop the disc, then press ■ (stop) one more time: the program will be erased.

Clearing a track from the program

During playback or while the disc is stopped, you can delete the last (most recently) programmed step by pressing CLEAR on the remote control. Press repeatedly to clear several steps (if the program is playing while you're doing this, you can't clear steps beyond the one that is currently playing).

Checking what's in the program

In stop mode you can check the contents of the program using the CHECK button on the remote control. Each press steps through the program. At each step the display shows the step number and the corresponding track number. When you reach the end of the program, a step number of 00 is displayed.

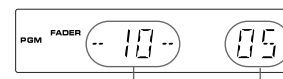

Program step number Programmed track number

Replacing a track in the program

If, while checking the program (see above), you decide you want to change something, simply stop at the step number you want to change and enter a new track number using either the number keys, the ◀◀ and ▶▶ (track skip) buttons, or the jog dial.

Fading In and Fading Out

Pausing a disc during playback cuts the sound off abruptly. You can achieve a softer effect by using the fader feature to fade the track out over a few seconds before pausing. Likewise, when you resume playback, instead of a sudden burst of sound, you can have the player fade in the volume gradually. Note that the fader is available only from the remote control, and that you can only hear the fades through the analog outputs, so if your player is connected to the amplifier via a digital out, you won't hear the fades.

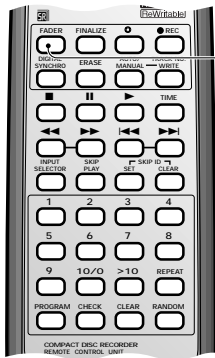

FADER

Press FADER during playback to pause the disc.

The fader indicator in the display blinks and the volume fades to zero over about five seconds. The player then pauses playback.

Press FADER to resume playback of a paused disc.

The fader indicator in the display blinks and the volume starts to fade in.

Playing Tracks at Random

Selecting the random play mode leaves the track order of the disc up to the player. Each track on the disc is played just once, but in a random order. This feature is only available from the remote control.

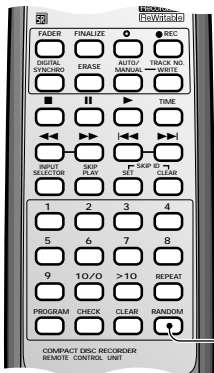

RANDOM

Press RANDOM during playback or when the disc is stopped.

The **RDM** indicator lights in the display and random playback starts.

- ❖ Pressing ■ (stop) cancels the random play mode.
- ❖ You can still use repeat mode during random play.

Playing a Disc with Skip IDs

If you're not sure whether a disc has skip IDs programmed, look for the **SKIP ON** indicator in the display when you load a disc—it will light automatically if one or more are present.

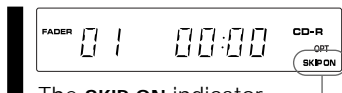

The **SKIP ON** indicator lights if there are skip IDs present on the disc.

1 Load a disc.

The **SKIP ON** indicator lights if there are any skip IDs on the disc, and the player is in skip play mode (in other words, it won't play those tracks that are marked by skip IDs).

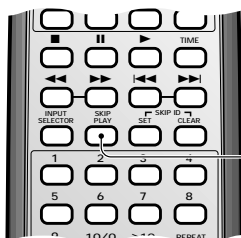

2

2 Press SKIP PLAY to switch skip play on/off, then press ► (play).

When you turn off skip play mode the player ignores the skip IDs and plays all tracks on the disc.

- ❖ If there were no skip IDs on the disc in the first place, the **SKIP PLAY** button has no effect.

Skipping Unwanted Tracks

After recording a CD-R disc, you may decide that one or more of the tracks are unwanted. This may be due to a simple mistake or because a track didn't record successfully. Although you can't erase those tracks, you can set what are called 'skip IDs'. These tell a CD player (though not all recognize skip IDs) not to play a particular track, but to skip to the next one on the disc.

You can also set skip IDs on CD-RWs, although it's probably a less useful feature since erasing the last track is possible should you make a mistake in recording.

If you make a mistake when setting a skip ID, you can clear it, but be careful: you can set up to 21 skip IDs per disc, but repeatedly setting and clearing skip IDs in different recording sessions will reduce this number.

Setting skip IDs:

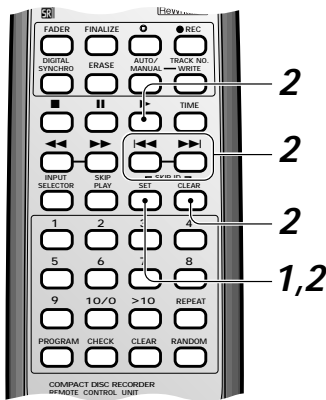

1 Press **SKIP ID SET** during playback (or while in play-pause mode) of the track you want to skip.

❖ If there's no room left on the disc to record another skip ID, the display will show the message **FULL**.

2 The display prompts you to confirm.

Press **SKIP ID SET** again to confirm. To cancel, press either **SKIP ID CLEAR** or **▶** (play).

❖ Use the **◀◀** and **▶▶** (track skip) buttons/jog dial to skip to other tracks that don't have skip IDs set. When you press **SKIP ID SET**, it will be for the track that is currently playing.

3 Set further skip IDs by repeating steps 1 and 2.

4 When you're finished, stop the disc and press **OPEN/CLOSE ▲**.

Until you eject the disc, the recorder stores the skip ID information in its memory. On pressing **OPEN/CLOSE ▲**, the recorder writes the skip ID information onto the disc.

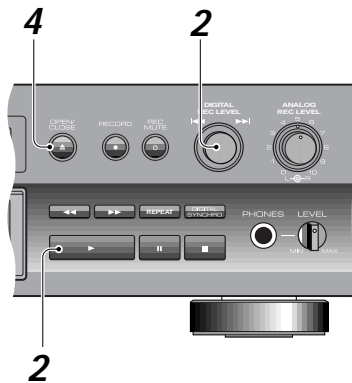

Clearing skip IDs:

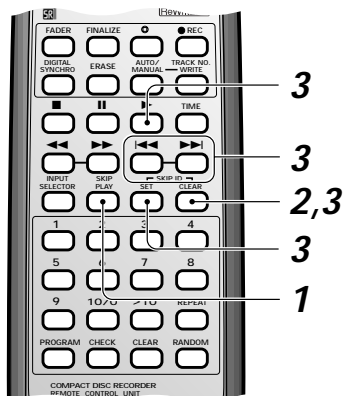

1 Press SKIP PLAY to switch off skip play mode.

The **SKIP ON** indicator in the display disappears.

- ❖ If the **SKIP ON** indicator did not light when you loaded the disc then there are no skip IDs present on that disc.

2 Press SKIP ID CLEAR during playback (or while in play-pause mode) of the track you no longer need a skip ID for.

- ❖ If this track doesn't have a skip ID, the player jumps to the next track that does and starts playback of that track.

3 The display prompts you to confirm.

Press **SKIP ID CLEAR** again to confirm. To cancel, press either **SKIP ID SET** or **▶** (play).

- ❖ Use the **◀◀** and **▶▶** (track skip) buttons/jog dial to move between tracks that have skip IDs set. When you press **SKIP ID CLEAR**, it will be for the track that is currently playing.

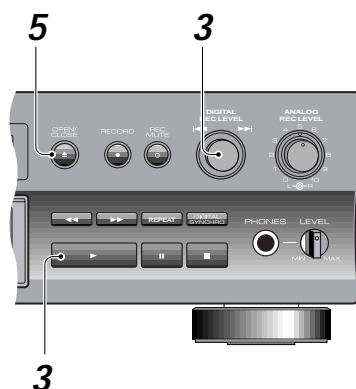

4 Clear further skip IDs by repeating steps 2 and 3.

5 When you're finished, stop the disc and press OPEN/CLOSE ▲.

Until you eject the disc, the recorder stores the changes in skip ID information in its memory. On pressing **OPEN/CLOSE ▲**, the recorder writes the new skip ID information onto the disc.

Numbering Tracks

If you're recording from CD, MD, DCC or DAT, you can usually let the recorder number the tracks as they change on the source material. Although automatic track numbering is the default mode of the recorder, you can number tracks manually as recording is taking place. In some cases—such as recording from digital satellite or Laserdisc, or from an analog source—auto track numbering may not work reliably (in these cases, a new track is started after the recorder detects two seconds of silence), and it's better to use manual track numbering. Remember: it is not possible to edit track numbers after recording.

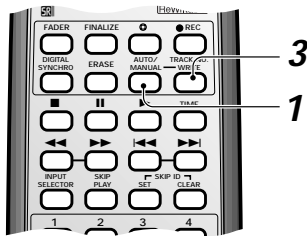
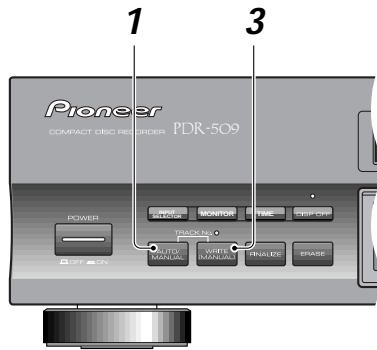

1 Press **TRACK NO. AUTO/MANUAL** to switch from automatic and manual numbering.

The red **MANUAL WRITE** indicator lights to remind you that manual numbering is switched on.

- ❖ Press **TRACK NO. AUTO/MANUAL** again to switch back to automatic numbering. The **AUTO TRACK** indicator lights in the display.
- ❖ You can switch between auto and manual track numbering either before starting to record, or during recording itself.

2 Start recording.

- ❖ You can use manual numbering in any record mode, but it is best suited to manual digital-input or analog-input recording (see pages 23 and 25 for more on these recording modes).

3 Press **TRACK NO. WRITE (MANUAL)** at any point you want a new track to start.

- ❖ CD tracks must be at least four seconds long—the recorder won't let you start a new track less than four seconds into the current track.

Recording Fade Ins and Fade Outs

Sometimes, for example if you're recording just an excerpt from something, it may be better to fade in the recording, then fade out again at the end, rather than start and end abruptly. Note that you can't record a fade in when in synchro recording mode (although you can record a fade out).

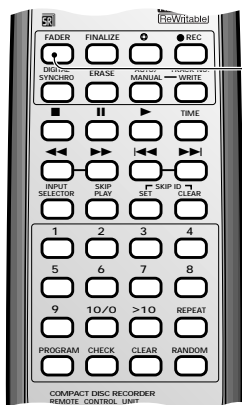

Recording a fade in

With the source playing, press **FADER** during record-pause mode to fade in.

Recording starts with a gradual fade in.

Recording a fade out

Press **FADER** during recording to fade out.

After recording about five second fade out, the recorder goes into record-pause mode. This happens in either normal or synchro record mode.

- ❖ You can also just press ■ (stop) if you don't need a fade out.

If you record a fade out during all-track sync mode, the synchro mode is canceled after the fade out (see pages 20–22 for more on synchro recording).

Note: If the recorder runs out of recording space on the disc before the source has finished, it will automatically record a fade out and stop recording.

Checking What's at the End of a Disc

You don't have to record a whole disc at once. Until you finalize the disc, further recording is possible from the end of the last track you recorded (assuming there are fewer than 99 tracks already on the disc). Here's how to check what's on the last recorded section of the disc before recording new material:

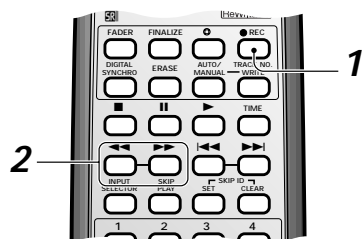

1

Press ● RECORD.

The recorder goes into record-pause mode.

2

Press and hold ◀◀ (fast-reverse).

You'll hear the last recorded track in reverse. Release the button and the track plays normally to the end.

- ❖ While the track is playing you can use the ◀◀ and ▶▶ (fast-reverse/forward) buttons
- ❖ If you press ● RECORD again while the track's playing, the recorder jumps to the end of the track and goes into record-pause mode again.

When the track has played out, the recorder automatically enters record-pause mode again.

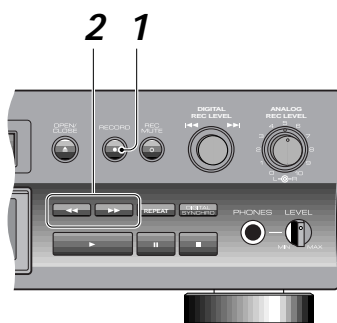

3

Once the player is back in record-pause mode you can go ahead and record normally.

If you decide you don't want to record, just press ■ (stop).

Recording Blank Sections

This feature is useful when you want to put some space at the end of a recording session so that the next recording doesn't start after the last too closely, but use it wherever you need some blank space recorded on the disc. *There are a couple of restrictions on using record mute: you can only record **one** mute per track; and you can't begin a recording with a muted section—you can use it only after the recording has started, or at the end of a recording.*

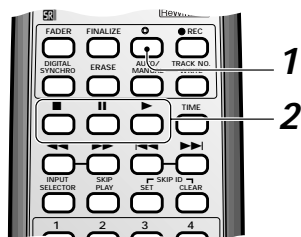

1

While recording or during record-pause mode, press ◯ REC MUTE.

A blank space of about four seconds is recorded, then the recorder goes into record-pause mode.

- ❖ If you press and hold ◯ REC MUTE, you can record a blank for as long as you hold down the button.
- ❖ Pressing ◯ REC MUTE, (without holding) in record-pause mode records four seconds of silence from the current position. Use this to create a space between tracks when recording in 1-track synchro mode, for example.

2

Press ■ (stop) to finish the recording session.

- ❖ To restart recording, press either ▶ (play) or ⏸ (pause).

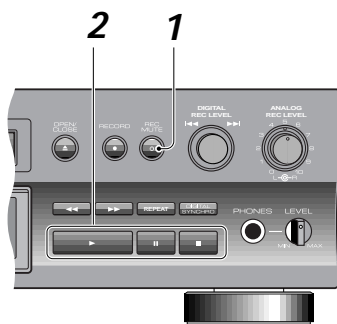

Monitoring a Source

If you have a set up like the figure below or like that on page 11, you can monitor the source without changing the input function of the amplifier from the PDR-509 (you could also monitor through a pair of headphones connected to the PDR-509's phones jack).

When recording, or in record-pause mode, the source signal is always available for monitoring from the analog outs of the PDR-509. Even if you're not recording, you can still monitor—useful for cueing up a disc or tape for the next recording.

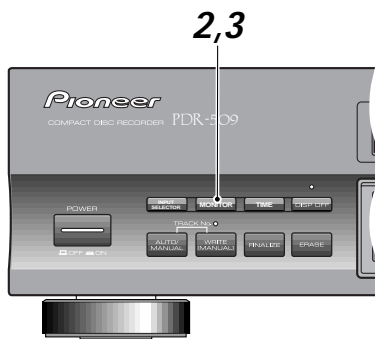

1 Start the source component playing.

Make sure that the input selector is set to the correct input.

2 Press MONITOR.

If the source is digital, the display indicates the input (**CD**, **MD**, **DCC**, **DAT**, **DVD**, or **----** if the source is unknown). then the sampling rate (**32K**, **44K** or **48K**). If the source is copy protected, the message **CAN NOT COPY** appears (see below for more on this), otherwise the display shows **MONI** (monitoring). If the source is analog, the display just shows **MONI**.

The source signal is fed through the analog outs of the unit, allowing you to monitor.

3 To switch off monitoring, press MONITOR again.

Checking for Digital Copy Protection

Using the **MONITOR** button, you can also check whether or not a digital source is copy-protected with SCMS (Serial Copy Management System). SCMS allows you to make digital copies of original sources for your own use, but prevents further digital copies being made from the copy.

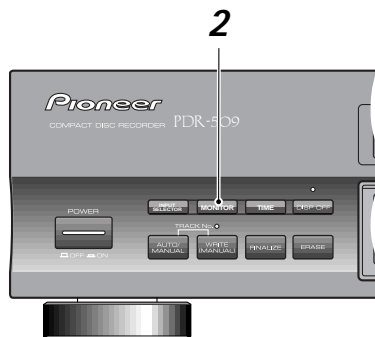
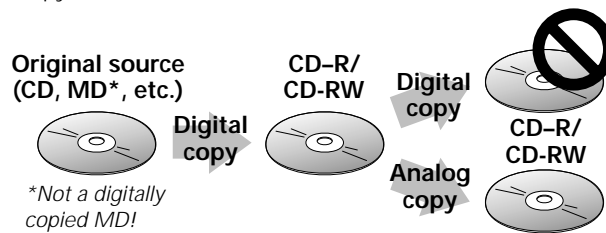

1 Start playing the digital source.

Make sure that the input selector is set to the correct digital input.

2 Press MONITOR.

The display indicates the input source (CD, MD, etc.) and its sampling rate, followed by **CAN NOT COPY** if the source is digital-copy protected.

If the display shows **MONI** (monitor), you can go ahead and record normally.

Finalizing a Disc

Before you can play a CD-R on an ordinary CD player, the disc must go through a process called finalization. Once finalized, a CD-R disc is no longer recordable, nor will you be able to set or clear skip IDs. Finalization is not reversible for CD-Rs so be absolutely sure that everything on the disc is the way you want it before you start.

CD-RW discs can also be finalized, although you can still erase the disc afterward and reuse it, so it's not anything like as final as it is with a CD-R disc. A finalized CD-RW disc can only be played on a CD player that is compatible with CD-RW discs (at present, these are very few).

CAUTION!

Finalization takes a few minutes. During this time *never* switch off the power to the unit—the disc may become unusable as a result. If there's a power failure or you do accidentally disconnect the power during finalization, the recorder will try and complete finalization once power is restored. Unfortunately, it may not be possible to complete the process successfully, and the disc may be damaged as a result.

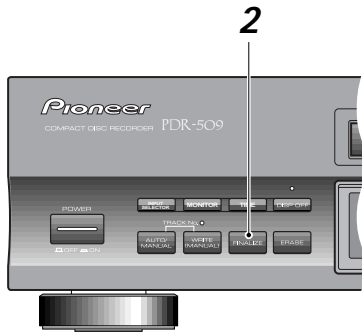

1

1 Load the CD-R or CD-RW you want to finalize.

- ❖ Check that the disc is free from dust, dirt and scratches—if necessary, clean the disc, following the guidelines on page 9.

2

2 Press FINALIZE.

The recorder goes into record-pause mode. After a short while you should see a display something like this:

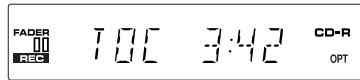

The display shows how long finalization will take—the exact time taken depends on the disc.

- ❖ Press ■ (stop) here to cancel finalization.

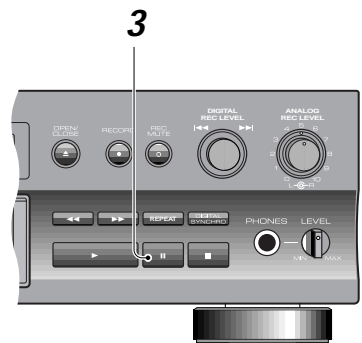

3

3 Press II (pause) to start finalization.

Finalization takes about four minutes; you'll see how long there is still to go in the display. The player goes into stop mode when finished.

For a CD-R, the **CD-R** indicator now changes to simply **CD**.

For a CD-RW, the **FINALIZE** indicator lights in the display.

- ❖ None of the controls on the player or the remote have any effect during finalization. If, however, the recorder hasn't managed to finalize the disc within 10 minutes, you can abort the operation by pressing ■ (stop). If you do this, the disc won't be playable on an ordinary CD player.

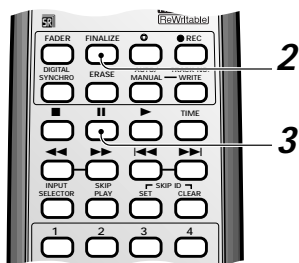

Erasing a CD-RW Disc

Although more expensive than CD-R discs, the great advantage of CD-RW is that the discs can be erased and reused. Various erase options are available depending on whether the disc has been finalized. If you want to perform an erase operation on a finalized disc that is only available for non-finalized discs, you first have to do a TOC erase. This returns a finalized disc to a non-finalized state.

A third, special option, erases (re-initializes) the whole disc. This process takes quite a long time to complete and should be used for recovering damaged discs, not for erasing tracks from a healthy disc.

CAUTION!

Never switch off the power during CD-RW erasing - your disc may become unusable. If there's a power failure or you do accidentally disconnect the power, the recorder will try and re-initialize the disc once power is restored. Unfortunately, it may not be possible to complete the process successfully, and the disc may be damaged as a result.

If the message **CHECK DISC** appears any time during any erase process, hit eject, take out the disc, clean it, then try the erase command again.

Be sure to remove the disc from the recorder before switching off the power, otherwise the erase operation will not be completed.

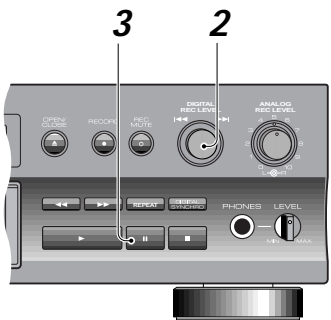
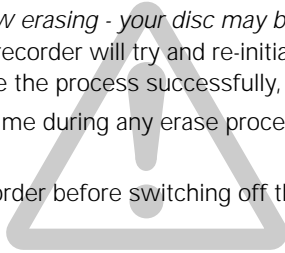

Function indicator lights when erasing

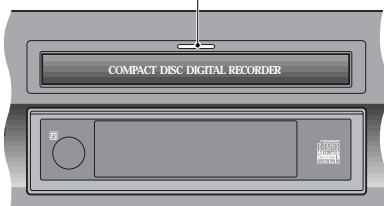

When a non-finalized disc is loaded:

1

Press ERASE.

The display shows **ERASE** then **LAST?** and the recorder function indicator blinks to indicate erase standby mode.

❖ Press ■ (stop) to cancel last track erase here.

2

Use the jog dial or press ◀◀ and ▶▶ on the remote control to change the erase option.

Switch between:

LAST? – erase just the last track

ALL? – erase all tracks

02-[LAST] – erase track 2 and all subsequent tracks

03-[LAST] – erase track 3 and all subsequent tracks

Keep turning the jog dial or press ◀◀ and ▶▶ on the remote control to change the number of tracks to erase.

3

Press || (pause) to start erasing.

The process takes just a few seconds. During this time, the function indicator lights.

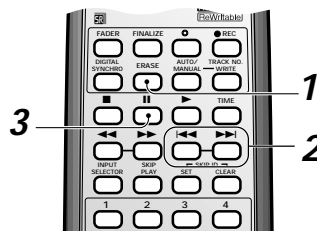

When a finalized disc is loaded:

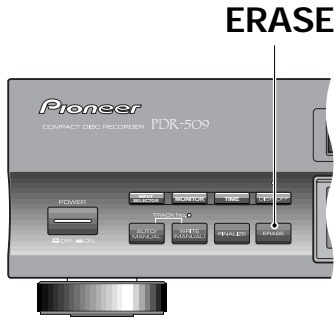

ERASE

1 Press ERASE.

The display shows **ERASE** and **TOC?** and the recorder function indicator blinks to indicate erase standby mode.

- ❖ Press ■ (stop) to cancel erase here.

2 Use the jog dial or ◀◀ and ▶▶ buttons on the remote control to change the erase option.

Switch between:

- TOC?** – erase the table of contents (returns disc to a non-finalized state)
- ALL?** – erase all tracks

3 Press || (pause) to start erasing.

The function indicator lights and the display shows **ERS** (erase), and the time remaining to completion.

- ❖ You can halt this erase process by holding down the ■ (stop) button for 10 seconds.

Function indicator lights when erasing

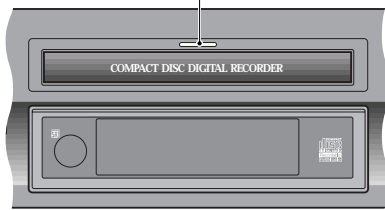

Re-initializing a disc

1 Press and hold ERASE for about four seconds.

The recorder prompts you to confirm with the message **ALL DISC ERASE?** and the recorder function indicator blinks to indicate erase standby mode.

- ❖ Press ■ (stop) to cancel all disc erase here.

2 Press || (pause) to start erasing.

The process takes about five minutes plus the entire length of the disc. During this time, the function indicator lights and the display shows **dE** (disc erase), followed by the remaining time to completion.

- ❖ You can halt this erase process by holding down the ■ (stop) button for 10 seconds.

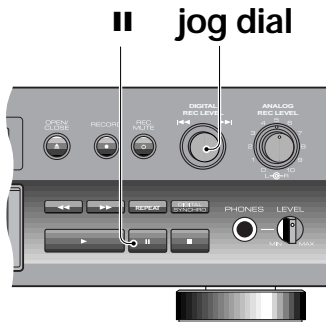

|| jog dial

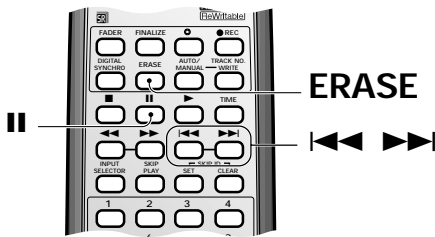

ERASE

Understanding Display Messages

Below is a list of messages you'll see during normal operation of the PDR-509 together with a brief explanation of what they mean. If you need more information, turn to the page indicated.

Message	Description	Reference
OPEN	The disc tray is open.	p.15
CLOSE	The disc tray is closing.	p.15
SET UP	The unit is setting up for recording. Wait for the message to disappear.	
TOC READ	The recorder is reading the disc's TOC (Table of Contents). Wait for the message to disappear.	
1-SYNC	The unit is in 1-track automatic digital recording mode. Recording starts when the recorder detects the digital source input signal.	p.20
AL-SYNC	The unit is in all-track automatic digital recording mode. Recording starts when the recorder detects the digital source input signal.	p.21
CAN NOT SYNC	This display appears when the DIGITAL SYNCHRO button is pressed if the INPUT SELECTOR is set for an analog source, or in digital mode if the source selected is not recognized as CD, MD, DAT, or DCC.	
MONI INPUT (CD, MD, DAT, DCC,DVD)	The recorder is monitoring the input selected with the input selector. The unit displays the source it is monitoring (CD, MD, DAT,DCC, or DVD).	p.32
PMA REC	The recorder is writing TOC data to the disc's PMA (Program Memory Area). <i>Never turn off the power while this display is showing.</i>	
TRACK ?	The recorder is waiting for you to enter a track in program play mode. Select a track using the numeric buttons, ◀◀ and ▶▶ (track skip) buttons, or jog dial.	p.26
SKIP SET?	Confirm that you want to set a skip ID by pressing the SKIP ID SET button.	p.28
SKIP CLEAR?	Confirm that you want to set a skip ID by pressing the SKIP ID CLEAR button.	p.29
LAST ?	Confirm that you want to erase the last track of a CD-RW disc by pressing ⏸ (pause).	p.34
ALL ?	Confirm that you want to erase all tracks on a CD-RW disc by pressing ⏸ (pause).	pp.34-35
TOC ?	Confirm that you want to erase the TOC of a finalized CD-RW disc to return it to a non-finalized state. After doing this, you can record more material on the disc.	p.35
** - [LAST] ? (* is a number)	Confirm that you want to erase tracks recorded on a CD-RW disc .	p.34
ALL DISC ERASE?	Confirm that you want to re-initialize the CD-RW disc by pressing ⏸ (pause).	p.35
CD-R CD-RW	This display is for in-store demonstration purposes. The demonstration stops when any key or control is operated. If no key or control is pressed for about three minutes after the demonstration was stopped, it will start again. To start the demonstration mode, switch on the power with a disc loaded and press ◀◀ as soon as the display reads 01 00:00 . To cancel the demonstration mode, switch on the power with a disc loaded and press ▶▶ as soon as the display reads 01 00:00 .	

Troubleshooting

Below is a list of messages mainly related to playback and recording problems, together with a brief explanation and a page reference where you can find more information:

Display	Cause	Remedy	Reference
CHECK DISC	The disc is damaged or dirty.	Take out the disc and check for dust, dirt, scratches, etc. Clean as necessary.	p.9
	The disc is loaded upside down.	Take out the disc and reload it label-side up. <i>If the same messages are displayed again after the disc is reloaded, unplug the power cord and plug it in again. If the same messages are still displayed, please contact a Pioneer authorized service center.</i>	p.15
CHECK (blinking display)	A system error occurred, perhaps due to noise or static electricity.	Unplug the power cord and plug it in again. If the same messages are displayed again, please contact a Pioneer authorized service center.	

Display messages relating to recording:

Display	Cause	Remedy	Reference
CAN NOT COPY	The input signal is digital-copy protected with SCMS.	Record the source through the analog inputs.	p.25, 32
CAN NOT REC	The digital source was interrupted.	Check that the digital input cable is connected properly and that the power of the source player is on.	p10
	The source is not audio, or is an incompatible format (e.g. a CD-ROM).	Check that the source is a regular music source.	
CHECK INPUT (CD) ?	The source player was already playing when the DIGITAL SYNCHRO button was pressed.	Stop the source player. After a short time, 1-SYNC or AL-SYNC is displayed, and the recorder goes into synchro-record-pause mode.	pp.20–22
SET UP	The unit is preparing to record.	Wait until the message disappears.	
REPAIR	The recorder was switched off/unplugged after recording without ejecting the disc. The recorder could not write essential recording information onto the disc.	While REPAIR is displayed, the recorder automatically examines the recorded area of the disc and updates the track numbers and recording time data. This process takes about 40 minutes for a fully recorded disc. Finalization or further recording is possible once the REPAIR message disappears.	
RESUME	The unit is resuming an operation. If the power supply is cut off (either by mistake or due to a power failure) during recording, the unit enters resume mode once power is restored so that additional recording is possible.	Wait until the message disappears.	p.19
REC FULL	No more recording is possible because the available recording time of the disc has been used up, or 99 tracks have already been recorded on the disc.	Use another disc, or erase the CD-RW disc.	p.19
Pro DISC	The loaded disc is a CD-R or CD-RW disc for professional use without the CONSUMER USE designation.	Load a CD-R or CD-RW disc that is designated as being for consumer use.	p.8, 19

Display messages relating to playback:

Display	Cause	Remedy	Reference
NEW DISC	A blank disc is loaded.	Only recording is possible on blank CD-R or CD-RW discs. Playback is not possible.	p.19
NO DISC	An attempt is made to start playback without loading a disc.	Open the tray and check that a disc is loaded.	p.15

Additional Information

It's often easy to mistake incorrect operation for trouble and malfunction of the unit. If you think there is something wrong with the component, check the points below first. If the problem persists, contact your nearest Pioneer-authorized service center and have them check over the unit.

Symptom	Cause	Remedy
Power cannot be turned on.	<ul style="list-style-type: none"> The power cord is unplugged from the wall outlet. The power was turned off from the component (stereo amplifier, audio timer, etc.) to which it is connected. 	<ul style="list-style-type: none"> Plug the power cord into a power outlet. Turn on the component supplying the power to the recorder.
No sound is heard during playback.	The recorder is not connected up properly.	Check all connections, especially to the amplifier—pp.10-11
Cannot record.	<ul style="list-style-type: none"> The recorder is not connected up properly. The CD-R or CD-RW disc in use has already been finalized. The input selection is incorrect. The REC LEVEL control is set too low. 	<ul style="list-style-type: none"> Check all connections—pp.10-11 Use a non-finalized disc or erase the CD-RW disc—pp.34-35 Select the input connected to the source component you're recording from. Increase the recording level—pp.24-25
Recorded sound is distorted.	<ul style="list-style-type: none"> The recording level is set too high. Signal connections are incorrect. There is interference from a TV set. The disc is damaged or warped. The disc is extremely dirty. 	<ul style="list-style-type: none"> Reduce the recording level—pp.24-25 Check all connections—pp.10-11 Turn the TV power off or install this unit further away from the TV. Use another disc. Clean the disc.
Remote control operation is impossible.	<ul style="list-style-type: none"> The remote control batteries are exhausted. There is an obstacle between the remote control unit and main unit. The remote control unit is being operated outside the remote controllable range. 	<ul style="list-style-type: none"> Replace both of the remote control batteries with new ones. Remove the obstacle. Operate in the remote controllable range—p.14
Some tracks are skipped without being played.	The SKIP PLAY button is set to on.	Set the SKIP PLAY button to off—p.27
Skip playback does not occur.	The SKIP PLAY button is set to off.	Set the SKIP PLAY button to on—p.27
A recorded CD-R disc cannot be played on other CD players.	<ul style="list-style-type: none"> The disc has not been finalized after recording. When such a disc is loaded in the unit, the CD-R indicator lights. The pickup lens of the other CD player is dirty, impairing its ability to play CD-R discs. 	<ul style="list-style-type: none"> Finalize the disc—p.33 Try the disc on a different CD player. If it plays OK then get the pickup lens on the original player cleaned.
The point-of-sale demonstration is displayed.	See page 36 for instructions on how to cancel the store demo mode.	

If digital synchro-recording fails to operate correctly, check the following:

- Pause playback of the source, then press the **DIGITAL SYNCHRO** button again.
 - If you're recording from a portable CD player, etc., make sure that the shock-protection feature is switched off.
 - Start playback of the source component once you see the **SYNCHRO** indicator start to blink.
 - If none of the above solves the problem, use manual digital recording to record.
- Digital synchro-recording uses a digital sub-signal contained in the source player's digital output. Digital synchro-recording will not work when recording from the following devices:
 - CD players whose digital output does not include a sub-signal
 - Portable CD, MD or DVD players which do not output a digital signal when stopped.

Specifications

1. General

Model	Compact disc audio system
Applicable discs	CDs, CD-Rs and CD-RWs
Power supply	AC 120 V, 60 Hz (U.S. and Canadian models) AC 220-230 V, 50/60 Hz (U.K. model)
Power consumption	18 W
Operating temperature	+5 °C to +35 °C (+41 °F to +95 °F)
Weight (without package)	3.9 kg (8 lb 10 oz)
Max. dimensions	420 (W) x 300 (D) x 105 (H) mm 16 ⁹ / ₁₆ (W) x 11 ¹³ / ₁₆ (D) x 4 ³ / ₁₆ (H) in.

2. Audio unit

U.S. and Canadian models

Frequency characteristics	2 Hz to 20 kHz
Playback S/N	110 dB (EIAJ)
Playback dynamic range	98 dB (EIAJ)
Playback total harmonic distortion	0.002 % (EIAJ)
Playback channel separation	98 dB
Recording S/N	92 dB
Recording dynamic range	92 dB
Recording total harmonic distortion	0.005 %

U.K. model

Frequency characteristics	2 Hz to 20 kHz
Playback S/N	112 dB (EIAJ)
Playback dynamic range	98 dB (EIAJ)
Playback total harmonic distortion	0.0017 % (EIAJ)
Playback channel separation	98 dB
Recording S/N	92 dB
Recording dynamic range	92 dB
Recording total harmonic distortion	0.004 %

Output voltage	2 V
Wow-flutter	Less than measurement limit (±0.001 % W.PEAK) (EIAJ)

U.S. and Canadian models /U.K. model

Number of channels	2 channels (stereo)
Digital output:	
Coaxial output	0.5 Vp-p ±20 % (75 Ω)
Optical output	-15 to -21 dBm (wavelength: 660 nm)
	Frequency deflection: Level 2 (standard mode)

*Recording specification values are for the LINE input (analog)

3. Input jacks

Optical digital input jack
Coaxial digital input jack
Audio LINE input jack
Control IN jack

4. Output jacks

Optical digital output jack
Coaxial digital output jack
Audio LINE output jack

5. Accessories

● Remote control unit	1
● Size AA/R6P dry cell batteries	2
● Audio cord	2
● AC power cord	1
● Operating Instructions	1

NOTE:

The specifications and design of this product are subject to change without notice, due to improvements.



Dear Customer:

Selecting fine audio equipment such as the unit you've just purchased is only the start of your musical enjoyment. Now it's time to consider how you can maximize the fun and excitement your equipment offers. This manufacturer and the Electronic Industries Association's Consumer Electronics Group want you to get the most out of your equipment by playing it at a safe level. One that lets the sound come through loud and clear without annoying blaring or distortion-and, most importantly, without affecting your sensitive hearing.

Sound can be deceiving. Over time your hearing "comfort level" adapts to higher volumes of sound. So what sounds "normal" can actually be loud and harmful to your hearing. Guard against this by setting your equipment at a safe level BEFORE your hearing adapts.

To establish a safe level:

- Start your volume control at a low setting.
- Slowly increase the sound until you can hear it comfortably and clearly, and without distortion.

Once you have established a comfortable sound level:

- Set the dial and leave it there.

Taking a minute to do this now will help to prevent hearing damage or loss in the future. After all, we want you listening for a lifetime.

We Want You Listening For A Lifetime

Used wisely, your new sound equipment will provide a lifetime of fun and enjoyment. Since hearing damage from loud noise is often undetectable until it is too late, this manufacturer and the Electronic Industries Association's Consumer Electronics Group recommend you avoid prolonged exposure to excessive noise. This list of sound levels is included for your protection.

Decibel

Level	Example
30	Quiet library, soft whispers
40	Living room, refrigerator, bedroom away from traffic
50	Light traffic, normal conversation, quiet office
60	Air conditioner at 20 feet, sewing machine
70	Vacuum cleaner, hair dryer, noisy restaurant
80	Average city traffic, garbage disposals, alarm clock at two feet.

THE FOLLOWING NOISES CAN BE DANGEROUS UNDER CONSTANT EXPOSURE

90	Subway, motorcycle, truck traffic, lawn mower
100	Garbage truck, chain saw, pneumatic drill
120	Rock band concert in front of speakers, thunderclap
140	Gunshot blast, jet plane
180	Rocket launching pad

Information courtesy of the Deafness Research Foundation.



Published by Pioneer Electronic Corporation.
Copyright © 1999 Pioneer Electronic Corporation.
All rights reserved.

PIONEER ELECTRONIC CORPORATION

4-1, Meguro 1-Chome, Meguro-ku, Tokyo 153-8654, Japan

PIONEER ELECTRONICS [USA] INC. P.O. BOX 1540, Long Beach, California 90801-1540, U.S.A.

PIONEER ELECTRONICS OF CANADA, INC. 300 Allstate Parkway, Markham, Ontario L3R OP2, Canada

PIONEER ELECTRONIC [EUROPE] N.V. Haven 1087, Keetberglaan 1, 9120 Melsele, Belgium TEL: 03/570.05.11

PIONEER ELECTRONICS AUSTRALIA PTY. LTD. 178-184 Boundary Road, Braeside, Victoria 3195, Australia, TEL: 03-9586-6300

PIONEER ELECTRONICS DE MEXICO S.A. DE C.V. San Lorenzo Num 1009 3er piso Desp. 302 Col. Del Valle, Mexico D.F. C.P. 03100 TEL: 5-688-52-90

Free Manuals Download Website

<http://myh66.com>

<http://usermanuals.us>

<http://www.somanuals.com>

<http://www.4manuals.cc>

<http://www.manual-lib.com>

<http://www.404manual.com>

<http://www.luxmanual.com>

<http://aubethermostatmanual.com>

Golf course search by state

<http://golfingnear.com>

Email search by domain

<http://emailbydomain.com>

Auto manuals search

<http://auto.somanuals.com>

TV manuals search

<http://tv.somanuals.com>