

Pioneer *sound.vision.soul*

COMPACT DISC PLAYER

CDJ-1000MK3

Operating Instructions



Thank you for buying this Pioneer product.

Please read through these operating instructions so you will know how to operate your model properly. After you have finished reading the instructions, put them away in a safe place for future reference.

In some countries or regions, the shape of the power plug and power outlet may sometimes differ from that shown in the explanatory drawings. However the method of connecting and operating the unit is the same.

K015 En

IMPORTANT



The lightning flash with arrowhead symbol, within an equilateral triangle, is intended to alert the user to the presence of uninsulated "dangerous voltage" within the product's enclosure that may be of sufficient magnitude to constitute a risk of electric shock to persons.

CAUTION
RISK OF ELECTRIC SHOCK
DO NOT OPEN

CAUTION:
TO PREVENT THE RISK OF ELECTRIC SHOCK, DO NOT REMOVE COVER (OR BACK). NO USER-SERVICEABLE PARTS INSIDE. REFER SERVICING TO QUALIFIED SERVICE PERSONNEL.



The exclamation point within an equilateral triangle is intended to alert the user to the presence of important operating and maintenance (servicing) instructions in the literature accompanying the appliance.

D1-4-2-3_En-A

WARNING

This equipment is not waterproof. To prevent a fire or shock hazard, do not place any container filled with liquid near this equipment (such as a vase or flower pot) or expose it to dripping, splashing, rain or moisture.

D3-4-2-1-3_A_En

IMPORTANT NOTICE – THE SERIAL NUMBER FOR THIS EQUIPMENT IS LOCATED ON THE BOTTOM. PLEASE WRITE THIS SERIAL NUMBER ON YOUR ENCLOSED WARRANTY CARD AND KEEP IN A SECURE AREA. THIS IS FOR YOUR SECURITY.

D1-4-2-6-1_En

Information to User

Alteration or modifications carried out without appropriate authorization may invalidate the user's right to operate the equipment.

D8-10-2_En

CAUTION: This product satisfies FCC regulations when shielded cables and connectors are used to connect the unit to other equipment. To prevent electromagnetic interference with electric appliances such as radios and televisions, use shielded cables and connectors for connections.

D8-10-3a_En

This Class B digital apparatus complies with Canadian ICES-003.

Cet appareil numérique de la Classe B est conforme à la norme NMB-003 du Canada.

D8-10-1-3_EF

WARNING: Handling the cord on this product or cords associated with accessories sold with the product will expose you to chemicals listed on proposition 65 known to the State of California and other governmental entities to cause cancer and birth defect or other reproductive harm.

Wash hands after handling

D36-P4_A_En

WARNING

To prevent a fire hazard, do not place any naked flame sources (such as a lighted candle) on the equipment.

D3-4-2-1-7a_A_En

VENTILATION CAUTION

When installing this unit, make sure to leave space around the unit for ventilation to improve heat radiation (at least 5 cm at rear, and 3 cm at each side).

WARNING

Slots and openings in the cabinet are provided for ventilation to ensure reliable operation of the product, and to protect it from overheating. To prevent fire hazard, the openings should never be blocked or covered with items (such as newspapers, table-cloths, curtains) or by operating the equipment on thick carpet or a bed.

D3-4-2-1-7b_A_En

POWER-CORD CAUTION

Handle the power cord by the plug. Do not pull out the plug by tugging the cord and never touch the power cord when your hands are wet as this could cause a short circuit or electric shock. Do not place the unit, a piece of furniture, etc., on the power cord, or pinch the cord. Never make a knot in the cord or tie it with other cords. The power cords should be routed such that they are not likely to be stepped on. A damaged power cord can cause a fire or give you an electrical shock. Check the power cord once in a while. When you find it damaged, ask your nearest PIONEER authorized service center or your dealer for a replacement.

S002_En

NOTE: THE NO USER-SERVICEABLE PARTS COMPARTMENT WARNING IS LOCATED ON THE APPLIANCE BOTTOM.

IMPORTANT SAFETY INSTRUCTIONS

- 1) Read these instructions.
 - 2) Keep these instructions.
 - 3) Heed all warnings.
 - 4) Follow all instructions.
 - 5) Do not use this apparatus near water.
 - 6) Clean only with dry cloth.
 - 7) Do not block any ventilation openings. Install in accordance with the manufacturer's instructions.
 - 8) Do not install near any heat sources such as radiators, heat registers, stoves, or other apparatus (including amplifiers) that produce heat.
 - 9) Do not defeat the safety purpose of the polarized or grounding-type plug. A polarized plug has two blades with one wider than the other. A grounding type plug has two blades and a third grounding prong. The wide blade or the third prong are provided for your safety. If the provided plug does not fit into your outlet, consult an electrician for replacement of the obsolete outlet.
 - 10) Protect the power cord from being walked on or pinched particularly at plugs, convenience receptacles, and the point where they exit from the apparatus.
 - 11) Only use attachments/accessories specified by the manufacturer.
 - 12) Use only with the cart, stand, tripod, bracket, or table specified by the manufacturer, or sold with the apparatus. When a cart is used, use caution when moving the cart/apparatus combination to avoid injury from tip-over.
- 
- 13) Unplug this apparatus during lightning storms or when unused for long periods of time.
 - 14) Refer all servicing to qualified service personnel. Servicing is required when the apparatus has been damaged in any way, such as power-supply cord or plug is damaged, liquid has been spilled or objects have fallen into the apparatus, the apparatus has been exposed to rain or moisture, does not operate normally, or has been dropped.

P1-4-2-2_En

NOTE: This equipment has been tested and found to comply with the limits for a Class B digital device, pursuant to Part 15 of the FCC Rules. These limits are designed to provide reasonable protection against harmful interference in a residential installation. This equipment generates, uses, and can radiate radio frequency energy and, if not installed and used in accordance with the instructions, may cause harmful interference to radio communications. However, there is no guarantee that interference will not occur in a particular installation. If this equipment does cause harmful interference to radio or television reception, which can be determined by turning the equipment off and on, the user is encouraged to try to correct the interference by one or more of the following measures:

- Reorient or relocate the receiving antenna.
- Increase the separation between the equipment and receiver.
- Connect the equipment into an outlet on a circuit different from that to which the receiver is connected.
- Consult the dealer or an experienced radio/TV technician for help.

D8-10-1-2_En

CAUTION

This product is a class 1 laser product, but this product contains a laser diode higher than Class 1. To ensure continued safety, do not remove any covers or attempt to gain access to the inside of the product. Refer all servicing to qualified personnel. The following caution label appears on your unit. Location: top of the CD drive

**CLASS 1
LASER PRODUCT**

CAUTION CLASS 3B INVISIBLE LASER RADIATION WHEN OPEN, AVOID EXPOSURE TO BEAM.
ATTENTION RADIATIONS LASER INVISIBLES DE CLASSE 3B QUAND OUVERT.ÉVITEZ TOUT EXPOSITION AU FAISCEAU.
ADVARSEL KLASSE 3B USYNLIG LASERSTRÅLING VED ÅBNING. UNDGÅ UDSÆTTELSE FOR STRÅLING.
WARNING KLASS 3B OSYNLIG LASERSTRÅLING NÄR DENNA DEL ÄR ÖPPNAD. UNDIK ATT UTSÄTTA DIG FÖR STRÅLEN.

VORSICHT BEI GEÖFFNETER ABDECKUNG IST UNSICHTBARE LASERSTRÄHLUNG DER KLASSE 3B IM GERÄTEINNEREN VORHANDEN. NICHT DEM LASERSTRAHLAUSSETZER!
PRECAUCIÓN CUANDO SE ABRE HAY RADIACIÓN LASER DE CLASE 3B INVISIBLE. EVITE LA EXPOSICIÓN A LOS RAYOS LASER.
VARO! AVATTAESSA OLET ALTTIINA NÄKYMÄTTÖMÄLLE LUOKAN 3B LASERSÄTELYLLE. ÄLÄ KATSO SÄTEESEEN.

DRW2308-A

D3-4-2-1-8_B_En

Contents

Before Operating

Specifications	3
Features	4
Handling Precautions	5
Discs Usable with This Unit	6
Connections	8
Names and Functions of Parts	10

Basic Operations

Loading and Removing Discs	13
DJ Player Operation	14
Auto cueing	14
Starting playback	14
To stop playback	14
To pause playback	14
Fast forward / Fast reverse	14
Track search	15
Folder search (MP3 only)	15
Cue point settings	15
To change the playing speed	16
Applying master tempo	16
Jog dial functions	16
Jog sensitivity adjustment	16
Mixing different tracks	17
About WAVE display	17
About TEXT display	17

Advanced Operations

Advanced Operations	18
Scratch play	18
Spin play	18
Braking	18
Loop playback	18
To perform hot cue	19
Reverse play	19
About fader start play	19
Relay play using two players	19
Operations Using Memory Cards	20
Recording to memory cards	20
To call up recorded data	21
To delete information recorded on memory cards	21
To copy memory card data	21
Display during recording of cue and loop points	21

Other

Troubleshooting	22
-----------------------	----

Specifications

1. General

System	Compact disc digital audio system
Power requirements	AC 120 V, 60 Hz
Power consumption	28 W
Operating temperature	+5 °C to +35 °C
Operating humidity	5 % to 85 % (There should be no condensation of moisture.)
Weight	4.2 kg (9.26 lb)
Dimensions	320 (W) x 370 (D) x 105 (H) mm 12 – 5/8 (W) x 14 – 9/16 (D) x 4 – 1/8 (H) in

2. Audio section

Frequency response	4 Hz to 20 kHz
Signal-to-noise ratio	115 dB or more (JEITA)
Distortion	0.006 % (JEITA)

3. Accessories

● Operating instructions	1
● Power cord	1
● Audio cable	1
● Control cord	1
● Forced eject pin (housed in a groove in the bottom panel)	1
● SD memory card	1
● Limited warranty	1

NOTE:

Specifications and design are subject to possible modification without notice.

Features

The CDJ-1000MK3 compact disc player is designed for use by DJs providing all the functions and performance required in disco clubs while offering performance, sound quality and functionality superior to any analog player.

JOG DIAL

The large 206 mm diameter jog dial enables better handling than an analog turntable.

● PITCH BEND

This function changes the music tempo depending on direction of jog dial rotation and speed of movement.

● SCRATCH PLAY

In the VINYL mode when the surface of the jog dial is pressed playback is discontinued and then continues according to the direction and speed the dial is rotated. You can also adjust the startup when the jog dial is touched and released to create new DJ techniques.

● FRAME SEARCH

Moves the disc from pause position in frame increments (1/75 sec) when the jog dial is rotated in pause mode.

● SUPER FAST SEARCH

Rotate the jog dial while holding depressed the SEARCH button, TRACK SEARCH button, or FOLDER SEARCH button. When this is done, search will be performed faster than the normal search, track search, or folder search operations.

● JOG ADJUST (Jog Sensitivity Adjustment)

This function allows you to adjust the felt resistance when rotating the jog dial.

ON JOG DISPLAY

The center of the jog dial displays information regarding disc status, cue point position, sound memory status, jog dial touch-detection, and VINYL mode.

WAVE DISPLAY

This display makes it possible to find the breakpoint between tracks in advance and use it as mix point or end point in the same way as you can on an analog record by checking the position of the needle in the groove.

CUE/LOOP MEMORY

This unit is equipped with a function allowing cue points and loop points for individual discs to be recorded on SD memory cards or MultiMedia Cards (MMC); the recorded data can then be called up when playing the respective disc.

HOT CUE

UP to three hot cue points (A, B, C) can be preset, thus allowing playback to be performed instantly from either of those points. The hot cue function can be used to record not only cue points, but loop points as well.

REVERSE PLAY

Set the DIRECTION switch to its forward position ([REV] position) to play the music backwards.

TEMPO CONTROL

100 mm high-precision slider coupled with a 0.02 % increment digital display (within a ± 6 % range) allows exact control of speed to make tempo adjustments easy and accurate.

● TEMPO CONTROL RANGE

The maximum variable range can be set to four variable ranges: ± 6 %, ± 10 %, ± 16 % and WIDE to facilitate adjustment.

● TEMPO CONTROL RESET

Resets the tempo to 0 % regardless of slider position.

● MASTER TEMPO

Changes music tempo without changing pitch.

CUE

● BACK CUE

After storing the cue point in memory, press the CUE button while playing the unit to go back to the cue point and start over.

● AUTO CUE

Auto cue automatically locates the song's start point even if it differs from the track's frame, allowing the player to start instantly at a press of the PLAY button.

● CUE POINT SAMPLER

The sound from the memorized cue point can be reproduced by one touch, which can be used as the start point check and the sampler.

REAL TIME SEAMLESS LOOP

This function simplifies setting and releasing loops. This function lets you set a loop while you are playing a track. A loop can also be set at the end of the track so that the track does not stop. In addition, an ADJUST mode has been added to enable one-touch adjustments to Loop-in and Loop-out points and facilitate loop operation.

RELOOP

Allows you to replay a loop any number of times.

Press the RELOOP button after releasing loop play to return to the loop start point. Clever use of on and off in combination with the rhythm make it possible to create new sound effects.

PLAYING ADDRESS

This bar graph provides a visual representation of track playback progress that enables you to see current playback position just like you can on an analog record by checking needle position. The length of the bar shows current position and a flashing bar provides advance notice of track end.

SLOT IN

Discs are loaded directly without opening doors or trays, making track selection that much faster.

FADER START

When a Pioneer DJ mixer (sold separately) is connected, the mixer's fader operation can be used to perform quick start and back cue.

MULTI READ

Allows playback of CD-R, CD-RW discs (recorded in music CD or MP3 format). (Note that some discs may not play properly due to characteristics of the individual disc, recorder, or disc soiling and scratches.)

MP3 DJ PLAY

MP3 files recorded on CD-ROM can be played with DJ functions.

Handling Precautions

Installation location

- Placing and using the player for long periods on heat-generating sources such as amplifiers or near spotlights, etc. will affect product performance. Avoid placing the player on heat-generating sources.
- Install this player as far as possible away from tuners and TV sets. The player installed in close proximity to such equipment may cause noise or degradation of the picture. Noise may be noticeable when an indoor antenna is used. In such cases, make use of an outdoor antenna or turn off power to the player.
- When the unit is used in a loud-sound environment, e.g., near a speaker, sound skip may occur. Install the unit away from the speaker or reduce the listening volume.
- Place this unit on a level surface and a stable platform. Take adequate note of the following precautions when preparing a place for installation:

Be sure the player, including its video, audio and power supply cords, does not touch vibrating materials. Any vibration other than that transmitted through the insulators may cause the disc to skip. Take special care when using the player while it is installed in a carrying case.

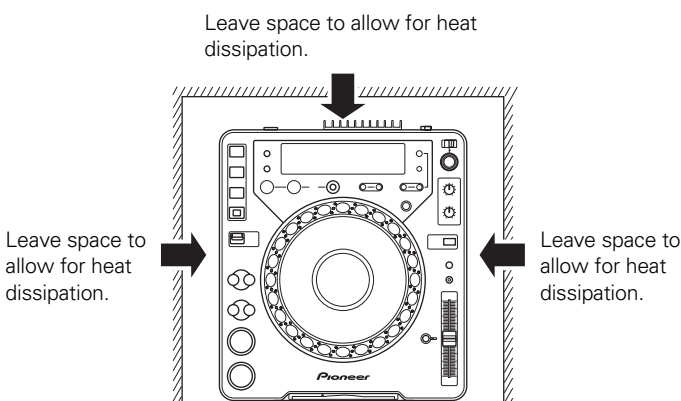
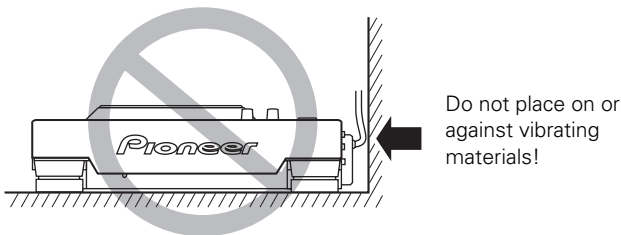

Moving the unit

■ Never move the unit during playback!

During playback, a disc rotates at very high speed; moving the player during playback may result in scratches or other damage to the disc.

■ When moving the unit is necessary

Before moving the unit, remove any disc and disconnect the power. Malfunctions or damage may result if the unit is moved with a disc loaded.

About the carrying case

The upper surface of the jog dial is equipped with a touch-sensitive switch. When placing the player in its carrying case, avoid placing any pressure on the jog dial.

Condensation

When this unit is brought into a warm room from previously cold surroundings or when the room temperature rises sharply, condensation may form inside the unit and impair its performance. In such cases, allow the unit to stand for about an hour or raise the room temperature gradually.

Cleaning the player

To clean the player wipe with a polishing or a soft, dry cloth. For stubborn dirt, moisten a soft cloth with a weak solution of neutral detergent (diluted in five to six parts water), wring the cloth well, and wipe away the dirt. Use a dry cloth to wipe the surface dry. Do not use volatile liquids such as benzene or thinner which will damage the unit.

About the lens cleaner

The player's pickup lens should not become dirty in normal use. If for some reason, the lens becomes soiled and malfunctions, contact your nearest PIONEER authorized service center. Lens cleaners for CD players are commercially available, but special care should be exercised in their use as some may cause damage to the lens.





Regarding data recorded on memory cards

It is the users responsibility to make regular backups of important memory card data. Pioneer disclaims any responsibility for damage to or loss of memory card data, or other incidental damages arising from incompatibilities of the player and memory card, static electricity or other external causes.

Discs Usable with This Unit

Types of discs playable on this unit

- The following marks and logos are displayed on disc labels, packaging, or jackets.

Types and Logos of playable discs			
CD	CD-TEXT (Note 1)	CD-R (Note 2)	CD-RW (Note 2)
			

Note 1) Regarding TEXT display:

The number of characters that can be displayed is up to 48. When a display exceeds 16 characters in length, the display will scroll. Only alpha-numerics and a limited number of symbols can be displayed (P. 17).

Note 2) CD-R/CD-RW discs:

This player supports playback of CD-R/CD-RW discs recorded in audio CD format or MP3.

* For details, consult the Operating Instructions for your recorder.

When playing 8 cm CDs, always use an 8 cm CD adapter (P. 13).

Notes:

- Some CD-R/CD-RW discs recorded on standalone recorders or computer drives may not be playable back on this player, due to a variety of reasons, including disc characteristics, scratches, dirt, player lens dirt or condensation, etc.
- Some discs recorded on computer drives may not be playable on this player, depending on the recording application used, its settings, and operating environment. Be sure to use the correct formatting for the discs used. For details, consult the application author.
- This unit cannot play partially recorded CD-R or CD-RW discs that have not been finalized.
- For detailed information regarding the handling of CD-R/CD-RW discs, consult the handling precautions supplied with each disc.

Regarding CD-R/RW discs

Due to the unique construction of CD-R/RW discs, leaving them for extended periods of time in the pause (or cue standby) mode at a single point may result in the discs' becoming difficult to play at that place. The same symptom may also occur if the loop function is used to play back a single point on the disc excessively.

As a result, users are advised to construct backup archive discs when playing discs containing important data.

About DualDisc playback

This product is designed to conform to standards for music CDs. No warranty is made for operation or performance when used with discs not conforming to such music CD standards.

Playing MP3 files

MP3 files must follow the format requirements listed below.

MP3 format	MPEG-1	Supports Audio Layer-3 sampling frequency 32 kHz, 44.1 kHz, 48 kHz, Bit Rate 32 Kbps to 320 Kbps.
	MPEG-2	Supports Audio Layer-3 sampling frequency 16 kHz, 22.05 kHz, 24 kHz, Bit Rate 16 Kbps (stereo) to 160 Kbps.
	ID3 tag	Supports ID3 Vers. 1.0/1.1/2.2/2.3/2.4. Displays title, album, artist.
Disc format	File extension	.mp3, .MP3, .mP3, .Mp3
	Folder layers	Maximum 8 layers; files in folders exceeding 8 layers cannot be played.
	Maximum number of folders	99 (99 folders + 1 root)
	Maximum number of files	999 (per folder)
	CD-R recording method	Record following the ISO9660 CD-ROM file system. Supports only Disc At Once or Track At Once. CDJ-1000MK3 does not support Packet Write recorded discs.

- * CDJ-1000MK3 is not equipped with a File Sort function; tracks will be played in the order in which they were recorded.
- * Plays MP3 files stored on CD-ROM. Cannot play MP3 files stored on SD memory cards or MultiMedia cards (MMC).
- * Startup time increases with the number of folders.

Handling discs

- When holding discs, do not touch their signal surfaces. Hold by the edges, or by one edge and the center hole.

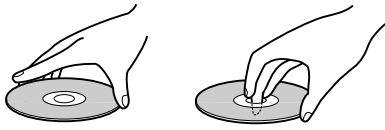

- Do not affix gummed labels or tape to the disc surface. Also, do not scratch or damage the label.



- Discs rotate at high speeds inside the player. Do not use damaged, cracked or warped discs.



■ Do not play a disc with a special shape

- Do not play a disc having other shape than a circular disc, such as heart shaped disc. Otherwise malfunction may occur.

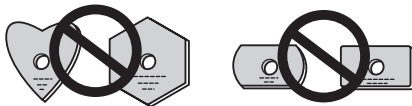

■ Storing discs

- Discs are made of the same kinds of plastic used for conventional analog audio records. Be careful not to allow discs to warp. Always store discs in their cases vertically, avoiding locations with high heat, humidity, or extremely low temperatures. Avoid leaving discs in cars; the interior of a car in direct sunlight can become extremely hot.
- Always read and abide by the precautionary notes listed on disc labels.

■ Cleaning discs

- Always keep your discs clean by wiping them gently with a soft cloth from the inner edge toward the outer edge.
- When cleaning discs, the use of a commercial CD cleaning kit is recommended.

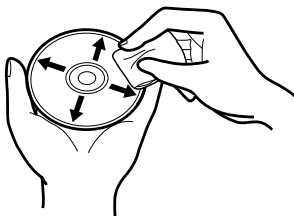

- If a disc becomes very dirty, dampen a soft cloth with water, (be sure to wring it out well) and wipe the away dirt gently. Remove any water drops with another soft, dry cloth.
- Do not use record cleaning sprays or anti-static agents on discs. Never clean discs with benzene, thinner, or other volatile solvents or damage to the disc surface may result.

Connections

Always turn off power switch and disconnect power cord when making or changing connections.

1. Connection to a Pioneer DJ mixer (audio output and control connector)

Using the auxiliary audio cable, connect the white plug to the L (left) jack, and the red plug to the R (right) jack.

In addition, by connecting the furnished control cord, the DJ mixer can be used to control this unit for fader start play and back cue operations.

Note that digital connections can be made only with mixers equipped with digital input connectors (models DJM-800, DJM-1000, etc.). Use a commercially available coaxial digital cable to connect this unit's DIGITAL OUT connector to the DJ mixer's DIGITAL IN connector.

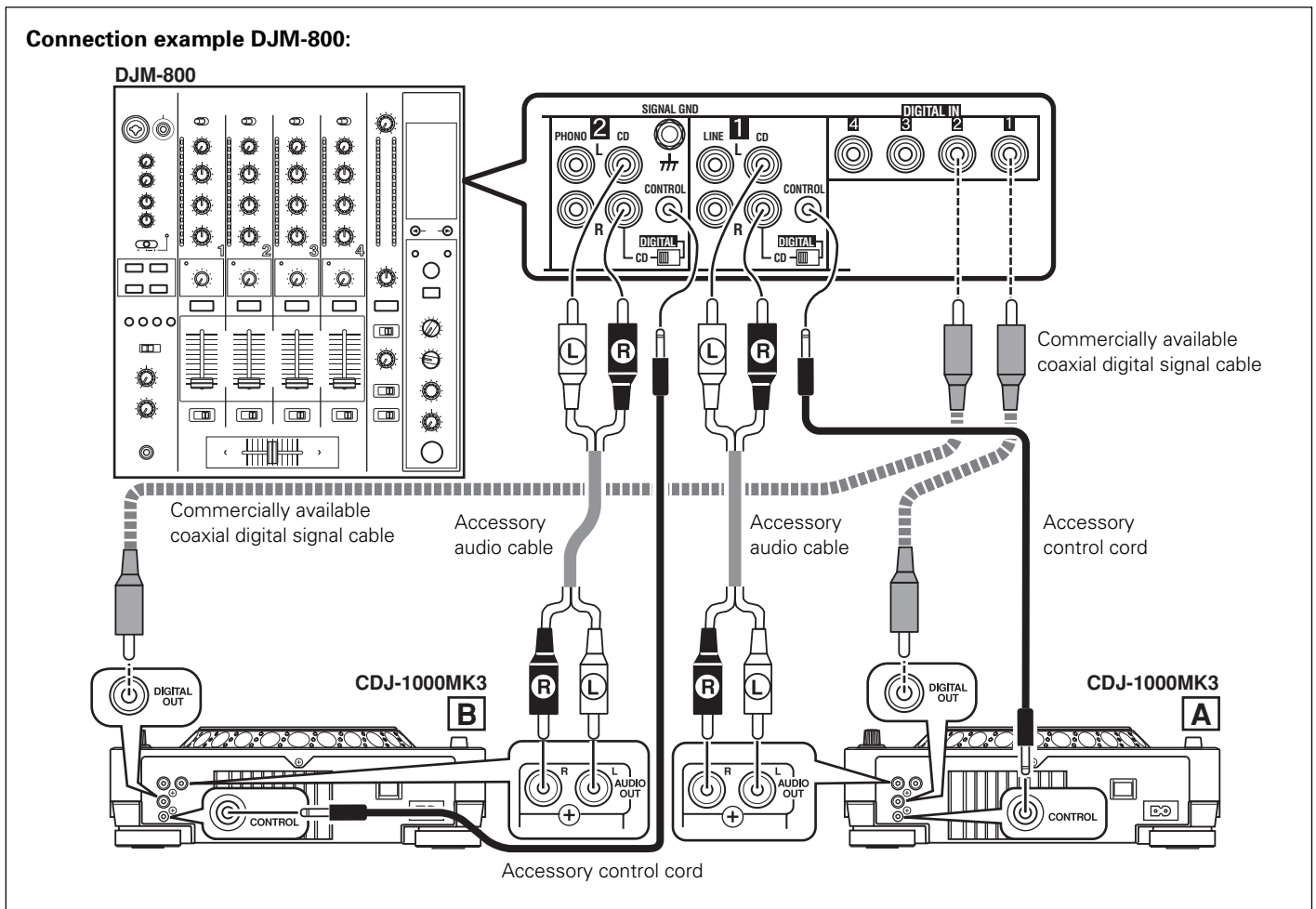

- When making connections to the DJM-1000, the furnished audio cables can be used to connect one set of the CD/LINE connectors to player A, and the other set of CD/LINE connectors to a second player B. When making digital audio connections, a commercially available coaxial digital signal cable must be used to connect the CD player's DIGITAL OUT connector to one of the DIGITAL IN connectors (4 to 6) of the DJM-1000 mixer.
- When connecting to the DJM-600, DJM-300, or DJM-500, use the furnished audio cables to connect the CD1 connectors to player A, and CD2 connectors to player B.
- When connecting to DJM-909 or DJM-707, use the furnished audio cables to connect the CH1 CD connectors to player A, and CH2 CD connectors to player B.
- When connecting to DJM-3000, connect player A to CH-1 LINE 1, and player B to CH-2 LINE 3.
- When connecting this CD player to other audio mixers, connect the player's AUDIO OUT connectors to the mixer's LINE IN or AUX IN connectors. (★ **DO NOT connect to the PHONO connectors, since it may result in distorted sound or improper playback.**)

2. Control cord connections for relay play

By using the accessory control cord to connect the control connectors of two DJ CD Players, automatic relay play can be performed. (P.19)

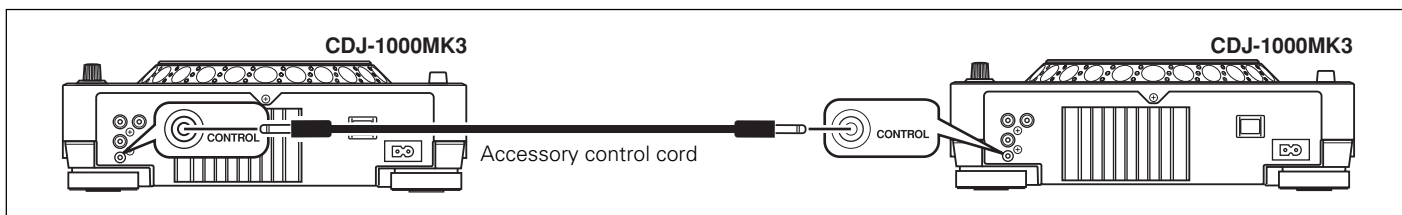

3. Connecting other components

A Connecting a stereo amplifier (when not using DJ mixer)

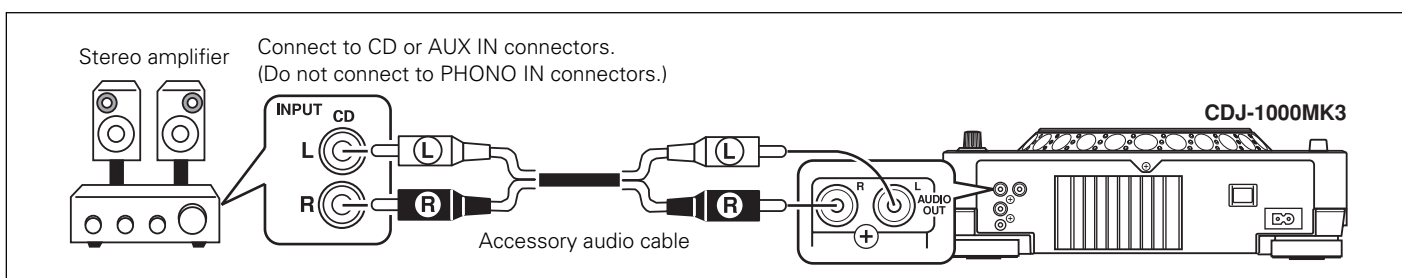

B Connecting a component equipped with DIGITAL IN connectors

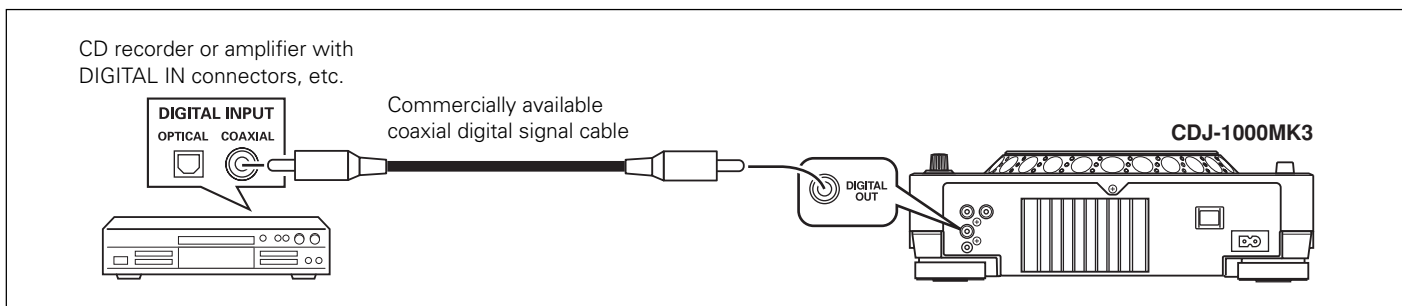

- The DIGITAL OUT connectors produce audio data only (without subcodes; CD graphics are not supported). Depending on the CD recorder or other component connected, some recording or other functions may be limited. For details, consult the operating instructions for the connected component.

4. Connecting the power cord

After completing all other connections, connect one end of the accessory power cord to the AC inlet on the rear side of the player, and connect the other end to a standard AC wall outlet, or to the auxiliary power outlet on your amplifier.

Names and Functions of Parts

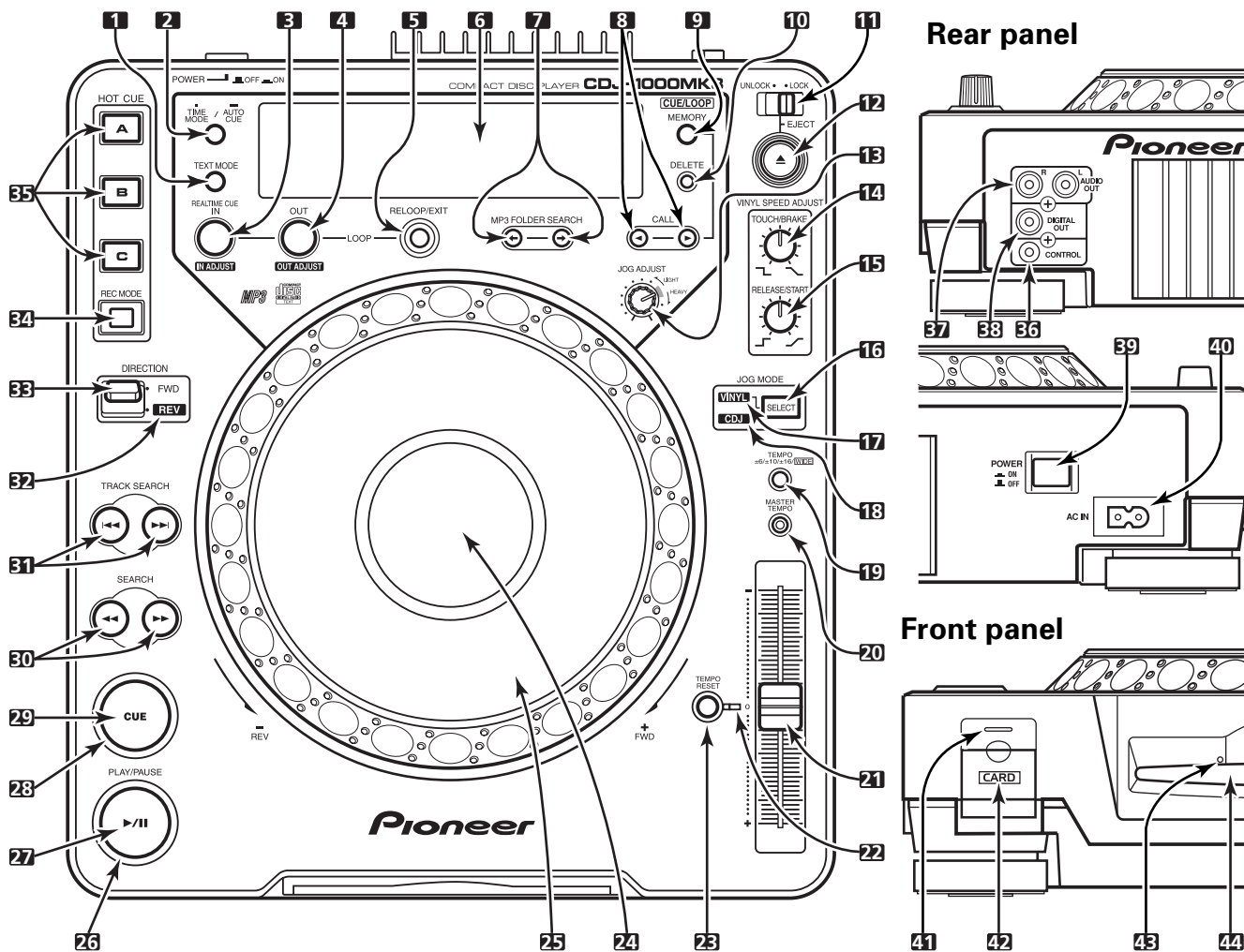

1. Display selector button (TEXT MODE)

Each time this button is pressed, the display alternates between WAVE and TEXT (track name/album name/artist name). P. 17
When playing MP3, WAVE display may not be possible, depending on the track.

2. TIME MODE/AUTO CUE button

TIME MODE:

Each time the button is pressed, the display's time display alternates between the current elapsed play time and the remaining play time (REMAIN).

When playing MP3, the REMAIN time may not display immediately, depending on the track.

- The current TIME MODE setting is retained in memory even when the power is turned off.

AUTO CUE:

When the button is held depressed for 1 second or more, the AUTO CUE mode is alternately enabled and disabled.

When the button is held depressed for 5 seconds or more, the AUTO CUE level is toggled. P. 14

- The current AUTO CUE on/off and AUTO CUE level settings are retained in memory even when power is turned off.

3. LOOP IN/REALTIME CUE (IN ADJUST) button/indicator

Realtime cue P. 15

Loop-in point input P. 18

Loop-in point adjust P. 18

4. LOOP OUT (OUT ADJUST) button/indicator

Loop-out point input P. 18

Loop-out point adjust P. 18

5. RELOOP/EXIT button P. 18

6. Display P. 12 (51 to 66)

7. FOLDER SEARCH buttons (←, →) P. 15

During MP3 playback, layered CD-ROM folder search will be performed in the designated direction.

8. CUE/LOOP CALL buttons (◀, ▶) P. 21

Use to call cue points and loop points recorded in external memory (when memory card is loaded).

9. CUE/LOOP MEMORY button P. 20

Use to record cue points and loop points to external memory (when memory card is loaded).

10. CUE/LOOP DELETE button P. 21

Use to delete cue points and loop points from external memory (when memory card is loaded).

11. EJECT UNLOCK/LOCK switch

UNLOCK: Disc is ejected when button is pressed, even if pressed during play.

LOCK: Disc cannot be ejected if button is pressed during play. Set unit to pause mode and then press button to eject disc.

12. EJECT button (▲)

When button is pressed, disc rotation stops and disc is ejected from port.

If the **EJECT UNLOCK/LOCK** switch is set to the [LOCK] position, the disc will not be ejected unless the unit is set to the pause mode before pressing the **EJECT** button.

13. JOG ADJUST dial

Use to adjust the felt resistance (light/heavy) of the jog dial when it is rotated.

14. VINYL SPEED ADJUST TOUCH/BRAKE dial

When the **JOG MODE SELECT** button is set to [VINYL], this dial determines the deceleration speed until play stops when the surface of the jog dial is pressed or the **PLAY/PAUSE** button is pressed. When the **VINYL SPEED ADJUST TOUCH/BRAKE** dial is rotated counterclockwise, play stops quickly; when the dial is rotated clockwise, play decelerates more slowly before coming to a stop.

15. VINYL SPEED ADJUST RELEASE/START dial

When the **JOG MODE SELECT** button is set to [VINYL], this dial determines the acceleration speed until full playback speed is reached when the jog dial is released or the **PLAY/PAUSE** button is pressed. When the **VINYL SPEED ADJUST RELEASE/START** dial is rotated counterclockwise, play accelerates to full speed quickly; when the dial is rotated clockwise, play accelerates more slowly before reaching full speed.

16. JOG MODE SELECT button

VINYL mode: When the surface of the jog dial is pressed during playback, play stops, and if the jog dial is then rotated, sound is produced in accordance with the degree of rotation.

- The currently set jog mode is stored in memory even when power is turned off.

CDJ mode: The above action does not occur when the jog dial is pressed.

17. VINYL indicator

Lights when jog mode is set to VINYL mode.

18. CDJ indicator

Lights when jog mode is set to CDJ mode.

19. TEMPO control range selector button (TEMPO ±6/±10/±16/WIDE)

Each time this button is pressed, the tempo adjust slider's variable range alternates between ±6 %, ±10 %, ±16 % and WIDE.

20. MASTER TEMPO button/indicator ☞ P. 16

When pressed, the master tempo function alternates ON/OFF.

21. Tempo adjust slider

When moved toward the user (+ front), the track tempo increases, and when moved away from the user (– rear), the tempo decreases.

22. Tempo reset indicator

Regardless of the position of the tempo adjust slider, this indicator lights when the tempo adjustment is at "0" (normal tempo).

23. TEMPO RESET button

Regardless of the position of the tempo adjust slider, pressing this button causes the tempo to be reset instantly to "0" (normal tempo). Pressing the button once again releases the reset.

24. Jog dial display ☞ P. 12 (71 to 75)**25. Jog dial (+FWD/–REV)** ☞ P. 16**26. Play/pause indicator**

Lights during playback, and flashes during pause mode.

27. PLAY/PAUSE button (▶/II) ☞ P. 14**28. Cue indicator** ☞ P. 14

When a cue point has been set, lights except during search. Flashes in the pause mode to show that a new cue point can be input.

29. CUE button

Cue point setting ☞ P. 15

Back cue ☞ P. 15

Cue point sampler ☞ P. 15

30. SEARCH buttons (◀◀, ▶▶) ☞ P. 14**31. TRACK SEARCH buttons (◀◀, ▶▶)** ☞ P. 15**32. Reverse indicator (REV)**

Lights when **DIRECTION** selector switch is set to reverse [REV].

33. DIRECTION selector switch (FWD/REV)

When set to [REV] (near side), reverse play is enabled. ☞ P. 19

34. HOT CUE REC MODE button ☞ P. 19

Switches the function of the **HOT CUE** button (record/call)

- Defaults to call mode when power is first turned on.

35. HOT CUE button/indicator (A, B, C) ☞ P. 19

When the indicators A, B, C light red, the hot cue point recording mode is enabled for that point. When any of the indicators A, B, C light green (HOT CUE point) or orange (HOT LOOP point), the respective call-up mode is enabled, and if the corresponding button is pressed, playback starts from the set hot cue (loop) point. When an indicator is not lighted, no hot cue (loop) point has been recorded.

Rear Panel**36. CONTROL connector**

When the accessory control cord is used to connect this connector to the corresponding CONTROL connector on a Pioneer DJ mixer, the DJ mixer can be used to control the CD player for fader start play and back cue.

Also, by connecting this connector to the CONTROL connector on another Pioneer DJ CD player, automatic relay play can be performed. ☞ P. 19

37. AUDIO OUT L, R connectors

RCA-type analog audio output jacks.

38. DIGITAL OUT connector

RCA type coaxial digital output connectors used to connect a DJ mixer or AV amplifier, CD player, etc., equipped with digital input connectors. The digital outputs here support all DJ and other functions, but only audio data is output (without subcodes; CD graphics are not supported).

39. POWER ■ OFF/■ ON switch**40. AC inlet (AC IN)**

Use the accessory power cord to connect this inlet to a standard AC power outlet.

Front Panel**41. Memory card indicator** ☞ P. 20

This indicator lights with a memory card is loaded and the door is closed, and flashes during memory card access.

- Do not open the door or turn off power while the indicator is flashing.

42. Memory card door and slot ☞ P. 20**43. Forced eject hole** ☞ P. 13**44. Disc loading slot** ☞ P. 13

Display Section

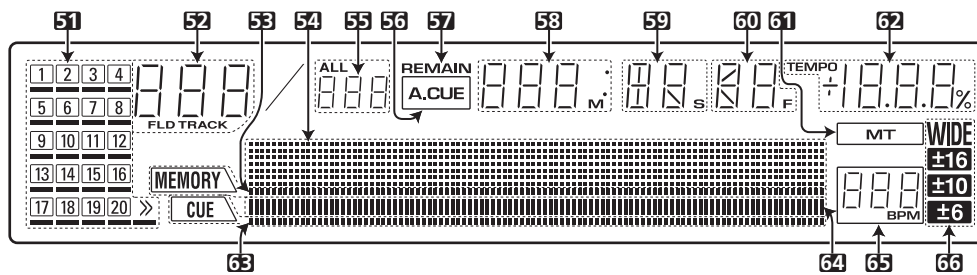

51. Calendar display (1 to 20, >>)

The tracks following the currently playing track are lighted. If more than 21 following tracks are set, the >> indicator will light. An underline appears underneath track numbers for which cue points or loops have been set.

52. Track number/folder number display (TRACK/FLD)

When playing an audio CD, the [TRACK] indicator lights, and the two-digit track number appears (01 to 99).

When playing MP3, [TRACK] lights and the track number is displayed (01 to 999). During folder search, the [FLD] indicator lights, and a two-digit folder number is displayed (00 to 99).

53. MEMORY display

If the currently selected track includes cue memory or loop memory, the [MEMORY] indicator lights and the MEMORY display indicates the relative starting position of the cue or loop. Two dots are used to display 1 point, and even if multiple starting positions are included within a single point, only one point is displayed.

54. Dot matrix display (100x7 dots)

The dot matrix is used to display TEXT, WAVE, guides and other information. Text up to 48 characters can be displayed (text longer than 16 characters is scrolled). P. 17

When WAVE display is used, the entire track is scaled so as to fit into the width of the display (100 dots width), with playback level shown across the display.

55. ALL track number display

When playing an audio CD, this display shows the total number of tracks on the disc. During MP3 playback, the number of tracks inside the folder is shown.

56. Auto cue indicator (A.CUE)

Lights when auto cue is ON.

57. REMAIN indicator

This indicator lights to indicate that track's remaining time is being displayed.

58. Time (minutes) display (M)

59. Time (seconds) display (S)

60. Frame display (F)

Seventy-five frames equal one second.

61. Master tempo indicator (MT)

Lights when the master tempo function is ON.

62. TEMPO display

Displays change in playing speed (tempo) caused by movement of the tempo adjust slider.

63. CUE point indicator

When a point is recorded in the CUE button or LOOP IN button for the currently selected track, the [CUE] indicator lights and the point's relative starting position is shown in the display (2 lighted dots).

64. Playing address display

To provide a quick grasp of the current track's elapsed time and remaining playing time, the entire track is shown as a bar graph scaled over the entire width of the display.

- During elapsed time display, the bar graph's indicator segments turn on from left to right.
- During remaining time display, the bar graph indicator segments turn off from left to right.
- When a track has less than 30 seconds of remaining play time, the graph flashes slowly; when less than 15 seconds remain, the flashing becomes quicker.

65. BPM display (0 to 360 BPM)

This display shows the Beats-Per-Minute (BPM) of the currently playing track (detection range 70 to 180 BPM). The automatic BPM counter may be unable to compute the correct BPM for some tracks.

66. Tempo control range display (±6, ±10, ±16, WIDE)

Displays the variable range of the tempo adjust slider as selected with the tempo control range selector button.

Jog dial display

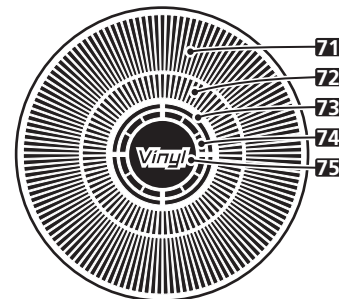

71. Operation display

This display shows the relative playing position, with one revolution equivalent to 135 frames. During playback, the display rotates, and it stops during pause mode.

72. Cue point position indicator

Indicates position of cue points.

73. Audio memory status indicator

This indicator flashes during audio memory write, and lights when writing has been sufficiently completed. When the indicator is flashing, it may not be possible to record real time cue points, or hot cue points. The indicator also flashes when memory insufficiency occurs due to scratch operation.

74. Jog touch detection indicator

In VINYL mode, this indicator lights to indicate that the jog dial surface has been touched.

75. VINYL mode indicator

Lights during VINYL mode.

Loading and Removing Discs

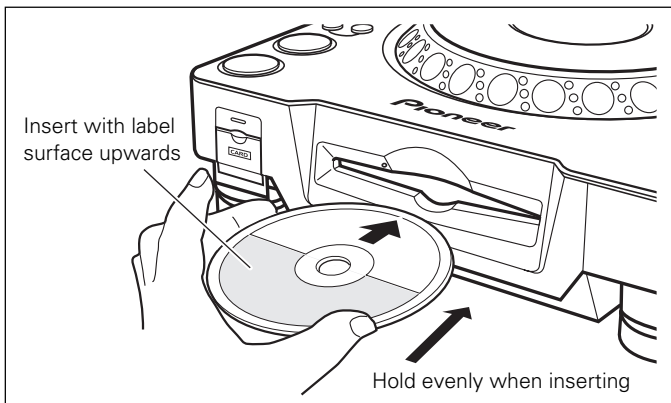

1. Set the rear panel POWER switch to ON.

Do not attempt to force a disc into the slot when the POWER switch is turned OFF, since the disc or loading mechanism may be damaged.

2. Insert the disc into the loading slot.

- Hold the disc with label surface upwards and insert evenly into the front-panel disc loading slot.
- When using 8 cm discs, place the disc into an adapter first.

This unit spins at high speed to provide high performance. When playing 8 cm discs with an adaptor, for safety reasons the rotation speed is reduced as a result scratch and reverse speeds will be lower.

- Only one disc can be loaded at a time. Do not attempt to load two or more discs simultaneously, or to load a second disc when another disc is already loaded.
- When loading a disc, do not apply bending force on the disc, or attempt to force the disc into the mechanism. Also, when the loading mechanism begins to pull the disc into the player or to eject a disc, do not attempt to forcibly override the mechanism's movement, since the disc or loading mechanism may be damaged.

3. When the EJECT UNLOCK/LOCK switch is set to [UNLOCK], press the EJECT (▲) button to eject a loaded disc. If the EJECT UNLOCK/LOCK switch is set to [LOCK], during playback press the PLAY/PAUSE (▶/II) button to first stop the disc, then press the EJECT (▲) button. If a cue point has been set, during playback press the CUE button to initiate back cue, then press the EJECT (▲) button to eject the disc.

- When the button is pressed, disc rotation will stop and the disc will be ejected partway from the loading slot.

Note:

Do not attempt to press the disc back into the slot while the [EJECT] indicator is lighted. If the disc is pressed back in while the [EJECT] indicator is lighted, the loading mechanism may stop. In this case, press the EJECT (▲) button again, and do not attempt to reload the disc until the [EJECT] indicator has turned OFF.

Precautions when playing 8 cm CD singles

- ① When playing 8 cm CD singles, be sure to use an adapter designed for 8 cm CDs. Before loading the disc into the player, confirm that the disc is fastened correctly by the adapter's tabs. If an 8 cm disc is loaded by mistake without an adapter, immediately press the EJECT (▲) button and remove the disc. If the disc is not ejected the first time the EJECT (▲) button is pressed, press the button again.
- ② Use only 8 cm disc adapters that feature the  logo mark (recommended compatible adapters). When mounting the disc to an adapter, confirm that the disc is able to rotate freely, and is not bent or warped.

Forced eject function

If a disc fails to be ejected when the EJECT (▲) button is pressed or otherwise when you cannot remove a disc, insert the provided pin into the forced eject hole at the front of the player (see illustration) and press to eject the disc. When using the forced eject function, be sure to following the accompanying precautions.

- ① Turn off the player's power and wait for at least one minute.



Attempting the forced eject function immediately after turning off the power may cause the following dangers:

- The disc may be ejected while still rotating, resulting in personal injury.
- The disc may be damaged due to the disc clamp's rotating in an unstable condition.

- ② Use only the provided accessory pin for this procedure (do not use other pointed objects). **The forced eject pin is located on the bottom surface of the player.**

When the accessory pin is inserted **fully** into the forced eject hole, the disc will be ejected from the loading slot by about 5 mm to 10 mm. It can then be grasped with the fingers and removed.

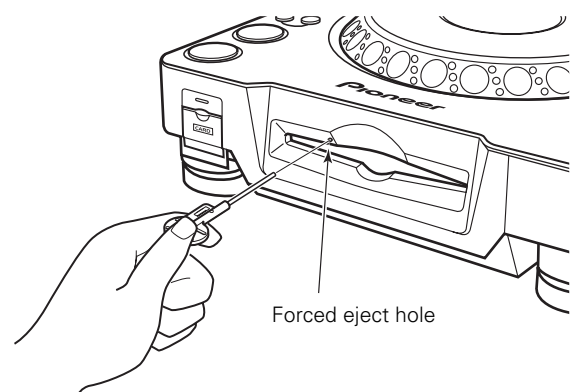

DJ Player Operation

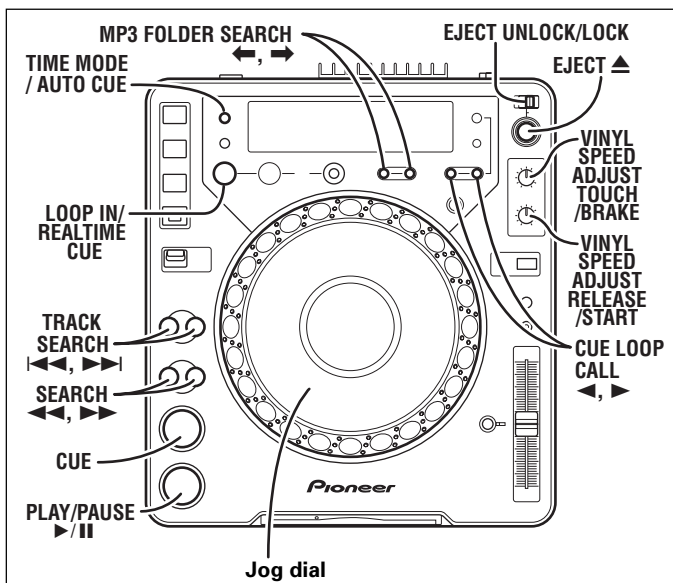

Auto cueing

This function automatically sets the cue point (see P. 15) just before actual sound begins when a disc is loaded, or when performing track search or changing tracks.

If the search continues for ten seconds without finding the point, the cue point is set at the track's beginning.

● Turning auto cueing on and off

Pressing the **TIME MODE/AUTO CUE** button and holding it down for a second or more causes auto cueing to be alternately turned on and off.

When AUTO CUE is on, the **[A.CUE]** indicator will be lit up.

- AUTO CUE on/off status is stored in memory and persists even when the power is turned off.
- It can change the AUTO CUE level.

■ Changing the AUTO CUE level

1. Press the **TIME MODE/AUTO CUE** button for over 5 seconds.

- The display will indicate **[A.CUE-60db]** (in the original state).

2. Press the **CUE LOOP CALL** button (◀, ▶) to change the level.

- It can choose from -36 dB, -42 dB, -48 dB, -54 dB, -60 dB, -66 dB, -72 dB and -78 dB.
- When the **TIME MODE/AUTO CUE** button is pressed or 15 seconds elapses, the level change mode is canceled.
- Even if you turn the power off, the set level will remain in memory.

Starting playback

1. Insert a disc in the player.

This unit spins discs at high speeds to provide high performance. As a result, disc loading takes a couple of seconds.

2. If auto cueing is on, press the **PLAY/PAUSE** button (▶/||).

- Press the **PLAY/PAUSE** button only after the current time lights in the display. The silent portion at the beginning of the displayed track will be skipped and playback will begin instantaneously from the first bars of the track.
- When jog mode is set to **[VINYL]**, the playback may accelerate slowly until it reaches full speed. (see "To pause playback").

When one track's playback ends, the next track is cued. The cue indicator (the outer ring on the **CUE** button) lights, and the outer ring on the **PLAY/PAUSE** button flashes to indicate the unit is in the play standby mode.

When the **PLAY/PAUSE** button (▶/||) is pressed, the next track begins its playback.

If auto cueing is off, playback will begin automatically from the first track.

- When auto cueing is off, playback will continue after the first track has been played, with all subsequent tracks being played in sequence.

To stop playback

1. Press the **EJECT** button (▲) when the **EJECT UNLOCK/LOCK** switch is set to **[UNLOCK]**.

When the **EJECT UNLOCK/LOCK** switch is set to **[LOCK]**, press the **PLAY/PAUSE** button (▶/||) during playback, or when a Cue point has been set, press the **CUE** button (back cue) before pressing the **EJECT** button (▲) to eject the disc.

- Playback will stop and the disc will be ejected.
- Note that the CDJ-1000MK3 does not come with a stop button.

Resume function

- When the **EJECT UNLOCK/LOCK** switch is in the **[UNLOCK]** position, even if the **EJECT** button is pressed by mistake, if the **PLAY/PAUSE** button is pressed quickly (before the **[EJECT]** indicator lights in the display), the unit will revert to the status it was in before the **EJECT** button was pressed. However, the audio output will stop during that time.
- Following disc eject, if the same disc is reinserted, the unit will return to the same status it was in before the disc was ejected (with exception of loop).
- Following disc eject, if the **FOLDER SEARCH** button (◀, ▶) or **TRACK SEARCH** button (◀◀, ▶▶) is pressed, the resume function will be canceled.

To pause playback

During playback, press the **PLAY/PAUSE** button (▶/||).

- The outer rings of the **PLAY/PAUSE** button and **CUE** button will flash, and playback will be interrupted.
- If the **PLAY/PAUSE** button is pressed again, the button's outer ring will light and playback will resume.
- In **CDJ** mode, broken playback sound will be output even during pause. If you wish for no sound to be output, lower the output level of the audio mixer.
- In **VINYL** mode, setting the **VINYL SPEED ADJUST TOUCH/BRAKE** dial modifies the speed of deceleration until playback reaches full pause. Rotating the dial clockwise causes the disc to decelerate slowly before the pause.
- In **VINYL** mode, setting the **VINYL SPEED ADJUST RELEASE/START** dial modifies the speed at which the disc accelerates when pause is released until reaching full playback speed. Rotating the dial clockwise causes the disc to accelerate more slowly to full speed.
- After setting the unit to pause, if no subsequent operation is performed for 100 minutes, the disc rotation will automatically stop. In this event, pressing the **PLAY/PAUSE** button will cause playback to resume.

Fast forward/Fast reverse

Press one of the **SEARCH** buttons (◀◀, ▶▶) during playback.

Press and hold the ▶▶ button for fast forward the disc; press and hold the ◀◀ button for fast reverse.

- When playing MP3, fast forward/fast reverse are supported only for tracks inside the same folder.
- When playing MP3, fast forward/fast reverse times may be slower depending on the track.

■ Super-fast search

Rotate the jog dial while pressing one of the **SEARCH** buttons (◀◀, ▶▶).

- Hold down one of the **SEARCH** buttons (◀◀, ▶▶) while turning the jog dial in the desired direction to enter super-fast forward or super-fast reverse mode.
- The speed of the search operation varies in response to the speed at which the jog dial is turned.
- During super-fast search, the search direction is determined by the direction the jog dial is turned. The direction of the pressed **SEARCH** button (◀◀, ▶▶) is ignored.
- When the jog dial rotation stops, the unit returns to playback mode.
- When the **SEARCH** button (◀◀, ▶▶) is released, super-fast search is canceled.
- When playing MP3, fast forward/fast reverse is supported only tracks inside the same folder.
- When playing MP3, fast forward/fast reverse times may be slower depending on the track.

Track search

Press one of the **TRACK SEARCH** buttons (◀◀, ▶▶).

- Each time the button is pressed, the track search is performed in the direction corresponding to the arrow on the button (during playback of a track, to return to the beginning of the preceding track, press the ◀◀ button twice). During playback of MP3s, the first track found in the direction pressed will be searched, and only those tracks inside the same folder are searched. If folder search is not performed when a CD-ROM is inserted, the tracks in the root directory only are searched. In cases in which there are no tracks in the root directory, playback will start from the track with the lowest number in the folder.
- When the button is held depressed, track search is performed continuously. If the button is held depressed for two seconds or more, the search speed increases.
- By pressing the ◀◀ button twice at the beginning of the first track (Track No.1), the last track will be searched. During playback of MP3s, when the ◀◀ button is pressed at the track with the lowest number, the last track in the same folder will be searched.
- By pressing the ▶▶ button at the last track, the first track (Track No.1) will be searched. During playback of MP3s, when the ▶▶ button is pressed at the last track, the track with the lowest number in the same folder will be searched.

■ Super-fast track search

Rotate the jog dial while pressing one of the **TRACK SEARCH** buttons (◀◀, ▶▶).

- To perform super-fast track search, hold the button depressed while rotating the jog dial in the direction you wish to perform the search; super-fast track search will be performed in proportion to the degree of jog dial rotation.
- During super-fast track search, the search direction is determined by the direction of rotation of the jog dial. The direction of the pressed **TRACK SEARCH** button is ignored.
- When the **TRACK SEARCH** button is released, super-fast track search is canceled.

Folder search (MP3 only)

Folder search is used when searching tracks in a CD-ROM with folder layers.

Press one of the **FOLDER SEARCH** buttons (←, →).

- Every time the **FOLDER SEARCH** button is pressed, the folders will be skipped to the specified direction. The root directory is displayed as folder number [00], folder name [ROOT].
- By holding either of the **FOLDER SEARCH** buttons depressed, folders will be searched continuously. If the button is held for two seconds or more, the search speed increases.
- When reverse search is performed from the lowest-numbered folder, the last folder will be searched.
- When forward search is performed from the last folder on the disc, the lowest-numbered folder will be searched.
- Folders with no playable tracks (empty folders) will be ignored, and the next folder will be searched.

■ Super-fast folder search

Rotate the jog dial while pressing one of the **FOLDER SEARCH** buttons (←, →).

- By turning the jog dial in the intended search direction while pressing either of the **FOLDER SEARCH** buttons, folder numbers will be searched corresponding to the direction of rotation of the jog dial.
- During super-fast folder search, the search direction is determined by the direction the jog dial is rotated. The direction indicated by the pressed **FOLDER SEARCH** button is ignored.
- When the **FOLDER SEARCH** button is released, super-fast folder search is canceled.

Cue point settings

Once a cue point has been stored in memory, during playback it can be used to place the player in a state where it is ready to begin playback from the cueing position by pressing the **CUE** button.

■ Setting the cue point in the CDJ mode

1. **During playback, press the PLAY/PAUSE button (▶/||) to pause playback at the point you wish to begin playback.**

2. **Search for the precise position of the cue point.**

● Using frame numbers to specify cue points.

Cue points may be specified in 1-frame units (where 75 frames are equivalent to 1 second).

Use the jog dial or the **SEARCH** button (◀◀, ▶▶) to advance frames. One rotation of the jog dial is equivalent to 135 frames; when the **SEARCH** button is pressed, the player advances 1 frame in the specified direction.

● Listen to the sound at the current frame to determine the cue point.

Turn the jog dial slowly and then return it to just before the point from which you wish to begin playback. (The cue point thus defined will consist of that point directly after the sound which can be heard during a cueing pause.)

3. **Press the CUE button when you reach the desired frame number or hear the sound at the point from which you wish to begin cueing.**

- The sound will mute and the current time will appear in the display, indicating that the cue point has been stored to memory.
- When a new cue point is stored in memory the previous setting will be erased.

[Amending the cue point]

1. **During playback, press the CUE button.**

- The player will return to the specified cue point.

2. **Press one of the SEARCH buttons (◀◀, ▶▶) to set to audible pause mode.**

3. **In the CDJ mode, to set the cue point, go through steps 2 and 3 as mentioned above.**

■ Setting the cue point in the VINYL mode

1. **During playback, when playback reaches the desired cue point, either press and hold the surface of the jog dial, or press the PLAY/PAUSE button (▶/||) to pause playback.**

2. **While continuing to press the surface of the jog dial, rotate it to return playback to the audio point just before the point you wish playback to begin.**

3. **When the audio is at the desired cue point, press the CUE button while continuing to press on the surface of the jog dial.**

- Cue point memory setting is completed when the current time lights in the display.

- When a new cue point is stored in memory the previous setting will be erased.

[Amending the cue point]

1. **During playback, press the CUE button.**

- The player will return to the specified cue point.

2. **In the VINYL mode, to set the cue point, go through steps 2 and 3 as mentioned above.**

- The **SEARCH** buttons (◀◀, ▶▶) can now be used to modify the cue point, in the same way as for the CDJ mode.

■ Realtime cue

During playback, press the LOOP IN/REALTIME CUE button at the desired cue point.

- This point will then be recorded as the new cue point.

■ Checking cue points (Cue point sampler)

After setting a cue point, hold the CUE button depressed.

- As long as the **CUE** button is held depressed, the sound at the set cue point can be heard.
- During cue point sampler, if the **CUE** button is released, back cue will be performed to the set cue point.
- In the case of MP3, cue point sampler can be performed only within the same folder.

■ Returning to a Cue point (Back cue)

1. **During playback, press the CUE button.**

- The player will return to the specified cue point.

2. **Press the PLAY/PAUSE button (▶/||).**

- Playback will begin immediately from the specified cue point.
- In the case of MP3, back cue can be performed within the same folder. So long as the cue point is not overwritten, it will remain in memory after folder search as well.

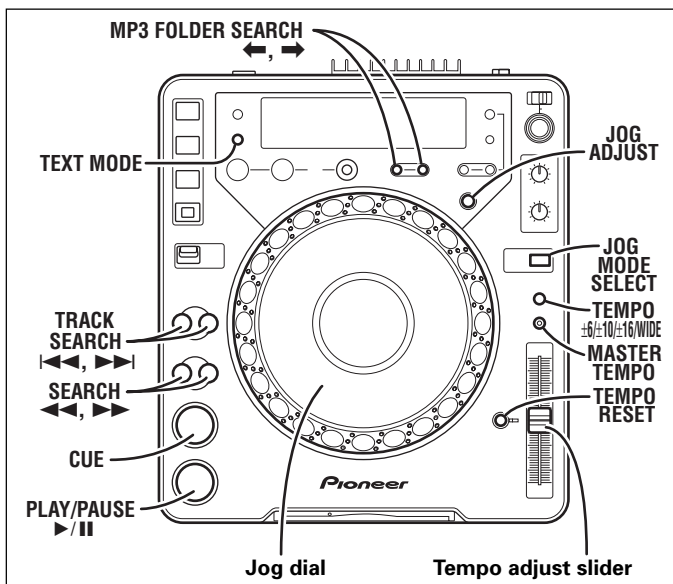

To change the playing speed

Move the tempo adjust slider forward or back.

When moved toward the user (+) the playing speed (tempo) becomes faster, and when moved away (-) the playing speed becomes slower.

- The degree of change in tempo is shown on the display.
- Even when changing the tempo, the pitch (key) can be kept stable (see section below, "Applying master tempo").

Selecting the range of tempo adjustment

Press the TEMPO ±6/±10/±16/WIDE button.

Each time the button is pressed the tempo adjust slider's variable range alternates in the order ±6%/±10%/±16%/WIDE. When ±6% is selected, the unit of change is 0.02%; when ±10% is selected, the unit of change is 0.05%; when ±16% is selected, the unit of change is 0.05%, and when WIDE is selected, the unit of change is 0.5%.

- The variable setting value is shown on the display.
- The variable range in the WIDE setting is as follows:
 - With CD play: ±100%
 - With MP3 play: +70% to -100%
- When power is first turned on, the setting defaults to ±10%.
- At -100%, playback stops.

Tempo Reset

Press the TEMPO RESET button.

The tempo reset indicator lights and the tempo change ratio becomes "0" (normal tempo) regardless of the position of the tempo adjust slider.

- If the TEMPO RESET button is pressed again, the reset is canceled (tempo change ratio reverts to that set with the tempo adjust slider).
- When power is first turned on, this function defaults to OFF.

Applying master tempo

Press the MASTER TEMPO button during playback.

The MASTER TEMPO button and the [MT] indicator light. The speed (tempo) can now be changed using the tempo adjust slider but the pitch (key) does not change.

- Sound quality will be degraded when subjected to digital processing.
- When power is first turned on, this function defaults to OFF.

Jog dial functions

1. Pitch bend: Rotate jog dial during playback.

(When the jog mode is set to [VINYL], touch only the sides of the jog dial. If the top surface is touched a different function is performed.)

- In proportion to the amount of rotation, the playback speed is accelerated (FWD+) or decelerated (REV-). When in the reverse mode, the playback speed accelerates when the dial is rotated in the REV- direction, and decelerates when rotated in the FWD+ direction.
- When dial rotation is stopped, playback reverts to the previous speed.

2. Scratch play: Rotate jog dial during playback.

See "Scratch play" in the Advanced Operations.

3. Frame search: Rotate jog dial during pause.

When jog mode is set to [CDJ], the audible pause mode is enabled and when set to [VINYL], inaudible pause is performed; the CD audio is played at a speed corresponding to the speed of jog dial rotation.

- The pause position will change in units of 1 frame.
- One rotation of the jog dial corresponds to 1.8 seconds of CD playback (135 frames).

4. Spin play: Rotate jog dial during playback or pause.

See "Spin play" in the Advanced Operations.

5. Super-fast search: Rotate jog dial during playback, while holding SEARCH button depressed.

To perform high-speed search, hold the SEARCH button (◀◀, ▶▶) depressed while rotating the jog dial in the desired direction of search; high-speed search will be performed in proportion to the degree of jog dial rotation.

- The speed of the search operation varies in response to the speed at which the jog dial is turned.
- The search is performed in the direction of jog dial rotation, without regard to which SEARCH button is pressed.
- When dial rotation is stopped, playback returns to normal.
- When the SEARCH button is released, this mode is canceled.
- When playing MP3, fast forward/fast reverse can be performed only within the same folder.

6. Super-fast track search: Rotate jog dial while holding TRACK SEARCH button depressed.

To perform high-speed track search, hold the TRACK SEARCH button (◀◀, ▶▶) depressed while rotating the jog dial in the desired direction of search; high-speed track search will be performed in proportion to the amount of jog dial rotation.

- The search is performed in the direction of jog dial rotation, without regard to which TRACK SEARCH button is pressed.
- When the TRACK SEARCH button is released, this mode is canceled.
- When playing MP3, search is performed only within the same folder.

7. Super-fast folder search: Rotate jog dial while holding FOLDER SEARCH button depressed (during MP3 play).

To perform super-fast folder search, hold the FOLDER SEARCH button (◀, ▶) depressed while rotating the jog dial in the desired direction of search; super-fast folder search will be performed in proportion to the amount of jog dial rotation.

- The search is performed in the direction of jog dial rotation, without regard to which FOLDER SEARCH button is pressed.
- When the FOLDER SEARCH button is released, this mode is canceled.

Note:

The surface of the jog dial is equipped with a built-in switch; do not rest objects on the dial or subject it to strong forces. Do not set drinks on the surface, since a spill could enter the mechanism and cause malfunctions.

Jog sensitivity adjustment

By rotating the JOG ADJUST dial, the sensation of resistance felt when rotating the jog dial can be adjusted.

Rotate JOG ADJUST dial.

- When rotated clockwise, resistance increases.
- When rotated counterclockwise, resistance decreases.
- Adjust the setting within the scale's gray zone to set the jog dial sensation equivalent to that of the CDJ-1000MK2.

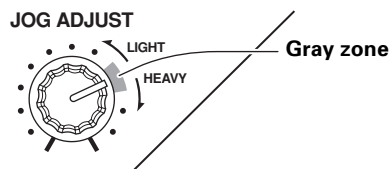

Mixing different tracks

(Example: Mix track B with currently playing track A from the main speakers.)

- Connect player CD1 to the DJ mixer's CH1, and connect player CD2 to CH2.
 - Raise the TRIM, CHANNEL FADER, and MASTER LEVEL settings appropriately so that sound is produced from player CD1.
1. **Set the DJ Mixer's CROSS FADER slider at its left side (CH1).**
 - Track A is heard from speakers.
 2. **Load a CD on player CD2.**
 3. **Press the TRACK SEARCH buttons (◀◀, ▶▶) on player CD2 to find and select track B.**
 4. **Set the DJ Mixer's MONITOR SELECTOR button CH2 to ON.**
 5. **Rotate the DJ Mixer's MONITOR LEVEL so that track B can be heard from the headphones.**
 - Only track A is heard from the main speakers.
 6. **Set cueing for track B on the headphones.**
 - ① With player CD2 in the playback mode, press the **PLAY/PAUSE** button (▶/||) to hear the point you wish to cue.
 - When the jog mode is set to [CDJ], the unit will enter audible pause mode (sound can be heard); when set to [VINYL], the unit will enter inaudible pause mode (no sound can be heard).
 - ② Rotate player CD2's jog dial and search for the track's cue point (first beat).
 - ③ When you have settled on the cue point, press the **CUE** button on player CD2.
 - The player's sound will be muted and cueing will be completed.
 7. **Simultaneously press player CD2's PLAY/PAUSE button (▶/||) when track A is heard from the speakers.**
 - Only track A will be heard from the main speakers.
 - Track B will be heard from the headphones.
 8. **Move the tempo adjust slider to match the tempo (BPM=Beat Per Minutes) of tracks A and B.**

Move the tempo adjust slider of player CD2 so that the BPM of track B matches those of track A.

 - When the two BPM rates match, the BPM synchronization is complete.
 9. **Press the CUE button on player CD2.**
 - Player CD2 will enter pause mode at the cue point.
 10. **As soon as track A is heard from the speakers, press the PLAY/PAUSE button (▶/||) on player CD2.**
 - Track B begins playing.
 11. **While checking the sound on the headphones, gradually move the DJ Mixer's CROSS FADER slider from left to right side (CH2).**
 - The sound of track A from the speakers will steadily become mixed with the sound of track B.
 - When the DJ Mixer's CROSS FADER slider has moved all the way to the right side, the sound heard from the speaker will have changed from track A to track B, and the operation is complete.

■ Long mix play

If the BPM rates match, mixing of tracks A and B will sound good even if the CROSS FADER slider is in the middle position.

■ Fader start play

Using the cross fader start function of a Pioneer DJ mixer, step 10 above can be eliminated for even simpler mixing. In addition, when the CROSS FADER slider is returned to its original position, the status returns to that in step 9 (player CD2 at its cue point), so that you can repeat the same play as many times as you like.

About the WAVE display

The WAVE display shows the changes in a track's bass beat (bass drum, etc.), thus allowing the DJ to understand where breaks and end points come in the track. When the **TEXT MODE** button is set for WAVE display, the selected track is shown rescaled to fit within the full range (100 points) of the display.

- After a track change, some time is required before the entire track's WAVE display can be shown. By prerecording desired tracks' WAVE patterns on a memory card, the next time the track is played its WAVE pattern can be displayed instantly (P. 21).
- If a track's low-frequency beat changes are too low in volume, the break points in the track may not be displayed properly.
- If a search or pause operation is performed during the time the waveform is being read, the waveform will not be displayed properly.
- Read-ahead of the WAVE pattern is not possible during MP3 playback.

About TEXT display

When the **TEXT MODE** button is used to select TEXT display, the display shows CD-TEXT, including the names of tracks, albums, and artists. During MP3 playback, the display shows ID3 tag track name (if no ID3 tag is recorded, the display shows the file name) /ID3 tag album name/ ID3 tag artist name.

- Each item can display up to 48 characters of text; text longer than 16 characters is scrolled.
- Text may include alphanumeric characters and some symbols.
- If no text is available, the [NO TEXT] message will be displayed.

When a track name is selected in TEXT display, the [♪] icon will be displayed followed by the track name (with MP3, the ID3 tag's title name or file name will be displayed).

Also, during MP3 play, the bit rate will be displayed following the track name.

♪ CDJ-1000MK3 [128 Kbps]

When an album name is selected in TEXT display, the [🎧] icon will be displayed followed by the album name.

🎧 Pioneer

When an artist name is selected in TEXT display, the [👤] icon will be displayed followed by the artist's name.

👤 Pioneer PRO DJ

When folder search is performed with MP3, the folder name is displayed during the search.

Pioneer DJ

Advanced Operations

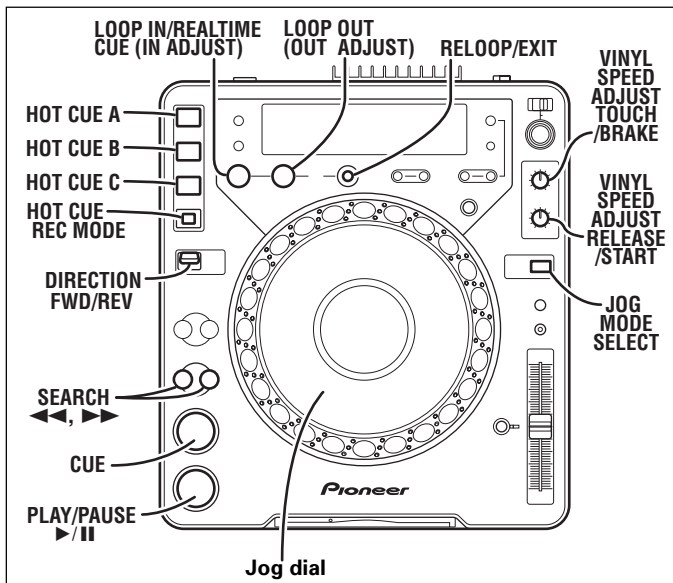

Scratch play

When jog mode is set to [VINYL], pressing the top surface of the jog dial and turning it causes playback to occur in proportion to the speed and direction of jog dial rotation.

1. Press the **JOG MODE SELECT** button so the [VINYL] indicator lights.
2. During playback, press the top surface of the jog dial.
 - Playback will slow and stop (the deceleration time until full stop ["response characteristics"] can be set separately). If the jog dial is rotated before playback decelerates to full stop, sound will stop, and playback will then be performed in response to the direction and speed of jog dial rotation in step 3.
3. Rotate the jog dial in the direction and at the speed you wish playback to be performed.
 - Playback will be heard in the direction and speed proportional to the jog dial rotation.
4. Remove hand from jog dial.
 - Playback will either acceleration or decelerate to return to its status before the jog dial was touched (the acceleration/deceleration time until playback returns to its previous condition ["response characteristics"] can be set separately).

How to set the deceleration response characteristics (time required for playback to decelerate to full stop when jog dial surface is pressed):

Rotate the VINYL SPEED ADJUST TOUCH/BRAKE dial.

- This dial allows you to adjust the slowdown in speed (response characteristics) until playback stops.
- This is the same setting as the deceleration speed adjustment used when the **PLAY/PAUSE** button (▶/⏸) is pressed in VINYL mode to temporarily pause playback (P. 14).

How to set reacceleration response characteristics (time required for playback to return to previous speed when hand is removed from jog dial surface):

Rotate the VINYL SPEED ADJUST RELEASE/START dial.

- This dial allows you to adjust the slowdown or increase in speed until playback returns to normal playback (response characteristics).
- This is the same setting as the acceleration speed adjustment used when the **PLAY/PAUSE** button (▶/⏸) is pressed in VINYL mode to resume playback (P. 14).

Spin play

During playback in **VINYL** mode, either press the surface of the jog dial or press the **PLAY/PAUSE** button (▶/⏸) to pause playback, then rotate the jog dial quickly; playback will occur in the direction and at a speed proportional to the direction and speed of jog dial rotation, even if you then release your hand from the jog dial.

Braking

- During playback in **VINYL** mode, if the **PLAY/PAUSE** button (▶/⏸) is pressed to pause playback, the sound decelerates at the braking speed set with the **VINYL SPEED ADJUST TOUCH/BRAKE** dial.
- When the **PLAY/PAUSE** button (▶/⏸) is pressed once again to resume playback, the sound accelerates at the speed set with the **VINYL SPEED ADJUST RELEASE/START** dial.

Loop playback

Defining a loop

1. Press the **PLAY/PAUSE** button (▶/⏸) to begin playback.
2. During playback or pause, press the **LOOP IN/REALTIME CUE** button.
 - This operation is not required if a prerecorded cue point has already been set as the loop start point.
3. When playback reaches the desired loop-out point, press the **LOOP OUT** button.
 - Playback will begin between the loop-in and loop-out points.
 - During MP3, the loop can be set only between points set within the same track.
 - When the loop has been set, the **RELOOP/EXIT** button lights.

To cancel a loop

During loop playback, press the **RELOOP/EXIT** button.

- When the playback reaches the loop-out point, it will continue normally, without returning to the loop-in point.

To change a loop-in point

1. During loop play, press the **LOOP IN/REALTIME CUE (IN ADJUST)** button.
 - The display will show the in-point time; the **LOOP IN/REALTIME CUE** button will change to quick flashing, while the **LOOP OUT** button light will go out.
2. Press the **SEARCH** button (◀◀, ▶▶) or rotate the jog dial.
 - The loop-in point will change in one-frame increments. The permissible range for adjusting an in point is ±30 frames, and it must be set before any out point.
 - In the case of MP3, adjustment of loop positions is possible only within the same track where cue points are set.
 - Loop-in point cannot be modified during reverse play and scratch play.
 - When the **LOOP IN/REALTIME CUE** button is pressed or 30 seconds elapses, the adjustment mode is canceled and loop play resumes.

To change a loop-out point

1. During loop play, press the **LOOP OUT (OUT ADJUST)** button.
 - The display will show the out-point time; the **LOOP OUT** button will change to quick flashing, while the **LOOP IN/REALTIME CUE** button light will go out.
2. Press the **SEARCH** button (◀◀, ▶▶) or rotate the jog dial.
 - The loop-out point will change in one-frame increments.
 - The loop-out point cannot be moved to a position before the loop-in point.
 - In the case of MP3, adjustment of loop positions is possible only within the same track where cue points are set.
 - Loop-out point cannot be modified during reverse play and scratch play.
 - When the **LOOP OUT** button is pressed or 30 seconds elapses, the adjustment mode is canceled and loop play resumes.

■ To return to a loop (Reloop)

During playback after leaving a loop, press the **RELOOP/EXIT** button.

- Playback will return to the loop-in point of the previously set loop, and loop play will resume.
- In the case of MP3 playback, reloop cannot be performed to a folder different from the one currently selected.
- Reloop cannot be performed when the **RELOOP/EXIT** button is not lighted.

To perform hot cue

Up to three hot-cue points (**A, B, C**, including loop data) can be set in advance. In this way, playback can be started from either of those points instantly.

■ Setting hot-cue points

1. Press the **HOT CUE REC MODE** button so that **HOT CUE A, B, C** buttons are lighted red.
2. During playback or pause, press the desired button (**A, B, C**) at the point you wish to set as a hot cue in that button.
 - The pressed button will flash red for 2 seconds, and the position and playback header data at that point will be recorded. When the button is pressed during loop playback, the data for the currently playing loop will be recorded. The playback direction is not recorded.
 - While data is being recorded, it is not possible to record data to other **HOT CUE** buttons, input cue points, or perform search or scratch.
 - When a memory card is loaded, the newly stored hot cue points will automatically be backed up to the memory card. (P. 20)
 - If hot cue points are stored while performing scratch, the playback may temporarily stop.

■ Beginning hot cue

1. Press the **HOT CUE REC MODE** button so that the **HOT CUE A, B, C** buttons' indicators are lighted either green or orange.
 - Buttons containing hot cue points will light green.
 - Buttons containing loop data will light orange.
 - Buttons containing no hot cue points will remain unlighted.
2. During playback, pause, or cue standby, press the button (**A, B, or C**) in which the desired start point has been set.
 - Playback will start instantly based on the data set in the button.
 - When loop data has been recorded to a **HOT CUE** button, loop play will start instantly.
 - Loop data recorded in a **HOT CUE** button produces a loop independent from any loops set with the **LOOP IN/REALTIME CUE** and **LOOP OUT** buttons; the **RELOOP/EXIT** button can be used to cancel the loop, and **LOOP OUT (OUT ADJUST)** button can be used to edit the loop-out point, and those edited modifications are directly applied to the data recorded in the **HOT CUE** button.
 - In the case of MP3 playback, hot cue playback cannot be performed on any loop that overlaps multiple folders.
 - When inserting a CD or memory card, it is possible to restore the hot cue points previously recorded to the memory card (P. 21).

Reverse play

Set the **DIRECTION FWD/REV** switch to the **[REV]** position.

The **[REV]** indicator will light and playback will begin in the reverse direction.

- Playback acceleration/deceleration produced with jog dial rotation will operate in reverse.
- During reverse playback, it is not possible to create new loops or to edit loop-out points.
- If track search or loop play are performed, the audio memory status indicator (jog dial display) will flash for 1 to 2 seconds, and scratch/reverse operations may be temporarily disabled.
- In the case of MP3, reverse play that overlaps multiple folders is not possible.
- During MP3 play, reverse playback may not occur immediately with some tracks.

About fader start play

When the accessory control cord is used to connect this unit's **CONTROL** jack to the corresponding **CONTROL** jack on a Pioneer DJ mixer, moving the mixer's channel fader causes the **CUE** standby on the CD player to be released, thus instantly starting playback. The mixer's cross fader can also be used to control fader start on the player. Also, when the fader lever is returned to its original position, the player can be made to return to its cue point (back cue). For details regarding connection, (P. 8).

Relay play using two players

When the accessory control cord is used to connect the **CONTROL** jacks of this player and another Pioneer CDJ series CD player, the two players can be made to perform automatic relay play (P. 9).

- Set the two players' auto cue function to ON (the **[A.CUE]** indicator lights in the display).
 - Set your audio mixer's fader control to its center position.
1. Begin playback on the first player.
 2. When the currently playing track finishes, the second player automatically begins playback.
 3. The first player then pauses at the beginning of the its next track in the **CUE** standby mode.
 - This process is repeated automatically, alternating playback on both players.
 - By exchanging the disc on the waiting player and cueing it to a desired track, you can play a continuing series of desired tracks from different discs.
 - By setting a cue point on the waiting player, it is possible to start from playback from a specifically desired point on a track (P. 15 "Cue point settings").

Note:

- Relay play may not occur properly if both players' audio output connectors are not connected to the same audio mixer.
- If the power is disconnected to the currently operating player, the waiting player may start playback in some cases.
- Since the control cords require different connections, it is not possible to combine fader start and relay play simultaneously.

Operations Using Memory Cards

■ Using memory cards

This player supports the use of SD memory cards or MultiMedia Cards for the recording of disc identification data, cue point data, loop point data, and hot cue data.

- ★ **SD memory cards must be formatted in accordance with "SD Memory Card Specifications Part2 FILE SYSTEM SPECIFICATION Version 1.0" (commercially purchased SD memory cards are factory formatted to the above standards). Unformatted cards cannot be used (the [UNFORMAT] message will be displayed).**
- ★ **Memory cards formatted on computers or in digital cameras may not be usable with this player.**

- ★ **MultiMedia Cards (MMC) formatted on the CDJ-1000 or CDJ-1000MK2 have the following limitations:**
 - MP3 data cannot be recorded.
 - Loop data set in hot cues cannot be recorded.
 - It is not possible to use a computer to copy or backup the cards.
 - When recording loop points, a single loop point requires two points of memory area.
 - The cards cannot be reformatted in this unit.

To protect important data (SD memory card)

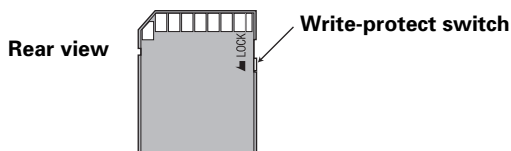

- Set the write-protect switch to the **[LOCK]** position to prevent further writing to the card. Return the switch to its original position if you wish to record further data on the card.

■ Loading a memory card

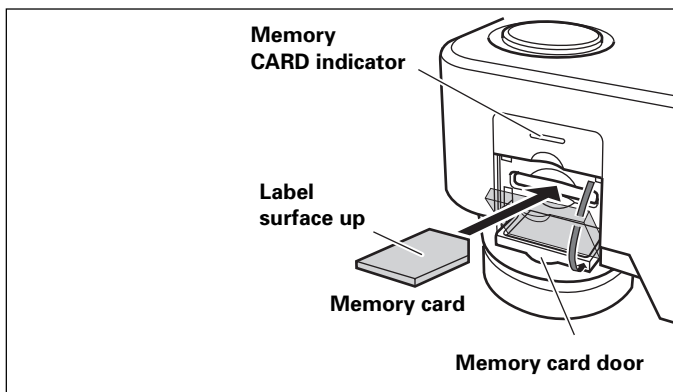

Open the memory card door, and insert the memory card, label side up and with the beveled edge toward the front. Insert the card slowly, holding it flat, and push it in until it stops. Shut the memory card door.

The display will show **[SD CARD]** (for cards conforming to the SD memory card standard) or **[CDJ CARD]** (for cards formatted with the CDJ-1000 or CDJ-1000MK2), followed by the number of discs recorded on the card.

● Removing the memory card

Open the memory card door and wait until the **CARD** indicator lamp goes out, then press in the memory card slightly and allow it to eject; grasp the end of the card and pull out carefully.

Notes:

- Do not open the card door or turn off power while the **CARD** indicator is flashing, since the recorded data may be damaged.
- Memory cards are precision electronic devices. Do not bend or drop them, or subject them to strong forces or impacts. Also, avoid using or storing memory cards in environments subject to static electricity or electrical noise.
- Memory cards can be broken when subjected to impacts or static electricity. Be very careful when handling them, and make regular backups of important recorded data (P. 21).

Pioneer disclaims any responsibility for damage to or loss of memory card data, or other incidental damages arising from such loss.

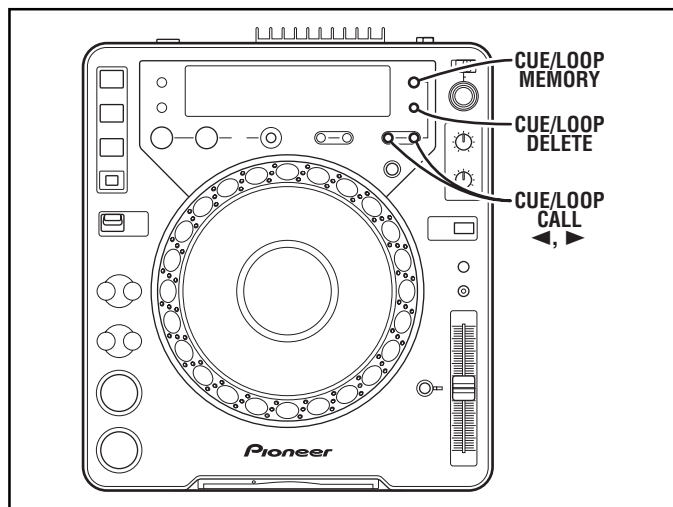

Recording to memory cards

- Up to 100 points (total of both cue and loop points) can be stored for each disc. When 100 points have been stored, attempts to record further points will result in the display of the **[POINT FULL]** message, and no further points can be recorded.
- If insufficient memory space exists on the card to record the current points, the **[CARD FULL]** message will appear.
- If the card has been set to write-protect, the **[CARD PROTECTED]** message will be displayed.

■ Recording a cue point

1. Use the auto cue function or **CUE** button to input a cue point.
2. Press the **CUE/LOOP MEMORY** button.
 - The display will show the cue point position data, and the word **[CARD MEMORY]** will appear in the display, indicating that the cue point has been stored in the memory card.
 - If no memory card is loaded, the **[NO CARD]** message will appear.
 - If the memory card door is open without any memory card being loaded, the message **[CLOSE CARD DOOR]** will appear in the display.

■ Recording a loop point

1. Set a loop-in point and loop-out point and begin loop playback.
2. During loop playback, press the **CUE/LOOP MEMORY** button.
 - The display will show the cue point position data, and the word **[CARD MEMORY]** will appear in the display, indicating that the loop-in and loop-out points have been stored in the memory card.
 - If no memory card is loaded, the **[NO CARD]** message will appear.
 - If the memory card door is open without any memory card being loaded, the message **[CLOSE CARD DOOR]** will appear in the display.

■ Recording hot cue points A, B, C

Hot cue points A, B, and C are automatically recorded on the memory card.

■ WAVE display

Wave displays are automatically recorded on the SD memory card.

To call up recorded data

■ To recall a memorized cue/loop point

When a memory card is loaded, and cue/loop point data is recorded, the calendar display and playing address display will appear red.

1. Press the CUE/LOOP CALL button.

- When the **CALL** button (▶) is pressed, the cue/loop points will be called up in order, beginning with the one closest to the beginning of the disc, and the unit will enter pause mode at the cue/loop in point.

2. Press the PLAY/PAUSE button (▶/II).

- Play/loop play will begin.

■ To recall a memorized hot cue point

Hot cue points A, B, and C are recorded automatically on the memory card. If hot cue points are recorded at the time a disc is inserted, the **HOT CUE** buttons **A**, **B**, **C** will flash green or orange. To call up one of the recorded hot cue points, press the corresponding button **A**, **B**, or **C**. The flashing green or orange indicator will light steadily (sound will not begin instantly when the call is made). If you have no need of calling one of the hot cue points, press the **HOT CUE REC MODE** button. The indicators will change to red, and the hot cue setting mode will be enabled. (To subsequently call up one of the hot cue points previously recorded on the memory card, remove the disc or memory card and reinsert it so that the **A**, **B**, and **C** buttons flash once again. Then press the desired flashing button).

■ WAVE display

When playing a track with which you have previously used the WAVE display function, the recorded WAVE pattern will automatically be recalled and displayed.

To delete information recorded on memory cards

■ To delete individual cue/loop points

1. Press the CUE/LOOP CALL button.

- When the **CALL** button (▶) is pressed, the cue/loop points will be called up in order, beginning with the one closest to the beginning of the disc, and the unit will enter pause mode at the cue/loop in point.

2. Press the CUE/LOOP DELETE button at the cue/loop point you wish to delete.

- The display will show the [DELETE] message, and the selected cue point or loop point data will be erased from the memory card.

■ To delete all cue/loop point information for an entire disc

1. Load the disc whose cue/loop point information you wish to erase.

2. Hold the CUE/LOOP DELETE button depressed for 5 or more seconds.

- The display will scroll the [DISC DELETE? PUSH MEMORY] confirmation message.

3. Press the CUE/LOOP MEMORY button.

- All cue and loop data for the loaded disc will be deleted from the memory card.
- If any button other than the **CUE/LOOP MEMORY** button is pressed, the delete mode will be canceled.

■ To delete all memory card data

1. With no disc loaded, hold the CUE/LOOP DELETE button depressed for 5 seconds or more.

- The display will scroll the [ALL DELETE? PUSH MEMORY] confirmation message.

2. Press the CUE/LOOP MEMORY button.

- All data will be deleted from the memory card.
- If any button other than the **CUE/LOOP MEMORY** button is pressed, the delete mode will be canceled.

To copy memory card data

1. With no disc or memory card loaded:

Hold the **CUE/LOOP MEMORY** button pressed for 5 seconds or more.

- The display will scroll the [COPY MODE] [CARD A IN] messages.

2. Insert the original source memory card into the memory card slot.

- The display will show the [READING] message; after several minutes, the [CARD B IN] message will appear.

3. Remove the source card and insert the target memory card.

- Be sure to delete earlier contents of the target card to provide sufficient recording capacity.
- The display will show the [WRITING] message, and after several minutes, the [CARD A IN] message will appear.

4. Remove the target card, and once more insert the original source card.

- The display will show the [READING] message; after several minutes, the [CARD B IN] message will appear.

5. Repeat steps 3 and 4 as required.

- The copying process is completed when the display shows the [COMPLETE] message.
- Copying of a full 32 MB SD memory card will require a maximum of 4 cycles of recording steps 3 to 4.
- If the target card has insufficient memory capacity to complete the copying process, the [CAPACITY ERROR] message will appear.

- If you possess a computer with memory card reader/writer, the reader/writer can be used to copy your SD memory cards. (MultiMedia Cards formatted on the CDJ-1000 or CDJ-1000MK2 cannot be copied using a computer.)

ⓘ P. 20, precautions regarding memory card formatting.

Display during recording of cue and loop points

Display Message	Meaning
[CARD MEMORY]	Cue point or loop point has been successfully stored in the memory card.
[CANNOT MEMORIZE ON THIS CARD]	Displayed during MP3 playback when a card formatted on the CDJ-1000 or CDJ-1000MK2 has been loaded and recorded operations are performed. Point data cannot be recorded to the card.
[CARD FULL]	Insufficient space remains on the memory card. Point data is not recorded to the card.
[CARD PROTECTED]	The memory card's LOCK (write protect) function is enabled, and point data cannot be written to the card.
[INTERNAL MEMORY] followed by [NO CARD]	No memory card is loaded.
[INTERNAL MEMORY] followed by [CLOSE CARD DOOR]	A memory card is loaded, but the memory card door has not been closed. Close the door and retry.
[UNFORMAT]	The loaded memory card does not conform to SD memory card standards, or to CDJ-1000, CDJ-1000MK2 (MMC) formatting standards. Point data cannot be recorded to the card.
[CARD ERROR]	The loaded memory card appears to be damaged.
[POINT FULL]	The total number of recorded cue points and loop points has reached 100.

Insert memory card when recording cue point data, loop point data, hot cue data, or WAVE data. If no memory card is loaded, point data will be lost in the event the power is turned off or the current disc is removed.

Troubleshooting

Incorrect operations can be mistaken as malfunctions. If you believe the unit is not operating correctly, consult the chart below. Sometimes incorrect operation may be due to a malfunction in another component. If the problem is not fixed, check the other components used with the player. If the problem still persists, contact your nearest Pioneer authorized service center or dealer for service.

Symptom	Probable Diagnosis	Remedy
Disc doesn't eject even when EJECT button (▲) is pressed.	<ul style="list-style-type: none"> ● Power plug is disconnected from outlet. ● The EJECT UNLOCK/LOCK switch is set to the [LOCK] position. 	<ul style="list-style-type: none"> ● Connect plug to wall outlet. ● Go to pause mode or cue standby mode before pressing the EJECT button (▲). ● Set the EJECT UNLOCK/LOCK switch to the [UNLOCK] position before pressing the EJECT button (▲).
Play doesn't commence even when the disc is inserted.	<ul style="list-style-type: none"> ● The auto cue function is set to on. 	<ul style="list-style-type: none"> ● Hold down the TIME MODE/AUTO CUE button for 1 second or longer to turn off the auto cue function.
Playback immediately stops when started.	<ul style="list-style-type: none"> ● Disc is loaded upside down. ● Smudges on the disc, etc. 	<ul style="list-style-type: none"> ● Load the disc correctly with the label side up. ● Clean the smudges from the disc.
MP3 can't be played.	<ul style="list-style-type: none"> ● Format is wrong. 	<ul style="list-style-type: none"> ● See section "Playing MP3 files" on page 6.
Can't search for MP3 tracks.	<ul style="list-style-type: none"> ● You attempted to search (fast forward/reverse) for files in a different folder. 	<ul style="list-style-type: none"> ● MP3 searches can be performed only within the same folder.
No sound is audible.	<ul style="list-style-type: none"> ● Output cables are connected incorrectly or are loose. ● Incorrect operation of audio mixer. ● Pin plugs and/or terminals are dirty. ● Player is in pause mode. 	<ul style="list-style-type: none"> ● Recheck connections. ● Check the settings of the audio mixer switches and sound volume controls. ● Clean away dirt. ● Press the PLAY/PAUSE button (▶/).
Sound is distorted, noise is output.	<ul style="list-style-type: none"> ● Output cables are connected incorrectly or are loose. ● Pin plugs and/or terminals are dirty. ● Interference is being picked up from a TV set. 	<ul style="list-style-type: none"> ● Connect to audio mixer's LINE INPUT terminals. (Do not connect to MIC terminals.) ● Clean away dirt. ● Switch OFF TV set, move player away from TV set.
With certain discs, loud noise is produced or play stops.	<ul style="list-style-type: none"> ● Disc has a bad scratch or warp. ● Disc is extremely dirty. 	<ul style="list-style-type: none"> ● Replace disc. ● Clean disc.
When the auto cue function is set ON, track search is not finished.	<ul style="list-style-type: none"> ● If the sound muted portion between selections is long, searching time will be long. (If the point cannot be found within ten seconds, the cue point is set at the track's beginning.) 	<ul style="list-style-type: none"> ● Press TIME MODE/AUTO CUE button for more than 1 second to set the auto cue function OFF.
Back cue function cannot be carried out even though the CUE button is pressed in playback mode.	<ul style="list-style-type: none"> ● The cue point is not set yet. ● In the case of MP3, back cue cannot be performed if no cue point is located within the currently playing folder. 	<ul style="list-style-type: none"> ● Set the cue point. (See page 15.)
Pressing the LOOP OUT button does not start loop play.	<ul style="list-style-type: none"> ● No cue points (loop-in points) have been set. ● In the case of MP3, loop cannot be performed if no loop-in point is located within the currently playing track. 	<ul style="list-style-type: none"> ● Set a cue point.
The jog dial does not operate as desired.	<ul style="list-style-type: none"> ● Incorrect JOG MODE [VINYL/CDJ] is set. 	<ul style="list-style-type: none"> ● Press the JOG MODE SELECT button to set the desired JOG MODE [VINYL] or [CDJ].
The picture of the TV screen is fluctuated or FM broadcast is interfered with noise.	<ul style="list-style-type: none"> ● Interference is being picked up from the CD player. 	<ul style="list-style-type: none"> ● Turn off POWER switch of the player, or move the player away from the TV or tuner.
The disc is not rotating when power is ON.	<ul style="list-style-type: none"> ● The disc rotation stops automatically if no operation has been performed for 100 minutes or more in pause mode. ● After the disc's final track finishes playing, if the [END] display continues for 100 minutes without any further operation input, disc rotation will automatically stop. 	<ul style="list-style-type: none"> ● Playback can be started by pressing the PLAY/PAUSE button (▶/). Press the EJECT button (▲) to eject the disc.
Can't record cue point memory.	<ul style="list-style-type: none"> ● No memory card is loaded. ● Memory card has been set for write-protect. ● When playing MP3, a MultiMedia Card recorded on the CDJ-1000 or CDJ-1000MK2 is loaded. ● SD memory card not formatted properly. ● Memory card door is open. 	<ul style="list-style-type: none"> ● Insert memory card. ● Set write-protect switch to allow writing to card. ● MultiMedia Cards recorded on the CDJ-1000 or CDJ-1000MK2 cannot be used for recording during MP3 playback. ● Insert memory card formatted in compliance with SD memory card standards. ● Close memory card door.

- This component may fail to operate properly due to influence of static electricity or other external influences. In this case, try turning off the POWER switch, and turn on the power again only when the disc has fully stopped rotating.
- This unit cannot play partially recorded CD-R or CD-RW discs that have not been finalized.
- This unit plays only standard 12 cm discs and 8 cm discs mounted in proper disc adapters; it cannot play irregularly shaped discs (damage or malfunctions may occur).
- When playing 8 cm discs mounted on adapters, some speed loss may be experienced when using scratch and reverse operations. This unit for high performance when rotating discs at high speed, but when 8 cm discs are mounted in adapters, the rotation speed is reduced for safety. This is not a malfunction.
- BPM values measured with this unit may differ from published values found on CD labels, or those measured on Pioneer DJ mixers. This is a result of differences in BPM measuring methods, and is not a malfunction.
- When playing CD-R/RW discs, some degradation in performance may be experienced depending on the recording quality of the individual disc.

Error message display

When the unit is unable to operate properly, an error code is displayed on the display panel. Check the error code displayed against the following table and take the recommended action to correct the error. If an error code other than any of the error codes listed in the table below is displayed or if the same error code is displayed even after corrective action has been taken, contact your nearest Pioneer Service Station or contact the store from which you purchased your player for assistance.

Error code	Error type	Error content	Cause and remedy
E-72 01	TOC READ ERROR	Can't read TOC data.	Disc is cracked. → Replace disc.
E-83 01 E-83 02 E-83 03	PLAYER ERROR	Can't play this disc properly.	Disc is dirty. → Clean disc. If other discs operate normally, problem is with this disc.
E-83 04	MP3 DECODER ERROR	Can't play this disc properly.	Does not conform to MP3 format. → Change to disc conforming to MP3 format.
E-83 05	DATA FORMAT ERROR		
E-91 01	MECHANICAL TIME OUT	Mechanical operation did not end within specified time.	Foreign object in disc loading slot. → Remove foreign object.



Dear Customer:

Selecting fine audio equipment such as the unit you've just purchased is only the start of your musical enjoyment. Now it's time to consider how you can maximize the fun and excitement your equipment offers. This manufacturer and the Electronic Industries Association's Consumer Electronics Group want you to get the most out of your equipment by playing it at a safe level. One that lets the sound come through loud and clear without annoying blaring or distortion-and, most importantly, without affecting your sensitive hearing.

Sound can be deceiving. Over time your hearing "comfort level" adapts to higher volumes of sound. So what sounds "normal" can actually be loud and harmful to your hearing. Guard against this by setting your equipment at a safe level BEFORE your hearing adapts.

To establish a safe level:

- Start your volume control at a low setting.
- Slowly increase the sound until you can hear it comfortably and clearly, and without distortion.

Once you have established a comfortable sound level:

- Set the dial and leave it there.

Taking a minute to do this now will help to prevent hearing damage or loss in the future. After all, we want you listening for a lifetime.

We Want You Listening For A Lifetime

Used wisely, your new sound equipment will provide a lifetime of fun and enjoyment. Since hearing damage from loud noise is often undetectable until it is too late, this manufacturer and the Electronic Industries Association's Consumer Electronics Group recommend you avoid prolonged exposure to excessive noise. This list of sound levels is included for your protection.

Decibel

Level Example

30	Quiet library, soft whispers
40	Living room, refrigerator, bedroom away from traffic
50	Light traffic, normal conversation, quiet office
60	Air conditioner at 20 feet, sewing machine
70	Vacuum cleaner, hair dryer, noisy restaurant
80	Average city traffic, garbage disposals, alarm clock at two feet.

THE FOLLOWING NOISES CAN BE DANGEROUS UNDER CONSTANT EXPOSURE

90	Subway, motorcycle, truck traffic, lawn mower
100	Garbage truck, chain saw, pneumatic drill
120	Rock band concert in front of speakers, thunderclap
140	Gunshot blast, jet plane
180	Rocket launching pad

Information courtesy of the Deafness Research Foundation.



S001_En

Should this product require service in the U.S.A. and you wish to locate the nearest Pioneer Authorized Independent Service Company, or if you wish to purchase replacement parts, operating instructions, service manuals, or accessories, please call the number shown below.

800 – 782 – 7210

Please do not ship your product to Pioneer without first calling the Customer Support Division at the above listed number for assistance.

**PIONEER ELECTRONICS (USA), INC.
CUSTOMER SUPPORT DIVISION
P.O. BOX 1760, LONG BEACH,
CA 90801-1760, U.S.A.**

For warranty information please see the Limited Warranty sheet included with your product.

Should this product require service in Canada, please contact a Pioneer Canadian Authorized Dealer to locate the nearest Pioneer Authorized Service Company in Canada. Alternatively, please contact the Customer Service Department at the following address:

Pioneer Electronics of Canada, Inc.

**300 Allstate Parkway
Markham, ON L3R 0P2
(905) 479-4411
1 (877) 283-5901**

For warranty information please see the Limited Warranty sheet included with your product.

Supply of this product only conveys a license for private, non-commercial use and does not convey a license nor imply any right to use this product in any commercial (i.e. revenue-generating) real time broadcasting (terrestrial, satellite, cable and/or any other media), broadcasting/streaming via internet, intranets and/or other networks or in other electronic content distribution systems, such as pay-audio or audio-on-demand applications. An independent license for such use is required. For details, please visit <http://www.mp3licensing.com>.



Fraunhofer Institut
Integrierte Schaltungen

MPEG Layer-3 audio coding technology licensed from Fraunhofer IIS and Thomson multimedia.

Published by Pioneer Corporation.
Copyright © 2005 Pioneer Corporation.
All rights reserved.

PIONEER CORPORATION 4-1, Meguro 1-Chome, Meguro-ku, Tokyo 153-8654, Japan

PIONEER ELECTRONICS (USA) INC.

Multimedia and Mass Storage Division: 2265 East 220th Street, Long Beach, CA 90810, U.S.A. TEL: 800-444-OPT1 (6784)

PIONEER ELECTRONICS OF CANADA, INC.

Industrial Products Department: 300 Allstate Parkway, Markham, Ontario L3R 0P2, Canada TEL: 905-479-4411

Free Manuals Download Website

<http://myh66.com>

<http://usermanuals.us>

<http://www.somanuals.com>

<http://www.4manuals.cc>

<http://www.manual-lib.com>

<http://www.404manual.com>

<http://www.luxmanual.com>

<http://aubethermostatmanual.com>

Golf course search by state

<http://golfingnear.com>

Email search by domain

<http://emailbydomain.com>

Auto manuals search

<http://auto.somanuals.com>

TV manuals search

<http://tv.somanuals.com>