

**Pioneer**

DJ Controller

**DDJ-S1**

**DDJ-S1 Serato DJ Edition**

**serato** || **serato**  **DJ**

<http://pioneeardj.com/support/>

The Pioneer DJ support site shown above offers FAQs, information on software and various other types of information and services to allow you to use your product in greater comfort.

<http://serato.com/>

For the latest version of the Serato DJ software, access Serato.com and download the software from there.

Operating Instructions

---

---

# Contents

## How to read this manual

- Thank you for buying this Pioneer product.  
Be sure to read both this leaflet and Read Before Use (Important)/ Quick Start Guide! Both documents include important information that you must understand before using this product.  
For instructions on obtaining the Serato DJ software's manual, see *Acquiring the manual* (p.24).
- In this manual, names of screens and menus displayed on the product and on the computer screen, as well as names of buttons and terminals, etc., are indicated within brackets. (e.g.: [CUE] button, [Files] panel, [MIC1] terminal)
- Please note that the screens and specifications of the software described in this manual as well as the external appearance and specifications of the hardware are currently under development and may differ from the final specifications.
- Please note that depending on the operating system version, web browser settings, etc., operation may differ from the procedures described in this manual.

This manual consists mainly of explanations of functions of this unit as hardware. For detailed instructions on operating the Serato DJ software, see the Serato DJ software manual.

- The Serato DJ software manual can be downloaded from "Serato.com". For details, see *Downloading the Serato DJ software manual* (p. 24).
- The latest version of these operating instructions can be downloaded from the Pioneer support site. For details, see *Downloading the latest version of these operating instructions* (p.24).

## 01 Before start

Features .....	3
What's in the box .....	3
About the AC adapter .....	3
Installing the software .....	5
About the driver software and setting utility software .....	7

## 02 Connections and part names

Connecting the input/output terminals .....	8
Part names and functions .....	9

## 03 Basic Operation

Connections .....	14
Starting the system .....	16
Quitting the system .....	18

## 04 Advanced Operation

Using hot cues .....	19
Using the Loop Roll function .....	19
Using the sampler function .....	19
Using the slip mode .....	19
Starting playback using the fader (Fader Start) .....	20
Displaying the album images in the track list .....	21
Analyzing tracks .....	21
Using a microphone .....	21
Using an external device .....	21
Recording .....	21
Outputting the microphone and AUX sound directly .....	21

## 05 Additional information

Troubleshooting .....	22
Acquiring the manual .....	24
Using as a controller for other DJ software .....	24
About trademarks and registered trademarks .....	25
Cautions on copyrights .....	25
Specifications .....	26

# Before start

## Features

This unit is an all-in-one DJ system combining the high operability hardware of Pioneer professional DJ players and DJ mixers that has achieved an excellent reputation among many professional DJs and clubs with the Serato DJ DJ software by Serato. It is also equipped with audio interface, and allows full-fledged DJ performances without requiring other DJ equipment.

## LAYOUT

This unit uses the same layout as Pioneer professional models, allowing intuitive and accurate performances with simple 2-channel mixing and effects.

## MIC/AUX INPUT, XLR OUTPUT

This unit is equipped with a microphone/auxiliary input allowing connection of a microphone or external device (sampler, portable audio device, etc.). For output, it has XLR and RCA terminals supporting professional PA equipment. In this way, this unit supports all types of situations and DJing styles.

## “Serato DJ” Supported

This unit supports “Serato DJ”, a DJ software program which offers a great number of functions required for DJ performances. All of the buttons and controls on this unit are preset to associate them with the software, so DJ performances can be held immediately, simply by connecting this unit to a computer.

## LAPTOP DOCK

The computer’s keyboard section can be stowed under this unit. Docking the computer with this unit into a single unit allows you to create an efficient DJ system.

## Playing address/Level meter

The player section is equipped with a “playing address” indicator letting you grasp the track’s progress at a glance by the position of the LED display and get the sense of touching the track directly when the [NEEDLE SEARCH (ROLL)] pad is touched with a finger. Furthermore, the mixer section is equipped with a master level meter and channel level meters. This increases affinity with the computer for even more comfortable DJ performances.

## HIGH SOUND QUALITY

The sound quality technology developed for Pioneer professional models is used to achieve a high level of sound quality for a DJ controller.

## What’s in the box

- CD-ROM (Installation Disc)
- AC adapter
- Power plug
- USB cable
- Warranty (for some regions only)<sup>□</sup>
- Read Before Use (Important)/Quick Start Guide

□ The included warranty is for the European region. (For the North American region, the warranty information is provided at the end of the “Read Before Use (Important)/Quick Start Guide”).

## About the AC adapter

### Safety instructions

To ensure your personal safety and to maximize the full operating potential of your unit, read and follow these safety instructions.

### Read & Retain Instructions

Read all operating and user information provided with this product.

### Cleaning

Use a damp cloth to clean the exterior housing. Avoid using any fluids including liquid, aerosol or alcohol-based cleaning products.

### Water or Moisture

Avoid operating or locating this product near water or other sources of fluid.

### Accessories

Do not place this product on an unstable cart, stand, or table. The product may fall and be seriously damaged.

### Ventilation

Do not block or cover this product in use. This unit should not be placed in a built-in installation unless properly ventilated.

### Environment

Avoid placing this product in a location with exposure to large quantities of dust, high temperatures, high humidity, or subject to excessive vibrations or shocks.

### Power Sources

Operate this product only from the recommended power sources. If you are unsure of the power source, consult an authorized Pioneer representative.

### Power-Cord Protection

When unplugging the unit, pull on the plug – not on the cord. Do not handle the cord or plug with wet hands; doing so could cause an electric short or shock. Do not allow anything to pinch or rest on the power cord and do not place in a walkway.

### Power

Turn OFF the system before installing this or any other hardware device.

### Overloading

Avoid connecting too many devices to a single wall socket or power source as this can cause fires or short circuits.

### Object & Liquid Entry

Never push inappropriate objects in to the device. Avoid spilling any liquids in to or on the outside of the drive.

## Servicing

Opening or removing the cover exposes you to possible electrical shock or other danger. Contact a Pioneer authorized service representative for repairing this product (refer to the enclosed Service & Support Card).

## Damage Requiring Service

Unplug the unit and refer servicing to qualified service personnel in the following situations:

- When the power cord, plug, or chassis is damaged.
- If liquid has been spilled, or objects have fallen into the product.
- If the product has been exposed to rain or water.
- If the product does not operate normally when the operating instructions are followed. Adjust only those controls that are covered by the operating instructions. Improper adjustment of other controls may result in damage and can require extensive work by a qualified technician to restore the unit to its normal operation.
- When the product exhibits a distinct change in performance – this indicates a need for service.

Check that there are no irregularities with the AC adapter or power plug, then insert the power plug into the specified position of the AC adapter using the specified procedure until a click is heard. For details, see *Mounting the power plug* on page 4.

If there are irregularities with the AC adapter or power plug, ask your nearest Pioneer authorized service center or your dealer to carry out repair work.

- Do not use this unit with a coin, paper clip or other metal object stuck between the AC adapter and power plug. Doing so could cause a short circuit, leading to fire or electric shock.



- When mounting the AC adapter on a wall outlet, make sure there is no space between the AC adapter and the wall outlet. Faulty contact or a coin, paper clip or other metal object getting stuck in the space could cause a short circuit, leading to fire or electric shock.

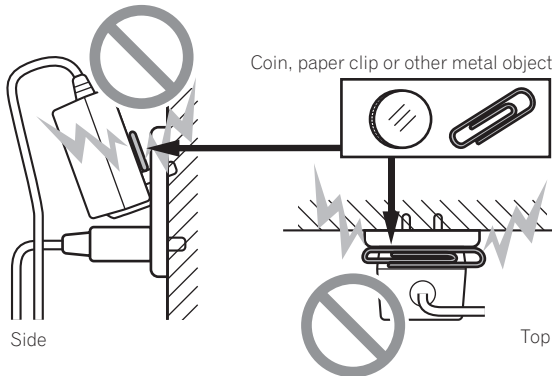

- The power plug could come detached from the AC adapter and remain in the power outlet if someone trips on the AC adapter's power cord or if something hits the AC adapter. If this happens, remove the power plug remaining in the outlet with dry hands, holding it as shown on the diagram below and without touching metal parts. Do not use any tools to remove it.

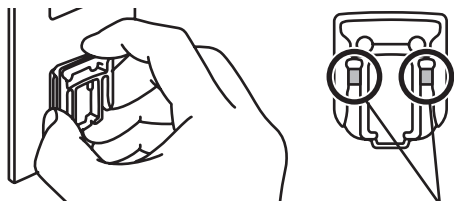

Do not touch metal parts.

## Mounting the power plug

Slide the power plug along the guide rails in the AC adapter unit as shown on the diagram below, then press in until a click is heard.

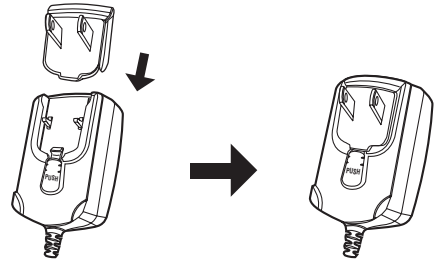

## ❖ Removing the power plug

While pressing the [PUSH] button on the AC adapter unit, slide the power plug away from the adapter as shown on the diagram below to remove it.

Once the power plug is mounted, there is no need to remove it.

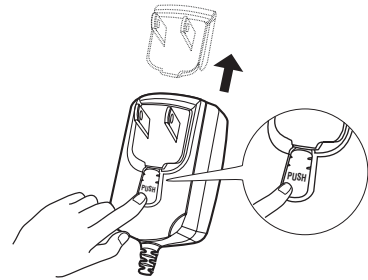

## Power plug

This product comes with the types of power plugs shown below. Use the appropriate power plug for the country or region you are in.

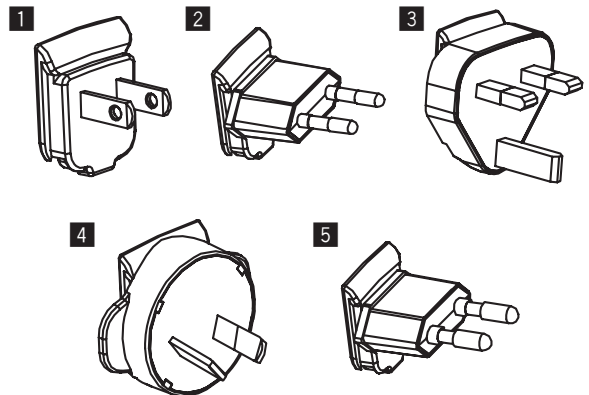

1 Type 1 (for North America)

2 Type 2 (for Europe)

3 Type 3 (for the UK)

4 Type 4 (for Australia)

5 Type 5 (for Thailand)

# Installing the software

## Before installing the software

For the latest version of the Serato DJ software, access Serato.com and download the software from there. A software download link is also provided on the included CD-ROM.

- For details, refer to "Installation Procedure (Windows)" or "Installation procedure (Mac OS X)".
- The user is responsible for preparing the computer, network devices and other elements of the Internet usage environment required for a connection to the Internet.

## About the driver software (Windows)

This driver software is an exclusive ASIO driver for outputting audio signals from the computer.

- There is no need to install the driver software when using Mac OS X.

## Checking the latest information on the driver software

For detailed information on this unit's designated driver software, see the Pioneer DJ support site below.

<http://pioneerdj.com/support/>

## About the Serato DJ software

Serato DJ is a DJ software application by Serato. DJ performances are possible by connecting the computer on which this software is installed to this unit.

## Minimum operating environment

Supported operating systems	CPU and required memory
Mac OS X: 10.6.8, 10.7.4 and 10.8	32-bit version Intel® processor, Core™ 2 Duo 2.0 GHz or better 1 GB or more of RAM
	64-bit version Intel® processor, Core™ 2 Duo 2.4 GHz or better 4 GB or more of RAM
Windows: Windows 7	32-bit version Intel® processor, Core™ 2 Duo 2.0 GHz or better 2 GB or more of RAM
	64-bit version Intel® processor, Core™ 2 Duo 2.4 GHz or better 4 GB or more of RAM

Others	
Optical drive	Optical disc drive on which the CD-ROM can be read
USB port	A USB 2.0 port is required to connect the computer with this unit.
Display resolution	Resolution of 1 280 x 720 or greater
Internet connection	An Internet connection is required for registering the "Serato.com" user account and downloading the software.

- For the latest information on the required operating environment and compatibility as well as to acquire the latest operating system, refer to "Software Info" under "DDJ-S1 Serato DJ Edition" on the Pioneer DJ support site below.  
<http://pioneerdj.com/support/>
- Operation is not guaranteed on all computers, even if all the required operating environment conditions indicated here are fulfilled.
- Depending on the computer's power-saving settings, etc., the CPU and hard disk may not provide sufficient processing capabilities. For notebook computers in particular, make sure the computer is in the proper conditions to provide constant high performance (for example by keeping the AC power connected) when using Serato DJ.
- Operation of Serato DJ is not guaranteed with AMD brand CPUs.
- Use of the Internet requires a separate contract with a provider offering Internet services and payment of provider fees.

## About the installation procedure

The installation procedure depends on the operating system (OS) on the computer you are using.

### For Windows

After installing the driver software, install the Serato DJ software.

### For Mac OS X

Only install the Serato DJ software.

## Installation Procedure (Windows)

Do not connect this unit and the computer until installation is completed.

- Log on as the user which was set as the computer's administrator before installing.
- If any other programs are running on the computer, quit them.

### 1 Insert the CD-ROM into the computer's optical drive.

The CD-ROM menu is displayed.

- If the CD-ROM menu does not appear when the CD-ROM is inserted, open the optical drive from [Computer (or My Computer)] in the [Start] menu, then double-click the [CD\_menu.exe] icon.

### 2 When the CD-ROM menu appears, select [Install Driver Software (Pioneer\_DDJ\_Driver\_x.xxx.exe)], then click [Start].

- To close the CD-ROM menu, click [Exit].

### 3 Proceed with installation according to the instructions on the screen.

If [Windows Security] appears on the screen while the installation is in progress, click [Install this driver software anyway] and continue with the installation.

When the installation program is completed, a completion message appears.

After installing the driver software, install the Serato DJ software.

### 4 Select [Install DJ Software (Serato DJ/Download)] from the CD-ROM's menu, then click [Start].

### 5 "An internet environment is required to access the site. Connected to the internet?" is displayed. Click [Yes].

The web browser is launched and the Pioneer DJ support site is displayed.

### 6 Click [Software Info] under [DDJ-S1 Serato DJ Edition] on the Pioneer DJ support site. [Serato DJ Support Information] is displayed.

### 7 Click the link to the Serato DJ download page.

The Serato DJ download page is displayed.

### 8 Log in to your "Serato.com" user account.

- If you have already registered a user account on "Serato.com", proceed to step 10.
- If you have not completed registering your user account, do so following the procedure below.
  - Following the instructions on the screen, input your e-mail address and the password you want to set, then select the region in which you live.
  - If you check [E-mail me Serato newsletters], newsletters providing the latest information on Serato products will be sent from Serato.
  - Once user account registration is completed, you will receive an e-mail at the e-mail address you have input. Check the contents of the e-mail sent from "Serato.com".
- Be careful not to forget the e-mail address and password specified when you performed user registration. They will be required for updating the software.
- The personal information input when registering a new user account may be collected, processed and used based on the privacy policy on the Serato website.

## 9 Click the link in the e-mail message sent from “Serato.com”.

This takes you to the Serato DJ download page. Proceed to step 11.

## 10 Log in.

Input the e-mail address and password you have registered to log in to “Serato.com”.

## 11 Download the Serato DJ software from the download page.

Unzip the downloaded file, then double-click the unzipped file to launch the installer.

## 12 Read the terms of the license agreement carefully, and if you agree, select [I agree to the license terms and conditions], then click [Install].

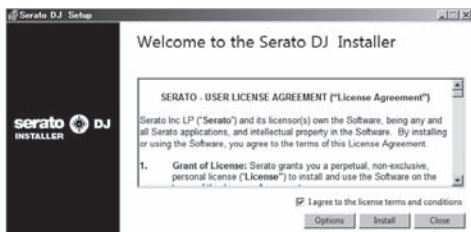

- If you do not agree to the contents of the usage agreement, click [Close] to cancel installation.

Installation begins.



The message of successful installation appears once installation is completed.

## 13 Click [Close] to quit the Serato DJ installer.

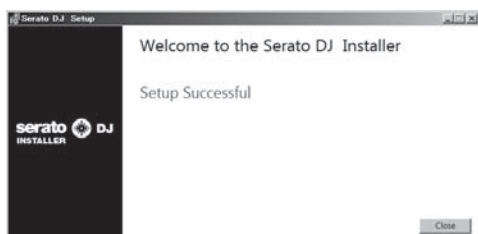

---

## Installation procedure (Mac OS X)

Do not connect this unit and the computer until installation is completed.

- If any other programs are running on the computer, quit them.

### 1 Insert the CD-ROM into the computer's optical drive.

The CD-ROM menu is displayed.

- If the CD-ROM menu does not appear on the screen when the CD-ROM is inserted, open the optical driver from Finder, then double-click the [CD\_menu.app] icon.

### 2 Select [Install DJ Software (Serato DJ/Download)] from the CD-ROM's menu, then click [Start].

## 3 “An internet environment is required to access the site. Connected to the internet?” is displayed. Click [Yes].

The web browser is launched and the Pioneer DJ support site is displayed.

## 4 Click [Software Info] under [DDJ-S1 Serato DJ Edition] on the Pioneer DJ support site.

[Serato DJ Support Information] is displayed.

## 5 Click the link to the Serato DJ download page.

The Serato DJ download page is displayed.

## 6 Log in to your “Serato.com” user account.

- If you have already registered a user account on “Serato.com”, proceed to step 8.
- If you have not completed registering your user account, do so following the procedure below.
  - Following the instructions on the screen, input your e-mail address and the password you want to set, then select the region in which you live.
  - If you check [E-mail me Serato newsletters], newsletters providing the latest information on Serato products will be sent from Serato.
  - Once user account registration is completed, you will receive an e-mail at the e-mail address you have input. Check the contents of the e-mail sent from “Serato.com”.
- Be careful not to forget the e-mail address and password specified when you performed user registration. They will be required for updating the software.
- The personal information input when registering a new user account may be collected, processed and used based on the privacy policy on the Serato website.

## 7 Click the link in the e-mail message sent from “Serato.com”.

This takes you to the Serato DJ download page. Proceed to step 9.

## 8 Log in.

Input the e-mail address and password you have registered to log in to “Serato.com”.

## 9 Download the Serato DJ software from the download page.

Unzip the downloaded file, then double-click the unzipped file to launch the installer.

## 10 Read the terms of the license agreement carefully, and if you agree, click [Agree].

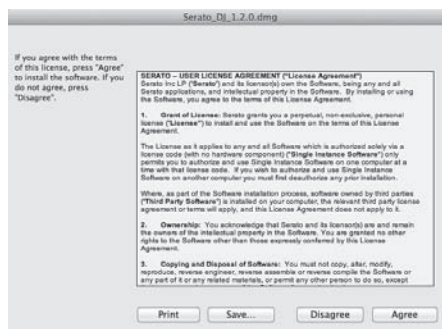

- If you do not agree to the contents of the usage agreement, click [Disagree] to cancel installation.

11 If the following screen appears, drag and drop the [Serato DJ] icon on the [Applications] folder icon.



## About the driver software and setting utility software

This unit functions as an audio device conforming to the ASIO standards.

## Using the settings utility software

This function can only be used by those using a Windows operating system.

### ❖ Launching the settings utility software

Click the Windows [Start] menu>[All Programs]>[Pioneer]>[DDJ]>[DDJ ASIO Settings Utility].

### ❖ Adjusting the buffer size

In the same way as the buffer size setting in the Serato DJ software, decreasing the value of the [Kernel Buffers] setting lowers the transfer delay (latency) of the audio data, while increasing the value reduces the tendency for dropouts in the audio data (breaks in the sound). The setting at [USB BUFFER SIZE (LATENCY)] in the Serato DJ software's [SETUP] menu has priority for the buffer size. (The default setting is 512 samples/10 ms.)

- For details on making the settings on the DJ software, see the Serato DJ software manual.
- If the [Buffer Size] or [Kernel Buffers] number is made large, drops in the data (breaks in the sound), etc., occur less easily, but the time lag due to transmission delays in the audio data (latency) increases.

### ❖ If breaks in the sound occur with the default setting

1 Launch [DDJ ASIO Settings Utility] and change [Kernel Buffers] to [4].

2 Set [USB BUFFER SIZE (LATENCY)] in the Serato DJ software to the minimum buffer size at which no breaks in the sound occur.

### ❖ If no breaks in the sound occur with the default setting

1 Set [USB BUFFER SIZE (LATENCY)] in the Serato DJ software to the minimum buffer size at which no breaks in the sound occur.

2 Launch [DDJ ASIO Settings Utility], change [Kernel Buffers] to [2], and check that no breaks in the sound occur.

3 If no breaks in the sound occur, set [USB BUFFER SIZE (LATENCY)] in the Serato DJ software to the minimum buffer size at which no breaks in the sound occur. If breaks in the sound do occur, change [Kernel Buffers] in the [DDJ ASIO Settings Utility] to [3].

## Checking the version of the driver software

Click the Windows [Start] menu>[All Programs]>[Pioneer]>[DDJ]>[DDJ Version Display Utility].

- You can check the firmware version of this unit on the screen.
- The firmware version is not displayed when this unit is not connected to the computer or when this unit and computer are not properly communicating.

# Connections and part names

- Wait until all connections between devices have been completed before connecting the AC adapter.  
Be sure to turn off the power and unplug the AC adapter from the power outlet before making or changing connections between devices.  
Refer to the operating instructions for the component to be connected.
- Only use the AC adapter included with this unit.
- Power to this unit is supplied by the AC adapter or by USB bus power.  
This unit can be used by connecting it to a computer using a USB cable, even without connecting the AC adapter.
- Connect this unit and the computer directly using the included USB cable.
- A USB hub cannot be used.

## Notes on running this unit with USB bus power

- When using this unit on USB bus power, supply power to the connected computer from the AC power supply. Do not run the computer on its battery.
- In cases like the ones below, the power may be insufficient and this unit may not operate on USB bus power.
  - When the computer's USB power supply capacity is insufficient.
  - When other USB devices are connected to the computer.
 If this unit does not operate on USB bus power, connect the included AC adapter.
- The following limitations apply when operating on USB bus power:
  - The jog dial indicator will not light.
  - The [MASTER OUT 1] (XLR output) channel is not output.
  - The [MIC1], [MIC2] and [AUX IN] terminals cannot be used.
  - The indicators are dimmer than when using the AC adapter.
 To use the unit without these limitations, connect the included AC adapter.

## Connecting the input/output terminals

### Front panel

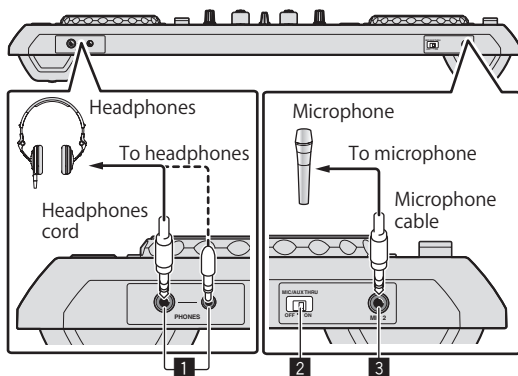

#### 1 PHONES jacks

Connect headphones here.  
Both stereo phone plugs (Ø 6.3 mm) and stereo mini phone plugs (Ø 3.5 mm) can be used.

For details, see *Monitoring sound with headphones* on page 18.

- There are two input jacks, both a stereo phones jack and a mini phones jack, but do not use both simultaneously. If both are used simultaneously, when one is disconnected and/or connected, the volume of the other may increase or decrease suddenly.

#### 2 MIC/AUX THRU selector switch

Set this to [ON] if you want to output the [MIC2] and [AUX] channels directly.

➤ *Outputting the microphone and AUX sound directly* (p.21)

#### 3 MIC2 terminal

Connects a microphone here.

➤ *Using a microphone* (p.21)

### Rear panel

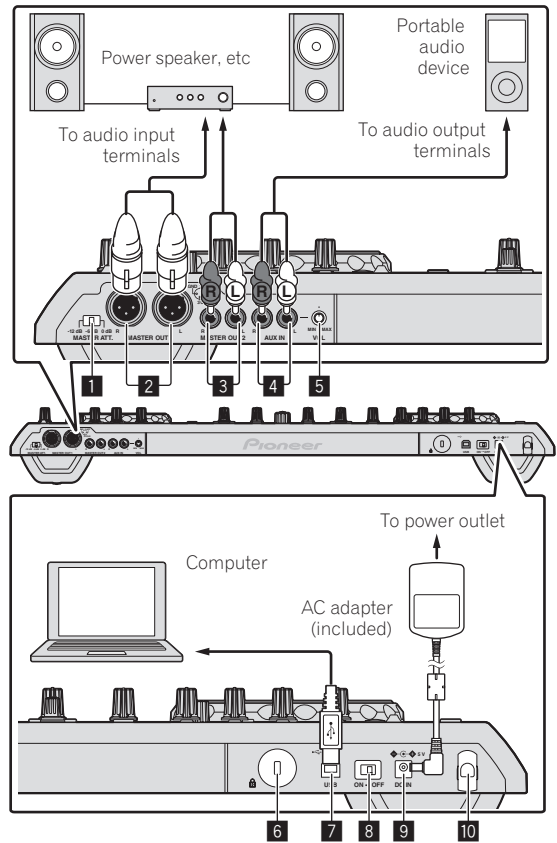

#### 1 MASTER ATT.

Sets the attenuation level of the sound output from the [MASTER 1] terminal.

#### 2 MASTER OUT 1 terminals

Connect powered speakers, etc., here.

#### 3 MASTER OUT 2 terminals

Connect to a power amplifier, etc.

#### 4 AUX IN terminal

Connect to the output terminal of an external device (sampler, portable audio device, etc.)

#### 5 VOL control

Adjusts the audio level input to the [AUX IN] terminals.

#### 6 Kensington security slot

#### 7 USB terminal

Connect to a computer.

- Connect this unit and the computer directly using the included USB cable.
- A USB hub cannot be used.



### 8 ON/OFF switch

Turns this unit's power on and off.

### 9 DC IN terminal

Connect to a power outlet using the included AC adapter (with the power plug mounted).

- Wait until connection of all equipment is completed before connecting the AC adapter.
- Only use the included AC adapter.

### 10 Cord hook

Catch the AC adapter's power cord and USB cable on this hook when using this unit.

- The sound will be interrupted if the AC adapter or USB cable is disconnected during playback.

### ❖ Cord hook

#### Hook the AC adapter's power cord in the top of the cord hook, the USB cable in the bottom.

Fasten the AC adapter's power cord and USB cable in place by hooking them on the cord hook. This prevents the power cord and USB cable from being accidentally pulled and the plugs from being disconnected from the terminals.

- The sound will be interrupted if the AC adapter or USB cable is disconnected during playback.

AC adapter's power cord

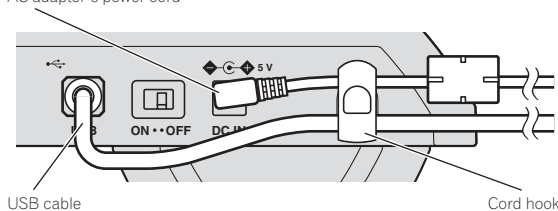

USB cable

Cord hook

### Upper left of control panel

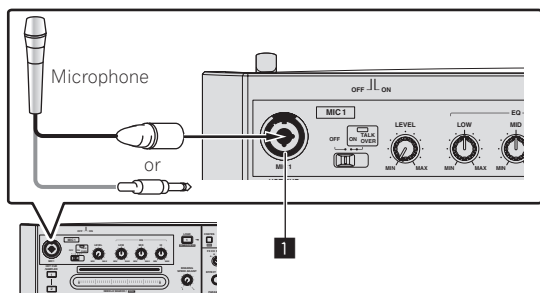

### 1 MIC1 terminal

Connects a microphone here.

➔ *Using a microphone (p.21)*

- Either an XLR connector or a phones plug (Ø 6.3 mm) can be used.

## Part names and functions

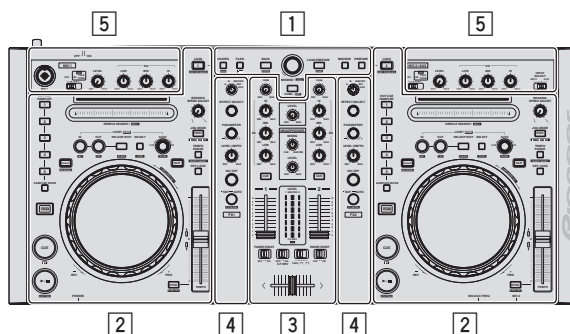

### 1 Browser section

### 2 Deck section

### 3 Mixer section

### 4 Effect section

### 5 Microphone/External input control section

### Browser section

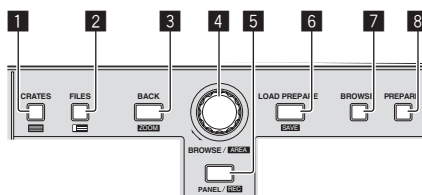

### 1 CRATES button

Press:

The cursor moves between the crate list panel and track list each time this button is pressed.

[SHIFT] + press:

The way album images are displayed in the browser area can be changed.

➔ *Displaying the album images in the track list (p.21)*

### 2 FILES button

Press:

Turns the display of the [Files] panel on/off.

[SHIFT] + press:

The way album images are displayed in the browser area can be changed.

➔ *Displaying the album images in the track list (p.21)*

### 3 BACK (LIBRARY) button

Press:

The cursor moves between the [CRATES] panel and library each time the button is pressed.

The cursor on the [Files] panel moves to a higher layer.

The cursor on the [Browse] panel moves to the previous category.

[SHIFT] + press:

This maximizes the [Browse] panel display

#### 4 Rotary selector

Turn:

The cursor in the library or on the [CRATES] panel moves up and down.

Press:

The cursor moves between the [CRATES] panel and library each time the rotary selector is pressed.

If there are sub crates in the item currently selected in the [CRATES] panel, that crate opens.

The cursor on the [Files] panel moves to a lower layer.

The cursor on the [Browse] panel moves to the next category.

- For details on the [CRATES] panel, see *Importing tracks* (p.17).

[SHIFT] + press:

The panel display switches each time the button is pressed.

Panel display off → Files → Browse → PREPARE → History → Panel display off.

#### 5 PANEL (REC) button

Press:

The panel display switches in the order below each time the button is pressed.

Panel display off → [REC] panel → [FX] panel → [SP-6] panel → Panel display off ...

- When Serato-Video is installed and enabled at the [SETUP] menu, a key for switching to the [VIDEO] panel is displayed on the Serato DJ software screen. To display the [VIDEO] panel, use the mouse to click this key for switching to the [VIDEO] panel.

[SHIFT] + press:

Click this to start/stop recording.

#### 6 LOAD PREPARE (SAVE) button

Press:

Loads tracks to the [Prepare] panel.

[SHIFT] + press:

Click this to save the recorded data.

#### 7 BROWSE button

Turns the display of the [Browse] panel on/off.

#### 8 PREPARE button

Turns the display of the [Prepare] panel on/off.

---

## Deck section

The deck section is used to control the two decks. There are controls and buttons for operating deck 1 on the left side of the controller, controls and buttons for operating deck 2 on the right side of the controller.

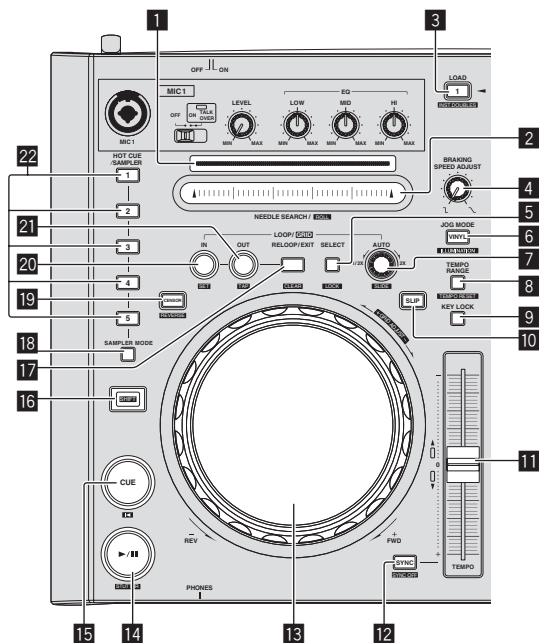

#### 1 Playing address indicator

The position in the track is displayed in 10 steps, with the beginning of the track at the left edge, the end of the track at the right edge. The indicator lights in sync with the elapsed playing time or remaining time display in the "Serato DJ" software.

#### 2 NEEDLE SEARCH (ROLL) pad

Touch:

By touching the pad, you can jump to the desired position in the track loaded in the deck.

[SHIFT] + touch:

Plays a loop roll for the number of beats assigned at the point the pad was touched.

↻ *Using the Loop Roll function* (p.19)

#### 3 LOAD (INST.DOUBLES) button

Press:

The selected tracks are loaded to the respective decks.

[SHIFT] + press:

Loads the track loaded in the deck selected on the opposite side onto the deck whose [LOAD (INST.DOUBLES)] button is pressed. When this is done while the track is playing, the track is played from the same position. (Instant Double)

#### 4 BRAKING SPEED ADJUST control

Adjusts the speed at which playback slows until stopping when playback of a track is stopped.

#### 5 LOOP SELECT (GRID LOCK) button

Press:

The loop slot switches. (Loop Slot)

When loops are stored in loop slots ahead of time, they can be called out later.

- Up to eight loops can be set in the loop slots.
- When you select the number of the loop slot at which you want to store the loop then set a loop, the loop is automatically stored.
- When a new loop is set after a loop has been stored, the loop is overwritten and the slot is updated.
- When the number of the loop slot whose loop you want to call out is selected and the **LOOP OUT (GRID TAP)** button is pressed while pressing the [SHIFT] button (reloop), playback of the stored loop starts.

[SHIFT] + press:

Sets so that the entire beat grid cannot be edited.

For instructions on displaying the beat grid, see the Serato DJ software manual.

**6 VINYL (ILLUMINATION) button**

Press:  
This switches the vinyl mode on/off.

[SHIFT] + press:

The way the jog dial illumination lights can be selected from one of two types.

The setting switches each time the button is pressed.

- The same setting is applied to the jog dials on the left and right decks.

**7 AUTO LOOP (GRID SLIDE) control**

Press:  
Turns the auto looping mode on and off.

- During loop playback, this operation cancels looping.

Turn:

Turn the control clockwise or counterclockwise to specify the length of the loop in number of beats.

The length of the loop can be changed by turning the [AUTO LOOP (GRID SLIDE)] control during loop playback.

[SHIFT] + press:

Slides the entire beat grid to the left or right.

For instructions on displaying the beat grid, see the Serato DJ software manual.

**8 TEMPO RANGE (TEMPO RESET) button**

Press:  
The [TEMPO] slider's range of variation switches each time the button is pressed.

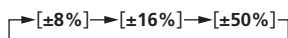

[SHIFT] + press:

Sets the tempo (BPM) of the currently playing track back to its original tempo.

**9 KEY LOCK button**

Press:  
Turns the key lock function on and off.  
When the key lock function is on, the key does not change even when the playing speed is changed with the [TEMPO] slider.

- The sound is digitally processed, so the sound quality decreases.

**10 SLIP button**

This turns the slip mode on/off.

➔ *Using the slip mode* (p.19)

**11 TEMPO slider**

Use this to adjust the track playing speed.

**12 SYNC (SYNC OFF) button**

Press:  
The tempos (pitches) and beat grids of tracks on multiple decks can be synchronized automatically.  
For instructions on displaying the beat grid, see the Serato DJ software manual.

[SHIFT] + press:

Cancels the sync mode.

**13 Jog dial**

Turn top:  
When the vinyl mode is on, the scratch operation is possible.  
When the vinyl mode is off, the pitch bend operation (adjustment of the playing speed) is possible.

Turn outer section:

The pitch bend operation (adjustment of the playing speed) is possible.

[SHIFT] + Turn top:

Adjusts the beat grid's spacing.

When turned clockwise, the beat grid's spacing widens, and when turned counterclockwise, the beat grid's spacing narrows.

For instructions on displaying the beat grid, see the Serato DJ software manual.

**14 PLAY/PAUSE ►/II (STUTTER) button**

Press:  
Use this to play/pause tracks.

[SHIFT] + press:

The track returns to the temporary cue point and playback continues from there. (Stutter)

**15 CUE button**

Press:  
This is used to set, play and call out temporary cue points.

- When the [CUE] button is pressed while pausing, the temporary cue point is set.
- When the [CUE] button is pressed during playback, the track returns to the temporary cue point and pauses. (Back Cue)
- When the [CUE] button is pressed and held after the track returns to the temporary cue point, playback continues as long as the button is pressed in. (Cue Sampler)
- When the [PLAY/PAUSE ►/II (STUTTER)] button is pressed during cue sampling, playback continues from that point.

[SHIFT] + press:

Loads the previous track in the track list. (Previous Track)

- If the current playback position is not the beginning of a track, the track returns to the beginning.

**16 SHIFT button**

When another button is pressed while pressing the [SHIFT] button, a different function is called out.

**17 RELOOP/EXIT (GRID CLEAR) button**

Cancels loop playback. (Loop Exit)  
After loop playback is canceled, playback returns to the previously set loop in point and loop playback resumes. (Reloop)

[SHIFT] + press:

Clears the beat markers. (Grid Clear)

**18 SAMPLER MODE button**

Sets [HOT CUE/SAMPLER] buttons 1 – 5 to the sampler mode.  
When pressed again, the mode returns to the hot cue mode.

**19 CENSOR (REVERSE) button**

Press:  
The track is played in the reverse direction while the [CENSOR (REVERSE)] button is pressed, and normal playback resumes when the button is released.

- Even during playback in the reverse direction, normal playback continues in the background. When the button is released, playback resumes from the point reached in the background.

[SHIFT] + press:

The track is played in the reverse direction. When the [SHIFT] and [CENSOR (REVERSE)] buttons are pressed again, reverse playback is canceled and normal playback resumes.

**20 LOOP IN (GRID SET) button**

Press:  
Loop In Point is set.  
When this button is pressed during loop playback, the loop in point can be fine-adjusted using the jog dial.

[SHIFT] + press:

Sets a beat marker. (Grid Set)

Beat markers can be set at multiple points.

For instructions on displaying the beat grid, see the Serato DJ software manual.

**21 LOOP OUT (GRID TAP) button**

Press:  
The loop out point is set, and loop playback begins.  
When this button is pressed during loop playback, the loop out point can be fine-adjusted using the jog dial.

[SHIFT] + press:

The beat grid can be adjusted during playback by tapping the button.  
For instructions on displaying the beat grid, see the Serato DJ software manual.

## 22 HOT CUE/SAMPLER buttons 1 – 5

Hot cue mode

Press:

Use this to set, play and call out hot cues.

[SHIFT] + press:

Delete the hot cue set for that button.

➔ *Using hot cues* (p.19)

Sampler mode

Press:

When one of [HOT CUE/SAMPLER] buttons 1 to 3 is pressed, playback of the sample starts.

The bank switches each time [HOT CUE/SAMPLER] button 4 or 5 is pressed.

[SHIFT] + press:

When one of [HOT CUE/SAMPLER] buttons 1 to 3 is pressed, playback of the sample stops.

➔ *Using the sampler function* (p.19)

## Mixer section

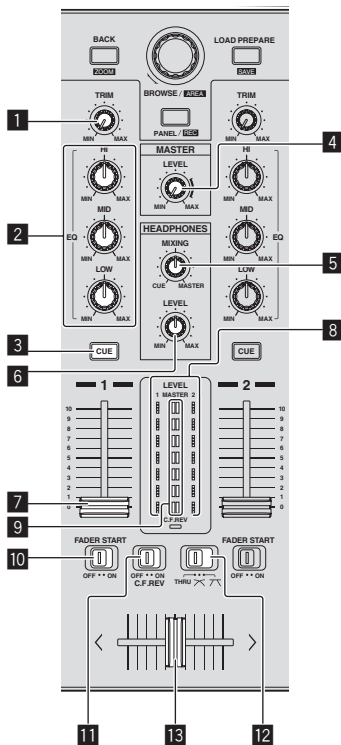

### 1 TRIM control

Adjusts the individual channel output gain.

### 2 EQ (HI, MID, LOW) controls

Boosts or cuts frequencies for the different channels.

### 3 HEADPHONES CUE button

Press:

The sound of channels for which the headphones [CUE] button is pressed is output to the headphones.

- When the headphones [CUE] button is pressed again, monitoring is canceled.

### 4 MASTER LEVEL control

Adjusts the master sound level output.

### 5 HEADPHONES MIXING control

Adjusts the balance of the monitor volume between the sound of the channels for which the headphones [CUE] button is pressed and the sound of the master channel.

## 6 HEADPHONES LEVEL control

Adjusts the audio level output from the [PHONES] terminal.

## 7 Channel fader

Adjusts the level of audio signals output in each channel.

## 8 Channel Level Indicator

Displays the sound level of the respective channels before passing through the channel faders.

## 9 Master level indicator

Displays the master output's audio level.

## 10 FADER START switch

These turn the fader start function on/off.

➔ *Starting playback using the fader (Fader Start)* (p.20)

## 11 C.F. REV switch

This reverses the channels assigned to the left and right sides of the crossfader.

[ON]: The left side of the crossfader is set to deck (2), the right side to deck (1).

[OFF]: The left side of the crossfader is set to deck (1), the right side to deck (2).

## 12 Crossfader curve selector switch

This switches the crossfader curve characteristics.

[^]: Set here for a curve that rises steeply. (When the crossfader moves away from either the left or right edge, the sound is immediately output from the opposite side.)

[∧]: Set here for a curve that rises gradually.

[THRU]: Choose this when you do not want to use the crossfader.

## 13 Crossfader

Switches between the audio output of the left and right decks.

## Effect section

The effect section is used to control two effect units (FX1 and FX2).

There are controls and buttons for operating FX1 on the left side of the controller, controls and buttons for operating FX2 on the right side of the controller. Also, the [FX CH SELECT] control is used to set the channel to which the effect is applied.

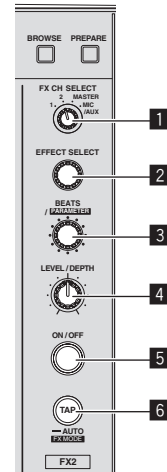

## MULTIMODE

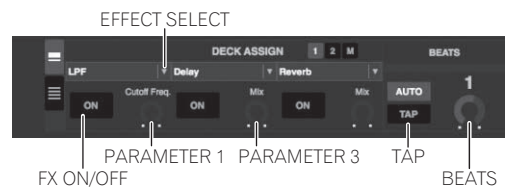

### 1 FX CH SELECT control

Switches the channel to which the effect is applied.

- Effects applied to the MIC/AUX channel cannot be used with Serato DJ ver. 1.2. They are scheduled to be supported with future version upgrades.

### 2 EFFECT SELECT control

Selects the type of effect.

### 3 BEATS (PARAMETER) control

Adjusts the effect time.

[SHIFT] + turn:

Adjusts the effect's parameter 3.

### 4 LEVEL/DEPTH control

Adjusts the effect's parameter 1.

### 5 FX ON/OFF button

Turns the effect on/off.

### 6 TAP/AUTO (FX MODE) button

Press:

The BPM used as the base value for the effect is calculated by the interval at which the button is tapped with a finger.

When the button is pressed and held, the effect time is reset.

[SHIFT] + press:

Switches the effect mode from the single mode to the multi mode.

When the [SHIFT] and [TAP/AUTO (FX MODE)] buttons are pressed again, the effect mode returns to the single mode.

### ❖ To monitor the effect sounds

When the [HEADPHONES MIXING] control is turned to the [CUE] side, the Serato DJ software's effect sounds are not output to the sound of the channels whose headphones [CUE] button are pressed.

If you want to monitor the Serato DJ software's effect sounds, turn the [HEADPHONES MIXING] control to the [MASTER] side and monitor the effect sounds in the sound of the master output.

## Microphone/External input control section

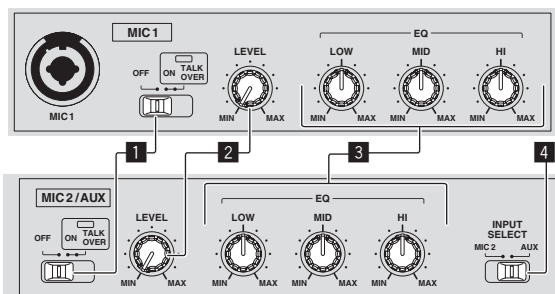

### 1 OFF, ON, MIC TALK OVER selector switch

Turns the microphone on/off.

➔ *Using a microphone* (p.21)

### 2 LEVEL control

Adjusts the level of the output sound.

### 3 EQ (HI, MID, LOW) controls

Boosts or cuts frequencies in order to change the quality of the sound.

### 4 MIC2/AUX selector switch

Switches the audio input between the microphone and the external device.

- [MIC2]: Selects the microphone connected to the [MIC2] terminal.
- [AUX]: Selects the external device connected to the [AUX IN] terminals.

➔ *Using a microphone* (p.21)

➔ *Using an external device* (p.21)

## Using the LAPTOP DOCK

The computer's keyboard section can be stowed under this unit.

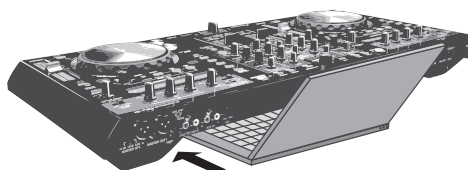

- Depending on the size of your (notebook) computer, the keyboard section may not fit in the LAPTOP DOCK.
- Install in such a way that the computer unit does not touch this unit.
- Install in such a way that the cables connected to the computer are not stuck under this unit.

## Using with the feet removed

This unit's two feet can be removed.

Use a Phillips screwdriver to remove the screws from the left and right feet (2 screws each).

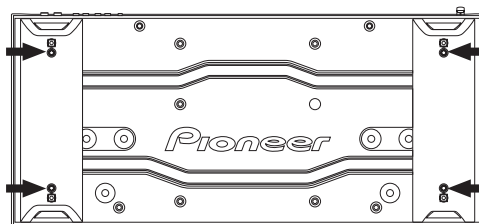

- The screws you have removed will be needed when mounting the feet. Be careful not to lose them. The feet cannot be properly mounted using other screws.

# Basic Operation

## Connections

1 Connect headphones to one of the [PHONES] terminals.

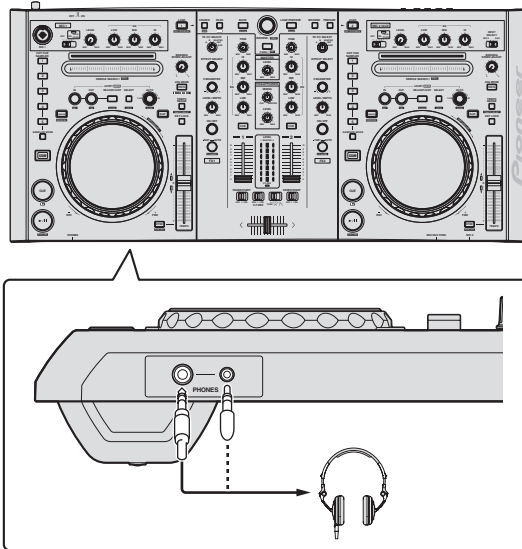

- There are two input jacks, both a stereo phones jack and a mini phones jack, but do not use both simultaneously. If both are used simultaneously, when one is disconnected and/or connected, the volume of the other may increase or decrease suddenly.

2 Connect powered speakers, a power amplifier, components, etc., to the [MASTER OUT 1] or [MASTER OUT 2] terminals.

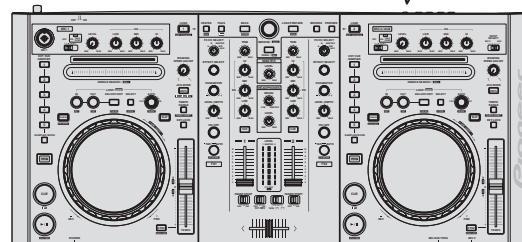
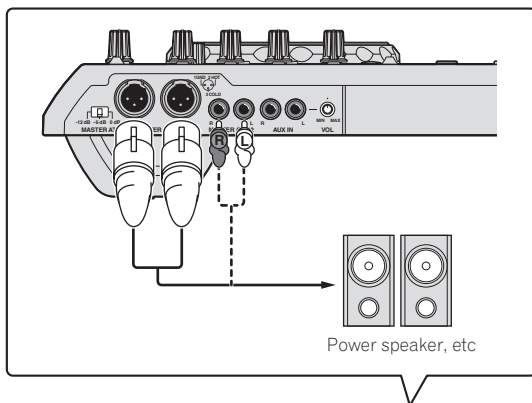

- For details on the connections of the input/output terminals, see *Connecting the input/output terminals* (p.8).

3 Connect this unit to your computer via a USB cable.

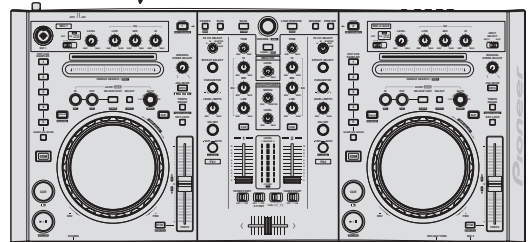
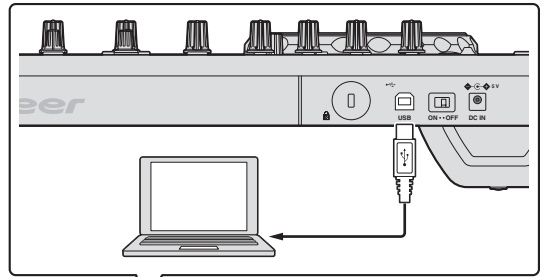

- This product satisfies electromagnetic noise regulations when it is connected to other equipment through shielded cables and connectors. Use only the furnished accessory connecting cables.

4 Turn on the computer's power.

5 Connect the power plug to the AC adapter.

Slide the power plug into the AC adapter's guide rails as shown on the diagram and press in until a click is heard.

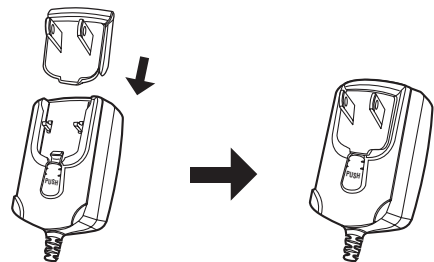

- For detailed cautions on the AC adapter, see *"About the AC adapter"* (p. 3).
- Use the appropriate power plug for the country or region you are in.

## 6 Connect the AC adapter.

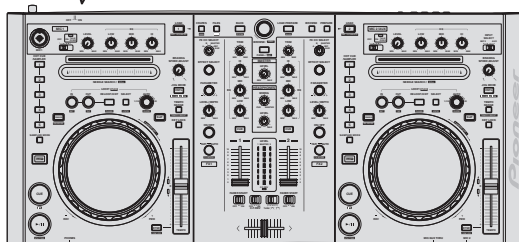
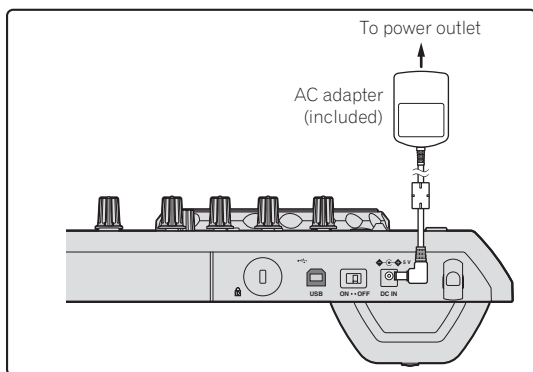

## 7 Slide the [ON/OFF] switch to the [ON] side.

Turn on the power of this unit.

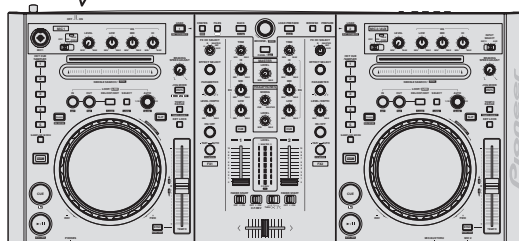
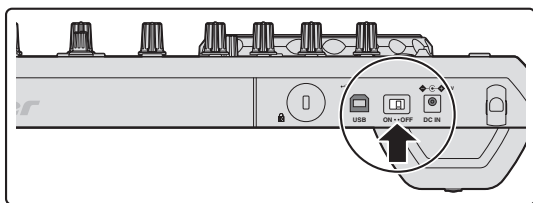

- For Windows users  
The message **[Installing device driver software]** may appear when this unit is first connected to the computer or when it is connected to a different USB port on the computer. Wait a while until the message **[Your devices are ready for use]** appears.

## 8 Turn on the power of the devices connected to the output terminals (powered speakers, power amplifier, components, etc.).

- When a microphone, DJ player or other external device is connected to input terminals, the power of that device also turns on.

# Starting the system

## Launching Serato DJ

### For Windows

From the Windows [Start] menu, click the [Serato DJ] icon under [All Programs] > [Serato] > [Serato DJ].

### For Mac OS X

In Finder, open the [Applications] folder, then click the [Serato DJ] icon.

### Computer screen directly after the Serato DJ software is launched

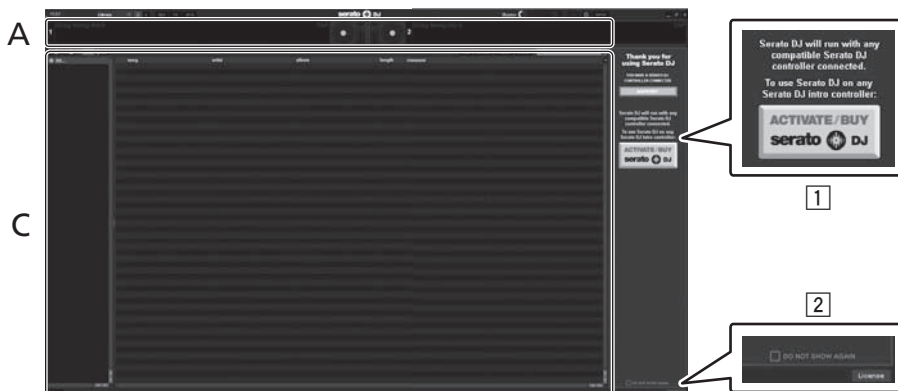

- 1 The [ACTIVATE/BUY Serato DJ] icon may appear on the right side of the screen that is displayed when Serato DJ is launched the first time, but there is no need to activate or purchase a license for those using **DDJ-S1 Serato DJ Edition**.
- 2 Check [DO NOT SHOW AGAIN] at the bottom right of the screen, then click [License] and continue to use Serato DJ as such.

### Computer screen when a track is loaded in the Serato DJ software

Click [Library] at the upper left of the computer screen, then select [Vertical] from the pull-down menu to switch the Serato DJ screen.

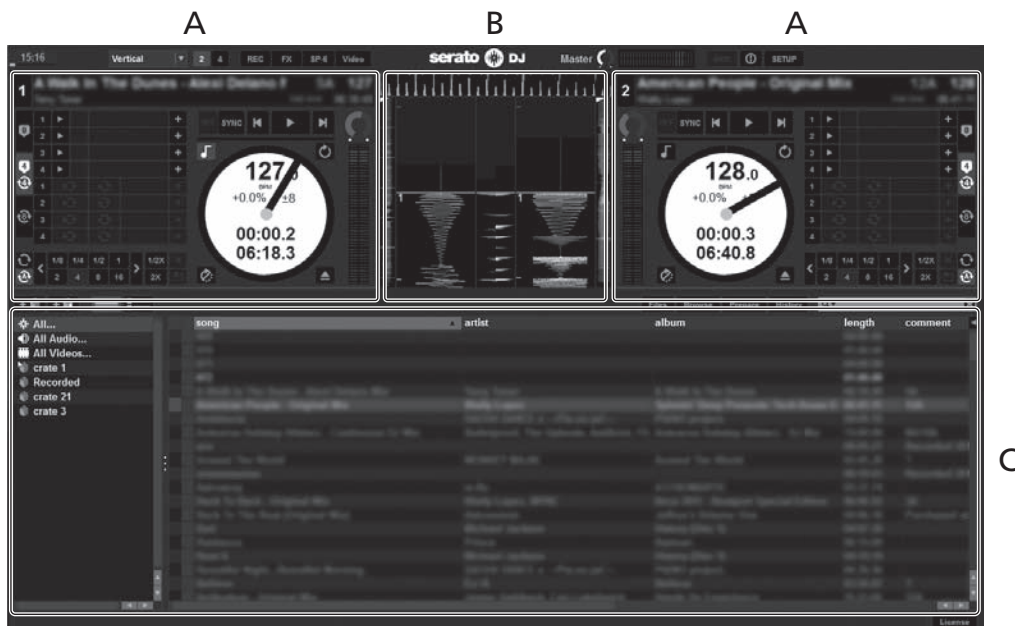

### A Deck section

The track information (the name of the loaded track, artist name, BPM, etc.), the overall waveform and other information is displayed here.

### B Waveform display

The loaded track's waveform is displayed here.

### C Browser section

Crates in which tracks in the library or sets of multiple tracks are stored are displayed here.

This manual consists mainly of explanations of functions of this unit as hardware. For detailed instructions on operating the Serato DJ software, see the Serato DJ software manual.



## Importing tracks

The following describes the typical procedure for importing tracks.

- There are various ways to import tracks with the Serato DJ software. For details, see the Serato DJ software manual.
- If you are already using Serato DJ software (Scratch Live, ITCH or Serato DJ Intro) and have already created track libraries, the track libraries you have previously created can be used as such.

### 1 Click the [Files] key on the Serato DJ software screen to open the [Files] panel.

The contents of your computer or the peripheral connected to the computer are displayed in the [Files] panel.

### 2 Click the folder on the [Files] panel containing the tracks you want to add to the library to select it.

### 3 On the Serato DJ software screen, drag and drop the selected folder to the crates panel.

A crate is created and the tracks are added to the library.

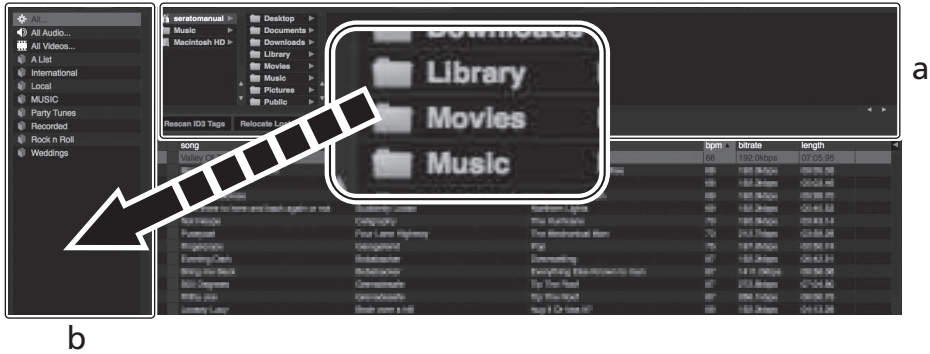

a [Files] panel  
b Crates panel

## Loading tracks and playing them

The following describes the procedure for loading tracks into deck [1] as an example.

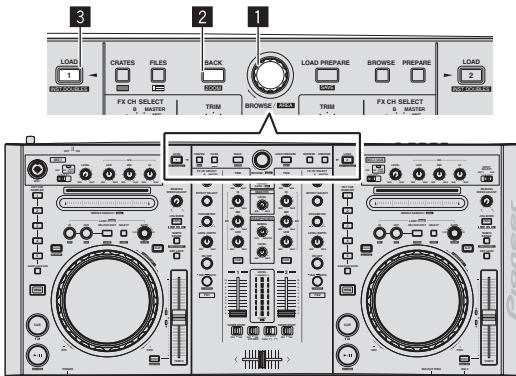

- 1 Rotary selector
- 2 BACK (LIBRARY) button
- 3 LOAD (INST.DOUBLES) button

1 Press this unit's [BACK (LIBRARY)] button, move the cursor to the crates panel on the computer's screen, then turn the rotary selector to select the crate, etc.

2 Press the rotary selector, move the cursor to the library on the computer's screen, then turn the rotary selector and select the track.



a Library  
b Crates panel

3 Press the [LOAD (INST.DOUBLES)] button to load the selected track onto the deck.

## Playing tracks and outputting the sound

The following describes the procedure for outputting the channel 1 sound as an example.

- Set the volume of the devices (power amplifier, powered speakers, etc.) connected to the [MASTER OUT 1] and [MASTER OUT 2] terminals to an appropriate level. Note that loud sound will be output if the volume is set too high.

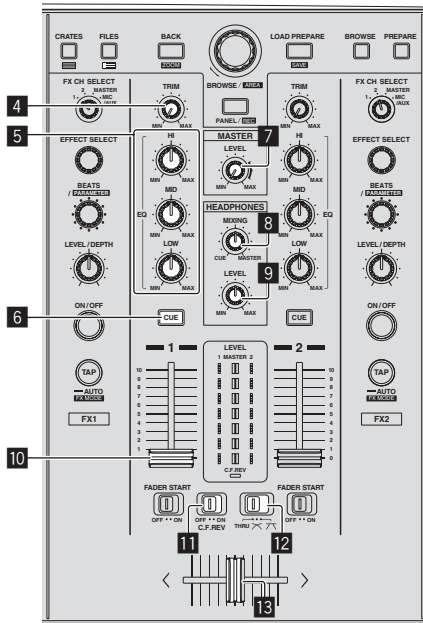

- 4 TRIM control
- 5 EQ (HI, MID, LOW) controls
- 6 Headphones CUE button
- 7 MASTER LEVEL control
- 8 HEADPHONES MIXING control
- 9 HEADPHONES LEVEL control
- 10 Channel fader
- 11 C.F. REV switch
- 12 Crossfader curve selector switch
- 13 Crossfader

1 Set the positions of the controls, etc., as shown below.

Names of controls, etc.	Position
MASTER LEVEL control	Turned fully counterclockwise
TRIM control	Turned fully counterclockwise
EQ (HI, MID, LOW) controls	Center
Channel fader	Moved forward
C.F. REV switch	[OFF] position
Crossfader curve selector switch	[THRU] position

- Press the [PLAY/PAUSE ►/II (STUTTER)] button to play the track.

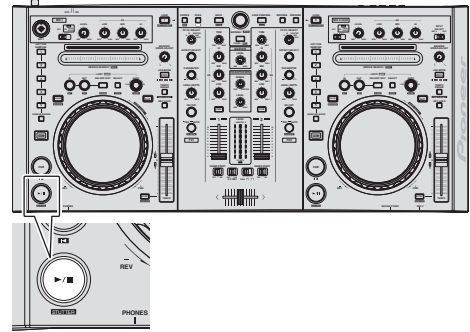

- Move the channel fader away from you.

- Turn the [TRIM] control.

Adjust [TRIM] so that the orange indicator on the channel level indicator lights at the peak level.

- Turn the [MASTER LEVEL] control to adjust the audio level of the speakers.

Adjust the sound level output from the [MASTER OUT 1] and [MASTER OUT 2] terminals to an appropriate level.

## Monitoring sound with headphones

Set the positions of the controls, etc., as shown below.

Names of controls, etc.	Position
HEADPHONES MIXING control	Center
HEADPHONES LEVEL control	Turned fully counterclockwise

- Press the headphones [CUE] button for the channel 1.

- Turn the [HEADPHONES LEVEL] control.

Adjust the sound level output from the headphones to an appropriate level.

### Note

This unit and the Serato DJ software include a variety of functions enabling individualistic DJ performances. For details on the respective functions, see the Serato DJ software manual.

- The Serato DJ software manual can be downloaded from "Serato.com". For details, see *Downloading the Serato DJ software manual* (p. 24).

## Quitting the system

- Quit [Serato DJ].

When the software is closed, a message for confirming that you want to close it appears on the computer's screen. Click [Yes] to close.

- Slide the [ON/OFF] switch to the [OFF] side.

- Disconnect the USB cable from your computer.

# Advanced Operation

The descriptions from this point on are for functions not described in the Serato DJ software manual that are specifically for when this unit and Serato DJ are used in combination.

## Using hot cues

With this function, playback can be started instantaneously from the position at which a hot cue is set.

- Hot cue operations using this unit can only be performed for hot cues 1 to 5.

### 1 Press the [SAMPLER MODE] button.

The [SAMPLER MODE] button turns off and the mode switches to the hot cue mode.

### 2 During playback or in the pause mode, press one of [HOT CUE/SAMPLER] buttons 1 to 5 to set the hot cue point.

### 3 Press the [HOT CUE/SAMPLER] button at which the hot cue was set.

Playback starts from the hot cue point.

- When the [HOT CUE/SAMPLER] button is pressed while pressing the [SHIFT] button, the hot cue point set at that button is deleted.

## Using the Loop Roll function

This function plays a loop with the number of beats assigned to the [NEEDLE SEARCH (ROLL)] pad continually while the pad is being pressed.

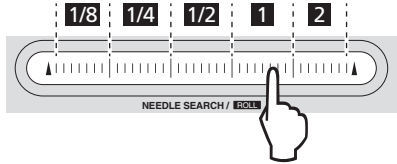

During loop roll playback, normal playback with the original rhythm continues in the background. When loop roll playback is canceled, playback resumes from the position reached in the background at the point loop roll playback was canceled.

- This function cannot be used with tracks that have been analyzed with Serato DJ Intro. To use this function with such tracks, reanalyze the tracks with Serato DJ.

### 1 Press the [NEEDLE SEARCH (ROLL)] pad while pressing the [SHIFT] button.

A loop roll with the number of beats assigned to the point at which the pad is pressed is played. Playback continues in the background while the loop roll is playing.

- During loop roll playback, the number of beats of the currently playing loop roll can be changed by turning the [AUTO LOOP (GRID SLIDE)] control.

### 2 Release your finger from the [NEEDLE SEARCH (ROLL)] pad.

Loop roll playback is canceled, and playback resumes from the position reached in the background.

## Using the sampler function

This function allows you to play sounds loaded in the sampler's (SP-6) sampler slots by operating this unit.

### 1 Press the [PANEL (REC)] button to open the [SP-6] panel on the computer's screen.

### 2 Press the [SAMPLER MODE] button.

The [SAMPLER MODE] button lights and the mode switches to the sampler mode.

### 3 Press [HOT CUE/SAMPLER] button 4 or 5.

Each time the button is pressed, the sampler's (SP-6) bank switches. The sampler has four banks, **A**, **B**, **C** and **D**, and each bank has six slots. Buttons 4 and 5 on deck 1 are assigned to banks A and B, buttons 4 and 5 on deck 2 to banks C and D.

### 4 Operating the mouse on the computer's screen, drag and drop tracks to load them into the [SP-6] panel's slots.

The sampler settings and loaded tracks are saved.

- Sampler slots 1 to 3 are assigned to [HOT CUE/SAMPLER] buttons 1 to 3 on deck 1, sampler slots 4 to 6 to [HOT CUE/SAMPLER] buttons 1 to 3 on deck 2.

### 5 Press one of [HOT CUE/SAMPLER] buttons 1 to 3 on deck 1 or one of [HOT CUE/SAMPLER] buttons 1 to 3 on deck 2.

The sound of the slot assigned to the button that was pressed is played. When a [HOT CUE/SAMPLER] button is pressed while a sample is playing, playback returns to the beginning of the sample and continues.

- When one of [HOT CUE/SAMPLER] buttons 1 to 3 is pressed while pressing the [SHIFT] button, the sound of the currently playing slot stops.

## Using the slip mode

When the slip mode is turned on, normal playback with the original rhythm continues in the background during scratching, looping and hot cue playback. When scratching, looping or hot cue playback is canceled, normal playback resumes from the position reached up to the point at which the operation was canceled.

Various performances can be achieved without breaking the rhythm.

- The [SLIP] button lights when the slip mode is set and flashes while the sound is being played in the background.

## Slip scratching

### 1 Press the [VINYL (ILLUMINATION)] button.

### 2 Press the [SLIP] button.

The mode switches to the slip mode.

### 3 During playback, operate the top of the jog dial to scratch.

Normal playback continues in the background even while scratching.

### 4 Release your hand from the top of the jog dial.

Playback starts from the position reached in the background.

- To cancel the slip mode, press the [SLIP] button again.

---

## Slip hot cue

### 1 Press the [SAMPLER MODE] button.

Set the hot cue mode.

### 2 Set the hot cue.

### 3 Press the [SLIP] button.

The mode switches to the slip mode.

### 4 During playback, press and hold a [HOT CUE/SAMPLER] button.

Playback starts from the position at which the hot cue was set. Playback continues while the [HOT CUE/SAMPLER] button is being pressed. Normal playback continues in the background while the hot cue is playing.

### 5 Release your finger from the [HOT CUE/SAMPLER] button.

Playback starts from the position reached in the background.

- To cancel the slip mode, press the [SLIP] button again.

---

## Slip braking

### 1 Turn the [BRAKING SPEED ADJUST] control.

This adjusts the speed at which the track stops from the play mode.

- When using slip braking, adjust the [BRAKING SPEED ADJUST] control to around the 9 o'clock position so that playback stops slowly.

### 2 Press the [SLIP] button.

The mode switches to the slip mode.

### 3 During playback, press the [PLAY/PAUSE ►/II (STUTTER)] button.

Playback slowly stops while the button is being pressed. Normal playback continues in the background while playback is slowly stopping.

### 4 Press the [PLAY/PAUSE ►/II (STUTTER)] button again.

Playback starts from the position reached in the background.

- To cancel the slip mode, press the [SLIP] button again.

---

## Auto slip looping

### 1 Press the [SLIP] button.

The mode switches to the slip mode.

### 2 Turn the [AUTO LOOP (GRID SLIDE)] control.

Select the auto loop beat.

### 3 Press the [AUTO LOOP (GRID SLIDE)] control.

A loop with the specified number of beats is set and loop playback starts. Normal playback continues in the background during loop playback.

### 4 Press the [AUTO LOOP (GRID SLIDE)] control again.

Looping is canceled and playback starts from the position reached in the background.

- To cancel the slip mode, press the [SLIP] button again.

---

## Manual slip looping

### ❖ Creating a loop and slipping it

#### 1 Press the [SLIP] button.

The mode switches to the slip mode.

#### 2 Press the [LOOP IN (GRID SET)] button, then press [LOOP OUT (GRID TAP)] button.

Loop playback starts.

Normal playback continues in the background even during loop playback.

#### 3 Press the [RELOOP/EXIT (GRID CLEAR)] button.

Looping is canceled and playback starts from the position reached in the background.

- To cancel the slip mode, press the [SLIP] button again.

### ❖ Slipping using a loop in a loop slot

#### 1 Press the [SLIP] button.

The mode switches to the slip mode.

#### 2 Press the [LOOP SELECT (GRID LOCK)] button and select the loop to be played.

#### 3 Press the [RELOOP/EXIT (GRID CLEAR)] button.

Loop playback starts.

Normal playback continues in the background even during loop playback.

#### 4 Press the [RELOOP/EXIT (GRID CLEAR)] button again.

Looping is canceled and playback starts from the position reached in the background.

- To cancel the slip mode, press the [SLIP] button again.

---

## Slip reverse

### 1 Press the [SLIP] button.

The mode switches to the slip mode.

### 2 Press the [CENSOR (REVERSE)] button while pressing the [SHIFT] button.

The track is played in the reverse direction.

Normal playback continues in the background even during reverse playback.

### 3 Once again, press the [CENSOR (REVERSE)] button while pressing the [SHIFT] button.

Reverse playback is canceled and playback starts from the point reached in the background.

- To cancel the slip mode, press the [SLIP] button again.

---

## Starting playback using the fader (Fader Start)

---

## Starting playback using the crossfader

### 1 Set the [FADER START] switch to [ON].

### 2 Move the crossfader.

Set to the edge opposite the side on which the channel you want to use with the fader start function is set.

### 3 Set the temporary cue point.

Playback pauses at the temporary cue point.

- If a temporary cue point is already set, press the [CUE] button to move the playback position back to that point.

### 4 Move the crossfader.

Playback starts.



- If you set the crossfader back to the original position, the player immediately returns to the temporary cue point and pauses playback (Back cue).

## Displaying the album images in the track list

The album images can be displayed in the track list. The layout of the track information and album images can be changed as desired.

Press the **[FILES]** button (or the **[CRATES]** button) while pressing the **[SHIFT]** button.

The track list display switches.

Button	Layout
<b>CRATES</b> button 	A simply display consisting only of text (default). Album art is not displayed.
<b>FILES</b> button 	A column of album art is displayed at the very left, followed by text.

## Analyzing tracks

When one of this unit's **[LOAD (INST.DOUBLES)]** buttons is pressed and tracks are loaded onto the decks, the tracks are analyzed, but some time may be required until analysis is completed and the BPM and waveform are displayed.

When the Serato DJ software is used as an offline player, tracks can be analyzed ahead of time. For tracks whose analysis has been completed, the BPM and waveform are displayed immediately when the tracks are loaded onto the decks.

For details on using the Serato DJ software as an offline player and instructions on analyzing tracks, see the Serato DJ software manual.

- Depending on the number of tracks, some time may be required for analysis.

## Using a microphone

### 1 Connect a microphone to the **[MIC1]** or **[MIC2]** terminal.

- To use the **[MIC2]** terminal, set the **[MIC2/AUX]** selector switch to **[MIC2]**.

### 2 Set the **[OFF, ON, MIC TALK OVER]** selector switch to **[ON]** or **[MIC TALK OVER]**.

- [ON]**: The indicator lights.
- [MIC TALK OVER]**: The indicator flashes.
- When set to **[MIC TALK OVER]**, the volume level of the currently playing track is automatically decreased when sound is input to the microphone. (The volume level of the sound input to the **[AUX IN]** terminals is not decreased.)

### 3 Turn the **[LEVEL]** control.

Adjust the sound level output from **[MIC1]** and **[MIC2]**.

- Pay attention that rotating to the extreme right position outputs a very loud sound.

### 4 Input audio signals to the microphone.

## Equalization

Turn the **[EQ (HI, MID, LOW)]** controls for **[MIC1]** or **[MIC2]**.

## Using an external device

### 1 Set the **[MIC2/AUX]** selector switch to **[AUX]**.

### 2 Turn clockwise the **[LEVEL]** control in the microphone/**AUX** section.

Adjusts the level of the output sound.

- If the volume level cannot be adjusted enough with the **[LEVEL]** control in the microphone/**AUX** section alone, adjust by turning the **[VOL]** control on the rear panel.

## Equalization

Turn the **[EQ (HI, MID, LOW)]** controls in the microphone/**AUX** section.

## Recording

- Recording of the input sound is not possible with Serato DJ when the **[MIC/AUX THRU]** selector switch is set to **[ON]**.

### 1 Select the channel to be recorded.

Perform this operation on the computer's screen.

- [MIX]**: The sound output from the **[MASTER OUT 1]** and **[MASTER OUT 2]** terminals can be recorded.
- [AUX]**: The sound of the **[MIC/AUX]** channel can be recorded alone.

### 2 Adjust the recording level.

Adjust the recording level using the appropriate controls for the source being recorded. The recording meter in the software shows the signal level that will be recorded to disk. We recommend that you set your levels so the loudest part of the mix causes the meter to enter the red zone only briefly.

### 3 Press the **[PANEL (REC)]** button while pressing the **[SHIFT]** button.

Recording starts.

The **[PANEL (REC)]** button flashes.

### 4 Press the **[PANEL (REC)]** button while pressing the **[SHIFT]** button.

The **[PANEL (REC)]** button turns off and recording stops.

### 5 Operate the computer to input the filename.

### 6 Press the **[LOAD PREPARE (SAVE)]** button while pressing the **[SHIFT]** button.

The recorded sound is saved.

- For details on the filenames of recorded data and where they are stored, see the Serato DJ software manual.

## Outputting the microphone and **AUX** sound directly

When the **[MIC/AUX THRU]** selector switch is set to **[ON]**, the audio signals of the connected external device and microphone are output directly without passing through the computer. Normally use with the switch set to **[OFF]**.

### 1 Set the **[MIC/AUX THRU]** selector switch to **[ON]**.

### 2 Input audio signals to the microphone or output audio signals from the external device.

- No effect is applied to the connected microphone and auxiliary equipment when the **[MIC/AUX THRU]** selector switch is set to **[ON]**.

# Additional information

## Troubleshooting

- Incorrect operation is often mistaken for trouble or malfunction. If you think that there is something wrong with this component, check the points below. Sometimes the trouble may lie in another component. Inspect the other components and electrical appliances being used. If the trouble cannot be rectified after checking the items below, ask your nearest Pioneer authorized service center or your dealer to carry out repair work.
- This unit may not operate properly due to static electricity or other external influences. In this case, proper operation may be restored by turning the power off, waiting 1 minute, then turning the power back on.

Problem	Check	Remedy
The power is not turned on.	Is the <b>[ON/OFF]</b> switch for power supply set to <b>[ON]</b> ?	Set the <b>[ON/OFF]</b> switch for power supply to <b>[ON]</b> .
This unit is not recognized.	Is the included USB cable properly connected?	Connect the included USB cable properly.
	Are you using a USB hub?	USB hubs cannot be used. Connect the computer and this unit directly using the included USB cable.
	Is the driver software properly set? (Windows)	Set the driver software properly. (With Mac OS X, no driver software is necessary.) (page 5)
This unit operates on USB bus power even when the included AC adapter is used.	Is the included AC adapter properly connected?	Mount the power plug properly on the included AC adapter. Connect the included AC adapter properly to the power outlet. (page 4) Connect the included AC adapter's DC plug properly to this unit. (page 8)
	Power does not turn on when operating on USB bus power.	Is the included USB cable properly connected?
Power does not turn on when operating on USB bus power.	The computer's USB power supply capacity may be insufficient.	Use the included AC adapter. (page 8)
	Are you using a USB hub?	USB hubs cannot be used. Connect the computer and this unit directly using the included USB cable. (page 8)
	Are you using a commercially available USB cable?	Use the included USB cable.
	Tracks are not displayed in the library.	Have music files been imported?
iTunes tracks are not displayed in the library.	Is a crate or subcrate that does not contain any tracks selected?	Either select a crate or subcrate that contains any tracks or add tracks to the crate or subcrate.
	Is <b>[Library + Display]</b> at the <b>[Library + Display]</b> tab in the <b>[SETUP]</b> menu checked?	Check <b>[Library + Display]</b> . For details on importing music files, see the Serato DJ software manual.
Music files in the library cannot be edited (changing track names, etc.).	Is a crate or subcrate that does not contain any tracks selected?	Either select a crate or subcrate that contains any tracks or add tracks to the crate or subcrate.
	Is <b>[Protect Library]</b> at the <b>[SETUP]</b> menu's <b>[Library + Display]</b> tab enabled?	Disable <b>[Protect Library]</b> .
Recording is not possible.	Is the recording level low?	Adjust the gain control on the <b>[REC]</b> panel in the Serato DJ software.
	Have you saved the recording after completing it?	Save the recording after completing it. For detailed instructions on recording, see the Serato DJ software manual.
	Is the external device or microphone properly connected?	Check the connection of the external device or microphone. (page 8)
	Is the channel you want to record properly selected?	Select the channel you want to record properly. (page 21)
No sound or small sound.	Are the <b>[TRIM]</b> control, channel faders, crossfader, <b>[INPUT SELECT]</b> switch and <b>[MASTER LEVEL]</b> control set to the proper positions?	Set the <b>[TRIM]</b> control, channel faders, crossfader, <b>[INPUT SELECT]</b> switch and <b>[MASTER LEVEL]</b> control to the proper positions.
	Are the connected powered speakers, etc., properly set?	Properly set the external input selection, volume, etc., on the powered speakers, etc.
	Are the connection cables properly connected?	Connect the connection cables properly.
	Are the terminals and plugs dirty?	Clean the terminals and plugs before making connections.
	Is the driver software properly set? (Windows)	Set the driver software properly. (With Mac OS X, no driver software is necessary.) (page 5)
	Are you operating on USB bus power?	When operating on USB bus power, the <b>[MASTER OUT 1]</b> volume decreases, the sound quality decreases, sound may not be output, etc. To use the unit without these limitations, connect the included AC adapter. (page 8)
	Is the <b>[MIC/AUX THRU]</b> selector switch set to <b>[ON]</b> ?	Set the <b>[MIC/AUX THRU]</b> selector switch to <b>[OFF]</b> . If the <b>[MIC/AUX THRU]</b> selector switch is set to <b>[ON]</b> , only the sound of the microphone or external device is output. (page 21)
	Distorted sound.	Is the <b>[MASTER LEVEL]</b> control set to the proper position?
	Is the <b>[TRIM]</b> control set to the proper position?	Adjust the <b>[TRIM]</b> control so that the channel level indicator's orange indicator lights at the peak level.
Volume of device connected to the <b>[AUX IN]</b> terminals is low and sound is distorted.	Is the <b>[AUX IN]</b> terminals' <b>[VOL]</b> control set to the proper position?	Set the audio level to a suitable level for the connected device. (page 21)

Problem	Check	Remedy
No sound is produced, or sound is distorted or noisy.	Is this unit placed near a TV?	Turn the TV's power off or install this unit and TV away from each other.
Sound being played is interrupted when using DJ software.	Is the driver software's latency value suitable?	Set the driver software's latency to a suitable value. Set the DJ software's latency to a suitable value.
Sound of an external device or microphone cannot be output.	Is the <b>[MIC2/AUX]</b> selector switch properly set? Are you operating on USB bus power?	Set the <b>[MIC2/AUX]</b> selector switch properly. (page 21) There are limitations when operating on USB bus power. To use the unit without these limitations, connect the included AC adapter. (page 8)
Sound is interrupted when the ASIO driver is set.	Has the ASIO driver been set with Serato DJ running?	Set the ASIO driver before launching Serato DJ. (page 7)
The indicator flashes and operation is strange.	—	Normal operation can be restored by disconnecting the AC adapter, waiting at least 1 minute, then reconnecting the AC adapter. If the same symptom persists, disconnect the AC adapter, then request repairs.
Serato DJ operation is unstable.	Are you using the latest version of the software? Are you using softwares other than Serato DJ at the same time? When other USB devices are connected to the computer. Are you using a USB hub? There is a problem with the USB port to which this unit is connected. Is this unit connected to a notebook computer running on its battery? The USB buffer size is too small.	Free updates of Serato DJ can be downloaded from the website. Use the most recent version. (page 5) Quit other applications to decrease the load on the computer. If operation continues to be unstable, try disabling the wireless network or other wireless connections, antivirus software, the screen saver, the low power mode, etc. (page 5) Disconnect other USB devices from the computer. When another USB audio device is connected to the computer at the same time, it may not operate or be recognized normally. USB hubs cannot be used. Connect the computer and this unit directly using the included USB cable. If your computer has multiple USB ports, try connecting this unit to a different USB port. Supply power to the notebook computer from an AC power supply. (Depending on the notebook computer's settings, the low power mode may be set when the computer is running on its battery, automatically reducing the performance of the computer itself.) (page 5) Raise the USB buffer size. (page 7)
The jog dial indicator does not light. <b>[MASTER OUT 1]</b> (XLR output) volume is low, sound quality is poor or no sound is output. <b>[MIC1]</b> , <b>[MIC2]</b> and <b>[AUX IN]</b> terminals cannot be used. The indicators are dim.	Are you operating on USB bus power?	There are limitations when operating on USB bus power. To use the unit without these limitations, connect the included AC adapter. (page 8)
Fader starting is not possible.	Are you in standby with a cue set?	Set the cue.
The BPM is not displayed. The sync and auto loop functions do not work.	Has the track been analyzed? Is <b>[Set Auto BPM]</b> checked in the offline player settings?	Analyze the file. Re-analyze the track with <b>[Set Auto BPM]</b> checked. For detailed instructions on analyzing tracks, see the Serato DJ software manual.
The BPM is displayed but not the beatgrid.	Are <b>[Set Auto BPM]</b> and <b>[Set Beatgrid]</b> checked in the offline player settings? Is <b>[Smart Sync]</b> at the <b>[DJ Preferences]</b> tab in the <b>[SETUP]</b> menu selected?	Re-analyze the track with <b>[Set Auto BPM]</b> and <b>[Set Beatgrid]</b> checked. For detailed instructions on analyzing tracks, see the Serato DJ software manual. Set the beatgrid. For detailed instructions on setting the beatgrid, see the Serato DJ software manual. The beatgrid can also be set using the buttons and controls on this unit. (page 9) With Serato DJ, <b>[SYNC PREFERENCES]</b> is set to <b>[Simple Sync]</b> by default, but this must be switched to <b>[Smart Sync]</b> in order to perform beat grid operations. For instructions on displaying the settings screen and details on the beat grid, see the Serato DJ manual.
The BPM and beatgrid are not displayed properly. The beatgrid is off beat.	Is the BPM analysis range set appropriately in the offline player settings?	Change the BPM analysis range then reanalyze the tracks. If the problem persists, set the beatgrid and BPM manually. Adjust the beatgrid. For detailed instructions on adjusting the beatgrid, see the Serato DJ software manual. The beatgrid can also be adjusted using the buttons and controls on this unit. While the track is playing, tap the <b>[TAP/AUTO (FX MODE)]</b> button in beat with the track (Tap function). The track's BPM and beatgrid can be adjusted. When the Tap function is used, the display of the deck section on the computer's screen switches to the <b>[Beatgrid Editor]</b> display. Click <b>[Edit Grid]</b> on the computer's screen. (page 13)

## Acquiring the manual

The operating instructions may be in a file in PDF format. Adobe® Reader® must be installed to read files in PDF format. If you do not have Adobe Reader, please install it from the download link on the CD-ROM's menu screen.

## Downloading the latest version of these operating instructions

### 1 Insert the CD-ROM into the computer's optical drive.

The CD-ROM menu is displayed.

If the CD-ROM's menu does not appear when the CD-ROM is inserted, perform the operations below.

- For Windows  
Open the optical drive from [**Computer** (or **My Computer**)] in the [**Start**] menu, then double-click the [**CD\_menu.exe**] icon.
- For Mac OS X  
In Finder, double-click the [**CD\_menu.app**] icon directly.

### 2 When the CD-ROM's menu is displayed, select [DDJ-S1: Operating Instructions (PDF file/Download)], then click [Start].

### 3 "An internet environment is required to access the site. Connected to the internet?" is displayed. Click [Yes].

The web browser is launched and the Pioneer DJ support site is displayed.

### 4 On the Pioneer DJ support site, click "Manuals" under "DDJ-S1 Serato DJ Edition".

### 5 Click on the required language on the download page.

Downloading of the operating instructions begins.

## Downloading the Serato DJ software manual

### 1 Insert the CD-ROM into the computer's optical drive.

The CD-ROM menu is displayed.

If the CD-ROM's menu does not appear when the CD-ROM is inserted, perform the operations below.

- For Windows  
Open the optical drive from [**Computer** (or **My Computer**)] in the [**Start**] menu, then double-click the [**CD\_menu.exe**] icon.
- For Mac OS X  
In Finder, double-click the [**CD\_menu.app**] icon directly.

### 2 When the CD-ROM's menu is displayed, select [Serato DJ: Serato DJ Software Manual (PDF file/Download)], then click [Start].

### 3 "An internet environment is required to access the site. Connected to the internet?" is displayed. Click [Yes].

The web browser is launched and the Pioneer DJ support site is displayed.

- To close the CD-ROM menu, click [**Exit**].

### 4 Click [Software Info] under [DDJ-S1 Serato DJ Edition] on the Pioneer DJ support site.

[Serato DJ Support Information] is displayed.

### 5 Click the link to the Serato DJ download page.

The Serato DJ download page is displayed.

### 6 Log in to your "Serato.com" user account.

Input the e-mail address and password you have registered to log in to "Serato.com".

### 7 From "More Downloads" on the right side of the download page, click "Serato DJ x.x.x Software Manual".

Downloading of the Serato DJ software manual starts.

## Using as a controller for other DJ software

This unit also outputs the operating data for the buttons and dials in MIDI format. If you connect a computer with a built-in MIDI-compatible DJ software via a USB cable, you can operate the DJ software on this unit. The sound of music files being played on the computer can also be output from the DDJ-S1.

When using this unit as a controller for operating DJ software other than Serato DJ, change the setting to use DJ software other than Serato DJ at the utility settings. Also, make the audio and MIDI-related settings in the DJ software.

- For details, see your DJ software's operating instructions.

## About MIDI messages

For details on this unit's MIDI messages, see "List of MIDI Messages".

- "List of MIDI Messages" can be acquired from the following URL:  
<http://pioneerdj.com/support/>

## About the driver software (Windows)

This driver software is an exclusive ASIO driver for outputting audio signals from the computer.

- There is no need to install the driver software when using Mac OS X.
- First read the *Software end user license agreement* on page 24 carefully.

## Operating environment

Supported operating systems		
Windows® 7 Home Premium/Professional/Ultimate	32-bit version	✓
	64-bit version	✓ <sup>[1]</sup>
Windows Vista® Home Basic/Home Premium/Business/Ultimate	32-bit version	✓
	64-bit version	✓ <sup>[1]</sup>
Windows® XP Home Edition/Professional (SP2 or later)	32-bit version	✓

[1] When using a 64-bit version of Windows, the driver software can only be used for 32-bit applications.

## Checking the latest information on the driver software

For detailed information on this unit's designated driver software, see the Pioneer DJ support site below.  
<http://pioneerdj.com/support/>

## About the installation procedure

- For the operating procedure, see *Installation Procedure (Windows)*.

## ❖ Software end user license agreement

This Software End User License Agreement ("Agreement") is between you (both the individual installing the Program and any single legal entity for which the individual is acting) ("You" or "Your") and PIONEER CORPORATION ("Pioneer").

TAKING ANY STEP TO SET UP OR INSTALL THE PROGRAM MEANS THAT YOU ACCEPT ALL OF THE TERMS OF THIS LICENSE AGREEMENT. PERMISSION TO DOWNLOAD AND/OR USE THE PROGRAM IS EXPRESSLY CONDITIONED ON YOUR FOLLOWING THESE TERMS. WRITTEN OR ELECTRONIC APPROVAL IS NOT REQUIRED TO MAKE THIS AGREEMENT VALID AND ENFORCEABLE. IF YOU DO NOT AGREE TO ALL OF THE TERMS OF THIS AGREEMENT, YOU ARE NOT AUTHORIZED TO USE THE PROGRAM AND MUST STOP INSTALLING IT OR UNINSTALL IT, AS APPLICABLE.

## 1 DEFINITIONS

- 1 "Documentation" means written documentation, specifications and help content made generally available by Pioneer to aid in installing and using the Program.
- 2 "Program" means all or any part of Pioneer's software licensed to You by Pioneer under this Agreement.



## 2 PROGRAM LICENSE

- 1 Limited License. Subject to this Agreement's restrictions, Pioneer grants to You a limited, non-exclusive, non-transferable, license (without the right to sublicense):
  - a To install a single copy of the Program on the hard disk drive of Your computer, to use the Program only for Your personal purpose complying with this Agreement and the Documentation ("Authorized Use");
  - b To use the Documentation in support of Your Authorized Use; and
  - c To make one copy of the Program solely for backup purposes, provided that all titles and trademark, copyright and restricted rights notices are reproduced on the copy.
- 2 Restrictions. You will not copy or use the Program or Documentation except as expressly permitted by this Agreement. You will not transfer, sublicense, rent, lease or lend the Program, or use it for third-party training, commercial time-sharing or service bureau use. You will not Yourself or through any third party modify, reverse engineer, disassemble or decompile the Program, except to the extent expressly permitted by applicable law, and then only after You have notified Pioneer in writing of Your intended activities. You will not use the Program on multiple processors without Pioneer's prior written consent.
- 3 Ownership. Pioneer or its licensor retains all right, title and interest in and to all patent, copyright, trademark, trade secret and other intellectual property rights in the Program and Documentation, and any derivative works thereof. You do not acquire any other rights, express or implied, beyond the limited license set forth in this Agreement.
- 4 No Support. Pioneer has no obligation to provide support, maintenance, upgrades, modifications or new releases for the Program or Documentation under this Agreement.

## 3 WARRANTY DISCLAIMER

THE PROGRAM AND DOCUMENTATION ARE PROVIDED "AS IS" WITHOUT ANY REPRESENTATIONS OR WARRANTIES, AND YOU AGREE TO USE THEM AT YOUR SOLE RISK. TO THE FULLEST EXTENT PERMISSIBLE BY LAW, PIONEER EXPRESSLY DISCLAIMS ALL WARRANTIES OF ANY KIND WITH RESPECT TO THE PROGRAM AND DOCUMENTATION, WHETHER EXPRESS, IMPLIED, STATUTORY, OR ARISING OUT OF COURSE OF PERFORMANCE, COURSE OF DEALING OR USAGE OF TRADE, INCLUDING ANY WARRANTIES OF MERCHANTABILITY, FITNESS FOR A PARTICULAR PURPOSE, SATISFACTORY QUALITY, ACCURACY, TITLE OR NON-INFRINGEMENT.

## 4 DAMAGES AND REMEDIES FOR BREACH

You agree that any breach of this Agreement's restrictions would cause Pioneer irreparable harm for which money damages alone would be inadequate. In addition to damages and any other remedies to which Pioneer may be entitled, You agree that Pioneer may seek injunctive relief to prevent the actual, threatened or continued breach of this Agreement.

## 5 TERMINATION

Pioneer may terminate this Agreement at any time upon Your breach of any provision. If this Agreement is terminated, You will stop using the Program, permanently delete it from the computer where it resides, and destroy all copies of the Program and Documentation in Your possession, confirming to Pioneer in writing that You have done so. Sections 2.2, 2.3, 2.4, 3, 4, 5 and 6 will continue in effect after this Agreement's termination.

## 6 GENERAL TERMS

- 1 Limitation of Liability. In no event will Pioneer or its subsidiaries be liable in connection with this Agreement or its subject matter, under any theory of liability, for any indirect, incidental, special, consequential or punitive damages, or damages for lost profits, revenue, business, savings, data, use, or cost of substitute procurement, even if advised of the possibility of such damages or if such damages are foreseeable. In no event will Pioneer's liability for all damages exceed the amounts actually paid by You to Pioneer or its subsidiaries for the Program. The parties acknowledge that the liability limits and risk allocation in this Agreement are reflected in the Program price and are essential elements of the bargain between the parties, without which Pioneer would not have provided the Program or entered into this Agreement.

- 2 The limitations or exclusions of warranties and liability contained in this Agreement do not affect or prejudice Your statutory rights as consumer and shall apply to You only to the extent such limitations or exclusions are permitted under the laws of the jurisdiction where You are located.
- 3 Severability and Waiver. If any provision of this Agreement is held to be illegal, invalid or otherwise unenforceable, that provision will be enforced to the extent possible or, if incapable of enforcement, deemed to be severed and deleted from this Agreement, and the remainder will continue in full force and effect. The waiver by either party of any default or breach of this Agreement will not waive any other or subsequent default or breach.
- 4 No Assignment. You may not assign, sell, transfer, delegate or otherwise dispose of this Agreement or any rights or obligations under it, whether voluntarily or involuntarily, by operation of law or otherwise, without Pioneer's prior written consent. Any purported assignment, transfer or delegation by You will be null and void. Subject to the foregoing, this Agreement will be binding upon and will inure to the benefit of the parties and their respective successors and assigns.
- 5 Entire Agreement. This Agreement constitutes the entire agreement between the parties and supersedes all prior or contemporaneous agreements or representations, whether written or oral, concerning its subject matter. This Agreement may not be modified or amended without Pioneer's prior and express written consent, and no other act, document, usage or custom will be deemed to amend or modify this Agreement.
- 6 You agree that this Agreement shall be governed and construed by and under the laws of Japan.

## About trademarks and registered trademarks

- Pioneer is a registered trademark of PIONEER CORPORATION.
- Microsoft, Windows and Windows Vista are either registered trademarks or trademarks of Microsoft Corporation in the United States and/or other countries.
- Mac OS, iTunes, and Finder are trademarks of Apple Inc., registered in the U.S. and other countries.
- Intel and Intel Core are trademarks of Intel Corporation in the U.S. and/or other countries.
- ASIO is a trademark of Steinberg Media Technologies GmbH.
- Serato DJ, Scratch Live, ITCH and Serato DJ Intro are registered trademarks of Serato.

The names of companies and products mentioned herein are the trademarks of their respective owners.

This product has been licensed for nonprofit use. This product has not been licensed for commercial purposes (for profit-making use), such as broadcasting (terrestrial, satellite, cable or other types of broadcasting), streaming on the Internet, Intranet (a corporate network) or other types of networks or distributing of electronic information (online digital music distribution service). You need to acquire the corresponding licenses for such uses. For details, see <http://www.mp3licensing.com>.

## Cautions on copyrights

Recordings you have made are for your personal enjoyment and according to copyright laws may not be used without the consent of the copyright holder.

- Music recorded from CDs, etc., is protected by the copyright laws of individual countries and by international treaties. It is the full responsibility of the person who has recorded the music to ensure that it is used legally.
- When handling music downloaded from the Internet, etc., it is the full responsibility of the person who has downloaded the music to ensure that it is used in accordance with the contract concluded with the download site.

---

---

## Specifications

### AC adapter

Power .....	AC 100 V to 240 V, 50 Hz/60 Hz
Rated current .....	300 mA
Rated output .....	DC 5 V, 2 A

### General – Main Unit

Power consumption (when using AC adapter) .....	1.4 A
Main unit weight .....	5.0 kg (11 lb)
Max. dimensions .....	680 mm (W) × 95.2 mm (H) × 318 mm (D) (26.8 in. (W) × 3.7 in. (H) × 12.5 in. (D))
Tolerable operating temperature .....	+5 °C to +35 °C (+41 °F to +95 °F)
Tolerable operating humidity .....	5 % to 85 % (no condensation)

### Audio Section (when using AC adapter/when playing on computer)

Rated output level

<b>MASTER OUT 1</b> .....	16 Vrms
<b>MASTER OUT 2</b> .....	3 Vrms

Total harmonic distortion

<b>MASTER OUT 1</b> .....	0.006 %
<b>MASTER OUT 2</b> .....	0.006 %

Frequency characteristic

<b>MASTER OUT 1</b> .....	20 Hz to 20 kHz
<b>MASTER OUT 2</b> .....	20 Hz to 20 kHz

S/N ratio

<b>MASTER OUT 1</b> .....	101 dB (at rated output)
<b>MASTER OUT 2</b> .....	101 dB (at rated output)

Input / Output terminals

**USB** terminal

B type .....	1 set
--------------	-------

**MASTER OUT 1** output terminal

XLR connector .....	1 set
---------------------	-------

**MASTER OUT 2** output terminal

RCA pin jacks .....	1 set
---------------------	-------

**PHONES** output terminal

Stereo phone jack (Ø 6.3 mm) .....	1 set
------------------------------------	-------

Stereo mini phone jack (Ø 3.5 mm) .....	1 set
---	-------

**AUX** input terminal

RCA pin jacks .....	1 set
---------------------	-------

**MIC1** terminal

XLR connector/phone jack (Ø 6.3 mm) .....	1 set
---	-------

**MIC2** terminal

Phone jack (Ø 6.3 mm) .....	1 set
-----------------------------	-------

For improvement purposes, specifications and design of this unit and the included software are subject to change without notice.

© 2013 PIONEER CORPORATION.

All rights reserved.

PIONEER CORPORATION

1-1, Shin-ogura, Saiwai-ku, Kawasaki-shi, Kanagawa 212-0031, Japan

<DRI1136-A>

## Free Manuals Download Website

<http://myh66.com>

<http://usermanuals.us>

<http://www.somanuals.com>

<http://www.4manuals.cc>

<http://www.manual-lib.com>

<http://www.404manual.com>

<http://www.luxmanual.com>

<http://aubethermostatmanual.com>

Golf course search by state

<http://golfingnear.com>

Email search by domain

<http://emailbydomain.com>

Auto manuals search

<http://auto.somanuals.com>

TV manuals search

<http://tv.somanuals.com>