

Pioneer *sound.vision.soul*

DVD Player

DV-360

DV-464

DV-2650



Operating Instructions

RW
COMPATIBLE

IMPORTANT



The lightning flash with arrowhead symbol, within an equilateral triangle, is intended to alert the user to the presence of uninsulated "dangerous voltage" within the product's enclosure that may be of sufficient magnitude to constitute a risk of electric shock to persons.

CAUTION
RISK OF ELECTRIC SHOCK
DO NOT OPEN



CAUTION:
TO PREVENT THE RISK OF ELECTRIC SHOCK, DO NOT REMOVE COVER (OR BACK). NO USER-SERVICEABLE PARTS INSIDE. REFER SERVICING TO QUALIFIED SERVICE PERSONNEL.

The exclamation point within an equilateral triangle is intended to alert the user to the presence of important operating and maintenance (servicing) instructions in the literature accompanying the appliance.

H002_En

CAUTION

This product contains a laser diode of higher class than 1. To ensure continued safety, do not remove any covers or attempt to gain access to the inside of the product.

Refer all servicing to qualified personnel.

The following caution label appears on your unit.

Location: rear of the unit



H018A_En

This product complies with the Low Voltage Directive (73/23/EEC, amended by 93/68/EEC), EMC Directives (89/336/EEC, amended by 92/31/EEC and 93/68/EEC).

H015A_En

CAUTION: THE STANDBY/ON BUTTON IS SECONDARY CONNECTED AND THEREFORE DOES NOT SEPARATE THE UNIT FROM MAINS POWER IN STANDBY POSITION. THEREFORE INSTALL THE UNIT SUITABLE PLACES EASY TO DISCONNECT THE MAINS PLUG IN CASE OF THE ACCIDENT. THE MAINS PLUG OF UNIT SHOULD BE UNPLUGGED FROM THE WALL SOCKET WHEN LEFT UNUSED FOR A LONG PERIOD OF TIME.

H017B_En

WARNING: THE APPARATUS IS NOT WATER-PROOFS, TO PREVENT FIRE OR SHOCK HAZARD, DO NOT EXPOSE THIS APPARATUS TO RAIN OR MOISTURE AND DO NOT PUT ANY WATER SOURCE NEAR THIS APPARATUS, SUCH AS VASE, FLOWER POT, COSMETICS CONTAINER AND MEDICINE BOTTLE ETC.

H001A_En

WARNING: Slot and openings in the cabinet are provided for ventilation and to ensure reliable operation of the product and to protect it from overheating, to prevent fire hazard, the openings should never be blocked and covered with items, such as newspapers, table-cloths, curtains, etc. Also do not put the apparatus on the thick carpet, bed, sofa, or fabric having a thick pile.

H040_En

On the top of the player

CAUTION	: VISIBLE AND INVISIBLE LASER RADIATION WHEN OPEN. AVOID EXPOSURE TO BEAM.
VORSICHT	: SICHTBARE UND UNSICHTBARE LASERSTRAHLUNG, WENNABDECKUNG GEÖFFNET. NICHT DEM STRAHL AUSSETZEN!
ADVARSEL	: SYNLIG OG USYNLIG LASERSTRÅLING VED ÅBNING UNDGÅ UDSÆTTELSE FOR STRÅLING.
VARNING	: SYNLIG OCH OSYNLIG LASERSTRÅLNING NÄR DENNA DEL ÄR ÖPPNAD BETRÄKTA EJ STRÅLNING.
VARO!	: AVATTAESSA AL TISTUT NÄKYVÄ JA NÄKYMÄTTÖMÄLLE LASERSATEIL YLLE. ÄLÄ KATSO SÄTEESEEN.
CUIDADO	: RADIACION LASER VISIBLE E INVISIBLE AL ESTAR ABIERTO. EVITAR EXPOSICION AL RAYO.

VPM11872

WARNING: BEFORE PLUGGING IN THE UNIT FOR THE FIRST TIME, READ THE FOLLOWING SECTION CAREFULLY. THE VOLTAGE OF THE AVAILABLE POWER SUPPLY DIFFERS ACCORDING TO COUNTRY OR REGION. BE SURE THAT THE POWER SUPPLY VOLTAGE OF THE AREA WHERE THIS UNIT WILL BE USED MEETS THE REQUIRED VOLTAGE (E.G., 230V OR 120V) WRITTEN ON THE REAR PANEL.

H041A_En

This product is for general household purposes. Any failure due to use for other than household purposes (such as long-term use for business purposes in a restaurant or use in a car or ship) and which requires repair will be charged for even during the warranty period.

K041_En

WARNING: NO NAKED FLAME SOURCES, SUCH AS LIGHTED CANDLE, SHOULD BE PLACED ON THE APPARATUS. IF NAKED FLAME SOURCES ACCIDENTALLY FALL DOWN, FIRE SPREAD OVER THE APPARATUS THEN MAY CAUSE FIRE.

H044_En

This product incorporates copyright protection technology that is protected by method claims of certain U.S. patents and other intellectual property rights owned by Macrovision Corporation and other rights owners. Use of this copyright protection technology must be authorized by Macrovision Corporation, and is intended for home and other limited viewing uses only unless otherwise authorized by Macrovision Corporation. Reverse engineering or disassembly is prohibited.

OPERATING ENVIRONMENT

Operating environment temperature and humidity:

$\pm 5^{\circ}\text{C} - +35^{\circ}\text{C}$ ($+41^{\circ}\text{F} - +95^{\circ}\text{F}$); less than 85%RH (cooling vents not blocked)

Do not install in the following locations

- Location exposed to direct sunlight or strong artificial light
- Location exposed to high humidity, or poorly ventilated location

H045_En

When disposing of used batteries, please comply with governmental regulations or environmental public instruction's rules that apply in your country or area.

H048_En

This product includes FontAvenue® fonts licenced by NEC corporation. FontAvenue is a registered trademark of NEC Corporation.

Replacement and mounting of an AC plug on the power supply cord of this unit should be performed only by qualified service personnel.

IMPORTANT

FOR USE IN THE UNITED KINGDOM

The wires in this mains lead are coloured in accordance with the following code :

Blue : Neutral
Brown : Live

If the plug provided is unsuitable for your socket outlets, the plug must be cut off and a suitable plug fitted.

The cut-off plug should be disposed of and must not be inserted into any 13 amp socket as this can result in electric shock. The plug or adaptor or the distribution panel should be provided with 5 A fuse. As the colours of the wires in the mains lead of this appliance may not correspond with coloured markings identifying the terminals in your plug, proceed as follows :

The wire which is coloured blue must be connected to the terminal which is marked with the letter N or coloured black.

The wire which is coloured brown must be connected to the terminal which is marked with the letter L or coloured red.

Do not connect either wire to the earth terminal of a three pin plug.

NOTE

After replacing or changing a fuse, the fuse cover in the plug must be replaced with a fuse cover which corresponds to the colour of the insert in the base of the plug or the word that is embossed on the base of the plug, and the appliance must not be used without a fuse cover. If lost, replacement fuse covers can be obtained from: your dealer.

Only 5 A fuses approved by B.S.I. or A.S.T.A to B.S. 1362 should be used.

H005BEn

Thank you for buying this Pioneer product.

Please read through these operating instructions so that you will know how to operate your model properly. After you have finished reading the instructions, put them in a safe place for future reference.

Contents

01 Before you start

Features	6
What's in the box	7
Putting the batteries in the remote control	7
Using the remote control	7
Disc / content format playback compatibility	8
General disc compatibility	8
CD-R/RW compatibility	8
DVD-R/RW compatibility	8
PC-created disc compatibility	8
About WMA	9
Compressed audio compatibility	9
JPEG file compatibility	10

02 Connecting up

Rear panel connections	11
Easy connections	12
Connecting using the S-video output	13
Connecting using the AV connector output	14
Connecting to an AV receiver	14

03 Controls and displays

Front panel	16
Display	18
Remote control	19

04 Getting started

Switching on	21
Let's Get Started	21

Using the on-screen displays	22
Setting up with the Setup Navigator	23
Playing discs	25
Basic playback controls	26
Resume and Last Memory	27
DVD-Video disc menus	28
Video CD PBC menus	28

05 Playing discs

Introduction	29
Using the Disc Navigator to browse the contents of a disc	29
Scanning discs	30
Playing in slow motion	30
Frame advance/frame reverse	31
Looping a section of a disc	31
Using repeat play	32
Using random play	33
Creating a program list	34
Editing a program list	35
Other functions available from the program menu	36
Searching a disc	36
Switching subtitles	37
Switching DVD audio language	37
Switching VR format DVD-RW audio channel	37
Switching Video CD audio channel	37
Zooming the screen	38
Switching camera angles	38
Displaying disc information	38

06 Viewing JPEG discs

Viewing JPEG discs	40
Using the JPEG Disc Navigator and Photo Browser	40
Zooming the screen	41

07 Audio Settings menu

Audio DRC	42
Virtual Surround	42

08 Video Adjust menu

Video Adjust	44
Creating your own presets	44

09 Initial Settings menu

Using the Initial Settings menu	46
Digital Audio Out settings	46
Digital Out	46
Dolby Digital Out	46
DTS Out	47
96kHz PCM Out	47
MPEG Out	47
Video Output settings	48
TV Screen	48
AV Connector Out	48
S-Video Out	48
Language settings	49
Audio Language	49
Subtitle Language	49
DVD Menu Language	50
Subtitle Display	50
Display settings	50
OSD Language	50
On Screen Display	50
Angle Indicator	50
Options	51
Parental Lock	51
PhotoViewer	53

010 Additional information

Taking care of your player and discs	54
Handling discs	54
Storing discs	54
Discs to avoid	55
Cleaning the unit's exterior	55
Cleaning the pickup lens	55
Problems with condensation	55
Hints on installation	55
Moving the player	56
Power cable caution	56
Screen sizes and disc formats	56
Widescreen TV users	56
Standard TV users	56
Setting the TV system	57
Watching NTSC on a PAL TV (MOD. PAL)	57
Resetting the player	58
Titles, chapters and tracks	58
DVD-Video regions	58
Selecting languages using the language code list	58
Language code list	59
Country code list	59
Glossary	60
Specifications	62

Chapter 1

Before you start

Features

24-bit/192kHz compatible DAC

This player is fully compatible with high sampling-rate discs, capable of delivering better-than-CD sound quality in terms of dynamic range, low-level resolution and high-frequency detail.

Excellent audio performance with Dolby^{*1} Digital and DTS^{*2} software

Logos:  

When connected to a suitable AV amplifier or receiver, this player gives great surround sound with Dolby Digital and DTS discs.

TruSurround^{*3} and Virtual Dolby Digital

Logo: 

TruSurround/Virtual Dolby Digital creates a realistic surround-sound effect from any Dolby Digital source using just two speakers. See *Virtual Surround* on page 42.

Picture zoom

While a DVD or Video CD is playing, you can zoom in on any part of the picture at up to 4x magnification for a closer look. See *Zooming the screen* on page 38.

MP3 and WMA compatibility

This player is compatible with CD-R, CD-RW and CD-ROM discs that contain MP3 or WMA audio tracks. See also *Compressed audio compatibility* on page 9.

Graphical on-screen displays

Setting up and using your DVD player is made very easy using the graphical on-screen displays.

Energy saving design

This player features an auto power-off function. If the player is not used for over 30 minutes, it automatically switches itself into standby.

This unit is designed to use 0.18 W of power when in standby mode.

**1 Manufactured under license from Dolby Laboratories. "Dolby" and the double-D symbol are trademarks of Dolby Laboratories.*

**2 "DTS" and "DTS Digital Out" are registered trademarks of Digital Theater Systems, Inc.*

**3 TruSurround and the  symbol are trademarks of SRS Labs, Inc. TruSurround technology is incorporated under license from SRS Labs, Inc.*

What's in the box

Please confirm that the following accessories are in the box when you open it.

- Remote control
- AA/R6P dry cell batteries x2
- Audio/video cable (red/white/yellow plugs)
- Power cable
- Operating instructions
- Warranty card

Putting the batteries in the remote control



Important

Incorrect use of batteries can result in hazards such as leakage and bursting. Please observe the following:

- Don't mix new and old batteries together.
- Don't use different kinds of battery together—although they may look similar, different batteries may have different voltages.
- Make sure that the plus and minus ends of each battery match the indications in the battery compartment.
- Remove batteries from equipment that isn't going to be used for a month or more.
- When disposing of used batteries, please comply with governmental regulations or environmental public instruction's rules that apply in your country or area.

H048 En

1 Open the battery compartment cover on the back of the remote control.

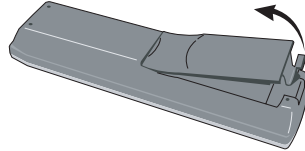

2 Insert two AA/R6P batteries into the battery compartment following the indications (+, -) inside the compartment.

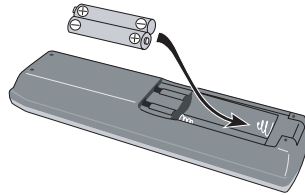

3 Close the cover.

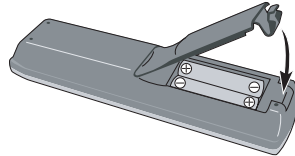

Using the remote control

Keep in mind the following when using the remote control:

- Make sure that there are no obstacles between the remote and the remote sensor on the unit.
- The remote has a range of about 7m.
- Remote operation may become unreliable if strong sunlight or fluorescent light is shining on the unit's remote sensor.
- Remote controllers for different devices can interfere with each other. Avoid using remotes for other equipment located close to this unit.

- Replace the batteries when you notice a fall off in the operating range of the remote.

Disc / content format playback compatibility

General disc compatibility

This player was designed and engineered to be compatible with software bearing one or more of the following logos:



- Kodak Picture CD
-  is a trademark of Fuji Photo Film Co. Ltd.

Other formats, including but not limited to the following, are not playable in this player:

DVD-Audio / SACD / DVD-RAM DVD-ROM / CD-ROM*

- * *Except those that contain MP3, WMA or JPEG. See also Compressed audio compatibility and JPEG file compatibility below.*

DVD-R/RW and CD-R/RW discs (Audio CDs and Video CDs) recorded using a DVD recorder, CD recorder or personal computer may not be playable on this unit. This may be caused by a number of possibilities, including but not limited to: the type of disc used; the

type of recording; damage, dirt or condensation on either the disc or the player's pick-up lens. See below for notes about particular software and formats.

CD-R/RW compatibility

- This unit will play CD-R and CD-RW discs recorded in CD Audio or Video CD format, or as a CD-ROM containing MP3, WMA or JPEG files. However, any other content may cause the disc not to play, or create noise/distortion in the output.
- This unit cannot record CD-R or CD-RW discs.
- Unfinalized CD-R/RW discs recorded as CD Audio can be played, but the full Table of Contents (playing time, etc.) will not be displayed.

DVD-R/RW compatibility

- This unit will play DVD-R/RW discs recorded using the DVD-Video format that have been finalized using a DVD-recorder.
- This unit will play DVD-RW discs recorded using the Video Recording (VR) format.
- **DVD-RW** shows in the display when a VR format DVD-RW disc is loading.
- When playing a VR format DVD-RW discs that was edited on a DVD recorder, the screen may go momentarily black at edited points and/or you may see scenes from immediately before the edited point.
- This unit cannot record DVD-R/RW discs.
- Unfinalized DVD-R/RW discs cannot be played in this player.

PC-created disc compatibility

- If you record a disc using a personal computer, even if it is recorded in a "compatible format" as listed above, there will be cases in which the disc may not be

playable in this machine due to the setting of the application software used to create the disc. In these particular instances, check with the software publisher for more detailed information.

- Check the DVD-R/RW or CD-R/RW software disc boxes for additional compatibility information.

About WMA



The Windows Media™ logo printed on the box indicates that this player can playback WMA data.

WMA is short for Windows Media Audio and refers to an audio compression technology developed by Microsoft Corporation. WMA data can be encoded by using Windows Media Player version 8 (or less) or Windows Media Player for Windows XP.

Windows Media, and the Windows logo are trademarks, or registered trademarks of Microsoft Corporation in the United States and/or other countries.

Compressed audio compatibility

- This unit will play CD-ROM, CD-R, and CD-RW discs containing files saved in the MPEG-1 Audio Layer 3 (MP3) or Windows Media Audio (WMA) format with a sampling rate of 32, 44.1 or 48kHz. Incompatible files will not play and the message **Can't play this format** will be displayed (**NO PLAY** in the front panel display).
- Fixed bit-rate MP3 files are recommended. Variable bit-rate (VBR) MP3 files are playable, but playing time may not be shown correctly.
- This player is compatible with WMA data encoded using Windows Media Player version 8 (or less) or Windows Media Player for Windows XP.
- This player is not compatible with loss-less-encoding or variable bit-rate (VBR) WMA files.
- WMA files encoded with DRM (Digital Rights Management) copy protection will not play and the message **Can't play this format** will be displayed (**NO PLAY** in the front panel display).
- The CD-ROM used to compile your WMA/MP3 files must be ISO 9660 Level 1 or 2 compliant. CD physical format: Mode1, Mode2 XA Form1. Romeo and Joliet file systems are both compatible with this player.
- Use CD-R or CD-RW media for recording your files. The disc must be finalized (i.e. the session must be closed) in order to play in this unit. This player is not compatible with multi-session discs. Only the first session of a multi-session disc will be recognized.
- This player only plays tracks that are named with the file extension .mp3, .MP3, .wma, or .WMA.

- When naming MP3 and WMA files, add the corresponding file name extension (.mp3 or .wma). Files are played according to the file extension. To prevent noise and malfunctions, do not use these extensions for other kinds of files.
- This player can recognize up to 999 files (WMA/MP3/JPEG) and up to 499 folders. If a disc exceeds these limits, only files and folders up to these limits will be playable. Files and folders are read/displayed in alphabetical order. Note that if the file structure is very complex, you may not be able to read/play all files on the disc.
- Folder and track names (excluding the file extension) are displayed.
- There are many different recording bit-rates available to encode MP3 files. This unit was designed to be compatible with all of them. Audio encoded at 128Kbps should sound close to regular CD Audio quality. This player will play lower bit-rate files, but please note that the sound quality becomes noticeably worse at lower bit-rates.

JPEG file compatibility

- Baseline JPEG and EXIF 2.1* still image files up to 8 mega-pixels are supported (maximum vertical and horizontal resolution is 5120 pixels). (*File format used by digital still cameras)
- The CD-ROM used to compile your JPEG files must be ISO 9660 Level 1 or 2 compliant. CD physical format: Mode1, Mode2 XA Form1. Romeo and Joliet file systems are both compatible with this player.
- This player only displays files that are named with the file extension .jpg or .JPG.

Chapter 2

Connecting up

Rear panel connections

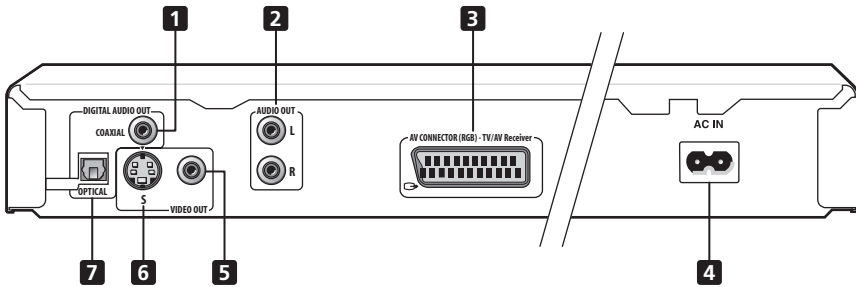

Important

- When connecting this player up to your TV, AV receiver or other components, make sure that all components are switched off and unplugged.

1 DIGITAL AUDIO OUT – COAXIAL

This is a digital audio output for connection to a PCM, Dolby Digital, DTS and/or MPEG-compatible AV receiver that has a coaxial digital input.

Connect using a commercially available coaxial digital audio cable.

2 AUDIO OUT L / R

This pair of analog audio outputs connects to your TV, AV receiver or stereo system. Even if you are connecting up one of the digital outputs, we still recommend you connect these jacks.

Use the supplied audio/video cable when connecting these jacks. Match the colors of the jacks and cables for correct stereo sound.

3 AV CONNECTOR (RGB) - TV/AV Receiver

This is a combined audio and video output for connection to a TV that has a SCART input. Connect using a SCART cable. The type of video output can be switched to suit your TV. See “Connecting using the AV connector output” on page 14.

4 AC IN

Connect the supplied power cable here, then plug into a power outlet.

5 VIDEO OUT

This is a standard video output that you can connect to your TV or AV receiver using the supplied audio/video cable.

6 S (S-video output)

This is an S-video output that you can use instead of the video output described in 5 above.

7 DIGITAL AUDIO OUT – OPTICAL

This is a digital audio output for connection to a PCM, Dolby Digital, DTS and/or MPEG-compatible AV receiver that has an optical digital input.

Connect using a commercially available optical digital audio cable.



Tip

- You may find it useful to have the manuals supplied with your other components handy when connecting this player.
- If you come across any unfamiliar terms in this section of the manual, turn to the *Glossary* on page 60.

Easy connections

The setup described here is a basic setup that allows you to play discs using just the cables supplied with the player. In this setup, stereo audio is played through the speakers in your TV.

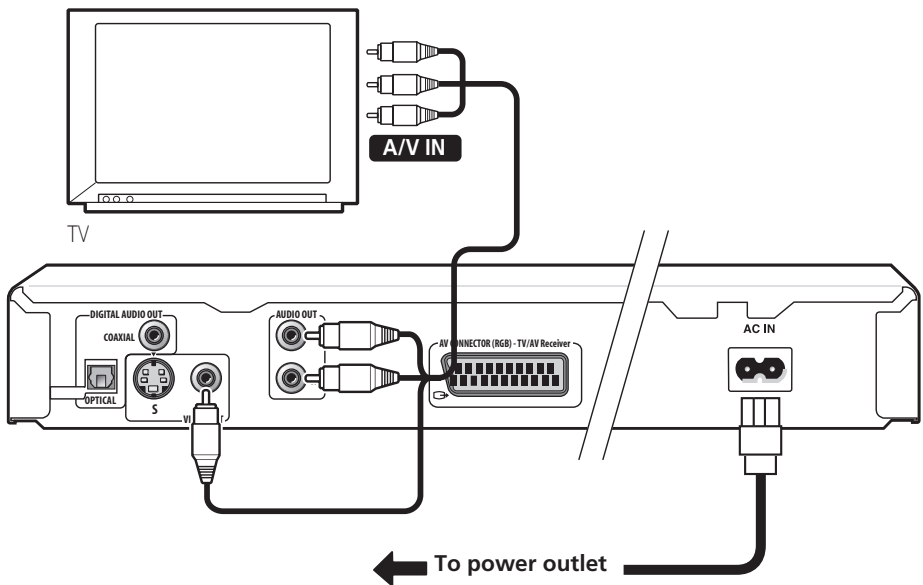

Important

- This player is equipped with copy protection technology. Do not connect this player to your TV via a VCR using AV cables, as the picture from this player will not appear properly on your TV. (This player may also not be compatible with some combination TV/VCRs for the same reason; refer to the manufacturer for more information.)

1 Connect the VIDEO OUT and AUDIO OUT L/R jacks to a set of A/V inputs on your TV.

Use the supplied audio/video cable, connecting the red and white plugs to the audio outputs and the yellow plug to the video output. Make sure you match up the left and right audio outputs with their corresponding inputs for correct stereo sound.

See below if you want to use a SCART cable for the audio/video connection, or an S-Video cable for the video connection.

2 Connect the supplied AC power cable to the AC IN inlet, then plug into a power outlet.



Note

- Before unplugging the player from the power outlet, make sure you first switch it into standby using either the front panel **STANDBY/ON** button, or the remote control, and wait of the **-OFF-** message to disappear from the player's display.
- For the above reasons, do not plug this player into a switched power supply found on some amplifiers and AV receivers.

Connecting using the S-video output

If your TV (or other equipment) has an S-video input, you can use this instead of the standard (composite) output for a better quality picture.

- **Use an S-video cable (not supplied) to connect the S-VIDEO OUT to an S-video input on your TV (or monitor or AV receiver).**

Line up the small triangle above the jack with the same mark on the plug before plugging in.

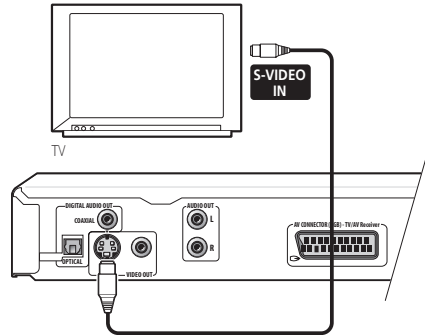

Connecting using the AV connector output

If your TV has a SCART-type AV input, you can use a SCART cable to connect this player to your TV. This type of connection carries both the sound and the picture, so there's no need to connect up the **AUDIO OUT L/R** and **VIDEO OUT** jacks.

- Use a **SCART cable (not supplied)** to connect the **AV CONNECTOR (RGB) - TV/AV Receiver** to an AV input on your TV.

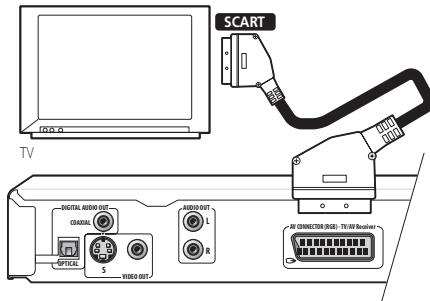

This connector can output standard (composite), S-Video or RGB component video. The default setting is standard, which should work with all TVs. Consult the manual that came with your TV to see if you can use one of the higher quality settings. See page 48 for how to change the video output.



Note

- SCART cables are available in several configurations. Make sure that the one you get will work with this player and your TV/monitor. You can find the pin assignments on page 62.

Connecting to an AV receiver

To enjoy multichannel surround sound you need to connect this player to an AV receiver using a digital output. This player has both coaxial and optical digital jacks; use whichever is convenient.

In addition to a digital connection, we recommend also connecting using the stereo analog connection.

You'll probably also want to connect a video output to your AV receiver. You can use any of the video outputs available on this player (the illustration shows a standard (composite) connection).

- 1 Connect one of **DIGITAL AUDIO OUT** jacks on this player to a digital input on your AV receiver.

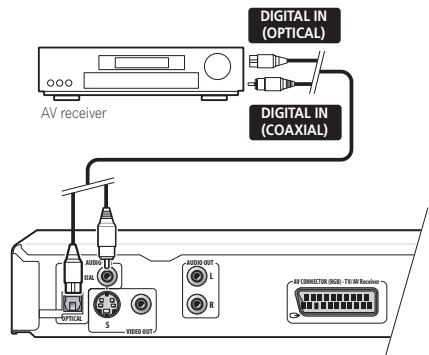

This enables you to listen to multichannel surround sound.

For an optical connection, use an optical cable (not supplied) to connect the **OPTICAL DIGITAL AUDIO OUT** jack to an optical input on your AV receiver.

For a coaxial connection, use a coaxial cable (similar to the supplied video cable) to connect the **COAXIAL DIGITAL AUDIO OUT** jack to a coaxial input on your AV receiver.

2 Connect the analog AUDIO OUT L/R and VIDEO OUT jacks on this player to a set of analog audio and video inputs on your AV receiver.

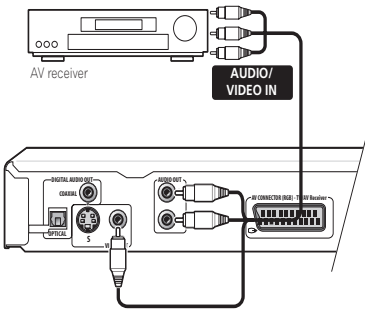

The diagram shows standard video connections, but you can alternatively use the S-Video or SCART cable connections if they're available.

3 Connect the AV receiver's video output to a video input on your TV.



Tip

- You usually have to connect the same kind of video cable between your DVD player and AV receiver, and between your AV receiver and TV.



FAQ

- My TV doesn't have any inputs to connect the DVD player. How can I watch DVDs?*
If your TV has no inputs you can't use this player with it.

- My VCR is already connected to my TV, so there aren't any spare inputs. What should I do?*

If all your TV's inputs are already in use, you can buy a video input selector from an electronics store, which effectively gives you more inputs.

- My TV only has one input for the sound. What should I plug it into?*

If you don't mind mono sound, you can buy a stereo RCA-to-mono RCA cable from an electronics store. Connect the stereo end to this player and the mono end to your TV.

If you want stereo sound, connect this player to your amplifier or stereo system using a stereo audio cable.

- I connected the DVD player to my AV receiver, and although the sound is fine, there's no picture. What did I do wrong?*

Make sure that the correct video input is selected on your TV.

Also make sure that the type of video connection from the DVD player to your AV receiver is the same as that from the receiver to your TV. Most AV receivers won't convert from one kind of connection to another.

Chapter 3

Controls and displays

Front panel

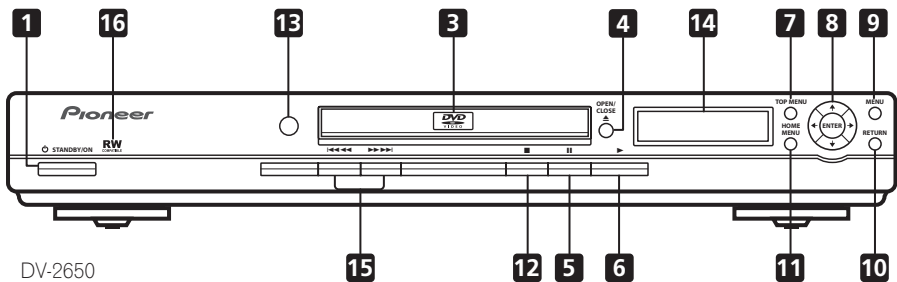

DV-2650

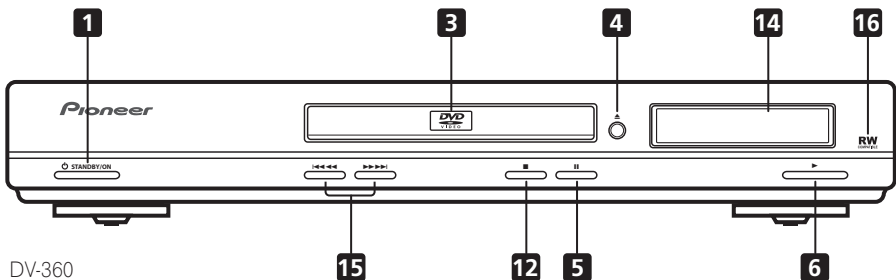

DV-360

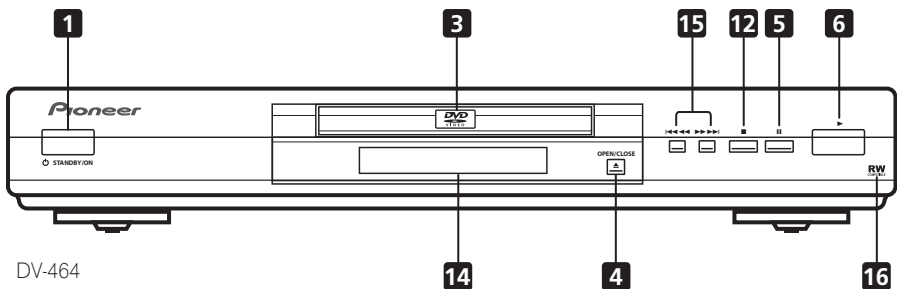

DV-464

1  **STANDBY/ON**

Press to switch the player on or into standby.

2 **FL DIMMER**

Press to dim or brighten the display.

3 **Disc tray****4**  **OPEN/CLOSE**

Press to open or close the disc tray.

5 

Press to pause playback. Press again to restart.

6 

Press to start or resume playback.

7 **TOP MENU**

Press to display the top menu of a DVD disc.

8 **ENTER & cursor buttons**

Use to navigate on-screen displays and menus. Press **ENTER** to select an option or execute a command.

9 **MENU**

Press to display a DVD disc menu, or the Disc Navigator if a VR format DVD-RW, CD, Video CD, MP3, WMA or JPEG disc is loaded.

10 **RETURN**

Press to return to a previous menu screen.

11 **HOME MENU**

Press to display (or exit).

12 

Press to stop the disc (you can resume playback by pressing  (play)).

13 **Remote control sensor**

The remote control has a range of up to about 7m.

14 **Display**

See page 18 for a description of the display.

15   **and**  

- Press and hold for fast reverse/forward scanning.
- Press to jump to the previous/next chapter or track.

16 **RW**
COMPATIBLE

This mark indicates compatibility with DVD-RW discs recorded on a DVD recorder in Video Recording mode.

Display

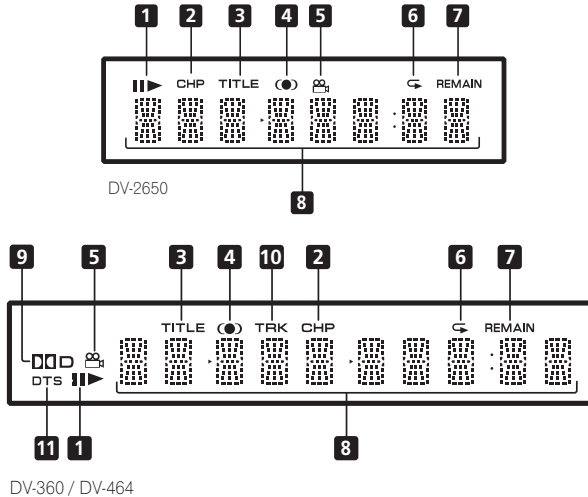

1 **II and ►**

Indicates whether a disc is playing or paused.

2 **CHP**

Indicates that the character display is showing a DVD chapter number.

3 **TITLE**

Indicates that the character display is showing a DVD title number.

4 **⦿**

Lights when **D**DV/SRS TruSurround is selected.

5 **🎬**

Lights during multi-angle scenes on a DVD disc.

6 **↺**

Lights in any of the repeat play modes.

7 **REMAIN**

Indicates that the character display is showing the disc or title/chapter/track remain time.

8 **Character display**

9 **D**

Lights when a Dolby Digital soundtrack is playing.

10 **TRK**

Indicates that the character display is showing a CD or Video CD track number.

11 **DTS**

Lights when a DTS soundtrack is playing.

Remote control

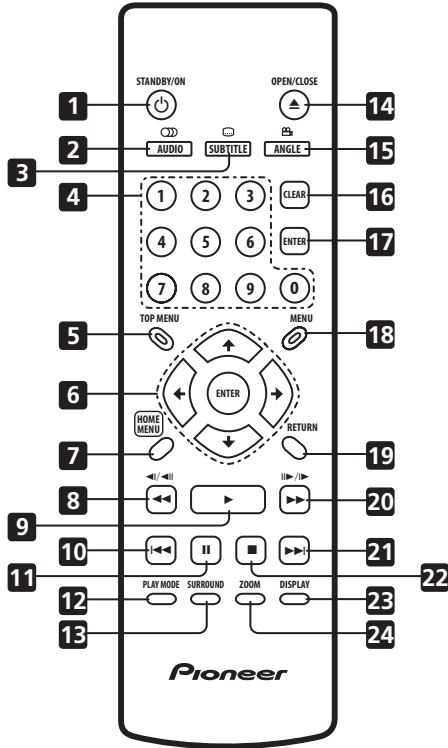

1 STANDBY/ON

Press to switch the player on or into standby.

2 AUDIO

Press to select the audio channel or language (see *Switching DVD audio language* on page 37).

3 SUBTITLE

Press to select a subtitle display (see *Switching subtitles* on page 37).

4 Number buttons

5 TOP MENU

Press to display the top menu of a DVD disc.

6 ENTER & cursor buttons

Use to navigate on-screen displays and menus. Press **ENTER** to select an option or execute a command.

7 HOME MENU

Press to display (or exit) the on-screen display.

8 and

Use for reverse slow motion playback, frame reverse and reverse scanning.

9

Press to start or resume playback.

10

Press to jump to the beginning of the current chapter or track, then to previous chapters/tracks.

11

Press to pause playback; press again to restart.

12 PLAY MODE

Press to display the Play Mode menu. (You can also get to the Play Mode menu by pressing **HOME MENU** and selecting Play Mode).

13 SURROUND

Press to activate/switch off **Dolby**/SRS TruSurround.

14 ▲ OPEN/CLOSE

Press to open or close the disc tray.

15 ANGLE

Press to change the camera angle during DVD multi-angle scene playback (see *Switching camera angles* on page 38).

16 CLEAR

Press to clear a numeric entry.

17 ENTER

Use to select menu options, etc. (works exactly the same as the **ENTER** button in **6** above).

18 MENU

Press to display a DVD disc menu, or the Disc Navigator if a VR format DVD-RW, CD, Video CD, MP3, WMA or JPEG disc is loaded.

19 RETURN

Press to return to a previous menu screen.

20 ►► and I►/II►

Use for forward slow motion playback, frame advance and forward scanning.

21 ►►I

Press to jump to the next chapter or track.

22 ■

Press to stop the disc (you can resume playback by pressing ► (play)).

23 DISPLAY

Press to display information about the disc playing (see *Displaying disc information* on page 38).

24 ZOOM

Press to change the zoom level (see *Zooming the screen* on page 38).

Chapter 4

Getting started

Switching on

After making sure that everything is connected properly and that the player is plugged in, press **⏻ STANDBY/ON** on the front panel, or on the remote control to switch the player on.

Also, switch on your TV and make sure that it is set to the input you connected the DVD player to.

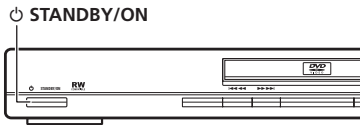

FAQ

- *My DVD player switches on but there is nothing displayed on my TV.*

Make sure that the TV is set to the correct video input (not a TV channel). For example, if you connected this player to the **VIDEO 1** inputs on your TV, switch your TV to **VIDEO 1**.



Note

- This player features a screen saver and an auto power off function. If the player is stopped and no button is pressed for five minutes, the screen saver starts. If the disc tray is closed but no disc is playing and no control is pressed for 30 minutes, the player automatically goes into standby.

Let's Get Started

When you switch on the player for the first time, you should see a welcome screen displayed on your TV. From here you can let the player know what kind of TV you have, then either use the Setup Navigator to make more settings, or jump right in and start playing some discs.

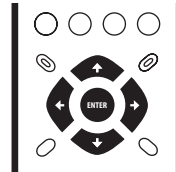

- 1 Use the **↑/↓ (cursor up/down)** buttons to choose a language, then press **ENTER**.

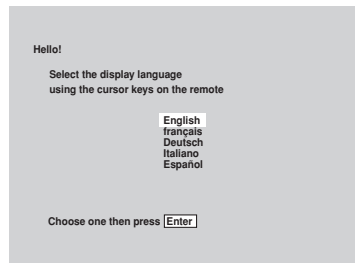

- 2 Use the \leftarrow/\rightarrow (cursor left/right) buttons to select either 'Wide screen (16:9)' or 'Standard size screen (4:3)' according to the kind of TV you have, then press **ENTER**.

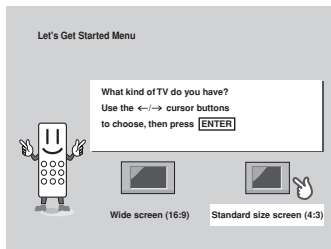

- 3 Press **ENTER** again to finish setting up.

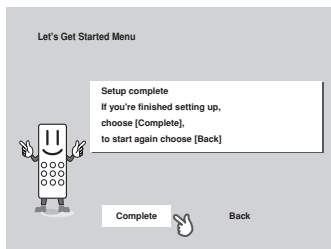

- Select **Back** then press **ENTER** if you want to go back and change the setting you just made.

Using the on-screen displays

For ease of use, this player makes extensive use of graphical on-screen displays (OSDs). You should get used to the way these work as you'll need to use them when setting up the player, using some of the playback features, such as program play, and when making more advanced settings for audio and video.

All the screens are navigated in basically the same way, using the cursor buttons ($\uparrow/\downarrow/\leftarrow/\rightarrow$) to change the highlighted item and pressing **ENTER** to select it.



Important

- Throughout this manual, 'Select' means use the cursor buttons to highlight an item on-screen, then press **ENTER**.

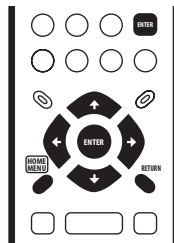

Button	What it does
HOME MENU	Display/exit the on-screen display.
$\uparrow/\downarrow/\leftarrow/\rightarrow$	Changes the highlighted menu item.
ENTER	Selects the highlighted menu item (both ENTER buttons work in exactly the same way).
RETURN	Returns to the main menu without saving changes.



Tip

- If you're using the DV-2650, the buttons to navigate the on-screen displays are available on the front panel as well as the remote control. (See *Front panel* on page 16 for the location and description of all the front panel controls for your model.)
- The button guide at the bottom of every OSD screen shows you which buttons you'll need to use for that screen.

Setting up with the Setup Navigator

Using the Setup Navigator you can make a number of other initial settings for this player. We recommend using the Setup Navigator, especially if you connected this player to an AV receiver for playing surround sound. To answer some of the questions about digital audio formats you may need to look at the instructions that came with your AV receiver.

1 If a disc is playing, press ■ (stop).

Also turn on your TV and make sure that it is set to the correct video input.

2 Press HOME MENU.

The on-screen display (OSD) appears.

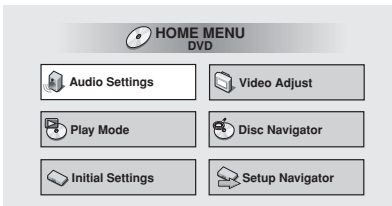

3 Select 'Setup Navigator'.

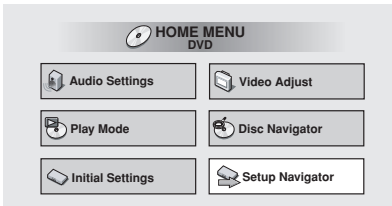

4 Select a DVD language.

Some DVD discs feature on-screen menus, soundtracks and subtitles in several languages. Set your preferred language here.

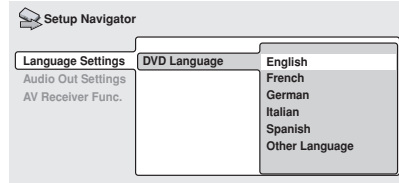

- Note that the language you choose here may not be available on all discs.
- If you want to select a language other than those listed, select **Other Language**. See Selecting languages using the language code list on **page 59** for detailed information.

5 Did you connect this player to an amplifier or AV receiver?

Select **Connected** or **Not Connected**.

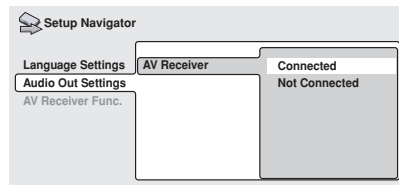

- If you selected **Not Connected** here, that completes setup using the Setup Navigator. Press **ENTER** to exit.

6 Did you connect this player to an AV receiver using a digital output?

Select **Connected** or **Not Connected**.

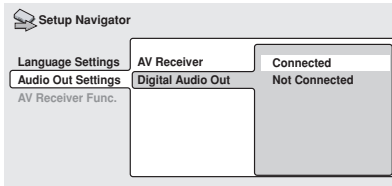

- If you selected **Not Connected** here, that completes setup using the Setup Navigator. Press **ENTER** to exit.

7 Is your AV receiver Dolby Digital compatible?

Select **Compatible**, **Not Compatible** or **Don't Know**.

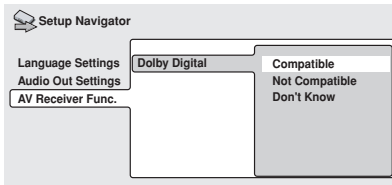

8 Is your AV receiver DTS compatible?

Select **Compatible**, **Not Compatible** or **Don't Know**.

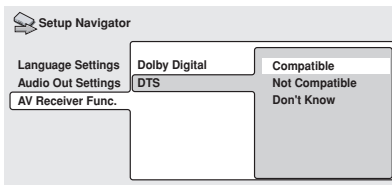

9 Is your AV receiver MPEG compatible?

Select **Compatible**, **Not Compatible** or **Don't Know**.

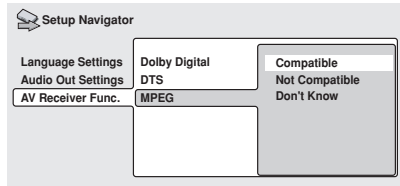

10 Is your AV receiver compatible with 96kHz Linear PCM audio?

Select **Compatible**, **Not Compatible** or **Don't Know**.

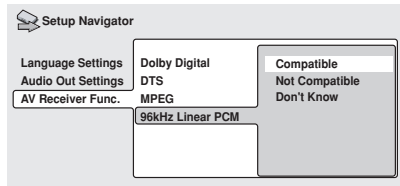

11 Press ENTER to complete the setup, or press HOME MENU to quit the Setup Navigator without making any changes.

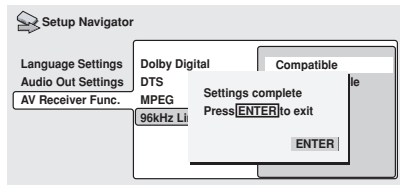

Congratulations, setup is complete!

Playing discs

The basic playback controls for playing DVD, CD, Video CD and WMA/MP3 discs are covered here. Further functions are detailed in the next chapter.

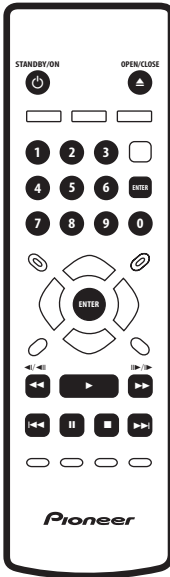

1 If the player isn't already on, press **STANDBY/ON** to switch it on.

If you're playing a DVD or Video CD, also turn on your TV and make sure that it is set to the correct video input.

2 Press **OPEN/CLOSE** to open the disc tray.

3 Load a disc.

Load a disc with the label side facing up, using the disc tray guide to align the disc (if you're loading a double-sided DVD disc, load it with the side you want to play face down).

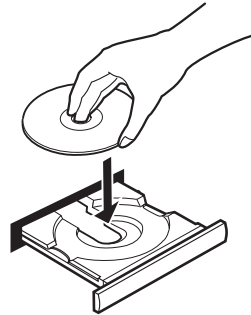

4 Press **▶ (play)** to start playback.

If you're playing a DVD or Video CD, a menu may appear. See *DVD-Video disc menus* on page 28 and *Video CD PBC menus* on page 28 for more on how to navigate these.

If you're playing an WMA/MP3 disc, it may take a few seconds before playback starts, depending on the complexity of the file structure on the disc.

If you loaded a CD/CD-R/RW containing JPEGs, a slideshow will start. See *Viewing JPEG discs* on page 40 for more on playing these discs.

- See also *PhotoViewer* on page 53 if the disc contains both WMA/MP3 audio files and JPEG picture files (by default, you will not be able to play the WMA/MP3 files).



FAQ

- *After I load a DVD disc, it ejects automatically after a few seconds!*

Most likely, the disc is the wrong region for your player. The region number should be printed on the disc; check it against the region number of the player (which you can find on the rear panel). See also on page 58.

If the region number is OK, it may be that the disc is damaged or dirty. Clean the disc and look for signs of damage. See also *Taking care of your player and discs* on page 54.

- *Why won't the disc I loaded play?*

First check that you loaded the disc the right way up (label side up), and that it's clean and not damaged. See *Taking care of your player and discs* on page 54 for information on cleaning discs.

If a disc loaded correctly won't play, it's probably an incompatible format or disc type, such as DVD-Audio or DVD-ROM. See *Disc / content format playback compatibility* on page 8 for more on disc compatibility.

- *I have a widescreen TV so why are there black bars at the top and bottom of the screen when I play some discs?*

Some movie formats are such that even when played on a widescreen TV, black bars are necessary at the top and bottom of the screen. This is not a malfunction.

- *I have a standard (4:3) TV and set the player to show widescreen DVDs in pan & scan format, so why do I still get black bars top and bottom with some discs?*

Some discs override the display preferences of the player, so even if you have **4:3 (Pan & Scan)** selected, those discs will still be shown in letter box format. This is not a malfunction.

- *My AV receiver is definitely compatible with 96kHz Linear PCM audio, but it doesn't seem to work with this player. What's wrong?*

For digital copy-protection purposes, some 96kHz DVD discs are automatically downsampled to 48kHz. This is not a malfunction. With these kinds of discs, if you want to enjoy high-quality analog audio, set **Digital Out** to **Off** (see *Digital Out* on page 46), and **96kHz PCM Out** to **96kHz** (see *96kHz PCM Out* on page 47).

Basic playback controls

The table below shows the basic controls on the remote for playing discs. The following chapter covers more playback features in more detail.

Button	What it does
▶	Starts playback. DVD and Video CD: If the display shows RESUME or LAST MEM playback starts from the resume or last memory point (see also <i>Resume and Last Memory</i> below.)
	Pauses a disc that's playing, or restarts a paused disc.

Button	What it does
■	Stops playback. DVD and Video CD: Display shows RESUME . Press ■ (stop) again to cancel the resume function. (See also <i>Resume and Last Memory</i> below.)
◀◀	Press to start fast reverse scanning. Press ▶ (play) to resume normal playback.
▶▶	Press to start fast forward scanning. Press ▶ (play) to resume normal playback.
◀◀◀	Skips to the start of the current track or chapter, then to previous tracks/chapters.
▶▶▶	Skips to the next track or chapter.
Numbers	Use to enter a title/track number. Press ENTER to select (or wait a few seconds). <ul style="list-style-type: none"> • If the disc is stopped, playback starts from the selected title (for DVD) or track number (for CD/Video CD/WMA/MP3). • If the disc is playing, playback jumps to the start of the selected chapter or track.

Front panel controls

The ▶ (play), ■ (stop), and || (pause) buttons on the front panel work in exactly the same way as their remote control equivalents.

The combined scan/skip buttons on the front panel (◀◀◀◀◀ and ▶▶▶▶▶) work slightly differently from the remote buttons. Press and hold for fast scan; press for track/chapter skip.

See *Front panel* on page 16 for the location and description of all the front panel controls for your model.



Important

- You may find with some DVD discs that some playback controls don't work in certain parts of the disc. This is not a malfunction.
- Track skip and number buttons for track selection do not work with unfinalized CD-R/RW discs.

Resume and Last Memory

When you stop playback of a DVD or Video CD disc, **RESUME** is shown in the display indicating that you can resume playback again from that point.

If the disc tray is not opened, the next time you start playback the display shows **RESUME** and playback resumes from the resume point.

For DVD discs only: If you take the disc out of the player, the play position is stored in memory. When you load the disc next time, the display shows **LAST MEM** and you can resume playback (this works for up to five discs).

If you want to clear the resume/last memory point, press ■ (stop) while **RESUME** or **LAST MEM** is displayed.



Note

- When a Video CD is loaded, the Resume point is lost if the player is switched off.
- For the Last Memory function to work, you must press ■ (stop) to stop playback before opening the disc tray.
- The Last Memory function doesn't work with VR format DVD-RW discs.

DVD-Video disc menus

Many DVD-Video discs contain menus from which you can select what you want to watch. They may give access to additional features, such as subtitle and audio language selection, or special features such as slideshows. See the disc packaging for details.

Sometimes DVD-Video menus are displayed automatically when you start playback; others only appear when you press **MENU** or **TOP MENU**.

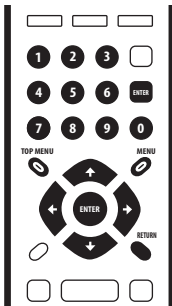

Button	What it does
TOP MENU	Displays the 'top menu' of a DVD disc—this varies with the disc.
MENU	Displays a DVD disc menu—this varies with the disc and may be the same as the 'top menu'.
↑/↓/←/→	Moves the cursor around the screen.
ENTER	Selects the current menu option.
RETURN	Returns to the previously displayed menu screen.
Numbers	Highlights a numbered menu option (some discs only). Press ENTER to select.



Tip

- If you're using the DV-2650, most of the buttons to navigate DVD disc menus are available on the front panel as well as the remote control. (See *Front panel* on page 16 for the location and description of all the front panel controls for your model.)

Video CD PBC menus

Some Video CDs have menus from which you can choose what you want to watch. These are called PBC (Playback control) menus.

You can play a PBC Video CD without having to navigate the PBC menu by starting playback using a number button to select a track, rather than the ► (play) button.

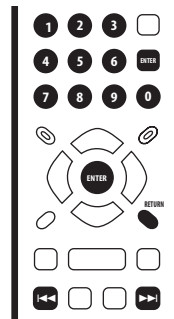

Button	What it does
RETURN	Displays the PBC menu.
Numbers	Use to enter a numbered menu option. Press ENTER to select.
◀◀	Displays the previous menu page (if there is one).
▶▶	Displays the next menu page (if there is one).

Chapter 5

Playing discs

Introduction

Most of the features described in this chapter make use of on-screen displays. For an explanation of how to navigate these, see *Using the on-screen displays* on page 22.

Many of the functions covered in this chapter apply to DVD discs, Video CDs, CDs and WMA/MP3/JPEG discs, although the exact operation of some varies slightly with the kind of disc loaded.

Some DVD discs restrict the use of some functions (random or repeat, for example). This is not a malfunction.

When playing Video CDs, some of the functions are not available during PBC playback. If you want to use them, start the disc playing using a number button to select a track.

Using the Disc Navigator to browse the contents of a disc

Use the Disc Navigator to browse through the contents of a disc to find the part you want to play. You can use the Disc Navigator when a disc is playing or stopped.

1 Press HOME MENU and select 'Disc Navigator' from the on-screen display.

Alternatively, if a VR format DVD-RW, CD, Video CD or WMA/MP3/JPEG disc is loaded, you can press **MENU**, which takes you straight to the Disc Navigator screen.

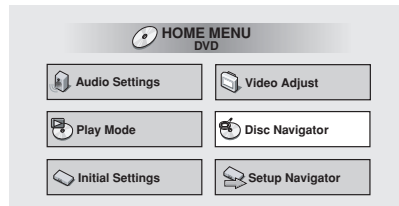

2 Select what you want to play.

Depending on the type of disc you have loaded, the Disc Navigator looks slightly different.

The screen for DVD discs shows the titles on the left and the chapters on the right. Select a title, or a chapter within a title.

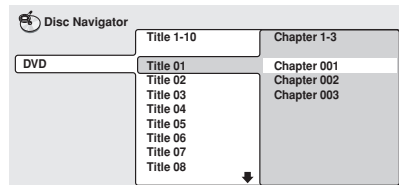

For a VR (Video Recording) mode DVD-RW disc select between the **Playlist** and **Original** areas of the disc, or a title. Press **→** (cursor right) to preview the title.

- It's not possible to switch between **Original** and **Playlist** during playback.

- Not all VR format DVD-RW discs have a Playlist.

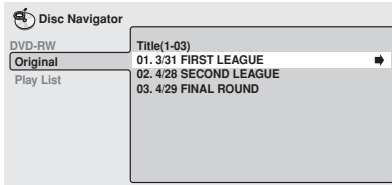

The screen for CDs and Video CDs shows a list of tracks.

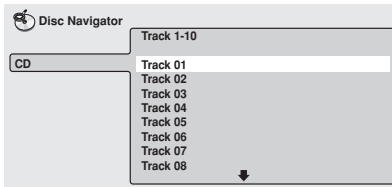

The screen for an WMA/MP3 disc shows the folder names on the left and the track names on the right (note that if there are more than 16 folders or names that contain accented or non-roman characters, tracks and folders may show up with generic names – **F_033**, **T_035**, etc.).

Select a folder, or a track within a folder.

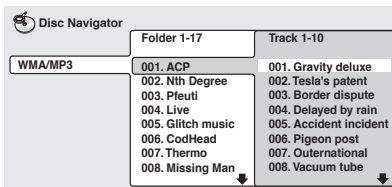

Playback starts after you press **ENTER**.



Tip

- The Disc Navigator is not available unless there is a disc loaded.

- It's not possible to use the Disc Navigator when playing a Video CD in PBC mode, or an unfinalized CD-R/RW disc.
- Another way to find a particular place on a disc is to use one of the search modes. See *Searching a disc* on page 36.

Scanning discs

You can fast-scan discs forward or backward at various different speeds.

1 During playback, press ◀◀ or ▶▶ to start scanning.

2 Press repeatedly to increase the scanning speed.

- WMA/MP3 tracks can only be scanned at one speed.
- The scanning speed is shown on-screen.

3 To resume normal playback, press ▶ (play).



Note

- Sound can be heard while scanning audio CDs and MP3 discs.
- When scanning a Video CD or WMA/MP3 track, playback automatically resumes at the end or beginning of the track.
- There is no sound while scanning DVDs, Video CDs and WMA discs, and no subtitles while scanning DVDs.
- Depending on the disc, normal playback may automatically resume when a new chapter is reached on a DVD disc.

Playing in slow motion

You can play DVDs and Video CDs at four different forward slow motion speeds. DVD discs can also be played at two reverse speeds.

1 During playback, press II (pause).

2 Press and hold ◀|/◀|| or |||/|▶ until slow motion playback starts.

- The slow motion speed is shown on-screen.
- There is no sound during slow motion playback.

3 Press repeatedly to change the slow motion speed.

- The slow motion speed is displayed on-screen.

4 To resume normal playback, press ▶ (play).



Note

- Video CD only supports forward slow motion playback.
- The picture quality during slow motion playback is not as good as during normal playback.
- Depending on the disc, normal playback may automatically resume when a new chapter is reached.

Frame advance/frame reverse

You can advance or back up a DVD disc frame-by-frame. With Video CDs and VR format DVD-RWs, you can only use frame advance.

1 During playback, press II (pause).

2 Press ◀|/◀|| or |||/|▶ to reverse or advance a frame at a time.

3 To resume normal playback, press ▶ (play).



Note

- The picture quality when using frame reverse is not as good as frame advance.
- Depending on the disc, normal playback may automatically resume when a new chapter is reached.
- When changing direction with a DVD disc, the picture may 'move' in an unexpected way. This is not a malfunction.

Looping a section of a disc

The A-B Repeat function allows you to specify two points (A and B) within a track (CD and Video CD) or title (DVD) that form a loop which is played over and over.



Important

- You can't use A-B Repeat with WMA/MP3 discs, Video CDs in PBC mode, or unfinalized CD-R/RW discs.

1 During playback, press PLAY MODE and select 'A-B Repeat' from the list of functions on the left.

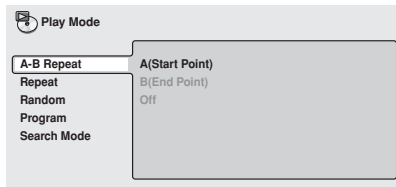

- 2 Press **ENTER** on 'A(Start Point)' to set the loop start point.

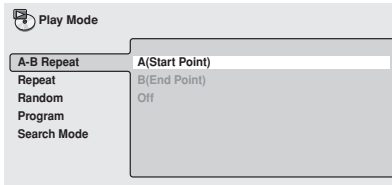

- 3 Press **ENTER** on 'B(End Point)' to set the loop end point.

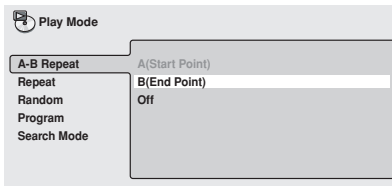

After pressing **ENTER**, playback jumps back to the start point and plays the loop.

- The minimum loop time is 2 seconds.

- 4 To resume normal playback, select 'Off' from the menu.

Using repeat play

There are various repeat play options, depending on the kind of disc loaded. It's also possible to use repeat play together with program play to repeat the tracks/chapters in the program list (see *Creating a program list* on page 34).



Important

- You can't use Repeat play with Video CDs in PBC mode, or unfinalized CD-R/RW discs.

- 1 During playback, press **PLAY MODE** and select 'Repeat' from the list of functions on the left.

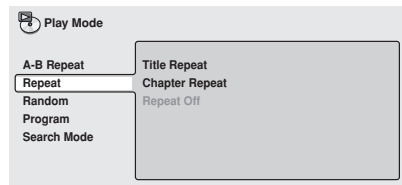

- 2 Select a repeat play option.

If program play is active, select **Program Repeat** to repeat the program list, or **Repeat Off** to cancel.

For DVD discs, select **Title Repeat** or **Chapter Repeat** (or **Repeat Off**).

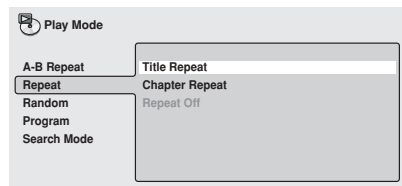

For CDs and Video CDs, select **Disc Repeat** or **Track Repeat** (or **Repeat Off**).

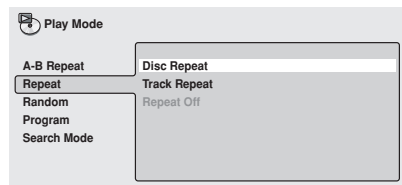

For WMA/MP3 discs, select **Disc Repeat**, **Folder Repeat** or **Track Repeat** (or **Repeat Off**).

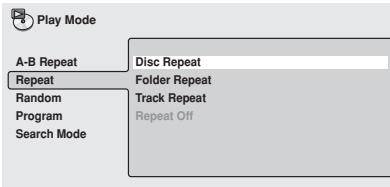

 **Note**

- You can't use repeat and random play at the same time.
- If you switch camera angle during repeat play, repeat play is canceled.

Using random play

Use the random play function to play titles or chapters (DVD-Video) or tracks (CD, Video CD and WMA/MP3 discs) in a random order.

You can set the random play option when a disc is playing or stopped.

 **Important**

- You can't use random play with VR format DVD-RW discs, Video CDs playing in PBC mode, or while a DVD disc menu is being displayed.

1 Press PLAY MODE and select 'Random' from the list of functions on the left.

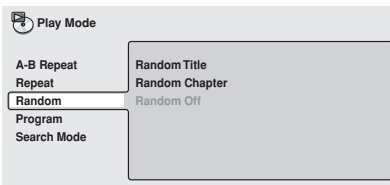

2 Select a random play option.

For DVD discs, select **Random Title** or **Random Chapter**, (or **Random Off**).

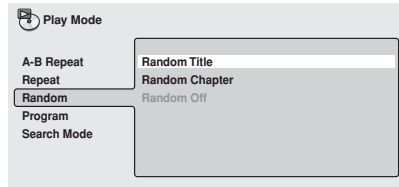

For CDs and Video CDs, select **On** or **Off** to switch random play on or off.

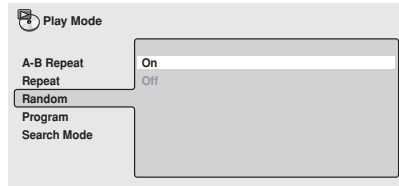

For WMA/MP3 discs, select **Random All** (all folders) or **Random Track** (current folder only), (or **Random Off**).

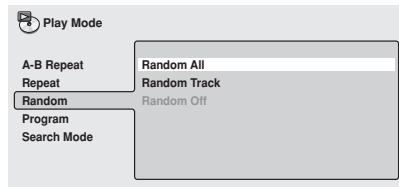

 **Tip**

- To stop the disc and cancel random playback, press **■** (stop).
- To cancel random playback without stopping playback, press **CLEAR**. The disc will play to the end, then stop.

- During random play, the ◀◀ and ▶▶ buttons function a little differently to normal: ◀◀ returns to the beginning of the current track/chapter. You can't go back further than this. ▶▶ selects another track/chapter at random from those remaining.
- You can't use random play together with program or repeat play.

Creating a program list

This feature lets you program the play order of titles/chapters/folders/tracks on a disc.



Important

- You can't use Program play with VR format DVD-RW discs, Video CDs playing in PBC mode, or while a DVD disc menu is being displayed.

1 Press PLAY MODE and select 'Program' from the list of functions on the left.

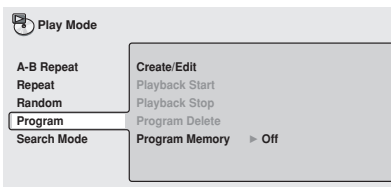

2 Select 'Create/Edit' from the list of program options.

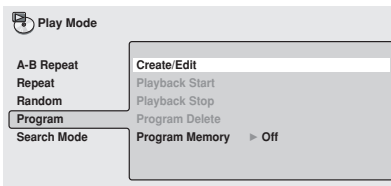

The Program edit screen that appears depends on the kind of disc loaded.

On the left side is the program list, then to the right is a list of titles (if a DVD disc is loaded), tracks (for CDs and Video CDs), or folder names (for WMA/MP3 discs). On the far right is a list of chapters (for DVD) or track names (for WMA/MP3).

3 Select a title, chapter, folder or track for the current step in the program list.

For a DVD disc, you can add a whole title, or a chapter within a title to the program list.

- To add a title, select the title.

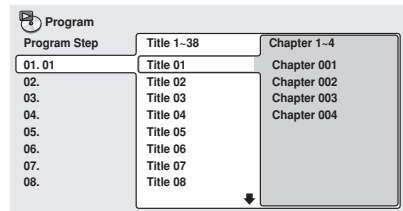

- To add a chapter, first highlight the title, then press → (cursor right) and select a chapter from the list.

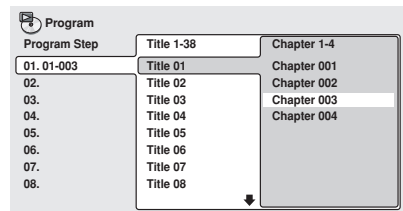

For a CD or Video CD, select a track to add to the program list.

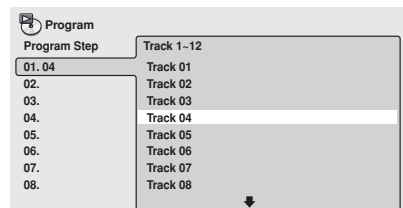

For an WMA/MP3 disc, you can add a whole folder, or a track within a folder to the program list.

- To add a folder, select the folder.

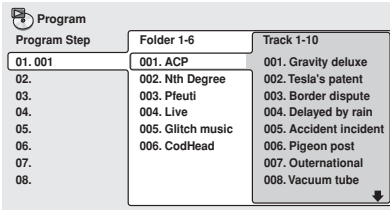

- To add a track, first find the folder, then press **→** (cursor right) and select a track name from the list.

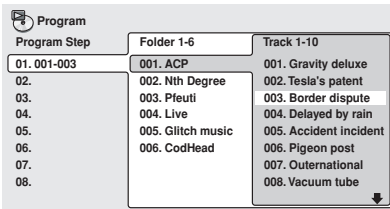

After pressing **ENTER** to select the title/ chapter/folder/track, the step number automatically moves down one.

4 Repeat step 3 to build up a program list.

A program list can contain up to 24 titles/ chapters/folders/tracks.

5 To play the program list, press **▶** (play).

Program play remains active until you turn off program play (see below), erase the program list (see below), eject the disc or switch off the player.



Tip

- To save your program list and exit the program edit screen without starting playback, press **PLAY MODE** or **HOME MENU**. (Don't press **RETURN** – your program list won't be saved.)
- During program play, press **▶▶** to skip to the next program step.
- Press **CLEAR** during playback to switch off program play. Press while stopped to erase the program list.

Editing a program list

After creating a program list, you can add, delete and change steps.

1 Press **PLAY MODE** and select 'Program' from the list of functions on the left.

2 Select 'Create/Edit' from the list of program options.

3 To clear a step, highlight the step number and press **CLEAR**.

4 To insert a step in the middle of the program list, highlight the step where you want the new step to appear, then select a title/chapter/folder/track to add.

After pressing **ENTER**, the new step is inserted into the list.

5 To add a step to the end of the program list, highlight the next free step then select a title/chapter/folder/track to add.



Tip

- To save your program list and exit the program edit screen without starting playback, press **PLAY MODE** or **HOME MENU**.

- If you want to exit the program edit screen without saving the changes you made, press **RETURN**.

Other functions available from the program menu

As well as creating and editing a program list, you can start program play, cancel program play, erase the program list, and memorize a program list from the Play Mode menu.

1 Press **PLAY MODE** and select 'Program' from the list of functions on the left.

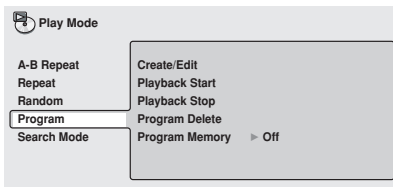

2 Select a program play function.

- **Create/Edit** – See above
- **Playback Start** – Starts playback of a saved program list
- **Playback Stop** – Turns off program play, but does not erase the program list
- **Program Delete** – Erases the program list and turns off program play
- **Program Memory (DVD only)** – Select On to save the program list for the disc loaded. (Select **Off** to cancel the program memory for the disc loaded)



Note

- Program lists are saved for the DVD disc loaded. When you load a disc with a saved program list, program play is automatically turned on.
- You can save program lists for up to 24 discs. After that, the oldest one is replaced with the new one saved.

Searching a disc

You can search DVD discs by title or chapter number, or by time. CDs can be searched by track number, and Video CDs by track number or time. WMA/MP3 discs can be searched by folder or track number.

1 Press **PLAY MODE** and select 'Search Mode' from the list of functions on the left.

The search options that appear depend on the kind of disc loaded. The screen below shows the DVD search options.

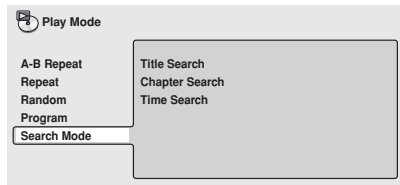

2 Select a search mode.

3 Use the number buttons to enter a title, chapter, folder or track number, or a time.

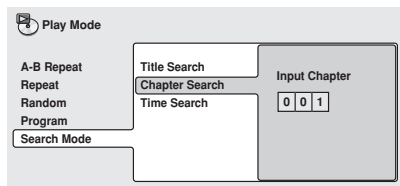

- For a time search, enter the number of minutes and seconds into the currently playing title (DVD) or track (Video CD) you want playback to resume from. For example, press **4, 5, 0, 0** to have playback start from 45 minutes into the disc. For 1 hour, 20 minutes and 30 seconds, press **8, 0, 3, 0**.

4 Press ENTER to start playback.

Note

- The disc must be playing in order to use time search.
- Search functions are not available with Video CDs in PBC mode, or unfinalized CD-R/RW discs.

Switching subtitles

Some DVD discs have subtitles in one or more languages; the disc box will usually tell you which subtitle languages are available. You can switch subtitle language during playback.

1 Press SUBTITLE repeatedly to select a subtitle option.

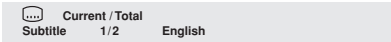

Note

- Some discs only allow you to change subtitle language from the disc menu. Press **TOP MENU** to access.
- To set subtitle preferences, see *Subtitle Language* on page 49.

Switching DVD audio language

When playing a DVD disc recorded with dialog in two or more languages, you can switch audio language during playback.

1 Press AUDIO repeatedly to select an audio language option.



Note

- Some discs only allow you to change audio language from the disc menu. Press **TOP MENU** to access.
- To set audio language preferences, see *Audio Language* on page 49.

Switching VR format DVD-RW audio channel

When playing a VR format DVD-RW disc recorded with dual-mono audio, you can switch between the main, sub, and mixed channels during playback.

1 Press AUDIO repeatedly to select an audio channel option.

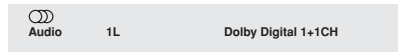

Switching Video CD audio channel

When playing a Video CD, you can switch between stereo, just the left channel or just the right channel.

1 Press AUDIO repeatedly to select an audio channel option.

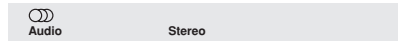

Zooming the screen

Using the zoom feature you can magnify a part of the screen by a factor of 2 or 4, while watching a DVD or Video CD.

1 During playback, use the ZOOM button to select the zoom factor.

- Normal
- 2x
- 4x

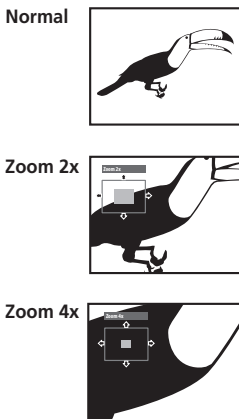

- Since DVD and Video CD have a fixed resolution, picture quality will deteriorate, especially at 4x zoom. This is not a malfunction.

2 Use the cursor buttons to change the zoomed area.

You can change the zoom factor and the zoomed area freely during playback.

- If the navigation square at the top of the screen disappears, press **ZOOM** again to display it.



Note

- We do not recommend using DVD disc menus when the screen is zoomed as menu options will not be highlighted.
- If you are displaying subtitles, these will disappear when the screen is zoomed. They will reappear when you return the screen to normal.

Switching camera angles

Some DVD discs feature scenes shot from two or more angles—check the disc box for details.

When a multi-angle scene is playing, a  icon appears on screen to let you know that other angles are available (this can be switched off if you prefer—see *Angle Indicator* on page 50).

1 During playback (or when paused), press ANGLE to switch angle.

Displaying disc information

Various track, chapter and title information, as well as the video transmission rate for DVD discs, can be displayed on-screen while a disc is playing.

1 To show/switch the information displayed, press DISPLAY.

When a disc is playing, the information appears at the top of the screen. Keep pressing **DISPLAY** to change the displayed information.

- DVD displays

Play		DVD			
	Current / Total	Elapsed	Remain	Total	
Title	11/38	2.05	4.57	7.02	
Audio	1. French	Subtitle	1. English	Angle	1
Dolby Digital 3/2.1CH					

Play		DVD			
	Current / Total	Elapsed	Remain	Total	
Chapter	11/38	2.05	4.57	7.02	
Tr. Rate					8.6Mbps

- VR format DVD-RW displays

Play		DVD-RW		Original	
	Current / Total	Elapsed	Remain	Total	
Title	1/32	0.08	30.22	30.30	
Chapter	1	Subtitle	--		
Audio Dolby Digital 2/0CH					

Play		DVD-RW		Original	
	Current / Total	Elapsed	Remain	Total	
Chapter	1/1				
Tr. Rate					4.3Mbps

- CD and Video CD displays

Play		CD			
	Current / Total	Elapsed	Remain	Total	
Track	2/16	1.07	4.40	5.47	

Play		CD			
	Current / Total	Elapsed	Remain	Total	
Disc		28.00	30.20	58.20	

- WMA/MP3 disc displays

Play		MP3			
	Current / Total	Elapsed	Remain	Total	
Track	1/17	0.18	12.42	13.00	
Track Name	Outernational				

Play		MP3			
	Current / Total	Elapsed	Remain	Total	
Folder	2/7				
Folder Name	ACP				

- JPEG disc displays

Play		JPEG			
	Current / Total	Elapsed	Remain	Total	
File	1/40				
File Name	FL000001				

Play		JPEG			
	Current / Total	Elapsed	Remain	Total	
Folder	1/40				
Folder Name	Holiday				



Note

- You can see disc information (number of titles/chapters, tracks, folders and so on) from the Disc Navigator screen. See *Using the Disc Navigator to browse the contents of a disc* on page 29.

Chapter 6

Viewing JPEG discs

Viewing JPEG discs

After loading a CD/CD-R/RW containing JPEG pictures, press ► to start a slideshow from the first folder/picture on the disc. The player displays the pictures in each folder in alphabetical order.

Pictures are automatically adjusted so that they fill as much of the screen as possible (if the aspect ratio of the picture is different to your TV screen you may notice black bars at the sides, or at the top and bottom of the screen).

While the slideshow is running:

Button	What it does
II	Pauses the slideshow; press again to restart.
◀◀	Displays the previous picture.
▶▶	Displays the next picture.
ANGLE	Pauses the slideshow and rotates the currently displayed picture 90° clockwise. Press ► (play) to restart slideshow).
ZOOM	Pauses the slideshow and zooms the screen (see below). Press ► (play) to restart slideshow).
MENU	Displays the Disc Navigator screen (see below).



Note

- The **II**, **ANGLE** and **ZOOM** buttons do not work while the display shows **LOADING**.
- The time it takes for the player to load a file increases with large file sizes.
- Up to 999 files are viewable on a disc. If there are more files than this on a disc, only the first 999 files are viewable.

Using the JPEG Disc Navigator and Photo Browser

Use the JPEG Disc Navigator to find a particular folder or picture by filename; use the Photo Browser to find a picture within a folder by thumbnail image.

1 Press MENU to display the Disc Navigator screen.

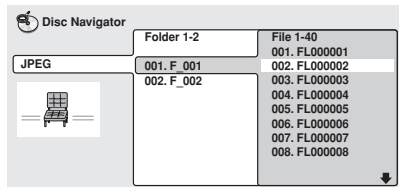

The left column shows the folders on the disc, the right column shows the files in a folder.

2 Use the cursor buttons (↑/↓/←/→) to navigate.

When a file is highlighted, a thumbnail image is displayed.

- When a folder is highlighted you can press **ENTER** to open the Photo Browser screen for that folder. See below for more on using the Photo Browser.

3 To resume the slideshow from the highlighted file, press **ENTER**.

Using the Photo Browser

The Photo Browser displays nine thumbnail images at a time from the current folder.

1 From the Disc Navigator screen, highlight a folder to display then press **ENTER**.

The Photo Browser screen opens with the first nine pictures displayed as thumbnails.

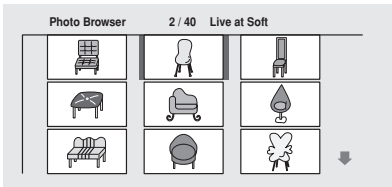

2 Use the cursor buttons (↑/↓/←/→) to highlight a thumbnail picture.

- Use the track skip buttons (|◀◀ and ▶▶|) to see the previous / next page of thumbnails. Keep the button pressed if you want to skip several pages; release when you reach the page you want.
- To return to the Disc Navigator screen, press **RETURN**.

3 Press **ENTER** to display the selected thumbnail full size on screen.

The slideshow resumes from the selected picture.

Zooming the screen

Using the zoom feature you can magnify a part of the screen by a factor of 2 or 4, while viewing pictures from a JPEG disc.

1 During slideshow playback, use the **ZOOM** button to select the zoom factor.

- **Normal**
- **2x**
- **4x**

Normal

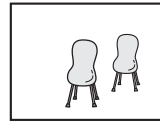

Zoom 2x

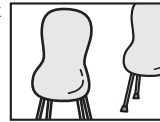

Zoom 4x



- The slideshow is paused when the screen is zoomed.
- Since JPEG pictures have a fixed resolution, picture quality may deteriorate, especially at 4x zoom. This is not a malfunction.

2 Use the cursor buttons (↑/↓/←/→) to change the zoomed area.

You can change the zoom factor and the zoomed area freely.

- When you change the zoom area, this becomes the new 'default' zoom area for the disc loaded.

3 To resume the slideshow, press ► (play).

Chapter 7

Audio Settings menu

Audio DRC

- Default setting: **Off**

When watching Dolby Digital DVDs at low volume, it's easy to lose the quieter sounds completely—including some of the dialog. Switching Audio DRC (Dynamic Range Control) to On can help by bringing up the quieter sounds, while controlling loud peaks. How much of a difference you hear depends on the material you're listening to. If the material doesn't have wide variations in volume, you may not notice much change.

- 1 Press **HOME MENU** and select 'Audio Settings' from the on-screen display.

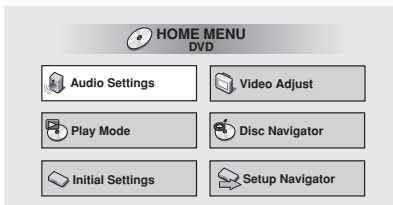

- 2 Highlight Audio DRC, then use the **←/→** (cursor left/right) buttons to change to 'On' or 'Off', as required.



- 3 Press **ENTER** to make the setting and exit the Audio Settings screen.

 **Note**

- Audio DRC is only effective with Dolby Digital audio sources.
- Audio DRC is only effective through the digital output when **Digital Out** (see page 46) is set to **On**, and **Dolby Digital Out** (see page 46) is set to **Dolby Digital > PCM**.
- The effect of Audio DRC depends on your speakers and AV receiver settings.

Virtual Surround

- Default setting: **Off**

Switch on Virtual Surround to enjoy surround sound effects from just two speakers.

When you play a Dolby Digital soundtrack, Virtual Dolby Digital, which uses TruSurround technology from SRS, produces a deep, realistic 3D soundspace from a pair of stereo speakers.

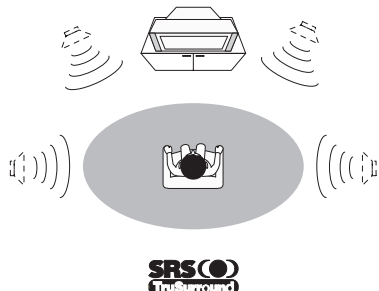

1 Press HOME MENU and select 'Audio Settings' from the on-screen display.

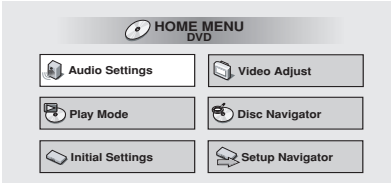

2 Highlight Virtual Surround, then use the ←/→ (cursor left/right) buttons to change to 'Dolby/SRS TruSurround' or 'Off', as required.



3 Press ENTER to make the setting and exit the Audio Settings screen.



Tip

- You can also use the **SURROUND** button on the remote control to switch Virtual Surround on (**Dolby/SRS TruSurround**)/ **Off**.



Note

- Virtual Surround doesn't work with DTS or 96kHz linear PCM audio through either the analog or digital outputs.
- If the player is outputting Dolby Digital or MPEG bitstream audio (in other words, no conversion to PCM), Virtual Surround has no effect on the audio from the digital output. See *Digital Audio Out settings* on page 46 for how to set up the digital output formats.
- How good the surround effect is varies with the disc.

Chapter 8

Video Adjust menu

Video Adjust

- Default setting: **Standard**

From the Video Adjust screen you can select the standard video presentation or define presets of your own.

- 1 Press **HOME MENU** and select 'Video Adjust' from the on-screen display.

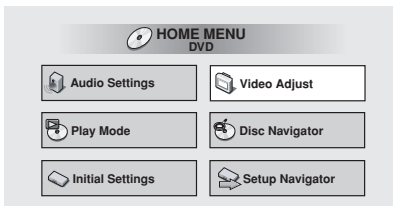

- 2 Use the **←/→** (cursor left/right) buttons to select a preset.

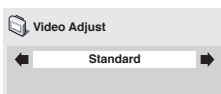

- **Standard** – Normal
- **Memory1–2** – Use for saving your own presets (see below)

- 3 Press **ENTER** to make the setting and exit the Video Adjust screen.

Note

- Depending on the disc and the TV/monitor, you may not see the effect clearly.

Creating your own presets

You can create up to three presets of your own.

- 1 Select one of the Memory presets (see above).
- 2 Press **↓** (cursor down) to select 'Detailed Settings' then press **ENTER**.

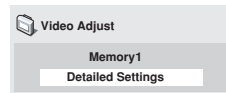

- 3 Adjust the picture quality settings.

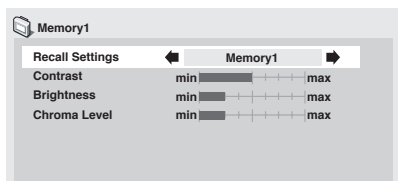

- Use the **↑/↓** (cursor up/down) buttons to select a setting.
- Use the **←/→** (cursor left/right) buttons to adjust the current setting.
- Press **DISPLAY** to switch between full and single view.
- You can change the preset number from the **Recall Settings** menu item.

You can adjust any or all of the following picture quality settings:

- **Contrast** – Adjusts the contrast between light and dark.
- **Brightness** – Adjusts the overall brightness.
- **Chroma Level** – Adjusts how saturated colors appear.

4 Press ENTER to save the preset and exit the Video Adjust screen.

Chapter 9

Initial Settings menu

Using the Initial Settings menu

The Initial Settings menu gives you complete control in setting up your DVD player, including audio, and video output settings, audience limitation settings, among others.

If an option is grayed out it means that it cannot be changed at the current time. This is usually because a disc is playing. Stop the disc, then change the setting.

1 Press HOME MENU and select 'Initial Settings' from the on-screen display.

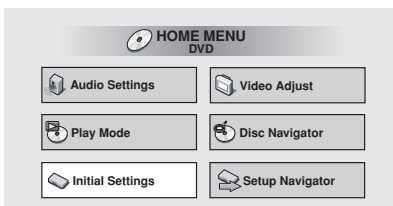

2 Select the setup category from the list on the left, then select an item from the menu list to the right.

3 Make the setting you want.



Note

- The language options shown in the on-screen display illustrations on the following pages may not correspond to those available in your country or region.

Digital Audio Out settings

Digital Out

You only need to make this setting if you connected this player to an AV receiver (or other component) using one of the digital outputs.

- Default setting: **On**

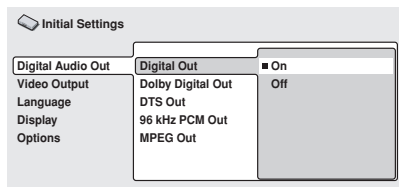

If at any time you need to switch off the digital audio output, set this to **Off**, otherwise leave it **On**.

Note that you can't switch on/off the optical and coaxial outputs individually.

Dolby Digital Out

You only need to make this setting if you connected this player to an AV receiver (or other component) using one of the digital outputs.

- Default setting: **Dolby Digital**

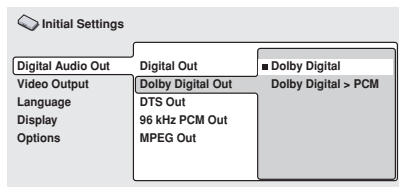

If your AV receiver (or other connected component) is Dolby Digital compatible, set to **Dolby Digital**, otherwise set to **Dolby Digital > PCM**.

DTS Out

You only need to make this setting if you connected this player to an AV receiver (or other component) using one of the digital outputs.

- Default setting: **DTS**

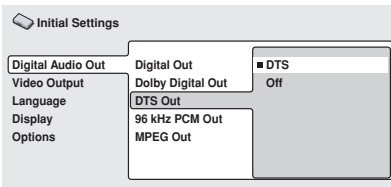

If your AV receiver (or other connected component) has a built-in DTS decoder, set this to **DTS**, otherwise set to **Off**. Check the manual that came with the other component if you're unsure whether it is DTS compatible.

Note

- If you set to **DTS** with a non-DTS compatible amplifier, noise will be output when you play a DTS disc.

96kHz PCM Out

You only need to make this setting if you connected this player to an AV receiver (or other component) using one of the digital outputs.

- Default setting: **96kHz > 48kHz**

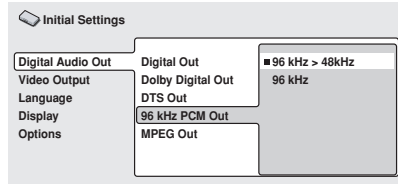

If your AV receiver (or other connected component) is compatible with high sampling rates (96 kHz), set this to **96kHz**, otherwise set it to **96kHz > 48kHz** (96 kHz audio is converted to a more compatible 48 kHz). Check the manual that came with the other component if you're unsure whether it is 96 kHz compatible.

MPEG Out

You only need to make this setting if you connected this player to an AV receiver (or other component) using one of the digital outputs.

- Default setting: **MPEG > PCM**

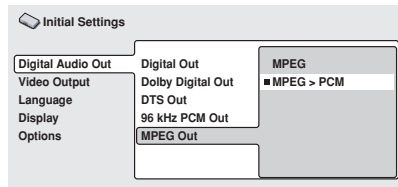

If your AV receiver (or other connected component) is compatible with MPEG audio, set this to **MPEG**, otherwise set it to **MPEG > PCM** (MPEG audio is converted to more compatible PCM audio). Check the manual that came with the other component if you're unsure whether it is MPEG audio compatible.

Video Output settings

TV Screen

- Default setting: **4:3 (Letter Box)**

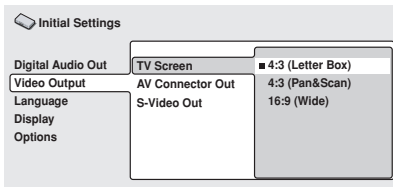

If you have a widescreen TV, select the **16:9 (Wide)** setting—widescreen DVD software is then shown using the full screen area. When playing software recorded in conventional (4:3) format, the settings on your TV will determine how the material is presented—see the manual that came with your TV for details on what options are available.

If you have a conventional TV, select either **4:3 (Letter Box)** or **4:3 (Pan & Scan)**. In Letter Box mode, widescreen software is shown with black bars at the top and bottom of the screen. Pan & Scan chops the sides off widescreen material to make it fit the 4:3 screen (so even though the image looks larger on the screen, you're actually seeing less of the picture). See also *Screen sizes and disc formats* on page 56.

AV Connector Out

You only need to make this setting if you connected this player to your TV using the AV SCART-type connector.

- Default setting: **Video**



Important

- If you make a setting here that is incompatible with your TV, the TV may not display any picture at all. If this happens either switch everything off and reconnect to the TV using either the supplied audio/video cable, or an S-Video cable (see page 13 and page 14 for more on this).
- SCART cables come in various configurations. Make sure you use the correct one for your TV/monitor. See page 62 for the SCART pin assignment diagram.

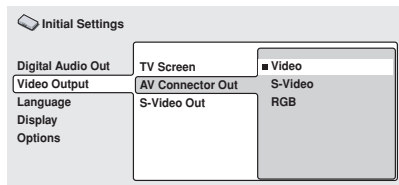

- **Video** – Standard video, compatible with all TVs.
- **S-Video** – Higher quality, but check your TV for compatibility.
- **RGB** – Best quality, but check your TV for compatibility.

S-Video Out

You only need to make this setting if you connected this player to your TV using an S-video cable.

- Default setting: **S2**

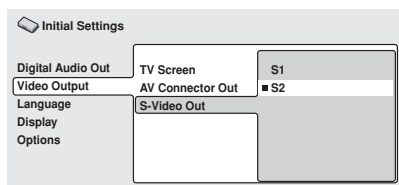

If you find that the picture is stretched or distorted on the default **S2** setting, try changing it to **S1**.

Language settings

Audio Language

- Default setting: **English**

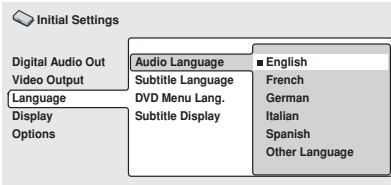

This setting is your preferred audio language for DVD discs. If the language you specify here is recorded on a disc, the player automatically plays the disc in that language.

The DVD format recognizes 136 different languages. Select **Other Language** if you want to specify a language other than those listed. See also *Selecting languages using the language code list* on page 58.



Tip

- You can switch between the languages recorded on a DVD disc during playback using the **AUDIO** button. (This does not affect this setting.) See *Switching DVD audio language* on page 37.
- Some DVD discs set the audio language automatically when loaded, overriding the **Audio Language** setting.
- Discs with two or more audio languages usually allow you to select the audio language from the disc menu. Press **MENU** to access the disc menu.

Subtitle Language

- Default setting: **English**

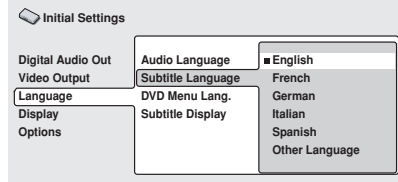

This setting is your preferred subtitle language for DVD discs. If the language you specify here is recorded on a disc, the player automatically plays the disc with those subtitles.

The DVD format recognizes 136 different languages. Select **Other Language** if you want to specify a language other than those listed. See also *Selecting languages using the language code list* on page 58.



Tip

- You can change or switch off the subtitles on a DVD disc during playback using the **SUBTITLE** button. (This does not affect this setting.) See *Switching subtitles* on page 37.
- Some DVD discs set the subtitle language automatically when loaded, overriding the **Subtitle Language** setting.
- Discs with two or more subtitle languages usually allow you to select the subtitle language from the disc menu. Press **MENU** to access the disc menu.

DVD Menu Language

- Default setting: **w/Subtitle Lang.**

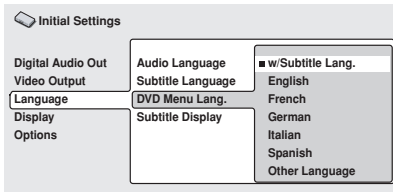

Some multilingual discs have disc menus in several languages. This setting specifies in which language the disc menus should appear. Leave on the default setting for menus to appear in the same language as your **Subtitle Language**—see above.

The DVD format recognizes 136 different languages. Select **Other Language** if you want to specify a language other than those listed. See also *Selecting languages using the language code list* on page 58.

Subtitle Display

- Default setting: **On**

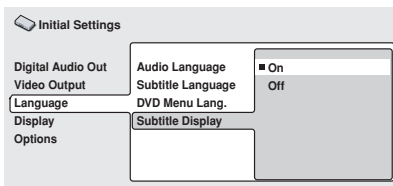

When set to **On**, the player displays subtitles according to the **Subtitle Language** setting. Set to **Off** to switch subtitles off altogether.

Display settings

OSD Language

- Default setting: **English**

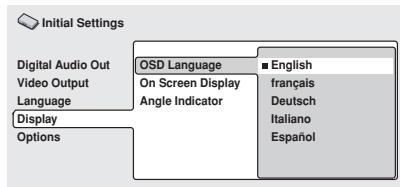

This sets the language of this player's on-screen displays.

On Screen Display

- Default setting: **On**

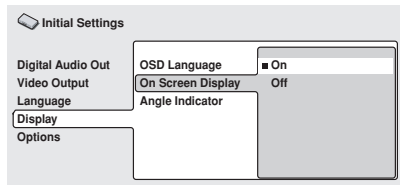

This sets whether operation displays are shown on-screen (**Play**, **Resume**, **Scan** and so on.)

Angle Indicator

- Default setting: **On**

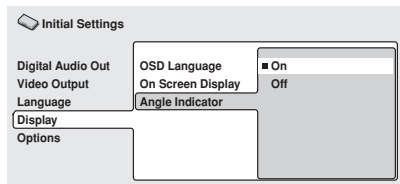

If you prefer not to see the camera icon on-screen during multi-angle scenes on DVD discs, change this setting to **Off**.

Options

Parental Lock

- Default level: **Off**
- Default password: *none*
- Default Country code: **us (2119)**

Some DVD-Video discs feature a Parental Lock level. If your player is set to a lower level than the disc, the disc won't play. This gives you some control about what your children watch on your DVD player.

Some discs also support the Country code feature. The player does not play certain scenes on these discs, depending on the Country code you set.

Before you can set the Parental Lock level or the Country code you must register a password. As the password owner, you can change the Parental Lock level or Country code whenever you like. You can also change the password.



Note

- Not all discs that you may consider inappropriate for your children use the Parental Lock feature. These discs will always play without requiring the password first.
- If you forget your password, you'll need to reset the player to its factory settings (See "Resetting the player" on page 58.), then register a new password.

Registering a new password

You must register a password before you can change the Parental Lock level or enter a Country code.

1 Select 'Password'.

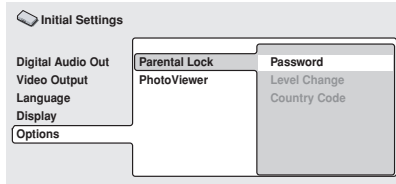

2 Use the number buttons to enter a 4-digit password.

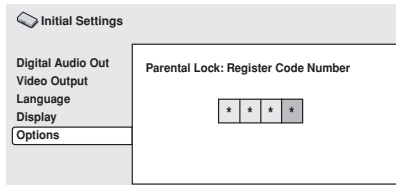

The numbers you enter show up as asterisks (*) on-screen.

3 Press ENTER to register the password and return to the Options menu screen.

If you forget your password, you can reset the player then register a new one. See *Resetting the player* on page 58 for how to reset the player.

Changing your password

To change your password, confirm your existing password then enter a new one.

1 Select 'Password Change'.

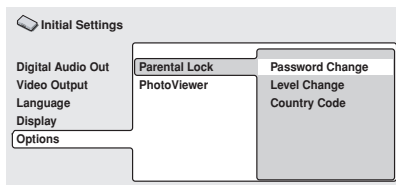

2 Use the number buttons to enter your existing password, then press ENTER.

The numbers appear as asterisks as you enter them.

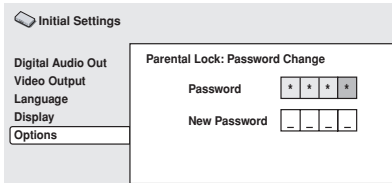

3 Enter a new password.

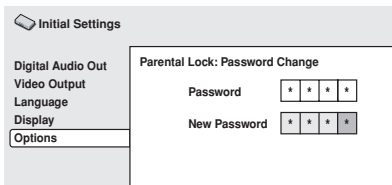

4 Press ENTER to register the new password and return to the Options menu screen.

Setting/changing the Parental Lock level

1 Select 'Level Change'.

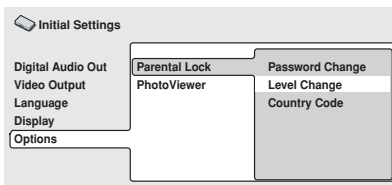

2 Use number buttons to enter your password, then press ENTER.

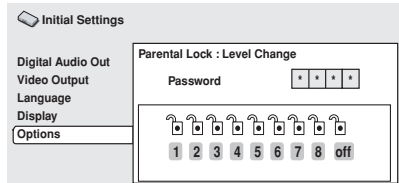

3 Select a new level.

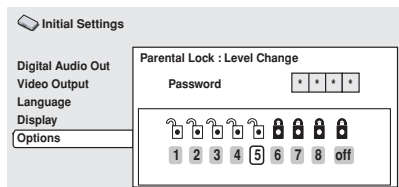

Press ← (cursor left) repeatedly to lock more levels (more discs will require the password); press → (cursor right) to unlock levels. You can't lock level 1.

4 Press ENTER to set the new level and return to the Options menu screen.

Setting/changing the Country code

You may also want to refer to the *Country code list* on page 59.

1 Select 'Country Code'.

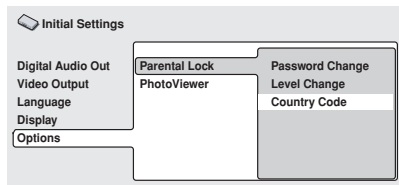

2 Use number buttons to enter your password, then press ENTER.

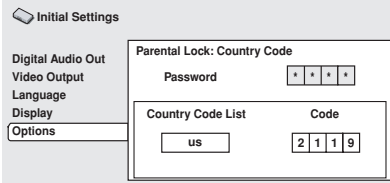

3 Select a Country code.

There are two ways you can do this.

- Select by code letter: Use **↑/↓** (cursor up/down) to change the Country code.

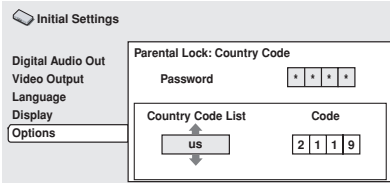

- Select by code number: Press **→** (cursor right) then use the number buttons to enter the 4-digit Country code (you can find the *Country code list* on page 59.)

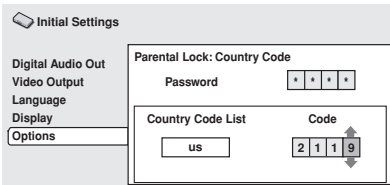

4 Press ENTER to set the new Country code and return to the Options menu screen.



Note

- Changing the Country code does not take effect until the next disc is loaded (or the current disc is reloaded).

PhotoViewer

- Default setting: **On**

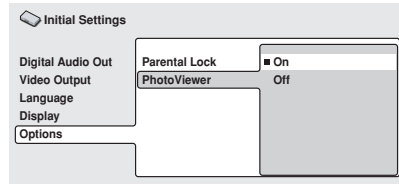

This setting is important if you load a disc that contains both WMA/MP3 audio files and JPEG picture files.

The default **On** setting allows you to view only the JPEG files on this kind of disc. Set to **Off** to be able to play the WMA/MP3 audio files.



Note

- Changing the PhotoViewer setting does not take effect until the next disc is loaded (or the current disc is reloaded).

Chapter 10

Additional information

Taking care of your player and discs

Handling discs

When holding discs of any type, take care not to leave fingerprints, dirt or scratches on the disc surface. Hold the disc by its edge or by the center hole and edge.

Damaged or dirty discs can affect playback performance. Take care also not to scratch the label side of the disc. Although not as fragile as the recorded side, scratches can still result in a disc becoming unusable.

Should a disc become marked with fingerprints, dust, etc., clean using a soft, dry cloth, wiping the disc lightly from the center to the outside edge as shown in the diagram below.

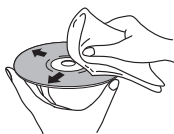

Wipe lightly from the center of the disc using straight strokes.



Don't wipe the disc surface using circular strokes.

If necessary, use a cloth soaked in alcohol, or a commercially available CD/DVD cleaning kit to clean a disc more thoroughly. Never use benzene, thinner or other cleaning agents, including products designed for cleaning vinyl records.

Storing discs

Although CDs and DVD discs are more durable than vinyl records, you should still take care to handle and store discs correctly. When you're not using a disc, return it to its case and store upright. Avoid leaving discs in excessively cold, humid, or hot environments (including under direct sunlight).

Don't glue paper or put stickers onto the disc, or use a pencil, ball-point pen or other sharp-tipped writing instrument. These could all damage the disc.



For more detailed care information see the instructions that come with discs.

Do not load more than one disc into the player at a time.

Discs to avoid

Discs spin at high speed inside the player. If you can see that a disc is cracked, chipped, warped, or otherwise damaged, don't risk using it in your player—you could end up damaging it.

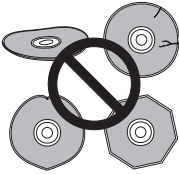

This player is designed for use with conventional, fully circular discs only. Use of shaped discs is not recommended for this product. Pioneer disclaims all liability arising in connection with the use of shaped discs.

Cleaning the unit's exterior

- Use a polishing cloth or dry cloth to wipe off dust and dirt. If the surfaces are very dirty, wipe with a soft cloth dipped in some neutral cleanser diluted five or six times with water and wrung out well, then wipe again with a dry cloth.
- Do not use furniture wax or cleaners. Never use thinners, benzine or insecticide sprays or other chemicals on or near this unit since they will corrode the surfaces.
- If you use a chemical-impregnated cleaning cloth, read the instructions carefully before use. These cloths may leave smear marks on half-mirror finish surfaces; if this happens, finish with a dry cloth.
- Unplug the unit when cleaning.

Cleaning the pickup lens

The DVD player's lens should not become dirty in normal use, but if for some reason it should malfunction due to dust or dirt, consult your nearest Pioneer-authorized service center. Although lens cleaners for CD players are commercially available, we do not recommend using them since some may damage the lens.

Problems with condensation

Condensation may form inside the player if it is brought into a warm room from outside, or if the temperature of the room rises quickly. Although the condensation won't damage the player, it may temporarily impair its performance. For this reason you should leave it to adjust to the warmer temperature for about an hour before switching on and using.

Hints on installation

We want you to enjoy using this product for years to come, so please bear in mind the following points when choosing a suitable location for it:

Do...

- Use in a well-ventilated room.
- Place on a solid, flat, level surface, such as a table, shelf or stereo rack.

Don't...

- Use in a place exposed to high temperatures or humidity, including near radiators and other heat-generating appliances.
- Place on a window sill or other place where the player will be exposed to direct sunlight.
- Use in an excessively dusty or damp environment.

- Place directly on top of an amplifier, or other component in your stereo system that becomes hot in use.
- Use near a television or monitor as you may experience interference—especially if the television uses an indoor antenna.
- Use in a kitchen or other room where the player may be exposed to smoke or steam.
- Use on a thick rug or carpet, or cover with cloth—this may prevent proper cooling of the unit.
- Place on an unstable surface, or one that is not large enough to support all four of the unit's feet.

Moving the player

If you need to move the player, first press **⏻ STANDBY/ON** on the front panel to turn the player off. Wait for **-OFF-** to disappear from the display, then unplug the power cable. Never lift or move the unit during playback—discs rotate at a high speed and may be damaged.

Power cable caution

Handle the power cable by the plug part. Do not pull out the plug by tugging the cable, and never touch the power cable when your hands are wet, as this could cause a short circuit or electric shock. Do not place the unit, a piece of furniture, or other object on the power cable or pinch the cable in any other way. Never make a knot in the cable or tie it with other cables. The power cables should be routed so that they are not likely to be stepped on. A damaged power cable can cause a fire or give you an electric shock. Check the power cable once in a while. If you find it damaged, ask your nearest Pioneer authorized service center or your dealer for a replacement.

Screen sizes and disc formats

DVD-Video discs come in several different screen aspect ratios, ranging from TV programs, which are generally 4:3, to Cinema-Scope widescreen movies, with an aspect ratio of up to about 7:3.

Televisions, too, come in different aspect ratios; 'standard' 4:3 and widescreen 16:9.

Widescreen TV users

If you have a widescreen TV, the **TV Screen** setting (page 48) of this player should be set to **16:9 (Wide)**.

When you watch discs recorded in 4:3 format, you can use the TV controls to select how the picture is presented. Your TV may offer various zoom and stretch options; see the instructions that came with your TV for details.

Please note that some movie aspect ratios are wider than 16:9, so even though you have a widescreen TV, these discs will still play in a 'letter box' style with black bars at the top and bottom of the screen.

Standard TV users

If you have a standard TV, the **TV Screen** setting (page 48) of this player should be set to **4:3 (Letter Box)** or **4:3 (Pan&Scan)**, depending on which you prefer.

Set to **4:3 (Letter Box)**, widescreen discs are shown with black bars top and bottom.



Set to **4:3 (Pan&Scan)**, widescreen discs are shown with the left and right sides cropped. Although the picture looks larger, you don't actually see the whole picture.



Please note that many widescreen discs override the player's settings so that the disc is shown in letter box format regardless of the setting.

Note

- Using the **16:9 (Wide)** setting with a standard 4:3 TV, or either of the **4:3** settings with a widescreen TV, will result in a distorted picture.

Setting the TV system

The default setting of this player is **AUTO**, and unless you notice that the picture is distorted when playing some discs, you should leave it set to **AUTO**. If you experience picture distortion with some discs, set the TV system to match your country or region's system. Doing this, however, may restrict the kinds of disc you can watch. The table below shows what kinds of disc are compatible with each setting (**AUTO**, **PAL** and **NTSC**).

1 If the player is on, press **⏻ STANDBY/ON** to switch it to standby.

2 Using the front panel controls, hold down **▶▶▶▶▶** then press **⏻ STANDBY/ON** to switch the TV system.

The TV system changes as follows:

- AUTO** → **NTSC**
- NTSC** → **PAL**
- PAL** → **AUTO**

The player's display shows "**Welcome Pioneer**", then indicates the new setting.

Note

- You have to switch the player into standby (press **⏻ STANDBY/ON**) before each change.

Disc Type	Format	Player setting		
		NTSC	PAL	AUTO
DVD	NTSC	NTSC	MOD.PAL	NTSC
	PAL	NTSC	PAL	PAL
Video CD	NTSC	NTSC	MOD.PAL	NTSC
	PAL	NTSC	PAL	PAL
CD/no disc	—	NTSC	PAL	NTSC or PAL

Watching NTSC on a PAL TV (MOD. PAL)

Most models of the newly developed count-down PAL TV system detect 50 Hz (PAL)/60 Hz (NTSC) and automatically switch vertical amplitude, resulting in a display without vertical shrinkage. However, in some cases, the image may appear without color.

If your PAL TV does not have a V-Hold control, you may not be able to watch NTSC discs because of picture roll. If the TV has a V-Hold control, adjust it until the picture stops rolling.

On some TVs, the picture may shrink vertically, leaving black bands at the top and bottom of the screen. This is not a malfunction; it is caused by the NTSC to PAL conversion.

Resetting the player

Use this procedure to reset all the player's settings to the factory default.

- 1 **Switch the player into standby.**
- 2 **Using the front panel buttons, hold down the ■ (stop) button and press ⏻ STANDBY/ON to switch the player back on.**

All the player's settings are now reset, and you should see the 'Let's Get Started' screen.

Titles, chapters and tracks

DVD discs are generally divided into one or more titles. Titles may be further subdivided into chapters.

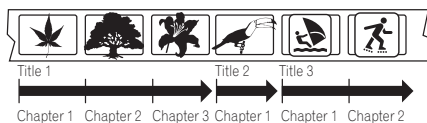

CDs and Video CDs are divided into tracks.



CD-ROMs contain folders and files. MP3 and WMA files are referred to as tracks. Folders may contain further folders.

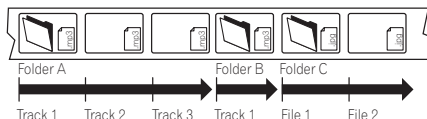

DVD-Video regions

All DVD-Video discs carry a region mark on the case somewhere that indicates which region(s) of the world the disc is compatible with. Your DVD player also has a region mark, which you can find on the rear panel. Discs from incompatible regions will not play in this player. Discs marked **ALL** will play in any player.

The diagram below shows the various DVD regions of the world.

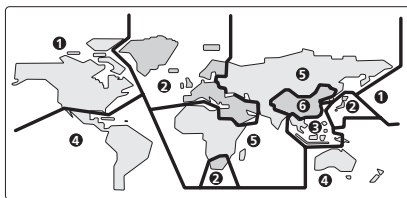

Selecting languages using the language code list

Some of the language options (such as 'DVD Language' in the Setup Navigator) allow you to set your preferred language from any of the 136 languages listed in the language code list on page 59.

- 1 **Select 'Other Language'.**
- 2 **Use the ←/→ (cursor left/right) buttons to select either a code letter or a code number.**
- 3 **Use the ↑/↓ (cursor up/down) buttons to select a code letter or a code number.**

See *Language code list* on page 59 for a complete list of languages and codes.

Language code list

Language (Language code letter), **Language code**

Japanese (ja), 1001	Bhutani (dz), 0426	Kirghiz (ky), 1125	Sinhalese (si), 1909
English (en), 0514	Esperanto (eo), 0515	Latin (la), 1201	Slovak (sk), 1911
French (fr), 0618	Estonian (et), 0520	Lingala (ln), 1214	Slovenian (sl), 1912
German (de), 0405	Basque (eu), 0521	Laothian (lo), 1215	Samoa (sm), 1913
Italian (it), 0920	Persian (fa), 0601	Lithuanian (lt), 1220	Shona (sn), 1914
Spanish (es), 0519	Finnish (fi), 0609	Latvian (lv), 1222	Somali (so), 1915
Chinese (zh), 2608	Fiji (fj), 0610	Malagasy (mg), 1307	Albanian (sq), 1917
Dutch (nl), 1412	Faroese (fo), 0615	Maori (mi), 1309	Serbian (sr), 1918
Portuguese (pt), 1620	Frisian (fy), 0625	Macedonian (mk), 1311	Siswati (ss), 1919
Swedish (sv), 1922	Irish (ga), 0701	Malayalam (ml), 1312	Sesotho (st), 1920
Russian (ru), 1821	Scots-Gaelic (gd), 0704	Mongolian (mn), 1314	Sundanese (su), 1921
Korean (ko), 1115	Galician (gl), 0712	Moldavian (mo), 1315	Swahili (sw), 1923
Greek (el), 0512	Guarani (gn), 0714	Marathi (mr), 1318	Tamil (ta), 2001
Afar (aa), 0101	Gujarati (gu), 0721	Malay (ms), 1319	Telugu (te), 2005
Abkhazian (ab), 0102	Hausa (ha), 0801	Maltese (mt), 1320	Tajik (tg), 2007
Afrikaans (af), 0106	Hindi (hi), 0809	Burmese (my), 1325	Thai (th), 2008
Amharic (am), 0113	Croatian (hr), 0818	Nauru (na), 1401	Tigrinya (ti), 2009
Arabic (ar), 0118	Hungarian (hu), 0821	Nepali (ne), 1405	Turkmen (tk), 2011
Assamese (as), 0119	Armenian (hy), 0825	Norwegian (no), 1415	Tagalog (tl), 2012
Aymara (ay), 0125	Interlingua (ia), 0901	Occitan (oc), 1503	Setswana (tn), 2014
Azerbaijani (az), 0126	Interlingue (ie), 0905	Oromo (om), 1513	Tonga (to), 2015
Bashkir (ba), 0201	Inupiak (ik), 0911	Oriya (or), 1518	Turkish (tr), 2018
Byelorussian (be), 0205	Indonesian (in), 0914	Panjabi (pa), 1601	Tsonga (ts), 2019
Bulgarian (bg), 0207	Icelandic (is), 0919	Polish (pl), 1612	Tatar (tt), 2020
Bihari (bh), 0208	Hebrew (iw), 0923	Pashto, Pushto (ps), 1619	Twi (tw), 2023
Bislama (bi), 0209	Yiddish (ji), 1009	Quechua (qu), 1721	Ukrainian (uk), 2111
Bengali (bn), 0214	Javanese (jw), 1023	Rhaeto-Romance (rm), 1813	Urdu (ur), 2118
Tibetan (bo), 0215	Georgian (ka), 1101	Kirundi (rn), 1814	Uzbek (uz), 2126
Breton (br), 0218	Kazakh (kk), 1111	Romanian (ro), 1815	Vietnamese (vi), 2209
Catalan (ca), 0301	Greenlandic (kl), 1112	Kinyarwanda (rw), 1823	Volapük (vo), 2215
Corsican (co), 0315	Cambodian (km), 1113	Sanskrit (sa), 1901	Wolof (wo), 2315
Czech (cs), 0319	Kannada (kn), 1114	Sindhi (sd), 1904	Xhosa (xh), 2408
Welsh (cy), 0325	Kashmiri (ks), 1119	Sangho (sg), 1907	Yoruba (yo), 2515
Danish (da), 0401	Kurdish (ku), 1121	Serbo-Croatian (sh), 1908	Zulu (zu), 2621

Country code list

Country, **Country code**, **Country code letter**

Argentina, 0118, ar	Hong Kong, 0811, hk	Philippines, 1608, ph
Australia, 0121, au	India, 0914, in	Portugal, 1620, pt
Austria, 0120, at	Indonesia, 0904, id	Russian Federation, 1821, ru
Belgium, 0205, be	Italy, 0920, it	Singapore, 1907, sg
Brazil, 0218, br	Japan, 1016, jp	Spain, 0519, es
Canada, 0301, ca	Korea, Republic of, 1118, kr	Sweden, 1905, se
Chile, 0312, cl	Malaysia, 1325, my	Switzerland, 0308, ch
China, 0314, cn	Mexico, 1324, mx	Taiwan, 2023, tw
Denmark, 0411, dk	Netherlands, 1412, nl	Thailand, 2008, th
Finland, 0609, fi	New Zealand, 1426, nz	United Kingdom, 0702, gb
France, 0618, fr	Norway, 1415, no	USA, 2119, us
Germany, 0405, de	Pakistan, 1611, pk	

Glossary

Analog audio

An electrical signal that directly represents sound. Compare this to digital audio which can be an electrical signal, but is an indirect representation of sound. See also *Digital audio*.

Aspect ratio

The width of a TV screen relative to its height. Conventional TVs are 4:3 (in other words, the screen is almost square); widescreen models are 16:9 (the screen is almost twice as wide as it is high).

Digital audio

An indirect representation of sound by numbers. During recording, the sound is measured at discrete intervals (44,100 times a second for CD audio) by an analog-to-digital converter, generating a stream of numbers. On playback, a digital-to-analog converter generates an analog signal based on these numbers. See also *Sampling frequency* and *Analog audio*.

Dolby Digital



Using a maximum of 5.1 channels of audio, this high quality surround system is used in many of the finer movie theaters around the world.

The on-screen display shows which channels are active, for example showing 3/2.1. The 3 being the two front channels and the center channel; the 2 being the surround channels, and the .1 being the LFE channel.

DRM

DRM (digital rights management) is a type of server software developed to enable secure distribution of paid content over the web, recently incorporated by WMA (Windows Media Audio).

DTS



DTS stands for Digital Theater Systems. DTS is a surround system different from Dolby Digital that has become a popular surround sound format for movies.

Dynamic range

The difference between the quietest and loudest sounds possible in an audio signal (without distorting or getting lost in noise). Dolby Digital and DTS soundtracks are capable of a very wide dynamic range, delivering dramatic cinema-like effects.

EXIF (Exchangeable Image File)

A file format developed by Fuji Photo Film for digital still cameras. Digital cameras from various manufacturers use this compressed file format which carries date, time and thumbnail information, as well as the picture data.

File extension

A tag added to the end of a filename to indicate the type of file. For example, ".mp3" indicates an MP3 file.

ISO 9660 format

This is the international standard for the format logic of CD-ROM folders and files. For the ISO9660 format, there are regulations for the following two levels.

JPEG

A file format used for still images, such as photographs and illustrations. JPEG files are identified by the file extension “.jpg” or “.JPG”. Most digital cameras use this format.

MP3

MP3 (MPEG1 audio layer 3) is a compressed audio file format. Files are recognized by their file extension “.mp3” or “.MP3”.

MPEG audio

An audio format used on Video CDs and some DVD discs. This unit can convert MPEG audio to PCM format for wider compatibility with digital recorders and AV amplifiers. See also *PCM (Pulse Code Modulation)*.

MPEG video

The video format used for Video CDs and DVDs. Video CD uses the older MPEG-1 standard, while DVD uses the newer and much better quality MPEG-2 standard.

PBC (PlayBack Control) (Video CD only)

A system of navigating a Video CD through on-screen menus recorded onto the disc. Especially good for discs that you would normally not watch from beginning to end all at once—karaoke discs, for example.

PCM (Pulse Code Modulation)

The most common system of encoding digital audio, found on CDs and DAT. Excellent quality, but requires a lot of data compared to formats such as Dolby Digital and MPEG audio. For compatibility with digital audio recorders (CD, MD and DAT) and AV amplifiers with digital inputs, this unit can convert Dolby Digital, DTS and MPEG audio to PCM. See also *Digital audio*.

Regions (DVD-Video only)

These associate discs and players with particular areas of the world. This unit will only play discs that have compatible region codes. You can find the region code of your unit by looking on the rear panel. Some discs are compatible with more than one region (or all regions).

Sampling frequency

The rate at which sound is measured to be turned into digital audio data. The higher the rate, the better the sound quality, but the more digital information is generated. Standard CD audio has a sampling frequency of 44.1kHz, which means 44,100 samples (measurements) per second. See also *Digital audio*.

WMA

WMA is short for Windows Media Audio and refers to an audio compression technology developed by Microsoft Corporation. WMA data can be encoded by using Windows Media Player version 8 or Windows Media Player for Windows XP. Files are recognized by their file extension “.wma” or “.WMA”.

Microsoft, Windows Media, and the Windows logo are trademarks, or registered trademarks of Microsoft Corporation in the United States and/or other countries.

Specifications

General

System	DVD player
Power requirements	AC 220-240 V, 50/60 Hz
Power consumption	12 W
Power consumption (standby)	0.18 W
Weight	2.3 kg
Dimensions:	
DV-2650	420 (W) x 53 (H) x 283 (D) mm
DV-360	420 (W) x 53 (H) x 277 (D) mm
DV-464	420 (W) x 55 (H) x 283 (D) mm
Operating temperature	+5°C to +35°C
Operating humidity	.5% to 85% (no condensation)

AV connector output

AV Connector (21-pin connector assignment)
 AV connector output 21-pin connector
 This connector provides the video and audio signals for connection to a compatible colour TV or monitor.

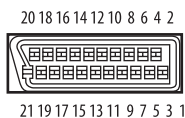

PIN no.	
1	Audio 2/R out
3	Audio 1/L out
4	GND
7	B out
8	Status
11	G out
15	R or C out
17	GND
19	Video out or Y out
21	GND

S-video output

Y (luminance) - Output level	1 Vp-p (75 Ω)
C (color) - Output level	286 mVp-p (75 Ω)
Jack	S-video jack

Video output

Output level	1 Vp-p (75 Ω)
Jack	RCA jack

Audio output (1 stereo pair)

Output level	During audio output 200 mVrms (1 kHz, -20 dB)
Number of channels	2
Jacks	RCA jack

Digital audio characteristics

Frequency response	.4 Hz to 44 kHz (DVD fs: 96 kHz)
S/N ratio	115 dB
Dynamic range	101 dB
Total harmonic distortion	0.0016 %
Wow and flutter	Limit of measurement (±0.001% W. PEAK) or lower

Digital output

Optical digital output	Optical digital jack
Coaxial digital output	RCA jack

Accessories

Audio/video cable	1
Power cable	1
Remote control	1
AA/R6P dry cell batteries	2
Operating Instructions	1
Warranty card	1



Note

- The specifications and design of this product are subject to change without notice, due to improvement.

Published by Pioneer Corporation.
Copyright © 2003 Pioneer Corporation.
All rights reserved

PIONEER CORPORATION

4-1, Meguro 1-Chome, Meguro-ku, Tokyo 153-8654, Japan

PIONEER ELECTRONICS (USA) INC.

P.O. BOX 1540, Long Beach, California 90810-1540, U.S.A. TEL: (800) 421-1404

PIONEER ELECTRONICS OF CANADA, INC.

300 Allstate Parkway, Markham, Ontario L3R OP2, Canada TEL: (905) 479-4411

PIONEER EUROPE NV

Haven 1087, Keetberglaan 1, B-9120 Melsele, Belgium TEL: 03/570.05.11

PIONEER ELECTRONICS ASIACENTRE PTE. LTD.

253 Alexandra Road, #04-01, Singapore 159936 TEL: 656-472-1111

PIONEER ELECTRONICS AUSTRALIA PTY. LTD.

178-184 Boundary Road, Braeside, Victoria 3195, Australia, TEL: (03) 9586-6300

PIONEER ELECTRONICS DE MEXICO S.A. DE C.V.

Bldv.Manuel Avila Camacho 138 10 piso Col.Lomas de Chapultepec, Mexico,D.F. 11000 TEL: 55-9178-4270

K002E

Free Manuals Download Website

<http://myh66.com>

<http://usermanuals.us>

<http://www.somanuals.com>

<http://www.4manuals.cc>

<http://www.manual-lib.com>

<http://www.404manual.com>

<http://www.luxmanual.com>

<http://aubethermostatmanual.com>

Golf course search by state

<http://golfingnear.com>

Email search by domain

<http://emailbydomain.com>

Auto manuals search

<http://auto.somanuals.com>

TV manuals search

<http://tv.somanuals.com>