

Pioneer *sound.vision.soul*

DVD Recorder

DVR-220

DVR-320

Register Your Product on
www.pioneerelectronics.com

Operating Instructions

RW
COMPATIBLE





The lightning flash with arrowhead, within an equilateral triangle, is intended to alert the user to the presence of uninsulated "dangerous voltage" within the product's enclosure that may be of sufficient magnitude to constitute a risk of electric shock to persons.

CAUTION

**RISK OF ELECTRIC SHOCK
DO NOT OPEN**

CAUTION:

TO PREVENT THE RISK OF ELECTRIC SHOCK, DO NOT REMOVE COVER (OR BACK). NO USER-SERVICEABLE PARTS INSIDE. REFER SERVICING TO QUALIFIED SERVICE PERSONNEL.



The exclamation point within an equilateral triangle is intended to alert the user to the presence of important operating and maintenance (servicing) instructions in the literature accompanying the appliance.

D1-4-2-3_En

IMPORTANT NOTICE – THE SERIAL NUMBER FOR THIS EQUIPMENT IS LOCATED IN THE REAR. PLEASE WRITE THIS SERIAL NUMBER ON YOUR ENCLOSED WARRANTY CARD AND KEEP IN A SECURE AREA. THIS IS FOR YOUR SECURITY.

D1-4-2-6-1_En

Information to User

Alteration or modifications carried out without appropriate authorization may invalidate the user's right to operate the equipment.

D8-10-2_En

NOTE: This equipment has been tested and found to comply with the limits for a Class B digital device, pursuant to Part 15 of the FCC Rules. These limits are designed to provide reasonable protection against harmful interference in a residential installation. This equipment generates, uses, and can radiate radio frequency energy and, if not installed and used in accordance with the instructions, may cause harmful interference to radio communications. However, there is no guarantee that interference will not occur in a particular installation. If this equipment does cause harmful interference to radio or television reception, which can be determined by turning the equipment off and on, the user is encouraged to try to correct the interference by one or more of the following measures:

- Reorient or relocate the receiving antenna.
- Increase the separation between the equipment and receiver.
- Connect the equipment into an outlet on a circuit different from that to which the receiver is connected.
- Consult the dealer or an experienced radio/TV technician for help.

D8-10-1-2_En

CAUTION : USE OF CONTROLS OR ADJUSTMENTS OR PERFORMANCE OF PROCEDURES OTHER THAN THOSE SPECIFIED HEREIN MAY RESULT IN HAZARDOUS RADIATION EXPOSURE.

CAUTION : THE USE OF OPTICAL INSTRUMENTS WITH THIS PRODUCT WILL INCREASE EYE HAZARD. D6-8-2-1_En

WARNING – TO PREVENT FIRE OR SHOCK HAZARD, DO NOT EXPOSE THIS APPLIANCE TO RAIN OR MOISTURE.

D1-4-2-1_En

CAUTION: This product satisfies FCC regulations when shielded cables and connectors are used to connect the unit to other equipment. To prevent electromagnetic interference with electric appliances such as radios and televisions, use shielded cables and connectors for connections.

D8-10-3a_En

This Class B digital apparatus complies with Canadian ICES-003.

Cet appareil numérique de la Classe B est conforme à la norme NMB-003 du Canada.

D8-10-1-3_En

IMPORTANT SAFETY INSTRUCTIONS

READ INSTRUCTIONS — All the safety and operating instructions should be read before the product is operated.

RETAIN INSTRUCTIONS — The safety and operating instructions should be retained for future reference.

HEED WARNINGS — All warnings on the product and in the operating instructions should be adhered to.

FOLLOW INSTRUCTIONS — All operating and use instructions should be followed.

CLEANING — The product should be cleaned only with a polishing cloth or a soft dry cloth. Never clean with furniture wax, benzene, insecticides or other volatile liquids since they may corrode the cabinet.

ATTACHMENTS — Do not use attachments not recommended by the product manufacturer as they may cause hazards.

WATER AND MOISTURE — Do not use this product near water — for example, near a bathtub, wash bowl, kitchen sink, or laundry tub; in a wet basement; or near a swimming pool; and the like.

ACCESSORIES — Do not place this product on an unstable cart, stand, tripod, bracket, or table. The product may fall, causing serious injury to a child or adult, and serious damage to the product. Use only with a cart, stand, tripod, bracket, or table recommended by the manufacturer, or sold with the product. Any mounting of the product should follow the manufacturer's instructions, and should use a mounting accessory recommended by the manufacturer.

CART — A product and cart combination should be moved with care. Quick stops, excessive force, and uneven surfaces may cause the product and cart combination to overturn.



VENTILATION — Slots and openings in the cabinet are provided for ventilation and to ensure reliable operation of the product and to protect it from overheating, and these openings must not be blocked or covered. The openings should never be blocked by placing the product on a bed, sofa, rug, or other similar surface. This product should not be placed in a built-in installation such as a bookcase or rack unless proper ventilation is provided or the manufacturer's instructions have been adhered to.

POWER SOURCES — This product should be operated only from the type of power source indicated on the marking label. If you are not sure of the type of power supply to your home, consult your product dealer or local power company.

LOCATION — The appliance should be installed in a stable location.

NONUSE PERIODS — The power cord of the appliance should be unplugged from the outlet when left un-used for a long period of time.

GROUNDING OR POLARIZATION

- If this product is equipped with a polarized alternating current line plug (a plug having one blade wider than the other), it will fit into the outlet only one way. This is a safety feature. If you are unable to insert the plug fully into the outlet, try reversing the plug. If the plug should still fail to fit, contact your electrician to replace your obsolete outlet. Do not defeat the safety purpose of the polarized plug.
- If this product is equipped with a three-wire grounding type plug, a plug having a third (grounding) pin, it will only fit into a grounding type power outlet. This is a safety feature. If you are unable to insert the plug into the outlet, contact your electrician to replace your obsolete outlet. Do not defeat the safety purpose of the grounding type plug.

POWER-CORD PROTECTION — Power-supply cords should be routed so that they are not likely to be walked on or pinched by items placed upon or against them, paying particular attention to cords at plugs, convenience receptacles, and the point where they exit from the product.

OUTDOOR ANTENNA GROUNDING — If an outside antenna or cable system is connected to the product, be sure the antenna or cable system is grounded so as to provide some protection against voltage surges and built-up static charges. Article 810 of the National Electrical Code, ANSI/NFPA 70, provides information with regard to proper grounding of the mast and supporting structure, grounding of the lead-in wire to an antenna discharge unit, size of grounding conductors, location of antenna-discharge unit, connection to grounding electrodes, and requirements for the grounding electrode. See Figure A.

LIGHTNING — For added protection for this product during a lightning storm, or when it is left unattended and unused for long periods of time, unplug it from the wall outlet and disconnect the antenna or cable system. This will prevent damage to the product due to lightning and power-line surges.

POWER LINES — An outside antenna system should not be located in the vicinity of overhead power lines or other electric light or power circuits, or where it can fall into such power lines or circuits. When installing an outside antenna system, extreme care should be taken to keep from touching such power lines or circuits as contact with them might be fatal.

OVERLOADING — Do not overload wall outlets, extension cords, or integral convenience receptacles as this can result in a risk of fire or electric shock.

OBJECT AND LIQUID ENTRY — Never push objects of any kind into this product through openings as they may touch dangerous voltage points or short-out parts that could result in a fire or electric shock. Never spill liquid of any kind on the product.

SERVICING — Do not attempt to service this product yourself as opening or removing covers may expose you to dangerous voltage or other hazards. Refer all servicing to qualified service personnel.

DAMAGE REQUIRING SERVICE — Unplug this product from the wall outlet and refer servicing to qualified service personnel under the following conditions:

- When the power-supply cord or plug is damaged.
- If liquid has been spilled, or objects have fallen into the product.
- If the product has been exposed to rain or water.
- If the product does not operate normally by following the operating instructions. Adjust only those controls that are covered by the operating instructions as an improper adjustment of other controls may result in damage and will often require extensive work by a qualified technician to restore the product to its normal operation.
- If the product has been dropped or damaged in any way.
- When the product exhibits a distinct change in performance — this indicates a need for service.

REPLACEMENT PARTS — When replacement parts are required, be sure the service technician has used replacement parts specified by the manufacturer or have the same characteristics as the original part. Unauthorized substitutions may result in fire, electric shock, or other hazards.

SAFETY CHECK — Upon completion of any service or repairs to this product, ask the service technician to perform safety checks to determine that the product is in proper operating condition.

WALL OR CEILING MOUNTING — The product should not be mounted to a wall or ceiling.

HEAT — The product should be situated away from heat sources such as radiators, heat registers, stoves, or other products (including amplifiers) that produce heat.

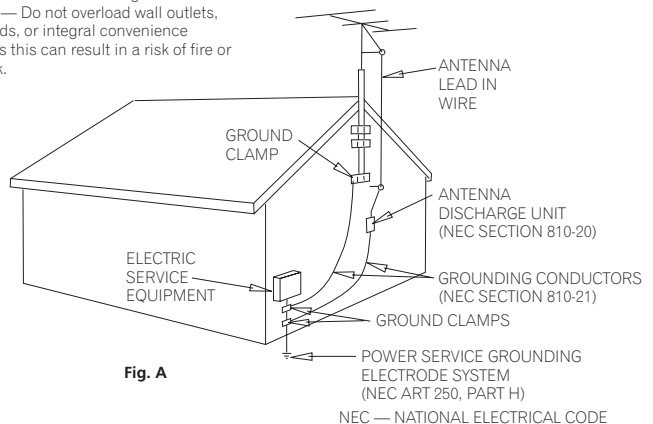

Fig. A

NEC — NATIONAL ELECTRICAL CODE

DANGER

VISIBLE AND INVISIBLE LASER RADIATION WHEN OPEN. AVOID DIRECT EXPOSURE TO BEAM.

This product incorporates copyright protection technology that is protected by method claims of certain U.S. patents and other intellectual property rights owned by Macrovision Corporation and other rights owners. Use of this copyright protection technology must be authorized by Macrovision Corporation, and is intended for home and other limited viewing uses only unless otherwise authorized by Macrovision Corporation. Reverse engineering or disassembly is prohibited.

CAUTION – PREVENT ELECTRIC SHOCK DO NOT USE THIS (POLARIZED) PLUG WITH AN EXTENSION CORD, RECEPTACLE OR OTHER OUTLET UNLESS THE BLADES CAN BE FULLY INSERTED TO PREVENT BLADE EXPOSURE.

ATTENTION – POUR PREVENIR LES CHOCS ELECTRIQUES NE PAS UTILISER CETTE FICHE POLARISEE AVEC UN PROLONGATEUR UNE PRISE DE COURANT OU UNE AUTRE SORTIE DE COURANT. SAUF SI LES LAMES PEUVENT ETRE INSEREES A FOND SANS EN LAISSER AUCUNE PARTIE A DECOUVERT.

D2-4-4-1_EF

NOTE TO CATV SYSTEM INSTALLER

THIS REMINDER IS PROVIDED TO CALL THE CATV SYSTEM INSTALLER'S ATTENTION TO ARTICLE 820-40 OF THE NEC THAT PROVIDES GUIDELINES FOR PROPER GROUNDING AND, IN PARTICULAR, SPECIFIES THAT THE CABLE GROUND SHALL BE CONNECTED TO THE GROUNDING SYSTEM OF THE BUILDING, AS CLOSE TO THE POINT OF CABLE ENTRY AS PRACTICAL.

D1-4-2-8_En

Recording equipment and copyright: You may use this product only to reproduce or copy materials for which you own the copyright or have obtained permission to copy from the copyright owner or for which you otherwise have a legal right to reproduce or copy. Unless you own the copyright or have obtained permission from the copyright owner or otherwise have a legal right to reproduce or copy, you may be violating the law, including copyright law, and may be subject to payment of damages and other remedies.

K018US_En

POWER-CORD CAUTION

Handle the power cord by the plug. Do not pull out the plug by tugging the cord and never touch the power cord when your hands are wet as this could cause a short circuit or electric shock. Do not place the unit, a piece of furniture, etc., on the power cord, or pinch the cord. Never make a knot in the cord or tie it with other cords. The power cords should be routed such that they are not likely to be stepped on. A damaged power cord can cause a fire or give you an electrical shock. Check the power cord once in a while. When you find it damaged, ask your nearest PIONEER authorized service center or your dealer for a replacement. **S002_En**

This product is for general household purposes. Any failure due to use for other than household purposes (such as long-term use for business purposes in a restaurant or use in a car or ship) and which requires repair will be charged for even during the warranty period. **K041_En**

This product includes FontAvenue® fonts licenced by NEC corporation. FontAvenue is a registered trademark of NEC Corporation.

WARNING: Handling the cord on this product or cords associated with accessories sold with the product will expose you to lead, a chemical known to the State of California and other governmental entities to cause cancer and birth defects or other reproductive harm.

Wash hands after handling

D36-P4_En

This product contains mercury. Disposal of this material may be regulated due to environmental considerations. For disposal or recycling information, please contact your local authorities or the Electronics Industries Alliance : www.eiae.org. **K057_En**



Dear Customer:

Selecting fine audio equipment such as the unit you've just purchased is only the start of your musical enjoyment. Now it's time to consider how you can maximize the fun and excitement your equipment offers. This manufacturer and the Electronic Industries Association's Consumer Electronics Group want you to get the most out of your equipment by playing it at a safe level. One that lets the sound come through loud and clear without annoying blaring or distortion-and, most importantly, without affecting your sensitive hearing.

Sound can be deceiving. Over time your hearing "comfort level" adapts to higher volumes of sound. So what sounds "normal" can actually be loud and harmful to your hearing. Guard against this by setting your equipment at a safe level BEFORE your hearing adapts.

To establish a safe level:

- Start your volume control at a low setting.
- Slowly increase the sound until you can hear it comfortably and clearly, and without distortion.

Once you have established a comfortable sound level:

- Set the dial and leave it there.

Taking a minute to do this now will help to prevent hearing damage or loss in the future. After all, we want you listening for a lifetime.

We Want You Listening For A Lifetime

Used wisely, your new sound equipment will provide a lifetime of fun and enjoyment. Since hearing damage from loud noise is often undetectable until it is too late, this manufacturer and the Electronic Industries Association's Consumer Electronics Group recommend you avoid prolonged exposure to excessive noise. This list of sound levels is included for your protection.

Decibel Level Example

30	Quiet library, soft whispers
40	Living room, refrigerator, bedroom away from traffic
50	Light traffic, normal conversation, quiet office
60	Air conditioner at 20 feet, sewing machine
70	Vacuum cleaner, hair dryer, noisy restaurant
80	Average city traffic, garbage disposals, alarm clock at two feet.

THE FOLLOWING NOISES CAN BE DANGEROUS UNDER CONSTANT EXPOSURE

90	Subway, motorcycle, truck traffic, lawn mower
100	Garbage truck, chain saw, pneumatic drill
120	Rock band concert in front of speakers, thunderclap
140	Gunshot blast, jet plane
180	Rocket launching pad

Information courtesy of the Deafness Research Foundation.



Contents

01 Before you start

Features	8
What's in the box	10
Putting the batteries in the remote control	10
Using the remote control	10
Disc / content format playback compatibility	11

02 Connecting up

Rear panel connections	13
Front panel connections	13
Easy connections	14
Using other types of video output	15
Connecting to a cable box or satellite receiver (1)	16
Connecting to a cable box or satellite receiver (2)	17
Connecting to an AV amplifier	18
Connecting other AV sources	19
Plugging in	19

03 Controls and displays

Front panel	20
Display	21
Remote control	22

04 Getting started

Switching on and setting up	24
Making your first recording	27
Using the built-in TV tuner	27
Basic playback	28
Using the Home Menu	30
Displaying disc information on-screen	31

05 Playback

Introduction	33
Using the Disc Navigator to browse the contents of a disc	33
Navigating discs	35
Scanning discs	35
Playing in slow motion	36
Frame advance/frame reverse	36
The Play Mode menu	37
Displaying and switching subtitles	40
Switching DVD soundtracks	40
Switching audio channels	41
Switching camera angles	41

06 Recording

About DVD recording	42
Recording time and picture quality	42
Restrictions on video recording	43
Setting the picture quality/recording time	43
Basic recording from the TV	44
Setting a timer recording	44
Timer recording FAQ	50
Simultaneous recording and playback	50
Recording from an external component	51
Automatic recording from a satellite tuner	51
Recording from a DV camcorder (DVR-320 only)	52
Recording from the DV output (DVR-320 only)	53
Playing your recordings on other DVD players	54
Initializing a DVD-RW disc	55

07 Editing

The Disc Navigator screen	56
Disc Navigator menu options	57
Editing VR mode Original and Video mode content	58
Creating and editing a VR mode Play List	62

08 Disc History

Using the Disc History	67
------------------------	----

09 The PhotoViewer

Playing a slideshow	68
---------------------	----

10 The Disc Setup menu

Basic settings	70
Initialize settings	71
Finalize settings	71

11 The Video/Audio Adjust menu

Setting the picture quality for TV and external inputs	72
Setting the picture quality for disc playback	73
Audio DRC	74



12 The Initial Setup menu

Using the Initial Setup menu	75
Basic settings	75
Tuner settings	76
Video Out settings	77
Audio In settings	78
Audio Out settings	79
Language settings	80
Recording settings	82
Playback settings	83

13 Additional information

Resetting the recorder	86
Setting up the remote to control your TV	86
Screen sizes and disc formats	87
Troubleshooting	88
Frequently asked questions	90
About DV (DVR-320 only)	91
Manual recording modes	92
Information for cable/satellite/STB (set-top box) users	92
Language code list	93
Country code list	93
On-screen displays and recorder displays	94
Handling discs	95
Storing discs	95
Damaged discs	95
Cleaning the pickup lens	95
Condensation	95
Hints on installation	96
Moving the recorder	96
Glossary	97
Specifications	99

Chapter 1

Before you start

Features

- **Chase play** **VR mode**

Using chase play you can start watching a recording before the recording has finished. For example, you could set a timer recording for a program that you're going to miss the first 15 minutes of, then start watching while the recorder is still recording the program 15 minutes ahead of you.

- **Simultaneous recording and playback** **VR mode**

This feature allows you to record a broadcast program while watching something else already recorded on the same disc.

- **Disc Navigator**

The on-screen Disc Navigator makes finding your way around the contents of a disc easy. For recordable DVD content, moving thumbnail images are displayed for ease of use. The Disc Navigator is also where you can edit recordable DVD content.

- **Disc History**

The Disc History screen shows disc information, including how much free space remains for recording, for the last 30 recordable discs loaded in the recorder. Every time you load a recordable disc, the Disc History is automatically updated with the latest information.

- **Home Menu**

The Home Menu gives you on-screen access to all the recorder's features in one convenient place, from setting up the recorder, to programming a timer recording and editing a recording.

- **Progressive scan-compatible**

Compared to standard interlaced video, progressive scan effectively doubles the amount of video information fed to your TV or monitor. The result is a stable, flicker-free image. (Check your TV/monitor for compatibility with this feature.)

- **Cinema surround sound in your home**

Connect this recorder to a Dolby Digital and/or DTS-compatible amplifier/receiver to enjoy full surround sound effects from Dolby Digital and DTS DVD discs.

- **Easy Timer Recording**

Setting the recorder to record a program is simple from the Easy Timer Recording screen. Set the channel to record and the recording quality, then graphically set the start and end times of the recording. That's it!

- **Program up to 32 timer recordings**

You can program the recorder to record up to 32 programs, up to a month in advance, using the VCR Plus+® system*1 for easy programming if you want. As well as single programs, you can specify daily or weekly recordings, too.

**1 VCR Plus+ and PlusCode are registered trademarks of Gemstar Development Corporation.*

The VCR Plus+ system is manufactured under licence from Gemstar Development Corporation.

- **One-touch recording**

Use one-touch recording to start recording immediately in 30 minute blocks. Each time you press the ● **REC** button, the recording time is extended by another 30 minutes.

- **Optimized recording**

Optimized recording adjusts the recording quality automatically if a timer recording will not fit onto a disc with the settings that you made.

- **Auto Start Recording from satellite receiver or other set top box**

With a satellite receiver or other set top box connected to the **INPUT 1/AUTO START REC** inputs of this recorder, you can start and stop recording automatically according to the timer settings of the set top box.

- **High quality 16-bit Linear PCM audio**

When recording using one of the high quality record settings (**FINE** or **MN32**), the audio is recorded in uncompressed 16-bit Linear PCM format. This delivers great sounding audio to accompany the high picture quality. See *Setting the picture quality/recording time* on page 43 for more on recording modes.

- **Picture quality adjustment features**

During playback, you can adjust various picture quality settings to improve the picture. You can also adjust the recording picture quality. For example, if you want to make a DVD copy of an old video tape, you can optimize the picture quality before transferring it to disc.

- **Find what you want to watch quickly and easily**

Unlike video tape that needs to be wound to the correct place, you can jump right to the part of a DVD disc that you want to watch. Search for a point on a disc by title, chapter or time.

- **Manual recording**

In addition to the four preset recording quality modes (**FINE**, **SP**, **LP** and **EP**), the manual recording mode allows you to access 32 different recording quality/time settings, giving you very fine control over the recording.

- **Record to and from a DV camcorder (DVR-320 only)**

This recorder has a built-in DV (Digital Video) input/output jack for connection to a DV camcorder. This makes it ideal for transferring camcorder footage to DVD for editing. You can also transfer DVD content back to the camcorder if you need to.

- **Safe, non-destructive editing** **VR mode**

When you edit a DVD-RW, the actual content of the disc (the Original content) is not touched. The edited version (the Play List content) just points to various parts of the Original content.

- **Chapter marking** **VR mode**

You can easily add chapter markers anywhere in your recordings for easy editing.

- **Play Video mode recordings on a regular DVD player** **Video mode**

Discs recorded using the Video mode can be played back on regular DVD players, including computer DVD drives compatible with DVD-Video playback*².

**² 'DVD-Video format' recording: The use of the DVD-Video format for recording on DVD-R and DVD-RW discs is referred to as recording in 'Video mode' on Pioneer's DVD recorders. Supporting playback of DVD-R / DVD-RW discs is optional for manufacturers of DVD playback equipment, and there is DVD playback equipment that does not play DVD-R or DVD-RW discs recorded in the DVD-Video format.*

Note: 'Finalization' is required.

- **WMA, MP3 and JPEG file playback**

This recorder can play WMA and MP3 audio files and JPEG picture files on CD-R, CD-RW or CD-ROM discs (see *Disc / content format playback compatibility* on page 11).

What's in the box

Please confirm that the following accessories are in the box when you open it.

- Remote control
- AA/R6P dry cell batteries x2
- Audio/video cable (red/white/yellow)
- RF antenna cable
- Power cable
- These operating instructions
- Warranty card

Putting the batteries in the remote control

1 Open the battery compartment cover on the back of the remote control.

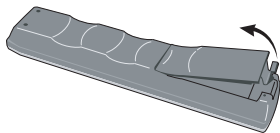

2 Insert two AA/R6P batteries into the battery compartment following the indications (+, -) inside the compartment.

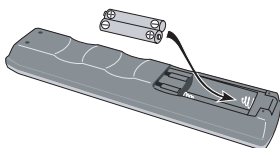

3 Close the cover.

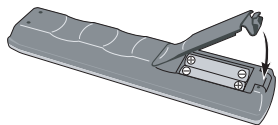

Note

Incorrect use of batteries can result in hazards such as leakage and bursting. Please observe the following:

- Don't mix new and old batteries together.
- Don't use different kinds of battery together—although they may look similar, different batteries may have different voltages.
- Make sure that the plus and minus ends of each battery match the indications in the battery compartment.
- Remove batteries from equipment that isn't going to be used for a month or more.
- When disposing of used batteries, please comply with governmental regulations or environmental public instruction's rules that apply in your country or area.

Using the remote control

Keep in mind the following when using the remote control:

- Make sure that there are no obstacles between the remote and the remote sensor on the unit.
- Remote operation may become unreliable if strong sunlight or fluorescent light is shining on the unit's remote sensor.
- Remote controllers for different devices can interfere with each other. Avoid using remotes for other equipment located close to this unit.
- Replace the batteries when you notice a fall off in the operating range of the remote.
- When the batteries run down or you change the batteries, the remote control mode and TV preset codes are automatically reset. See *Remote Control Set* on page 76 and *Setting up the remote to control your TV* on page 86 to reset them.
- Use within the operating range and angle, as shown.

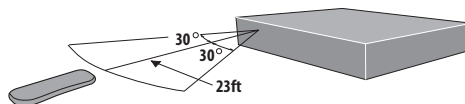

- You can control this recorder using the remote sensor of another Pioneer component using the **CONTROL IN** jack on the rear panel. See *Rear panel connections* on page 13 for more information.

Disc / content format playback compatibility

General disc compatibility

This recorder is compatible with a wide range of disc types (media) and formats. Playable discs will generally feature one of the following logos on the disc and/or disc packaging. Note however that some disc types, such as recordable CD and DVD, may be in an unplayable format—see below for further compatibility information.



- Also compatible with KODAK Picture CD
-  is a trademark of Fuji Photo Film Co. Ltd.

DVD-R/RW compatibility

This recorder will play and record DVD-R/RW discs.

Compatible media:

- DVD-RW Ver. 1.1, Ver. 1.1 / 2x and Ver. 1.2
- DVD-R Ver. 2.0 and Ver. 2.0 / 4x / 8x

Recording formats:

- DVD-R: DVD-Video format (Video mode)
- DVD-RW: Video Recording (VR) format and DVD-Video format (Video mode)

CD-R/RW compatibility

This recorder cannot record CD-R or CD-RW discs.

- Compatible formats: CD-Audio, Video CD, ISO 9660 CD-ROM* containing MP3, WMA or JPEG files
* ISO 9660 Level 1 or 2 compliant. CD physical format: Mode1, Mode2 XA Form1. Romeo and Joliet file systems are both compatible with this recorder.
- Multi-session playback: Yes (except CD-Audio and Video CD)
- Unfinalized disc playback: CD-Audio only

Compressed audio compatibility

- Compatible media: CD-ROM, CD-R, CD-RW
- Compatible formats: MPEG-1 Audio Layer 3 (MP3), Windows Media Audio (WMA)
- Sampling rates: 44.1 or 48kHz
- Bit-rates: Any (128Kbps or higher recommended)
- VBR (variable bit rate) MP3 playback: Yes
- VBR WMA playback: No
- WMA encoder compatibility: Windows Media Codec 8 (*files encoded using Windows Media Codec 9 may be playable but some parts of the specification are not supported; specifically, Pro, Lossless, Voice and VBR*)
- DRM (Digital Rights Management) file playback: No (see also DRM in the *Glossary* on page 97)
- File extensions: .mp3, .wma (these must be used for the recorder to recognize MP3 and WMA files – do not use for other file types)
- File structure: Up to 99 folders / 999 files (if these limits are exceeded, only files and folders up to these limits are playable)

WMA (Windows Media Audio) compatibility



The Windows Media® logo printed on the box indicates that this recorder can playback Windows Media Audio content.

WMA is an acronym for Windows Media Audio and refers to an audio compression technology developed by Microsoft Corporation. WMA content can be encoded by using Windows Media® Player version 7, 7.1, Windows Media® Player for Windows® XP, or Windows Media® Player 9 Series.

Microsoft, Windows Media, and the Windows logo are trademarks, or registered trademarks of Microsoft Corporation in the United States and/or other countries.

JPEG file compatibility

- Compatible formats: Baseline JPEG and EXIF 2.2* still image files
*File format used by digital still cameras
- Sampling ratio: 4:4:4, 4:4:2, 4:2:0
- Horizontal resolution: 160 – 5120 pixels
- Vertical resolution: 120 – 3840 pixels
- Progressive JPEG compatible: No

- File extensions: .jpg, jpeg, .jif, jfif (must be used for the recorder to recognize JPEG files – do not use for other file types)
- File structure: The recorder can load up to 99 folders / 999 files at one time (if there are more files/folders that this on the disc then more can be reloaded)

PC-created disc compatibility

Discs recorded using a personal computer may not be playable in this unit due to the setting of the application software used to create the disc. In these particular instances, check with the software publisher for more detailed information.

Discs recorded in packet write mode (UDF format) are not compatible with this recorder.

Check the DVD-R/RW or CD-R/RW software disc boxes for additional compatibility information.



Frequently asked questions

- *What's the difference between DVD-R and DVD-RW?*
The most important difference between DVD-R and DVD-RW is that DVD-R is a record-once medium, while DVD-RW is a re-recordable/erasable medium. You can re-record/erase a DVD-RW disc approximately 1,000 times.
For more information, see *About DVD recording* on page 42.
- *What's VR mode?*
VR (Video Recording) mode is a special mode designed for home DVD recording. It allows very flexible editing of recorded material compared to 'Video mode'. On the other hand, Video mode discs are more compatible with other DVD players.
- *Can I play my recordable discs in a regular DVD player?*
Generally, DVD-R discs and DVD-RW discs recorded in Video mode^{*2} are playable in a regular DVD player, but they must be 'finalized' first. This process fixes the contents of the disc to make them readable to other DVD players as DVD-Video discs.
DVD-RW discs recorded in VR mode are playable in some players.



This indicates a product feature that is capable of playing DVD-RW discs recorded using VR mode.

Note that Pioneer cannot guarantee that discs recorded using this recorder will play on other players.

^{*2} 'DVD-Video format' recording: The use of the DVD-Video format for recording on DVD-R and DVD-RW discs is referred to as recording in 'Video mode' on Pioneer's DVD recorders. Supporting playback of DVD-R / DVD-RW discs is optional for manufacturers of DVD

playback equipment, and there is DVD playback equipment that does not play DVD-R or DVD-RW discs recorded in the DVD-Video format.

Note: 'Finalization' is required.

This recorder supports the recording of 'copy-once' broadcast programs using the CPRM copy protection system (see CPRM on page 43) on CPRM-compliant DVD-RW discs in VR mode. CPRM recordings can only be played on players that are specifically compatible with CPRM.

- *Do I need two DVD recorders for editing? What kind of editing can I do?*

Unlike editing video tape, you only need one DVD recorder to edit discs. With DVD, you edit by making a 'Play List' of what to play and when to play it. On playback, the recorder plays the disc according to the Play List.

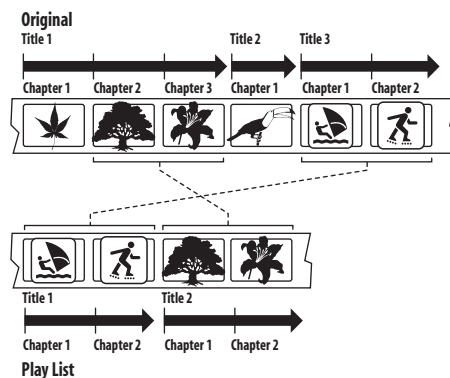

Throughout this manual, you will often see the words Original and Play List to refer to the actual content and the edited version.

- **Original** content refers to what's actually recorded on the disc.
- **Play List** content refers to the edited version of the disc—how the Original content is to be played.

Chapter 2

Connecting up

Rear panel connections

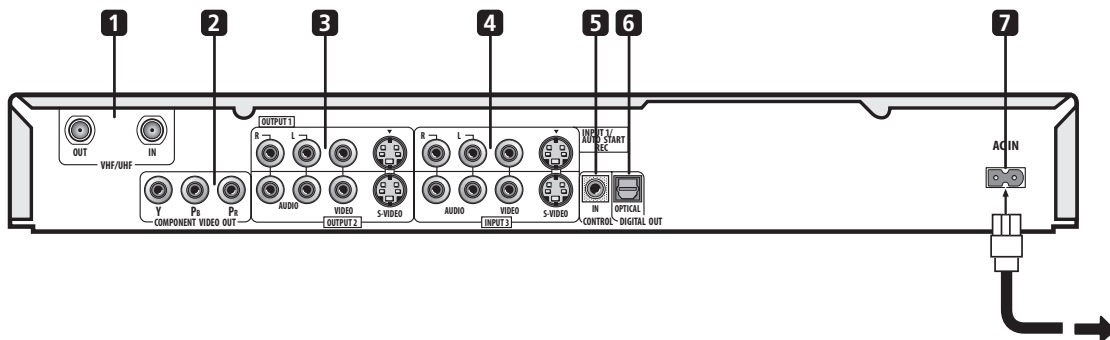

1 VHF/UHF IN/OUT

Connect your TV antenna to the **VHF/UHF IN** jack. The signal is passed through to the **VHF/UHF OUT** jack for connection to your TV.

2 COMPONENT VIDEO OUT

A high-quality video output for connecting to a TV or monitor with a component video input.

3 Audio/video outputs 1 and 2

Two sets of audio/video outputs (stereo analog audio; composite and S-video video) that you can use to connect TVs or monitors.

4 Audio/video inputs 1 and 3

Two sets of audio/video inputs (stereo analog audio; composite and S-video video) that you can use to connect to satellite receivers, TVs, VCR or other source component for recording.

5 CONTROL IN

Use to control this recorder from the remote sensor of another Pioneer component with a **CONTROL OUT** terminal and bearing the Pioneer  mark. Connect the **CONTROL OUT** of the other component to the **CONTROL IN** of this recorder using a mini-plug cord.

6 OPTICAL DIGITAL OUT

A digital audio output for connecting to an AV receiver, Dolby Digital/DTS decoder or other equipment with optical digital input.

7 AC IN

Connect to a power outlet using the supplied power cable after making all other connections.

Front panel connections

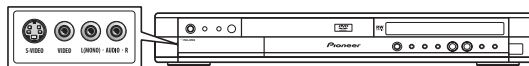

On the left side of the front panel a flip-down cover hides a third audio/video input, consisting of an S-video and standard (composite) video jack, and stereo analog audio jacks.

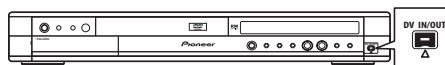

DVR-320 only: On the right side is the DV input/output i.LINK connector. This is for connection to a DV camcorder.

Easy connections

The setup described here is a basic configuration that allows you to record TV programs on both this recorder and your VCR. When watching recordings from this recorder, set your TV to input 1; switch to input 2 to watch a video playing in the VCR.

Important

- This recorder is equipped with copy protection technology. Do not connect this recorder to your TV via a VCR (or your VCR via this recorder) using AV cables, as the picture from this recorder will not appear properly on your TV.
- Before making or changing any rear panel connections, make sure that all components are switched off and unplugged from the wall outlet.

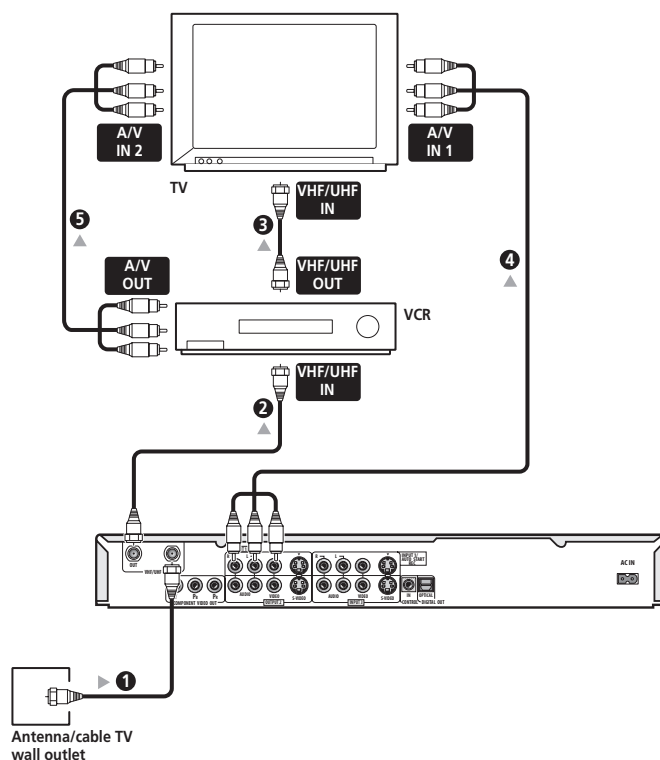

1 Connect your TV antenna/cable TV outlet to the VHF/UHF IN jack on this recorder.

2 Use an RF antenna cable (one is supplied) to connect the VHF/UHF OUT jack on this recorder to the antenna input on your VCR.

- If you are not connecting a VCR in the chain, connect this recorder directly to your TV and skip the next step.

3 Use an RF antenna cable to connect the antenna output on your VCR to the antenna input on your TV.

4 Connect the AUDIO and VIDEO OUTPUT jacks (1 or 2) to a set of audio/video inputs on your TV.

Use the supplied three-pin audio/video cable. It is color-coded to help you match them up (red/white for the right/left audio connections and yellow for video in/out). Make sure you match up the left and right outputs with their corresponding inputs for correct stereo sound.

5 Connect your VCR to your TV (A/V IN 2 above) using a set of audio and video cables.

Note

- See the following page if you want to use S-video or component video cables for the video connection.

Using other types of video output

This recorder has standard (composite), S-video and component video outputs. The main difference between them is the quality of the picture. S-video delivers a better picture than composite video, while component video gives better picture quality still. The variety of outputs also gives you the flexibility of connecting your particular equipment using the best connection type available.

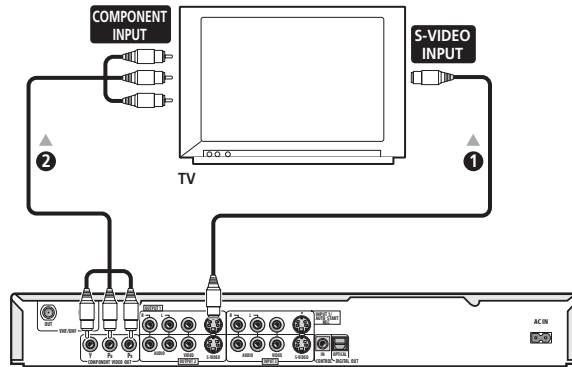

1 Connecting using an S-video output

S-video carries the picture as separate color and luminance (brightness) signals.

There are two S-video outputs for connection to TVs, monitors, VCRs or other equipment.

- Use an S-video cable (not supplied) to connect an S-VIDEO OUTPUT (1 or 2) to an S-VIDEO INPUT on your TV, monitor (or other equipment).

2 Connecting using the component video output

Component video carries the picture as two separate color signals, plus a luminance (brightness) signal.

See also *Component Video Out* on page 77 for how to set up the component video output for use with a progressive scan-compatible TV.

- Use a component video cable (not supplied) to connect the COMPONENT VIDEO OUT jacks to a component video input on your TV, monitor (or other equipment).

Connecting to a cable box or satellite receiver (1)

If you are using a cable box or satellite receiver with only a few scrambled channels, follow the setup on this page. If many or all the channels are scrambled, we recommend using the setup on the following page.

Using the setup on this page you can:

- Record unscrambled channels by selecting them on this recorder.
- Record scrambled channels by selecting them on the cable box/satellite tuner and using the Auto Start Recording feature (see *Automatic recording from a satellite tuner* on page 51).
- Watch one channel while recording another.

Important

- Do not connect this recorder 'through' your VCR, satellite receiver or cable box. Always connect each component directly to your TV or AV receiver.

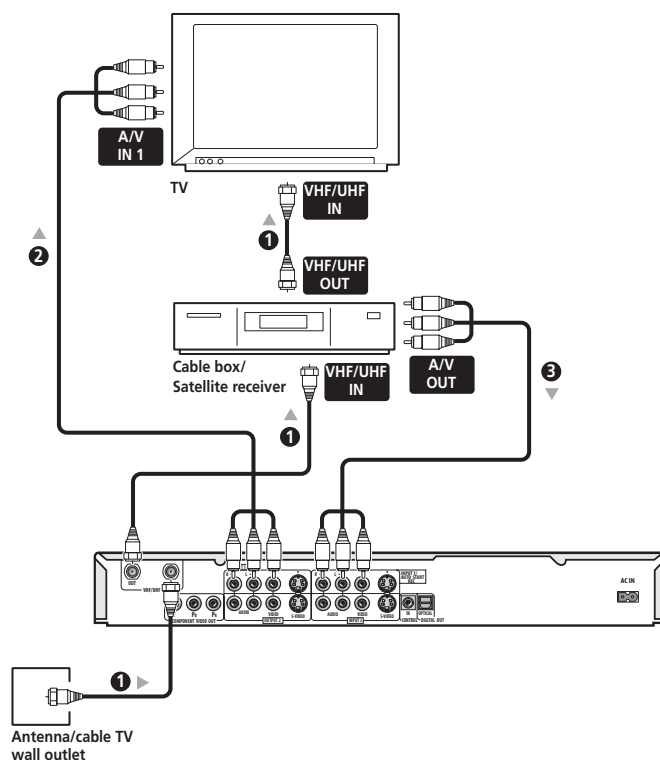

1 Connect RF antenna cables as shown.

This enables you to watch and record TV channels.

2 Connect the AUDIO and VIDEO OUTPUT jacks (1 or 2) on this recorder to a set of audio/video inputs on your TV using a set of A/V cables (as supplied).

This enables you to watch the output from this recorder.

3 Connect the audio/video output of your cable box/satellite tuner to the INPUT 1/AUTO START REC jacks on this recorder using a set of A/V cables.

This enables you to record scrambled TV channels.

Note

The diagram shows standard video connections, but you can alternatively use the S-video or component video connections if they're available.

Connecting to a cable box or satellite receiver (2)

If many or all the channels you receive by cable or satellite are scrambled, we recommend using this setup.

Using the setup on this page you can:

- Record any channel by selecting it on the cable box/satellite tuner.
- Record using the Auto Start Recording feature (see *Automatic recording from a satellite tuner* on page 51).

Important

- Do not connect this recorder 'through' your VCR, satellite receiver or cable box. Always connect each component directly to your TV or AV receiver.

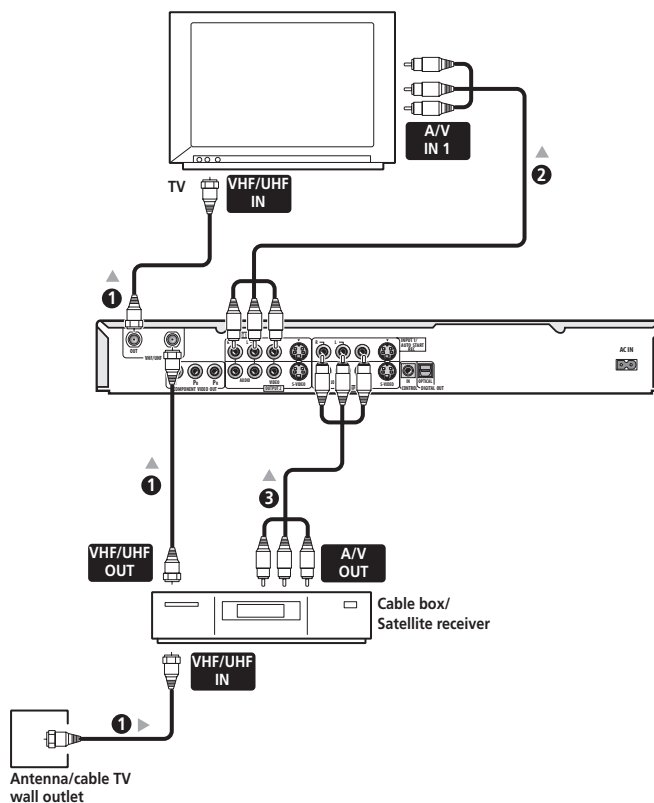

1 Connect RF antenna cables as shown.

This enables you to watch and record TV channels.

2 Connect the AUDIO and VIDEO OUTPUT jacks (1 or 2) on this recorder to a set of audio/video inputs on your TV using a set of A/V cables (as supplied).

This enables you to watch discs.

3 Connect the audio/video output of your cable box/satellite tuner to the INPUT 1/AUTO START REC jacks on this recorder using a set of A/V cables.

This enables you to record scrambled TV channels.

Note

- The setup on this page does not allow you to watch one channel and record another.
- The diagram shows standard video connections, but you can alternatively use the S-video or component video connections if they're available.

Connecting to an AV amplifier

To enjoy multichannel surround sound you need to connect this recorder to an AV amplifier/receiver using the digital optical output. In addition to the digital connection, we recommend also connecting using the stereo analog connection.

You'll probably also want to connect a video output to your AV amplifier/receiver. Use the standard (composite) video output (as shown here), or the S-video or component video connections.

See also *Audio Out settings* on page 79 for how to set up the digital audio output. (Noise may be output from your speakers if the recorder is not set up to work with your AV amplifier/receiver.)

Important

- Do not connect this recorder to your TV 'through' your VCR or other component using A/V cables. Always connect it directly to your TV.

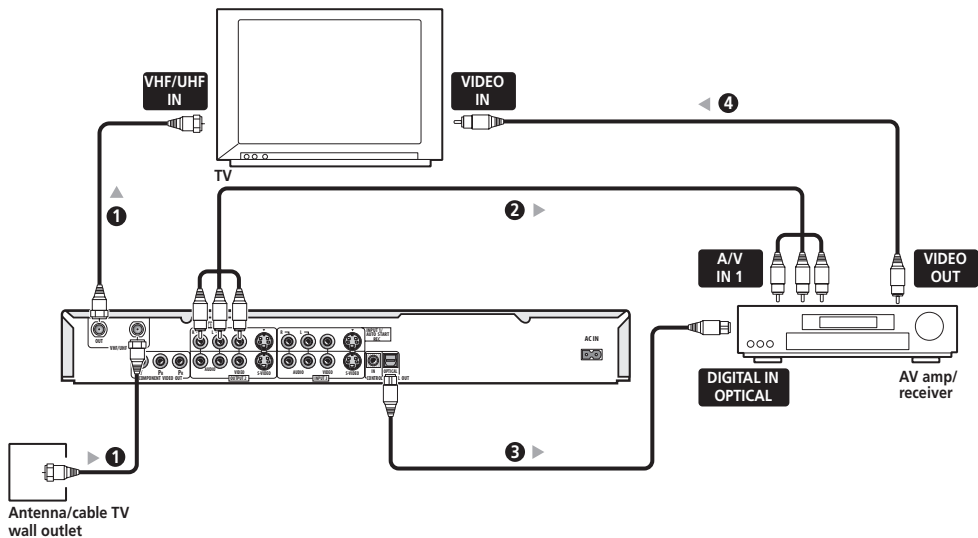

1 Connect RF antenna cables as shown.

This enables you to watch and record TV channels.

2 Connect the AUDIO and VIDEO OUTPUT jacks (1 or 2) on this recorder to a set of audio/video inputs on your AV receiver.

3 Use an optical digital audio cable (not supplied) to connect the OPTICAL DIGITAL OUT jack on this recorder to an optical digital input on your AV receiver.

This enables you to listen to multichannel surround sound.

4 Connect the AV receiver's video output to a video input on your TV.

Note

- The diagram shows standard video connections, but you can alternatively use the S-video or component video connections if they're available.
- If your AV receiver doesn't have an optical digital input, but has a coaxial type, converter boxes that convert from optical to coaxial are available at specialist audio dealers.

Connecting other AV sources

Connecting a VCR or analog camcorder

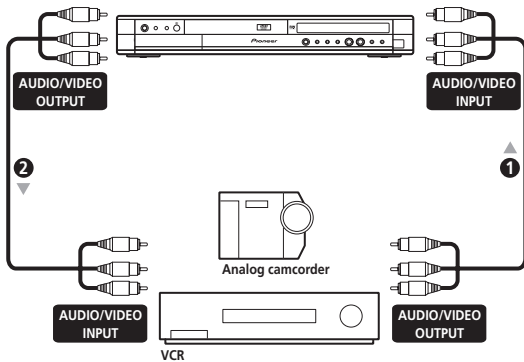

1 Connect a set of audio and video outputs of your VCR or camcorder to a set of inputs on this recorder.

This enables you to record tapes from your VCR or camcorder.

- You can use standard video or S-video cables for the video connection.
- The front panel connections make convenient connections for a camcorder input.

2 Connect a set of audio and video inputs of your VCR or camcorder to a set of outputs on this recorder.

This enables you to record from this recorder to your VCR or camcorder.

- You can use standard video or S-video cables for the video connection.

Connecting a DV camcorder (DVR-320 only)

Using the front panel **DV IN/OUT** jack, it is possible to connect a DV camcorder or video deck, or DVD-R/RW recorder and digitally transfer DV tapes or DVD-R/RW discs to DVD-R/RW.

Important

- This jack is for connection to DV equipment only. It is not compatible with digital satellite tuners or D-VHS video decks.

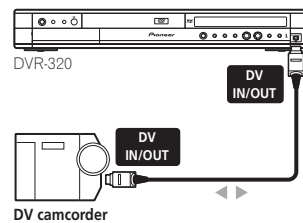

- 1 Use a DV cable (not supplied) to connect the DV in/out jack of your DV camcorder/video deck to the front panel DV IN/OUT jack of this recorder.**

Plugging in

After checking all the connections, plug in the recorder.

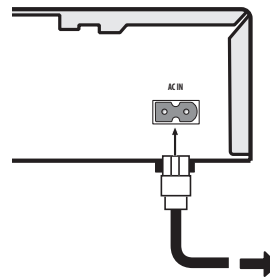

- 1 Use the supplied power cable to connect this recorder to a power outlet.**

Chapter 3

Controls and displays

Front panel

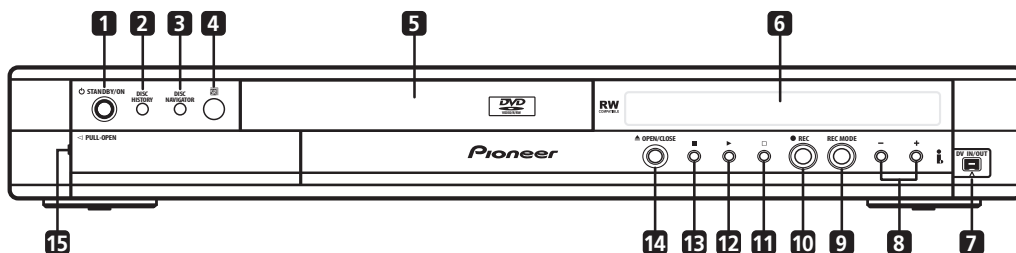
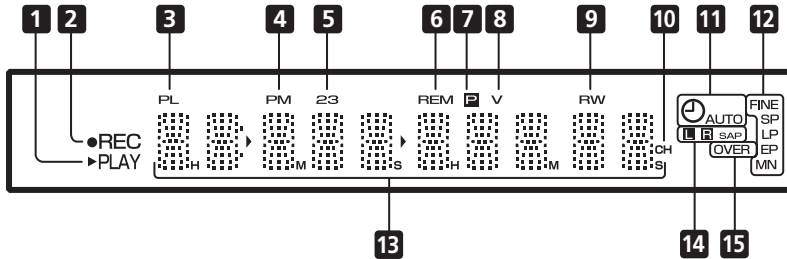

Illustration shows DVR-320

- 1** **STANDBY/ON**
Press to switch the recorder on/into standby.
- 2** **DISC HISTORY** (page 67)
Press to display the Disc History screen.
- 3** **DISC NAVIGATOR** (page 33, 56)
Press to directly access the Disc Navigator screen.
- 4** **IR remote sensor** (page 10)
- 5** **Disc tray**
- 6** **Front panel display**
See *Display* on page 21 for details.
- 7** **DV IN/OUT jack (DVR-320 only)** (page 13, 19, 51, 52, 53)
Digital input/output jack for use with a DV camcorder.
- 8** **+/-** (page 27, 29)
Use to change TV channels, skip chapters/tracks, etc.
- 9** **REC MODE** (page 43)
Press repeatedly to change the recording mode (picture quality).
- 10** **REC**
Press to start recording.
- 11**
Press to stop recording.
- 12**
Press to start or restart playback.
- 13**
Press to stop playback.
- 14** **OPEN/CLOSE**
Press to open/close the disc tray.
- 15** **Front panel inputs** (page 13)
Pull the cover down where indicated to access the front panel input jacks. Especially convenient for connecting camcorders and other portable equipment.

Display



1 ▶ PLAY

Lights during playback; blinks when paused.

2 ● REC

Lights during recording; blinks when recording is paused.

3 PL (page 57)

Lights when a VR mode disc is loaded and the recorder is in Play List mode.

4 PM

Lights to indicate PM (after midday) for the clock display.

5 23 (page 76)

Shows the remote control mode (if nothing is displayed, the remote control mode is 1).

6 REM

Lights when the character display is showing the remaining available recording time.

7 (page 77)

Lights when the component video output is set to progressive scan.

8 V

Lights when an unfinalized Video mode disc is loaded.

9 R / RW

Indicates the type of recordable DVD loaded: DVD-R or DVD-RW.

10 CH (page 27)

Channel indicator for the built-in TV tuner.

11 (page 44)

Lights when a timer recording has been set. (Indicator blinks if the timer has been set but there isn't a recordable disc loaded.)

AUTO (page 51)

Lights when Auto Start Recording has been set, and during Auto Start Recording.

12 Recording quality indicators (page 42)

FINE

Lights when the recording mode is set to **FINE** (best quality).

SP

Lights when the recording mode is set to **SP** (standard play).

LP

Lights when the recording mode is set to **LP** (long play).

EP

Lights when the recording mode is set to **EP** (extended play).

MN

Lights when the recording mode is set to **MN** (manual recording level) mode.

13 Character display

14 Channel recording indicators

(page 78)

Indicates which channels are recorded when Dual Mono is selected.

SAP (page 28)

Lights when the currently selected TV channel has a Second Audio Program channel.

15 OVER (page 79)

Lights when the analog audio input level is too high.

Remote control

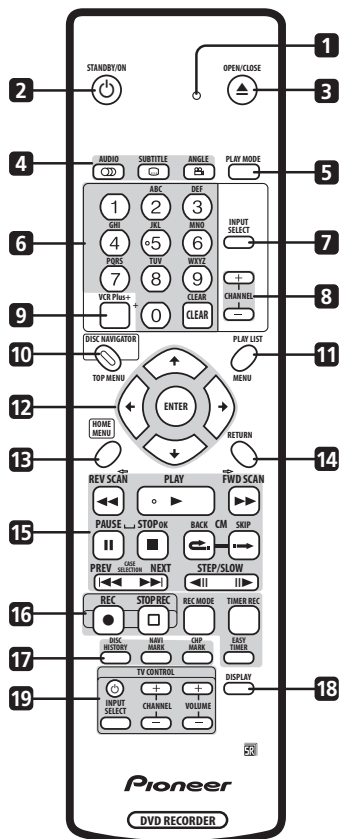

1 Remote control indicator

Lights when setting up the remote control for use with a TV (page 86) and when setting the remote control mode (page 76).

2 **STANDBY/ON**

Press to switch the recorder on/into standby.

3 **OPEN/CLOSE**

Press to open/close the disc tray.

4 DVD playback functions

AUDIO (page 28, 40)

Changes the audio language or channel. (When the recorder is stopped, press to change the tuner audio.)

SUBTITLE (page 40)

Displays/changes the subtitles included in multilingual DVD-Video discs.

ANGLE (page 41)

Switches camera angles on discs with multi-angle scenes.

5 **PLAY MODE** (page 37)

Press to display the Play Mode menu (for features such as search, repeat and program play).

6 **Alphanumeric buttons and CLEAR**

Use the number buttons for track/chapter/title selection; channel selection, and so on. The same buttons can also be used to enter names for titles, discs and so on.

Use **CLEAR** to clear an entry and start again.

7 **INPUT SELECT** (page 51)

Press to change the input to use for recording.

8 **CHANNEL +/-** (page 27)

Press to change the channel of the built-in TV tuner.

9 **VCR Plus+** (page 47)

Press, then use the number buttons to enter a PlusCode® programming number for timer recording.

10 **DISC NAVIGATOR** (page 33, 56) / **TOP MENU** (page 29)

Press to display the Disc Navigator screen, or the top menu if a DVD-Video disc is loaded.

11 **PLAY LIST** (page 57) / **MENU** (page 29)

Press to switch between Original and Play List content on VR mode discs, or display the disc menu if a DVD-Video disc is loaded.

12 **↑/↓/←/→ (cursor buttons) and ENTER**

Used to navigate all on-screen displays. Press **ENTER** to select the currently highlighted option.

13 **HOME MENU** (page 30)

Press to display the Home Menu, from which you can navigate all the functions of the recorder.

14 **RETURN**

Press to go back one level in the on-screen menu or display.

15 **Playback controls** (page 28)

◀◀ REV SCAN / FWD SCAN ▶▶ (page 35)

Press to start reverse or forward scanning. Press again to change the speed.

▶ PLAY

Press to start playback.

⏸ PAUSE

Press to pause playback or recording.

■ STOP

Press to stop playback.

CM BACK (commercial back)

Press repeatedly to skip progressively backward on the disc.

CM SKIP (commercial skip)

Press repeatedly to skip progressively forward on the disc.

◀◀ PREV / NEXT ▶▶

Press to skip to the previous or next title/chapter/track/folder; or to display the previous or next menu page.

◀|| STEP/SLOW ||▶ (page 36)

During playback, press to start slow-motion playback; while paused, press to show the previous or next video frame.

16 Recording controls (page 27)**● REC**

Press to start recording. Press repeatedly to set the recording time in blocks of 30 mins.

□ STOP REC

Press to stop recording.

REC MODE (page 43)

Press repeatedly to change the recording mode (picture quality).

TIMER REC (page 46)

Press to set a timer recording from the standard Timer Recording screen.

EASY TIMER (page 45)

Press to set a timer recording from the Easy Timer Recording screen.

17 DISC HISTORY (page 67)

Press to display summary information (disc name, recording time left, etc.) from the last 30 recordable discs loaded.

NAVI MARK (page 34)

Press to select a thumbnail picture for the current title for use in the Disc Navigator screen.

CHP MARK (page 60)

Press to insert a chapter marker when playing/recording a VR mode DVD-RW disc.

18 DISPLAY (page 31)

Displays/changes the on-screen information displays.

19 TV CONTROL (page 86)

After setting up, use these controls to control your TV.

Chapter 4

Getting started

Switching on and setting up

When you switch the recorder on for the first time, you can make several basic settings using the Setup Navigator feature. This takes you through setting the clock, the internal TV tuner and the video and audio output settings.

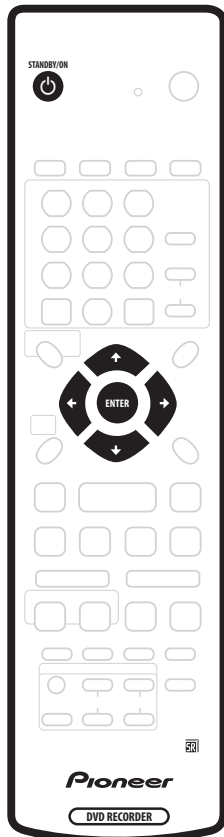

If you're using the recorder for the first time, we strongly recommend you use the Setup Navigator before starting to use the recorder.



1 Switch on your TV and set the video input to this recorder.

2 Press the  STANDBY/ON button on the remote control or the front panel to switch on.

When you switch on for the first time, your TV should display the Setup Navigator screen. (If the Setup Navigator doesn't appear, you can also access it from the Initial Setup menu; see page 76).

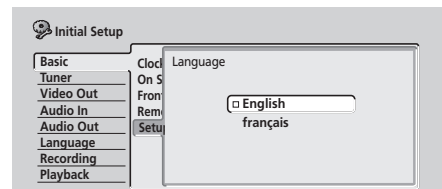

3 Use the / (cursor up/down) buttons to select English or French as the OSD, subtitle, audio, and DVD menu language, then press ENTER.

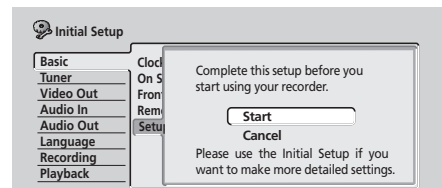

4 Press ENTER again to start setting up using the Setup Navigator.



- If you don't want to use the Setup Navigator, press  (cursor down) to select **Cancel**, then press **ENTER** to exit the Setup Navigator.

5 Use the / (cursor up/down) buttons to select 'Antenna' or 'Cable' depending on how you receive your terrestrial TV channels, then press ENTER.

You can also select **Do not set** if you don't need the recorder to retune all the channels (if you're using the Setup Navigator for a second time, for example).

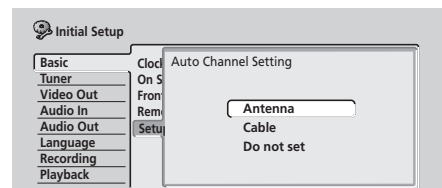

After selecting **Antenna** or **Cable** the recorder starts automatic tuning. This takes a couple of minutes to complete.

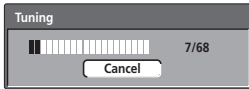

6 Select 'Auto' for automatic time setting, then press **ENTER**.

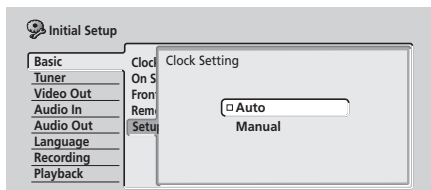

- **Auto clock setting**

Some TV channels broadcast time signals together with the program. This recorder can use these signals to set the clock automatically.

Set 'Clock Set CH' to the channel preset number that broadcasts a clock signal, then move the cursor down to 'Start' and press **ENTER**.

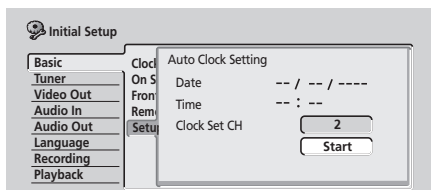

The recorder takes a short while to set the time. After you see that the time has been set, select **Next** to proceed.

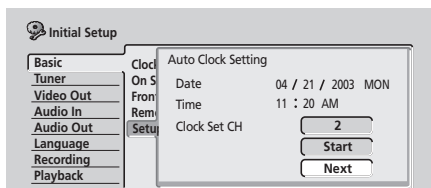

If the time could not be set automatically, press **RETURN** to go back to the previous screen and select **Manual**.

- **Manual clock setting**

If no stations in your area are broadcasting time signals, you can set the clock manually.

Use the **←/→** (cursor left/right) buttons to set your time zone.

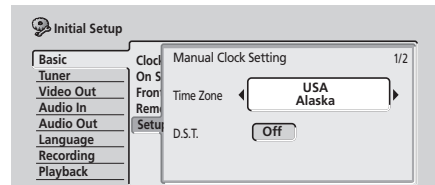

Press **↓** (cursor down) then use the **←/→** (cursor left/right) buttons to set D.S.T. to **On** or **Off**, then press **ENTER**.

Select **On** if you are currently using daylight saving time.

Set the current date and time.

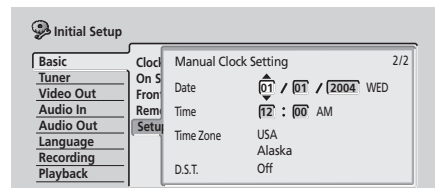

- Use the **↑/↓** (cursor up/down) buttons to change the value in the highlighted field.
- Use the **←/→** (cursor left/right) buttons to move from one field to another.
- Press **ENTER** to finish setting the time.

7 Select the kind of TV you have, 'Wide (16:9)' or 'Standard (4:3)'.

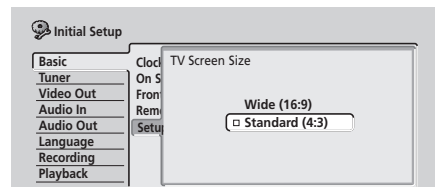

Use the **↑/↓** (cursor up/down) buttons to select, then press **ENTER**.

8 Is your TV compatible with progressive scan video?

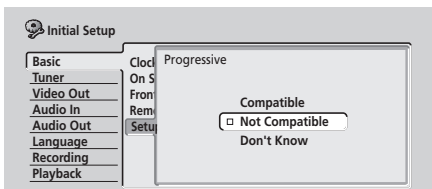

Use the **↑/↓** (cursor up/down) buttons to select **Compatible**, **Not Compatible**, or **Don't Know**, then press **ENTER**.

- Note that progressive scan video is only output through the component video outputs (see page 15).

9 Is this recorder connected to an AV receiver for digital audio?

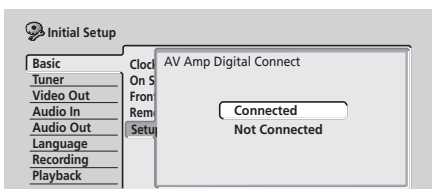

Use the **↑/↓** (cursor up/down) buttons to select **Connected**, or **Not Connected**, then press **ENTER**.

- If you select **Not Connected**, that completes the setup. Press **ENTER** to exit the Setup Navigator, or select **Go Back** if you want to go back and start again.

10 Select the digital audio formats your AV receiver is compatible with.

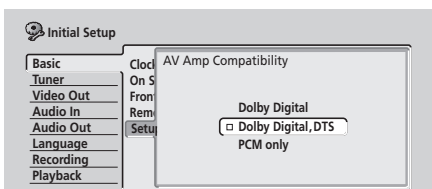

Use the **↑/↓** (cursor up/down) buttons to select **Dolby Digital**, **Dolby Digital, DTS** or **PCM only**, then press **ENTER**.

- Check the operating instructions that came with your AV receiver if you're not sure what it's compatible with.

11 Is your AV receiver compatible with 96 kHz digital audio?

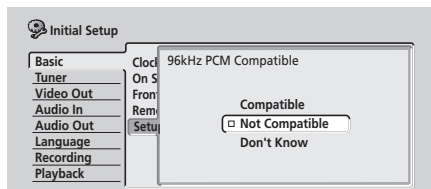

Use the **↑/↓** (cursor up/down) buttons to select **Compatible**, **Not Compatible**, or **Don't Know**, then press **ENTER**.

- Check the operating instructions that came with your AV receiver if you're not sure.

12 That's it! Press ENTER to finish setting up, or select 'Go Back' if you want to start again.

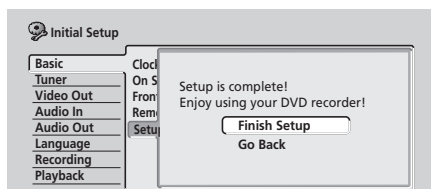

Other settings you can make

After setting up using the Setup Navigator, you should be ready to start enjoying your DVD recorder. It's possible, however, that you may want to make a couple of additional settings, depending on how the recorder is set up for terrestrial TV broadcasts.

- **Manual channel setting** – This setting lets you skip channels where there is no station, as well as manually tune to stations. See *Manual CH Setting* on page 77.
- **VCR Plus+ channel setting** – This setting lets you assign guide channels to ensure that the VCR Plus+ programming system works correctly. See *VCR Plus+ CH Setting* on page 77.

That completes basic setup using the Setup Navigator.

- **Setting up the remote to control your TV** – You can set up the supplied remote control to control many brands of TV. See *Setting up the remote to control your TV* on page 86.

Making your first recording

This quick guide shows you how to make a basic recording of a TV program to a recordable DVD.

Recording is covered in much more detail in chapter 6 (*Recording*).

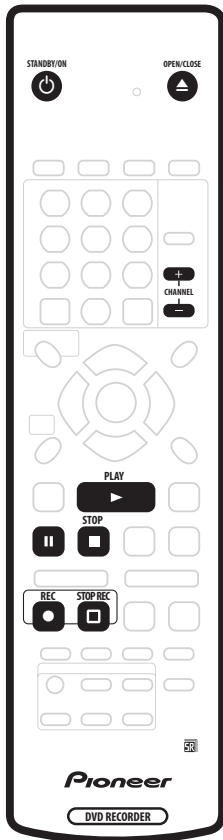

1 If they aren't already on, switch on your TV and this recorder.

Press **⏻ STANDBY/ON** to switch on.

- Make sure that the video input on your TV is set to this recorder.

2 Press **⏏ OPEN/CLOSE** to eject the disc tray.

3 Load a blank DVD-R or DVD-RW disc with the label face-up, using the disc guide to align the disc.

- When you load a new, blank DVD-RW disc, the recorder will take a moment to initialize it for recording.

4 Use the **CHANNEL +/-** buttons to select the TV channel you want to record from.

- You can also use the **+/-** buttons on the front panel if the recorder is stopped.
- Antenna channels are numbered 2 through 69. Cable channels are numbered 1 through 125.

5 Press **● REC** to start recording.

- By default, the recording will be in **SP** (standard play) mode, which will give you around 2 hours of recording from a blank DVD disc.
- You can pause recording by pressing **⏸ PAUSE**. Press **● REC** or **⏸ PAUSE** again to restart recording.

6 When you want to stop recording, press

□ STOP REC.

Playing back your recording

The TV program you just recorded should be on the DVD disc as a single title with one or more chapters.

- Press **▶ PLAY** to start playback.

If you want to stop playback before the end of the recording, press **■ STOP**.

Using the built-in TV tuner

Changing TV channels

When no disc is playing, you can change TV channels in three different ways:

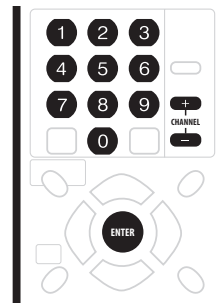

- **CHANNEL +/-** buttons on the remote
- **Number buttons** on the remote – For example, to select channel 4, press **4** then **ENTER**; for channel 34, press **3, 4, ENTER**; for channel 102, press **1, 0, 2, ENTER**.
- **+/-** buttons on the front panel

Note

- Antenna channels are numbered 2 through 69. Cable channels are numbered 1 through 125.
- You can't change TV channels during playback or recording, or while in recording standby.

Changing audio channels

Some TV programs are broadcast with both a main and a Second Audio Program (SAP). You can change the TV audio using the **AUDIO** button.

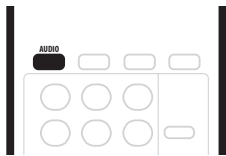

- **Press AUDIO to change the TV audio.**
The current audio channel is displayed on-screen.



- If **SAP** is selected, but there is no SAP channel being broadcast, you will still hear the main audio channel.
- If the sound is poor quality when set to **Stereo**, you can often improve it by changing to **Mono**.

Basic playback

This section shows you how to use your recorder for playback of discs (DVD, CD, etc.). More playback features, such as repeat and program play, are covered in the next chapter.

Important

- Throughout this manual, the term 'DVD' means playback-only DVD-Video discs and DVD-R/RW. If a function is specific to a particular kind of DVD disc, it is specified.
- Some DVD-Video discs don't allow certain playback controls to operate at certain points in the disc. This is not a malfunction.

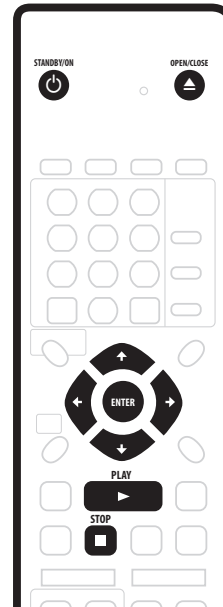

1 Press **STANDBY/ON** to switch on.

Also turn on your TV and make sure that it is set to the correct video input.

2 Press **OPEN/CLOSE** to open the disc tray.

3 Load a disc.

Load a disc with the label side facing up, using the disc tray guide to align the disc (if you're loading a double-sided DVD-Video disc, load it with the side you want to play face down).

- If you want to play a DTS audio CD, please first read the note on page 29.

4 Press **PLAY** to start playback.

- If you're playing a DVD-Video or Video CD, a disc menu may appear when you start playback. Use the **↑/↓/←/→** (cursor) buttons and **ENTER** to navigate DVD disc menus, and the number buttons and **ENTER** for Video CD menus.
- See the following sections for more details on playing specific kinds of discs.

5 To stop playback, press **STOP**.

6 When you've finished using the recorder, eject the disc and switch the recorder back into standby.

- To open/close the disc tray, press **OPEN/CLOSE**. Remove the disc before putting the recorder into standby.
- Press **STANDBY/ON** to switch the recorder into standby.

Playing DVD discs

The table below shows the basic playback controls for DVD-Video, and recordable DVD discs.



Press to start playback.
If **RESUME** is displayed on-screen, playback starts from the place last stopped.



Press to stop playback.
You can resume playback from the same point by pressing ► **PLAY**. (Press ■ **STOP** again to cancel the resume function.)



Pauses playback, or restarts playback when paused.



Press to start scanning. Press repeatedly to increase the scanning speed. (There are four scan speeds; the current scan speed is shown on-screen.)



Press to skip to previous/next chapter/title. (You can also use the front panel +/- buttons to do this during playback.)



Except VR mode: During playback, enter a chapter number then press **ENTER** to skip directly to that chapter within the currently playing title.

On some discs, you can also use the number buttons to select numbered items in the disc menu.

VR mode only: During playback, enter a title number then press **ENTER**.



(Commercial back/skip) Each press skips backward/forward progressively up to a maximum of 10 minutes forward or 3 minutes back.



During playback, press to start slow-motion playback. Press repeatedly to change the playback speed.
While paused, press to advance a single frame in either direction.



Press to display the 'top' menu or menu of a DVD-Video disc (these are often the same).



Use the cursor buttons to navigate DVD-Video disc menus; press **ENTER** to select items.



Press to return to the previous level of a DVD-Video disc menu.

Playing CDs and WMA/MP3 discs

The table below shows the basic playback controls for audio CDs, and WMA/MP3 files.



Press to start playback.



Press to stop playback.



Pauses playback, or restarts playback when paused.



CD and MP3 only: Press to start scanning. Press again to increase the scanning speed. (There are two scan speeds; the current scan speed is shown on-screen.)



Press to skip to previous/next track (or folder for WMA/MP3 disc). (You can also use the front panel +/- buttons to do this during playback.)



During playback, enter a track number then press **ENTER** to skip directly to that track.

Note

- If you want to play a DTS audio CD, make sure the recorder is connected to a DTS-compatible amplifier with a digital connection. Noise will be output through the analog outputs. Also make sure that **STEREO** is selected using the **AUDIO** button (see *Switching audio channels* on page 41).
- Scanning doesn't work with WMA tracks.

Playing Video CDs

The table below shows the basic playback controls for Video CDs.

Some discs feature Playback Control (PBC for short) menus. These discs show PBC in the display when you load them and display a menu on-screen from where you can select what to watch.



Press to start playback.

If **RESUME** is displayed on-screen, playback starts from the place last stopped.



Press to stop playback.

You can resume playback from the same point by pressing ► **PLAY**. (Press ■ **STOP** again to cancel the resume function.)



Pauses playback, or restarts playback when paused.



Press to start scanning. Press repeatedly to increase the scanning speed. (There are two scan speeds; the current scan speed is shown on-screen.)



Press to skip to previous/next track. (You can also use the front panel +/- buttons to do this during playback.)
When a PBC menu is displayed, press to display the previous/next page.



During playback, enter a track number then press **ENTER** to skip directly to that track.

While a PBC menu screen is displayed, use to select numbered menu items.



Each press skips backward/forward progressively up to a maximum of 10 minutes forward or 3 minutes back. Note that this function doesn't work when playing in PBC mode.



During playback, press to start slow-motion playback. Press repeatedly to change the playback speed.

While paused, press to advance a single frame (forward direction only).



Press to display the disc menu of a Video CD playing in PBC mode.

Note

- When playing in PBC mode, some playback features, such as search, repeat and program play are not available. You can play a PBC Video CD in non-PBC mode by pressing ►► to start playback instead of ► **PLAY**.

Using the Home Menu

From the Home Menu screen you can access all the features of the recorder. Press **HOME MENU** to display the Home Menu screen:



DVR-320 screen

Use the ↑/↓/←/→ (cursor) buttons followed by **ENTER** to select the option you want. To exit the Home Menu, press **HOME MENU**.

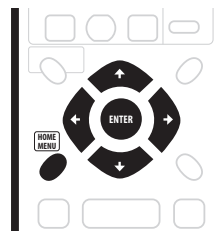

Home menu options

Timer Recording (page 44)	Disc Setup (page 70)
Disc Navigator (page 33, page 56)	Initial Setup (page 75)
Disc History (page 67)	Video/Audio Adjust (page 72)
PhotoViewer (page 68)	Play Mode (page 37)
DV Record (DVR-320 only) (page 52)	

Note

- Some options in the Home Menu may be grayed out sometimes, indicating that they are not available at the present time. For example, the Photoviewer option is grayed out unless there is a disc loaded that contains JPEG image files.

Displaying disc information on-screen

You can display various on-screen information about the disc loaded.

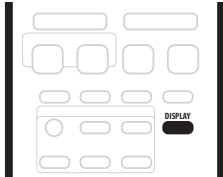

1 Press DISPLAY repeatedly to display/change the on-screen information.

- The on-screen display automatically disappears after 150 minutes.

2 To hide the information display, press DISPLAY repeatedly until it disappears.

The example displays below are a guide only; actual displays vary according to the disc loaded, etc.

Stop display 1

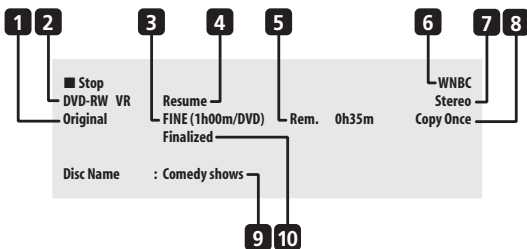

1 DVD-RW Original / Play List

If a VR mode disc is loaded, this shows whether playback is currently set to **Original** or **Play List**.

2 Disc type and mode

Shows the disc type (**DVD-R**, **DVD-RW**, **CD**, etc.), and the disc mode for recordable DVD, if applicable (**VR** or **Video**).

3 Recording mode and time

Shows the current recording mode (**FINE**, **SP**, **LP**, etc.), and the total recording time of the disc.

4 Resume

Shows **Resume** if playback can be resumed from the last place stopped.

5 Recording time remaining

Shows the approximate recording time left on the disc in the current recording mode.

6 Station call letters or TV channel

Shows the station call letters or TV channel preset for the built-in TV tuner.

7 Audio mode

Shows the broadcast audio mode for the current channel preset (**Mono**, **Stereo**, etc.).

8 Copy control information

Shows recording restrictions.

9 Disc name

Shows the disc name.

(For CDs, this area shows playable files other than CD audio tracks; for example, **Multi-format: WMA/MP3**.)

10 Finalized

Shows **Finalized** if a recordable DVD is finalized.

Stop display 2

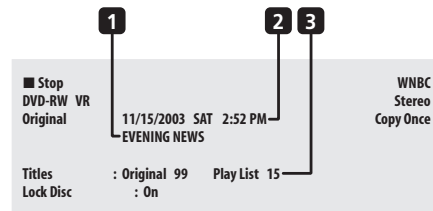

1 Broadcast program name

2 Date and time

3 Number of titles/tracks on disc

For a VR mode DVD-RW, the number of Original and Play List titles are shown separately.

Play display 1

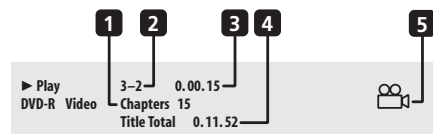

1 Number of chapters in title

2 Current title and chapter number

(For CD/Video CD, shows current track; for WMA/MP3, shows current folder and track; for JPEG disc, shows current folder and file.)

3 Elapsed title time

(For CD, WMA, MP3, shows elapsed track time; for Video CD, shows elapsed disc time.)

4 Total running time of title

5 Angle indicator

Lights during multi-angle scenes.

Play display 2

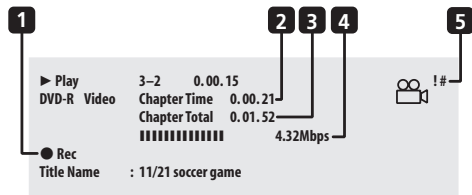

1 Chase playback, simultaneous record/playback

Indicates that recording is in progress

2 Elapsed chapter time

3 Total running time of chapter

4 Data transfer rate

Shows the current data rate being read from the disc.

5 Copy protected material (!) / PureCinema indicator (#)

Shows '!' if the playback material is copy-once protected.

Shows '#' if the current video is 24 fps, progressive scan.

Note

- When using the simultaneous play and record feature, the display shows information for playback only.
- Transfer rate shows the amount of video and audio information recorded on the disc. It is not an indication of picture/audio quality.
- The Video mode disc displays become the same as a DVD-Video disc once the disc is finalized.
- The total recording time figure shown in parenthesis is calculated based on a 12cm/4.7GB disc at the displayed record setting.
- Recording and playback times for TV recordings are approximately 0.1% shorter than the actual time. This is because of the slightly different frame rates of TV broadcasts versus DVD.
- **Copy Once** or **Can't Record** messages may appear in the stop or recording displays. These indicate that the broadcast TV program contains copy control information.

Recording display

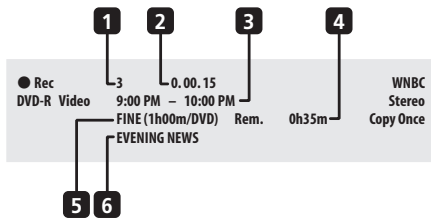

1 Current title number

2 Elapsed recording time

3 Timer recording start and stop times

Shows the start and stop times if the current recording is a timer recording.

4 Remaining recording time available

Shows the amount of space left on the disc in the current recording mode.

5 Recording mode

Shows the current recording mode (**FINE**, **SP**, **LP**, etc.), and the total recording time of the disc.

6 Broadcast program title

Chapter 5

Playback

Introduction

Most of the features described in this chapter make use of on-screen displays. Navigate these using the **↑/↓/←/→** (cursor buttons) and **ENTER**. To go back one level from any screen, use the **RETURN** button. Remember also that the button guide at the bottom of every screen shows what.

Many of the functions covered in this chapter apply to DVD discs, Video CDs, WMA/MP3 discs and CDs, although the exact operation of some varies slightly with the kind of disc loaded. The following icons are provided to help you quickly identify which instructions you need for which kind of disc.

- DVD** Any kind of DVD, DVD-R or DVD-RW
- DVD-Video** Commercially produced DVD or finalized Video mode DVD-R/RW
- Video mode** Video mode DVD-R/RW (unfinalized)
- VR mode** VR mode DVD-RW
- CD** Audio CD
- Video CD** Video CD
- WMA/MP3** WMA or MP3 files
- MP3** MP3 files

- Some DVD-Video discs don't allow certain playback controls to operate at certain points in the disc. This is not a malfunction.
- When playing Video CDs, some functions, such as making a program list, are not available in PBC mode. Stop the disc first, then start playback by pressing **▶▶**.
- For discs that contain JPEG picture files, see *The PhotoViewer* on page 68.

Using the Disc Navigator to browse the contents of a disc.

Use the Disc Navigator to browse the contents of a disc and start playback.

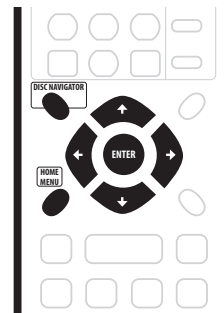

Using the Disc Navigator with playback-only discs

DVD-Video **CD** **Video CD** **WMA/MP3**

1 Press HOME MENU and select 'Disc Navigator' from the on-screen display.

Alternatively, for a CD, Video CD or WMA/MP3 disc, you can press **DISC NAVIGATOR** (front panel or remote), which takes you straight to the Disc Navigator screen.



DVR-320 screen

2 Select what you want to play.

Use the **↑/↓/←/→** (cursor buttons) to highlight items and **ENTER** to select.

Depending on the type of disc you have loaded, the Disc Navigator looks slightly different.

The screen for DVD discs shows the titles on the left and the chapters on the right. Select a title, or a chapter within a title.

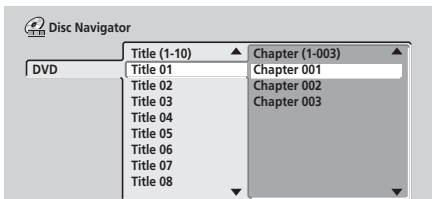

The screen for CDs and Video CDs shows a list of tracks.

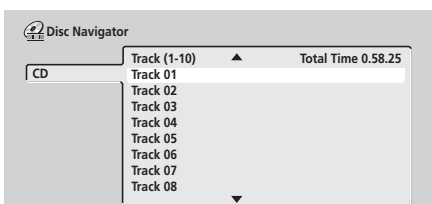

The screen for WMA/MP3 discs shows a list of folders and tracks. Select a folder or a track within a folder.

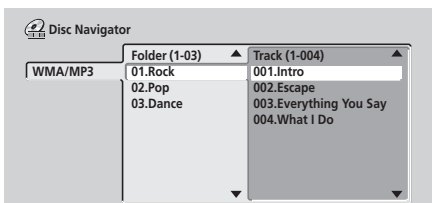

Playback starts after you press **ENTER**.

- For discs that contain both CD-Audio tracks and WMA/MP3 tracks, you can switch the playback area between **CD** and **WMA/MP3**. This can only be done while the disc is stopped.

Using the Disc Navigator with recordable discs

VR mode **Video mode**

When used with a recordable disc, the Disc Navigator gives you access to all the editing features of this recorder as well as the ability to browse and play titles. See also *Editing* on page 56 for more on editing recordable discs.

1 Press HOME MENU and select 'Disc Navigator' from the on-screen display.

Alternatively, you can press **DISC NAVIGATOR** to go straight to the Disc Navigator screen.

2 Select 'Play' from the menu options.

3 Use the ↑/↓/←/→ (cursor buttons) to select a title to play.

4 Press ENTER to start playback.



Tip

- You can also use the front panel controls: Press **DISC NAVIGATOR**, then use the **+ / -** buttons to select a title. Press **▶ PLAY** to start playback.



Note

- The Disc Navigator is only accessible when there is a disc loaded.
- It's not possible to use the Disc Navigator when playing a Video CD in PBC mode.
- Another way to find a particular place on a disc is to use the time search mode. See *Search Mode* on page 37.

Changing the thumbnail picture for a title

VR mode **Video mode**

You can change the thumbnail picture that appears for each title in the Disc Navigator screen using the **NAVI MARK** button.

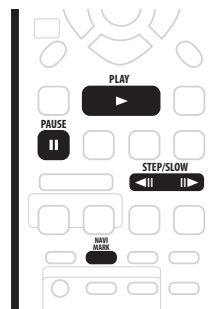

1 Start playback of the title you want to change the thumbnail for.

2 Press NAVI MARK anywhere in the title to make the displayed picture the thumbnail for that title.

- For greater control over the exact frame you want to use, you can use the **II PAUSE** and/or slow-motion/frame advance/reverse controls (**◀II / II▶**).

Navigating discs

ALL

During playback you can easily jump to another title, chapter or track on a disc using the number buttons on the remote.



DVD-Video Video mode

1 During playback use the number buttons to enter a chapter number within the current title.

For example, for chapter 6, press **6**; for chapter 24, press **2**, then **4**.

- To clear and start again, press **CLEAR**.

2 Optionally: Press ENTER.

- Alternatively, just wait a few seconds and playback will jump to the new chapter.

VR mode

1 During playback, use the number buttons to input a title number.

For example, for title 6, press **6**; for title 24, press **2**, then **4**.

- To clear and start again, press **CLEAR**.

2 Optionally: Press ENTER.

- Alternatively, just wait a few seconds and playback will jump to the new title.

CD Video CD WMA/MP3

1 During playback, use the number buttons to input a track number.

For example, for track 6, press **6**; for track 24, press **2**, then **4**.

- To clear and start again, press **CLEAR**.

2 Optionally: Press ENTER.

- Alternatively, just wait a few seconds and playback will jump to the new track.

Scanning discs

You can fast scan discs at various speeds, forwards or backward.

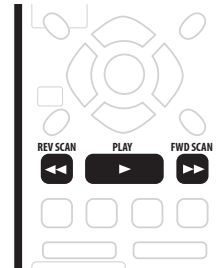

1 During playback, press ◀◀ or ▶▶ to start reverse or forward scanning.

- The scanning speed is shown on-screen.

2 Press the same button repeatedly to increase the scanning speed.

DVD

- **Forward:**
SCAN 1 → SCAN 2 → SCAN 3 → SCAN 4
- **Reverse:**
Reverse play → SCAN 1 → SCAN 2 → SCAN 3 → SCAN 4

CD Video CD MP3

- **Forward/Reverse:**
SCAN 1 → SCAN 2

3 To resume normal playback, press ▶ PLAY.

Note

- Depending on the disc, reverse playback may not be smooth.
- Sound can be heard while scanning audio CDs (analog output only).
- Scanning is not possible with WMA files.
- No subtitles are displayed while scanning DVD-Video discs.
- No sound is output when scanning DVDs, except on forward **SCAN 1***1. (Linear PCM is output from the optical digital output during forward **SCAN 1**.)

*1 Except during chase playback and simultaneous recording/playback.

- Depending on the disc, normal playback may automatically resume when a new chapter is reached on a DVD disc.

Playing in slow motion

DVD Video CD

You can play DVDs and Video CDs at various slow motion speeds. DVDs can be played in slow motion in either direction, while Video CDs can only be played forwards in slow motion.

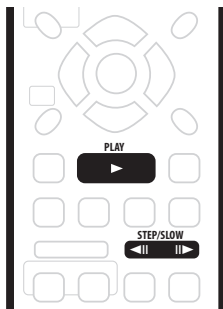

1 Press ◀|| or ||▶ to start slow motion reverse or forward playback.

- The playback speed is shown on-screen.
- There is no sound during slow motion playback

2 Press the same button repeatedly to change the slow motion speed.

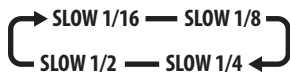

3 To resume normal playback, press ▶ PLAY.

Note

- The picture quality during slow motion playback is not as good as during normal playback and depends on the disc being played.
- Reverse slow-motion playback may not be as smooth as forward and may be better with some discs than others.
- Depending on the disc, normal playback may automatically resume when a new chapter is reached on a DVD disc.
- No sound is output during slow-motion playback.

Frame advance/frame reverse

DVD Video CD

You can advance or back up a DVD disc frame-by-frame. With Video CDs, you can only use frame advance.

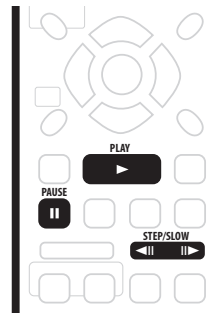

1 During playback, press || PAUSE.

2 Press ◀|| or ||▶ to back up or advance one frame.

- You can only use frame advance when playing a Video CD.
- Hold down ◀|| or ||▶ for continuous frame reverse/frame advance.

3 To resume normal playback, press ▶ PLAY.

Note

- The picture quality when using frame reverse is not as good as frame advance.
- Depending on the disc, normal playback may automatically resume when a new chapter is reached on a DVD disc.

The Play Mode menu

ALL

The Play Mode menu gives you access to search functions, repeat and program play functions.

Important

- You can't use the Play Mode features with Video CDs playing in PBC mode, or while a DVD disc menu is being displayed. For other restrictions, see the following sections.



- 1 Press **PLAY MODE** to display the Play Mode menu screen.

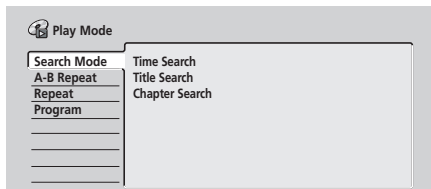

- You can also access the Play Mode menu from the Home Menu (press **HOME MENU**).

- 2 Use the **↑/↓/←/→** (cursor buttons) and **ENTER** to navigate.

- To exit the Play Mode menu, press **HOME MENU** or **PLAY MODE**.

Search Mode

ALL

The Search Mode feature lets you start playback from a specified point in a disc by time or by title/chapter/folder/track number.

- 1 Select '**Search Mode**' from the Play Mode menu.
- 2 Select one of the search options.
- 3 Use the number buttons to enter a title/chapter/folder/track number or the search time (in hours, minutes & seconds).

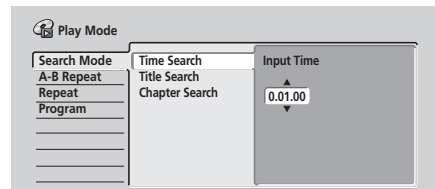

Time Search (DVD): For example, for 25 minutes into the current title, press **2, 5, 0, 0**. For 1 hour and 15 minutes and 20 seconds into the title, press **1, 1, 5, 2, 0**.

Time Search (Video CD): For example, for 45 minutes into the disc, press **4, 5, 0, 0**.

Title/Chapter/Folder/Track Search: For example, for track 6, press **6**. Alternatively, you can use the **↑/↓** (cursor up/down) buttons.

- 4 Press **ENTER**.

Tip

- You can often select what you want to watch on a DVD disc from the disc menu. Press **MENU** or **TOP MENU** to display the disc menu.

Note

- When using time search, playback may occasionally start slightly before or after the time you input.

A-B Repeat

DVD

CD

Video CD

The A-B Repeat function allows you to specify two points (A and B) within a track or title that form a loop which is played over and over.

Important

- You can't use A-B Repeat with WMA/MP3 discs.

1 During playback, select 'A-B Repeat' from the Play Mode menu.

2 With 'A (Loop Start)' highlighted, press ENTER at the point you want the loop to start.

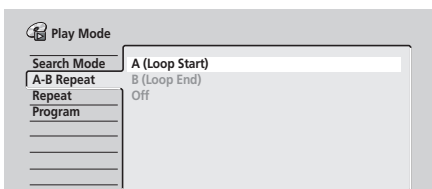

After setting the loop start point, the highlight will automatically move down to **B(Loop End)**.

3 With 'B (Loop End)' highlighted, press ENTER at the point you want the loop to end.

Playback immediately jumps back to the start point and plays the loop round and round.

- When playing a DVD-Video/Video mode DVD, the start and end points of the loop must be in the same title.

4 To resume normal playback, select 'Off' from the A-B Repeat menu.

- You can also press **CLEAR** to cancel A-B Repeat play if no menu OSD (such as the Disc Navigator) is displayed.

Note

- If you switch camera angles while using A-B Repeat with a DVD-Video disc, A-B repeat is canceled.

Repeat play

ALL

There are various repeat play options, depending on the kind of disc loaded. It's also possible to use repeat play together with program play to repeat the tracks/chapters in the program list (see *Program play* below).

1 Select 'Repeat' from the Play Mode menu.

2 Select a repeat play mode.

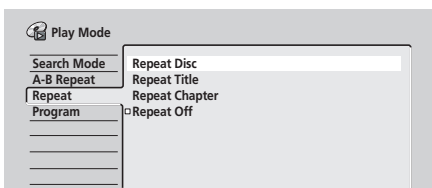

VR mode

- For VR mode DVD discs, select **Repeat Disc**, **Repeat Title** or **Repeat Chapter** (or **Repeat Off**).

DVD-Video Video mode

- For DVD-Video and Video mode DVD discs, select **Repeat Title** or **Repeat Chapter** (or **Repeat Off**).

CD Video CD

- For CDs and Video CDs, select **Repeat Disc** or **Repeat Track** (or **Repeat Off**).

WMA/MP3

- For WMA/MP3 discs, select **Repeat Disc**, **Repeat Folder** or **Repeat Track** (or **Repeat Off**).

3 To resume normal playback, select 'Repeat Off' from the Repeat Play menu.

- You can also press **CLEAR** to cancel repeat play if no menu OSD (such as the Disc Navigator) is displayed.

Note

- If you switch the camera angle during repeat play of a DVD-Video disc, repeat play is canceled.
- If there is a program list, you can also select **Repeat Program** to repeat the program list.

Program play

DVD-Video CD Video CD WMA/MP3

This feature lets you program the play order of titles/chapters/folders/tracks on a disc.

1 Select 'Program' from the Play Mode menu.

2 Select 'Input/Edit Program' from the list of program options.

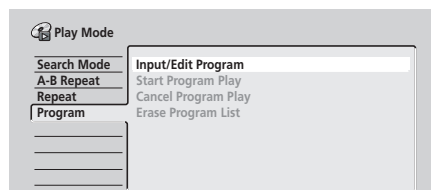

The Program edit screen that appears depends on the kind of disc loaded.

On the left side is the program list, then to the right is a list of titles (DVD), folders (WMA/MP3), or tracks (CD, Video CDs). On the far right is a list of chapters (DVD) or tracks (WMA/MP3).

3 Select a title, chapter, folder or track for the current step in the program list.

For a DVD disc, you can add a whole title, or a chapter within a title to the program list.

- To add a title, select the title.
- To add a chapter, first highlight the title, then press → (cursor right) and select a chapter from the list.

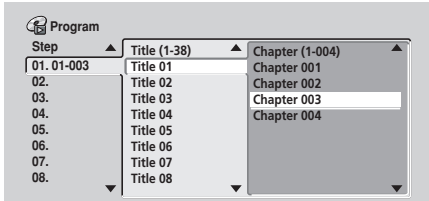

For a CD or Video CD, select a track to add to the program list.

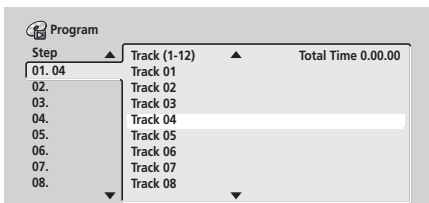

For a WMA/MP3 disc, you can add a whole folder, or a track within a folder to the program list.

- To add a folder, select the folder.
- To add a track, first highlight the folder, then press → (cursor right) and select a track from the list.

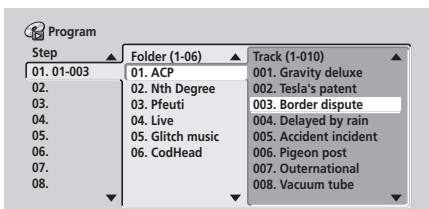

After pressing **ENTER** to add the title/chapter/folder/track, the step number automatically moves down one.

- To insert a step into the program list, highlight the step number where you want to insert another step, then select a chapter/title/folder/track as usual. After pressing **ENTER**, all the subsequent steps move down one.
- To delete a step from the program list, highlight the step you want to delete, then press **CLEAR**.

4 Repeat step 3 to build up a program list.

A program list can contain up to 24 titles/chapters/folders/tracks.

5 To play the program list, press ► PLAY.

Program play remains active until you turn off program play (see below), erase the program list (see below), eject the disc or switch off the recorder.



Tip

- To save your program list and exit the program edit screen without starting playback, press **HOME MENU** or **PLAY MODE**.
- You can change the program list by selecting **Input/Edit Program** from the Play Mode Program menu
- During program play, press ►► to skip to the next program step.
- Press **CLEAR** during playback to switch off program play (if no menu OSD, such as the Disc Navigator, is displayed). Press while stopped to erase the program list.

Other Program play functions

As well as creating and editing a program list, you can start program play, cancel program play, and erase the program list from the Play Mode menu.

1 Press PLAY MODE and select 'Program' from the list of functions on the left.

2 Select a program play function.

- **Input/Edit Program** – See above
- **Start Program Play** – Starts playback of a saved program list
- **Cancel Program Play** – Turns off program play, but does not erase the program list
- **Erase Program List** – Erases the program list and turns off program play



Note

- When playing a program list of DVD-Video chapters, chapters not included in the program list may be sometimes be played, depending on the disc.
- You can use repeat play with program play. Start playback of the program list then select **Program Repeat** from the Repeat Play Mode menu (see *Repeat play* on page 38).

Displaying and switching subtitles

DVD-Video

Some DVD discs have subtitles in one or more languages; the disc box will usually tell you which subtitle languages are available. You can switch subtitle language during playback.

Check the disc packaging for details of the subtitle options.

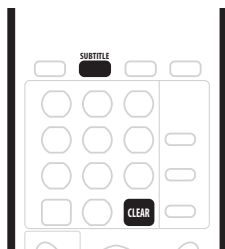

1 Press SUBTITLE repeatedly to select a subtitle option.

The current subtitle language is shown on-screen and in the front panel display.

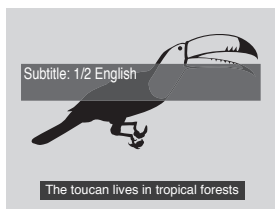

2 To switch off subtitles, press SUBTITLE then CLEAR.

Note

- Some discs only allow you to change subtitle language from the disc menu. Press **TOP MENU** to access.
- To set subtitle preferences, see *Subtitle Language* on page 80.

Switching DVD soundtracks

DVD-Video

When playing a DVD disc recorded with two or more soundtracks (often in different languages), you can switch the soundtrack during playback.

Check the disc packaging for details of the soundtrack options.

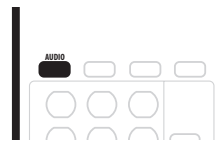

- Press **AUDIO** repeatedly to select an audio soundtrack.

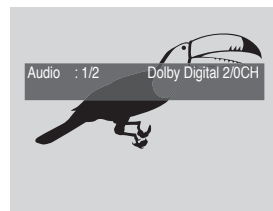

Note

- The sound may drop out for a few seconds when switching soundtracks.
- Some discs only allow you to change audio language from the disc menu. Press **TOP MENU** to access.
- To set audio language preferences, see *Audio Language* on page 80.
- Some discs feature both Dolby Digital and DTS soundtracks. There is no analog audio output when DTS is selected. To listen to the DTS soundtrack, connect this recorder to a DTS decoder or AV amplifier with built-in DTS decoder via the digital output. See *Connecting to an AV amplifier* on page 18 for connection details.

Switching audio channels

VR mode

CD

Video CD

WMA/MP3

For VR mode content that has both a main and a SAP (Secondary Audio Program) audio channel, you can switch between main (**L**), SAP (**R**), or both (**L+R**).

When playing Video CDs and audio CDs you can switch between stereo, just the left channel or just the right channel.



1 To display/switch the audio channel, press **AUDIO** repeatedly.

The audio channel(s) currently playing are indicated on-screen.

VR mode

- **L+R** – Both channels (default)
- **L** – Left/main channel only
- **R** – Right/SAP channel only

CD

Video CD

WMA/MP3

- **Stereo** – Stereo (default)
- **1/L** – Left channel only
- **2/R** – Right channel only



Note

- When playing a Dual Mono recording on a VR mode disc, if you are listening to the Dolby Digital soundtrack via the digital output, you cannot switch the audio channel. Set **Dolby Digital Out** to **Dolby Digital** → **PCM** (see *Dolby Digital Out* on page 79) or listen via the analog outputs if you need to switch the audio channel.

Switching camera angles

DVD-Video

Some DVD-Video discs feature scenes shot from two or more angles—check the disc box for details: it should be marked with a  icon if it contains multi-angle scenes. When a multi-angle scene is playing, the same icon appears on screen to let you know that other angles are available (this can be switched off if you prefer—see *Angle Indicator* on page 85).

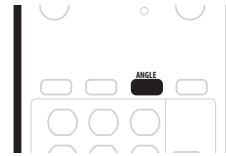

• To switch the camera angle, press **ANGLE**.

- The angle number is displayed on-screen.
- If the disc was paused, playback starts again with the new angle.
- Repeat play is canceled if you change the angle while repeat playback is active.



Note

- You can also change the angle from some DVD-Video disc menus. Press **TOP MENU** to access.

Chapter 6

Recording

About DVD recording

This recorder can record on both DVD-R and DVD-RW media. The main difference between the two is that DVD-R discs can only be recorded once, while DVD-RW can be recorded, erased and re-recorded many times.

A further difference between the two disc types is that only DVD-RW can be initialized for *VR mode* recording, which offers much more comprehensive editing functions compared to *Video mode* recording.

The big advantage, however, of Video mode is its compatibility with standard DVD players, most of which will not play VR mode DVD-RW discs (see also the notes below).

While DVD-R discs can only be recorded using the Video mode, you can initialize a DVD-RW disc for Video or VR mode recordings. Once initialized (any previous content is erased in this operation), all recordings on that disc will be in the chosen recording mode.



Important

- You cannot play, edit or record on unfinalized DVD-R/RW discs recorded in Video mode on other DVD recorders. (Likewise, unfinalized Video mode discs recorded on this recorder are not playable on other players/recorders.)
- This recorder cannot record onto CD-R or CD-RW discs.
- Pioneer takes no responsibility for recording failure due to power cuts, defective discs, or damage to the recorder.
- Fingerprints and small scratches on a disc can affect playback and/or recording performance. Please take proper care of your discs.



Note

- Some DVD players, such as some Pioneer models, are compatible with VR mode DVD-RW discs. Check the operating instructions for your player for VR mode compatibility information.
- The maximum number of titles that can be recorded on a DVD-R/RW disc is 99.
- The maximum number of chapters recordable on a DVD-R/RW disc is 999.

Recording time and picture quality

There are four preset recording quality modes:

- **FINE** – Highest quality setting, gives about 1 hour of recording time.
- **SP** (Standard Play) – Default quality, sufficient for most applications, gives about 2 hours of recording time.
- **LP** (Long Play) – Slightly lower video quality, but doubles the recording time to around 4 hours.
- **EP** (Extended Play) – Use when maximum recording time is most important; EP gives you around 6 hours of recording time.

In addition to these settings, you can access 32 different recording quality/time settings when manual recording mode is on (see *Manual Recording* on page 82), giving you very fine control over the recording.

When setting a timer recording there is a further option, **AUTO**, which maximizes the recording quality for the space available on the disc loaded at the time of recording.

In all except the **FINE/MN32** modes, sound is recorded in two channel Dolby Digital format. When set to **FINE/MN32**, sound is recorded in high quality, uncompressed Linear PCM format.

If the broadcast audio has a SAP channel and you are recording in Video mode, or in VR mode on the **FINE/MN32** setting, use the **AUDIO** button to select the **Mono, Stereo** or **SAP** audio channel to record before recording starts.



Note

- Note that all recording times (both here and those shown by the recorder) are only approximate. This is because of the way that the video is recorded; you may get slightly more or slightly less, depending on what you're recording.

Restrictions on video recording

- You cannot record copy-protected video using this recorder. Copy-protected video includes DVD-Video discs and some satellite broadcasts. If copy-protected material is encountered during a recording, recording will pause automatically and an error message will be displayed on-screen.
- Video that is 'copy-once only' can only be recorded on a DVD-RW disc in VR mode (see below).
- When recording a TV broadcast or through an external input, you can display copy control information on screen. (see *Displaying disc information on-screen* on page 31).

CPRM

CPRM is a copy protection system with scramble system regarding the recording of 'copy once' broadcast programs. CPRM stands for *Content Protection for Recordable Media*.

This recorder is CPRM compatible, which means that you can record copy-once broadcast programs, but you cannot then make a copy of those recordings. CPRM recordings can only be made on CPRM-compatible DVD-RW (ver. 1.1 or higher) discs formatted in VR mode.

DVD CPRM recordings can only be played on players that are specifically compatible with CPRM.

Recording equipment and copyright

You may use this product only to reproduce or copy materials for which you own the copyright or have obtained permission to copy from the copyright owner or for which you otherwise have a legal right to reproduce or copy. Unless you own the copyright or have obtained permission from the copyright owner or otherwise have a legal right to reproduce or copy, you may be violating the law, including copyright law, and may be subject to payment of damages and other remedies.

- This product incorporates copyright protection technology that is protected by method claims of certain U. S. patents and other intellectual property rights owned by Macrovision Corporation and other rights owners. Use of this copyright protection technology must be authorized by Macrovision Corporation, and is intended for home and other limited viewing uses only unless otherwise authorized by Macrovision corporation. Reverse engineering or disassembly is prohibited.

Setting the picture quality/recording time

VR mode Video mode

Before starting a recording, you will usually want to set the picture quality/recording time. There are four standard settings available, which allow you to choose a balance between picture quality and recording time.

It's also possible to create a fifth, 'manual' setting for picture quality/recording time. Before you can select this, however, you will need to set the **Manual Recording** option in the Initial Settings menu (see *Manual Recording* on page 82).

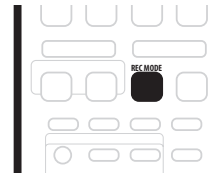

- **Press REC MODE (remote or front panel) repeatedly to select a recording setting.**

- **FINE** – Fine picture quality
- **SP** – Standard play
- **LP** – Long play
- **EP** – Extended play
- **MN** – Manual (available only when manual recording is on)

The setting is indicated in the front panel display, and shown on-screen together with the recording time for a blank recordable disc. If a recordable disc is loaded, the approximate remaining recording time for that disc is also shown. (Note that if the On Screen Display setting (see *On Screen Display* on page 76) is **Off** then this information is not displayed.)

Basic recording from the TV

VR mode **Video mode**

Follow the instructions below to record a TV program. Recording starts immediately and continues until the disc is full or you stop the recording.

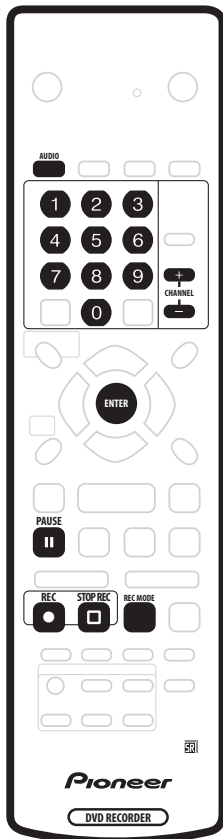

1 Load a recordable disc.

- If you load a new blank DVD-RW disc, the recorder takes a short while to initialize the disc.

2 Use the CHANNEL +/- buttons to select the TV channel to record.

The front panel display shows the channel number:



- While the recorder is stopped, you can also use the number buttons on the remote to select the channel. (For channel 6, press **6** then **ENTER**; for channel 24, press **2, 4** then **ENTER**)

- If the recorder is stopped, you can also use the **+/-** buttons on the front panel to select the channel number.

3 Use the REC MODE button to set the picture quality/recording time.

- See *Setting the picture quality/recording time* above for detailed instructions.

4 If the broadcast audio has a SAP channel (Second Audio Program), press AUDIO to select the audio channel to record.

Press repeatedly to switch between **Mono**, **Stereo** and **SAP** audio channels.

- When recording in VR mode, both mono and SAP audio channels are recorded, allowing you to switch the audio channel on playback. The only exception to this is when the picture quality is set to **FINE/MN32**, in which case you do need to select the audio channel before recording.

5 Press ● REC to start recording.

If you want to set a recording end time, press the ● **REC** button repeatedly. The recording time increases in 30 minute increments, up to a maximum of 6 hours. The time the recording will end is shown on-screen and in the front panel display. When the recording ends, the recorder automatically switches into standby if no other operation is being performed.

- To cancel the set recording time, press ● **REC**.
- If you want to pause recording at any time, press **II PAUSE**. Press again to restart the recording. (If recording in VR mode, a new chapter is started after recording restarts)

6 To stop the recording, press □ STOP REC.

- If you set the recording time in the previous step, you can still stop the recording anytime by pressing □ **STOP REC**.
- Recording will stop automatically when there is no more space on the DVD.

Setting a timer recording

VR mode **Video mode**

Using the timer recording features you can program up to 32 timer recordings up to a month in advance. Timer recording programs can be set to record just once, every day, or every week.

You can set the recording quality for your timer recording in the same way as for a regular recording, but with the added option of an **AUTO** mode, which maximizes the recording quality for the space available on the disc.

You can also set the recorder so that it will adjust the recording quality to try and fit the recording on to the disc if it would not otherwise fit at the recording quality you set (see *Optimized Rec* on page 82 for more on this).

Important

- A timer recording can't be set if:
 - Auto Start Recording is in progress.
 - There are already 32 timer programs waiting to be recorded.
- Timer recording will not start if:
 - The recorder is already recording
 - A disc is being initialized, finalized or unfinalized.
- Except when finalizing Video mode discs, timer recording will start when the operation preventing timer recording has finished.
- If a Video mode disc is playing when a timer recording is due to start, playback will automatically stop to allow the recording to start. (Simultaneous recording and playback is only possible with VR mode discs.)
- The timer indicator lights in the front panel display when the timer is active. If the indicator is blinking it means that there is no disc loaded, or the disc loaded is not recordable.
- Timer recordings have higher priority than the Auto Start Recording function (see *Automatic recording from a satellite tuner* on page 51). A timer recording will interrupt an Auto Start Recording. (Auto Start Recording will resume after the timer recording has finished.)
- Approximately two minutes before a timer recording is set to start, the recorder will go into timer recording standby (assuming that a recordable disc is loaded). In timer recording standby you cannot use some functions.

Easy Timer Recording

As the name suggests, Easy Timer Recording makes setting up a timer recording as simple as possible.

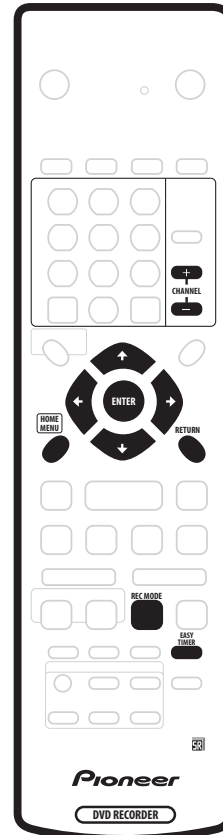

1 Press EASY TIMER.

Alternatively, you can also access from the Home Menu (press **HOME MENU** and select **Timer Recording** then **Easy Timer Recording**).

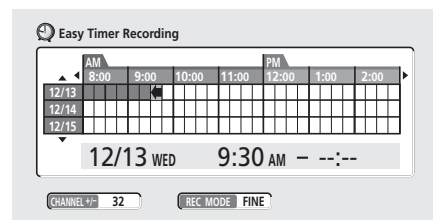

2 Set the TV channel and recording quality.

- Use the **CHANNEL +/-** buttons to set the channel you want to record.
- Use the **REC MODE** button to set the recording quality. Press repeatedly to switch between **FINE**, **SP**, **LP**, **EP** and **AUTO** (and **MN** if manual recording mode is on).

- The **AUTO** option automatically sets the best recording quality for the space available on the disc loaded at the time of recording.

3 Use **↑/↓/←/→** (cursor buttons) to move the cursor to the recording start date and time on the grid.

- You can move the cursor forward or back an hour at a time using the **◀** and **▶** buttons.

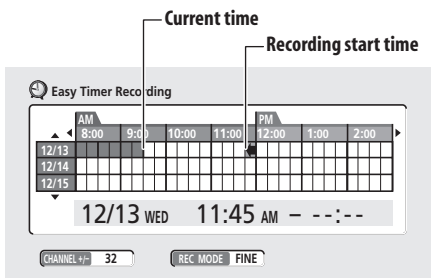

Each row of the grid is one day (you can set the timer recording for up to a month in advance). Each column is a 15 minute interval.

The darker area represents time that has already passed and can't therefore be selected. The lighter area is time that's available.

4 Press **ENTER** to set the start time.

The start date and time is displayed in the middle of the screen.

- You can go back and reset the start time if you need to by pressing **RETURN**.

5 Use the **←/→** (cursor left/right) to move the cursor to the recording end time on the grid.

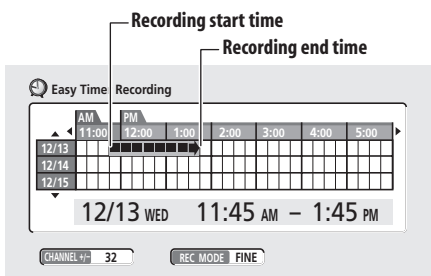

As you move the cursor around the grid, an arrow stretches from the start time to the current cursor position, representing the length of the recording. A recording of up to 6 hours can be set.

6 Press **ENTER** to set the end time.

7 Select '**Yes**' to set the timer recording and exit, or '**No**' to go back to the timer recording screen.

The timer recording indicator (Ⓢ) lights in the front panel display to indicate the recorder is in timer recording standby.

- You can check the timer recording details you just set from the main timer recording screen (see *Standard timer recording* below).

Standard timer recording

The timer recording screen you can see all the timer programs already set, clear programs and set up new ones.

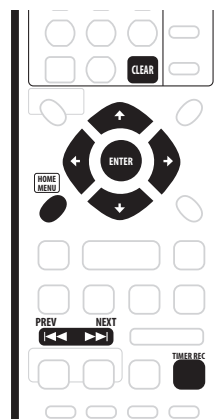

1 Press **TIMER REC** to display the Timer Recording screen.

You can also access the Timer Recording screen from the Home Menu (press **HOME MENU**, select **Timer Recording**, then **Timer Recording (View)**).

This screen shows all the timer programs currently set.

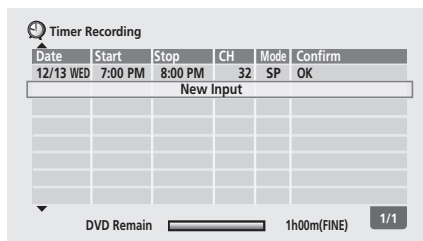

- The amount of free space available on the currently loaded recordable DVD is shown towards the bottom of the screen.
- In the lower-right corner, the number of timer programs already set is shown next to **Tmr Pgms**.

- Each row is for one timer recording program, with the date and time information, channel, recording mode and recording status.
- If there are more than eight timer programs already set, press **NEXT** ►► to switch page (go back using the **PREV** ◀◀ button).
- You can also clear a timer program by highlighting it and pressing **CLEAR**.

2 Select 'New Input' to set a new timer program, then press ENTER.

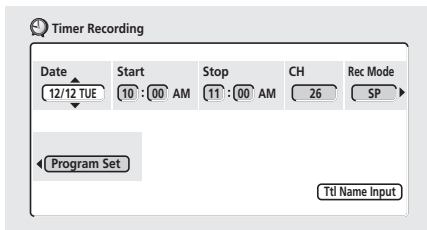

3 Enter the timer recording settings.

Use the ◀/▶ (cursor left/right) buttons to select a field; use the ↑/↓ (cursor up/down) buttons to change the value.

- **Date** – Choose a date up to one month in advance, or select a daily or weekly program.
- **Start** – Set the recording start time.
- **Stop** – Set the recording end time (maximum length of a timer recording is 6 hours).
- **CH** – Choose a channel (2–69 or 1–125 for antenna or cable channels respectively, excluding skip channels), or one of the external inputs from which to record.
- **Mode** – Select **FINE**, **SP**, **LP**, **EP** or **AUTO** (See *Setting the picture quality/recording time* on page 43). If Manual Recording is on, then you can also select the **MN** setting.
- **Ttl Name Input** – Optionally, you can enter a name for the recording up to 32 characters. (Highlight **Program Set** then press ↓ (cursor down) to access this option.)

4 After entering all the timer recording information, highlight 'Program set' and press ENTER.

The timer recording list screen is displayed again. The timer program you just input appears in the list.

- The rightmost column in the timer recording screen (**Confirm**) shows whether there's enough space to record your timer program. If you selected a daily or weekly program, the date of the last recording that will fit on the disc appears (up to a maximum of one month ahead).
- If the timer program is too long to fit into the available disc space, the message **Time Over** appears. The program will record until the disc is full.
- If **Optimized Rec** (see *Optimized Rec* on page 82) is set to **On**, the recorder will adjust the recording quality to try and fit the recording on the disc. If the program is too long even when recorded in **EP** (extended play), the message **Time Over** appears.
- If there are already the maximum number of titles or chapters on the disc, the message **Title Over** or **Data Over** appears. (There can be up to 99 titles on a disc.)
- If a timer program overlaps another in the list, the message **Overlap** appears.
- If no recordable disc is loaded, the message **Can't Rec** appears.
- **Standby** is displayed when the recorder is in timer recording standby.
- **Recording** is displayed when a timer recording is in progress.

5 To exit the timer recording screen, press HOME MENU.

- If you change the **Auto Channel Setting** (from cable to antenna or the other way around), existing timer programs will be erased.

Timer recording using the VCR Plus+® programming system

This system makes programming timer recordings very simple. Most TV guides publish PlusCode numbers with their program details. If you want to make a timer recording of a program, you just input the corresponding code. The date, start, stop and channel settings are made automatically. All you have to do is tell the recorder the recording mode, and whether it's a once-only recording or a regular recording.

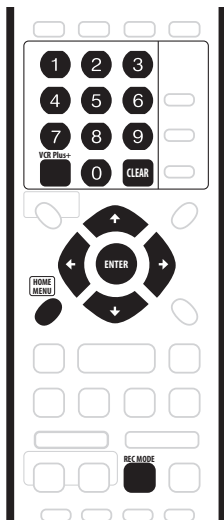

1 Press 'VCR Plus+' to display the VCR Plus+ program screen.

You can also access this screen from the Home Menu (press **HOME MENU**, select **Timer Recording**, then **VCR Plus+**).

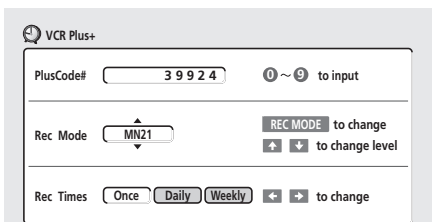

- Use the number buttons to enter the PlusCode number. (To clear the last digit entered, press **CLEAR**.)
- Press **REC MODE** to change the recording quality (see also *Setting the picture quality/recording time* on page 43). If Manual Recording is on, then you can also select the **MN** setting.
- Use the **←/→** (cursor left/right) buttons to select the **Once**, **Daily** or **Weekly** recording option.

2 After making the settings, press ENTER.

The program details are shown at the bottom of the screen for a few seconds then the screen is automatically exited.

- If you haven't set up the guide channels (or at least the guide channel for the PlusCode number that you entered), the recorder will prompt you to enter the channel number that the TV program is showing on.



Tip

- You can check the timer program settings by pressing **TIMER REC** to display the timer recording screen.

VCR Plus+ programming with the power off

You can enter a PlusCode number when the recorder is in standby.

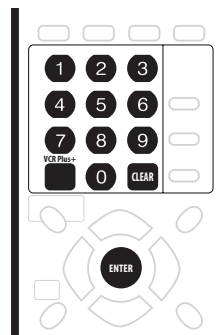

Important

- You can't use this feature until you have set up the guide channels. See *VCR Plus+ CH Setting* on page 77
- You can't change the recording mode.
- You can't program daily or weekly timer recordings.

1 Press 'VCR Plus+'.

The front panel display shows the current recording mode and prompts you to enter the PlusCode number.



2 Use the number buttons to enter the PlusCode number.



- To clear the last digit entered, press **CLEAR**.

3 Press ENTER.

The display shows the timer settings:

Date → Start time → End time → Recording channel.

- If **CODE ERROR** appears in the display, check that the PlusCode number is correct and start again from step 1.
- If **CAN'T SET** appears in the display, it means that although you entered a valid PlusCode number, the program has already finished, or the guide channel is not set.

Extending a timer recording in progress

You can extend a timer recording beyond the programmed end time in two different ways. This can be useful if a broadcast program overruns, for example.

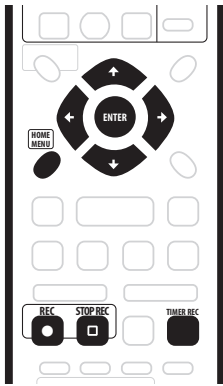

Moving the end time by 30-minute blocks

- 1 During timer recording, press and hold **REC** for three seconds.

The timer indicator disappears from the front panel display.

- 2 Press **REC** repeatedly to extend recording in 30 minute increments.

Programming a new end time

- 1 During timer recording, press **TIMER REC** to display the Timer Recording screen.

You can also access the Timer Recording screen from the Home Menu (press **HOME MENU**, select **Timer Recording**, then **Timer Recording (View)**).

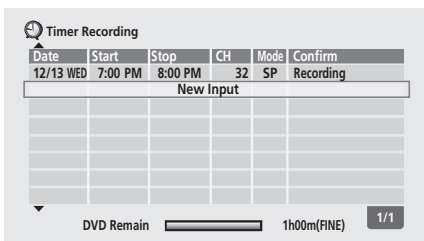

- 2 Use the **↑** (cursor up) button to highlight the current timer recording ('Recording' is shown in the 'Confirm' column), then press **ENTER**.

A screen showing details of the timer recording appears. From this screen, only the recording stop time can be changed.

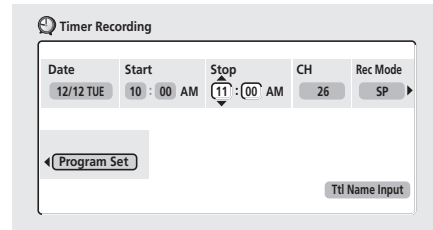

- 3 Set a new Stop time for the timer recording.

Use the **←/→** (cursor left/right) buttons to select the hour or minute field, then use the **↑/↓** (cursor up/down) buttons to change the time.

- 4 Press **ENTER** to set the new time and exit the screen.

Recording will continue until the new stop time is reached.

Canceling and stopping a timer recording in progress

After a timer recording has started, you can cancel the program (but continue recording), or stop recording completely if you need to.

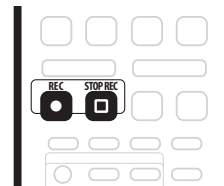

- 1 During timer recording, press and hold **REC** for three seconds.

Only the program is canceled (the timer indicator disappears); recording continues so that you can manually stop recording whenever you like.

- 2 When you want to stop recording completely, press **STOP REC**.

Preventing use of the recorder before a timer recording (child lock)

You can make all the front panel and remote control buttons inoperative using the child lock feature. This is useful when you set a timer recording and want to make sure that the timer settings are not changed before recording has finished.

1 If the recorder is on, switch it into standby.

2 Press and hold ■ **STOP** on the front panel for 3 seconds to lock the controls.

The front panel display briefly shows **LOCK**. If any buttons are pressed on the remote or front panel, **LOCK** is briefly displayed again.

- To unlock the recorder, press and hold ■ **STOP** on the front panel for 3 seconds until the display shows **UNLOCK**.
- To cancel a timer recording when the recorder is locked, first unlock the recorder (see above), then press and hold ● **REC** for 3 seconds.

Timer recording FAQ



Frequently Asked Questions

- *Even though the timer is set, the recorder doesn't start recording!*

Check that the disc loaded is recordable, not locked (see *Lock Disc* on page 70), and that there are fewer than 99 titles already on the DVD.

- *The recorder won't let me enter a timer program! Why not?*

You can't enter a timer program if the clock isn't set.

- *What happens when two or more timer programs overlap?*

Basically, the program with the earlier recording start time has priority. However, the recorder will start recording the program with the later start time after the earlier program is finished. If two programs have the same times (but different channels, for example), the program set most recently takes priority.

- *I entered a timer program, but the recorder doesn't confirm whether or not it's OK. Why not?*

Timer confirmation only works for DVD recordings when there is a recordable disc loaded. Also make sure that the disc is not locked (see *Lock Disc* on page 70) and that there are fewer than 99 titles already recorded. Note that it's possible that although the timer recording screen says **OK**, the recording doesn't complete successfully because of some other reason, such as a damaged disc, etc.

Simultaneous recording and playback

VR mode

A feature called Chase Play makes it possible to watch a recording in progress from the start of the recording (as in, playback is 'chasing' the recording). For example, perhaps you have to miss the first 30 minutes of a movie on TV; you can start recording, then start watching the movie, from the beginning, while the recorder is still recording 30 minutes ahead of you.

In fact, you're not just limited to watching the recording in progress; you can watch anything else already on the DVD by selecting it from the Disc Navigator screen (see *Using the Disc Navigator with recordable discs* on page 34).



Important

- Note that you must use a DVD-RW Ver. 1.1/2x or Ver. 1.2 disc to be able to use this feature.
- You may not be able to use this feature with DVD-RW discs initialized on another recorder.

- **During recording, press ► **PLAY** to start playback from the beginning of the current recording, or press **DISC NAVIGATOR** and select another title to play from there.**

You can use all the usual playback controls, such as pause, slow-motion play, scan and skip.

- To stop playback, press ■ **STOP** (recording will continue).
- To stop recording, press □ **STOP REC** (playback will continue).



Note

- You can't start playback immediately after recording starts.
- When scanning, no sound is output if the recorder is also recording (see *Scanning discs* on page 35).
- You can't use this feature during Auto Start Recording, or in Auto Start Recording standby.

Recording from an external component

VR mode Video mode

You can record from an external component, such as a camcorder or VCR, connected to one of the recorder's external inputs.

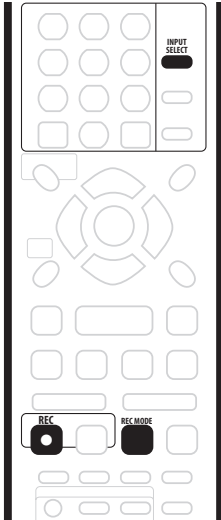

1 Make sure that the component you want to record from is connected properly to the DVD recorder.

See Chapter 2 (*Connecting up*) for connection options.

2 Press INPUT SELECT repeatedly to select one of the external inputs to record from.

There are three analog inputs and a DV digital input (DVR-320 only). The current input is shown on-screen and in the front panel display:

- **L1** – Input 1/Auto Start Rec
- **L2** – Input 2 (front panel)
- **L3** – Input 3
- **DV** – DV input/output (front panel) (DVR-320 only)

Check that the **Audio In** settings for **External Audio**, **Dual Mono Recording** and **DV Input** are as you want them (see *Audio In settings* on page 78).

- If the aspect ratio is distorted (squashed or stretched), adjust on the source component or your TV before recording.

3 Set up the recorder.

- Use **REC MODE** to set the recording quality. See *Setting the picture quality/recording time* on page 43 for detailed information.

4 Press ● REC when you're ready to start recording.

- The recorder will only start recording from the **DV IN/OUT** jack if there is a valid signal. Recording will also pause if the signal is interrupted during recording.

Note

- If your source is copy-protected using CopyGuard, you will not be able to record it. See *Restrictions on video recording* on page 43 for more details.

Automatic recording from a satellite tuner

VR mode Video mode

If you have a satellite tuner or some other kind of set top box connected to the **L1** input, you can have the recorder start and stop recording automatically with the timer settings of the connected component. (If the other component doesn't have a built-in timer, you'll need to use it with an external timer unit.)

After setting up for Auto Start Recording, this recorder starts recording when it detects a signal from the other component. When the signal ceases, the recorder stops recording.

If you want to use this recorder with the timer features of your satellite tuner, see *Information for cable/satellite/STB (set-top box) users* on page 92.

Important

- It takes a little while for this recorder to switch on and start recording after detecting a signal. Please bear this in mind when setting the timer.

1 Set the timer for the satellite receiver (or other component), then switch it into standby (if necessary).

Check the manual that came with the receiver if you're not sure how to do this.

2 Load a recordable disc into this recorder.

3 Check that the 'Audio In' settings for 'External Audio' and 'Dual Mono Recording' are as you want them.

See *Audio In settings* on page 78 for more on these settings.

4 Set up the recorder.

- Use **REC MODE** to set the recording quality. See *Setting the picture quality/recording time* on page 43 for detailed information.

5 Press **HOME MENU** and select 'Timer Recording', then 'Auto Start Rec'.

6 Select 'Start' to switch Auto Start Recording on, or 'Cancel' to switch off.

7 Switch the recorder into standby.

The **AUTO** indicator in the front panel display lights.

The recorder will automatically switch on and start recording when the other component comes on.

Recording stops when the external component switches off.

- To cancel Auto Start Recording, press **STANDBY/ON**. The indicator goes off.
- To cancel Auto Start Recording once recording has already started, press **REC** for 3 seconds, then **STOP REC**.
- If you use the **REC** button to extend a timer recording that is active during Auto Start Recording standby, Auto Start Recording is canceled. (If you want to program a new end time for the timer recording, press the front panel **+** button for 3 seconds, then program the new time (see also *Extending a timer recording in progress* on page 49). Note that Auto Start Recording is canceled when you do this.)

Note

- You can't set Auto Start Recording when:
 - the recorder is recording or in timer recording standby.
 - there is no recordable disc loaded.
 - the disc loaded is locked.
 - the disc loaded already contains the maximum number of titles (99).
 - If Auto Start Recording is set, it will not start if another timer recording is in progress.
 - Timer recordings take precedence over Auto Start Recording. Auto Start Recording will stop if a timer recording is due to start. After the timer recording has finished, Auto Start Recording will resume.

Recording from a DV camcorder (DVR-320 only)

VR mode Video mode

You can record from a DV camcorder connected to the **DV IN/OUT** jack on the front panel of this recorder. Using the recorder's remote, you can control both the camcorder and this recorder.

Before recording, make sure that the audio input for the **DV IN/OUT** jack is setup (see *DV Input (DVR-320 only)* on page 78).

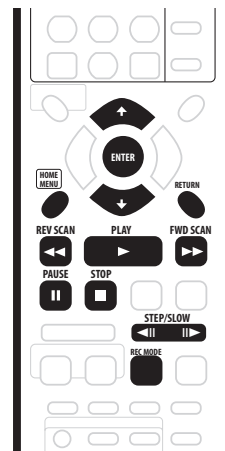

Important

- The source signal must be DVC-SD format
- Some camcorders cannot be controlled using this recorder's remote.
- If you connect a second recorder using a DV cable, you cannot control the second unit from this one.
- You can't control this unit remotely from a component connected to the **DV IN/OUT** jack.
- You can't record date and time information from DV cassette.
- During DV recording, if a part of the tape is blank, or has copy-protected material on it, this recorder will pause recording. Recording will restart automatically when there is a recordable signal.
- For best results when recording from a DV camcorder to this recorder, we recommend cueing the camcorder to the place you want to start recording from and setting the camcorder to play-pause.

1 Make sure your digital camcorder is connected to the front panel DV IN/OUT jack.

Also, set the camcorder to VTR mode.

2 Set up the recorder.

- Use **REC MODE** to set the recording quality. See *Setting the picture quality/recording time* on page 43 for detailed information.
- Make sure a recordable disc is loaded.

3 From the Initial Settings menu, check that the DV audio input is setup as you require.

See *DV Input (DVR-320 only)* on page 78 for more on this.

- Check also that the **Audio In** settings for **External Audio** and **Dual Mono Recording** are as you want them (see *Audio In settings* on page 78).

4 Press HOME MENU and select 'DV Record' from the menu.

- DV recording only works when the digital camcorder is in VTR mode with a tape loaded.

5 Find the place on the camcorder tape that you want to start recording from.

For best results, pause playback at the point from which you want to record.

- Depending on your camcorder, you can use this recorder's remote to control the camcorder using the **■**, **▶**, **||**, **◀◀**, **▶▶**, **◀||** and **||▶** buttons.

6 Use the **↑/↓** (cursor up/down) buttons to select 'Start Rec' and press **ENTER**.



- Recording is automatically paused if the recorder detects no signal, or a copy-protected signal. Recording restarts when there is a non-copy-protected signal.
- You can pause or stop the recording by selecting **Pause Rec** or **Stop Rec** from the on-screen display. You cannot control the camcorder from this remote control during recording.
- If you restart recording after stopping the camcorder, the first few seconds of the camcorder tape will not be recorded. Use the pause button on your camcorder instead and recording will start immediately.
- *VR Mode only:* A chapter marker is inserted every time there is a break in the timecode on the DV tape. This happens when the recording is stopped or paused then restarted, for example.

- While recording, you cannot exit the DV recording screen using the **HOME MENU** or **RETURN** button.

Note

- Depending on the connected camcorder, you may not be able to control it using the remote control supplied with this recorder.
- If the audio subcode on the DV tape cannot be read correctly, the audio type will not switch automatically. You can switch the audio manually from the **External Audio** setting (page 78).
- See also *DV-related messages* on page 91 if you encounter an error while using the **DV IN/OUT** jack.

Frequently Asked Questions

- *I can't get my DV camcorder to work with the recorder!*
Check that the DV cable is properly connected. Also make sure that what you're trying to record is not copy-protected.

If it still doesn't work, try switching off the camcorder then switch back on.

- *There's a picture, but no sound!*

Try switching the **DV Input** setting (see *DV Input (DVR-320 only)* on page 78) between **Stereo 1** and **Stereo 2**.

Recording from the DV output (DVR-320 only)

VR mode **Video mode**

You can record non-copy-protected material from a DVD to a camcorder connected to the **DV IN/OUT** jack.

- 1 **Connect the camcorder to the DV IN/OUT jack of this recorder.**
- 2 **Find the place you want to start recording from.**
- 3 **Start recording on the camcorder.**
- 4 **Play the source material.**

Playing your recordings on other DVD players

VR mode **Video mode**

Most regular DVD players can play finalized discs recorded in Video mode. A number of players (including many Pioneer models) can also play DVD-RW discs recorded in VR mode, finalized or not. Check the manual that came with the player to check what kinds of discs it will play.

When you finalize a Video mode disc, a title menu is created from which you can select titles when you play the disc. There are a number of different styles of title menu to choose from to suit the content of the disc.

All the title menus are navigated in the usual way, pressing **MENU** or **TOP MENU** to display the menu, then using the **↑/↓/←/→** (cursor buttons) followed by **ENTER** to select titles and start playback.

Finalizing a disc

VR mode **Video mode**

Finalizing 'fixes' the recordings in place so that the disc can be played on a regular DVD player or computer equipped with a suitable DVD-ROM drive.

Note that the disc name will appear in the title menu after you finalize a disc. Make sure the disc name is as you want it before you finalize the disc as it can't be changed afterwards. If you want to rename the disc, see *Input Disc Name* on page 70 before starting the steps below.



Important

- Once you've finalized a disc recorded in Video mode, you can't edit or record anything else on that disc. However, the finalization on a DVD-RW disc maybe 'undone'; see *Undo Finalize* on page 71 for how to do this.
- A VR mode disc can still be recorded and edited on this recorder even after finalizing.

1 Load the disc you want to finalize.

Make sure that the recorder is stopped before proceeding.

2 Press HOME MENU and select 'Disc Setup'.

3 Select 'Finalize'.

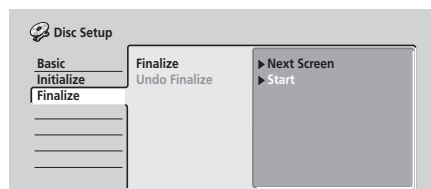

4 Select 'Finalize' from the finalize options, then 'Next Screen'.

5 For Video mode discs only, select a title menu style, then select 'Yes' to start finalization or 'No' to cancel.

The menu you select will be the one that appears when the 'top menu' is selected on any DVD player.



- Discs recorded partially or fully on the Pioneer DVR-7000 DVD recorder do not support this feature. These discs will have only a text title menu when finalized on this recorder.

6 The recorder will now start finalizing the disc.

During finalization:

- If the finalization process is going to take more than around 4 minutes, you can press **ENTER** to cancel. Around 4 minutes before completion, the option to cancel disappears.
- How long finalization takes depends on the type of disc, how much is recorded on the disc and the number of titles on the disc. A disc recorded in VR mode can take up to 1 hour to finalize. A disc recorded in Video mode can take up to 20 minutes.

Initializing a DVD-RW disc

DVD-RW

When you first load a blank disc, the recorder will initialize it automatically for recording. You can also manually initialize DVD-RW discs.

You can initialize a disc for either Video mode recording or VR mode recording.

Important

- Initializing a disc will erase everything recorded on it. Make sure there is nothing on the disc that you want to keep!
- You may not be able to re-initialize a disc in a different format if it was originally initialized on an older DVD recorder.

- 1 Press **HOME MENU** and select **'Disc Setup'**.
- 2 Select **'Initialize'**

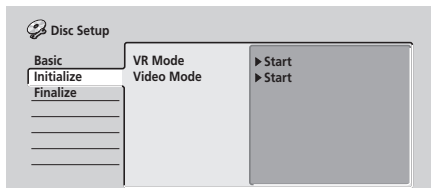

- 3 Select **'Video Mode'** or **'VR Mode'** from the initialize options.

- 4 Select **'Start'**.

It takes about 40 seconds to initialize the disc.

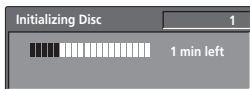

Note

- By default, the recorder initializes blank DVD-RW discs for VR mode recording. See *DVD-RW Auto Init.* on page 83 if you want to change the default to Video mode.
- If a disc was previously finalized on an older DVD recorder, you may not be able to re-initialize and/or initialize it for Video mode recording.

Chapter 7

Editing

Using the Disc Navigator you can edit video content on unfinalized Video mode and VR mode DVD discs. The editing features available in the Disc Navigator depend on whether you are editing video on a Video mode or VR mode DVD, and whether you're editing Original content, or a Play List.

With unfinalized Video mode DVDs, there are a limited number of editing commands, including naming, locking and erasing titles. Once a Video mode disc has been finalized, further editing is not possible. You can still use the Disc Navigator to select titles for playback, however (see *Using the Disc Navigator to browse the contents of a disc*, on page 33).

There are two ways to edit VR mode DVD-RW discs. You can directly edit the Original content of the disc, or you can create and edit a Play List. The Play List doesn't actually change any of the content on the disc, but just controls how the content is played back (rather like the program play feature found on CD players).

The Disc Navigator screen

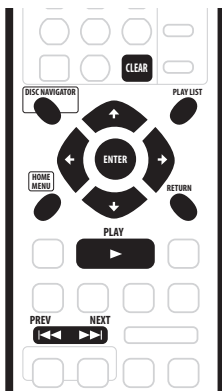
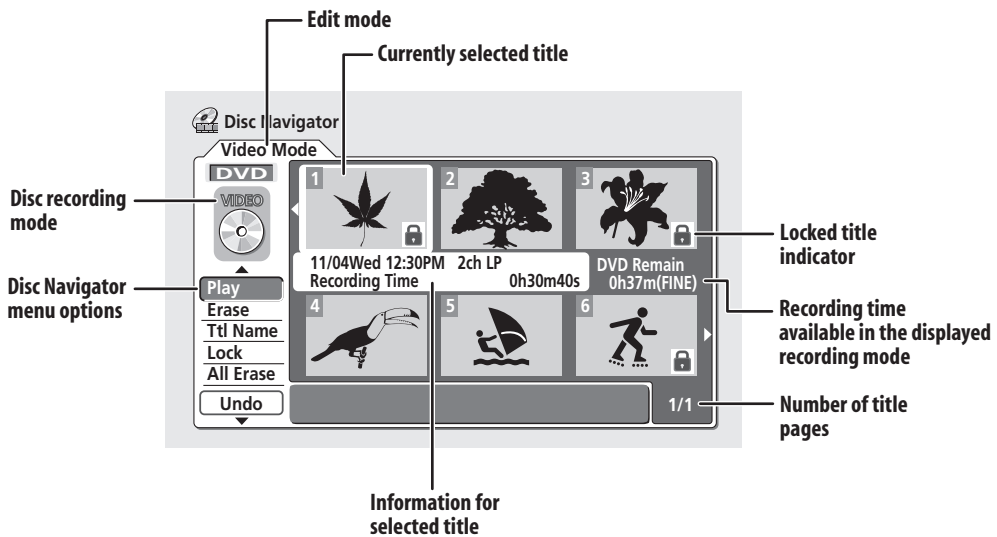

1 Press DISC NAVIGATOR to display the Disc Navigator screen.

Playback will automatically stop when you do this.

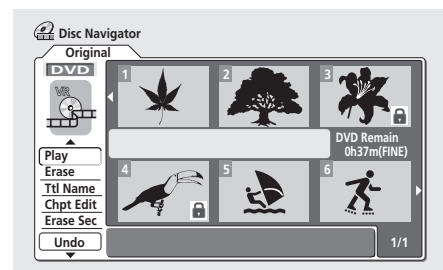

- You can also access the Disc Navigator from the Home Menu (press **HOME MENU**, select **Disc Navigator** then press **ENTER**).
- Use the **↑/↓** (cursor up/down) buttons to highlight the command you want from the menu options on the left, then press **ENTER**. Most commands require you then to select a title (or chapter) or location from the thumbnail views area of the screen. Use the **↑/↓/←/→** (cursor buttons) followed by **ENTER** to do this.
- When in the thumbnails area of the screen, use the **PREV** (◀◀) and **NEXT** (▶▶) buttons to display the previous/next page if there are more than six titles/chapters.
- As you highlight different thumbnails, information about the title/chapter is shown in the central area of the screen. Press **DISPLAY** to change the information displayed.
- If you are editing a VR mode disc, press **PLAYLIST** to switch between Original and Play List Disc Navigator screens.

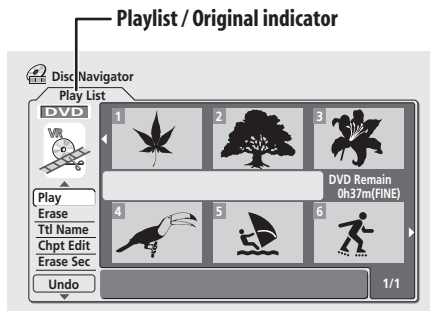

- Press **RETURN** to get back to the menu options on the left from the thumbnail area of the Disc Navigator.
- 2 To exit the Disc Navigator, press HOME MENU.**

Remember

- You can change the thumbnail pictures used for titles using the **NAVI MARK** button—see *Changing the thumbnail picture for a title* on page 34.

Disc Navigator menu options

The commands available from the Disc Navigator for different disc types is shown below.

Video mode

- **Play** – Play a title (page 58)
- **Title Name (Ttl Name)** – Name or rename a title (page 58)
- **Lock/Unlock** – Lock or unlock a title to prevent accidental changes being made (page 61)
- **Erase** – Erase a title (page 58)
- **Erase All** – Erase all titles (page 61)
- **Undo** – Undo the last change (page 61)

VR mode (Original)

- **Play** – Play a title (page 58)
- **Title Name (Ttl Name)** – Name or rename a title (page 58)
- **Lock/Unlock** – Lock or unlock a title to prevent accidental changes being made (page 61)
- **Erase** – Erase a title (page 58)
- **Erase All** – Erase all titles (page 61)
- **Undo** – Undo the last change (page 61)
- **Chapter Edit (Chpt Edit)** – Make detailed changes to chapters in a title (page 59)
- **Erase Section (Erase Sec)** – Erase a part of a title (page 60)

VR mode (Play List)

- **Create** – Make a new Play List title (page 62)
- **Chapter Edit (Chpt Edit)** – Make detailed changes to chapters in a Play List title (page 63)
- **Move** – Move the position of a title in the Play List (page 65)
- **Erase All** – Erase all titles in the Play List (page 65)
- **Undo** – Undo the last change (page 61)
- **Play** – Play a title (page 62)
- **Erase** – Erase a title from the Play List (page 62)
- **Title Name (Ttl Name)** – Name or rename a title in the Play List (page 62)
- **Combine** – Combine two Play List titles into one (page 65)
- **Divide** – Divide a Play List title into two (page 65)
- **Erase Section (Erase Sec)** – Erase a part of a title (page 64)

Editing VR mode Original and Video mode content

These commands affect the actual content stored on the DVD-R/RW.

Remember

- If you are editing a VR mode disc, use the **PLAYLIST** button to switch to the Disc Navigator Original screen.

Play

VR mode **Video mode**

Use this function to start playback of a title.

- 1 Select 'Play' from the Disc Navigator menu options.
- 2 Use the $\uparrow/\downarrow/\leftarrow/\rightarrow$ (cursor buttons) to select the title you want to play, then press **ENTER** or **▶ PLAY**.

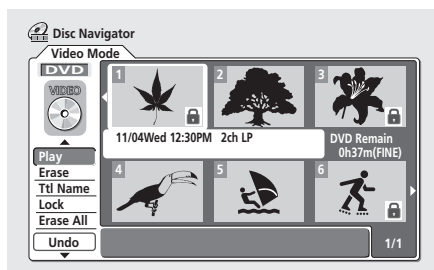

Playback of the title you selected starts.

Tip

- You can also use the front panel controls for the Play function: Press **DISC NAVIGATOR**, then use the **+/-** buttons to select a title. Press **▶ PLAY** to start playback.

Erase

VR mode **Video mode**

The Erase title command does slightly different things depending on what you are currently editing. If you are editing Original content on a VR mode disc the title will be erased from the disc and the available recording time will increase accordingly.

If you erase titles from a Video mode DVD-R disc, the title will disappear from the list of titles, but the available recording time will not increase. Erasing a title from a Video mode DVD-RW disc increases the available recording time only if it is the last title on the disc.

- 1 Select 'Erase' from the Disc Navigator menu options.
- 2 Use the $\uparrow/\downarrow/\leftarrow/\rightarrow$ (cursor buttons) to select the title you want to erase, then press **ENTER**.

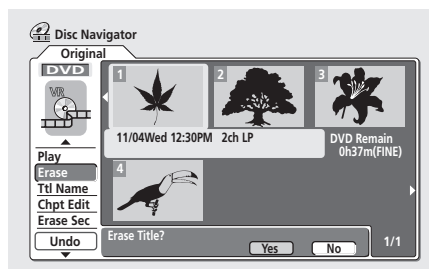

- 3 Highlight 'Yes' to confirm, or 'No' to cancel, then press **ENTER**.
- 4 Press **RETURN** to go back to the Disc Navigator menu options, or select another title to erase.

Tip

- You can erase a title quickly by pressing **CLEAR** when the title is highlighted. Confirm the edit by pressing **ENTER**. (You can also use this method to erase titles when using the *Play* function, above.)

Title Name (Ttl Name)

VR mode **Video mode**

You can give titles new names of up to 64 characters long for VR mode recordings and 32 characters for Video mode recordings.

- 1 Select 'Ttl Name' from the Disc Navigator menu options.
- 2 Use the $\uparrow/\downarrow/\leftarrow/\rightarrow$ (cursor buttons) to select the title you want to name, then press **ENTER** to go to the name input screen.
- 3 Input a name for the selected title.

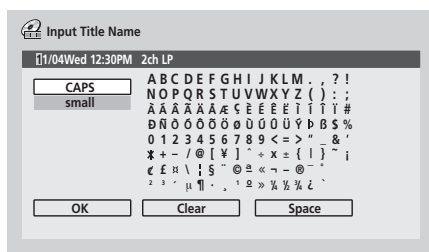

- Use the $\uparrow/\downarrow/\leftarrow/\rightarrow$ (cursor buttons) and **ENTER** to select characters.

- A name generated automatically by the recorder will already be in the name input section of the screen. Use the ◀/▶ buttons to change the cursor position.
- Select **CAPS** or **small** to change to upper or lower-case, or use the **CASE SELECTION** buttons (◀◀/▶▶).
- You can also use the **CLEAR** button to delete characters directly (press and hold for 2 seconds to delete the whole name). For other remote control key shortcuts, see *Using the remote key shortcuts to input a name* below.
- For discs formatted on a different DVD recorder, you will see only a limited character set.

4 Highlight 'OK' then press ENTER to enter the name and return to the main Disc Navigator screen.

- To return to the main Disc Navigator screen without saving changes to the title name, press **RETURN**.

5 Press RETURN to go back to the Disc Navigator menu options, or select another title to name.

Using the remote key shortcuts to input a name

The table below shows the remote control key shortcuts that you can use to input characters in the name input screen. Pressing a button repeatedly cycles through the characters shown.

If you want to enter two characters in succession that are both on the same button (for example a **P** and an **R**), press ▶▶ to advance the cursor one space manually between inputting the two characters.

Key	Characters	Key	Characters
1	, ' ? ! - & 1	6	m n o 6 ö ð ò ó ñ
2	a b c 2 ä å á â ã æ ç	7	p q r s 7 \$ ÿ / ß * ^{*1}
3	d e f 3 è é ê ë	8	t u v 8 ù ú û ü
4	g h i 4 î ï ð	9	w x y z 9
5	j k l 5 £	0	0
◀◀	[cursor back]	▶▶	[cursor forward]
◀◀/▶▶	[change case]	CLEAR	[clear character]
	<space>	■	[finish name input]
VCR Plus+	~ () _ / ; : " ' ^ @ # * % ¥ + = { } [] < >		

*1 lower-case: ÿ; upper-case: ß

Chapter Edit (Chpt Edit)

VR mode

When editing VR mode DVDs you can edit individual chapters within a title, with commands for erasing, combining and dividing. You can also play individual chapters to check their content.

1 Select 'Chpt Edit' from the Disc Navigator menu options.

2 Use the ↑/↓/←/→ (cursor buttons) to select the title that contains the chapters you want to edit, then press ENTER.

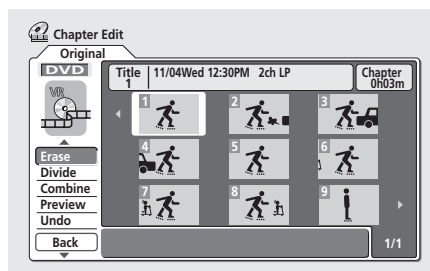

After selecting a title, thumbnails of each chapter appear and you'll see that the Disc Navigator menu items change to the chapter editing commands:

- **Erase** – Erase chapters: Select the chapter you want to erase and press **ENTER** (see also the note below).
- **Divide** – Divide a chapter into two or more parts: Select the chapter you want to divide. From the following screen use the playback controls (▶, ||, ◀◀, ▶▶, etc) to find the point at which you want to divide the chapter. With **Divide** highlighted, press **ENTER**.

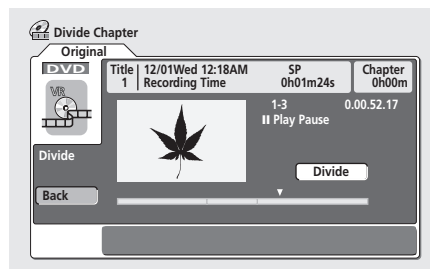

You can keep dividing the chapter as many times as you wish (up to 999 chapters per disc). Highlight **Exit** and press **ENTER** to return to the Chapter Edit screen.

- **Combine** – Combine two adjacent chapters into one: Highlight the bar divider between two adjacent chapters and press **ENTER** (see also the note below)

- **Preview** – Preview chapters: Select the chapter you want to play; press ■ **STOP** to return to the chapter edit screen.
- **Undo** – Undo the last command (only works with VR mode disc edits).

3 Press RETURN to get back to the menu options on the left side of the screen.

4 To return to the Disc Navigator screen, press RETURN again, or select 'Back' from the menu options on the left.

Note

- It may not be possible to erase chapters less than 5 seconds long.
- It may not always be possible to combine two chapters, even though they are adjacent. If a chapter has been divided into three, then the middle chapter erased, it is not possible to combine the two remaining chapters into one.

Erase Section (Erase Sec)

VR mode

Using this command you can delete a part of an Original title, ideal for cutting out the commercial breaks in a recording made from the TV.

1 Select 'Erase Sec' from the Disc Navigator menu options.

2 Use the ↑/↓/←/→ (cursor buttons) to select a title.

After selecting a title, the Erase Sec screen appears from which you can mark the start and end points of the section to erase.

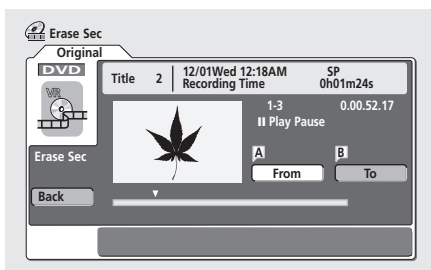

3 Use the playback controls (▶, II, ◀◀, ▶▶, etc) to find the start of the section to erase, then (with 'From' highlighted) press ENTER.

The bar at the bottom of the screen shows the current play position in the title. After pressing **ENTER**, a marker appears under the bar to show the start of the section.



4 In the same way, find the end of the section to erase, then (with 'To' highlighted) press ENTER.

After pressing **ENTER**, another marker appears under the bar to show the end of the section, with the section itself marked in red.

5 Select 'Yes' to confirm, or 'No' to cancel, then press ENTER.

- You may not be able to erase very short sections (less than five seconds).

6 Erase another section from the same title, or press RETURN to get back to the main Disc Navigator screen.

Inserting chapter markers into a title

VR mode

You can create new chapters within a title using the **CHP MARK** button while playing the title or during recording. This is useful not just for navigation of the disc content but also for editing purposes.

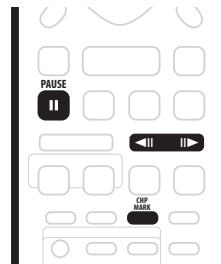

1 Start playback of the title you want to create new chapter markers in.

You can use the **Play** command from the Disc Navigator menu to do this.

2 Press **CHP MARK** at any point where you want a new chapter to begin.

A chapter marker icon appears on-screen briefly to confirm a new chapter marker has been inserted:



- For greater control over the exact position of chapter markers it can be useful to use the **II PAUSE** button and/or the slow-motion and frame advance/reverse controls (**◀II/II▶**).

Note

- You cannot insert chapter markers during Auto Start Recording.
- If you pause a recording in VR mode, the recorder automatically starts a new chapter when you restart the recording.
- When recording in Video mode, the recorder automatically puts chapter markers in at regular intervals. It is not possible to add extra chapter markers manually after recording (see also *Auto Chapter (Video)* on page 83).
- When recording in VR mode, the recorder automatically puts chapter markers in when the audio format changes.
- The Play List and Original content on a disc can each contain up to 999 chapters.

Lock / Unlock

VR mode **Video mode**

You can lock a title so that it can't be edited or erased accidentally. If you do need to edit it, you can always unlock it later.

Important

- You can't undo any edits made before changing the lock status. You also can't undo a lock/unlock command using the **Undo** option from the Disc Navigator menu.

1 Select '**Lock**' from the Disc Navigator menu options.

2 Use the **↑/↓/←/→** (cursor buttons) to select the title you want to lock (or unlock), then press **ENTER**.

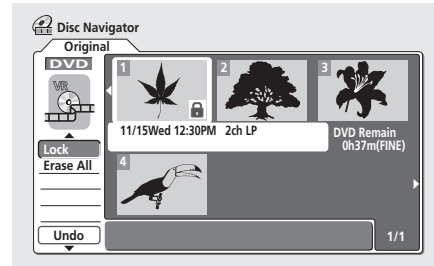

An unlocked title will become locked; a locked title will be unlocked. Locked titles are shown in the Disc Navigator with a padlock icon.

3 Press **RETURN** to go back to the Disc Navigator menu options, or select another title to lock/unlock.

Erase All

VR mode **Video mode**

This erases all unlocked titles from the disc (see also *Lock / Unlock* above).

1 Select '**Erase All**' from the Disc Navigator menu options.

2 Select '**Yes**' to confirm, or '**No**' to cancel, then press **ENTER**.

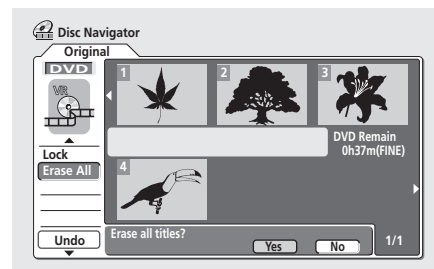

Undo

VR mode **Video mode**

If you make a mistake while editing, you can generally undo it. There are three levels of undo (in other words, you can undo the last three edits you made).

• Select '**Undo**' from the Disc Navigator menu options.

- You can't undo anything after exiting the Disc Navigator screen.

Creating and editing a VR mode Play List

VR mode

A Play List is a kind of virtual content based on the actual (Original) content of the disc. The main advantages of this type of editing is that it is non-destructive of the video content on the disc, and it allows greater control over editing, so that you end up with the content exactly as you want it.

Remember

- Use the **PLAYLIST** button to switch to the Play List edit screen.
- The Play List can contain a maximum of 99 titles.

Play

VR mode

Use this function to start playback of a title.

- 1 Select 'Play' from the Disc Navigator Play List menu options.
- 2 Select the title you want to play, then press ENTER.

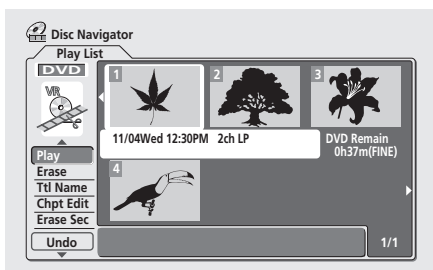

Playback of the title you selected starts.

Tip

- You can also use the front panel controls for the Play function: Press **DISC NAVIGATOR**, then use the + / - buttons to select a title. Press **▶ PLAY** to start playback.

Erase

VR mode

This command erases a title only from the Play List. The title remains in the Original content and the available recording time does not increase.

- 1 Select 'Erase' from the Disc Navigator Play List menu options.
- 2 Select the title you want to erase, then press ENTER.

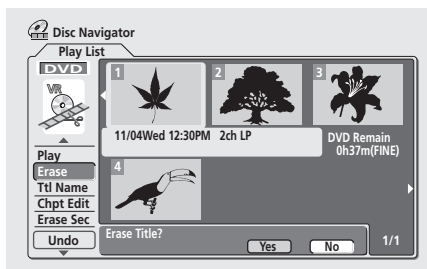

- 3 Highlight 'Yes' to confirm, or 'No' to cancel, then press ENTER.
- 4 Press RETURN to go back to the Disc Navigator menu options, or select another title to erase.

Note

- The remaining recording time doesn't change when you erase something from the Play List.

Title Name (Ttl Name)

VR mode

You can give titles new names of up to 64 characters long.

- 1 Select 'Ttl Name' from the Disc Navigator Play List menu options.
- 2 Select the title you want to name, then press ENTER.
- 3 Input a name for the selected title.

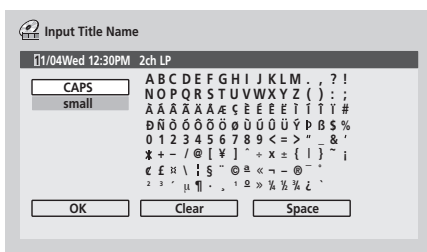

Press **ENTER** after selecting each character.

- A name generated automatically by the recorder will already be in the name input section of the screen. Use the ◀/▶ buttons to change the cursor position.
- Select **CAPS** or **small** to change to upper or lower-case, or use the **CASE SELECTION** buttons (I◀/▶I).
- You can also use the **CLEAR** button to delete characters directly (press and hold for 2 seconds to delete the whole name). For other remote control key shortcuts, see *Using the remote key shortcuts to input a name* on page 59.
- For discs formatted on a different DVD recorder, you will see only a limited character set.

4 Highlight 'OK', then press ENTER to fix the name and return to the main Disc Navigator screen.

- To return to the main Disc Navigator screen without saving changes to the title name, press **RETURN**.

5 Press RETURN to go back to the Disc Navigator menu options, or select another title to name.

Chapter Edit (Chpt Edit)

VR mode

When editing VR mode DVDs you can edit individual chapters within a title, with commands for erasing, moving, combining and dividing. You can also play individual chapters to check their content.

1 Select 'Chpt Edit' from the Disc Navigator Play List menu options.

2 Select the title that contains the chapters you want to edit, then press ENTER.

After selecting a title, thumbnails of each chapter appear and you'll see that the Disc Navigator menu items change to the chapter editing commands:

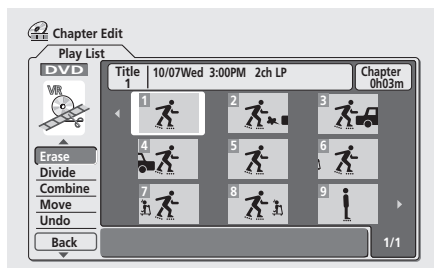

- **Erase** – Erase chapters: Select the chapter you want to erase and press **ENTER**.

- **Divide** – Divide a chapter into two or more parts: Select the chapter you want to divide. From the following screen use the playback controls (▶, ⏸, ◀, ▶, etc) to find the point at which you want to divide the chapter. With **Divide** highlighted, press **ENTER**.

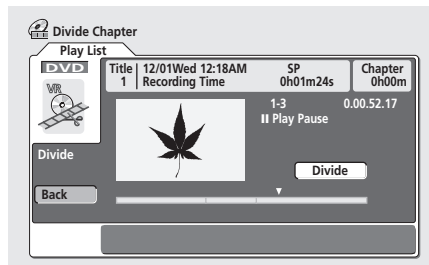

You can keep dividing the chapter as many times as you wish (up to 999 chapters per disc). Highlight **Exit** and press **ENTER** to return to the Chapter Edit screen.

- **Combine** – Combine two adjacent chapters into one: Select the dividing line between two adjacent chapters and press **ENTER**.

- **Move** – Rearrange chapters: Select the chapter you want to move, press **ENTER**, then highlight the new location for it, then press **ENTER** again.

- **Preview** – Preview chapters: Select the chapter you want to play; press ■ **STOP** to return to the chapter edit screen.

- **Undo** – Undo the last command.

3 Press RETURN to get back to the menu options on the left side of the screen.

4 To return to the Disc Navigator screen, press RETURN again, or select 'Back' from the menu options on the left.

Erase Section (Erase Sec)

VR mode

Using this command you can delete a part of a Play List title, ideal for cutting out the commercial breaks in a recording made from the TV.

1 Select 'Erase Sec' from the Disc Navigator menu options.

2 Use the $\uparrow/\downarrow/\leftarrow/\rightarrow$ (cursor buttons) to select a title.

After selecting a title, the Erase Sec screen appears from which you can mark the start and end points of the section to erase.

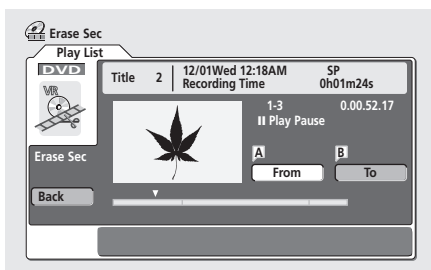

3 Use the playback controls (\blacktriangleright , \parallel , \blacktriangleleft , \blacktriangleright , etc) to find the start of the section to erase, then (with 'From' highlighted) press ENTER.

The bar at the bottom of the screen shows the current play position in the title. After pressing **ENTER**, a marker appears under the bar to show the start of the section.



4 In the same way, find the end of the section to erase, then (with 'To' highlighted) press ENTER.

After pressing **ENTER**, another marker appears under the bar to show the end of the section, with the section itself marked in red.

5 Select 'Yes' to confirm, or 'No' to cancel, then press ENTER.

- You may not be able to erase very short sections (less than five seconds).

6 Erase another section from the same title, or press RETURN to get back to the main Disc Navigator screen.

Create

VR mode

Use this function to add an Original title to the Play List. When you do this, the whole title is put into the Play List (you can erase bits you don't need later—see *Chapter Edit (Chpt Edit)* on page 63).

The title appears in the Play List complete with the chapter markers that appear in the Original. However, if you add more chapter markers to the Original later, these are not automatically copied over into the Play List title.

You can add up to 99 titles to the Play List.

1 Select 'Create' from the Disc Navigator Play List menu options.

2 Use the $\uparrow/\downarrow/\leftarrow/\rightarrow$ (cursor buttons) to select the insertion point for the new title, then press ENTER.

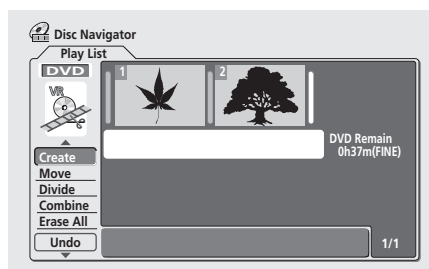

If there are no titles in the Play List yet, this step does not apply.

3 Use the $\uparrow/\downarrow/\leftarrow/\rightarrow$ (cursor buttons) to select an Original title to put into the Play List.

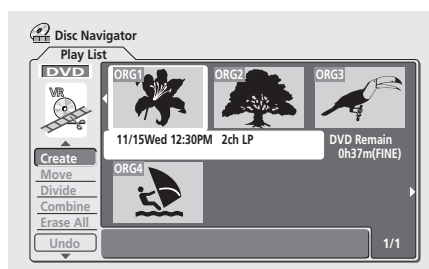

4 Press ENTER to add the title.

The new title appears in the updated Play List.

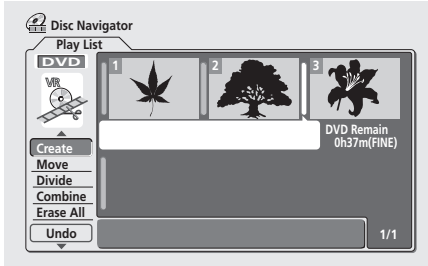

5 Press RETURN to go back to the Disc Navigator menu options, or select another location for a new title.

Move

VR mode

Use this function to re-arrange the playing order of Play List titles.

- 1 Select 'Move' from the Disc Navigator Play List menu options.
- 2 Select the title you want to move, then press ENTER.

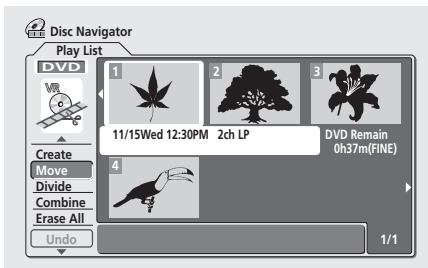

3 Select a new position in the Play List for the title, then press ENTER.

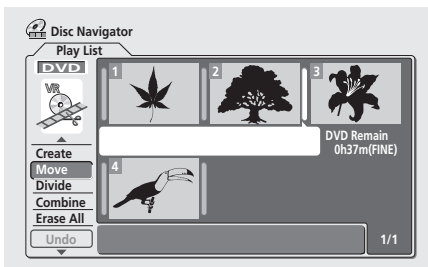

After pressing ENTER, the new, updated Play List is displayed.

4 Press RETURN to go back to the Disc Navigator menu options, or select another title to move.

Divide

VR mode

Use this command to split a title up into two new titles.

- 1 Select 'Divide' from the Disc Navigator Play List menu options.
- 2 Select the title that you want to divide, then press ENTER.
- 3 Use the playback controls (▶, II, ◀◀, ▶▶, etc) to find the place you want to divide the title.

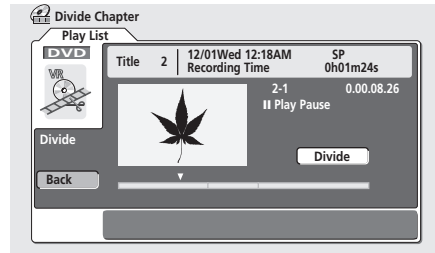

4 With 'Divide' highlighted, press ENTER to divide the title at the current playback position.

After pressing ENTER, the main Disc Navigator Play List screen is displayed, updated with the new title.

5 Press RETURN to go back to the Disc Navigator menu options or select another title to divide.

Combine

VR mode

Use this function to combine two adjacent Play List titles into one.

- 1 Select 'Combine' from the Disc Navigator Play List menu options.
- 2 Highlight the bar divider between the two titles you want to combine, then press ENTER.

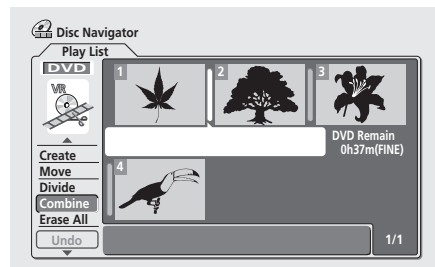

After pressing **ENTER**, the new, updated Play List is displayed.

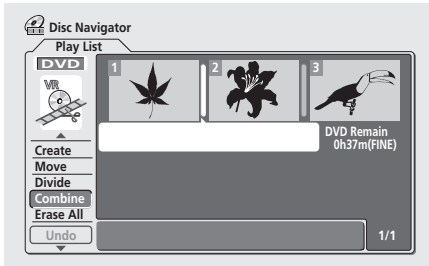

3 Press **RETURN** to go back to the Disc Navigator menu options, or continue combining more titles.

Erase All

VR mode

This command erases all the titles from the Play List.

- 1** Select 'Erase All' from the Disc Navigator Play List menu options.
- 2** Select 'Yes' to confirm, or 'No' to cancel, then press **ENTER**.

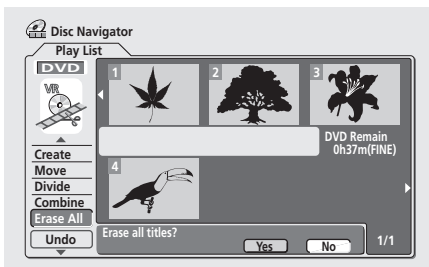

Undo

VR mode

If you make a mistake while editing, you can generally undo it. There are three levels of undo (in other words, you can undo the last three edits you made).

- **Select 'Undo' from the Disc Navigator Play List menu options.**
 - You can't undo anything after exiting the Disc Navigator screen.

Chapter 8

Disc History

VR mode Video mode

The Disc History screen lets you see how much recording space remains on the last 30 recordable DVD discs loaded. It also displays information such as disc name, the first three title names, number of titles recorded, recording mode and the lock status of the disc.

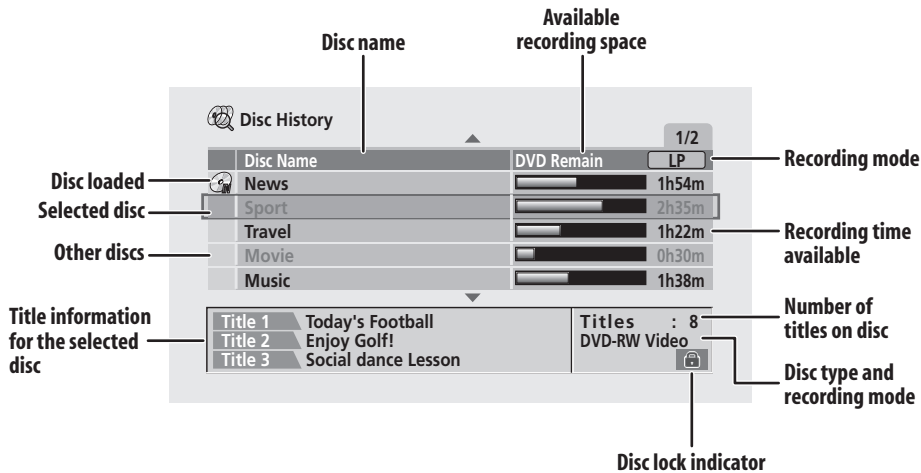

Using the Disc History

1 Press DISC HISTORY to display the Disc History screen.

The most recently loaded disc appears at the top of the list, with previously loaded discs below it. If there is a disc loaded, it is shown in the list with a 'disc in' icon.

- The Disc History screen is also accessible from the Home Menu.

2 Use the ↑/↓ (cursor up/down) buttons to see title information for other discs in the list.

- To remove a disc from the list, press **CLEAR** (you can't remove the currently loaded disc).
- You can see the available recording time for different recording modes by pressing the **REC MODE** button.

3 To exit the Disc History screen, press HOME MENU or DISC HISTORY.

Tip

- You can also use the front panel controls to view information in the Disc History screen: Press **DISC HISTORY**, then use the +/– buttons to move up and down the list.

Note

- When you initialize a DVD-RW disc or record a DVD-R disc for the first time, the recorder automatically names the disc **DISC **** (where ** is a number from 1 to 99). You can rename the disc if you want to (see *Input Disc Name* on page 70).
- When you change the display for the available recording time using the **REC MODE** button, only the display is changed; the actual recording mode is not affected.
- The following discs appear in the Disc History list in gray:
 - Discs with no available recording space left
 - Locked discs
 - Discs that contain the maximum 99 titles and/or 999 chapters
- When a Video mode disc is finalized, the information for that disc disappears from the Disc History.

Chapter 9

The PhotoViewer

From the PhotoViewer you can view JPEG photos and picture files stored on a CD-ROM/R/RW on your TV.

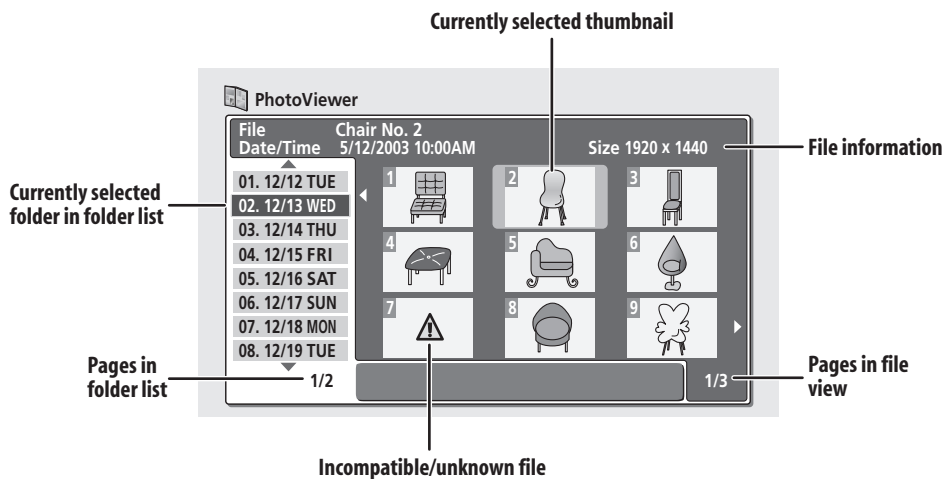

Playing a slideshow

1 Press HOME MENU and select 'PhotoViewer' to display the PhotoViewer screen.

- The PhotoViewer is only accessible when a disc containing JPEG files is loaded.

2 Use the ↑/↓ (cursor up/down) buttons to select a folder from the folder list.

The first nine images from the selected folder are displayed as thumbnails in the main part of the screen.

3 Press ENTER to move to the thumbnail view area. The first thumbnail image is highlighted.

- To get back to the folder list, press RETURN.

4 Use the ↑/↓/←/→ (cursor buttons) to select a thumbnail.

- Use the ◀◀ and ▶▶ buttons to display the previous/next page of thumbnails.

5 Press ENTER or ▶ PLAY to start playing a slideshow from the selected thumbnail.

- Use the ◀◀ PREV / NEXT ▶▶ buttons to display the previous/next picture, or the || PAUSE button to pause the slideshow.

6 Press ■ STOP to return to the thumbnail view area.

7 To return to the folder view area, press RETURN.

- To exit the PhotoViewer, press HOME MENU.

Note

- Up to 999 files or 99 folders are viewable, but if there are more files/folders than this on the disc it is still possible to view them all using the Reload function (see the following page).
- The time it takes for the recorder to load a file increases with large file sizes.
- Pictures with an aspect ratio different to your TV screen will appear with black bars top and bottom, or either side (depending on the picture).
- If you encounter a disc that will not play, check that the disc and file formats are compatible with this recorder (see *JPEG file compatibility* on page 11).

Reloading files from a disc

If you have a disc with a very large number of files and/or folders, you can still view all the images using the reload function.

- 1 Use the **↓** (cursor down) button to navigate to the last entry in the folder list ('Read next: ...').
- 2 Press **ENTER** to load the next batch of up to 999 files/99 folders from the disc.

It will take a moment (at most a minute) to load in the images.

Note

- You can press **HOME MENU** to exit the PhotoViewer screen while the recorder is reloading images. (If you enter the PhotoViewer again, it will resume reloading.)

Zooming the screen

During a slideshow you can zoom in to enlarge a portion of the picture by a factor of two or four. You can also move the area of the picture displayed.

- 1 During a slideshow, use the **CHANNEL +** button to zoom the picture.

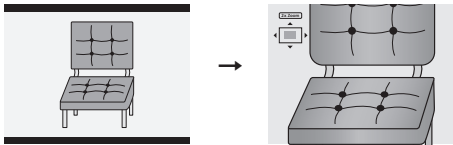

Repeated presses cycle between zoom off, 2x zoom and 4x zoom. The zoom factor is displayed on-screen.

- 2 Use the **↑/↓/←/→** (cursor buttons) to move the zoomed area within the picture.

Rotating the screen

You can rotate the displayed picture during a slideshow so you can always view pictures the right way up, whichever way they were taken.

- During a slideshow, press **ANGLE** to rotate the displayed picture clockwise by 90°.

Press **ANGLE** repeatedly to continue rotating the picture in increments of 90°.



Chapter 10

The Disc Setup menu

From the Disc Setup menu you can name discs, lock the contents to prevent accidental recording and erasure, initialize and finalize discs. The Disc Setup menu is accessed from the Home menu:

- Press **HOME MENU** and select 'Disc Setup'.



DVR-320 screen

Basic settings

Input Disc Name

VR mode **Video mode**

When you initialize a disc for recording, the recorder automatically assigns a name for the disc ranging from **DISC 1** to **DISC 99**. You can use the Input Disc Name function to change the default disc name to something more descriptive. This name appears when you load the disc and when you display disc information on-screen.

- 1 Select 'Input Disc Name' from the Basic options, then 'Next Screen'.

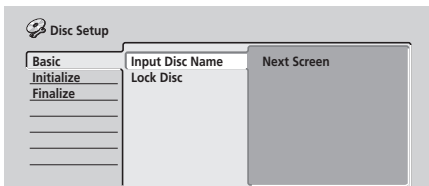

- 2 Input a name for the disc up to 64 characters long for a VR mode disc, or 32 for a Video mode disc.

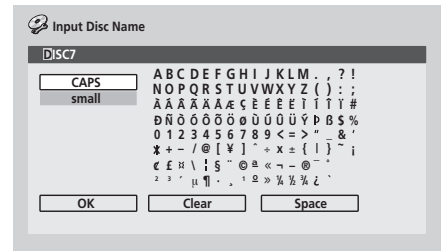

- Use the **↑/↓/←/→** (cursor buttons) and **ENTER** to select characters.
- Use the **◀◀/▶▶** buttons to change the cursor position.
- Select **CAPS** or **small** to change to upper or lower-case, or use the **CASE SELECTION** buttons (**⏪/▶▶**).
- You can also use the **CLEAR** button to delete characters directly (press and hold for 2 seconds to delete the whole name). For other remote control key shortcuts, see *Using the remote key shortcuts to input a name* on page 59.
- For discs formatted on a different DVD recorder, you will see only a limited character set.

Lock Disc

VR mode

- Default setting: **Off**

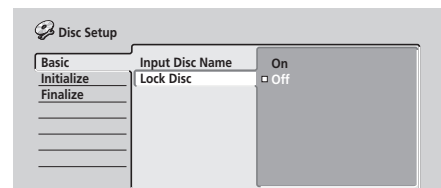

Set to **On** to prevent accidental recording, editing or erasing of the disc loaded. If you need to unlock the disc to make edits, select **Off**.

Important

- A locked disc can still be initialized (which will completely erase the disc).

Initialize settings

DVD-RW

You can initialize a DVD-RW disc for either VR mode recording or Video mode recording. The first time you load a new DVD-RW disc, it will be automatically initialized for recording according to the DVD-RW Auto Init. setting in the Initial Setup menu (see page 83).

The initialize menu here lets you reinitialize a disc, for example if you want to change the recording format of the disc. See *Initializing a DVD-RW disc* on page 55 for detailed instructions.

Finalize settings

Finalize

DVD-R DVD-RW

Finalizing 'fixes' the recordings in place so that the disc can be played on a regular DVD player or computer equipped with a suitable DVD-ROM drive.

See *Playing your recordings on other DVD players* on page 54 for detailed instructions.

Undo Finalize

DVD-RW

You can undo the finalization on DVD-RW discs recorded on this recorder in Video mode. You need to do this if you want to record more material or edit material already on the disc.

You can also undo the finalization of VR mode discs which have been finalized on other DVD recorders. If when you load a disc the message **This disc cannot be recorded. Undo the finalization** is displayed, use this command to be able to record on the disc using this recorder.

- 1 From the Disc Setup menu, select 'Finalize', then 'Undo Finalize' from the finalize options.
- 2 Select 'Start'.

Chapter 11

The Video/Audio Adjust menu

Using the Video/Audio Adjust menu you can set up the picture quality for the built-in tuner and external inputs, for disc playback, and for recording.

Setting the picture quality for TV and external inputs

Picture Creation lets you choose a set of picture quality settings for the built-in TV tuner and for each external input. There are several preset settings that suit various sources, or you can create up to three of your own sets.

Choosing a preset

- 1 With the recorder stopped, press HOME MENU and select 'Video/Audio Adjust'.



DVR-320 screen

- 2 Select 'Video Adjust'.
- 3 Use the ←/→ (cursor left/right) buttons to change the preset.

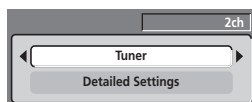

- Use the **INPUT SELECT** button to switch between the built-in TV tuner and the external inputs.
- Use the **CHANNEL +/-** buttons to change the channel of the built-in TV tuner.

There are 6 presets available:

- **Tuner** – suitable for general TV broadcasts
- **VCR** – suitable for video cassettes
- **LDP** – suitable for Laserdiscs
- **Memory1** – user preset 1
- **Memory2** – user preset 2
- **Memory3** – user preset 3

You can press **DISPLAY** to see the individual settings for the current preset (**Tuner**, **VCR** or **LDP**).

- 4 Press **ENTER** to select the preset.

Creating your own set

There are three user presets in which you can save your own set of picture quality settings.

- 1 Follow *Choosing a preset* above and select one of the user presets (**Memory 1, 2 or 3**).
- 2 Select 'Detailed Settings'.

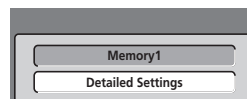

- 3 Use the ↑/↓ (cursor up/down) buttons to select the picture quality setting you want to adjust.

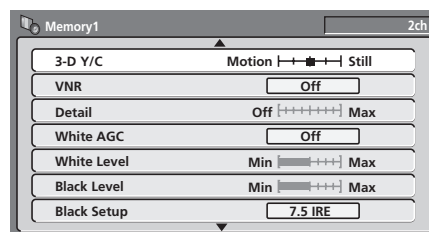

You can adjust the following settings:

- **3-D Y/C** – Adjusts the brightness/color separation.
- **VNR** – Adjusts the amount of noise reduction applied to the video signal.
- **Detail** – Adjusts how sharp edges appear.
- **White AGC** – Turn on for automatic white level adjustment.
- **White Level** – Adjusts the intensity of white.
- **Black Level** – Adjusts the intensity of black.
- **Black Setup** – Corrects the standard reference black level.
- **Hue** – Adjusts overall balance between red and green.
- **Chroma Level** – Adjusts how rich the colors appear.

4 Use the **←/→** (cursor left/right) buttons to adjust the currently selected picture quality setting.

5 When you have all the settings as you want them, press **HOME MENU** to exit.

You can now use the preset for any other input or the built-in TV tuner.



Tip

- To see more of the picture as you adjust different settings, press **ENTER** after selecting the setting you want to adjust.



Note

- **DVR-320 only:** When the DV input is selected, only **VNR** and **Detail** settings can be adjusted.
- When **White AGC** is **On**, the **White Level** setting can't be adjusted.

Setting the picture quality for disc playback

This setting determines how the picture will look when playing discs.

Choosing a preset

1 With a disc playing (or paused), press **HOME MENU** and select 'Video/Audio Adjust'.

2 Select 'Video Adjust'

3 Use the **←/→** (cursor left/right) buttons to change the setting.

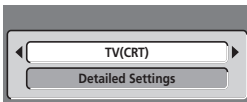

There are 6 presets available:

- **TV(CRT)** – suitable for standard cathode-ray tube TVs
- **PDP** – suitable for plasma display screens
- **Professional** – suitable for professional monitors
- **Memory1** – user preset 1
- **Memory2** – user preset 2
- **Memory3** – user preset 3

You can press **DISPLAY** to see the individual settings for the current preset (**TV(CRT)**, **PDP** or **Professional**).

4 Press **ENTER** to select the preset.

Creating your own set

There are three user presets in which you can save your own set of picture quality settings for disc playback.

1 Follow *Choosing a preset* above and select one of the user presets (**Memory 1, 2 or 3**).

2 Move the cursor down and select 'Detailed Settings'.

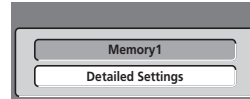

3 Select the picture quality setting you want to adjust.

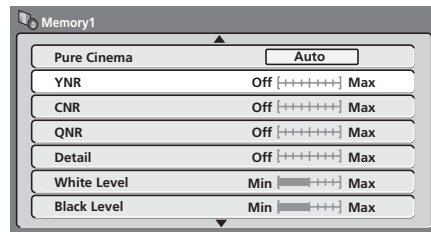

You can adjust the following settings:

- **Pure Cinema** – When watching DVD movies, Pure Cinema optimizes the picture quality. If the picture appears unnatural on the default **Auto** setting, change to **On** or **Off** as desired. (Note that this setting can only be adjusted when the video output is set to progressive.)
See also *PureCinema* in the Glossary on page 98.
- **YNR** – Adjusts the amount of noise reduction (NR) applied to the Y (brightness) component (has no effect when the video output is set to progressive).
- **CNR** – Adjusts the amount of noise reduction (NR) applied to the C (color) component (has no effect when the video output is set to progressive).
- **QNR** – Adjusts the amount of noise reduction (NR) applied to the block noise.
- **Detail** – Adjusts how sharp edges appear.
- **White Level** – Adjusts the intensity of white.
- **Black Level** – Adjusts the intensity of black.
- **Black Setup** – Corrects the standard reference black level.
- **Hue** – Adjusts overall balance between red and green.
- **Chroma Level** – Adjusts how rich the colors appear.

4 Use the **←/→** (cursor left/right) buttons to adjust the currently selected picture quality setting.

5 When you have all the settings as you want them, press **HOME MENU** to exit.



Tip

- To see more of the picture as you adjust different settings, press **ENTER** after selecting the setting you want to adjust.

Audio DRC

- Default setting: **Off**

When watching Dolby Digital material at low volume, it's easy to lose low level sounds completely—including some of the dialog. Switching on Audio DRC (Dynamic Range Control) can help by bringing up the low level sounds, while controlling high level peaks.

- 1 During playback or when paused, press **HOME MENU** and select 'Video/Audio Adjust'.
- 2 Select 'Audio Adjust'.
- 3 Use the **←/→** (cursor left/right) buttons to adjust DRC from 'Off' to 'Max'.

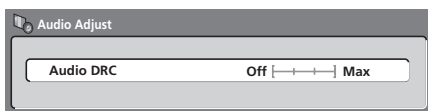

Exactly how much difference you can hear between the settings will depend on the material.



Remember

- Audio DRC is not effective when listening to a disc via the digital output when **Dolby Digital Out** is set to **Dolby Digital**. In this case adjust the dynamic range from your AV amplifier/receiver.

Chapter 12

The Initial Setup menu

Using the Initial Setup menu

The Initial Setup menu is where you can set various recorder options for sound, picture, language and so on.

- Press **HOME MENU** and select 'Initial Setup'.



DVR-320 screen

- Some settings can only be changed when the recorder is stopped. During playback these settings are grayed out in the Initial Setup menu.
- Except for the Setup Navigator, menu screens are exited automatically after 20 minutes of inactivity.

Basic settings

Clock Setting

The date (month, day, year) and time must be set before you can use any of the timer recording features.

The clock can be set automatically if there is a broadcast station transmitting clock signals, or manually.

Select **Auto** to set the clock automatically or **Manual** to display the clock setting screen.

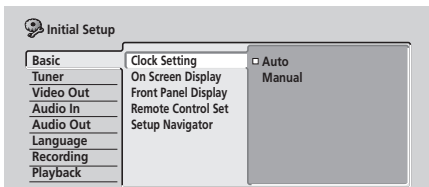

- **Auto clock setting**
Some TV channels broadcast time signals together with the program. This recorder can use these signals to set the clock automatically.

Set 'Clock Set CH' to the channel preset number that broadcasts a clock signal, then move the cursor down to 'Start' and press **ENTER**.

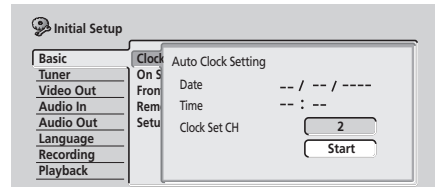

If the time could not be set automatically, press **RETURN** to go back to the previous screen and select **Manual**.

- **Manual clock setting**
If no stations in your area are broadcasting time signals, you can set the clock manually:
- Use the **←/→** (cursor left/right) buttons to set your time zone, then press **ENTER**.
- Press **↓** (cursor down) then use the **←/→** (cursor left/right) buttons to set daylight saving time (D.S.T.) **On** or **Off**, then press **ENTER**.

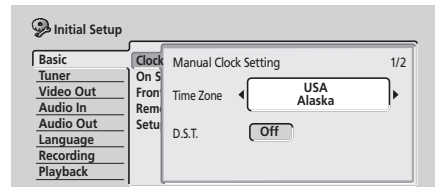

- Set the current date and time.

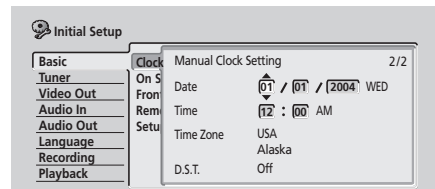

Use the **↑/↓** (cursor up/down) buttons to change the value in the highlighted field.

Use the **←/→** (cursor left/right) buttons to move from one field to another.

On Screen Display

- Default setting: **On**

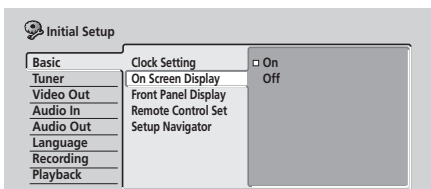

On the default setting, the recorder shows on-screen operation displays (**Play**, **Stop** and so on). Change to **Off** to hide these displays.

Front Panel Display

- Default setting: **On**

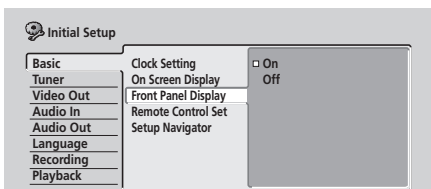

On the default setting, the time is shown in the front panel display when the recorder is in standby. Switch to **Off** to have the front panel display switch off completely when in standby.



Note

- When set to **Off**, the display still lights dimly in standby when setting a timer recording, or during Auto Start Recording.

Remote Control Set

- Default setting: **Recorder1**

You only need to set this if you are using more than one Pioneer DVD recorder in the same room.

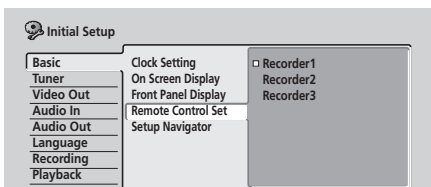

So that each remote control operates only its own recorder, make this setting different for each recorder and remote in the room.

There are three different recorder IDs. When set to **Recorder2** or **Recorder3**, the remote control mode is shown in the front panel display.

After selecting a new recorder ID, you have to confirm the change by selecting **Yes** or **No** (use the **←/→** (cursor left/right) buttons), then pressing **ENTER**.

Note that as soon as you change the recorder ID, the remote becomes inoperative until you change the remote to the same ID.

To set the remote, press and hold **RETURN** and a number button (**1**, **2** or **3**) until the indicator on the remote lights.

Setup Navigator

- Default setting: *n/a*

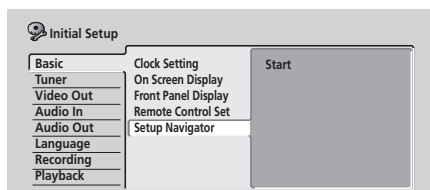

The Setup Navigator appears automatically when you switch on the recorder for the first time (or after resetting the recorder). It is also available from the Initial Settings menu should you need it at any other time.

See also *Switching on and setting up* on page 24.

Tuner settings

Auto Channel Setting

- Default setting: **Antenna**

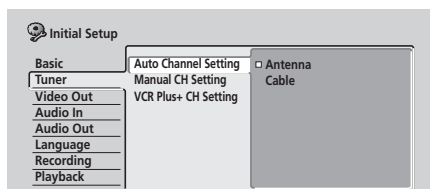

Auto Channel Setting automatically tunes the built-in TV tuner to terrestrial broadcast TV channels or cable channels. Select **Antenna** or **Cable**, depending on how you receive your TV channels, then wait for the automatic tuning to finish.

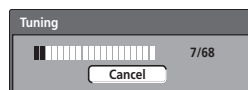

After automatic tuning, a summary channel mapping screen is displayed.

Initial Setup							
Channel Mapping Antenna							
CH	Skip	CH	Skip	CH	Skip	CH	Skip
2	Off	10	Off	18	Off	26	Off
3	Off	11	Off	19	Off	27	Off
4	Off	12	Off	20	Off	28	Off
5	Off	13	Off	21	Off	29	Off
6	Off	14	Off	22	Off	30	Off
7	Off	15	Off	23	Off	31	Off
8	Off	16	Off	24	Off	32	Off

Press **ENTER** to return to the main menu screen.

Note

- If you want to cancel before tuning has finished, press **ENTER**.
- You can manually tune and skip blank channels using the Manual CH Setting, below.

Manual CH Setting

- Default setting: *n/a*

The channel skip function lets you skip channels where there is no station so that as you change channels using the **CHANNEL +/-** buttons or the number buttons, you only change to channels that have a station.

The manual tuning function allows you to manually tune to stations, should you need to.

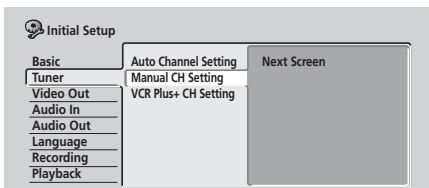

1 From the manual channel setting screen:

- Use the **CHANNEL +/-** button to change channels.
- If you want to skip the displayed channel (because there is no station assigned to that channel), change the **Skip** setting to **On**.
- If you want to manually tune the displayed channel, change the **AFT** (Auto Fine Tuning) setting to **Off**, then move down to **Level** to manually tune to a station.

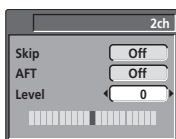

- To return to the Initial Setup menu, press **ENTER**.

VCR Plus+ CH Setting

- Default setting: *n/a*

Guide channels are used by the VCR Plus+ system so that the channel number specified in the VCR Plus+ programming numbers can be guaranteed to correspond to the correct station.

1 Select 'VCR Plus+ CH Setting', then 'Next Screen'.

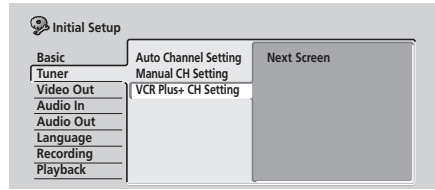

2 Assign channel numbers to the guide channels as necessary.

Look in your TV guide to see which channel numbers should be assigned to which guide channels.

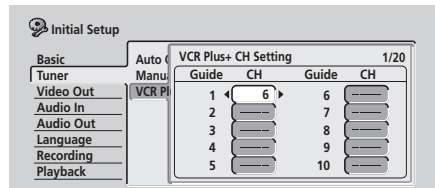

- Use the **↑/↓** (cursor up/down) buttons to change the guide channel for setting.
- Use the **←/→** (cursor left/right) buttons to change the channel number.
- Use the **PREV / NEXT** button to display the previous/next 10 guide channels.

3 To return to the Initial Setup menu, press **ENTER**.

Video Out settings

Component Video Out

- Default setting: **Interlace**

You only need to make this setting if you connected this recorder to your TV using the component video jacks.

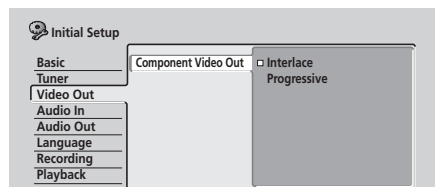

If your TV is compatible with progressive-scan component video, set this **Progressive** for the highest quality picture. If your TV is not compatible with progressive-scan video, leave it set to **Interlace**.

See also *Progressive scan video* in the glossary on page 98.

Important

If you switch to **Progressive** when using a TV that is not compatible with progressive-scan video, you will not be able to see anything displayed on your TV. If this happens, press and hold the **+** button on the front panel, then press **DISC HISTORY**. This will set the recorder's video output back to **Interlace**.

Compatibility of this unit with progressive-scan TVs

Consumers should note that not all high-definition television sets are fully compatible with this product and may cause artifacts to be displayed in the picture. In case of 525 progressive scan picture problems, it is recommended that the user switch the connection to the 'standard definition' output (**Interlace**). If there are questions regarding our TV set compatibility with this model, please contact our customer service center.

This recorder is compatible with the following Pioneer displays and monitors

Plasma display

- PDP-505HD, PDP-5030HD, PDP-4330HD, PDP-5040HD, PDP-4340HD, Pro-1000HD, Pro-800HD, Pro-1000HDI, Pro-800HDI, Pro-1110HD, Pro-910HD, PDP-4300, PDP-5031, PDP-502MX

Projection monitor receiver

- SD-641HD5, SD-582HD5, SD-532HD5, SD-533HD5, SD-643HD5, Pro-710HD, Pro-610HD, Pro-510HD, Pro-720HD, Pro-620HD, Pro-520HD, Pro-730HD, Pro-630HD, Pro-530HD, Pro-730HDI, Pro-530HDI, Pro-700HD

Audio In settings

External Audio

- Default setting: **Stereo**

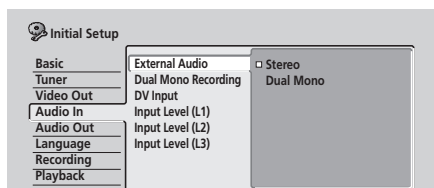

If the external source is standard stereo, leave set to **Stereo**. If each channel carries a separate soundtrack, change to **Dual Mono**.

DVR-320 only: When the external audio is from the DV input, an audio subcode channel within the DV audio tells the recorder whether the audio is stereo or dual mono. This has priority over the setting you make here.

Dual Mono Recording

- Default setting: **L**

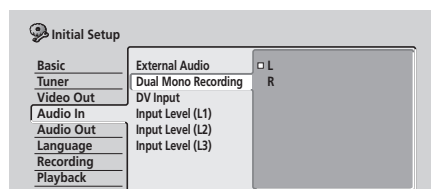

When recording a dual mono source from an external input in Video mode or VR mode set to **FINE / MN 32**, you can choose to record either the **L** (left), or the **R** (right) audio channel.

Note

- If you're recording in VR mode (except when set to **FINE / MN 32**), both channels will be recorded and you can switch them as you like on playback.

DV Input (DVR-320 only)

- Default setting: **Stereo1**

You need to set this if you have a camcorder using 32kHz/12-bit sound connected to the front panel **DV IN/OUT** jack.

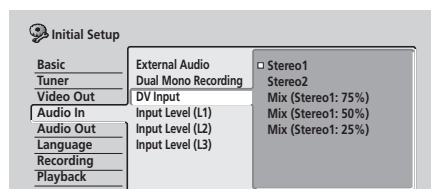

Some digital camcorders have two stereo tracks for audio. One is recorded at the time of shooting; the other is for overdubbing after shooting.

On the **Stereo1** setting, the sound that was recorded while shooting is used. On the **Stereo2** setting, the overdubbed sound is used. You can also choose a **Mix** setting of 25%, 50% or 75% for the Stereo 1 with a corresponding Stereo 2 setting of 75%, 50% or 25%.

Input Level (L1 / L2 / L3)

- Default setting: **0dB**

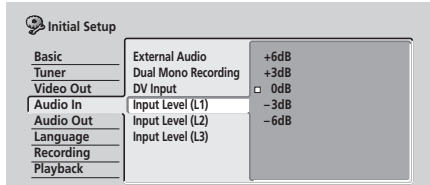

You can adjust the gain of the audio from each external input individually, from **-6dB** to **+6dB** in steps of 3 dB to optimize the recorded audio level.

Audio Out settings

Digital Out

- Default setting: **On**

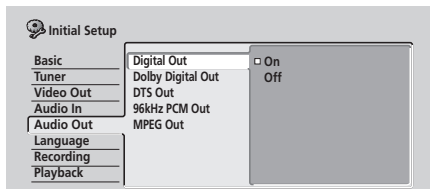

If at any time you need to switch off the digital audio output, set this to **Off**, otherwise leave it **On**.

Note

- When set to **Off**, all the other **Audio Out** settings are grayed out and can't be set.

Dolby Digital Out

You only need to make this setting if you connected this recorder to an AV amplifier (or other component) using the digital output.

- Default setting: **Dolby Digital**

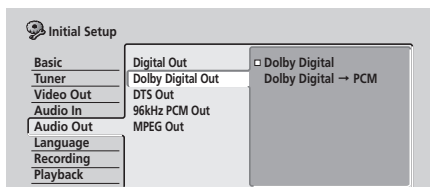

If your AV receiver (or other connected component) is Dolby Digital compatible, set to **Dolby Digital**, otherwise set to **Dolby Digital → PCM**. Check the manual that came with the connected component if you're unsure whether it is Dolby Digital compatible.

DTS Out

You only need to make this setting if you connected this recorder to an AV amplifier (or other component) using the digital output.

- Default setting: **On**

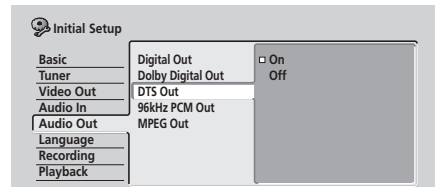

If your AV receiver (or other connected component) has a built-in DTS decoder, set to **On**, otherwise set to **Off**. Check the manual that came with the connected component if you're unsure whether it is DTS compatible.

Important

- If you set to **On** with a non-DTS compatible amplifier, noise will be output when you play a DTS disc.
- When set to **On**, there is no analog audio output when playing a DTS DVD-Video disc.
- When playing a DTS audio CD (even when **DTS Out** is **Off**), noise is output from the analog outputs. *Do not play this through your amplifier and speakers.*
- When playing a DTS audio CD, make sure that **Stereo** is selected using the **AUDIO** button. See *Switching DVD soundtracks* on page 40.

96kHz PCM Out

You only need to make this setting if you connected this recorder to an AV amplifier (or other component) using the digital output.

- Default setting: **96kHz → 48kHz**

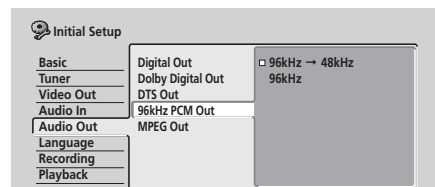

If your AV receiver (or other connected component) is compatible with high sampling rate audio (88.2 / 96 kHz), set to **96kHz**, otherwise set to **96kHz → 48kHz**. Check the manual that came with the connected component if you're unsure whether it is compatible with high sampling rate audio.

MPEG Out

You only need to make this setting if you connected this recorder to an AV amplifier (or other component) using the digital output.

- Default setting: **MPEG → PCM**

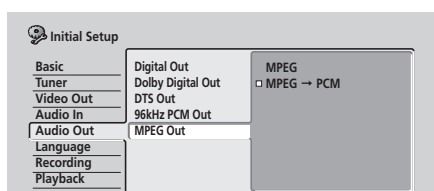

If your AV receiver (or other connected component) is MPEG audio compatible, set to **MPEG**, otherwise set to **MPEG → PCM**. Check the manual that came with the connected component if you're unsure whether it is MPEG compatible.

Language settings

OSD Language

- Default setting: **English**

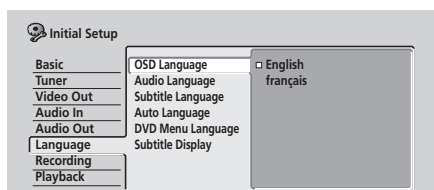

This sets the language of the on-screen menus and displays.

Audio Language

- Default setting: **English**

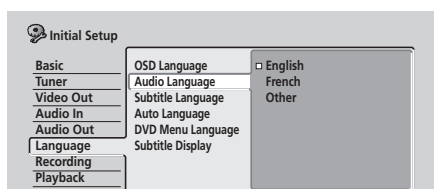

This setting is your preferred audio language for DVD discs. If the language you specify here is recorded on a disc, the recorder automatically plays the disc in that language (although this depends on the **Auto Language** setting—see *Auto Language* below).

Choose **Other** if you want to specify a language other than English or French (see *Selecting 'Other' languages* on page 81).



Tip

- You can switch between the languages recorded on a DVD disc any time during playback using the **AUDIO** button. (This does not affect this setting.)

Subtitle Language

- Default setting: **English**

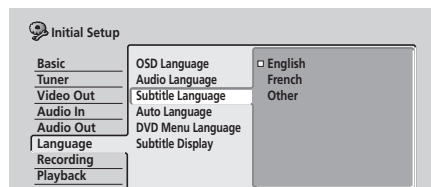

This setting is your preferred subtitle language for DVD discs. If the language you specify here is recorded on a disc, the recorder automatically plays the disc with those subtitles (although this depends on the **Auto Language** setting—see *Auto Language* below).

Choose **Other** if you want to specify a language other than English or French (see *Selecting 'Other' languages* on page 81).



Tip

- You can change or switch off the subtitles on a DVD disc any time during playback using the **SUBTITLE** button. (This does not affect this setting.)

Auto Language

- Default setting: **On**

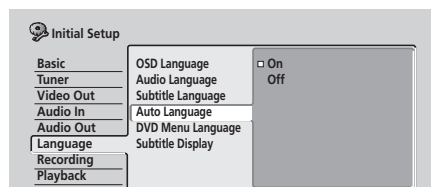

When set to **On**, the recorder selects the default audio language on a DVD disc (French dialog for a French movie, for example), and displays subtitles in your preferred subtitle language only if that is set to something different. In other words, movies in your native language won't have any subtitles, while foreign language movies will be shown with subtitles.

Set to **Off** to have the recorder play discs strictly according to your **Audio Language** and **Subtitle Language** settings.

For **Auto Language** to work, the **Audio Language** and **Subtitle Language** settings must be the same—see *Audio Language* on page 80 and *Subtitle Language* on page 80.

Note

- Even when set to **On**, Auto Language may not work with some discs. In this case, set the audio and subtitle languages using the **AUDIO** and **SUBTITLE** buttons.

Tip

- You can still switch audio and subtitle languages on playback using the **AUDIO** and **SUBTITLE** buttons.

DVD Menu Language

- Default setting: **w/Subtitle Language**

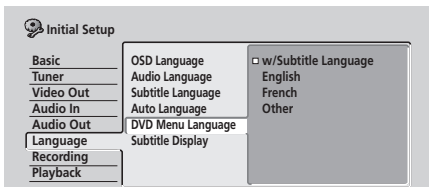

Some multilingual discs have disc menus in several languages. This setting specifies in which language the disc menus should appear. Leave on the default setting for menus to appear in the same language as your **Subtitle Language**—see *Subtitle Language* on page 80. Choose **Other** if you want to specify a language other than English or French (see *Selecting 'Other' languages* on page 81).

Subtitle Display

- Default setting: **On**

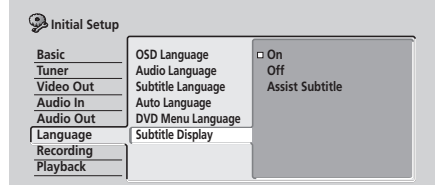

When set to **On**, the recorder displays subtitles according to the **Subtitle Language** and **Auto Language** settings. Set to **Off** to switch subtitles off altogether (although you may find that some discs override this setting). Set to **Assist Subtitle** to have the recorder display the extra assistive subtitles recorded on to some DVD discs.

Selecting 'Other' languages

1 Select 'Other' from the language list.

This option appears in the settings for DVD Menu Language, Audio Language, and Subtitle Language.

2 Select the language you want.

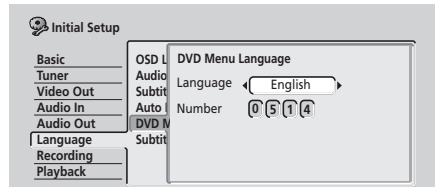

- Select by language name: Use the **←/→** (cursor left/right) buttons to change the language.
- Select by code number: Press **↓** (cursor down) then use the number buttons to enter the 4-digit language code.

See *Language code list* on page 93 for a list of available languages and corresponding codes.

3 Press ENTER to confirm and exit the screen.

Recording settings

Manual Recording

- Default setting: **Off**

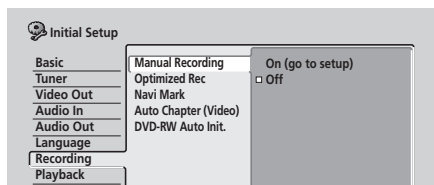

On the default setting there are four different recording time/picture quality settings, **FINE**, **SP**, **LP** and **EP**. If you want to create a custom setting, switch on Manual Recording and select one of the 32 manual settings.

When recording, you can select your Manual Recording setting using the **REC MODE** button.

1 Select 'On (go to setup)' to display the manual recording setting screen.

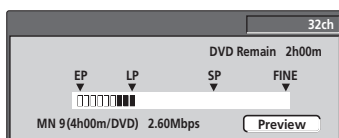

2 Use the ←/→ (cursor left/right) buttons to change the manual recording level.

- You can also use the ◀◀ and ▶▶ buttons to cycle between levels **MN1**, **MN9**, **MN21** and **MN32**.
- To preview the recording quality, press ↓ (cursor down) and select **Preview**. To return to the level adjust screen, press **ENTER**.

3 Press ENTER to set the manual recording level and return to the menu screen.

Note

- The preset picture quality settings correspond to the following manual settings: **FINE**: **MN32**, **SP**: **MN21**, **LP**: **MN9**, **EP**: **MN1**.
- See page *Manual recording modes* on page 92 for detailed information on the manual recording levels.

Optimized Rec

- Default setting: **Off**

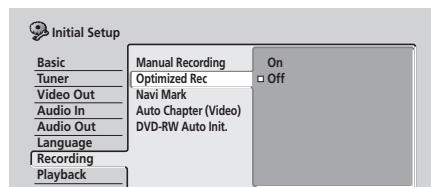

On the default setting, if a timer program (standard, easy or VCR Plus+ programming system) is set but there isn't enough space on the disc at the recording quality set, the recording will start, but it will be cut off when the disc is full. Set **Optimized Rec** to **On** to have the recorder automatically adjust the recording quality to fit the available disc space.

Note

- You may notice a reduction in picture quality if the recorder has to fit a lot of extra material into the remaining time available on the disc.
- If, even on recording level **MN 1**, there is insufficient space available on the disc, the recording is made at level **MN 1** but recording will stop once the disc is full.
- Optimized Recording only compensates for the first (earliest starting) timer program if more than one has been set.

Navi Mark

- Default setting: **0 seconds**

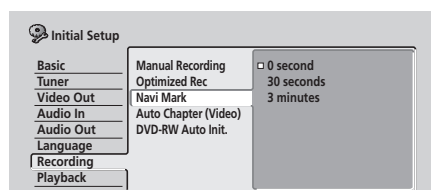

In the Disc Navigator, each title is shown with a still frame picture to remind you what it is. This setting lets you decide the default still frame. The default setting of **0 seconds** takes the first frame of the title, but you can also set it to **30 seconds** or **3 minutes** into the title (if the title is shorter than the setting, then the first frame is used).

Auto Chapter (Video)

- Default setting: **10 minutes**

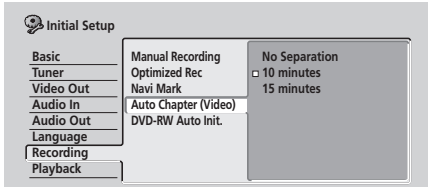

When recording in Video mode, a new chapter is started every 10 minutes on the default setting. You can change this interval to **15 minutes**, or switch off automatic chapter marking altogether with the **No Separation** setting.

DVD-RW Auto Init.

- Default setting: **VR Mode**

When you load a new, blank DVD-RW disc the recorder automatically initializes it for recording. You can set it to initialize the disc for **VR mode** or **Video mode** recording.

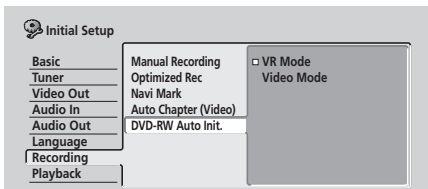

Playback settings

TV Screen Size

- Default setting: **4:3 (Letter Box)**

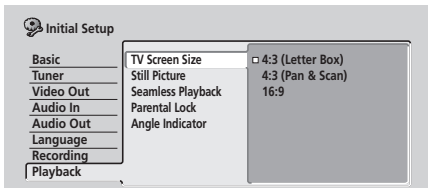

If you have a widescreen TV, select the **16:9** setting—widescreen DVD software is then shown using the full screen area. When playing software recorded in conventional (4:3) format, the settings on your TV will determine how the material is presented—see the manual that came with your TV for details on what options are available.

If you have a conventional TV, choose either **4:3 (Letter Box)** or **4:3 (Pan & Scan)**. In Letter Box mode, widescreen software is shown with black bars at the top and bottom of the screen. Pan & Scan chops the sides off widescreen material to make it fit the 4:3 screen (so even though the picture looks larger on the screen, you're actually seeing less of the movie). See *Screen sizes and disc formats* on page 87 for more information.

Still Picture

- Default setting: **Auto**

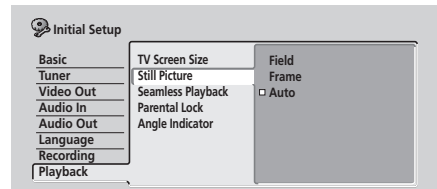

The recorder uses one of two processes when displaying a still frame from a DVD disc. The default **Auto** setting automatically chooses the best setting each time.

- **Field** – produces a stable, generally shake-free image.
- **Frame** – produces a sharper image, but more prone to shake than field stills.

Seamless Playback

VR mode

- Default setting: **Off**

During playback of a VR mode Play List, you may notice momentary interruption in the picture at edited points. The Seamless Playback feature lets you trade-off accuracy of the edit points for more seamless playback. When switched **On**, you may notice that the edit points are a few frames earlier or later than you set.

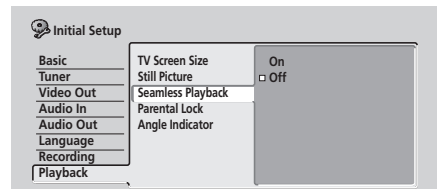

Parental Lock

- Default level: **Off**
- Default password: *none*
- Default Country code: **us (2119)**

Some DVD-Video discs feature a Parental Lock level. If the recorder is set to a lower level than the disc, it will require you to enter a password before the disc will play. This gives you some control about what your children watch on your DVD recorder.

Some discs also support the Country code feature. The recorder does not play certain scenes on these discs depending on the Country code you set.

Before you can set the Parental Lock level or the Country code you must set a password. As the password owner you can change the Parental Lock level or Country code whenever you like. You can also change the password.

Note

- Not all discs that you may consider inappropriate for your children use the Parental Lock feature. These discs will always play without requiring the password first.
- If you forget the password, you can reset the recorder to its factory settings (see *Resetting the recorder* on page 86), then set a new password.

Parental Lock : Set Password

The password you set will enable you to change the Parental Lock level and Country code setting. It is also the password that you will need to enter if you want to play a disc with a parental lock level higher than the recorder.

1 Select 'Set Password'.

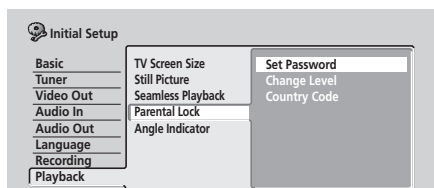

2 Use the number buttons to input a four-digit password.

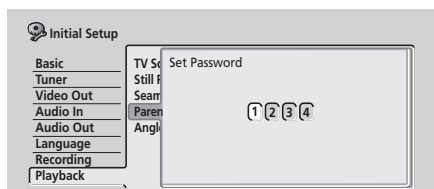

3 Press ENTER to set the password.

Parental Lock : Change Password

To change your password, confirm your existing password then enter a new one.

1 Select 'Change Password'.

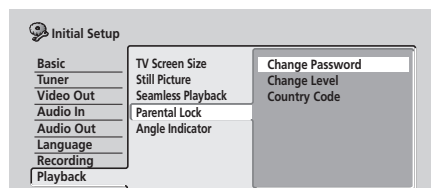

2 Use the number buttons to enter your existing password.

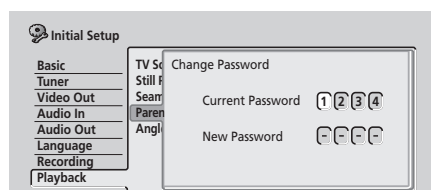

3 Press ENTER.

4 Enter a new password.

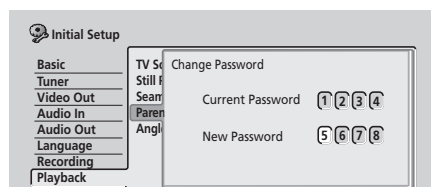

5 Press ENTER.

Parental Lock : Change Level

1 Select 'Change Level'.

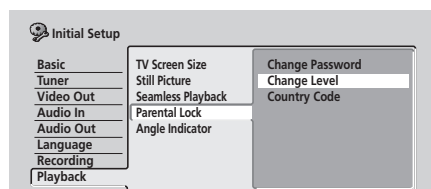

2 Use number buttons to enter your password, then press ENTER.

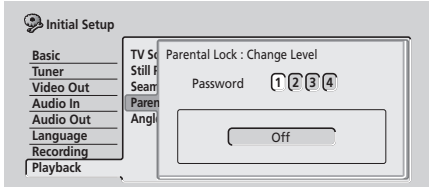

3 Use the ←/→ (cursor left/right) buttons to select a new parental lock level.

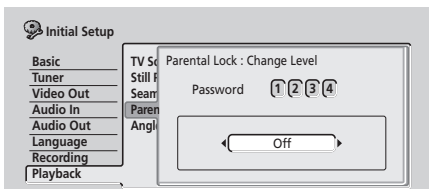

4 Press ENTER to set the new Parental Lock level.

Parental Lock : Country Code

You may also want to refer to the *Country code list* on page 93.

1 Select 'Country Code'.

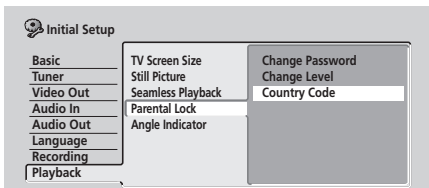

2 Use number buttons to enter your password, then press ENTER.

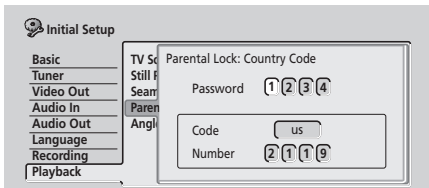

3 Select a Country code.

There are two ways you can do this.

• Select by code letter: Use ←/→ (cursor left/right) to change the country code.

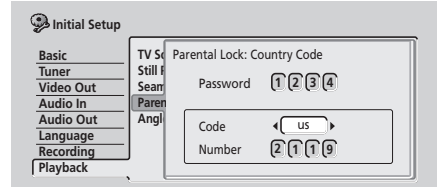

• Select by code number: Press ↓ (cursor down) then use the number buttons to enter the 4-digit country code (you can find the *Country code list* on page 93.)

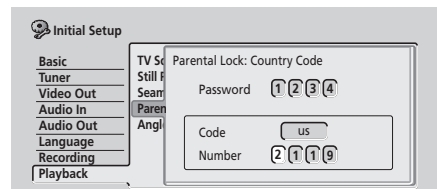

4 Press ENTER to set the new Country code.

Note

• Changing the country code does not take effect until the next disc is loaded (or the current disc is reloaded).

Angle Indicator

• Default setting: **On**

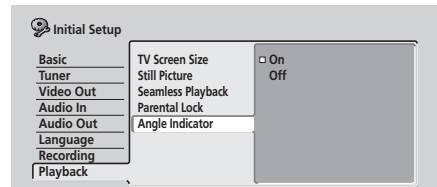

On the default setting, when playing a DVD-Video disc that features multi-angle scenes, an icon appears on-screen during the parts of the disc where angle switching is available. Change to **Off** to hide the on-screen indicator.

Chapter 13

Additional information

Resetting the recorder

If you need to, you can reset the recorder to all its factory settings.

- 1 Make sure that the recorder is on.**
- 2 Press and hold ■ STOP and press ⏻ STANDBY/ON.**

The recorder turns off with all settings reset.

Setting up the remote to control your TV

You can use the supplied remote to control your TV. To be able to use this feature you first have to program the remote with a maker code from the table below.

- 1 Press and hold down the CLEAR button, then enter the maker code for your TV.**

The LED indicator on the remote controls lights.

See the table below for the list of maker codes. If there is more than one code given for your make, input the first one in the list.

- If the maker's name of your TV doesn't appear in the table below, you will not be able to use this remote to control your TV.

- 2 Press ⏻ TV to check that the remote works with your TV.**

If the remote is set up correctly, the TV should switch on/off. If it doesn't and there is another code given for your maker, repeat step 1 with a new code.











Using the TV remote control buttons

The table below shows how to use this remote control with your TV.

Button	What it does
⏻ TV	Press to switch the TV on/off (standby)
INPUT SELECT	Press to change the TV's video input
TV VOLUME	Use to adjust the TV volume
TV CHANNEL	Use to change TV channels

Maker	Code
Aiwa	38
Funai	36
GE	11, 28
General	34
Goldstar	10, 23
Grandient	30
Hitachi	06, 24, 25, 32
Magnavox	12, 29
Mitsubishi	09
NEC	37
Panasonic	08, 22, 41
Philips	07
Pioneer	00, 35, 40, 44
RCA	01, 15, 16, 17, 18
Sanyo	14, 21
Sharp	02, 19, 27
Sony	04
Toshiba	05, 26, 31, 43
Victor	13, 33, 42
Zenith	03, 20

Screen sizes and disc formats

When viewing on a standard TV or monitor		
Screen format of disc	Setting	Appearance
16:9 	4:3 (Letter Box) 	The program is shown in widescreen with black bars at the top and bottom of the screen.
	4:3 (Pan & Scan) 	The sides of the program are cropped so that the picture fills the whole screen.
4:3 	16:9 	The program appears squashed. Set to either 4:3 (Letter Box) or 4:3 (Pan & Scan) .
	4:3 (Letter Box) 4:3 (Pan & Scan) 	The program is presented correctly on either setting.
When viewing on a widescreen TV or monitor		
Screen format of disc	Setting	Appearance
16:9 	16:9 	The program is presented in widescreen.
4:3 	16:9  	Your TV will determine how the picture is presented—check the manual that came with the TV for details.

Troubleshooting

Incorrect operation is often mistaken for trouble and malfunction. If you think there is something wrong with this component, please check the points below. Sometimes the trouble may lie in another component. Investigate the other components and electrical appliances being used. If the trouble cannot be rectified even after checking the points below, ask your nearest Pioneer authorized service center or your dealer to carry out repair work.



Note

- If the unit does not operate normally due to external effects such as static electricity, disconnect the power plug from the outlet and insert again to return to normal operating conditions.

General

Problem	Remedy
The disc is automatically ejected after closing the disc tray	<ul style="list-style-type: none"> • Check that the disc is not a DVD-RAM or other incompatible format disc (page 11). • Check that the disc is loaded properly (aligned in disc tray and label-side up). • Take out the disc and clean it (page 95). • Check that the disc has a region code compatible with the recorder (page 98).
No picture	<ul style="list-style-type: none"> • Check that everything is connected properly (page 13). • Check that the connected TV and/or the AV receiver is set to the correct input. • Make sure that the disc is NTSC format. • The recorder may be set to progressive-scan with an incompatible TV. Reset to interlace by pressing and holding the + button (front panel) then pressing DISC HISTORY (front panel).
Can't play a disc	<ul style="list-style-type: none"> • Check that the disc is not a DVD-RAM or other incompatible format disc (page 11). • Take out the disc and clean it (page 95). • Check that the disc is loaded properly (aligned in disc tray and label-side up). • There may be condensation in the recorder. Leave the recorder for an hour or so for the condensation to evaporate.
All settings are reset	<ul style="list-style-type: none"> • If the recorder is unplugged (or there is a power failure) while the recorder is on, all the settings will be lost. • Make sure that you switch the recorder into standby before unplugging the power cord.
Screen goes blank and controls are inoperative	<ul style="list-style-type: none"> • Press ■ STOP then restart playback.
Remote control does not work	<ul style="list-style-type: none"> • If you connected this recorder to another Pioneer product using the CONTROL IN jack, point the remote control at the other component to use (page 13). • Set the remote control to the same ID number as the recorder (page 76). (When the batteries run down, the remote mode is automatically reset to 1.) • Use the remote within its operating range (page 10). • Replace the batteries (page 10).
Front panel display shows 'LOCK' when a button is pressed	<ul style="list-style-type: none"> • The Child Lock is on; turn off in order to use the recorder (page 49).
The picture freezes and the front panel and remote control buttons stop working.	<ul style="list-style-type: none"> • Press the front panel ⏻ STANDBY/ON button to switch the power off, then switch back on and restart playback. If the power fails to switch off, press and hold ⏻ STANDBY/ON for 10 seconds until the power switches off.

Problem	Remedy
No sound or sound is distorted	<ul style="list-style-type: none"> • Make sure that the amplifier/receiver or TV is set to the correct input and the volume turned up. • There is no sound when the picture is paused, or during scanning (even forwards at regular play speed) or slow motion play. Press ► PLAY to resume regular playback • DTS discs can only be played if this recorder is connected to a DTS decoder or DTS compatible amplifier/receiver. If you have connected a suitable decoder, also make sure that the Initial Setup > Audio Out > DTS Output setting is On. • Some 96kHz discs do not output audio through the digital jack. In this case, switch the input of your amplifier/receiver to analog. • Check the audio cable connections (page 13). • If the sound is distorted, try cleaning the cable plugs.
The picture from the external input is distorted	<ul style="list-style-type: none"> • If the video signal from the external component is copy-protected, you cannot connect via this recorder. Connect the component directly to your TV.
Screen is stretched vertically or horizontally	<ul style="list-style-type: none"> • Make sure that the TV Screen Size setting (page 83) is correct for the kind of TV you have (see also page 87). • If you have a widescreen TV, check its aspect ratio settings. • This recorder's input switches into wide mode automatically according to the input signal. When the unit connected is not compatible with ID-1, set the connected component to output 4:3 aspect ratio (standard) video.
Can't play a disc recorded using this recorder on another player	<ul style="list-style-type: none"> • If the disc was recorded in Video mode, make sure that it's finalized (page 54). • Some players will not play recordable DVD discs, even when recorded in Video mode and finalized. • If the disc was recorded in VR mode, the other player must be specifically RW compatible in order to play it (page 11). • Discs recorded with copy-once material cannot be played on non-CPRM compatible players (page 43).
During playback the picture is dark or distorted	<ul style="list-style-type: none"> • When a copy-protected disc is played via a VCR, the picture will not display correctly. Connect the recorder directly to your TV.
Can't control your TV using this remote control	<ul style="list-style-type: none"> • If there is more than one code listed for your make of TV, try each one in turn (page 86) • It is possible that none of the codes listed will work with your particular model of TV, even if the maker appears in the remote control code list.
Can't record or does not record successfully	<ul style="list-style-type: none"> • Check that there is some remaining blank space on the DVD (page 67). • Check that the disc isn't already finalized. • A DVD disc may contain up to 99 (Original) titles and 999 chapters. Check that these limits have not been reached. • Check that the source you are trying to record is not copy protected. • For a VR formatted disc, check that the disc isn't locked (page 70). • The power may have failed during recording.
Timer program doesn't record successfully	<ul style="list-style-type: none"> • When setting the recording channel, make sure you set the recorder's built-in TV tuner, not the TV's built-in tuner. • When recording to a Video mode disc, programs that are copy-once protected cannot be recorded. Use a VR mode formatted disc for copy-once material (page 43). • Two timer programs may have overlapped, in which case only the earlier one will record completely. • The power may have failed during recording.

Problem	Remedy
After briefly unplugging or after a power failure the front panel display shows '---'	<ul style="list-style-type: none"> A backup battery inside the recorder keeps the clock and other settings from being reset when there is no power to the recorder. This battery should last approximately 5 years from factory shipping. Reset the clock and other recorder settings to use the recorder again. To have the battery replaced, contact your dealer or a Pioneer Service Center.

Frequently asked questions

In this section you can find answers to frequently asked questions on how to use your DVD recorder and what it can do.

- What kind of discs can I use for recording?*

You can use DVD-R and DVD-RW discs for recording. DVD-RAM, CD-R and CD-RW discs are not recordable using this recorder.

See *Disc / content format playback compatibility* on page 11 for more details.
- Can I watch recordings made using this recorder on other DVD players?*

Yes. Use a DVD-R disc for you recordings (these are always recorded in Video mode). After recording, finalize the disc to make it playable on other DVD players (note that you cannot make further recordings on the disc after finalizing it).

If you want to use a DVD-RW disc, make sure that it's initialized for recording in Video mode. As with a DVD-R, finalize the disc after recording to make it playable in other players.

See also *Playing your recordings on other DVD players* on page 54.
- Can I edit recordings, or erase parts of recordings from a disc?*

Yes. Recording to a VR mode DVD-RW disc gives you the most flexibility when editing. By default, when you load a new DVD-RW disc into the recorder it is initialized for recording in VR mode.

See also *Editing* on page 56.
- Can I play a VR mode DVD-RW disc in another DVD player?*

Look for the 'RW Compatible' mark on the other DVD player to see if it will play VR mode DVD-RW discs. If the player does not recognize the disc when you load it, try finalizing it in the recorder, then try again.

See also *Playing your recordings on other DVD players* on page 54.
- Can I record a copy-once protected program from a subscription satellite or cable channel?*

Yes, but you'll need to use a CPRM-compatible DVD-RW disc initialized for VR mode recording. (Look on the disc package to see if it is CPRM compatible.)

See also *CPRM* on page 43.
- Can I play a disc while recording?*

Yes. For simultaneous recording and playback, use a 2x speed compatible DVD-RW initialized for VR mode recording (the disc should be a DVD-RW Ver. 1.1/2x or Ver. 1.2 CPRM-compatible).

See also *Simultaneous recording and playback* on page 50.
- I changed the batteries in the remote control and now it doesn't work!*

Most likely the remote control ID does not match the recorder. After changing the batteries, the remote ID is reset to 1; if the recorder is set to something else, the remote will not work with it.

See *Remote Control Set* on page 76 for how to set the ID of the recorder and the remote.

About DV (DVR-320 only)

Using DV, also known as i.LINK, you can connect a DV-equipped camcorder to this recorder using a single DV cable for input and output of audio, video, data and control signals.

The i.LINK interface is also known as IEEE 1394-1995. "i.LINK" and the "i.LINK" logo are trademarks.

- This recorder is only compatible with DV-format (DVC-SD) camcorders. Digital satellite tuners and Digital VHS video recorders are not compatible.
- You cannot connect more than one DV camcorder at a time to this recorder.
- You cannot control this recorder from external equipment connected via the **DV IN/OUT** jack.
- It may not always be possible to control the connected camcorder via the **DV IN/OUT** jack.
- This recorder only outputs DVD playback video from the **DV IN/OUT** jack; signals from the built-in TV tuner, CD, Video CD and other inputs are not output.
- Copy-protected or copy-once video is not output from the **DV IN/OUT** jack.
- Digital camcorders can usually record audio as stereo 16-bit/48kHz, or twin stereo tracks of 12-bit/32kHz. This recorder can only record one stereo audio track. Set the **DV Input** setting as required (see *DV Input (DVR-320 only)* on page 78).
- Audio output from the **DV IN/OUT** jack is 16-bit only.
- Audio input to the **DV IN/OUT** jack should be 32 or 48kHz (not 44.1kHz).
- Picture disturbance in the recording may occur if the source component pauses playback or plays an unrecorded section of tape, or if the power fails in the source component, or the DV cable becomes disconnected.

DV-related messages

You may see the following messages appear on your TV screen when using the **DV IN/OUT** jack.

- **DV camcorder playback canceled. Recording has been paused.** – Recording was paused because the camcorder is not in playback mode.
- **Cannot operate the DV camcorder.** – This recorder cannot control the camcorder. Try switching off the camcorder then switching it back on.
- **Could not operate the DV camcorder.** – This recorder was not able to control the camcorder.
- **Recording has stopped because the recorded material on the tape finished.** – When the recorded part of the DV tape comes to an end, this recorder automatically stops recording.
- **Recording has stopped because DV camcorder playback stopped.** – Recording stopped because DV camcorder playback was stopped or the camcorder was disconnected.
- **The DV camcorder is not set for playback. Please select playback mode on the DV camcorder.** – The camcorder is in camera mode.
- **No DV camcorder connected.** – The camcorder is not connected properly, or the camcorder is switched off.
- **The DV camcorder is recording.** – The camcorder is recording, so you cannot start recording from the camcorder to this recorder.
- **You cannot connect more than one DV camcorder at the same time.** – The DV jack on this recorder supports connection to just one camcorder.
- **No tape in the DV camcorder.** – There is no cassette loaded into the connected equipment.
- **The DV camcorder is in record-pause mode.** – The camcorder is in record-pause mode.

Manual recording modes

The table below shows the approximate recording times for all of the 32 manual recording modes, as well as the standard recording mode equivalents. Levels separated by a bold line show where there is a noticeable change in picture quality.

Audio recording in all manual recording modes is in Dolby Digital 2ch format, except for MN32 which is in Linear PCM format.

VR mode			Video mode	
Level	Rec. time		Level	Rec. time
MN 1	360 mins.	EP	MN 1	360 mins.
MN 2	345 mins.		MN 2	345 mins.
MN 3	330 mins.		MN 3	330 mins.
MN 4	315 mins.		MN 4	315 mins.
MN 5	300 mins.		MN 5	300 mins.
MN 6	285 mins.		MN 6	285 mins.
MN 7	270 mins.	LP	MN 7	270 mins.
MN 8	255 mins.		MN 8	255 mins.
MN 9	240 mins.		MN 9	240 mins.
MN 10	230 mins.		MN 10	230 mins.
MN 11	220 mins.		MN 11	220 mins.
MN 12	210 mins.		MN 12	210 mins.
MN 13	200 mins.		MN 13	200 mins.
MN 14	190 mins.		MN 14	190 mins.
MN 15	180 mins.		MN 15	180 mins.
MN 16	170 mins.		MN 16	170 mins.
MN 17	160 mins.		MN 17	160 mins.
MN 18	150 mins.		MN 18	150 mins.
MN 19	140 mins.	SP	MN 19	140 mins.
MN 20	130 mins.		MN 20	130 mins.
MN 21	120 mins.		MN 21	120 mins.
MN 22	110 mins.		MN 22	110 mins.
MN 23	105 mins.		MN 23	105 mins.
MN 24	100 mins.		MN 24	100 mins.
MN 25	95 mins.		MN 25	95 mins.
MN 26	90 mins.		MN 26	90 mins.
MN 27	85 mins.		MN 27	85 mins.
MN 28	80 mins.		MN 28	80 mins.
MN 29	75 mins.		MN 29	75 mins.
MN 30	70 mins.		MN 30	70 mins.
MN 31	65 mins.		MN 31	65 mins.
MN 32	61 mins.	FINE	MN 32	61 mins.

Information for cable/satellite/STB (set-top box) users

The following instructions show how to use the timer features of your STB with this recorder.

Setting up

1 Connect the STB's audio/video outputs to a set of audio/video inputs on this recorder.

2 Switch on both the STB and this recorder and switch the recorder's input function to the STB (L1, L2 or L3).

To check that everything is connected properly, switch on your TV and select this recorder as the video input. You should see whatever the STB is tuned to.

3 Program the IR controller supplied with your STB to send start/stop recording codes for a Pioneer VCR.

See the manual that came with the STB for how to do this.

Only the **REC** and **STOP** codes have any effect when used with this recorder:

- **REC** – Start recording
- **STOP** – Stop recording

4 Position the IR controller so that it will control this recorder.

The IR sensor on the recorder is located just above the  mark on the front panel.

Making a timer recording

1 Set the timer on the STB.

See the manual that came with your STB for how to do this.

2 Switch on this recorder.

You must leave the recorder on until the recording finishes.

- At the programmed times, the STB will start and stop recording on this recorder.

Language code list

Language (Language code letter), **Language code**

Japanese (ja), 1001	Bhutani (dz), 0426	Kirghiz (ky), 1125	Sinhalese (si), 1909
English (en), 0514	Esperanto (eo), 0515	Latin (la), 1201	Slovak (sk), 1911
French (fr), 0618	Estonian (et), 0520	Lingala (ln), 1214	Slovenian (sl), 1912
German (de), 0405	Basque (eu), 0521	Laothian (lo), 1215	Samoa (sm), 1913
Italian (it), 0920	Persian (fa), 0601	Lithuanian (lt), 1220	Shona (sn), 1914
Spanish (es), 0519	Finnish (fi), 0609	Latvian (lv), 1222	Somali (so), 1915
Chinese (zh), 2608	Fiji (fj), 0610	Malagasy (mg), 1307	Albanian (sq), 1917
Dutch (nl), 1412	Faroese (fo), 0615	Maori (mi), 1309	Serbian (sr), 1918
Portuguese (pt), 1620	Frisian (fy), 0625	Macedonian (mk), 1311	Siswati (ss), 1919
Swedish (sv), 1922	Irish (ga), 0701	Malayalam (ml), 1312	Sesotho (st), 1920
Russian (ru), 1821	Scots-Gaelic (gd), 0704	Mongolian (mn), 1314	Sundanese (su), 1921
Korean (ko), 1115	Galician (gl), 0712	Moldavian (mo), 1315	Swahili (sw), 1923
Greek (el), 0512	Guarani (gn), 0714	Marathi (mr), 1318	Tamil (ta), 2001
Afar (aa), 0101	Gujarati (gu), 0721	Malay (ms), 1319	Telugu (te), 2005
Abkhazian (ab), 0102	Hausa (ha), 0801	Maltese (mt), 1320	Tajik (tg), 2007
Afrikaans (af), 0106	Hindi (hi), 0809	Burmese (my), 1325	Thai (th), 2008
Amharic (am), 0113	Croatian (hr), 0818	Nauru (na), 1401	Tigrinya (ti), 2009
Arabic (ar), 0118	Hungarian (hu), 0821	Nepali (ne), 1405	Turkmen (tk), 2011
Assamese (as), 0119	Armenian (hy), 0825	Norwegian (no), 1415	Tagalog (tl), 2012
Aymara (ay), 0125	Interlingua (ia), 0901	Occitan (oc), 1503	Setswana (tn), 2014
Azerbaijani (az), 0126	Interlingue (ie), 0905	Oromo (om), 1513	Tonga (to), 2015
Bashkir (ba), 0201	Inupiak (ik), 0911	Oriya (or), 1518	Turkish (tr), 2018
Byelorussian (be), 0205	Indonesian (in), 0914	Panjabi (pa), 1601	Tsonga (ts), 2019
Bulgarian (bg), 0207	Icelandic (is), 0919	Polish (pl), 1612	Tatar (tt), 2020
Bihari (bh), 0208	Hebrew (iw), 0923	Pashto, Pushto (ps), 1619	Twi (tw), 2023
Bislama (bi), 0209	Yiddish (ji), 1009	Quechua (qu), 1721	Ukrainian (uk), 2111
Bengali (bn), 0214	Javanese (jw), 1023	Rhaeto-Romance (rm), 1813	Urdu (ur), 2118
Tibetan (bo), 0215	Georgian (ka), 1101	Kirundi (rn), 1814	Uzbek (uz), 2126
Breton (br), 0218	Kazakh (kk), 1111	Romanian (ro), 1815	Vietnamese (vi), 2209
Catalan (ca), 0301	Greenlandic (kl), 1112	Kinyarwanda (rw), 1823	Volapük (vo), 2215
Corsican (co), 0315	Cambodian (km), 1113	Sanskrit (sa), 1901	Wolof (wo), 2315
Czech (cs), 0319	Kannada (kn), 1114	Sindhi (sd), 1904	Xhosa (xh), 2408
Welsh (cy), 0325	Kashmiri (ks), 1119	Sangho (sg), 1907	Yoruba (yo), 2515
Danish (da), 0401	Kurdish (ku), 1121	Serbo-Croatian (sh), 1908	Zulu (zu), 2621

Country code list

Country, **Country code**, **Country code letter**

Argentina, 0118 , ar	Finland, 0609 , fi	Malaysia, 1325 , my	Singapore, 1907 , sg
Australia, 0121 , au	France, 0618 , fr	Mexico, 1324 , mx	Spain, 0519 , es
Austria, 0120 , at	Germany, 0405 , de	Netherlands, 1412 , nl	Sweden, 1905 , se
Belgium, 0205 , be	Hong Kong, 0811 , hk	New Zealand, 1426 , nz	Switzerland, 0308 , ch
Brazil, 0218 , br	India, 0914 , in	Norway, 1415 , no	Taiwan, 2023 , tw
Canada, 0301 , ca	Indonesia, 0904 , id	Pakistan, 1611 , pk	Thailand, 2008 , th
Chile, 0312 , cl	Italy, 0920 , it	Philippines, 1608 , ph	United Kingdom, 0702 , gb
China, 0314 , cn	Japan, 1016 , jp	Portugal, 1620 , pt	USA, 2119 , us
Denmark, 0411 , dk	Korea, Republic of, 1118 , kr	Russian Federation, 1821 , ru	

On-screen displays and recorder displays

The table below shows a list of error messages that you may encounter when using the recorder and an explanation of their meaning.

Message	Explanation/Action
<ul style="list-style-type: none"> • Initializing disc. Please wait a moment. 	When you load a blank DVD-RW disc, the recorder automatically initializes it.
<ul style="list-style-type: none"> • Incompatible region number. 	The disc loaded has an incompatible region number for the recorder and so will not play.
<ul style="list-style-type: none"> • Cannot record any more titles. • No more space for file management data. • Cannot add any more chapter marks. 	The disc control data limit has been reached, or the maximum number of chapters and/or titles has been reached. Erase titles/chapters or combine chapters.
<ul style="list-style-type: none"> • This disc cannot be recorded. Undo the finalization. 	The disc was finalized on a non-Pioneer DVD recorder. Undo the finalization in order to recording/editing.
<ul style="list-style-type: none"> • Cannot play this disc. • This disc cannot be recorded. • Cannot read the CPRM information. • Could not record the information to the disc. • Cannot edit. • Could not initialize disc. • Could not complete finalization successfully. • Could not undo finalization successfully. • Could not successfully unlock the disc. 	The disc may be dirty or damaged. Take out the disc, clean it and retry. If the error persists, use a new disc. If the error appears even with a new disc, please consult a Pioneer Service Center.
<ul style="list-style-type: none"> • Cannot record to a disc that is not CPRM compatible. • Cannot record this content using Video mode recording. 	The video source is copy-once protected. Use a VR mode DVD-RW disc with CPRM for recording.
<ul style="list-style-type: none"> • This content is copy protected. 	The video source is copy-protected and cannot be recorded.
<ul style="list-style-type: none"> • Incorrect CPRM information. 	The recorder could not read the CPRM information. The recorder may be damaged—please consult a Pioneer Service Center.
<ul style="list-style-type: none"> • The audio will conform to the [Dual Mono Recording] setting. 	When recording from an external input in Video mode, or in VR mode set to MN 32, audio is recorded in Linear PCM format. You can only record the left or right channel; not both.
<ul style="list-style-type: none"> • Operation stopped due to power failure. 	If during recording the power plug is disconnected from the power outlet, this message will be displayed the next time the recorder is switched on. In this case, the recording will not be recoverable.
<ul style="list-style-type: none"> • Could not repair the disc. 	The recorder was unable to repair the disc after a power cut. The contents of the recording will be lost.
<ul style="list-style-type: none"> • Overheating has stopped operation. Press DISPLAY to clear this message. 	The internal temperature of the recorder has exceeded the operating limit. If this message reappears, please contact a Pioneer authorized service center.
<i>(DV-320 only)</i>	
<ul style="list-style-type: none"> • No DV input. • Cannot preview because there is no DV input. 	No signal was detected at the DV input/output jack. This may appear if a blank section of DV tape is playing in the connected camcorder.

Handling discs

When holding discs of any type, take care not to leave fingerprints, dirt or scratches on the disc surface. Hold the disc by its edge or by the center hole and edge.

Damaged or dirty discs can affect playback and recording performance. Take care also not to scratch the label side of the disc. Although not as fragile as the recorded side, scratches can still result in a disc becoming unusable.

Should a disc become marked with fingerprints, dust, etc., clean using a soft, dry cloth, wiping the disc lightly from the center to the outside edge as shown in the diagram below.



If necessary, use a cloth soaked in alcohol, or a commercially available CD/DVD cleaning kit to clean a disc more thoroughly. Never use benzine, thinner or other cleaning agents, including products designed for cleaning vinyl records.

Storing discs

Although CDs and DVD discs are more durable than vinyl records, you should still take care to handle and store discs correctly. When you're not using a disc, return it to its case and store upright. Avoid leaving discs in excessively cold, humid, or hot environments (including under direct sunlight).

Don't glue paper or put stickers onto the disc, or use a pencil, ball-point pen or other sharp-tipped writing instrument. These could all damage the disc.



For more detailed care information see the instructions that come with discs.

Do not load more than one disc into the recorder.

Damaged discs

Discs spin at high speed inside the recorder. If you can see that a disc is cracked, chipped, warped, or otherwise damaged, don't risk using it; you could end up damaging the recorder.

This recorder is designed for use with conventional, fully circular discs only. Use of shaped discs is not recommended for this product. Pioneer disclaims all liability arising in connection with the use of shaped discs.

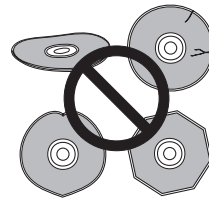

Cleaning the pickup lens

The DVD recorder's lens should not become dirty in normal use, but if for some reason it should malfunction due to dust or dirt, consult your nearest Pioneer-authorized service center. Although lens cleaners for CD players are commercially available, we do not recommend using them since some may damage the lens.

Condensation

Condensation may form inside the recorder if it is brought into a warm room from outside, or if the temperature of the room rises quickly. Although the condensation won't damage the recorder, it may temporarily impair its performance. For this reason you should leave it to adjust to the warmer temperature for about an hour before switching on and using.

Hints on installation

We want you to enjoy using this unit for years to come, so please bear in mind the following points when choosing a suitable location for it:

Do...

- ✓ Use in a well-ventilated room.
- ✓ Place on a solid, flat, level surface, such as a table, shelf or stereo rack.

Don't...

- ✗ Use in a place exposed to high temperatures or humidity, including near radiators and other heat-generating appliances.
- ✗ Place on a window sill or other place where the recorder will be exposed to direct sunlight.
- ✗ Use in a dusty or damp environment or in a room where it will be exposed to excessive cigarette smoke.
- ✗ Place directly on top of an amplifier, or other component in your stereo system that becomes hot in use.
- ✗ Use near a television or monitor as you may experience interference—especially if the television uses an indoor antenna.
- ✗ Use in a kitchen or other room where the recorder may be exposed to smoke or steam.
- ✗ Use on a thick rug or carpet, or cover with cloth—this may prevent proper cooling of the unit.
- ✗ Place on an unstable surface, or one that is not large enough to support all four of the unit's feet.

Moving the recorder

If you need to move the recorder, first remove the disc, if there's one loaded, and close the disc tray. Next, press **⏻** **STANDBY/ON** to switch the power to standby, checking that the **POWER OFF** indication in the display goes off. Lastly, disconnect the power cord. Never lift or move the unit during playback or recording—discs rotate at a high speed and may be damaged.

Glossary

Analog audio

An electrical signal that directly represents sound. Compare this to digital audio which can be an electrical signal, but is an indirect representation of sound. See also *Digital audio*.

Aspect ratio

The width of a TV screen relative to its height. Conventional TVs are 4:3 (in other words, the screen is almost square); widescreen models are 16:9 (the screen is almost twice as wide as it is high).

Chapter

Just as a book is split up into several chapters, a title on a DVD disc is usually divided into chapters. See also *Title*.

Digital audio

An indirect representation of sound by numbers. During recording, the sound is measured at discrete intervals (44,100 times a second for CD audio) by an analog-to-digital converter, generating a stream of numbers. On playback, a digital-to-analog converter generates an analog signal based on these numbers. See also *Sampling frequency* and *Analog audio*.

Dolby Digital



With multichannel audio, this high quality surround system is used in many movie theaters around the world. *Manufactured under licence from Dolby Laboratories. "Dolby" and the double-D symbol are trademarks of Dolby Laboratories.*

DRM (Digital Rights Management)

DRM (Digital Rights Management) copy protection is a technology designed to prevent unauthorized copying by restricting playback, etc. of material on devices other than the PC (or other WMA recording equipment) used to record it. For detailed information, please see the instruction manuals or help files that came with your PC (or other WMA recording equipment) and/or software.

DTS



DTS stands for Digital Theater System. DTS is a surround system different from Dolby Digital that has become a popular surround sound format for movies.

"DTS" and "DTS Digital Out" are registered trademarks of Digital Theater Systems, Inc.

Dynamic range

The difference between the quietest and loudest sounds possible in an audio signal (without distorting or getting lost in noise). Dolby Digital and DTS soundtracks are capable of a very wide dynamic range, delivering dramatic cinema-like effects.

EXIF (Exchangeable Image File)

A file format developed by Fuji Photo Film for digital still cameras. Digital cameras from various manufacturers use this compressed file format which carries date, time and thumbnail information, as well as the picture data.

File extension

A tag added to the end of a filename to indicate the type of file. For example, ".mp3" indicates an MP3 file.

ISO 9660 format

International standard for the volume and file structure of CD-ROM discs.

JPEG

A file format used for still images, such as photographs and illustrations. JPEG files are identified by the file extension ".jpg" or ".JPG". Most digital cameras use this format.

MP3

MP3 (MPEG1 audio layer 3) is a compressed audio file format. Files are recognized by their file extension ".mp3" or ".MP3".

MPEG audio

MPEG) (Multichannel

An audio format used on Video CDs and some DVD discs. This unit can convert MPEG audio to PCM format for wider compatibility with digital recorders and AV amplifiers. See also *PCM*.

MPEG video

The video format used for Video CDs and DVDs. Video CD uses the older MPEG-1 standard, while DVD uses the newer and much better quality MPEG-2 standard.

Optical digital output

A jack that outputs digital audio in the form of light pulses. Connect components with optical digital jacks using a special optical cord, available from specialist audio dealers.

PCM (Pulse Code Modulation)

The most common system of encoding digital audio, found on CDs and DAT. Excellent quality, but requires a lot of data compared to formats such as Dolby Digital and MPEG audio. For compatibility with digital audio recorders (CD, MD and DAT) and AV amplifiers with digital inputs, this unit can convert Dolby Digital and MPEG audio to PCM. See also *Digital audio*.

PBC (PlayBack Control) (Video CD only)

A system of navigating a Video CD through on-screen menus recorded onto the disc. Especially good for discs that you would normally not watch from beginning to end all at once—karaoke discs, for example.

Progressive scan video

Also called non-interlaced video, this method of displaying a picture updates all the lines in one pass, resulting in a more stable, flicker-free image than interlaced video (for a given scanning rate).

PureCinema

Video on a DVD disc may be either video material (originally shot on video) or film material (originally shot on film). Video material has a frame rate of 30 frames/second, compared to 24 frames/second for film. This recorder converts film material to 60 frames/second (in progressive scan mode). PureCinema adjusts the picture so that it matches more closely the picture quality of a cinema screen

You can see whether video on a DVD disc is film or video material by displaying the transfer rate. If a '#' appears above the transfer rate display, it is film material.

Regions (DVD only)

(example region code marks)

Regions associate discs and players with particular areas of the world. This unit will only play discs that have compatible region codes. You can find the region code of your unit by looking on the rear panel. Some discs are compatible with more than one region (or all regions).

Sampling frequency

The rate at which sound is measured to be turned into digital audio data. The higher the rate, the better the sound quality, but the more digital information is generated. Standard CD audio has a sampling frequency of 44.1kHz, which means 44,100 samples (measurements) per second. See also *Digital audio*.

Title

A collection of chapters on a DVD disc. See also *Chapter*.

Track

Audio CDs and Video CDs use tracks to divide up the content of a disc. The DVD equivalent is called a chapter. See also *Chapter*.

WMA

WMA is short for Windows Media Audio and refers to an audio compression technology developed by Microsoft Corporation. WMA data can be encoded by using Windows Media Player version 9 or Windows Media Player for Windows XP. Files are recognized by their file extension ".wma" or ".WMA".

Microsoft, Windows Media, and the Windows logo are trademarks, or registered trademarks of Microsoft Corporation in the United States and/or other countries.

Specifications

General

System	DVD-Video, DVD-R/RW, Video-CD, CD, CD-R/RW (WMA, MP3, JPEG, CD-DA)
Power requirements	120 V, 60 Hz
Power Consumption	
DVR-220	23 W
DVR-320	26 W
Power consumption in standby mode	0.42W (Front Panel Display : off)
Weight	8 lb 13 oz / 4.0 kg
Dimensions	420 (W) x 59 (H) x 339 (D) mm
Operating temperature	+5°C to +35°C
Operating humidity	.5% to 85% (no condensation)
TV format	.NTSC

Recording

Recording format	DVD Video Recording DVD-VIDEO
------------------	-------------------------------

Recordable discs

DVD-RW (DVD Re-recordable disc)
DVD-R (DVD Recordable disc)

Video recording format

Sampling frequency	13.5MHz
Compression format	MPEG

Audio recording format

Sampling frequency	48kHz
Compression format	Dolby Digital or Linear PCM (uncompressed)

Recording time

Fine (FINE)	Approx. 1 hour
Standard Play (SP)	Approx. 2 hours
Long Play (LP)	Approx. 4 hours
Extended Play (EP)	Approx. 6 hours
Manual Mode (MN)	Approx. 1–6 hours

Tuner

Receivable channels

VHF	2–13ch
UHF	14–69ch
CATV	C1–C125ch

Timer

Programs	1 month/32 programs
Clock	Quartz lock (12-hour digital display)
Power off memory	Approx. 5 years (after manufacture)

Input/Output

VHF/UHF antenna input/output terminal	VHF/UHF set 75 Ω (F-shape connector)
Video input	Input 1, 3 (rear), 2 (front)
Input level	1 Vp-p (75 Ω)
Jacks	RCA jack
Video output	Output 1,2
Output level	1 Vp-p (75 Ω)
Jacks	RCA jack
S-Video input	Input 1, 3 (rear), 2 (front)
Y (luminance) - Input level	1 Vp-p (75 Ω)
C (color) - Input level	286 mVp-p (75 Ω)
Jacks	4 pin mini DIN
S-Video output	Output 1,2
Y (luminance) - Output level	1 Vp-p (75 Ω)
C (color) - Output level	286 mVp-p (75 Ω)
Jacks	4 pin mini DIN
Component video output	
Output level	Y: 1.0 Vp-p (75 Ω) PB, PR: 0.7 Vp-p (75 Ω)
Jacks	RCA jacks
Audio input	Input 1, 3 (rear), 2 (front) L/R
Input level	
During audio input	2V rms (Input impedance: more than 22 k Ω)
Jacks	RCA jacks
Audio output	Output 1,2 L/R
During audio output	2V rms (Output impedance: less than 1.5 k Ω)
Jacks	RCA jacks
Control input	Mini jack
DV input/output (DVR-320 only)	4 pin (i.LINK/IEEE 1394 standard)

Supplied accessories

Remote control	1
Dry cell batteries (AA/R6P)	2
Audio / Video cable (red/white/yellow)	1
RF antenna cable	1
Power cable	1
Operating Instructions	1
Warranty card	1

Note: The specifications and design of this product are subject to change without notice, due to improvement.

Index

A

Adjusting the picture quality **72 – 74**
 Audio DRC **74**
 Audio language **22, 40, 80**
 Audio settings **78 – 80**
 Auto language **80, 81**

C

Camcorder - see DV camcorder
 Changing TV channels **27, 86**
 Chase play - see Simultaneous recording and playback
 Component video **13, 15, 77**
 CPRM **43, 90, 94**

D

Disc and file formats **11, 87**
 Disc compatibility - see Disc and file formats
 Disc Navigator **33 – 34, 56 – 66**
 Dolby Digital **8, 26, 40, 41, 42, 74, 79, 97**
 Dual mono audio **21, 78**
 DV camcorder **9, 52, 53, 91**

E

Easy timer recording **8, 45**
 Editing recordings **56 – 66**

F

Finalizing discs **31, 54, 71**

I

Initializing discs **42, 55, 71, 83**

J

JPEG picture files **9, 11, 31, 68 – 69, 97**

M

Manual channel setup **77**
 Manual recording mode (MN) **21, 43, 82, 92**
 MP3 audio **9, 11, 29, 97**
 MPEG audio **80, 97**

O

One-touch recording **8, 44**

On-screen display (OSD) **24, 31, 80**
 Optimized recording **8, 47, 82**
 Original content **9, 12, 22, 31, 56, 57, 58 – 62, 64**
 OSD - see On-screen display (OSD)

P

PBC (PlayBack Control for Video CD) **30, 33, 98**
 PhotoViewer **68 – 69**
 Picture quality - see Adjusting the picture quality and Recording quality
 Play List **9, 12, 21, 22, 31, 56, 57, 62 – 66**
 Play Mode menu **22, 37 – 39**
 Program play **38, 38 – 39**
 Progressive scan video **8, 21, 26, 32, 73, 78, 98**

R

Recording **27, 32, 42 – 55**
 Recording quality **42, 43, 72**
 Remote control **10, 22, 76**
 Repeat play **38, 39**
 Rotating (a JPEG picture) **69**

S

SAP - see TV audio channel
 Scanning **22, 35**
 Setting up **24 – 26, 86**
 Simultaneous recording and playback **8, 32, 50, 90**
 Slow motion playback **36**
 Subtitle language **22, 24, 40, 80, 81**

T

Timer recording **8, 21, 23, 32, 44 – 50, 51**
 TV aspect ratio **25, 83, 87**
 TV audio channel **21, 28, 44, 78**

V

VCR Plus+ **8, 22, 47 – 48, 77**
 Video mode **9, 11, 12, 21, 32, 42, 54, 55, 58, 71, 83, 90, 92**
 Video settings **72 – 74, 77 – 78**
 VR mode **12, 21, 42, 44, 54, 55, 58, 62, 71, 83, 90, 92**

W

WMA audio **9, 11, 29, 98**

Z

Zooming (a JPEG picture) **69**

Should this product require service in the U.S.A. and you wish to locate the nearest Pioneer Authorized Independent Service Company, or if you wish to purchase replacement parts, operating instructions, service manuals, or accessories, please call the number shown below.

8 0 0 - 4 2 1 - 1 4 0 4

Please do not ship your product to Pioneer without first calling the Customer Support Division at the above listed number for assistance.

Pioneer Electronics (USA) Inc.
Customer Support Division
P.O. BOX 1760, Long Beach,
CA 90801-1760, U.S.A.

For warranty information please see the Limited Warranty sheet included with your product.

Should this product require service in Canada, please contact a Pioneer Canadian Authorized Dealer to locate the nearest Pioneer Authorized Service Company in Canada.
Alternatively, please contact the Customer Satisfaction Department at the following address:

Pioneer Electronics of Canada, Inc.
Customer Satisfaction Department
300 Allstate Parkway, Markham, Ontario L3R OP2
(905)479-4411
1(877)283-5901

For warranty information please see the Limited Warranty sheet included with your product.

Si ce produit doit être réparé au Canada, veuillez vous adresser à un distributeur autorisé Pioneer du Canada pour obtenir le nom du Centre de Service Autorisé Pioneer le plus près de chez-vous. Vous pouvez aussi contacter le Service à la clientèle de Pioneer:

Pioneer Electroniques du Canada, Inc.
Service à la clientèle
300, Allstate Parkway, Markham, Ontario L3R OP2
(905)479-4411
1(877)283-5901

Pour obtenir des renseignements sur la garantie, veuillez vous reporter au feuillet sur la garantie restreinte qui accompagne le produit.

S018D_enfr

Published by Pioneer Corporation.
Copyright © 2004 Pioneer Corporation.
All rights reserved.

PIONEER CORPORATION

4-1, Meguro 1-Chome, Meguro-ku, Tokyo 153-8654, Japan

PIONEER ELECTRONICS (USA) INC.

P.O. BOX 1540, Long Beach, California 90810-1540, U.S.A. TEL: (800) 421-1404

PIONEER ELECTRONICS OF CANADA, INC.

300 Allstate Parkway, Markham, Ontario L3R OP2, Canada TEL: (905) 479-4411

PIONEER EUROPE NV

Haven 1087, Keetberglaan 1, B-9120 Melsele, Belgium TEL: 03/570.05.11

PIONEER ELECTRONICS ASIACENTRE PTE. LTD.

253 Alexandra Road, #04-01, Singapore 159936 TEL: 656-472-1111

PIONEER ELECTRONICS AUSTRALIA PTY. LTD.

178-184 Boundary Road, Braeside, Victoria 3195, Australia, TEL: (03) 9586-6300

PIONEER ELECTRONICS DE MEXICO S.A. DE C.V.

Bldv.Manuel Avila Camacho 138 10 piso Col.Lomas de Chapultepec, Mexico,D.F. 11000 TEL: 55-9178-4270

K002E

Free Manuals Download Website

<http://myh66.com>

<http://usermanuals.us>

<http://www.somanuals.com>

<http://www.4manuals.cc>

<http://www.manual-lib.com>

<http://www.404manual.com>

<http://www.luxmanual.com>

<http://aubethermostatmanual.com>

Golf course search by state

<http://golfingnear.com>

Email search by domain

<http://emailbydomain.com>

Auto manuals search

<http://auto.somanuals.com>

TV manuals search

<http://tv.somanuals.com>