

Pioneer *sound.vision.soul*

DVD Recorder

DVR-433H-S

DVR-433H-K

HDD
HARD DISK DRIVE

DVD
VIDEO

DVD
R

DVD
RW

COMPACT
disc
DIGITAL AUDIO

COMPACT
disc
DIGITAL VIDEO

VIDEO *plus+*

Operating Instructions

RW
COMPATIBLE

Thank you for buying this Pioneer product.

Please read through these operating instructions so you will know how to operate your model properly. After you have finished reading the instructions, put them away in a safe place for future reference.

IMPORTANT



The lightning flash with arrowhead symbol, within an equilateral triangle, is intended to alert the user to the presence of uninsulated "dangerous voltage" within the product's enclosure that may be of sufficient magnitude to constitute a risk of electric shock to persons.

CAUTION

**RISK OF ELECTRIC SHOCK
DO NOT OPEN**

CAUTION:

TO PREVENT THE RISK OF ELECTRIC SHOCK, DO NOT REMOVE COVER (OR BACK). NO USER-SERVICEABLE PARTS INSIDE. REFER SERVICING TO QUALIFIED SERVICE PERSONNEL.



The exclamation point within an equilateral triangle is intended to alert the user to the presence of important operating and maintenance (servicing) instructions in the literature accompanying the appliance.

D3-4-2-1-1_En-A

WARNING

This equipment is not waterproof. To prevent a fire or shock hazard, do not place any container filled with liquid near this equipment (such as a vase or flower pot) or expose it to dripping, splashing, rain or moisture.

D3-4-2-1-3_A_En

WARNING

Before plugging in for the first time, read the following section carefully.

The voltage of the available power supply differs according to country or region. Be sure that the power supply voltage of the area where this unit will be used meets the required voltage (e.g., 230V or 120V) written on the rear panel.

D3-4-2-1-4_A_En

CAUTION

This product is a class 1 laser product, but this product contains a laser diode higher than Class 1. To ensure continued safety, do not remove any covers or attempt to gain access to the inside of the product. Refer all servicing to qualified personnel.

**CLASS 1 LASER PRODUCT
LASER KLASSE 1
クラス1レーザ製品**

The following caution label appears on your unit.
Location: inside of the unit

CAUTION CLASS 3B VISIBLE AND INVISIBLE LASER RADIATION WHEN OPEN. AVOID EXPOSURE TO THE BEAM.
ATTENTION RADIATIONS LASER VISIBLES ET INVISIBLES DE CLASSE 3B QUAND OUVERT. ÉVITEZ TOUT EXPOSITION AU FAISCEAU.
ADVARSEL KLASSE 3B SYNLIG OG USYNLIG LASERSTRÅLING VED ÅBNING. UNDGÅ UDSÆTTELSE FOR STRÅLING.
VARNING KLASSE 3B SYNLIG OCH OSYNLIG LASERSTRÅLNING NÄR DENNA DEL ÄR ÖPPNAD. UNDVIK ATT UTSÄTTA DIG FÖR STRÅLEN.
VORSICHT BEI GEÖFFNETER ABDECKUNG IST SICHTBARE UND UNSICHTBARE LASERSTRÄHLUNG DER KLASSE 3B IM GERÄTEINNEREN VORHANDEN. AUGEN NICHT DEM LASERSTRAHL AUSSETZEN!
PRECAUCIÓN CUANDO SE ABRE HAY RADIACIÓN LÁSER DE CLASE 3B VISIBLE E INVISIBLE. EVITE LA EXPOSICIÓN A LOS RAYOS LÁSER.
VARO! AVATTAESSA OLET ALTIINNA NÄKYVÄLLE, JA NÄKYMÄTTÖMÄLLE LUOKAN 3B LASERSÄTELYLLE. ÄLÄ KATSO SÄTEESEEN.
注意 ここを開くと CLASS 3B の可視レーザ光及び不可視レーザ光が出ます。ビームを直接見たり、触れたりしないこと。

DRW2247 - A

D3-4-2-1-8_A_En

This product complies with the Low Voltage Directive (73/23/EEC, amended by 93/68/EEC), EMC Directives (89/336/EEC, amended by 92/31/EEC and 93/68/EEC).

D3-4-2-1-9a_En

CAUTION

The STANDBY/ON switch on this unit will not completely shut off all power from the AC outlet. Since the power cord serves as the main disconnect device for the unit, you will need to unplug it from the AC outlet to shut down all power. Therefore, make sure the unit has been installed so that the power cord can be easily unplugged from the AC outlet in case of an accident. To avoid fire hazard, the power cord should also be unplugged from the AC outlet when left unused for a long period of time (for example, when on vacation).

D3-4-2-2-2a_A_En

WARNING

To prevent a fire hazard, do not place any naked flame sources (such as a lighted candle) on the equipment.

D3-4-2-1-7a_A_En

Operating Environment

Operating environment temperature and humidity: $+5\text{ }^{\circ}\text{C} - +35\text{ }^{\circ}\text{C}$ ($+41\text{ }^{\circ}\text{F} - +95\text{ }^{\circ}\text{F}$); less than 85 %RH (cooling vents not blocked)

Do not install this unit in a poorly ventilated area, or in locations exposed to high humidity or direct sunlight (or strong artificial light)

D3-4-2-1-7c_A_En

VENTILATION CAUTION

When installing this unit, make sure to leave space around the unit for ventilation to improve heat radiation (at least 10 cm at top, 10 cm at rear, and 10 cm at each side).

WARNING

Slots and openings in the cabinet are provided for ventilation to ensure reliable operation of the product, and to protect it from overheating. To prevent fire hazard, the openings should never be blocked or covered with items (such as newspapers, table-cloths, curtains) or by operating the equipment on thick carpet or a bed.

D3-4-2-1-7b_A_En

This product incorporates copyright protection technology that is protected by method claims of certain U.S. patents and other intellectual property rights owned by Macrovision Corporation and other rights owners. Use of this copyright protection technology must be authorized by Macrovision Corporation, and is intended for home and other limited viewing uses only unless otherwise authorized by Macrovision Corporation. Reverse engineering or disassembly is prohibited.

This product is for general household purposes. Any failure due to use for other than household purposes (such as long-term use for business purposes in a restaurant or use in a car or ship) and which requires repair will be charged for even during the warranty period.

K041_En

This product includes FontAvenue® fonts licenced by NEC corporation. FontAvenue is a registered trademark of NEC Corporation.

If the AC plug of this unit does not match the AC outlet you want to use, the plug must be removed and appropriate one fitted. Replacement and mounting of an AC plug on the power supply cord of this unit should be performed only by qualified service personnel. If connected to an AC outlet, the cut-off plug can cause severe electrical shock. Make sure it is properly disposed of after removal.

The equipment should be disconnected by removing the mains plug from the wall socket when not left unused for a long period of time (for example, when on vacation).

D3-4-2-1a_A_En

POWER-CORD CAUTION

Handle the power cord by the plug. Do not pull out the plug by tugging the cord and never touch the power cord when your hands are wet as this could cause a short circuit or electric shock. Do not place the unit, a piece of furniture, etc., on the power cord, or pinch the cord. Never make a knot in the cord or tie it with other cords. The power cords should be routed such that they are not likely to be stepped on. A damaged power cord can cause a fire or give you an electrical shock. Check the power cord once in a while. When you find it damaged, ask your nearest PIONEER authorized service center or your dealer for a replacement.

S002_En

Replacement and mounting of an AC plug on the power supply cord of this unit should be performed only by qualified service personnel.

IMPORTANT

FOR USE IN THE UNITED KINGDOM

The wires in this mains lead are coloured in accordance with the following code:

Blue : Neutral
Brown : Live

If the plug provided is unsuitable for your socket outlets, the plug must be cut off and a suitable plug fitted.

The cut-off plug should be disposed of and must not be inserted into any 13 amp socket as this can result in electric shock. The plug or adaptor or the distribution panel should be provided with 5 A fuse. As the colours of the wires in the mains lead of this appliance may not correspond with coloured markings identifying the terminals in your plug, proceed as follows :

The wire which is coloured blue must be connected to the terminal which is marked with the letter N or coloured black.

The wire which is coloured brown must be connected to the terminal which is marked with the letter L or coloured red.

Do not connect either wire to the earth terminal of a three pin plug.

NOTE

After replacing or changing a fuse, the fuse cover in the plug must be replaced with a fuse cover which corresponds to the colour of the insert in the base of the plug or the word that is embossed on the base of the plug, and the appliance must not be used without a fuse cover. If lost replacement fuse covers can be obtained from your dealer. Only 5 A fuses approved by B.S.I or A.S.T.A to B.S.1362 should be used.

D3-4-2-1-2-2_En

Contents

01 Before you start

Features	6
What's in the box	8
Putting the batteries in the remote control	8
Using the remote control	8
Disc / content format playback compatibility	9
About the internal hard disk drive	11

02 Connecting up

Rear panel connections	12
Front panel connections	12
Extra features for use with compatible TVs	13
Easy connections	14
Using other types of audio/video output	15
Connecting to a cable box, satellite receiver or digital terrestrial receiver	16
Connecting an external decoder box (1)	17
Connecting an external decoder box (2)	18
Connecting to an AV amplifier/receiver	19
Connecting other AV sources	20
Plugging in	20

03 Controls and displays

Front panel	21
Remote control	22
Display	24

04 Getting started

Switching on and setting up	25
Selecting the hard disk or DVD for playback and recording	27
Making your first recording	28
Using the built-in TV tuner	29
Basic playback	31
Using the Home Menu	34
Displaying disc information on-screen	34

05 Recording

About DVD recording	37
About HDD recording	37
Recording time and picture quality	38
Recorded audio	38
Restrictions on video recording	38
Setting the picture quality/recording time	39
Basic recording from the TV	39
Setting a timer recording	41
Timer recording FAQ	47

Simultaneous recording and playback	48
Recording from an external component	48
Automatic recording from a satellite tuner	49
Recording from a DV camcorder	50
Playing your recordings on other DVD players	51
Initializing a recordable DVD disc	52

06 Playback

Introduction	53
Navigating discs and the HDD	53
Using the Disc Navigator to browse the contents of a disc	54
Scanning discs	56
Playing in slow motion	56
Frame advance/frame reverse	57
The Play Mode menu	57
Displaying and switching subtitles	60
Switching DVD soundtracks	61
Switching audio channels	61
Switching camera angles	62

07 Copying and back-up

Introduction	63
One Touch Copy	63
Using Copy Lists	64
Using disc back-up	71

08 Editing

The Disc Navigator screen	73
Command menu panel options	74
Editing accuracy	74
HDD genres	74

09 Using the Jukebox

Copying CDs to the HDD	82
Playing music from the Jukebox	83
Editing Jukebox albums	83

10 The PhotoViewer

Playing a slideshow	85
---------------------	----



11 The Disc Setup menu

Introduction.....	87
Basic settings	87
Initialize settings	87
Finalize settings.....	88
Optimize HDD	88
Initialize HDD	88

12 The Video/Audio Adjust menu

Setting the picture quality for TV and external inputs	89
Setting the picture quality for disc playback	90
Audio DRC.....	91

13 The Initial Setup menu

Using the Initial Setup menu	92
------------------------------------	----

14 Additional information

Screen sizes and disc formats	101
Minimum copying times	102
Troubleshooting.....	103
Frequently asked questions	105
About DV	106
Manual recording modes.....	107
Language code list.....	108
Country/Area code list	108
On-screen displays and recorder displays	109
Resetting the recorder.....	111
Handling discs.....	111
Cleaning the pickup lens.....	111
Condensation	111
Hints on installation.....	112
Glossary.....	113
Specifications	115

Index

Chapter 1

Before you start

Features

- **HDD recording** **HDD**

Record up to 227 hours of video (in MN1 mode) on the internal 80 GB (gigabyte) hard disk (HDD). With both recordable DVD and a high-capacity HDD in the same recorder, you have the flexibility to keep recordings on the HDD for quick access anytime, or record to DVD for archiving or playing on other DVD players.

- **Copy between HDD and DVD**

You can quickly and easily copy recordings between the HDD and DVD. When copying to DVD you can usually use the high-speed copy feature, which can copy an hour of video in about one minute (when recorded in SEP mode using a DVD-R Ver. 2.0 / 2.1 (16x) disc).

You can also choose to copy material at a different recording quality from the original. For example, you might want to copy an XP mode (highest quality) recording on the HDD to SP (standard play) quality on a DVD so that you can fit other recordings on the same disc.

- **One Touch Copy**

One Touch Copy makes copying the currently playing title from HDD to DVD, or DVD to HDD as simple as pressing a button.

- **High quality, real-time copying**

When recording to the HDD, picture quality data is also stored so that picture quality can be optimized when making real-time copies to DVD later.

(This is applicable only to MN16–32 HDD recordings (Video Mode Off), or MN12–32 / XP+ recordings (Video Mode On).

- **Chase play** **VR mode** **HDD**

Using chase play you can start watching a recording from the beginning, while continuing to record. For example, you could set a timer recording for a program that you're going to miss the first 15 minutes of, then start watching while the recorder is still recording the program 15 minutes ahead of you.

- **Simultaneous recording and playback**

VR mode **HDD**

HDD and DVD playback and recording are completely independent. For example, you can record a broadcast program to a recordable DVD, while watching another recording you already made on the same DVD.

- **On-screen Help**

Use the **HELP** button on the remote control to display a help screen for the current operation.

- **Disc Navigator**

The on-screen Disc Navigator makes finding your way around the contents of a disc or the HDD easy. For recordable DVD and HDD content, moving thumbnail images are displayed for ease of use. The Disc Navigator is also where you can edit HDD and recordable DVD content.

- **Home Menu**

The Home Menu gives you on-screen access to all the recorder's features in one convenient place, from setting up the recorder, to programming a timer recording and editing a recording.

- **Progressive scan-compatible**

Compared to standard interlaced video, progressive scan effectively doubles the amount of video information fed to your TV or monitor. The result is a stable, flicker-free image. (Check your TV/monitor for compatibility with this feature.)

- **Cinema-style surround sound in your home**

Connect this recorder to a Dolby Digital and/or DTS-compatible AV amp/receiver to enjoy full surround sound effects from Dolby Digital and DTS DVD discs.

- **Easy Timer Recording**

Setting the recorder to record a program is simple from the Easy Timer Recording screen. Set the channel to record and the recording quality, then graphically set the start and end times of the recording. That's it!

- **Program up to 32 timer recordings**

You can program the recorder to record up to 32 programs, up to a month in advance. As well as single programs, you can specify daily or weekly recordings, too.

* **VIDEO Plus+** is a registered trademark of Gemstar Development Corporation.

The VIDEO Plus+ system is manufactured under license from Gemstar Development Corporation.

- **One Touch Recording**

Use One Touch Recording to start recording immediately in 30 minute blocks. Each time you press the **REC** button, the recording time is extended by another 30 minutes, up to six hours.

- **Optimized recording**

Optimized recording adjusts the recording quality automatically if a timer recording will not fit onto a disc with the settings that you made.

- **Auto Start Recording from satellite receiver or other set top box**

With a satellite receiver or other set top box connected to the **AV2/AUTO START REC** inputs of this recorder, you can start and stop recording automatically according to the timer settings of the set top box.

- **Super high quality HDD recording** **HDD**

Using the **XP+** recording mode you can record super high quality video (around 15 Mbps data transfer rate) to the HDD.

- **High quality 16-bit Linear PCM audio**

In the **LPCM** recording mode, audio is recorded in uncompressed 16-bit Linear PCM format. This delivers great sounding audio to accompany the high picture quality.

- **Picture quality adjustment features**

During playback, you can adjust various picture quality settings to improve the picture. You can also adjust the recording picture quality. For example, if you want to make a DVD copy of an old video tape, you can optimize the picture quality before transferring it to disc.

- **Find what you want to watch quickly and easily**

Unlike video tape that needs to be wound to the correct place, you can jump right to the part of a DVD disc or the HDD that you want to watch. Search for a point on a disc by title, chapter or time.

- **Manual recording**

In addition to six preset recording quality modes, the manual recording mode allows you to access 34 different recording quality/time settings, giving you precise control over the recording.

- **Record from a DV camcorder**

This recorder has a built-in DV (Digital Video) input for connection to a DV camcorder. This makes it ideal for transferring camcorder footage to DVD or HDD for editing.

- **Safe, non-destructive editing** **VR mode**

When editing Play List content, the actual content of the disc (the Original content) is not touched. The edited version (the Play List content) just points to various parts of the Original content.

- **Play Video mode recordings on a regular DVD**

player **Video mode**

Discs recorded using the Video mode can be played back on regular DVD players, including computer DVD drives compatible with DVD-Video playback*.

* 'DVD-Video format' recording: The use of the DVD-Video format for recording on DVD-R and DVD-RW discs is referred to as recording in 'Video mode' on Pioneer's DVD recorders. Supporting playback of DVD-R / DVD-RW discs is optional for manufacturers of DVD playback equipment, and there is DVD playback equipment that does not play DVD-R or DVD-RW discs recorded in the DVD-Video format. Note: 'Finalization' is required.

- **WMA, MP3 and JPEG file playback**

This recorder can play WMA and MP3 audio files and JPEG picture files on CD-R, CD-RW or CD-ROM discs.

- **Disc Back-up**

The disc back-up feature gives you a convenient way to back-up important material on a finalized Video mode DVD to another recordable DVD disc. The material is first copied to the HDD, then on to a second DVD disc.

- **Recovery Recording** **HDD**

When a timer recording is set to use DVD but the disc loaded at the time of the recording is unrecordable, the program will automatically be recorded to the HDD.

- **Auto Replace Recording** **HDD**

This feature is useful for regular timer recordings of a TV program which you don't want to keep after watching. Each time the program is recorded, it replaces the one currently on the HDD. There's no need to manually delete it later.

Note on copying:

Recording equipment should be used only for lawful copying and you are advised to check carefully what is lawful copying in the country in which you are making a copy. Copying of copyright material such as films or music is unlawful unless permitted by a legal exception or consented to by the rightowners.

What's in the box

Please confirm that the following accessories are in the box when you open it.

- Remote control
- AA/R6P dry cell batteries x2
- Audio/video cable (red/white/yellow)
- RF antenna cable
- Power cable
- These operating instructions
- Warranty card

Putting the batteries in the remote control

1 Open the battery compartment cover on the back of the remote control.

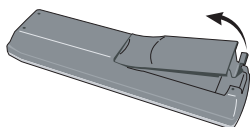

2 Insert two AA/R6P batteries into the battery compartment following the indications (+, -) inside the compartment.

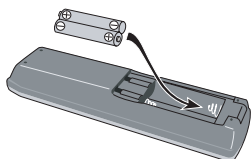

3 Close the cover.

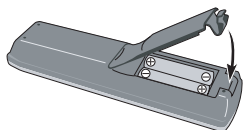

Important

Incorrect use of batteries can result in hazards such as leakage and bursting. Please observe the following:

- Don't mix new and old batteries together.
- Don't use different kinds of batteries together—although they may look similar, different batteries may have different voltages.
- Make sure that the plus and minus ends of each battery match the indications in the battery compartment.
- Remove batteries from equipment that isn't going to be used for a month or more.
- When disposing of used batteries, please comply with governmental regulations or environmental public instruction's rules that apply in your country or area.

Using the remote control

Please keep in mind the following when using the remote control:

- Make sure that there are no obstacles between the remote and the remote sensor on the unit.
- Remote operation may become unreliable if strong sunlight or fluorescent light is shining on the unit's remote sensor.
- Remote controllers for different devices can interfere with each other. Avoid using remotes for other equipment located close to this unit.
- Replace the batteries when you notice a fall off in the operating range of the remote.
- When the batteries run down or you change the batteries, the remote control mode and TV preset codes are automatically reset. See *Remote Control Mode* on page 98 to reset them.
- Use within the operating range in front of the remote control sensor on the front panel, as shown.

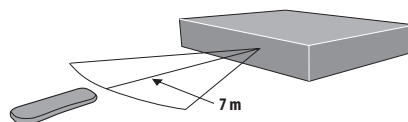

- You can control this recorder using the remote sensor of another Pioneer component using the **CONTROL IN** jack on the rear panel. See *Rear panel connections* on page 12 for more information.

Disc / content format playback compatibility

General disc compatibility

This recorder is compatible with a wide range of disc types (media) and formats. Playable discs will generally feature one of the following logos on the disc and/or disc packaging. Note however that some disc types, such as recordable CD and DVD, may be in an unplayable format—see below for further compatibility information.



- Also compatible with KODAK Picture CD
- **DVD** is a trademark of DVD Format/Logo Licensing Corporation.
-  is a trademark of Fuji Photo Film Co. Ltd.

This recorder also supports the IEC's Super VCD standard. Compared to the Video CD standard, Super VCD offers superior picture quality, and allows two soundtracks to be recorded. Super VCD also supports the widescreen size.



DVD-R/RW compatibility

This recorder will play and record DVD-R/RW discs.

Compatible media:

- DVD-RW Ver. 1.1, Ver. 1.1 / 2x, Ver. 1.2 / 2–4x and Ver. 1.2 / 2–6x
- DVD-R Ver. 2.0 and Ver. 2.0 / 4x / 8x / 16x, and Ver. 2.1 1–8x / 1–16x

Recording formats:

- DVD-R/RW: Video Recording (VR) format and DVD-Video format (Video mode)

Readable formats:

- DVD-R/RW: Video Recording (VR) format and DVD-Video format (Video mode)

Note that older models of DVD recorders and DVD writers may reject DVD-RW Ver. 1.2 discs and/or corrupt the data on the disc. If you want to share DVD-RW discs between this recorder and an older recorder/writer, we recommend using Ver. 1.1 discs.

The following table shows older Pioneer DVD recorders' limited compatibility with DVD-RW Ver. 1.2 discs.

Model	Playable	Recordable
DVR-7000	Yes ^{1,2,3}	No
DVR-3100/ DVR-5100H	Yes ¹	No

¹ Discs should be finalized in this recorder before playing. Unfinalized VR mode and Video mode discs may not play.

² Cannot read the CPRM information will show in the display when you load a disc. However, this will not affect playback.

³ Copy-once protected disc titles will not play.

CD-R/RW compatibility

This recorder cannot record CD-R or CD-RW discs.

- Readable formats: CD-Audio, Video CD/Super VCD, ISO 9660 CD-ROM* containing MP3, WMA or JPEG files
* ISO 9660 Level 1 or 2 compliant. CD physical format: Mode1, Mode2 XA Form1. Romeo and Joliet file systems are both compatible with this recorder.
- Multi-session playback: Yes (except CD-Audio and Video CD/Super VCD)
- Unfinalized disc playback: CD-Audio only

Compressed audio compatibility

- Compatible media: CD-ROM, CD-R, CD-RW
- Compatible formats: MPEG-1 Audio Layer 3 (MP3), Windows Media Audio (WMA)
- Sampling rates: 44.1 or 48kHz
- Bit-rates: Any (128Kbps or higher recommended)
- Variable bit-rate (VBR) MP3 playback: Yes
- VBR WMA playback: No
- WMA encoder compatibility: Windows Media Codec 8 (files encoded using Windows Media Codec 9 may be playable but some parts of the specification are not supported; specifically, Pro, Lossless, Voice and VBR)
- DRM (Digital Rights Management) file playback: No (see also DRM in the Glossary on page 113)
- File extensions: .mp3, .wma (these must be used for the recorder to recognize MP3 and WMA files – do not use for other file types)
- File structure: Up to 99 folders / 999 files (if these limits are exceeded, only files and folders up to these limits are playable)

WMA (Windows Media Audio) compatibility



The Windows Media[®] logo printed on the box indicates that this recorder can playback Windows Media Audio content.

WMA is an acronym for Windows Media Audio and refers to an audio compression technology developed by Microsoft Corporation. WMA content can be encoded by using Windows Media[®] Player for Windows[®] XP, Windows Media[®] Player 9 or Windows Media[®] Player 10 series.

Microsoft, Windows Media, and the Windows logo are trademarks, or registered trademarks of Microsoft Corporation in the United States and/or other countries.

JPEG file compatibility

- Compatible formats: Baseline JPEG and EXIF 2.2* still image files
*File format used by digital still cameras
- Sampling ratio: 4:4:4, 4:2:2, 4:2:0
- Horizontal resolution: 160 – 5120 pixels
- Vertical resolution: 120 – 3840 pixels
- Progressive JPEG compatible: No
- File extensions: .jpg, .jpeg, .jif, .jfi (must be used for the recorder to recognize JPEG files – do not use for other file types)
- File structure: The recorder can load up to 99 folders / 999 files at one time (if there are more files/folders that this on the disc then more can be reloaded)

PC-created disc compatibility

Discs recorded using a personal computer may not be playable in this unit due to the setting of the application software used to create the disc. In these particular instances, check with the software publisher for more detailed information.

Discs recorded in packet write mode (UDF format) are not compatible with this recorder.

Check the DVD-R/RW or CD-R/RW software disc boxes for additional compatibility information.

Frequently asked questions

- *What's the difference between DVD-R and DVD-RW?*
The most important difference between DVD-R and DVD-RW is that DVD-R is a record-once medium, while DVD-RW is a re-recordable/erasable medium. You can re-record/erase a DVD-RW disc approximately 1,000 times.
For more information, see *About DVD recording* on page 37.
 - *What's VR mode?*
VR (Video Recording) mode is a special mode designed for home DVD recording. It allows flexible editing of recorded material compared to 'Video mode'. On the other hand, Video mode discs are more compatible with other DVD players.
 - *How do I change the format of a disc?*
Both DVD-R and DVD-RW discs can be initialized for Video mode or VR mode recording. DVD-R discs are ready for Video mode recording when you first load them into the recorder. You can, however, initialize them for VR mode recording from the Disc Setup menu.
DVD-RW discs can be initialized and re-initialized for either mode at any time (although initializing will erase all the data on the disc).
 - *Can I play my recordable discs in a regular DVD player?*
Generally, DVD-R discs and DVD-RW discs recorded in Video mode* are playable in a standard DVD player, but they must be 'finalized' first. This process fixes the contents of the disc to make them readable to other DVD players as DVD-Video discs.
DVD-R discs recorded in VR mode are not playable in standard DVD players, but may be playable in other DVD recorders and DVD-ROM drives (in the case of DVD-ROM drives, the disc will need to be finalized first).
DVD-RW discs recorded in VR mode are playable in some players and other recorders.
Note that discs may not play due to recording or disc characteristics, scratches or dirt on the disc or pickup lens, etc.
- RW COMPATIBLE** This label indicates playback compatibility with DVD-RW discs recorded in VR mode (Video Recording format). However, for discs recorded with a record-only-once encrypted program, playback can only be achieved using a CPRM compatible device.
Note that Pioneer cannot guarantee that discs recorded using this recorder will play on other players.

* 'DVD-Video format' recording: The use of the DVD-Video format for recording on DVD-R and DVD-RW discs is referred to as recording in 'Video mode' on Pioneer's DVD recorders. Supporting playback of DVD-R / DVD-RW discs is optional for manufacturers of DVD playback equipment, and there is DVD playback equipment that does not play DVD-R or DVD-RW discs recorded in the DVD-Video format.

Note: 'Finalization' is required.

This recorder supports the recording of 'copy-once' broadcast programs using the CPRM copy protection system (see CPRM on page 38) on CPRM-compliant discs in VR mode. CPRM recordings can only be played on players that are specifically compatible with CPRM.

- Do I need two DVD recorders for editing? What kind of editing can I do?

Unlike editing video tape, you only need one DVD recorder to edit discs. With VR mode discs, you can edit by making a 'Play List' of what to play and when to play it. On playback, the recorder plays the disc according to the Play List.

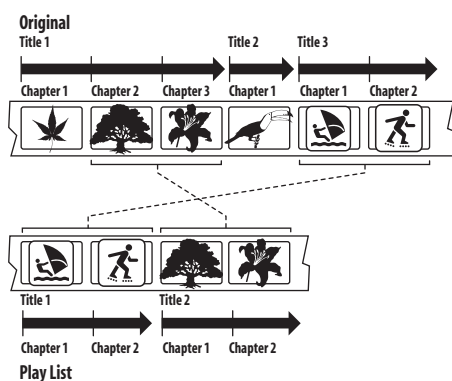

Throughout this manual, you will often see the words Original and Play List to refer to the actual content and the edited version.

- **Original** content refers to what's actually recorded on the disc.
- **Play List** content refers to the edited version of the disc—how the Original content is to be played.

About the internal hard disk drive

The internal hard disk drive (HDD) is a fragile piece of equipment. Depending on the conditions under which it is used, or through careless use, it is possible that the recorded contents will be damaged or lost completely, or that normal playback and recording will not be possible. Please understand that in the event of repair or replacement of the HDD or related components, all your HDD recordings will be lost.

Please use the recorder following the guidelines below to protect against possible HDD failure.

The HDD should not be regarded as a place to store recordings permanently. We recommend that you back up your important recordings onto DVD-R/RW discs in order to protect against accidental loss.

Pioneer cannot under any circumstances accept responsibility for any direct or indirect loss arising from any inconvenience or loss of recorded material resulting from HDD failure.

- Install and use the recorder on a stable, level surface.
- Do not block the rear vent/cooling fan.
- Do not use the recorder in excessively hot or humid places, or in places that may be subject to sudden changes in temperature. Sudden changes in temperature can cause condensation to form inside the recorder. This can be a cause of HDD failure.
- Do not move the recorder immediately after switching it off. If you need to move the recorder, please follow the steps below:
 - 1 After the message **POWER OFF** is shown in the display, wait at least two minutes.
 - 2 Unplug from the wall socket.
 - 3 Move the recorder.
- If there's a power failure while the recorder is on there is a chance that some data on the HDD will be lost.
- The HDD is very delicate. If used improperly or in an unsuitable environment, it is possible that the HDD will fail after a few years of use. Signs of problems include playback unexpectedly freezing and noticeable block noise (mosaic) in the picture. However, sometimes there will be no warning signs of HDD failure. If the HDD fails, no playback of recorded material will be possible. In this case it will be necessary to replace the HDD unit.

Optimizing HDD performance

As you record and edit material on the HDD, the data on the disk becomes fragmented, eventually affecting the recorder's performance. Before this happens, the recorder will warn you that it is time to optimize the HDD (which you can do from the Disc Setup menu; see *Optimize HDD* on page 88).

Chapter 2

Connecting up

Rear panel connections

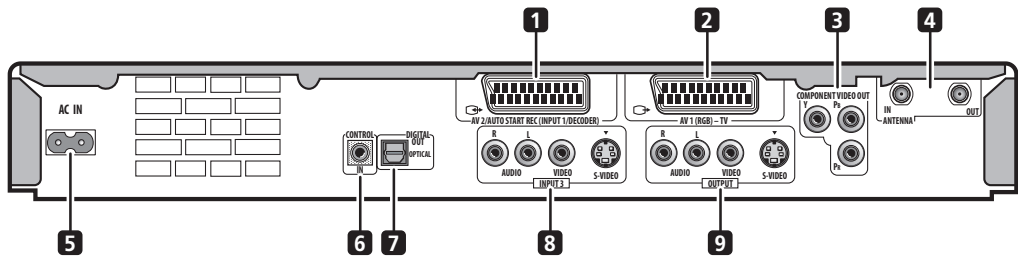
**1 AV2/AUTO START REC(INPUT 1/DECODER) AV connector**

Audio/video input/output SCART-type AV connector for connecting to a VCR, or other equipment with a SCART connector. The input accepts video, S-video and RGB. See *AV2/L1 In* on page 94 for how to set this up.

2 AV1(RGB)-TV AV connector

Audio/video output SCART-type AV connector for connecting to a TV or other equipment with a SCART connector. The video output is switchable between video, S-video and RGB. See page *AV1 Out* on page 94 for how to set this up.

3 COMPONENT VIDEO OUT

A high-quality video output for connecting to a TV or monitor with a component video input.

4 ANTENNA IN (RF IN)/OUT

Connect your TV antenna to the **ANTENNA IN (RF IN)** jack. The signal is passed through to the **ANTENNA OUT** jack for connection to your TV.

5 AC IN – Power inlet**6 CONTROL IN**

Use to control this recorder from the remote sensor of another Pioneer component with a **CONTROL OUT** terminal and bearing the Pioneer SR mark. Connect the **CONTROL OUT** of the other component to the **CONTROL IN** of this recorder using a mini-plug cord.

7 DIGITAL AUDIO OUT

Optical digital audio jack for connecting to an AV amplifier/receiver, Dolby Digital/DTS/MPEG decoder or other equipment with a digital input.

8 INPUT 3

Stereo analog audio, video and S-video inputs for connection to a VCR or other source component.

9 OUTPUT

Stereo analog audio, video and S-video outputs for connection to a TV or AV amplifier/receiver.

Front panel connections

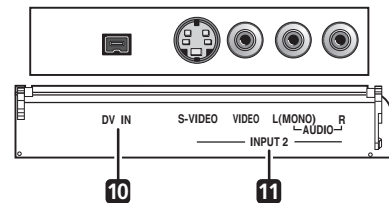

On the right side of the front panel a flip-down cover hides more connections.

10 DV IN

A DV input i.LINK connector, suitable for connecting a DV camcorder.

11 Audio/video input 2

Audio/video input (stereo analog audio; composite and S-video video), especially suitable for camcorders, game consoles, portable audio, etc.

Extra features for use with compatible TVs

When this recorder is connected to a TV that features i/o Link, A, AV Link, T-V Link, EasyLink, MegaLogic, SMARTLINK, Q-Link, DATA LOGIC or NexTVView Link using a fully-wired 21-pin SCART cable (not supplied), the following functions are available:

- Direct TV recording
- Channel preset download
- NexTVView timer programming download
- TV auto power on
- System configuration

For further details and compatibility information, see also the manual that came with your TV.

Direct TV recording

Direct TV recording allows you to record the TV program that you're watching, without having to worry about whether this recorder is set to the same channel. See *Direct recording from TV* on page 40 for more on this feature.

Channel preset download

This feature allows you to set up the channel presets of this recorder very simply using the channel presets and preset names already in your TV. See *Switching on and setting up* on page 25 and *Auto Channel Setting* on page 93 for more on this feature.

NexTVView timer programming download

NexTVView timer programming download allows you to program a timer recording directly from the NexTVView electronic program guide displayed on your TV.

See the manual that came with your TV for more information on how to use this feature. Note that the **SP** and **LP** options displayed on your TV correspond to the **SP** and **LP** recording modes on this recorder.

TV auto power on

When you play a disc in this recorder, the TV automatically turns on and switches to the correct video input. See the manual that came with your TV for how to use this feature.

System configuration

Basic settings, including language, country and TV screen size (aspect ratio), can be downloaded from your TV to help set up this recorder for use.

Easy connections

The setup described below is a basic setup that allows you to watch and record TV programs, and play discs. Other types of connections are explained starting on the following page.

Important

- These connections use SCART cables (not supplied). If your TV (or VCR) does not have a SCART connection, see the following page for connecting up using the supplied audio/video cable.
- The **AV1(RGB)-TV** AV connector can output ordinary (composite), S-video or RGB video, plus stereo analog audio. The **AV2/AUTO START REC(INPUT 1/DECODER)** connector accepts ordinary, S-video and RGB video input, as well as stereo analog audio. See *AV1 Out* on page 94 and *AV2/L1 In* on page 94 for how to set them up.
- Before making or changing any rear panel connections, make sure that all components are switched off and unplugged from the wall outlet.

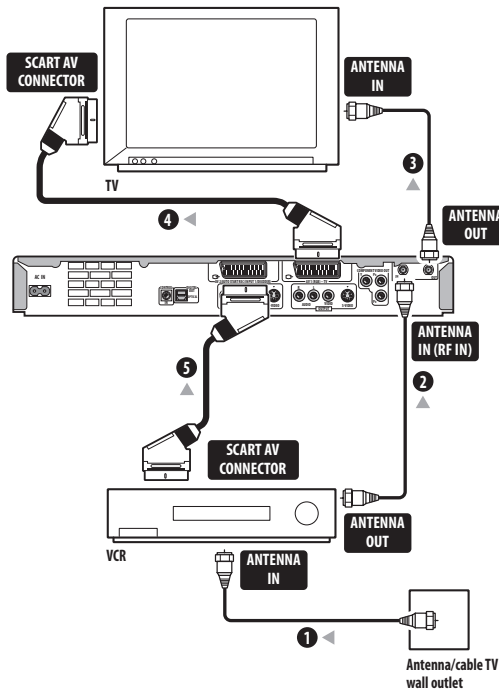

1 Connect the cable from the antenna/cable TV outlet to the antenna input on your VCR.

- If you are not connecting a VCR in the chain, connect it to the **ANTENNA IN (RF IN)** jack on this recorder and skip the next step.

2 Use an RF antenna cable (one is supplied) to connect the antenna output of your VCR to the ANTENNA IN (RF IN) of this recorder.

3 Use another RF antenna cable to connect the ANTENNA OUT of this recorder to the antenna input on your TV.

4 Use a SCART cable (not supplied) to connect the AV1(RGB)-TV AV connector on this recorder to the SCART AV connector on your TV.

5 Use another SCART cable to connect the AV2/AUTO START REC(INPUT 1/DECODER) AV connector to a SCART AV connector on your VCR.

Tip

- This recorder has a 'through' function which allows you to record a TV program from the built-in TV tuner in this recorder while watching a video playing on your VCR. (To use this feature when the recorder is in standby, **Power Save** must be set to **Off**—see *Power Save* on page 92).

Using other types of audio/video output

If you can't use the SCART AV connector to connect your TV to this recorder, there are standard audio/video output jacks, as well as an S-video and component video output.

Using the supplied audio/video cable

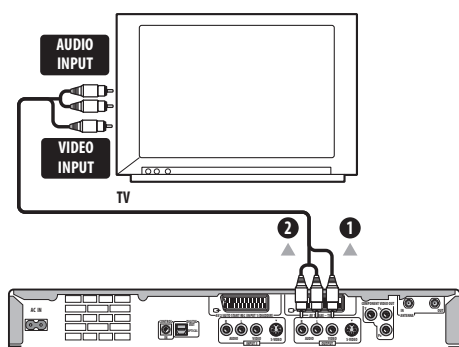

1 Connect the VIDEO OUTPUT jack to a video input on your TV.

Use the yellow jack of the supplied audio/video cable for the video connection.

2 Connect the AUDIO OUTPUT jacks to the corresponding audio inputs on your TV.

Use the red and white jacks of the supplied audio/video cable for the audio connection. Make sure you match up the left and right outputs with their corresponding inputs for correct stereo sound.

Using the S-video or component video output

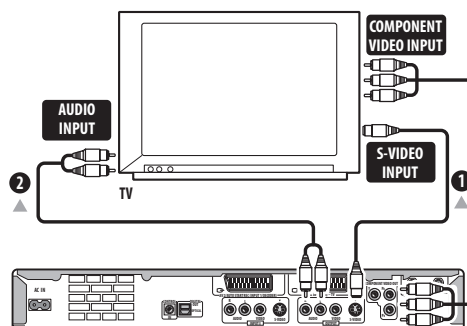

1 Connect the S-video or component video output to a similar input on your TV.

For an S-video connection, use an S-video cable (not supplied) to connect the **S-VIDEO OUTPUT** jack to an S-video input on your TV.

For a component video connection, use a component video cable (not supplied) to connect the **COMPONENT VIDEO OUT** jacks to a component video input on your TV.

See also *Component Video Out* on page 94 for how to set up the component video output for use with a progressive scan-compatible TV.

2 Connect the AUDIO OUTPUT jacks to the corresponding audio inputs on your TV.

You can use the supplied audio/video cable, leaving the yellow video plug disconnected. Make sure you match up the left and right outputs with their corresponding inputs for correct stereo sound.

Connecting to a cable box, satellite receiver or digital terrestrial receiver

If you have a cable, satellite or digital terrestrial receiver with a built-in decoder, connect it to this recorder and your TV as shown on this page.¹ If you are using a separate decoder box for your cable/satellite TV, set up following the instructions on the next page.

Using the setup on this page you can:

- Record any channel by selecting it on the cable box, satellite receiver or digital terrestrial receiver.

Important

- Do not connect this recorder to your TV 'through' your VCR, satellite receiver or other component. Always connect each component directly to your TV or AV amplifier/receiver.

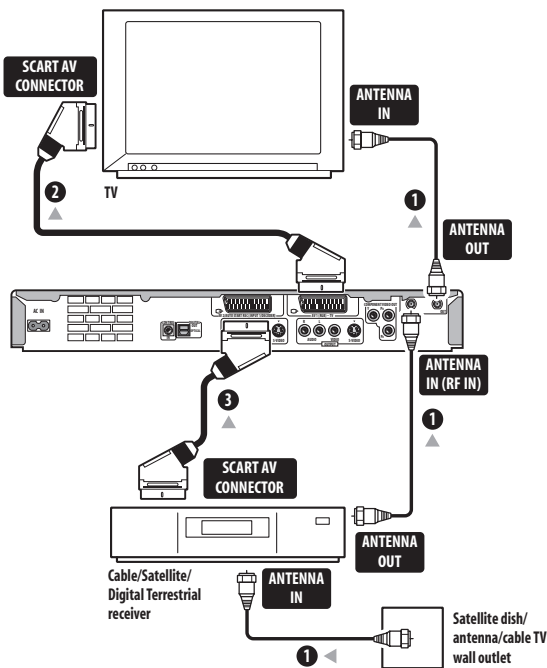

Tip

- This recorder has a 'through' function which allows you to record a TV program from the built-in TV tuner in this recorder while watching a video playing on your VCR. (To use this feature when the recorder is in standby, **Power Save** must be set to **Off**—see *Power Save* on page 92).

1 Connect RF antenna cables as shown.

This enables you to watch and record TV channels.

2 Use a SCART cable (not supplied) to connect the AV1(RGB)-TV AV connector to a SCART AV connector on your TV.

This enables you to watch discs.

3 Use another SCART cable to connect the AV2/AUTO START REC(INPUT 1/DECODER) AV connector to a SCART AV connector on your cable box/satellite/digital terrestrial receiver.

This enables you to record scrambled TV channels.

Note

¹ The diagram shows SCART video connections, but you can alternatively use any of the other audio/video connections.

Connecting an external decoder box (1)

If you have an external, dedicated decoder box for your satellite or cable TV system, use the setup described on this page.

Important

- Do not connect your decoder box directly to this recorder.
- Information from the decoder (for example, relating to pay TV services), is only viewable when this recorder is off (in standby).
- For timer recording to work properly on this recorder, the VCR/satellite receiver/cable box must also be switched on during recording.
- It is not possible to watch one TV program and record another using this setup.

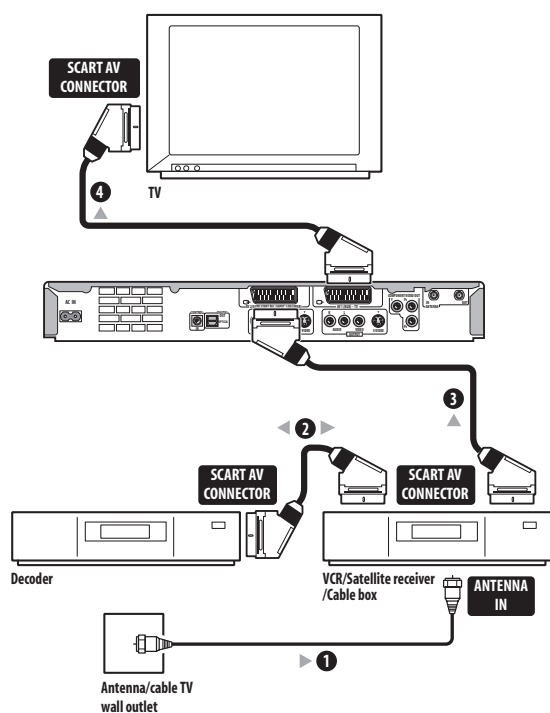

1 Connect the cable from the antenna/cable TV outlet to the antenna input on your VCR/satellite receiver/cable box.

2 Use a SCART cable (not supplied) to connect your decoder to your VCR/satellite receiver/cable box. See the manual for your decoder box for more detailed instructions.

3 Use a SCART cable to connect your VCR/satellite receiver/cable box to the AV2/AUTO START REC(INPUT 1/DECODER) AV connector on this recorder.

4 Use a SCART cable to connect the AV1(RGB)-TV AV connector to your TV.

Connecting an external decoder box (2)

If you only have a decoder, connect it to this recorder and your TV as shown on this page.¹

Using the setup on this page you can:

- Record scrambled channels received using the recorder's built-in TV tuner.

Important

- Do not connect this recorder 'through' your VCR, satellite receiver or cable box. Always connect each component directly to your TV or AV amplifier/receiver.

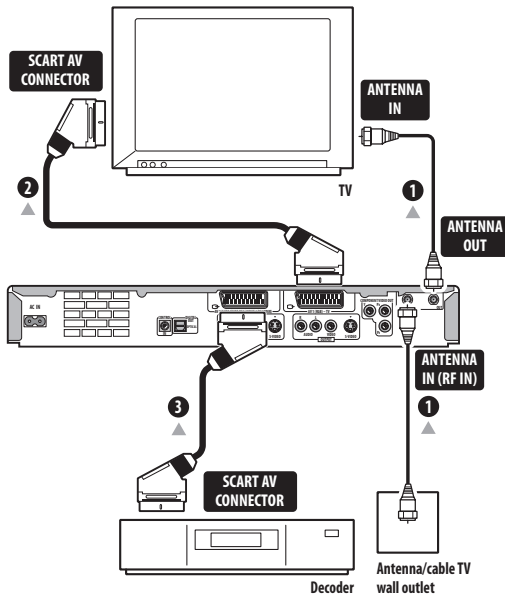

1 Connect RF antenna cables as shown.

This enables you to watch and record TV channels.

2 Use a SCART cable (not supplied) to connect the AV1(RGB)-TV AV connector to a SCART AV connector on your TV.

This enables you to watch discs.

3 Use another SCART cable to connect the AV2/AUTO START REC(INPUT 1/DECODER) AV connector to a SCART AV connector on your decoder box.

This enables you to record scrambled TV channels.

Note

¹ In order to use this setup, you will need to make the following settings from the Initial Setup menu:

- Set the **AV2/L1 In** setting to **Decoder** from the Initial Setup menu (see *AV2/L1 In* on page 94).
- From the **Manual CH Setting** screen, set the **Decoder** setting for the scrambled channels to **On** (see *Manual CH Setting* on page 93).

Connecting to an AV amplifier/receiver

To enjoy multichannel surround sound you need to connect this recorder to an AV amplifier/receiver using the digital optical output.

In addition to a digital connection, we recommend also connecting using the stereo analog connection for compatibility with all discs and sources.

You'll probably also want to connect a video output to your AV amplifier/receiver. Use the ordinary video output (as shown here), or the S-video output.

Important

- Noise may be output from your speakers if the recorder is not set up to work with your AV amplifier/receiver properly (see *Audio Out Settings* on page 95).

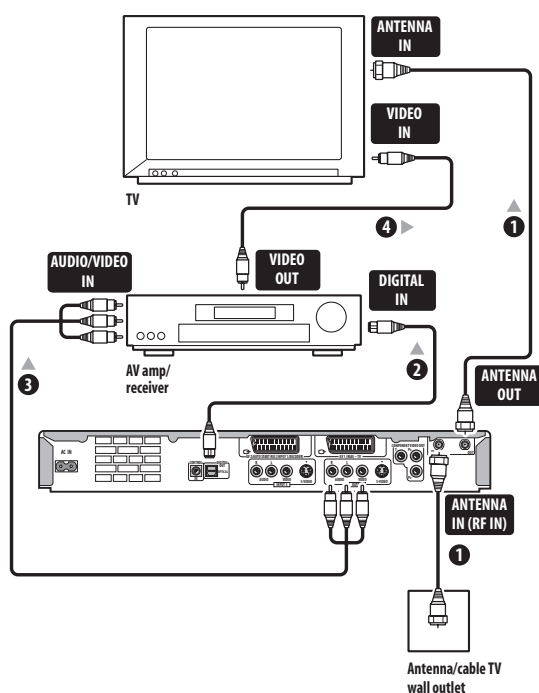

1 Connect RF antenna cables as shown.

This enables you to watch and record TV channels.

2 Connect one of the DIGITAL OUT OPTICAL jack on this recorder to an optical digital input on your AV amplifier/receiver.

This enables you to listen to multichannel surround sound.

3 Connect the analog AUDIO OUTPUT and VIDEO OUTPUT jacks on this recorder to an analog audio and video input on your AV amplifier/receiver.

4 Connect the AV amplifier/receiver's video output to a video input on your TV.

Important

- Do not connect this recorder to your TV 'through' your VCR using A/V cables. Always connect it directly to your TV.

Connecting other AV sources

Connecting a VCR or analog camcorder

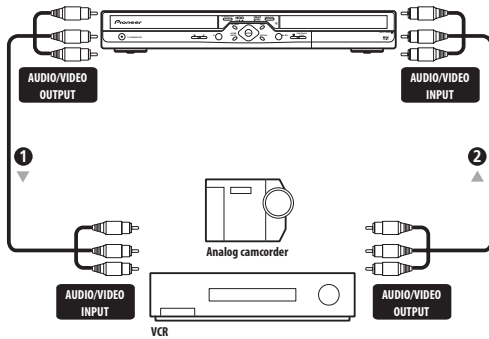

1 Connect a set of audio and video inputs of your VCR or camcorder to a set of outputs on this recorder.

This enables you to record from this recorder to your VCR or camcorder.

- You can use standard video or S-video cables for the video connection.
- Alternatively, you can use the **AV2/AUTO START REC(INPUT 1/DECODER) SCART** connector for audio/video input and output with just one SCART cable.

2 Connect a set of audio and video outputs of your VCR or camcorder to a set of inputs on this recorder.

This enables you to record tapes from your VCR or camcorder.

- You can use standard video or S-video cables for the video connection.
- The front panel connections make convenient connections for a camcorder input.

Connecting a DV camcorder

Using the front panel **DV IN** jack, it is possible to connect a DV camcorder or video deck, or DVD-R/RW recorder and digitally transfer DV tapes or DVD-R/RW discs to DVD-R/RW.



Important

- This jack is for connection to DV equipment only. It is not compatible with digital satellite receivers or D-VHS video decks.

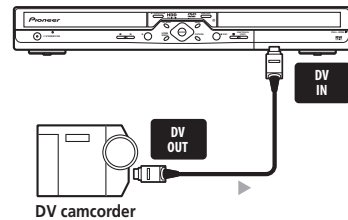

1 Use a DV cable (not supplied) to connect the DV jack of your DV camcorder/video deck to the front panel DV IN jack of this recorder.

Plugging in

After checking all the connections, plug in the recorder.

1 Use the supplied power cable to connect this recorder to a power outlet.

Chapter 3

Controls and displays

Front panel

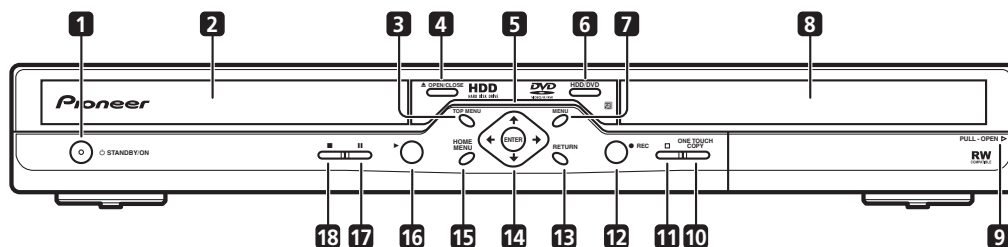

1 STANDBY/ON

Press to switch the recorder on/into standby.

2 Disc tray

3 DISC NAVIGATOR/TOP MENU

Press to display the Disc Navigator screen, or the top menu if a DVD-Video disc is loaded.

4 OPEN/CLOSE

Press to open/close the disc tray.

5 HDD/DVD indicator

Lights blue when the HDD is selected; orange when DVD is selected.

6 HDD/DVD

Press to switch between the hard disk drive (HDD) and DVD for recording and playback.

7 MENU

Press to display a DVD-Video disc menu.

8 Front panel display and IR remote sensor

See *Display* on page 24 for details.

9 Front panel inputs (page 12)

Pull the cover down where indicated to access the front panel input jacks (audio, video and DV). Especially convenient for connecting camcorders and other portable equipment.

10 ONE TOUCH COPY (page 63)

Press to start One Touch Copy of the currently playing title to DVD or the HDD. See also the *Note on copying* on page 7.

11

Press to stop recording.

12 ● REC

Press to start recording. Press repeatedly to set the recording time in 30 minute blocks.

13 RETURN

Press to go back one level in the on-screen menu or display.

14 ↑/↓/←/→ and ENTER

Used to navigate all on-screen displays. Press **ENTER** to select the currently highlighted option.

When stopped, the ↑/↓ buttons can also be used to change the TV channel.

15 HOME MENU (page 34)

Press to display the Home Menu, from which you can navigate all the functions of the recorder.

16 ►

Press to start or restart playback.

17 ||

Press to pause or resume playback.

18 ■

Press to stop playback.

Remote control

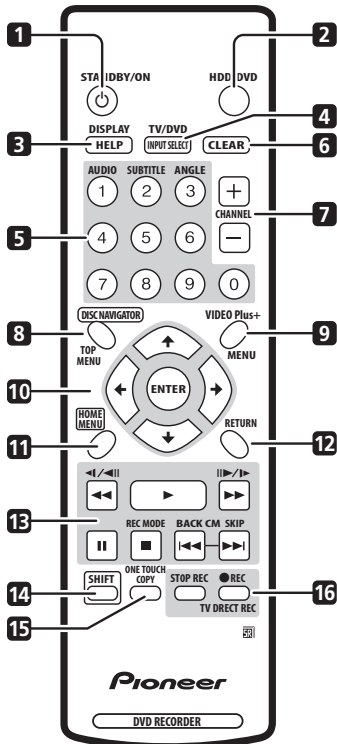

1 STANDBY/ON

Press to switch the recorder on/into standby.

2 **HDD/DVD** (page 27)

Press to select the hard disk (HDD) or DVD for recording or playback.

3 **HELP**

Press for help on how to use the current GUI screen.

DISPLAY (SHIFT + HELP) (page 34)

Displays/changes the on-screen information displays.

4 **INPUT SELECT** (page 48)

Press to change the input to use for recording.

TV/DVD (SHIFT + INPUT SELECT) (page 30)

Press to switch between 'TV mode', in which you get the picture and sound from the TV's tuner, and 'DVD mode', in which you get picture and sound from the recorder's tuner (or an external input).

5 **Number buttons**

Use the number buttons for track/chapter/title selection; channel selection, and so on. The same buttons can also be used to enter names for titles, discs and so on.

AUDIO (SHIFT + 1) (page 29, 61)

Changes the audio language or channel. (When the recorder is stopped, press to change the tuner audio.)

SUBTITLE (SHIFT + 2) (page 60)

Displays/changes the subtitles included in multilingual DVD-Video discs.

ANGLE (SHIFT + 3) (page 62)

Switches camera angles on discs with multi-angle scenes.

6 **CLEAR**

Use to clear an entry and start again.

7 **CHANNEL +/-** (page 29)

Press to change the channel of the built-in TV tuner.

8 **DISC NAVIGATOR** (page 54, 73) / **TOP MENU**

(page 32)

Press to display the Disc Navigator screen, or the top menu if a DVD-Video disc is loaded.

9 **VIDEO Plus+ (SHIFT + MENU)** (page 43) / **MENU**

(page 32)

Press to set a timer program using VIDEO Plus+, or display the disc menu if a DVD-Video disc is loaded.

10 and **ENTER**

Used to navigate all on-screen displays. Press **ENTER** to select the currently highlighted option.

11 **HOME MENU** (page 34)

Press to display the Home Menu, from which you can navigate all the functions of the recorder.

12 **RETURN** (page 98)

Press to go back one level in the on-screen menu or display. Also used for setting the remote control mode.

13 **Playback controls** (page 31)

/ (page 56)

Press to start reverse or forward scanning. Press again to change the speed.



Press to start playback.



Press to pause playback or recording.



Press to stop playback.

REC MODE (SHIFT + ■) (page 39)

Press repeatedly to change the recording mode (picture quality).



Press to skip to the previous or next title/chapter/track/folder; or to display the previous or next menu page.

CM BACK (SHIFT + I◀◀) (commercial back)

Press repeatedly to skip progressively backward through the audio or video playing.

CM SKIP (SHIFT + ▶▶I) (commercial skip)

Press repeatedly to skip progressively forward through the audio or video playing.



While paused, press and hold to start slow-motion playback. Press repeatedly to change the playback speed.

While paused, press to advance a single frame in either direction.

14 SHIFT

Hold down **SHIFT** to access the functions on the remote printed in green. For example, press and hold **SHIFT**, then press ■ for **REC MODE**.

15 ONE TOUCH COPY (page 63)

Press to start One Touch Copy of the currently playing title to DVD or the HDD.

16 Recording controls (page 28) **STOP REC**

Press to stop recording.

 REC

Press to start recording. Press repeatedly to set the recording time in blocks of 30 mins.

TV DIRECT REC (SHIFT + ● REC) (page 40)

Press to start recording whatever channel your TV is set to.

Display

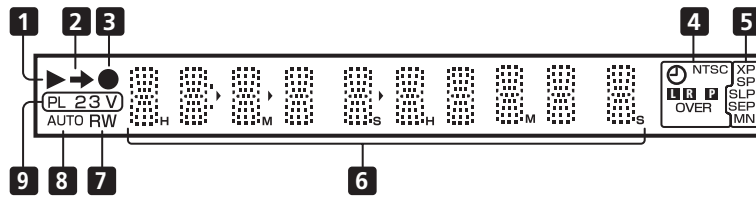

- 1** ▶
Lights during playback; blinks when playback is paused.
- 2** →
Lights when copying.
- 3** ●
Lights during recording; blinks when recording is paused.
- 4** ⏸ (page 41)
Lights when a timer recording has been set. (Indicator blinks if the timer has been set to DVD but there isn't a recordable disc loaded, or the timer has been set to HDD but the HDD is not recordable.)
- NTSC**
Lights when playing NTSC format video.
- L R** (page 95)
Indicates which channels of a bilingual broadcast are recorded.
- P** (page 94)
Lights when the component video output is set to progressive scan.
- OVER** (page 95)
Lights when the analog audio input level is too high.
- 5 Recording quality indicators** (page 38)
- XP**
Lights when the recording mode is set to **XP** (best quality).
- SP**
Lights when the recording mode is set to **SP** (standard play).
- LP / SLP**
Lights when the recording mode is set to **LP** (long play) or **SLP** (super long play).
- EP / SEP**
Lights when the recording mode is set to **EP** (extended play) or **SEP** (super extended play).
- MN**
Lights when the recording mode is set to **MN** (manual recording level) mode.
- 6 Character display**
- 7 R / RW**
Indicates the type of recordable DVD loaded: DVD-R or DVD-RW.
- 8 AUTO**
Lights when Auto Start Recording has been set, and during Auto Start Recording.
- 9 PL** (page 73)
Lights when a VR mode disc is loaded and the recorder is in Play List mode.
- 2 3** (page 98)
Shows the remote control mode (if nothing is displayed, the remote control mode is 1).
- V**
Lights when an unfinalized Video mode disc is loaded.

Chapter 4

Getting started

Switching on and setting up

When you switch the recorder on for the first time, you can make several basic settings using the Setup Navigator feature. This takes you through setting the clock, the internal TV tuner and the video output settings. If you're using the recorder for the first time, we strongly recommend you use the Setup Navigator before starting to use the recorder.

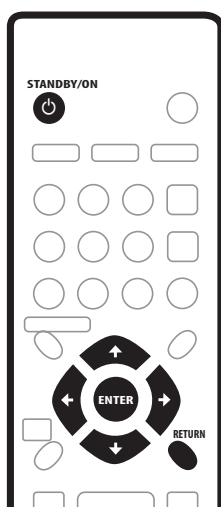

1 Switch on your TV and set the video input to this recorder.

2 Press the **STANDBY/ON** button on the remote control or the front panel to switch on.

When you switch on for the first time, your TV should display the Setup Navigator screen. (If the Setup Navigator doesn't appear, you can also access it from the Initial Setup menu; see page 92).

- If this recorder is connected to a compatible TV using a fully-wired 21-pin SCART cable, the recorder will take a few seconds to download country, TV screen size and language information. (Check the manual that came with your TV for compatibility information.)

3 Use the **↑/↓** buttons to choose a language, then press **ENTER**.

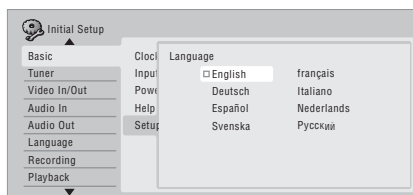

4 Press **ENTER** to start setting up using the Setup Navigator.

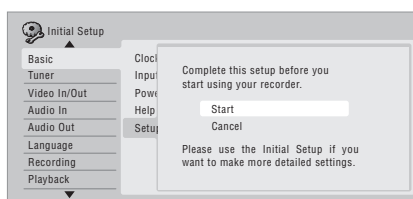

- If you don't want to use the Setup Navigator, press **↓** to select **Cancel**, then press **ENTER** to exit the Setup Navigator.

5 Select the Auto Channel Setting ('Auto Scan' or 'Download from TV'), or 'Do not set', then press **ENTER**.

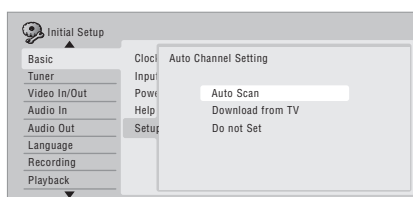

- Select **Do not set** if you want to skip setting up the channels (because they have already been set up, for example).
- You can only use the **Download from TV** feature if you connected this recorder to your TV using a fully-wired 21-pin SCART cable connected to the **AV1(RGB)-TV** connector, and if your TV supports this function (check your TV's instruction manual for more details).

- Use the **←/→** buttons to choose your country, then press **ENTER**.



- **Auto-tuning channels**

The **Auto Scan** option automatically scans and sets the channel presets.

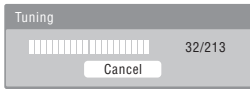

- **Downloading channels from your TV**

Use the **Download from TV** option to download all the channels that your TV is tuned to.



6 Select 'Auto' for automatic time setting, or 'Manual' to set the clock manually, then press ENTER.

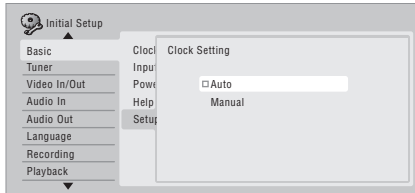

- **Auto clock setting**

Some TV channels broadcast time signals together with the program. This recorder can use these signals to set the clock automatically.

Set 'Clock Set CH' to the channel preset number that broadcasts a time signal, then move the cursor down to 'Start' and press ENTER.

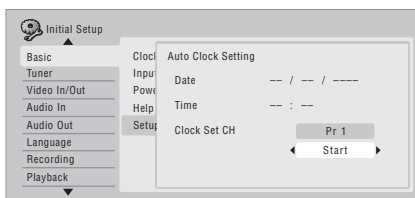

The recorder takes a short while to set the time. After you see that the time has been set, select **Next** to proceed.

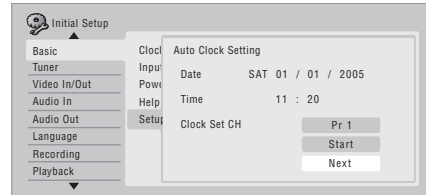

If the time could not be set automatically, press **RETURN** to go back to the previous screen and select **Manual**.

- **Manual clock setting**

If no stations in your area are broadcasting time signals, you can set the clock manually.

Use the ←/→ buttons to set your time zone.

You can set this by selecting a city or a time relative to GMT.

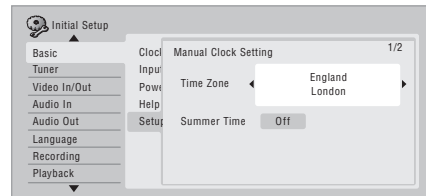

Press ↓ then use the ←/→ buttons to select 'On' or 'Off' for summer time, then press ENTER.

Select **On** if you are currently using summer time.

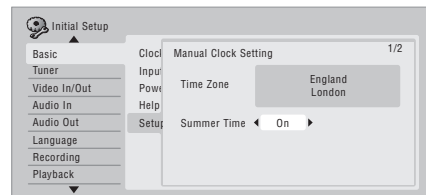

Set the date (day/month/year) and time, then press ENTER to make all the settings.

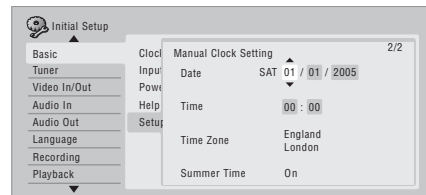

Use the **↑/↓** buttons to change the value in the highlighted field.

Use the \leftarrow/\rightarrow buttons to move from one field to another.

- You can go back to the previous screen at anytime in the Setup Navigator by pressing **RETURN**.

7 Select the TV screen type, 'Wide (16:9)' or 'Standard (4:3)'.

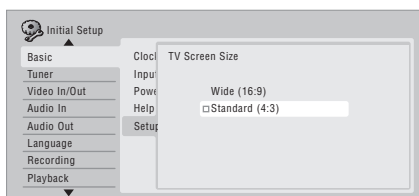

Use the \uparrow/\downarrow buttons to select, then press **ENTER**.

8 Is your TV compatible with progressive scan video?

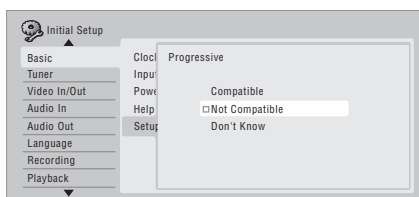

Use the \uparrow/\downarrow buttons to select **Compatible**, **Not Compatible**, or **Don't Know**, then press **ENTER**.

- Note that progressive scan video is only output through the **AV1(RGB)-TV** connector and the component video outputs.

9 Press **ENTER** to exit the Setup Navigator, or select 'Go Back' if you want to start again.

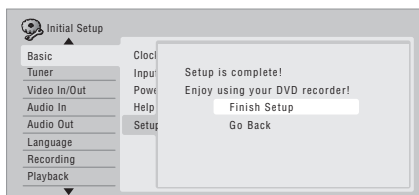

That completes basic setup using the Setup Navigator.

Other settings you can make

After setting up using the Setup Navigator, you should be ready to start enjoying your DVD recorder. It's possible, however, that you may want to make a couple of additional settings, depending on how the recorder is set up for terrestrial TV broadcasts.

- Manual channel setting – This setting lets you skip channels where there is no station, as well as manually tune to stations. See *Manual CH Setting* on page 93.
- If for any reason you need to cancel the setup process before it's completed, you will be asked the next time you switch on whether you want to start setting up again, or whether to leave it until later.

Selecting the hard disk or DVD for playback and recording

The **HDD/DVD** button (remote control and front panel) is used to select the hard disk (HDD) or DVD for playback and recording. The indicator in the front panel display shows which is currently selected.

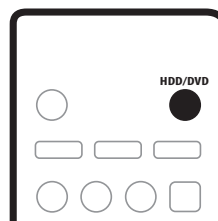

Making your first recording

This quick guide shows you how to make a basic recording of a TV program on either the HDD, or to a recordable DVD.

Recording is covered in much more detail in chapter 5 (*Recording*).

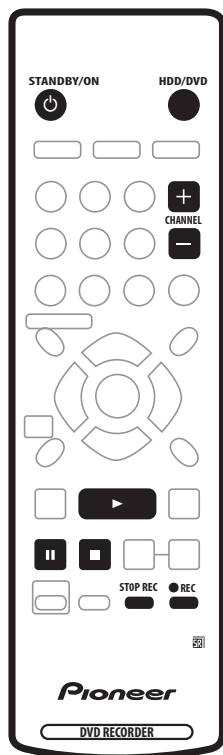

1 If they aren't already on, switch on your TV and this recorder.

Press **STANDBY/ON** to switch on.

- Make sure that the video input on your TV is set to this recorder.

2 Use the HDD/DVD button to select the HDD or DVD as the recording destination.

If you choose to record to the HDD, skip to step 5 now.

3 Press **▲ OPEN/CLOSE** (front panel only) to open the disc tray.

4 Load a blank DVD-R or DVD-RW disc with the label side face-up, using the disc guide to align the disc.

- When you load a new, blank DVD-RW disc, the recorder will take a moment to initialize it for recording.
- Blank DVD-R discs are ready for Video mode recording out of the box.

5 Use the CHANNEL +/- buttons to select the TV channel you want to record from.

- Channel presets are numbered 1–99.
- If the recorder is connected to your TV using a SCART cable and your TV supports Direct Recording, it's possible to quickly start recording whatever channel your TV is tuned to. See *Direct recording from TV* on page 40 for detailed instructions.

6 Press **● REC** to start recording.

- By default, the recording will be in **SP** (standard play) mode, which will give you around two hours of recording from a blank DVD disc. The different recording modes and their recommended uses are covered in more detail in the chapter on Recording.
- You can pause recording by pressing **II**. Press **● REC** or **II** again to restart recording.

7 When you want to stop recording, press **□ STOP REC**.

Playing back your recording

The TV program you just recorded should be on the HDD or DVD disc as a single title with one or more chapters.

• Press **▶** to start playback.

If you want to stop playback before the end of the recording, press **■**.

Using the built-in TV tuner

Changing TV channels

There are three different ways to select TV channels. Note that you can't change the TV channel during playback, recording or during recording standby.

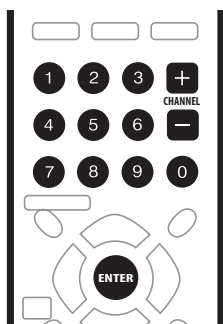

- **CHANNEL +/-** buttons on the remote
- **Number buttons** on the remote – For example, to select channel 4, press **4** then **ENTER**; for channel 34, press **3**, **4**, **ENTER**.¹

Changing audio channels

You can change the audio channel of the broadcast or external input signal.

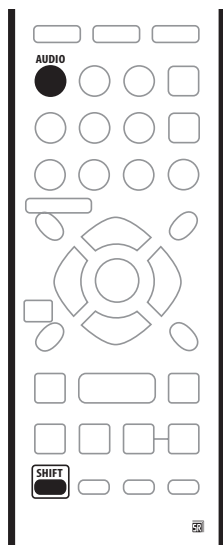

- **Press AUDIO (SHIFT + 1) to change the audio.** The current audio channel is displayed on-screen.

- If the NICAM audio setting (see *Nicam Select* on page 94) is set to **NICAM** and you are watching a NICAM broadcast, you can switch between **NICAM** and **Regular** (non-NICAM) audio.



- If the NICAM broadcast is bilingual, you can also select the language.

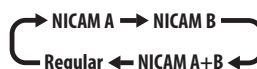

- You can also select the language for a non-NICAM bilingual broadcast.

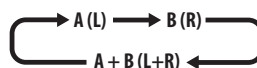

- When watching a recording made from an external input with **Bilingual** recording selected (see *External Audio* on page 94), you can switch the audio channel between left (**L**), right (**R**) or both (**L+R**).

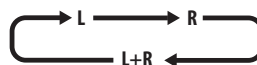

Tip

- When recording to the HDD with HDD Recording Format set to Video Mode On, to DVD in Video mode, or on the **LPCM** setting, only one channel of a bilingual broadcast is recorded. In this case, decide which language you want to record before recording by setting the Bilingual Recording setting (see *Bilingual Recording* on page 95).

Note

1. Channel presets are numbered 1–99.

Switching between TV and DVD

When the recorder is stopped or recording you can choose whether to have the audio/video from the built-in TV tuner (or external input) play on your TV ('DVD mode'), or watch the channel that the TV is currently set to ('TV mode').

During playback or when a menu is being displayed on-screen, the sound and video is always routed to your TV and is unaffected by the **TV/DVD (SHIFT + INPUT SELECT)** mode setting.

Note that the recorder must be connected to your TV using a SCART cable to be able to use this feature.

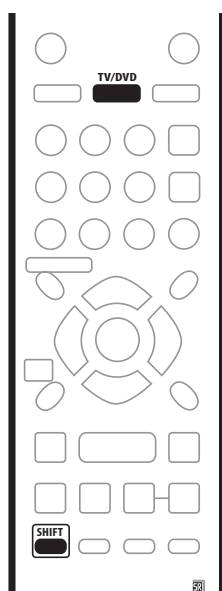

- Press **TV/DVD (SHIFT + INPUT SELECT)** to switch between TV mode and DVD mode.

Basic playback

This section shows you how to use your recorder for playback of discs (DVD, CD, etc.), and for playback of video from the HDD. More playback features, such as repeat and program play, are covered in *Playback* on page 53.

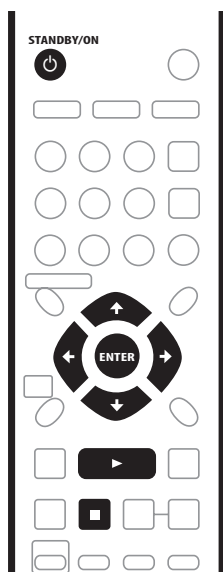

Important

- Throughout this manual, the term 'DVD' means playback-only DVD-Video discs and DVD-R/RW. If a function is specific to a particular kind of DVD disc, it is specified.
- Some DVD-Video discs don't allow certain playback controls to operate at certain points in the disc. This is not a malfunction.

1 Press **STANDBY/ON** to switch on.

Also turn on your TV and make sure that it is set to the correct video input.

2 Press **HDD/DVD** to select either the HDD or the DVD for playback.

If playing video from the HDD, skip to step 5 below.





3 Press **OPEN/CLOSE** (front panel only) to open the disc tray.

4 Load a disc.

Load a disc with the label side facing up, using the disc tray guide to align the disc (if you're loading a double-sided DVD-Video disc, load it with the side you want to play face down).



- If you want to play a DTS audio CD, please first read the note on page 33.

5 Press to start playback.

- If you're playing a DVD-Video or Video CD, a disc menu may appear when you start playback. Use the /// buttons and **ENTER** to navigate DVD disc menus, and the number buttons and **ENTER** for Video CD menus.
- When playing video from the HDD, playback will automatically stop after the end of a title is reached.
- See the following sections for more details on playing specific kinds of discs.

6 To stop playback, press .

7 When you've finished using the recorder, eject the disc and switch the recorder back into standby.

- To open/close the disc tray, press  **OPEN/CLOSE** (front panel). Remove the disc before putting the recorder into standby.
- Press  **STANDBY/ON** to switch the recorder into standby.

Playing DVD discs

The table below shows the basic playback controls for DVD-Video, and recordable DVD discs.



Press to start playback.
If **RESUME** is displayed on-screen, playback starts from the place last stopped.



Press to stop playback.
You can resume playback from the same point by pressing **▶**. (Press **■** again to cancel the resume function.)



Pauses playback, or restarts playback when paused.



Press to start scanning. Press repeatedly to increase the scanning speed.



Press to skip to previous/next chapter/title.



Except VR mode: During playback, enter a chapter number then press **ENTER** to skip directly to that chapter within the currently playing title.

On some discs, you can also use the number buttons to select numbered items in the disc menu.

VR mode only: During playback, enter a title number then press **ENTER**.

All: Press **CLEAR** to clear a number entry and start again.



(Commercial back/skip) Each press skips backward/forward progressively up to a maximum of ten minutes forward or three minutes back.



While paused, press and hold to start slow-motion playback. Press repeatedly to change the playback speed.

While paused, press to advance a single frame in either direction.



Press to display the menu of a DVD-Video disc.



Use the cursor buttons to navigate DVD-Video disc menus; press **ENTER** to select items.



Press to return to the previous level of a DVD-Video disc menu.

Playing from the HDD

The table below shows the basic playback controls when playing video recorded on the hard disk (HDD).



Press to start playback.
If **RESUME** is displayed on-screen, playback starts from the place last stopped. Playback automatically stops after the end of a title is reached.



Press to stop playback.
You can resume playback from the same point by pressing **▶**. (Press **■** again to cancel the resume function.)



Pauses playback, or restarts playback when paused.



Press to start scanning. Press repeatedly to increase the scanning speed.



Press to skip to previous/next chapter/title.



During playback, enter a title number then press **ENTER** to skip directly to that title.

Press **CLEAR** to clear a number entry and start again.



(Commercial back/skip) Each press skips backward/forward progressively up to a maximum of ten minutes forward or three minutes back.









While paused, press and hold to start slow-motion playback. Press repeatedly to change the playback speed.

While paused, press to advance a single frame in either direction.

Playing CDs and WMA/MP3 discs













The table below shows the basic playback controls for audio CDs¹, and WMA/MP3 files.

	Press to start playback.
	Press to stop playback.
	Pauses playback, or restarts playback when paused.
	Press to start scanning. Press again to increase the scanning speed. (There are two scan speeds; the current scan speed is shown on-screen.)
	Press to skip to previous/next track (or folder for WMA/MP3 disc).
	<p>During playback, enter a track number then press ENTER to skip directly to that track.</p> <p>Press CLEAR to clear a number entry and start again.</p>



Playing Video CD/Super VCDs

The table below shows the basic playback controls for Video CD/Super VCDs.

Some discs feature Playback Control (PBC for short) menus. These discs show PBC in the display when you load them and display a menu on-screen from where you can select what to watch.²

	<p>Press to start playback.</p> <p><i>Video CD only:</i> If RESUME is displayed on-screen, playback starts from the place last stopped.</p>
	<p>Press to stop playback.</p> <p><i>Video CD only:</i> You can resume playback from the same point by pressing . (Press  again to cancel the resume function.)</p>
	Pauses playback, or restarts playback when paused.
	Press to start scanning. Press repeatedly to increase the scanning speed.
	Press to skip to previous/next track. When a PBC menu is displayed, press to display the previous/next page.
	<p>During playback, enter a track number then press ENTER to skip directly to that track.</p> <p>Press CLEAR to clear a number entry and start again.</p> <p>While a PBC menu screen is displayed, use to select numbered menu items.</p>
 	<i>Video CD only:</i> Each press skips backward/forward progressively up to a maximum of ten minutes forward or three minutes back. Note that this function doesn't work when playing in PBC mode.
	While paused, press and hold to start slow-motion playback. Press repeatedly to change the playback speed (forward only). While paused, press to advance a single frame (forward only).
	Press to display the disc menu of a Video CD/Super VCD playing in PBC mode.

Note

- If you want to play a DTS audio CD, make sure the recorder is connected to a DTS-compatible amp/receiver with a digital connection. Noise will be output through the analog outputs. Also make sure that **STEREO** is selected using the **AUDIO (SHIFT + 1)** button (see *Switching audio channels* on page 61).
- When playing in PBC mode, some playback features, such as search, repeat and program play are not available. You can play a PBC Video CD/Super VCD in non-PBC mode by pressing  to start playback instead of .

Using the Home Menu

From the Home Menu screen you can access all the features of the recorder.

Note that some options in the Home Menu may be grayed out sometimes, indicating that they are not available at the present time. For example, the Photoviewer option is grayed out unless there is a disc loaded that contains JPEG image files.

Press **HOME MENU** to display the Home Menu screen:



Use the **↑/↓/←/→** buttons followed by **ENTER** to select the option you want. To exit the Home Menu, press **HOME MENU**.

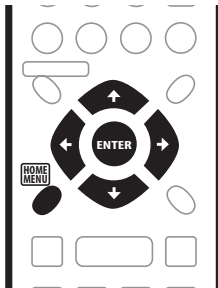

Home menu options

Disc Navigator (page 54, page 73)	Disc Setup (page 87)
Timer Recording (page 42)	Initial Setup (page 92)
Play Mode (page 57)	Video/Audio Adjust (page 89)
Copy (page 63)	Photo Viewer (page 85)
Jukebox (page 82)	

Displaying disc information on-screen

You can display various on-screen information about the disc loaded or the HDD.

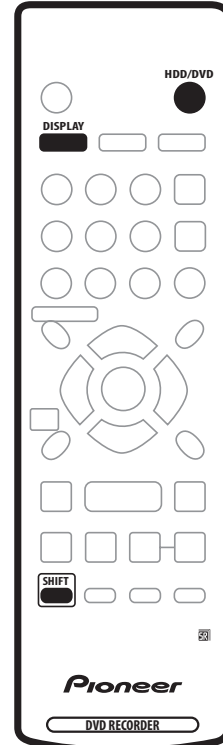

1 Press **DISPLAY (SHIFT + HELP)** repeatedly to display/change the on-screen information.

- Press once to show the HDD and removable disc (DVD, etc.) activity together. Press again to show the status of just the currently selected playback/recording device (HDD or removable disc).
- The on-screen display automatically disappears after 150 minutes.

2 To hide the information display, press **DISPLAY (SHIFT + HELP)** repeatedly until it disappears.

The example displays below are a guide only; actual displays vary according to the disc loaded, etc.

HDD and removable disc activity display

Press **DISPLAY (SHIFT + HELP)** once to see the HDD and removable disc (DVD, etc.) activity. Use the **HDD/DVD** button to switch between the two kinds of display.

The example displays below show high-speed copying from HDD to DVD, and HDD chase playback.

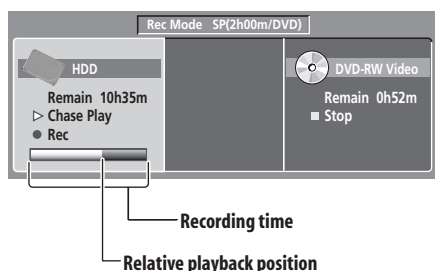
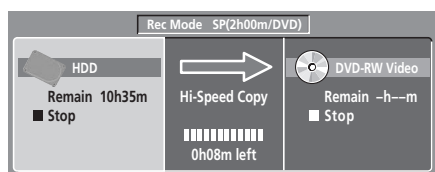

Stop display 1

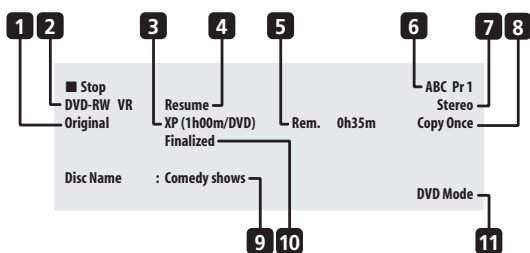

1 DVD-RW Original / Play List

If a VR mode disc is loaded, this shows whether playback is currently set to **Original** or **Play List**.

During preview playback of the Copy List, this shows **Copy List**.

2 Disc type and mode

Shows the disc type (**HDD**, **DVD-R**, **DVD-RW**, **CD**, etc.), and the disc mode for recordable DVD, if applicable (**VR** or **Video**).

3 Recording mode and time

Shows the current recording mode (**XP**, **SP**, **LP**, etc.), and the total recording time of the disc.

4 Resume

Shows **Resume** if playback can be resumed from the last place stopped.

5 Recording time remaining

Shows the approximate recording time left on the disc in the current recording mode.

6 Preset name and number

Shows the preset name and preset number for the currently selected channel.

7 Audio mode

Shows the broadcast audio mode for the current channel preset (**Mono**, **Stereo**, etc.).

8 Copy control information

Shows recording restrictions of the current channel program.

9 Disc name

Shows the disc name.

(For CDs, this area shows playable files other than CD audio tracks; for example, **Multi-format: WMA/MP3**.)

10 Finalized

Shows **Finalized** if a recordable DVD is finalized.

11 TV/DVD mode

Shows the current mode of the recorder (see *Switching between TV and DVD* on page 30).

Stop display 2

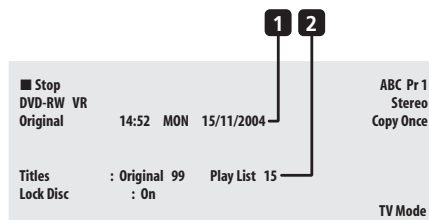

1 Date and time

2 Number of titles/tracks on disc

For a VR mode DVD-RW, the number of Original and Play List titles are shown separately.

Play display 1

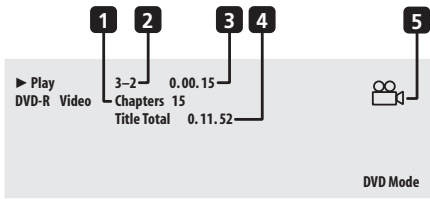

1 Number of chapters in title

2 Current title and chapter number

(For CD/Video CD/Super VCD, shows current track; for WMA/MP3, shows current folder and track; for JPEG disc, shows current folder and file.)

3 Elapsed title time

(For CD, WMA, MP3, Super VCD, shows elapsed track time; for Video CD, shows elapsed disc time.)

4 Total running time of title

5 Angle indicator

Lights during multi-angle scenes.

Play display 2

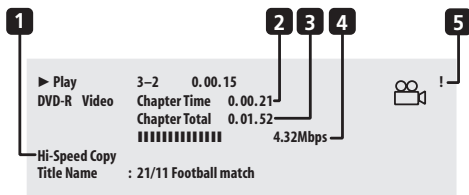

1 Chase playback, simultaneous record/playback, copy, disc back-up

Indicates that recording, copying or back-up is in progress.

2 Elapsed chapter time

3 Total running time of chapter

4 Data transfer rate

Shows the current data rate being read from the disc.¹

5 Copy protected material (!)

Shows '!' if the playback material is copy-once protected.

Recording display

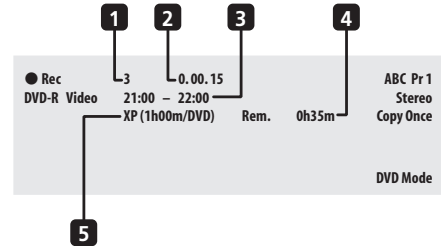

1 Current title number

2 Elapsed recording time

3 Timer recording start and stop times

Shows the start and stop times if the current recording is a timer recording.

4 Remaining recording time available

Shows the amount of space left on the disc in the current recording mode.

5 Recording mode

Shows the current recording mode (**XP**, **SP**, **LP**, etc.), and the total recording time of the disc.



Tip

- When using the simultaneous play and record feature, the display shows information for playback only.
- During real-time copy, the copy source playback information is displayed.
- The Video mode disc displays become the same as a DVD-Video disc once the disc is finalized.
- The total recording time figure shown in parenthesis is calculated based on a 12cm/4.7GB disc at the displayed record setting.
- Recording and playback times for TV recordings are approximately 0.1% shorter than the actual time. This is because of the slightly different frame rates of TV broadcasts versus DVD.
- The frame number is shown next to the elapsed time display when the disc is paused.
- **Copy Once** or **Can't Record** messages may appear in the stop or recording displays. These indicate that the broadcast TV program contains copy control information.

Note

1. Data transfer rate shows the amount of video and audio information recorded on the disc. It is not an indication of picture/audio quality.

Chapter 5

Recording

About DVD recording

This recorder can record on both DVD-R and DVD-RW media. The main difference between the two is that DVD-R discs can only be recorded once, while DVD-RW can be recorded, erased and re-recorded many times.

Both types of disc can be initialized for *Video mode* or *VR mode* recording. Each has its advantages, and it depends on what you want to do with the recording which mode you choose.

If you want to edit your recordings in any significant way, VR mode offers greater possibilities for cutting, copying, and changing the way the video is presented.

Video mode is less flexible when it comes to editing, but it has the advantage that it is compatible with standard DVD players (many of which won't play VR mode discs¹).

Once a disc is initialized for a particular mode, all recording on that disc will be in that mode.



Important

- The maximum number of titles and chapters that can be recorded on a VR mode disc is 99 and 999 respectively; on a Video mode disc the maximum number of titles and chapters is 99 and 99. No more recording is possible on a disc that already contains the maximum number of chapters/titles.
- Unfinalized Video mode discs are not usable in other DVD recorders. Likewise, unfinalized video mode discs recorded using other recorders are not usable in this recorder.
- Pioneer takes no responsibility for recording failure due to power cuts, defective discs, or damage to the recorder.
- Fingerprints, dirt and small scratches on a disc can affect playback and/or recording performance. Please take proper care of your discs.
- See also *Disc / content format playback compatibility* on page 9 for detailed disc compatibility information.
- Although this recorder can record PAL, SECAM, NTSC and PAL-60, you can't mix multiple TV line systems on one disc. A disc can contain PAL and SECAM recordings, or NTSC and PAL-60. See also *Additional information about the TV system settings* on page 99.

About HDD recording

Recording to the internal hard disk drive (HDD) is very flexible; you have the full choice of recording quality options, including manual mode, and of course you can record, erase and re-record as many times as you like.

The capacity of the hard disk drive means that you can store many hours of video on it, even using the higher quality recording modes.



Important

- The maximum number of titles/chapters per title that can be recorded on the HDD is 999 and 99 respectively. No more recording is possible on the HDD after the maximum number of titles has been reached.
- The maximum continuous recording time for one title is 12 hours.
- It is possible to record both PAL and NTSC titles on the HDD. Before recording, you need to make sure that the Input Line System setting (page 99) matches the TV line system of the source you're recording.

HDD Video mode compatibility

When recording to the HDD you can choose to record in one of two formats. Set the format from the HDD Recording Format item in the Initial Setup menu (see page 97).

When set to Video Mode On, high-speed copying from HDD to Video mode DVD is possible. When recording a bilingual broadcast, set which channel you want to record from the Initial Setup menu (see *Bilingual Recording* on page 95).

When HDD Recording Format is set to Video Mode Off, high-speed copying isn't possible. However, both channels of bilingual broadcasts are recorded and you can switch the audio on playback.

Note

1. Some DVD players, such as some Pioneer models, are compatible with VR mode discs. Check the operating instructions for your player for VR mode compatibility information.

Recording time and picture quality

There are six preset recording quality modes¹:

- **XP** – High quality setting, gives about one hour of recording time on a DVD disc.
- **SP** (Standard Play) – Default quality, used for most applications, gives about two hours of recording time on a DVD.
- **LP** (Long Play) – Lower video quality than SP, but doubles the recording time on a DVD to about four hours.
- **EP** (Extended Play) – Lower quality than LP, but gives about six hours of recording time on a DVD disc.
- **SLP** (Super Long Play) – Lower quality than EP, but gives about eight hours of recording time on a DVD disc.
- **SEP** (Super Extended Play) – Lowest video quality but gives about ten hours of recording time on a DVD disc.

Please note that there is a trade-off between recording time and quality. The longer the possible recording time, the lower the recorded picture quality.

In addition to these settings, when Manual Recording is On (see *Manual Recording* on page 97) you can access 32 different recording quality/time settings (**MN1–MN32**), a high-quality audio mode (**LPCM**), and a super-high quality (data transfer rate of around 15 Mbps) HDD recording mode (**XP+**).

When setting a timer recording there is a further option, **AUTO**, which maximizes the recording quality for the space available on the disc loaded at the time of recording. (If recording to the HDD, the recording quality is maximized to fit on to a DVD disc.)

Recorded audio

In all except the **LPCM** mode, sound is recorded in two channel Dolby Digital format. When set to **LPCM**, sound is recorded in high quality, uncompressed Linear PCM format.

If the broadcast audio is bilingual and you are recording in Video mode or to the HDD with the HDD Recording Format set to Video Mode On, or on the **LPCM** setting, use the Bilingual Recording setting (page 95) to select the **A/L** or **B/R** audio channel to record before recording starts. In other cases, both channels of a bilingual broadcast will be recorded and you can switch on playback.

Restrictions on video recording

You cannot record copy-protected video using this recorder. Copy-protected video includes DVD-Video discs and some satellite broadcasts. If copy-protected material is encountered during a recording, recording will pause automatically and an error message will be displayed on-screen.

Video that is 'copy-once only' can only be recorded on the HDD or in VR mode (see below).

When recording a TV broadcast or through an external input, you can display copy control information on screen. (see *Displaying disc information on-screen* on page 34).

CPRM

CPRM is a copy protection/scrambling system developed for the recording of 'copy once' broadcast programs. CPRM stands for *Content Protection for Recordable Media*.

This recorder is CPRM compatible, which means that you can record copy-once broadcast programs, but you cannot then make a copy of those recordings. CPRM recordings can only be made on CPRM-compatible DVD-R (ver. 2.0/8x or higher) or DVD-RW (ver. 1.1 or higher) discs formatted in VR mode or on the HDD.

DVD CPRM recordings can only be played on players that are specifically compatible with CPRM.

Recording equipment and copyright

Recording equipment should be used only for lawful copying and you are advised to check carefully what is lawful copying in the country in which you are making a copy. Copying of copyright material such as films or music is unlawful unless permitted by a legal exception or consented to by the rightowners.

- This product incorporates copyright protection technology that is protected by method claims of certain U.S. patents and other intellectual property rights owned by Macrovision Corporation and other rights owners. Use of this copyright protection technology must be authorized by Macrovision Corporation, and is intended for home and other limited viewing uses only unless otherwise authorized by Macrovision Corporation. Reverse engineering or disassembly is prohibited.

Note

1. All recording times (both in this manual and those shown by the recorder) are approximate. This is because of the way that the video is recorded; you may get slightly more or slightly less, depending on what you're recording.

Setting the picture quality/recording time

VR mode Video mode HDD

Before starting a recording, you will usually want to set the picture quality/recording time. There are six standard settings available, which allow you to choose a balance between picture quality and recording time.

When Manual Recording is set to On (see *Manual Recording* on page 97), a further option will be available (**MN1–32**, **LPCM** or **XP+**, depending on what you set).

See also *Recording time and picture quality* on page 38 for more information.

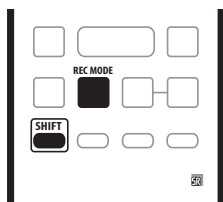

- Press **REC MODE (SHIFT + ■)** repeatedly to select a recording setting.

- **XP** – High quality
- **SP** – Standard play
- **LP** – Long play
- **EP** – Extended play
- **SLP** – Super Long play
- **SEP** – Super Extended play
- **MN / LPCM¹ / XP+²** – Manual / Linear PCM / XP+ (available only when manual recording is on)

The setting is indicated in the front panel display, and shown on-screen together with the recording time for a blank recordable disc. If a recordable disc is loaded, the approximate remaining recording time for that disc is also shown. (Note that if the On Screen Display setting (see *On-Screen Display* on page 98) is **Off** then this information is not displayed.)

Basic recording from the TV

VR mode Video mode HDD

Follow the instructions below to record a TV program. Recording starts immediately and continues until the disc is full or you stop the recording.

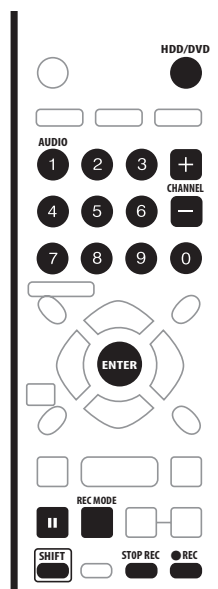

- 1 Use the **HDD/DVD** button to select the **HDD** or a recordable **DVD** for recording.

- If you're recording to DVD, load a recordable disc (if you load a new blank DVD-RW disc, the recorder takes a short while to initialize the disc).

- 2 Use the **CHANNEL +/-** buttons to select the **TV channel** to record.

The front panel display shows the channel number:



- While the recorder is stopped, you can also use the number buttons on the remote to select the channel. (For channel 6, press **6** then **ENTER**; for channel 24, press **2, 4** then **ENTER**)

- 3 Use the **REC MODE (SHIFT + ■)** button to set the **picture quality/recording time**.

- See *Setting the picture quality/recording time* above for detailed instructions.

Note

1. Audio is recorded in 16-bit Linear PCM format, video is recorded at XP quality. When recording a bilingual broadcast, select which audio channel to record (see *Bilingual Recording* on page 95).

2. Applicable only to HDD recording. (If this setting is used when recording to DVD, **MN32** is used.) When copied to DVD, XP+ recordings are always copied in real time.

Setting a timer recording

VR mode Video mode HDD

Using the timer recording features you can program up to 32 timer recordings up to a month in advance. Timer recording programs can be set to record just once, every day, or every week.

There are three ways to program a timer recording; using the Easy Timer Recording feature (see *Easy Timer Recording* below), using the VIDEO Plus+ programming system (see *Timer recording using the VIDEO Plus+® programming system* on page 43), or using manual timer recording (see *Setting a manual timer recording* on page 44).

You can set the recording quality for your timer recording in the same way as for a regular recording, but with the added option of an **AUTO** mode, which maximizes the recording quality for the space available on the disc (if recording to DVD), or to fit on to a blank DVD disc (if recording to HDD).

You can set timer recordings to record to a recordable DVD or to the hard disk drive. For regular (daily or weekly) HDD timer recordings that you don't need to keep, you can use the Auto Replace Recording feature to automatically replace the previous timer recording with the new one. Note that when you use this feature, the previous recording made on that timer program will be replaced by the next one, regardless of whether you have watched it yet or not.

You can also set the recorder so that it will adjust the recording quality to try and fit the recording on to the disc if it would not otherwise fit at the recording quality you set (see *Optimized Rec* on page 97 for more on this).

Finally, if you set a timer recording to record to DVD but there isn't a recordable DVD loaded at the time of the recording, the Recovery Recording feature will automatically record the program to the HDD for you.



Important

- A timer recording can't be set if there are already 32 timer programs waiting to be recorded.
- Timer recording will not start if:
 - The recorder is already recording.
 - A disc is being initialized, finalized or unfinalized.
- Timer recording will start when the operation preventing timer recording has finished.
- If a recordable DVD that doesn't support simultaneous playback and recording (see *Simultaneous recording and playback* on page 48) is playing when a DVD timer recording is due to start, playback will automatically stop to allow the recording to start.
- The timer indicator (Ⓢ) lights in the front panel display when the timer is active. If the indicator is blinking it means that (for a DVD timer recording) there is no disc loaded, or the disc loaded is not recordable (for an HDD timer recording it means that the HDD is not recordable).
- Approximately two minutes before a timer recording is set to start, the recorder will go into timer recording standby. In timer recording standby you cannot use some functions.
- The maximum length for timer recordings made to the HDD is 24 hours. However, because one title (HDD) is limited to 12 hours, recordings over 12 hours will be spread over two titles. Note that there will be a break in the recording of a few seconds between titles.

Easy Timer Recording

As the name suggests, Easy Timer Recording makes setting up a timer recording as simple as possible.

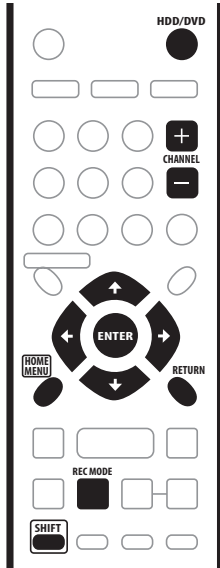

1 Press HOME MENU, select 'Timer Recording', then 'Easy Timer'.



2 Set the TV channel and recording quality.

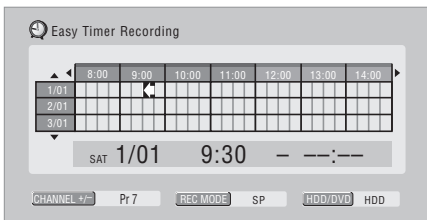

- Use the **CHANNEL +/-** buttons to set the channel you want to record.
- Use the **REC MODE (SHIFT + ■)** button to set the recording quality. Press repeatedly to switch between **XP, SP, LP, EP, SLP, SEP** and **AUTO** (and **MN** if manual recording mode is on).

- **DVD recording:** The **AUTO** option automatically sets the best recording quality for the space available on the disc loaded at the time of recording.
- **HDD recording:** The **AUTO** option automatically sets the best recording quality that would fit on to a blank DVD disc.
- Use the **HDD/DVD** button to select **DVD** or **HDD** to record to DVD or the HDD respectively.

3 Use ↑/↓/←/→ to move the cursor to the recording start date and time on the grid.

- You can move the cursor forward or back an hour at a time using the ◀◀ and ▶▶ buttons.

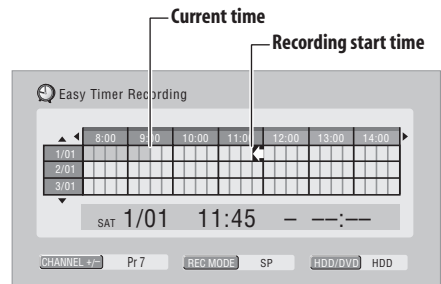

Each row of the grid is one day (you can set the timer recording for up to a month in advance). Each column is a 15 minute interval.

The darker area represents time that has already passed and can't therefore be selected. The lighter area is time that's available.

4 Press ENTER to set the start time.

The start date and time is displayed in the middle of the screen.

- You can go back and reset the start time if you need to by pressing **RETURN**.

5 Use the ←/→ to move the cursor to the recording end time on the grid.

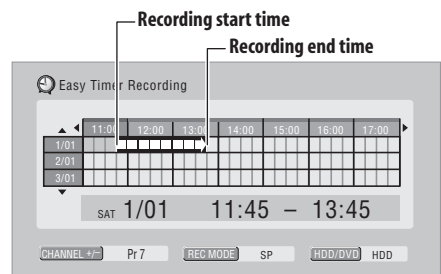

As you move the cursor around the grid, an arrow stretches from the start time to the current cursor position, representing the length of the recording. A recording of up to six hours can be set.

6 Press **ENTER** to set the end time.

7 Select **'Yes'** to set the timer recording and exit, or **'No'** to go back to the timer recording screen.

Timer recording using the VIDEO Plus+® programming system

This system makes programming timer recordings very simple. Most TV guides publish PlusCode programming numbers with their program details. If you want to make a timer recording of a program, you just input the corresponding code. The date, start, stop and channel settings are made automatically. All you have to do is tell the recorder the recording mode, and whether it's a once-only recording or a regular recording.

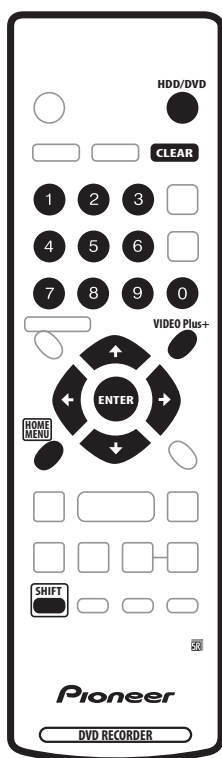

1 Press **'VIDEO Plus+ (SHIFT + MENU)'** to display the **VIDEO Plus+ program screen**.

You can also access this screen from the Home Menu (press **HOME MENU**, select **Timer Recording**, then **VIDEO Plus+**).

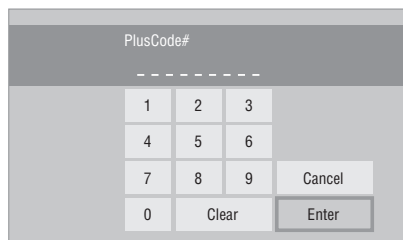

- Use the number buttons to enter the PlusCode programming number. (To clear the last digit entered, press **CLEAR**.)
- You can also use the **↑/↓/←/→** buttons to select digits from the on-screen display.

2 After making the settings, select **'Enter'** and press **ENTER**.

The timer recording screen appears with the timer program you just set.

3 Confirm that the settings are correct.

If the channel number isn't displayed, use the **←/→** buttons to highlight **CH**, then use the **↑/↓** buttons to set the correct channel number.

- If the channel number is set, but incorrectly, set up the guide channel (see *Set VIDEO Plus+ CH* on page 93).

4 Select **'Store Program'** to finish.

- Other options in the same menu panel allow you to name the program, and change the recording destination and/or recording mode.

VIDEO Plus+ programming with the power off

You can enter a PlusCode programming number when the recorder is in standby. Note that the recording is always made to the HDD. If you want to record to a DVD disc, you'll need to switch on the power and use the full VIDEO Plus+ program screen.

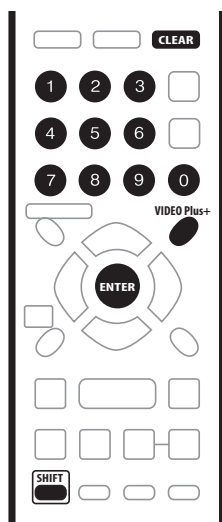

Important

- You can't use this feature until you have set up the guide channels. See *Set VIDEO Plus+ CH* on page 93.
- You can't change the recording mode.
- You can't program daily or weekly timer recordings.

1 Press 'VIDEO Plus+ (SHIFT + MENU)'.

The front panel display shows the current recording mode and prompts you to enter the PlusCode programming number.



2 Use the number buttons to enter the number.



- To clear the last digit entered, press **CLEAR**.

3 Press ENTER.

The display shows the timer settings:
Date → Start time → End time → HDD and Recording channel → Recording mode.

- If **CODE ERROR** appears in the display, check that the number is correct and that the guide channel is set (see *Set VIDEO Plus+ CH* on page 93), then set the timer recording again.

- If **CAN'T SET** appears in the display, it means that although you entered a valid number, the program has already finished.

Setting a manual timer recording

The timer recording screen you can see all the timer programs already set, clear programs and set up new ones.

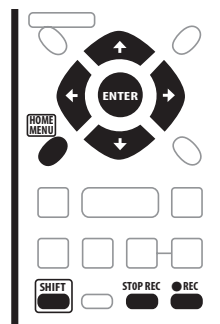

1 Press TIMER REC to display the Timer Recording screen.

You can also access the Timer Recording screen from the Home Menu (press **HOME MENU**, select **Timer Recording**, then **Timer Recording**).

This screen shows all the timer programs currently set.

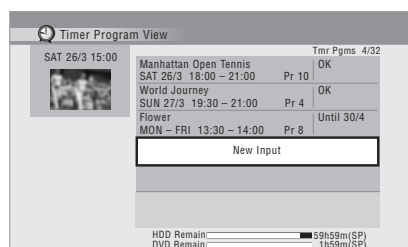

- Each row is for one timer recording program, with the date and time information, channel, recording mode, DVD or HDD and recording status.
- The amount of free space available on the HDD and the currently loaded recordable DVD is shown towards the bottom of the screen.
- In the upper-right corner, the number of timer programs already set is shown next to **Tmr Pgms**.
- If there are more than five timer programs already set, press **▶▶** to switch page (go back using the **◀◀** button).
- You can also delete a timer program before it's started (before the recorder enters timer recording standby) by highlighting it and pressing **CLEAR**. See also *Deleting a timer program* on page 46.

2 Select 'New Input' to set a new timer program, then press ENTER.

CH	Date	Start	Stop	Extend
Pr 10	SAT 26/3	18:00	21:00	30 min

Detailed Settings

Record To	HDD
Recording Mode	XP
Auto Replace Rec.	On
Genre	No Category
Bilingual Recording	A/L
HDD Recording Format	Video Mode On

Enter Details

Set Detailed
Set Title Name
Cancel

3 Enter the timer recording settings.

Use the \leftarrow/\rightarrow buttons to select a field; use the \uparrow/\downarrow buttons to change the value.

- **CH** – Choose a channel (Pr 1–Pr 99, excluding skip channels), or one of the external inputs from which to record.
- **Date** – Choose a date up to one month in advance, or select a daily or weekly program.
- **Start** – Set the recording start time.
- **Stop** – Set the recording end time (maximum length of a timer recording is 24 hours).

4 If you want to change the recording mode, recording destination, etc., select 'Set Detailed'.

In this area you can set:

Record to – Select **HDD** for hard disk recording or **DVD** for DVD recording. Select **HDD** for Auto Replace Recording (daily or weekly timer recording only).

Recording Mode – Select **XP**, **SP**, **LP**, **EP**, **SLP** or **SEP**, (See *Setting the picture quality/recording time* on page 39). If Manual Recording is on, then you can also select the **LPCM** or **XP+** setting, or **MN** (press **ENTER** then use the \leftarrow/\rightarrow buttons to select the level).

Replace – Auto Replace Recording: automatically erases the previous daily or weekly recording when the next one is recorded.

Genre – Select a record genre (for HDD recording only).

Bilingual – Select which channel of a bilingual broadcast to record (necessary if recording to a Video mode DVD or to the HDD with the HDD Rec Mode set to **Video Mode On**).

HDD Recording Format – Select **Video Mode On** or **Video Mode Off** depending on whether you need high-speed copying to Video mode DVD capability or not.

5 After entering all the timer recording information, highlight 'Store Program' and press ENTER.

The timer recording list screen is displayed again. The timer program you just input appears in the list. The rightmost column shows various timer recording status messages:

- **OK** – Can be recorded.
- **Time Over** – Not enough space on the HDD (the recording won't finish).
- **Over 12h** – Recording time of over 12 hours set (when recording to the HDD the recording will be split into two titles).
- **Overlap** – Two timer programs partially or completely overlap. The one starting earlier will take priority.
- **Until ...** (eg., **Until 13/8**) – For a regular recording, the last program that could be recorded is shown.
- **Data Over** – Can't record because the disc management area of the disc is full.
- **Cancel Once** – A regular timer program is set to skip.
- **Can't Rec** – Not possible to record for some reason.
- **Title Over** – Can't record because there is already the maximum number of titles on the disc (HDD: 999; DVD: 99).
- **Recording** – The program is currently recording.
- **Standby** – The recorder is in timer recording standby.
- *nothing displayed* – Another timer recording or copying is in progress.

6 To exit the timer recording screen, press HOME MENU.



Tip

- To enter a title name for the timer recording in advance, select **Set Title Name** and follow the on-screen display.



Note

- If you set a DVD timer recording but there is no recordable DVD disc loaded, or the disc loaded doesn't have enough free space for the complete recording, **Recovery** is shown. In this case (unless you load a suitable disc before the recording actually starts), the recorder will use the HDD for recording. (The message **Can't Rec** will appear if there are already 999 titles on the HDD or if there is not enough free space on the HDD for recording.)
- For a DVD timer recording, if **Optimized Rec** (see *Optimized Rec* on page 97) is set to **On**, the recorder will adjust the recording quality to try and fit the recording on the disc. If the recording will not fit onto the disc even on MN1 recording quality then the Recovery Recording feature will automatically make the recording to the HDD instead.
- If there is very little free space left on the HDD, an Auto Replace Recording may not complete successfully.

- If the HDD is being used for playback or high-speed copying when an Auto Replace Recording is due to start, the new timer recording will not replace the old one. However, the next time the timer recording starts, both of the older two programs will be erased.

Editing a timer program

You can change any of the settings in a timer program before the recording is due to start.

- 1 Press **TIMER REC.**
- 2 Highlight the timer program you want to change.
- 3 Press **⇒** then select 'Modify' from the command menu panel.

Alternatively, press **ENTER**.

The Timer Program Set screen appears from which you can edit the settings.

- 4 Edit the timer recording settings as necessary.
- 5 Select 'Store Program' to finish.

Confirm the settings you made from the following screen.

Deleting a timer program

You can delete timer programs you no longer need.

- 1 Press **TIMER REC.**
- 2 Highlight the timer program you want to erase.
- 3 Press **⇒** then select 'Erase' from the command menu panel.
 - Select **Yes** to confirm or **No** to cancel.
 - You can also just press **CLEAR** when the timer program is highlighted.

Skipping a regular timer program

If you've set a regular daily or weekly timer program, you can set the recorder to skip the next scheduled recording.

- 1 Press **TIMER REC.**
- 2 Highlight the timer program you want to skip.
- 3 Press **⇒** then select 'Cancel Once' from the command menu panel.

You can also just press **||** when the timer program is highlighted.

- In the timer program list, **Cancel Once** appears by the program.

Extending a timer recording in progress

You can extend a timer recording beyond the programmed end time in two different ways. This can be useful if a broadcast program overruns, for example.

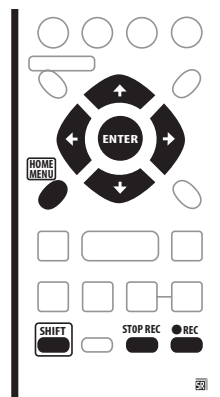

Moving the end time by 30-minute blocks

- 1 During timer recording, press and hold **● REC** for three seconds.

The timer indicator disappears from the front panel display.

- 2 Press **● REC** repeatedly to extend recording in 30 minute increments.

Programming a new end time

You can edit the end time of a timer recording you have previously set.

- 1 Press **TIMER REC.**
- 2 Highlight the timer program you want to change.
- 3 Press **⇒** then select 'Modify' from the command menu panel.

Alternatively, press **ENTER**.

The Timer Program Set screen appears from which you can edit the settings.
- 4 Edit the end time as necessary.
 - You can also edit the **Extend** time parameter.
- 5 Select 'Store Program' then press **ENTER**.

- 6 To exit the timer recording screen, press **HOME MENU**.

Simultaneous recording and playback

VR mode HDD

A feature called Chase Play makes it possible to watch a recording in progress (DVD or HDD) from the start of the recording (as in, playback is 'chasing' the recording). For example, perhaps you have to miss the first 30 minutes of a movie on TV; you can start recording, then start watching the movie, from the beginning, while the recorder is still recording 30 minutes ahead of you.

In fact, you're not just limited to watching the recording in progress; you can watch anything else already on the DVD or HDD by selecting it from the Disc Navigator screen (see *Using the Disc Navigator with recordable discs and the HDD* on page 54).

Important

- Note that you must use a DVD-RW Ver. 1.1 / 2x or Ver. 1.2 disc to be able to use this feature.
- You may not be able to use this feature with a DVD-RW disc that was first initialized on another recorder.
- Chase playback is not possible using a VR mode DVD-R disc.
- **During recording, press ► to start playback from the beginning of the current recording¹, or press DISC NAVIGATOR and select another title to play from there.**

You can use all the usual playback controls, such as pause, slow-motion play, scan² and skip.

- To stop playback, press ■ (recording will continue).
- To stop recording, press □ **STOP REC** (playback will continue).
- During recording or in timer recording standby, you can't play an HDD title, DVD or Video CD/Super VCD disc if the Input Line System setting doesn't match the TV line system of the disc/HDD title (see also *Additional information about the TV system settings* on page 99). Also, during simultaneous recording and playback, if the TV line system of the playback track/title changes then playback will automatically stop.

Note

1. You can't start playback immediately after recording starts. Simultaneous playback and recording doesn't work while copying or backing up.
2. When scanning a DVD, no sound is output if the recorder is also recording the DVD (see *Scanning discs* on page 56).
3. This cannot be selected if **AV2/L1 In** is set to **Decoder** (see *AV2/L1 In* on page 94).

Recording from an external component

VR mode Video mode HDD

You can record from an external component, such as a camcorder or VCR, connected to one of the recorder's external inputs.

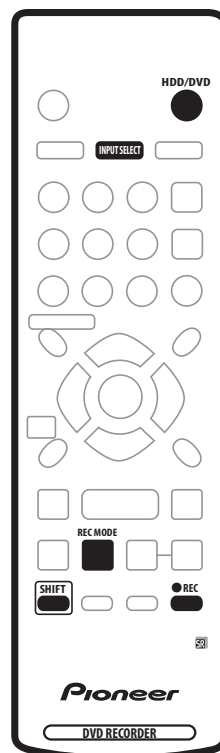

1 Make sure that the component you want to record from is connected properly to the DVD recorder.

See Chapter 2 (*Connecting up*) for connection options.

2 Press INPUT SELECT repeatedly to select one of the external inputs to record from.

There are three analog inputs and a DV digital input. The current input is shown on-screen and in the front panel display:

- **AV2/L1** – Input 1³
- **L2** – Input 2 (front panel)
- **L3** – Input 3
- **DV** – DV input (front panel)

Check that the **Audio In** settings for **External Audio**, **Bilingual Recording** and **DV Input** are as you want them (see *Audio In Settings* on page 94).

- If the aspect ratio is distorted (squashed or stretched), adjust on the source component or your TV before recording.

3 Set up the recorder.

- Use **REC MODE (SHIFT + ■)** to set the recording quality. See *Setting the picture quality/recording time* on page 39 for detailed information.
- Use the **HDD/DVD** button to select the HDD or DVD for recording.

4 Press ● REC when you're ready to start recording.

- The recorder will only start recording from the **DV IN** jack if there is a valid signal. Recording will also pause if the signal is interrupted during recording.
- If your source is copy-protected using CopyGuard, you will not be able to record it. See *Restrictions on video recording* on page 38 for more details.

Automatic recording from a satellite tuner

HDD

If you have a satellite tuner or some other kind of set top box connected to the **AV2/AUTO START REC (INPUT 1/DECODER)** input, you can have the recorder start and stop recording automatically with the timer settings of the connected component. (If the other component doesn't have a built-in timer, you'll need to use it with an external timer unit.)¹

After setting up for Auto Start Recording, this recorder starts recording when it detects a signal from the other component. When the signal ceases, the recorder stops recording.

If you want to use this recorder with the timer features of your satellite tuner, see *Language code list* on page 108.



Important

- It takes a little while for this recorder to switch on and start recording after detecting a signal. Please bear this in mind when setting the timer.
- If Auto Start Recording is set, it will not start if another timer recording is in progress.

Note

1. You can't set Auto Start Recording when:
- the recorder is recording or in timer recording standby.
 - the HDD is not recordable.
 - the HDD already contains the maximum number of titles (999).

- Timer recordings take precedence over Auto Start Recording. Auto Start Recording will stop if a timer recording is due to start. After the timer recording has finished, Auto Start Recording will resume.

1 Set the timer for the satellite receiver (or other component), then switch it into standby (if necessary).

Check the manual that came with the receiver if you're not sure how to do this.

2 Check that the 'Audio In' settings for 'External Audio' and 'Bilingual Recording' are as you want them.

See *Audio In Settings* on page 94 for more on these settings.

3 Set up the recorder.

- Use **REC MODE (SHIFT + ■)** to set the recording quality. See *Setting the picture quality/recording time* on page 39 for detailed information.

4 Press HOME MENU and select 'Timer Recording', then 'Auto Start Recording'.

5 Select 'Yes' to switch Auto Start Recording on, or 'No' to switch off.

6 Switch the recorder into standby.

The **AUTO** indicator in the front panel display lights.

The recorder will automatically switch on and start recording when the other component comes on. Recording stops when the external component switches off.

- To cancel Auto Start Recording, press **⏻ STANDBY/ON** while the recorder is in standby. The **AUTO** indicator goes off.
- To cancel Auto Start Recording once recording has already started, press **● REC** for three seconds (this cancels Auto Start Recording, but recording continues), then **□ STOP REC** to stop recording.
- You can also stop recording by pressing **□ STOP REC** then selecting **Yes** to confirm.



Tip

- Alternatively, with no OSD displayed, press and hold the front panel **□ STOP REC** button for more than three seconds to switch Auto Start Recording on directly. After switching on, switch the recorder into standby (step 6).

Recording from a DV camcorder

VR mode Video mode HDD

You can record from a DV camcorder connected to the **DV IN** jack on the front panel of this recorder. Using the recorder's remote, you can control both the camcorder and this recorder.

Before recording, make sure that the audio input for the **DV IN** jack is setup (see *DV Input* on page 95).

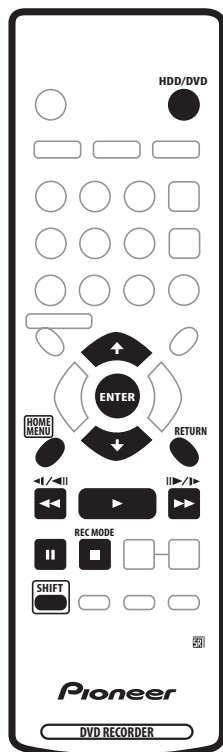

Important

- The source signal must be DVC-SD format
- Some camcorders cannot be controlled using this recorder's remote.
- If you connect a second recorder using a DV cable, you cannot control the second unit from this one.
- You can't control this unit remotely from a component connected to the **DV IN** jack.
- You can't record date and time information from DV cassette.
- During DV recording, if a part of the tape is blank, or has copy-protected material on it, this recorder will pause recording. Recording will restart automatically when there is a recordable signal. However, if there is more than 10 seconds of blank tape, this recorder will stop recording and the camcorder should stop (depending on the camcorder).
- For best results when recording from a DV camcorder to this recorder, we recommend cueing the camcorder to the place you want to start recording from and setting the camcorder to play-pause.

1 Make sure your digital camcorder is connected to the front panel DV IN jack.

Also, set the camcorder to VTR mode.

2 Set up the recorder.

- Use **REC MODE** (SHIFT + ■) to set the recording quality. See *Setting the picture quality/recording time* on page 39 for detailed information.
- Make sure a recordable disc is loaded if you want to record to DVD.

3 From the Initial Settings menu, check that the DV audio input is setup as you require.

See *DV Input* on page 95 for more on this.

- Check also that the **Audio In** settings for **External Audio** and **Bilingual Recording** are as you want them (see *Audio In Settings* on page 94).

4 Press HOME MENU, select 'Copy', then 'DV Record' from the menu.

- DV recording only works when the digital camcorder is in VTR mode with a tape loaded.

5 Select 'Record to Hard Disk Drive' or 'Record to DVD' to record to the hard disk drive or a recordable DVD respectively.

6 Find the place on the camcorder tape that you want to start recording from.

For best results, pause playback at the point from which you want to record.

- Depending on your camcorder, you can use this recorder's remote to control the camcorder using the **■**, **▶**, **⏸**, **◀◀**, **▶▶**, **◀|/◀||** and **||/|▶** buttons.

7 Use the **↑/↓** buttons to select 'Start Rec' and press **ENTER**.

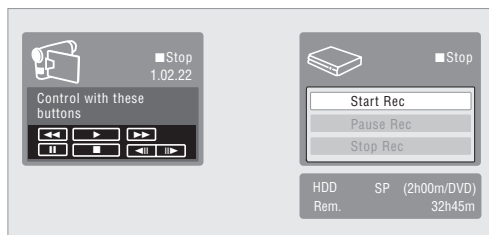

- Recording is automatically paused if the recorder detects no signal, or a copy-protected signal. Recording restarts when there is a non-copy-protected signal.
- You can pause or stop the recording by selecting **Pause Rec** or **Stop Rec** from the on-screen display. You cannot control the camcorder from this remote control during recording.
- If you restart recording after stopping the camcorder, the first few seconds of the camcorder tape will not be recorded. Use the pause button on your camcorder instead and recording will start immediately.
- HDD and DVD-RW (VR Mode) only:** A chapter marker is inserted every time there is a break in the timecode on the DV tape. This happens when the recording is stopped or paused then restarted, for example.
- While recording, you cannot exit the DV recording screen using the **HOME MENU** or **RETURN** button.
- See also *DV-related messages* on page 106 if you encounter an error while using the **DV IN** jack.

? Frequently Asked Questions

- I can't get my DV camcorder to work with the recorder!*
Check that the DV cable is properly connected. Also make sure that what you're trying to record is not copy-protected.
If it still doesn't work, try switching off the camcorder then switch back on.
- There's a picture, but no sound!*
Try switching the **DV Input** setting (see *DV Input* on page 95) between **Stereo 1** and **Stereo 2**.¹

Note

- If the audio subcode on the DV tape cannot be read correctly, the audio type will not switch automatically. You can switch the audio manually from the **External Audio** setting (page 94).
- If the TV line system of the disc is different to the current setting of the recorder, you will not be able to finalize the disc. See *Additional information about the TV system settings* on page 99 for how to change the recorder's setting.

Playing your recordings on other DVD players

VR mode **Video mode**

Most regular DVD players can play finalized discs recorded in Video mode. A number of players (including many Pioneer models) can also play DVD-RW discs recorded in VR mode, finalized or not. Most players will not play VR mode DVD-R discs, although some DVD-ROM drives and DVD recorders may be able to (finalization might be necessary). Check the manual that came with the player to check what kinds of discs it will play.

When you finalize a Video mode disc, a title menu is created from which you can select titles when you play the disc. There are a number of different styles of title menu to choose from to suit the content of the disc.

All the title menus are navigated in the usual way, pressing **MENU** or **TOP MENU** to display the menu, then using the **↑/↓/←/→** followed by **ENTER** to select titles and start playback.

Finalizing a disc

VR mode **Video mode**

Finalizing 'fixes' the recordings in place so that the disc can be played on a regular DVD player or computer equipped with a suitable DVD-ROM drive.²

Note that the disc name will appear in the title menu after you finalize a disc. Make sure the disc name is as you want it before you finalize the disc as it can't be changed afterwards. If you want to rename the disc, see *Input Disc Name* on page 87 before starting the steps below.

! Important

- Once you've finalized a disc recorded in Video mode, you can't edit or record anything else on that disc. However, the finalization on a DVD-RW disc maybe 'undone'; see *Undo Finalize* on page 88 for how to do this.
- A VR mode disc can still be recorded and edited on this recorder even after finalizing.

1 Load the disc you want to finalize.

Make sure that the recorder is stopped before proceeding.

- 2 Press **HOME MENU** and select '**Disc Setup**'.
- 3 Select '**Finalize**'.

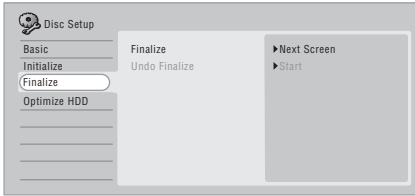

- 4 Select '**Finalize**' from the finalize options, then '**Next Screen**'.
- 5 For Video mode discs only, select a title menu style, then select '**Yes**' to start finalization or '**No**' to cancel.

The menu you select will be the one that appears when the 'top menu' is selected on any DVD player.

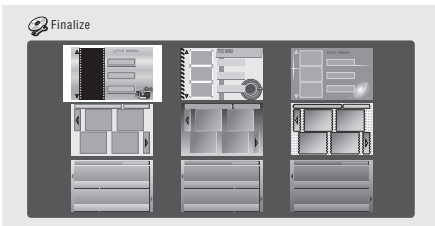

- Discs recorded partially or fully on the Pioneer DVR-7000 DVD recorder do not support this feature. These discs will have only a text title menu when finalized on this recorder.

6 The recorder will now start finalizing the disc.

During finalization:

- If the finalization process of a DVD-RW disc is going to take more than around four minutes, you can press **ENTER** to cancel. Around four minutes before completion, the option to cancel disappears.
- You can't cancel the finalization of a VR mode DVD-R disc.
- How long finalization takes depends on the type of disc, how much is recorded on the disc and the number of titles on the disc. A disc recorded in VR mode can take up to one hour to finalize. A disc recorded in Video mode can take up to 20 minutes.

Initializing a recordable DVD disc

When you first load a blank disc, the recorder will initialize it automatically for recording. You can also manually initialize discs for either Video mode recording or VR mode recording.¹

By default, the recorder initializes blank DVD-RW discs for VR mode recording. See *DVD-RW Auto Init.* on page 97 if you want to change the default to Video mode.

DVD-R discs are ready for Video mode recordings out of the box; if you want to use a DVD-R for VR mode recording, you must do it before recording anything else on the disc.

Important

- Initializing a DVD-RW disc will erase everything recorded on it. Make sure there is nothing on the disc that you want to keep!
- You may not be able to re-initialize a DVD-RW disc in a different format if it was originally initialized on an older DVD recorder.
- Once initialized for VR mode recording, you can't re-initialize a DVD-R back to Video mode.

- 1 Press **HOME MENU** and select '**Disc Setup**'.
- 2 Select '**Initialize**'

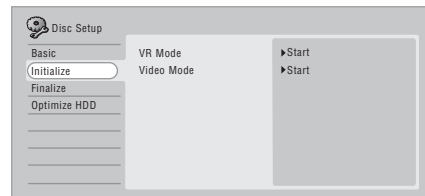

3 Select '**Video Mode**' or '**VR Mode**' from the initialize options.

4 Select '**Start**'.

It takes about 30 seconds to initialize the disc.

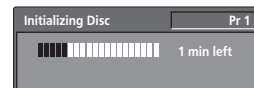

Note

1.If a disc was previously finalized on an older DVD recorder, you may not be able to re-initialize and/or initialize it for Video mode recording.

Chapter 6

Playback

Introduction

Most of the features described in this chapter make use of on-screen displays. Navigate these using the **↑/↓/←/→** and **ENTER**. To go back one level from any screen, use the **RETURN** button. Remember also that the button guide at the bottom of every screen shows which buttons do what.

Many of the functions covered in this chapter apply to the HDD, DVD discs, Video CDs, Super VCDs, WMA/MP3 discs and CDs, although the exact operation of some varies slightly with the kind of disc loaded. The following icons are provided to help you quickly identify which instructions you need for which kind of disc.

- DVD** Any kind of DVD, DVD-R or DVD-RW
- DVD-Video** Commercially produced DVD or finalized Video mode DVD-R/RW
- Video mode** Video mode DVD-R/RW (unfinalized)
- VR mode** VR mode DVD-R/RW
- HDD** HDD
- CD** Audio CD
- Video CD** Video CD
- Super VCD** Super VCD
- MP3** WMA or MP3 files

- Some DVD-Video discs don't allow certain playback controls to operate at certain points in the disc. This is not a malfunction.
- When playing Video CDs, some functions, such as making a program list, are not available in PBC mode. Stop the disc first, then start playback by pressing **▶▶**.
- For discs that contain JPEG picture files, see *The PhotoViewer* on page 85.

Navigating discs and the HDD

ALL

During playback you can easily jump to another title, chapter or track on a disc using the number buttons on the remote.

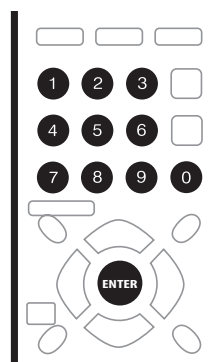

DVD-Video **Video mode**

1 During playback use the number buttons to enter a chapter number within the current title.

For example, for chapter 6, press **6**; for chapter 24, press **2**, then **4**.

- To clear and start again, press **CLEAR**.

2 Optionally: Press ENTER.

- Alternatively, just wait a few seconds and playback will jump to the new chapter.

HDD **VR mode**

1 During playback, use the number buttons to input a title number.

For example, for title 6, press **6**; for title 24, press **2**, then **4**.

- To clear and start again, press **CLEAR**.

2 Optionally: Press ENTER.

- Alternatively, just wait a few seconds and playback will jump to the new title.

CD

Video CD

SuperVCD

MP3

1 During playback, use the number buttons to input a track number.

For example, for track 6, press **6**; for track 24, press **2**, then **4**.

- To clear and start again, press **CLEAR**.

2 Optionally: Press ENTER.

- Alternatively, just wait a few seconds and playback will jump to the new track.

Using the Disc Navigator to browse the contents of a disc.

Use the Disc Navigator to browse the contents of a disc and start playback.

Using the Disc Navigator with recordable discs and the HDD

VR mode

Video mode

HDD

You can use the Disc Navigator to browse and edit video on recordable DVDs and the HDD, and to view information on titles.

See also *Editing* on page 73 for more on editing recordable discs.

1 Use the HDD/DVD button to select the hard disk drive or DVD.

2 Press HOME MENU and select 'Disc Navigator' from the on-screen display.

Alternatively, you can press **DISC NAVIGATOR** to go straight to the Disc Navigator screen.

3 Use the **↑/↓** buttons to browse up and down the list of titles.

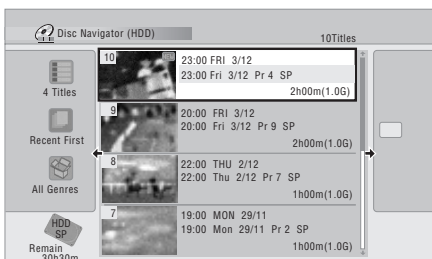

- Use the **◀◀/▶▶** buttons to display the previous/next page of titles, if there are more titles than can fit on to the screen.
- You can change the style and order in which titles are displayed from the view options menu. See below for more on this.

- You can change the thumbnail picture displayed for a title; see *Set Thumbnail* on page 76.

4 To play the highlighted title, press ENTER.

- You can also select **Play** from the command menu options.



Tip

- Use the time search feature to find a particular point on a DVD or within a title on the HDD. See *Search Mode* on page 57 for more information.

Changing the display style of the Disc Navigator

You can choose to display titles in the Disc Navigator in various different ways, sorted alphabetically, by recording date, by genre, and so on. You can also choose whether to display four or eight titles on the screen at the same time.

1 From the Disc Navigator's title list, press **←** to display the view options panel.

The View Options panel

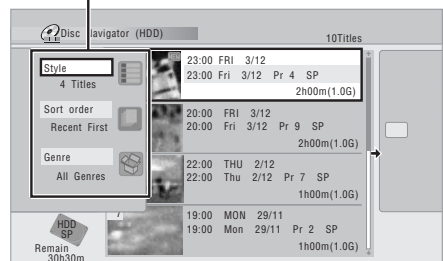

2 Use the **↑/↓** buttons to select 'Style', 'Sort Order' or 'Genre', then press ENTER to see the available view options.

- Style** – Select four or eight titles per screen view

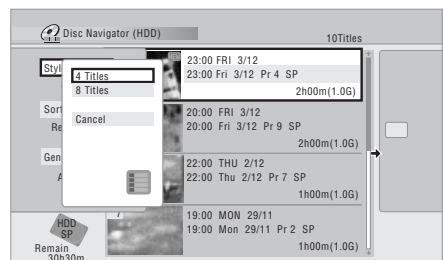

- **Sort Order** – Sort by date (most recent first), unwatched first, title name or recording date (oldest first)

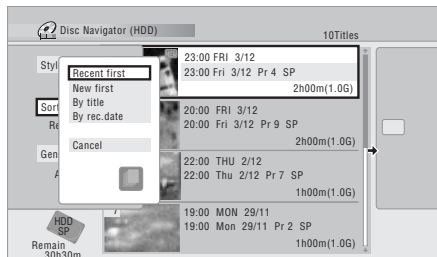

- **Genre** – Display all genres or just a selected genre

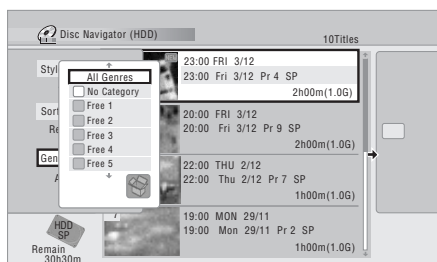

3 Use the ↑/↓ buttons to select an option, then press ENTER.

The title list display is updated according to the new display preferences.

4 Press → to return to the title list.

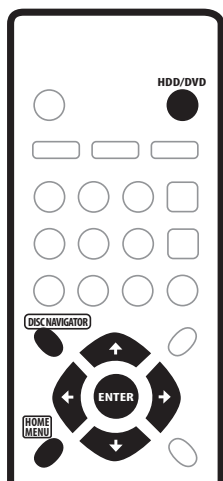

Using the Disc Navigator with playback-only discs

DVD-Video CD Video CD Super VCD MP3

1 Press HOME MENU and select 'Disc Navigator' from the on-screen display.

Alternatively, for a CD, Video CD, Super VCD or WMA/MP3 disc, you can press **DISC NAVIGATOR**, which takes you straight to the Disc Navigator screen.



2 Select what you want to play.

Use the ↑/↓/←/→ to highlight items and **ENTER** to select.

Depending on the type of disc you have loaded, the Disc Navigator looks slightly different.

- When a DVD is loaded, titles are shown on the left, chapters on the right. Select a title, or a chapter within a title.
- When a CD or Video CD/Super VCD¹ is loaded, a list of the tracks is displayed.
- When a WMA/MP3 disc is loaded, a list of folders and tracks is displayed (as shown below). Select a folder or a track within a folder.

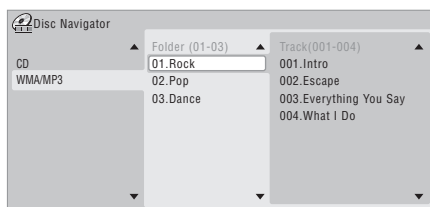

Playback starts after you press **ENTER**.

- For discs that contain both CD-Audio tracks and WMA/MP3 tracks, you can switch the playback area between **CD** and **WMA/MP3**. This can only be done while the disc is stopped.

Note

1.It's not possible to use the Disc Navigator when playing a Video CD/Super VCD in PBC mode.

Scanning discs

You can fast scan discs at various speeds, forwards or backward.¹

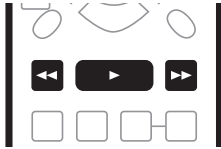

1 During playback, press ◀◀ or ▶▶ to start reverse or forward scanning.

- The scanning speed is shown on-screen.

2 Press the same button repeatedly to increase the scanning speed.

DVD

HDD

- Forward:

SCAN 1 (1.5x Quick View) → SCAN 2 → SCAN 3 → SCAN 4

- Reverse:

Reverse play² → SCAN 1 → SCAN 2 → SCAN 3 → SCAN 4

CD

Video CD

Super VCD

MP3

- Forward/Reverse:
SCAN 1 → SCAN 2

3 To resume normal playback, press ▶.

Playing in slow motion

DVD

HDD

Video CD

Super VCD

You can play video at various slow motion speeds. DVDs and video on the HDD can be played in slow motion in either direction, while Video CD/Super VCDs can only be played forwards in slow motion.³

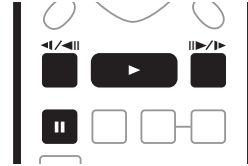

1 During playback, press II.

2 Press and hold ◀|/◀|| or |||/|▶ to start slow motion reverse or forward playback.

3 Press the same button repeatedly to change the slow motion speed.

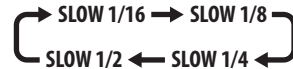

4 To resume normal playback, press ▶.

Note

- Only analog audio is output when scanning audio CDs.
 - No subtitles are displayed when scanning DVDs.
 - Analog and digital sound is output when scanning DVDs with Dolby Digital or Linear PCM sound on forward **SCAN 1**. (Linear PCM is output from the optical digital output, Except during chase playback and simultaneous recording/playback) No sound is output when using other scan speeds.
 - No sound is output when scanning from the HDD, except on forward **SCAN 1**. (Linear PCM is output from the optical digital output during forward **SCAN 1**).
 - Depending on the disc, normal playback may automatically resume when a new chapter is reached on a DVD disc.
- Depending on the disc, reverse playback may not be smooth.
- The picture quality during slow motion playback is not as good as during normal playback and depends on the disc being played.
 - Reverse slow-motion playback may not be as smooth as forward and may be better with some discs than others.
 - Depending on the disc, normal playback may automatically resume when a new chapter is reached on a DVD disc.
 - No sound is output during slow-motion playback.

A-B Repeat

DVD

CD

Video CD

HDD

The A-B Repeat function allows you to specify two points (A and B) within a track or title that form a loop which is played over and over.¹

1 During playback, select 'A-B Repeat' from the Play Mode menu.

2 With 'A (Loop Start)' highlighted, press ENTER at the point you want the loop to start.

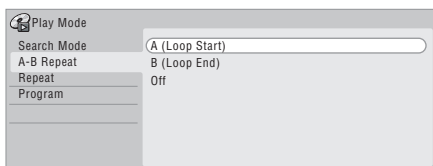

After setting the loop start point, the highlight will automatically move down to **B (Loop End)**.

3 With 'B (Loop End)' highlighted, press ENTER at the point you want the loop to end.

Playback immediately jumps back to the start point and plays the loop round and round.

- When playing a DVD-Video/Video mode DVD, or from the HDD, the start and end points of the loop must be in the same title.

4 To resume normal playback, select 'Off' from the A-B Repeat menu.

- You can also press **CLEAR** to cancel A-B Repeat play if no menu OSD (such as the Play Mode menu) is displayed.

Repeat play

ALL

There are various repeat play options, depending on the kind of disc loaded, or if you're using the HDD for playback. It's also possible to use repeat play together with program play to repeat the tracks/chapters in the program list (see *Program play* on page 59).²

1 Select 'Repeat' from the Play Mode menu.

2 Select a repeat play mode.

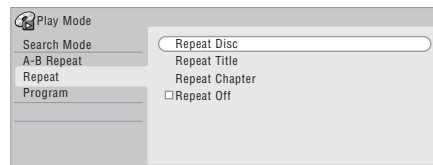

VR mode

- For VR mode DVD discs, select **Repeat Disc**, **Repeat Title** or **Repeat Chapter** (or **Repeat Off**).

DVD-Video

Video mode

HDD

- For HDD, DVD-Video and Video mode DVD discs, select **Repeat Title** or **Repeat Chapter** (or **Repeat Off**).

CD

Video CD

Super VCD

- For CDs and Video CD/Super VCDs, select **Repeat Disc** or **Repeat Track** (or **Repeat Off**).

MP3

- For WMA/MP3 discs, select **Repeat Disc**, **Repeat Folder** or **Repeat Track** (or **Repeat Off**).

3 To resume normal playback, select 'Repeat Off' from the Repeat Play menu.

- You can also press **CLEAR** to cancel repeat play if no menu OSD (such as the Play Mode menu) is displayed.

Note

- If you switch camera angles during A-B repeat play, A-B repeat is canceled.
- You can't use A-B Repeat with WMA/MP3 or Super VCD discs.
- If you switch the camera angle during repeat play of a DVD-Video disc, repeat play is canceled.

Program play

DVD-Video HDD CD Video CD Super VCD MP3

This feature lets you program the play order of titles/chapters¹/folders/tracks on a disc or the HDD.

- 1 Select 'Program' from the Play Mode menu.
- 2 Select 'Input/Edit Program' from the list of program options.

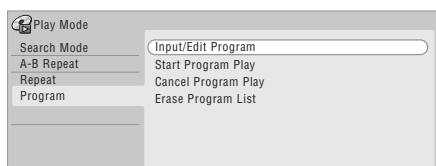

The Program edit screen that appears depends on the kind of disc loaded.

On the left side is the program list, then to the right is a list of titles (DVD, HDD), folders (WMA/MP3), or tracks (CD, Video CD/Super VCDs). On the far right is a list of chapters (DVD, HDD) or tracks (WMA/MP3).

3 Select a title, chapter, folder or track for the current step in the program list.

DVD or HDD: You can add a whole title, or a chapter within a title to the program list.

- To add a title, select the title.
- To add a chapter, first highlight the title, then press **→** and select a chapter from the list.

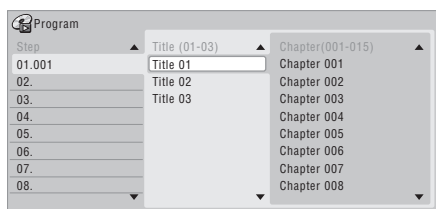

CD or Video CD/Super VCD: Select a track to add to the program list.

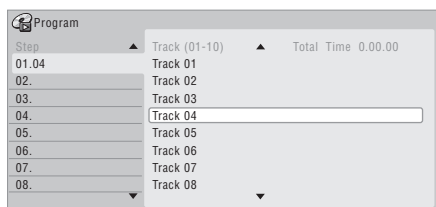

WMA/MP3: You can add a whole folder, or a track within a folder to the program list.

- To add a folder, select the folder.
- To add a track, first highlight the folder, then press **→** and select a track from the list.

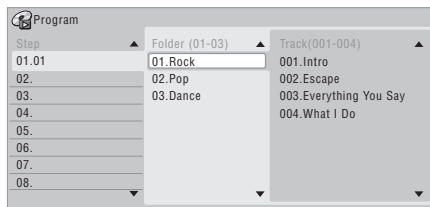

After pressing **ENTER** to add the title/chapter/folder/track, the step number automatically moves down one.

- To insert a step into the program list, highlight the step number where you want to insert another step, then select a chapter/title/folder/track as usual. After pressing **ENTER**, all the subsequent steps move down one.
- To delete a step from the program list, highlight the step you want to delete, then press **CLEAR**.

4 Repeat step 3 to build up a program list.

A program list can contain up to 24 titles/chapters/folders/tracks.

5 To play the program list, press **▶**.

Program play remains active until you turn off program play (see below), erase the program list (see below), eject the disc or switch off the recorder.

- You can use repeat play with program play. Start playback of the program list then select **Program Repeat** from the Repeat Play Mode menu (see *Repeat play* on page 58).

Note

1. When playing a program list of DVD-Video chapters, chapters not included in the program list may be sometimes be played, depending on the disc.

**Tip**

- To save your program list and exit the program edit screen without starting playback, press **HOME MENU**.
- You can change the program list by selecting **Input/Edit Program** from the Play Mode Program menu.
- During program play, press **▶▶** to skip to the next program step.
- Press **CLEAR** during playback to switch off program play (if no menu OSD, such as the Disc Navigator, is displayed). Press while stopped to erase the program list.

Other Program play functions

As well as creating and editing a program list, you can start program play, cancel program play, and erase the program list from the Play Mode menu.

- 1 Press **HOME MENU**, select '**Play Mode**', then '**Program**'.
- 2 Select a program play function.
 - **Input/Edit Program** – See above
 - **Start Program Play** – Starts playback of a saved program list
 - **Cancel Program Play** – Turns off program play, but does not erase the program list
 - **Erase Program List** – Erases the program list and turns off program play

Displaying and switching subtitles**DVD-Video**

Some DVD discs have subtitles in one or more languages; the disc box will usually tell you which subtitle languages are available. You can switch subtitle language during playback.¹

Check the disc packaging for details of the subtitle options.

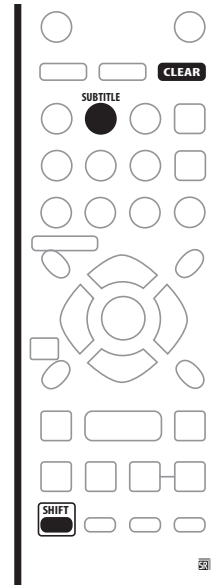

- 1 Press **SUBTITLE (SHIFT + 2)** repeatedly to select a subtitle option.

The current subtitle language is shown on-screen and in the front panel display.

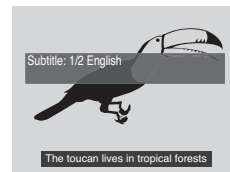

- 2 To switch off subtitles, press **SUBTITLE (SHIFT + 2)** then **CLEAR**.

Note

1. • Some discs only allow you to change subtitle language from the disc menu. Press **TOP MENU** or **MENU** to access.
 - To set subtitle preferences, see *Subtitle Language* on page 96.

Switching DVD soundtracks

DVD-Video

When playing a DVD disc recorded with two or more soundtracks (often in different languages), you can switch the soundtrack during playback.¹

Check the disc packaging for details of the soundtrack options.

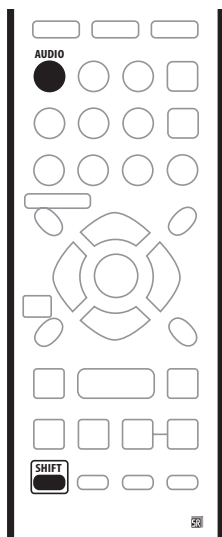

- Press **AUDIO (SHIFT + 1)** repeatedly to select an audio soundtrack.

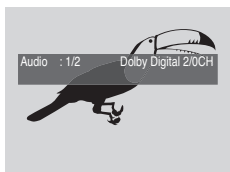

- The sound may drop out for a few seconds when switching soundtracks.
- Some discs feature both Dolby Digital and DTS soundtracks. There is no analog audio output when DTS is selected. To listen to the DTS soundtrack, connect this recorder to a DTS decoder or AV amp/receiver with built-in DTS decoder via the digital output. See *Connecting to an AV amplifier/receiver* on page 19 for connection details.

Note

- Some discs only allow you to change audio language from the disc menu. Press **TOP MENU** or **MENU** to access.
 - To set audio language preferences, see *Audio Language* on page 96.
- Only when HDD Recording Format is set to Video Mode Off (*HDD Recording Format* on page 97).
- When playing a Bilingual recording on a VR mode disc, if you are listening to the Dolby Digital soundtrack via the digital output, you cannot switch the audio channel. Set **Dolby Digital Out to Dolby Digital → PCM** (see *Dolby Digital Out* on page 95) or listen via the analog outputs if you need to switch the audio channel.

Switching audio channels

VR mode HDD CD Video CD Super VCD

MP3

For HDD² and VR mode content recorded with bilingual audio, you can switch between left (**L**) channel, right (**R**) channel, or both (**L+R**).³

When playing Video CDs and audio CDs you can switch between stereo, just the left channel or just the right channel.

Some Super VCDs have two soundtracks. With these discs you can switch between the two soundtracks as well as individual channels in each.

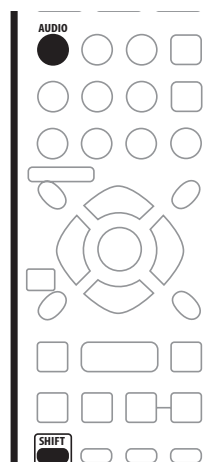

- To display/switch the audio channel, press **AUDIO (SHIFT + 1)** repeatedly.

The audio channel(s) currently playing are indicated on-screen.

VR mode HDD

- **L+R** – Both channels (default)
- **L** – Left channel only
- **R** – Right channel only

CD Video CD MP3

- **Stereo** – Stereo (default)
- **1/L** – Left channel only
- **2/R** – Right channel only

Super VCD

- **1 Stereo** – Soundtrack 1 / Stereo (default)
- **1 L** – Soundtrack 1 / Left channel
- **1 R** – Soundtrack 1 / Right channel
- **2 Stereo** – Soundtrack 2 / Stereo
- **2 L** – Soundtrack 2 / Left channel
- **2 R** – Soundtrack 2 / Right channel

Switching camera angles

DVD-Video

Some DVD-Video discs feature scenes shot from two or more angles—check the disc box for details: it should be marked with a  icon if it contains multi-angle scenes. When a multi-angle scene is playing, the same icon appears on screen to let you know that other angles are available (this can be switched off if you prefer—see *Angle Indicator* on page 98).

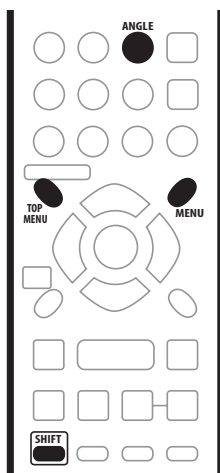

- **To switch the camera angle, press ANGLE (SHIFT + 3).**
 - The angle number is displayed on-screen.
 - If the disc was paused, playback starts again with the new angle.
 - Repeat play is canceled if you change the angle while repeat playback is active.
 - You can also change the angle from some DVD-Video disc menus. Press **TOP MENU** or **MENU** to access.

Chapter 7

Copying and back-up

Introduction

Use the copying features of this recorder to:

- Back up important recordings stored on the HDD to a DVD.
- Make a DVD copy of a recording on the HDD to play in another player.
- Transfer video from a DVD to the HDD for editing.
- Transfer edited video from the HDD to DVD.

The simplest way to copy a title is to use the One Touch Copy feature. This copies the currently playing HDD title to DVD, or DVD title to the HDD. See *One Touch Copy* on page 63 for detailed instructions.

For more sophisticated copying tasks you can build a Copy List of titles to copy, and edit titles so that you only copy the bits you want. See *Using Copy Lists* on page 64 for detailed instructions.

Where possible, the recorder will copy your recordings at high-speed. Depending on the recording mode, the kind of disc loaded and various other factors, copying can be as fast as one minute per hour of video. See *Minimum copying times* on page 102 for more on copying times.

If you want to save disc space you can copy video at a lower recording quality (for example, an XP recording on the HDD copied to SP on a DVD). Copying in this way is always done in real-time.

When real-time copying from the HDD to a Video mode DVD, the chapter markers in the original material are not copied. Chapter markers are put into the copy at intervals, according to the Auto Chapter (Video) setting (see also *Auto Chapter (Video)* on page 97).

Restrictions on copying

Some video material is copy-once protected. This means that it can be recorded to HDD, but it can't then be freely copied again. If you want to transfer copy-once protected material from HDD to DVD, you'll need to use a VR mode disc compatible with CPRM Ver. 1.1 or higher (see *CPRM* on page 38 for more on this). Only one instance of a copy-once protected title can be added to the Copy List, and after it's been copied, the title is erased from the HDD (it is therefore not possible to copy a locked title that is copy-once protected).

You can identify copy-once protected material during playback by displaying disc information on-screen. If the current title is copy-once protected, an exclamation mark (!) is shown (see *Play display 2* on page 36).

Copyright

Recording equipment should be used only for lawful copying and you are advised to check carefully what is lawful copying in the country in which you are making a copy. Copying of copyright material such as films or music is unlawful unless permitted by a legal exception or consented to by the rightowners.

One Touch Copy

* See also *Copyright* above.

The One Touch Copy feature copies the currently playing or selected (in the Disc Navigator) HDD title to DVD, or DVD title to HDD. The whole title is copied, regardless of where in the title you start the copy.

HDD to DVD copies are made in the same recording mode. When copying DVD to HDD, the copy is made in whatever recording mode is currently set.

Make sure that a recordable DVD-R/RW disc is loaded when trying to copy from the HDD.

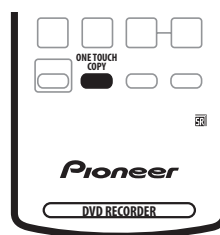

1 If you're copying from DVD to the HDD, use the REC MODE (SHIFT + ■) button to select a recording mode.

Note that selecting a recording mode higher than the title playing will not result in a better quality recording.

2 During playback, press ONE TOUCH COPY to copy the current title.

The front panel display indicates that the title is being copied.

- High-speed copying is used when copying from the HDD to DVD. Playback continues while copying.
- Real-time copying is used when copying from DVD to the HDD. Playback restarts from the beginning of the title.

Canceling One Touch Copy

You can cancel a One Touch Copy once it's started.

- **Press and hold ONE TOUCH COPY for more than a second.**

Copying is canceled and the video already copied is erased.

- If you cancel a HDD to DVD-R copy, the space available for recording does not return to the pre-copy figure.

Notes on copying using One Touch Copy

Copying to DVD

- Title name, chapter markers, as well as thumbnail picture markers for the Disc Navigator, are also copied. However, if you copy to a Video mode DVD-R/RW, only the first 40 characters of a name are copied.
- The chapter markers in the copy may not be in exactly the same positions as the original when recording on to a Video mode disc.
- You can't use the One Touch Copy function to copy a title if any part of the title is copy-once protected.
- A title that contains mixed aspect ratios can't be copied to a Video mode disc. Use a VR mode disc for this type of material.
- Low resolution (**SEP** through **LP** modes¹) widescreen material can't be copied to a Video mode disc. Use a VR mode disc for this type of material.
- When HDD Recording Format is set to Video Mode Off, titles recorded in **LP/MN9–15** modes cannot be high-speed copied to a Video mode DVD. Please use a VR mode disc.
- Recordings of bilingual broadcasts cannot be high-speed copied to a Video mode DVD. Please use a VR mode disc.
- **XP+** titles cannot be copied to DVD at high-speed.

Copying to the HDD

- The maximum title length for copying is 12 hours.
- Title name and chapter markers are also copied, except when copying from a finalized Video mode disc.
- Thumbnail picture markers and chapter markers for the Disc Navigator are copied, but their position in the copy may be slightly changed from the original.
- If some part of the title being copied is copy-protected, copying will start, but the copy-protected portions will not be copied.

Using Copy Lists

* See also *Copyright* on page 63.

At its simplest, a Copy List is just a list of HDD or DVD titles that you want to copy. When copying HDD titles to DVD, you can, however, edit the titles in your copy list, erasing chapters you don't need, or re-naming titles, for example. Edits you make to titles in the Copy List do not affect the actual video content; only the 'virtual' content of the Copy List. So you can freely erase and modify anything in your Copy List safe in the knowledge that the actual content is not being altered.

Copying from HDD to DVD

Important

- The recorder can only store one Copy List at a time.
- The Copy List is erased if the Input Line System setting is changed (see *Additional information about the TV system settings* on page 99).
- Resetting the recorder to its factory settings (see *Resetting the recorder* on page 111) will erase the Copy List.

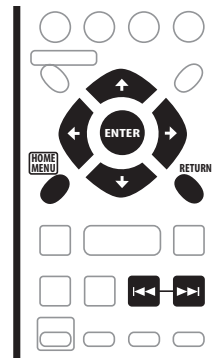

- 1 Press **HOME MENU** and select 'Copy'.



Note

1. In manual recording mode these equate to **MN1–15** (Video Mode Off) or **MN1–11** (Video Mode On).

2 Select 'HDD → DVD'.

If this is the first time to create a Copy List, skip to step 4 below.

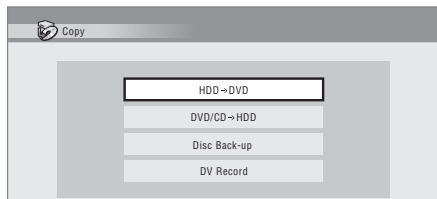

3 If there is already a Copy List stored in the recorder, choose whether to 'Create New Copy List' or 'Use Existing Copy List'.

If you select **Use Existing Copy List**, skip to step 8 below.

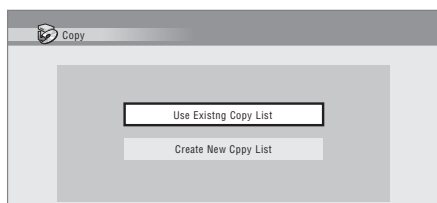

- Selecting **Create New Copy List** will erase any Copy List already stored in the recorder.

4 Select VR mode or Video mode for the copy.

For certain kinds of material you must use VR mode; for greater compatibility with other players, use Video mode.



5 Use the ↑/↓ buttons to highlight titles you want to copy, pressing ENTER after each one to add it to the Copy List.

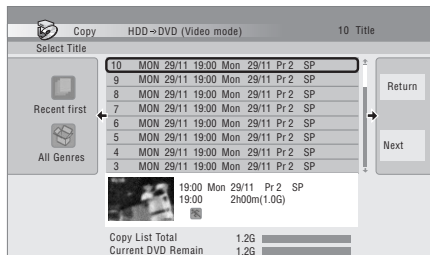

Titles you've added to the Copy List are highlighted in pink.

There are some restrictions on titles that can be added to the Copy List if you are copying to a Video mode DVD:

- When adding titles that contain copy-once protected material, the copy-once parts will not be added.
- When adding titles that contain material of more than one aspect ratio (screen size), each part with a different aspect ratio will be added as a separate title if high-speed copying is possible.

Depending on the title¹, high-speed copying may not be possible to a Video mode disc.

6 Press → to display the command menu panel.

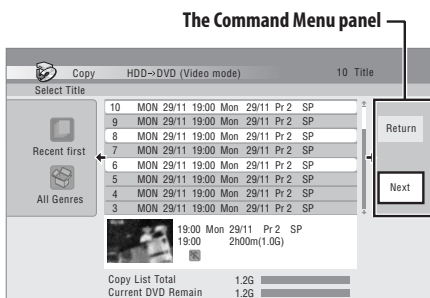

Note

- Widescreen titles recorded at low resolution (**SEP** through **LP/MN1-15** (Video Mode Off) or **MN1-11** (Video Mode On)).
 - **LP/MN9-15** recordings when HDD Recording Mode is set to Video Mode Off.
 - Bilingual recordings.
 - Combined titles that were originally recorded using different recording modes.
 - **XP+** titles.

7 Select 'Next' to move on to the Title Edit screen.

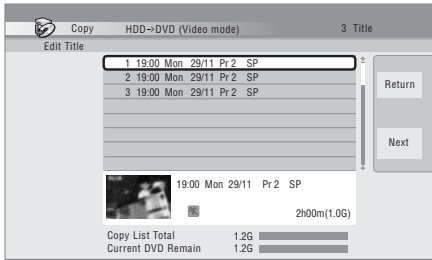

8 To edit a title, highlight it using the ↑/↓ buttons, then press ENTER.

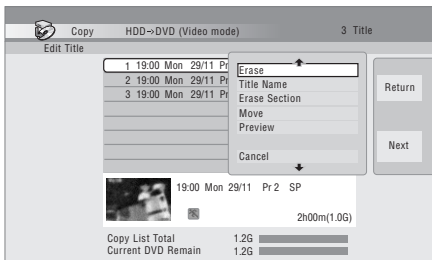

A menu of editing commands appears:

- **Erase** – Erase individual titles from the Copy List (see page 67).
- **Title Name** – Name or rename a title in the Copy List (see page 67).
- **Erase Section** – Erase part of a title (see page 68).
- **Move** – Change the order of titles in the Copy List (see page 68).
- **Preview** – Check the content of a title in the Copy List (see page 69).
- **Divide** – Divide a title in the Copy List into two (see page 69).
- **Combine** – Combine two titles in the Copy List into one (see page 69).
- **Chapter Edit** – Edit chapters within a Copy List title (see page 69):
 - **Divide** – Divide a chapter into two.
 - **Erase/Move** – Erase a chapter/Change the chapter order.
 - **Combine** – Combine two chapters into one.
- **Set Thumbnail** – Set the thumbnail frame for a title (see page 70).
- **Recording Mode** – Set the picture quality of the copy (see page 70).

- **Bilingual** – Set how bilingual audio should be copied when copying from HDD to Video mode DVD (see page 71).
- **Cancel** – Exit the Copy List screen without saving any changes.

Repeat this step for as many titles you have that need editing.

9 Press → to display the command menu panel.

10 Select 'Next' to proceed to the Start Copy screen.



- Select **Recording Mode** if you want to change the recording quality (see *Recording Mode* on page 70).
- Select **Input Disc Name** if you want to change the disc name. Input a name of up to 64 characters for a VR mode disc or 40 characters for a Video mode disc. (The input method is similar to that of naming titles; see *Title Name* on page 67.)
- Select **Finalize** if you want to automatically finalize a Video mode DVD after copying.¹ Select a title menu style from the following screen.

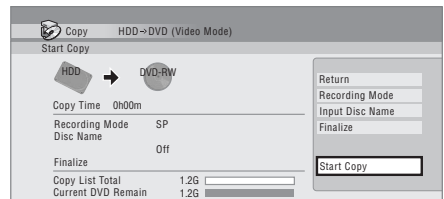

11 Select 'Start Copy' to start copying.

Note

1.If a timer recording is scheduled to start during copying, the disc will not be finalized.

Copying from DVD to HDD

Important

- The DVD to HDD Copy screen isn't accessible when a finalized Video mode disc is loaded. However, you can still use the One Touch Copy function (See *One Touch Copy* on page 63).
- The recorder can only store one Copy List at a time.
- The Copy List will be erased if:
 - any of the titles on the DVD disc are erased or edited.
 - the disc tray is opened.
 - playback is switched between Play List and Original.
 - the DVD disc is re-initialized or finalized.
 - the recorder is reset to its factory settings (see *Resetting the recorder* on page 111).
- It may not be possible to copy from a DVD disc that was recorded on a different DVD recorder or a PC.

- 1 Press **HOME MENU** and select **'Copy'**.
- 2 Select **'DVD/CD → HDD'**.
- 3 If there is already a Copy List stored in the recorder, choose whether to **'Create New Copy List'** or **'Use Existing Copy List'**.
 - Selecting **Create New Copy List** will erase any Copy List already stored in the recorder.

- 4 Use the **↑/↓** buttons to highlight titles you want to copy, pressing **ENTER** after each one to add it to the Copy List.
Titles you've added to the Copy List are highlighted in pink.

- 5 Press **⇒** to display the command menu panel.
- 6 Select **'Next'** to move on to the Title Edit screen.
- 7 To edit a title, highlight it using the **↑/↓** buttons, then press **ENTER**.

A menu appears of Copy List editing commands:

- **Erase** – Erase individual titles from the Copy List (see page 67).
- **Move** – Change the order of titles in the Copy List (see page 68).
- **Preview** – Check the content of a title in the Copy List (see page 69).
- **Cancel** – Exit the Copy List screen without saving any changes.

Repeat this step for as many titles you have that need editing.

- 8 Press **⇒** to display the command menu panel.
- 9 Select **'Next'** to proceed to the Start Copy screen.
 - Select **Recording Mode** if you want to change the recording quality (see *Recording Mode* on page 70).
- 10 Select **'Start Copy'** to start copying.

Erase

Use this command to erase individual titles from the Copy List.

- 1 Highlight the title you want to erase.
- 2 Select **'Erase'** from the command menu panel.
- 3 Select **'Yes'** to confirm or **'No'** to cancel, then press **ENTER**.

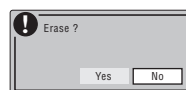

Tip

- You can erase a title quickly by pressing **CLEAR** when the title is highlighted. Confirm the edit by pressing **ENTER**.

Title Name

Use this command to name or rename titles in the Copy List (the names of the original titles remain unchanged). When copying to a Video mode disc, the name length is limited to 40 characters; for a VR mode disc, the limit is 64 characters.

- 1 Highlight the title you want to name (or rename).
- 2 Select **'Title Name'** from the command menu panel.
- 3 Input a name for the selected title.

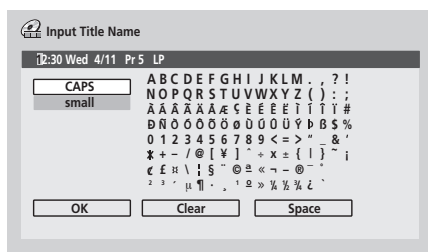

- Use the **↑/↓/←/→** and **ENTER** to select characters.
- A name generated automatically by the recorder will already be in the name input section of the screen. Use the **◀◀/▶▶** buttons to change the cursor position.

- Select **CAPS** or **small** to change to upper or lower case, or use the **CASE SELECTION** buttons (◀◀/▶▶).
- You can also use the **CLEAR** button to delete characters directly (press and hold for two seconds to delete the whole name). For other remote control key shortcuts, see *Using the remote key shortcuts to input a name* on page 76.
- For discs formatted on a different DVD recorder, you will see only a limited character set.

4 Highlight 'OK' then press ENTER to enter the name and return to the Copy List.

- To return to the main Copy List screen without saving changes to the title name, press **RETURN**.

Erase Section

Using this command you can delete a part of a Copy List title, ideal for cutting out the commercial breaks in a recording made from the TV.

1 Highlight the title containing the section you want to erase.

2 Select 'Erase Section' from the command menu panel.

The Erase Section screen appears from which you can mark the start and end points of the section to erase.

3 Select the type of edit.

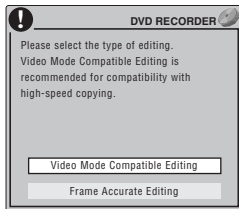

- **Video Mode Compatible Editing** – Edit points cannot be set with absolute precision, but high-speed copying to Video mode DVD will be possible.
- **Frame Accurate Editing** – Exact edit points are preserved, but high-speed copying to Video mode DVD will not be possible.
- For more information about these options, see *Editing accuracy* on page 74

4 Highlight 'From' then use the playback controls (▶, II, ◀◀, ▶▶, etc.) to find the start of the section to erase, then press ENTER.

The bar at the bottom of the screen indicates the current play position in the title. After pressing **ENTER**, a marker shows the start of the section.

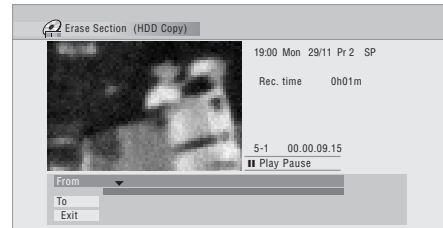

5 Highlight 'To' then, in the same way, find the end of the section to erase, then press ENTER.

After pressing **ENTER**, another marker indicates the end of the section, with the section itself marked in red.

6 Select 'Yes' to confirm, or 'No' to cancel, then press ENTER.

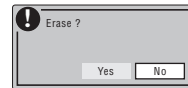

In the thumbnail viewer you can see a few seconds of video either side of the marked section to see how the edit will look.

Move

Use this command to change the order of titles in the Copy List.

1 Highlight the title you want to move and press ENTER.

2 Select 'Move' from the command menu panel.

3 Move the insert bar to the new position for the title and press ENTER.

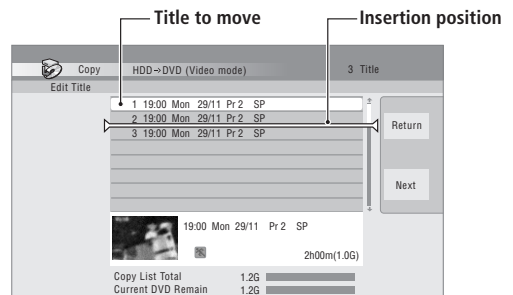

Preview

Use this command to check what's in a title.

- 1 Highlight the title you want to preview.
- 2 Select 'Preview' from the command menu panel. The selected title starts to play. Use any of the usual playback controls to scan, skip, play in slow-motion, etc.
- 3 To get back to the Copy List, press RETURN.

Divide

Use this command to make two titles from a title already in the Copy List.

- 1 Highlight the title you want to divide.
- 2 Select 'Divide' from the command menu panel.
- 3 Select the type of edit.

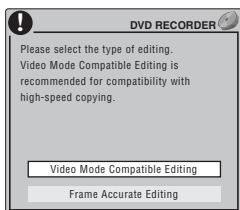

- **Video Mode Compatible Editing** – Edit points cannot be set with absolute precision, but high-speed copying to Video mode DVD will be possible.
- **Frame Accurate Editing** – Exact edit points are preserved, but high-speed copying to Video mode DVD will not be possible.
- For more information about these options, see *Editing accuracy* on page 74

- 4 Use the playback controls (▶, II, ◀◀, ▶▶, etc.) to find the place you want to divide the title.

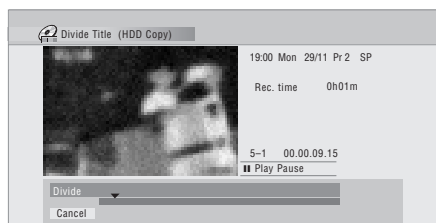

- 5 Press ENTER to divide the title at the current playback position.

Combine

Use this command to make a single title from two titles in the Copy List. The second title selected will be appended to the first.

- 1 Highlight the title you want to combine with another, then press ENTER. This title will not move. The next title you select will be appended to this one.
- 2 Select 'Combine' from the command menu panel.
- 3 Select the title you want to append to the first, then press ENTER. This title will effectively move to be added to the end of the first title. In the example below, title 3 will be appended to title 1.

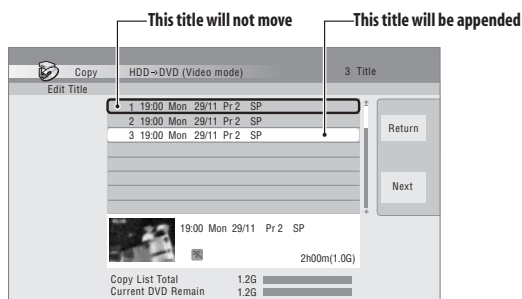

- 4 Select 'Yes' to confirm or 'No' to cancel, then press ENTER.

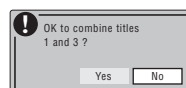

Chapter Edit

The Chapter Edit option gives you access to several commands that you can use to edit chapters within a Copy List title.

- 1 Highlight the title that contains the chapters you want to edit.
- 2 Select 'Chapter Edit' from the command menu panel.
- 3 Select the type of editing.

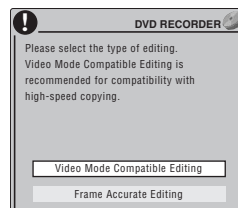

- **Video Mode Compatible Editing** – Edit points cannot be set with absolute precision, but high-speed copying to Video mode DVD will be possible.
 - **Frame Accurate Editing** – Exact edit points are preserved, but high-speed copying to Video mode DVD will not be possible.
 - For more information about these options, see *Editing accuracy* on page 74
- 4 Select the command you want:**
- **Divide** – Divide a chapter into two or more parts: Use the playback controls (▶, II, ◀◀, ▶▶, etc.) to find the point at which you want to divide the chapter, then press **ENTER**.

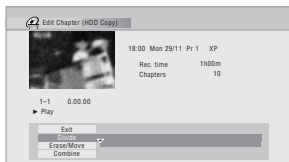

You can keep dividing the chapter as many times as you wish (up to 99 per title).

- **Erase/Move** – Erase or move chapters: Select the chapter you want to erase/move and press **ENTER**. Select whether you want to erase or move the chapter.
Move command only: Select the destination for the chapter, and press **ENTER**.

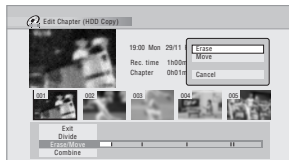

- **Combine** – Combine two adjacent chapters into one: Highlight the bar divider between two adjacent chapters and press **ENTER**.

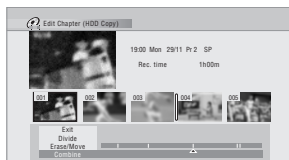

5 Select 'Exit' to get back to the main Copy List screen.

Note

1. When copying to a Video mode DVD, the chapter markers in the copy may not be in exactly the same position as the original.
2. When the copy mode is set to something other than High-Speed Copy for copying to a Video mode DVD, the chapter markers of the original are not copied. Chapter markers are put into the copy at regular intervals, according to the Auto Chapter setting (see also *Auto Chapter (Video)* on page 97).
3. XP+ mode available only when copying to HDD.
4. Optimized mode only available when copying to DVD.

Set Thumbnail

You can change the thumbnail picture that appears in the four-title display of the Disc Navigator for a title to any frame that appears in that title.

- 1 **Highlight the title you want to change the thumbnail picture for.**
- 2 **Select 'Set Thumbnail' from the command menu panel.**
The thumbnail setting screen appears from which you can find the frame you want.
- 3 **Use the playback controls (▶, II, ◀◀, ▶▶, etc.) to find a suitable frame, then press ENTER to set.**
You can also use the **CM SKIP (SHIFT + ▶▶)** buttons.



- 4 **Select 'Exit' to return to the Copy List screen.**

Recording Mode

- 1 **Select 'Recording Mode' from the command menu panel.**
- 2 **Use the ↑/↓ buttons to select a recording mode for the copy.**
 - **High-Speed Copy¹** – The Copy List is copied at the same recording quality as the original.
 - **XP, SP, LP, EP, SLP, SEP, MN²** – The Copy List is copied at the specified recording quality in real-time. (Note that if you copy at a higher quality setting than the original, the copy will not be better quality than the original.)
If you select **MN** above, you can also change the level setting (**MN1–MN32, LPCM** or **XP+³**) from the Recording Quality box that appears.
 - **Optimized^{2,4}** – The recording quality is automatically adjusted so that the Copy List fits on to the space available on the disc. Copying is carried out in real-time.

When you change the recording mode setting, you can see how much disc space it will require. If this is more than is available, it shows up in red and you won't be able to start copying. In this case, either change the recording quality, or press **RETURN** to go back to the Copy List screen and erase one or more titles from the Copy List.

3 Press **ENTER**.

Bilingual

- 1 Select the title containing the audio you want to change.
- 2 Select 'Bilingual' from the command menu panel.
- 3 Use the **↑/↓** buttons to select a bilingual audio option.
- 4 Press **ENTER**.

Using disc back-up

* See also *Copyright* on page 63.

This feature offers a simple way to make a back-up copy of a finalized Video mode disc. The data is copied first to the hard disk drive¹, then on to another recordable DVD disc.

- 1 Press **HOME MENU**, select 'Copy', then 'Disc Back-up'.
- 2 Select a back-up option.

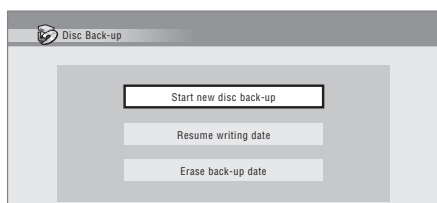

There are three back-up options:

- **Start new disc back-up** – Start making a back-up of a disc.
- **Resume writing data** – Record the back-up data already on the HDD to a recordable DVD.
- **Erase back-up data** – Erase the back-up data on the HDD.

3 Press **▲ OPEN/CLOSE (front panel)** to open the disc tray and load the disc you want to make a back-up of, then close the disc tray.

You can only make back-up copies of finalized Video mode discs.

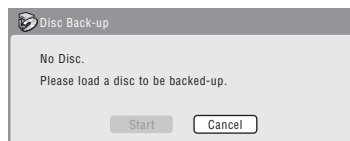

4 Select 'Start'.

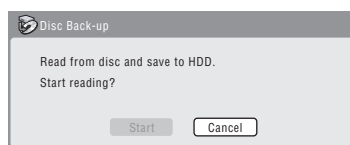

- To see the progress of the back-up, press **DISPLAY (SHIFT + HELP)**.
- You can cancel the back-up process by pressing **ONE TOUCH COPY** for more than one second.

5 When the data has been copied, press **▲ OPEN/CLOSE (front panel)** to open the disc tray. Take out the disc and load a blank* recordable DVD.

* If you're using a DVD-RW, the disc doesn't have to be blank, although the previous contents of the disc will be erased in the back-up process.

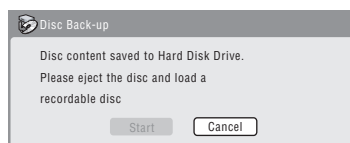

You can use a DVD-R Ver. 2.0 or 2.1 disc, or DVD-RW Ver. 1.1 or Ver. 1.2 disc for the back-up.

- If you back-up a DVD-R disc to DVD-RW, you cannot undo the finalization later.
- Actual recordable capacity of discs vary so there may be cases where the contents of the disc you're backing-up will not fit on to a particular blank disc. If this happens, please try another brand of disc.

Note

1. It is not possible to play this material directly from the HDD.

6 Select 'Start' to start writing the backed-up data to the blank disc.

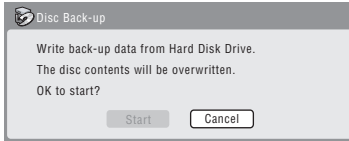

- To see the progress of the back-up, press **DISPLAY (SHIFT + HELP)**.
- You can cancel the back-up process by pressing **ONE TOUCH COPY** for more than one second. However, this will make the disc unusable (although if you are using a DVD-RW disc you can re-initialize it in order to make it usable again—see *Initializing a recordable DVD disc* on page 52.)

7 After the recorder has finished recording the back-up disc, you can select whether to make another back-up of the same data or exit.

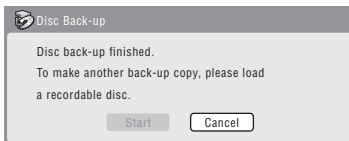

- Select **Start** to make another back-up copy or **Cancel** to finish. If you want to make another back-up copy, return to step 6 above.

8 If you don't need to keep the back-up data on the HDD, you can delete it now.

Select **Yes** to delete the data from the HDD; select **No** to keep it (you can delete it later if you want to).

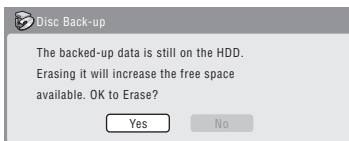

- If you decide to leave the back-up data on the HDD, you can make back-up copies to recordable DVD discs anytime from the Disc Back-up menu.

Chapter 8 Editing

The Disc Navigator screen

The Disc Navigator screen is where you can edit video content on unfinalized Video mode and VR mode DVD discs¹, as well as video content on the internal hard disk drive.

Important

- Titles that have been recorded with a Line Input setting different to the current setting of the recorder are shown in the Disc Navigator with a blank thumbnail image. See also *Additional information about the TV system settings* on page 99.
- During recording, if you display the Disc Navigator for the HDD, some of the titles may appear with a  mark. These titles were recorded with a Line Input setting different to the current setting of the recorder. During recording, these titles cannot be played.

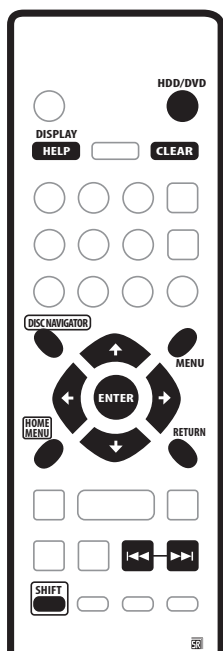

1 Use the HDD/DVD button to select the HDD or DVD.

2 Press DISC NAVIGATOR to display the Disc Navigator screen.

Playback will automatically stop when you do this.

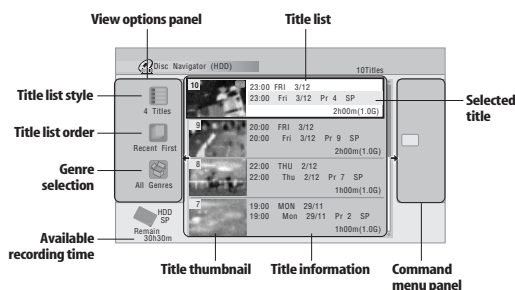

- You can also access the Disc Navigator from the Home Menu (press **HOME MENU**, select **Disc Navigator** then press **ENTER**).
- From the title list, press **→** to display the command menu panel. Use the **↑/↓** and **ENTER** buttons to navigate the menus.
- When in the title list, use the **◀◀** and **▶▶** buttons to display the previous/next page if there are more titles than can be displayed.
- Press **DISPLAY (SHIFT + HELP)** to change the title information displayed in the title list.
- If you are editing a VR mode disc you can display the Play List by selecting **Play List** from the view options panel (press **←**, then select **Play List** from the view options, then **Play List**).



- You can switch between the HDD and the DVD Disc Navigator screens using the **HDD/DVD** button.

Titles on the HDD marked with a  icon are timer recordings set to Auto Replace Recording (see *Setting a manual timer recording* on page 44).

Titles on the HDD marked with a **NEW** icon are recently recorded titles that haven't yet been played.

3 To exit the Disc Navigator, press HOME MENU.

Note

1. It isn't possible to edit video on DVD-RAM discs using this recorder.

Command menu panel options

The table below shows which commands you can use with which video type.

	HDD	Video mode	VR mode (Original)	VR mode (Play List)
Create (page 75)				●
Play (page 75)	●	●	●	●
Erase (page 75)	●	●	●	●
Edit > Title Name (page 75)	●	●	●	●
Edit > Set Thumbnail (page 76)	●	●	●	●
Edit > Erase Section (page 77)	●		●	●
Edit > Divide (page 77)	●			●
Edit > Chapter Edit (page 78)	●		●	●
Edit > Set Genre (page 79)	●			
Edit > Lock (page 79)	●	●	●	
Edit > Move (page 79)				●
Edit > Combine (page 80)				●
Genre Name (page 80)	●			
Multi-Mode (page 80)	●			
Undo (page 81)		●	●	●

Editing accuracy

Some editing (and Copy List) commands ask you whether you want to keep Video mode compatibility or frame accuracy (*Video mode compatible editing*, or *Frame accurate editing*).

Frame accurate editing is very precise. The edit point is accurate to the exact frame you choose. However, this accuracy is not preserved in any copy you make if you use the high-speed copy function to make a Video mode DVD.

Video mode compatible editing is less precise. The edit point you choose will only be accurate to within 0.5–1 second. On the other hand, these edit points will be preserved if you use high-speed copy to make a Video mode DVD.

HDD genres

The large capacity of the HDD means that there may be many hours of video in the recorder. To help you organize your HDD video content you can assign different genres to titles. There are five genres in total, including five user-definable ones that you can name as you like.

Create

VR mode *Play List only*

Use this function to create a Play List and add titles to it. Before you can use this command, make sure that the Play List is switched on in the view options panel on the left.

1 Select 'Create' from the command menu panel.

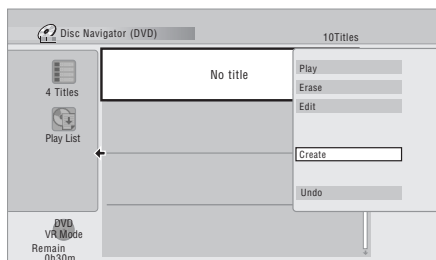

2 Select a title to add to the Play List.

Use the \uparrow/\downarrow buttons to highlight an Original title then press **ENTER** to add it and display the Play List.

3 Repeat steps 1 and 2 to add as many titles as necessary to the Play List.

Play

HDD **Video mode** **VR mode**

Use this function to start playback of a title.

1 Highlight the title you want to play.

2 Select 'Play' from the command menu panel.

Playback of the title you selected starts.



Erase

HDD **Video mode** **VR mode**

Use this function to erase unwanted titles.

When you erase titles from the HDD or Original titles from a VR mode DVD-RW, the available recording space increases accordingly. Erasing a title from a Video mode DVD-RW disc increases the available recording time only if it is the last title on the disc.

Erasing Play List titles, or titles from a DVD-R, VR mode or Video mode, will not result in any more free space on the disc.

1 Highlight the title you want to erase.

2 Select 'Erase' from the command menu panel.

3 Select 'Yes' to confirm or 'No' to cancel, then press ENTER.



Tip

- You can erase a title quickly by pressing **CLEAR** when the title is highlighted. Confirm the edit by pressing **ENTER**.

Title Name

HDD **Video mode** **VR mode**

You can give titles new names of up to 64 characters long for VR mode and HDD recordings, and up to 40 characters for Video mode recordings.

1 Highlight the title you want to name (or rename).

2 Select 'Edit' > 'Title Name' from the command menu panel.

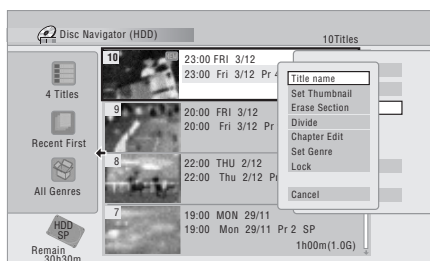

3 Input a name for the selected title.

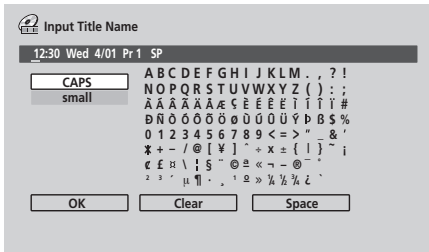

- Use the **↑/↓/←/→** and **ENTER** to select characters.
- A name generated automatically by the recorder will already be in the name input section of the screen. Use the **◀◀/▶▶** buttons to change the cursor position.
- Select **CAPS** or **small** to change to upper or lower-case, or use the **CASE SELECTION** buttons (**◀◀/▶▶**).
- You can also use the **CLEAR** button to delete characters directly (press and hold for two seconds to delete the whole name). For other remote control key shortcuts, see *Using the remote key shortcuts to input a name* below.
- For discs formatted on a different DVD recorder, you will see only a limited character set.

4 Highlight 'OK' then press ENTER to enter the name and return to the main Disc Navigator screen.

- To return to the main Disc Navigator screen without saving changes to the title name, press **RETURN**.

Using the remote key shortcuts to input a name

The table below shows the remote control key shortcuts that you can use to input characters in the name input screen. Pressing a button repeatedly cycles through the characters shown.

If you want to enter two characters in succession that are both on the same button (for example a **P** and an **R**), press **▶▶** to advance the cursor one space manually between inputting the two characters.

Key	Characters	Key	Characters
1	, ' ? ! - & 1	6	m n o 6 ö ö ò ó ø ñ
2	a b c 2 ä å á à ã æ ç	7	p q r s 7 \$ ÿ / ß * ¹
3	d e f 3 è é ê ê	8	t u v 8 ü ú û ú
4	g h i 4 î ï ï ï	9	w x y z 9
5	j k l 5 £	0	0
◀◀	[cursor back]	▶▶	[cursor forward]
◀◀/▶▶	[change case]	CLEAR	[clear character]
	<space>	■	[finish name input]
VIDEO Plus+ (SHIFT + MENU)	~ () _ / ; : " ` ^ @ # * % ¥ + = { } [] < >		

^{*1} lower-case: ÿ; upper-case: ß

Set Thumbnail

HDD Video mode VR mode

You can change the thumbnail picture that appears in the Disc Navigator for a title to any frame that appears in that title.

1 Highlight the title you want to change the thumbnail picture for.

2 Select 'Edit' > 'Set Thumbnail' from the command menu panel.

The thumbnail setting screen appears from which you can find the frame you want.



3 Use the playback controls (▶, II, ◀◀, ▶▶, etc.) to find a suitable frame, then press ENTER to set.



You can also use the CM SKIP (SHIFT + ▶▶) buttons.

4 Select 'Exit' to return to the Edit screen.

Erase Section

HDD **VR mode**

Using this command you can delete a part of a title, ideal for cutting out the commercial breaks in a recording made from the TV.

- 1 Highlight the title containing the section you want to erase.
- 2 Select 'Edit' > 'Erase Section' from the command menu panel.
- 3 *HDD only:* Select the type of edit.



- **Video Mode Compatible Editing** – Edit points cannot be set with absolute precision, but high-speed copying to Video mode DVD will be possible.
- **Frame Accurate Editing** – Exact edit points are preserved, but high-speed copying to Video mode DVD will not be possible.
- For more information about these options, see *Editing accuracy* on page 74

4 Highlight 'From' then use the playback controls (▶, II, ◀◀, ▶▶, etc.) to find the start of the section to erase, then press ENTER.

The bar at the bottom of the screen indicates the current play position in the title. After pressing ENTER, a marker shows the start of the section.



5 Highlight 'To' then, in the same way, find the end of the section to erase, then press ENTER. After pressing ENTER, another marker indicates the end of the section, with the section itself marked in red.

6 Select 'Yes' to confirm, or 'No' to cancel, then press ENTER.

In the thumbnail viewer you can see a few seconds of video either side of the marked section to see how the edit will look.

- When editing VR mode Original content, you may not be able to erase very short sections (less than five seconds).

Divide

HDD **VR mode** *Play List only*

Use this command to divide a title into two. Note that once divided, the two new HDD titles cannot be recombined into one again.

- 1 Highlight the title you want to divide.
- 2 Select 'Edit' > 'Divide' from the command menu panel.
- 3 *HDD only:* Select the type of edit.

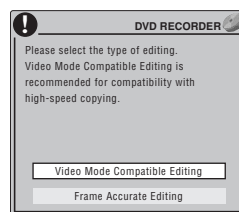

- **Video Mode Compatible Editing** – Edit points cannot be set with absolute precision, but high-speed copying to Video mode DVD will be possible.

- **Frame Accurate Editing** – Exact edit points are preserved, but high-speed copying to Video mode DVD will not be possible.
- For more information about these options, see *Editing accuracy* on page 74

4 Use the playback controls (▶, II, ◀◀, ▶▶, etc.) to find the place you want to divide the title.



5 Press ENTER to divide the title at the current playback position.

6 Select 'Yes' to confirm you want to divide the title, or 'No' to cancel.

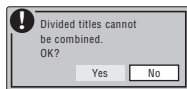

Chapter Edit

HDD **VR mode**

When editing a VR mode DVD or video on the HDD you can edit individual chapters within a title, with commands for erasing, combining and dividing.

- 1 Highlight the title that contains the chapters you want to edit.**
- 2 Select 'Edit' > 'Chapter Edit' from the command menu panel.**
- 3 HDD only: Select the type of edit.**

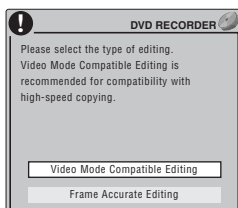

- **Video Mode Compatible Editing** – Edit points cannot be set with absolute precision, but high-speed copying to Video mode DVD will be possible.
- **Frame Accurate Editing** – Exact edit points are preserved, but high-speed copying to Video mode DVD will not be possible.
- For more information about these options, see *Editing accuracy* on page 74

4 Select the command you want:

- **Divide** – Divide a chapter into two or more parts: Use the playback controls (▶, II, ◀◀, ▶▶, etc.) to find the point at which you want to divide the chapter, then press **ENTER**.

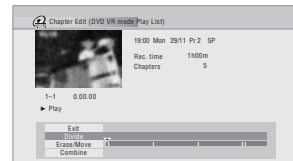

You can keep dividing the chapter as many times as you wish (up to 999 chapters per DVD disc or 99 chapters per HDD title).

- **Erase¹/Move²** – Erase or move chapters: Select the chapter you want to erase/move and press **ENTER**. Select whether you want to erase or move the chapter.

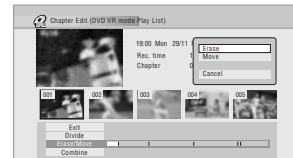

Move command only: Select the destination for the chapter, and press **ENTER**.

- **Combine³** – Combine two adjacent chapters into one: Highlight the bar divider between two adjacent chapters and press **ENTER**.



5 Select 'Exit' to get back to the main Disc Navigator screen.

Note

1. When editing VR mode Original content, it may not be possible to erase chapters less than five seconds long.
2. VR mode Play List only.
3. It may not always be possible to combine two chapters, even though they are adjacent. If a chapter has been divided into three, then the middle chapter erased, it is not possible to combine the two remaining chapters into one.

Set Genre

HDD

Use this command to assign a genre to a title.

- 1 Highlight the title you want to assign a genre to.
- 2 Select 'Edit' > 'Set Genre' from the command menu panel.

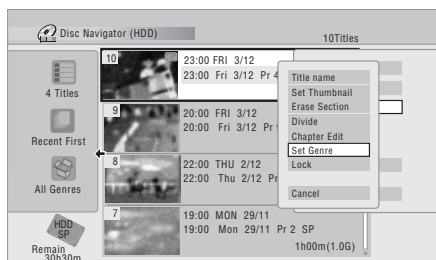

- 3 Use the **↑/↓** buttons to select a genre for the title, then press **ENTER**.

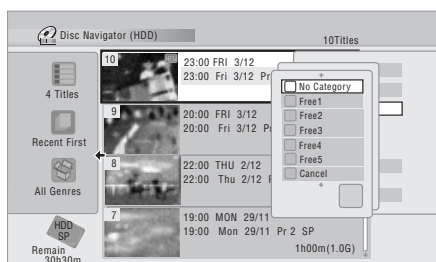

Lock

HDD

Video mode

VR mode

Original only

You can lock a title so that it can't be edited or erased accidentally. If you do need to edit it, you can always unlock it later.



Important

- You can't undo any edits made before changing the lock status. You also can't undo a lock/unlock command using the **Undo** option from the Disc Navigator menu.

- 1 Highlight the title you want to lock (or unlock).

- 2 Select 'Edit' > 'Lock' from the command menu panel.

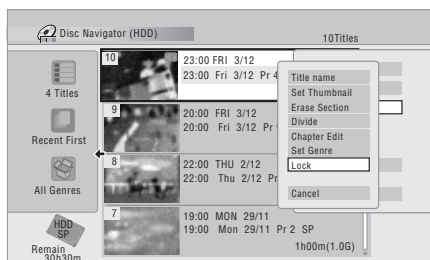

An unlocked title will become locked; a locked title will be unlocked. Locked titles are shown in the Disc Navigator with a padlock icon.

Move

VR mode

Play List only

Use this function to re-arrange the playing order of Play List titles.

- 1 Highlight the title you want to move.
- 2 Select 'Edit' > 'Move' from the command menu panel.

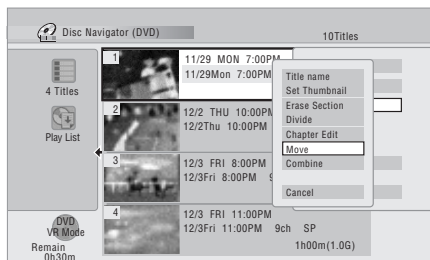

- 3 Select a new position in the Play List for the title, then press **ENTER**.

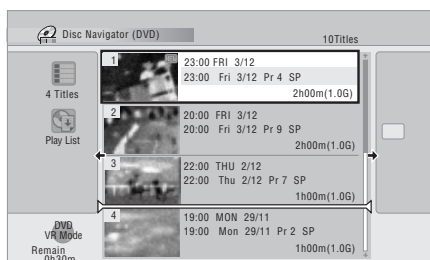

After pressing **ENTER**, the new, updated Play List is displayed.

Combine

VR mode Play List only

Use this function to combine two Play List titles into one.

1 Highlight the title you want to combine.

This title will remain in the same place after combining with another title.

2 Select 'Edit' > 'Combine' from the command menu panel.

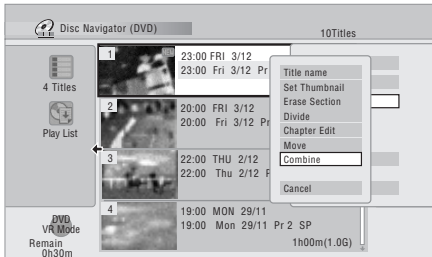

3 Select another title to combine with the first.

This title will be appended to the first title selected.

After pressing **ENTER**, the new, updated Play List is displayed.

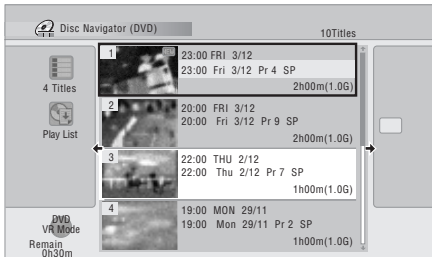

Genre Name

HDD

Use this command to rename one of the five user-definable genres (**Free 1-5**).

1 Select 'Genre Name' from the command menu panel.

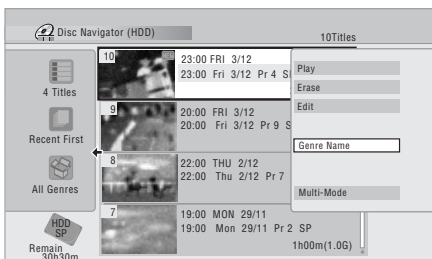

2 Use the **↑/↓** buttons to select one of the user-definable genre names, then press **ENTER**.

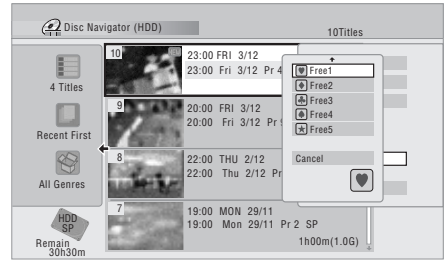

3 Input a name for the genre.

- The name can be up to 12 characters long.
- For information on remote control key shortcuts, see *Using the remote key shortcuts to input a name* on page 76.

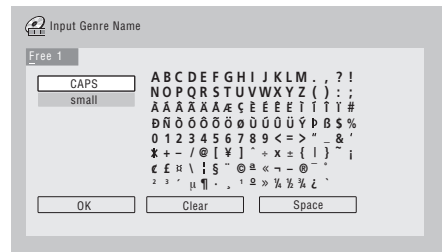

4 To finish entering the name, highlight 'OK' and press **ENTER**.

Multi-Mode

HDD

Multi-Mode allows you to select several titles, then select a command that will be applied to all of them. In this way you can select multiple titles and then erase them all at once, for example.

1 Select 'Multi-Mode' from the command menu panel.

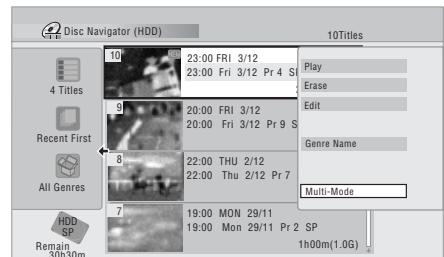

2 Select titles from the title list.

Use the **↑/↓** and **ENTER** buttons to select. Selected titles are marked with a .

3 Select 'Next' from the command menu panel.

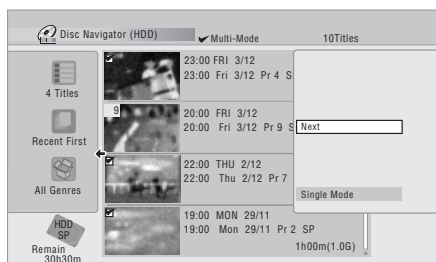

4 Select the command that you want applied to all the marked titles.

For example, select **Erase** to erase all the marked titles.

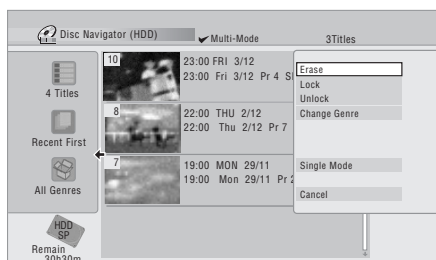

Once the command is completed, Multi-Mode is automatically exited.

Undo

Video mode VR mode

If you make a mistake while editing, you can generally undo it. There are three levels of undo (in other words, you can undo the last three edits you made).

1 Select 'Undo' from the command menu panel.

- You can't undo anything after exiting the Disc Navigator screen.

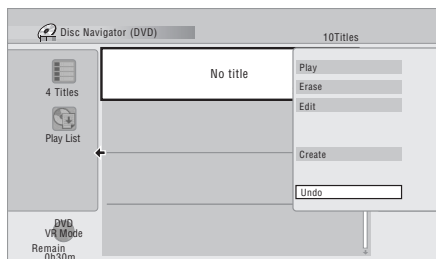

Frequently asked questions

- Why doesn't the available recording time increase when I erase titles from a VR mode DVD-R?

When you erase titles from a DVD-R, the titles are no longer displayed, but the content remains on the disc. DVD-R is a write-once medium; it can't be erased or rewritten.

- I can't edit my disc!

You may find that as the available recording time is reduced on a VR mode DVD-R disc, editing is no longer possible. This is because information about your edits requires a certain amount of disc space. As you edit, this information builds up, eventually preventing you from editing further.

Chapter 9

Using the Jukebox

The Jukebox feature allows you to use the recorder's HDD to store and playback music from up to 999 of your CDs. Once on the HDD, you can name albums, assign them a genre, and set tracks that you don't want to play to Jump.

Copying CDs to the HDD

The first step is to copy some CDs to your HDD. This is done in real-time. All tracks are copied from each CD¹ as an album. Although album and track names are not copied, you can add these later (see *Editing Jukebox albums* on page 83).

Usually, the tracks are copied to the HDD in the order they appear on the CD. If you want to copy them in some other order, set the CD to play in program play mode. See *Program play* on page 59 for how to do this.

Note that once copied to the HDD, audio tracks cannot be recorded back to a DVD-R/RW disc.



Important

- During copying, no other recorder operation is possible.
- Scheduled timer recordings will not start until copying is complete.
- Copy protected CDs may not copy successfully.

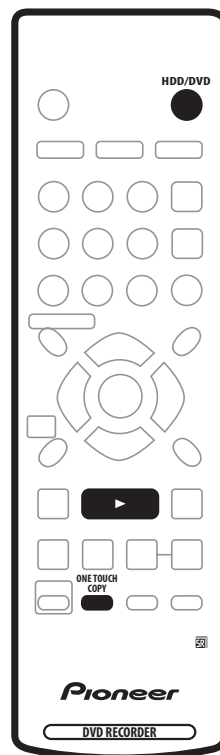

1 Press HDD/DVD and select DVD.

2 Load the CD you want to copy to the HDD.

If you want to copy the CD with a different track order, set the program play mode here.

3 Press ▶ to starts CD playback.

4 Press ONE TOUCH COPY.

Alternatively, you can select **DVD/CD → HDD** from the Copy submenu of the Home Menu.

The CD can be playing or stopped when you press **ONE TOUCH COPY**. If the CD is playing, playback (and copying) will start from the beginning of the CD.

Note

1.The recorder can copy up to 999 CDs; a CD can contain up to 99 tracks. The recorded audio format is 256 kbps Dolby Digital.

Playing music from the Jukebox

You can select albums or individual tracks from the Jukebox to play.¹

1 Press Home Menu and select 'Jukebox'.

The album list is displayed.



2 Use the ↑/↓ buttons to select the album you want to play and press ENTER.

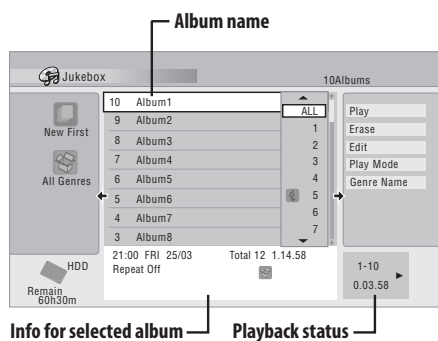

- The album always plays from the first track. Once all tracks on the selected album have played, the next album in the list will play (excluding tracks that have been set to Jump—see *Editing Jukebox albums* on page 83).

Selecting a track from an album to play

1 Use the ↑/↓ buttons to select the album containing the track you want to play, then press →.

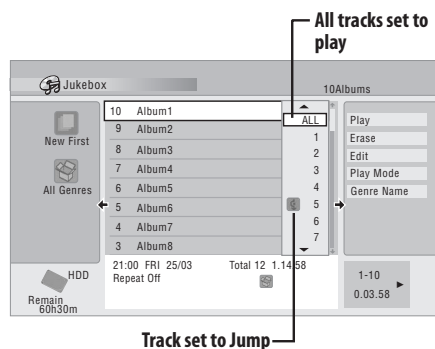

2 Use the ↑/↓ buttons to select the track you want to play and press ENTER.

- You can play tracks that are set to Jump like this (after the track has played, the next track that doesn't have Jump set will be played).

Editing Jukebox albums

A number of commands are available for editing and changing the playback behaviour of albums.

1 Use the ↑/↓/←/→ buttons to select the album/track you want to edit.

2 Press → to display the command menu panel.

3 Use the ↑/↓ buttons to select a menu command and press ENTER.

- Erase** – Erase the selected track (if all tracks in an album are selected, the whole album is erased).
- Edit > Album Name** – Enter a name of up to 64 characters for the album. See page *Title Name* on page 75 for how to enter names.
- Edit > Change Genre** – Set or change the genre for the album.
- Edit > Jump Set²** – Set a track to jump so that it doesn't play (choose this command again to cancel the Jump setting).
- Play Mode** – Change the playback order for albums and tracks.
- Genre Name** – Enter a name of up to 12 characters for a genre. See page *Title Name* on page 75 for how to enter names.

Note

- The digital audio output contains a copy-prohibit signal when albums are playing from the HDD.
- Tracks set to Jump will be skipped during consecutive track playback.

Changing the album view

- 1 From the album list, press **←** to display the view options menu panel.
- 2 Select the view option you want, then press **ENTER**.

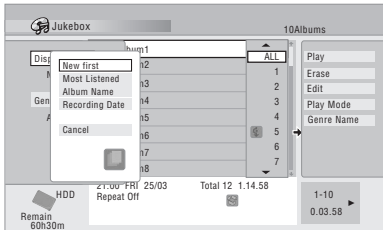

• Display order

New First – Most recently copied CDs appear at the top of the album list.

Most Listened – Most often listened to CDs appear at the top of the list.

Album Name – Albums are listed alphabetically.

Recording Date – Albums are listed by the recording date (oldest first).

• Genre

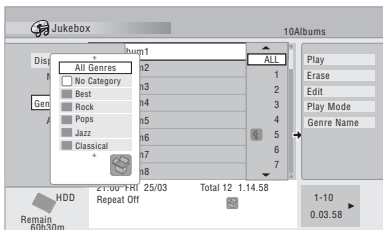

All – All albums are displayed.

Genre – Only albums in the selected genre are displayed.

Chapter 10

The PhotoViewer

From the PhotoViewer you can view JPEG photos and picture files stored on a CD-ROM/R/RW¹ on your TV.

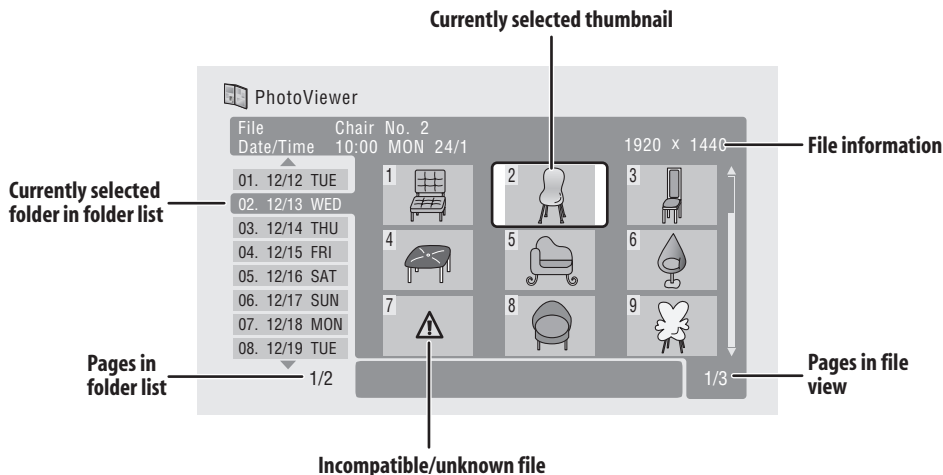

Playing a slideshow

1 Press HOME MENU and select 'PhotoViewer' to display the PhotoViewer screen.

- The PhotoViewer is only accessible when a disc containing JPEG files is loaded.
- If you encounter a disc that will not play, check that the disc and file formats are compatible with this recorder (see *JPEG file compatibility* and *PC-created disc compatibility* on page 10).

2 Use the ↑/↓ buttons to select a folder from the folder list.

The first nine images from the selected folder are displayed as thumbnails in the main part of the screen.

- The larger the file size, the longer it takes the recorder to load the file.

3 Press ENTER or → to move to the thumbnail view area.

The first thumbnail image is highlighted.

- To get back to the folder list, press RETURN (or ← when the leftmost thumbnail is highlighted).

4 Use the ↑/↓/←/→ to select a thumbnail.

- Use the I◀◀ and ▶▶I buttons to display the previous/next page of thumbnails.

5 Press ENTER or ► to start playing a slideshow from the selected thumbnail.

- Use the I◀◀ / ▶▶I buttons to display the previous/next picture, or the || button to pause the slideshow.
- Depending on the aspect ratio, some pictures may be displayed with black bars top and bottom, or left and right.
- Large picture files may take a few seconds to display. This is normal.

6 Press ■ or RETURN to return to the thumbnail view area.

7 To return to the folder view area, press RETURN (or ← when the leftmost thumbnail is highlighted).

- To exit the PhotoViewer, press HOME MENU.

Note

1. Up to 999 files or 99 folders are viewable, but if there are more files/folders than this on the disc it is still possible to view them all using the Reload function (see the following page).

Reloading files from a disc

If you have a disc with a large number of files and/or folders, you can still view all the images using the reload function.

1 Use the ↓ button to navigate to the last entry in the folder list ('Read next: ...').

2 Press ENTER to load the next batch of up to 999 files/99 folders from the disc.

It will take a moment (at most a minute) to load in the images.¹

Zooming the image

During a slideshow you can zoom in to enlarge a portion of the picture by a factor of two or four. You can also move the area of the picture displayed.

1 During a slideshow, use the CHANNEL + button to zoom the picture.

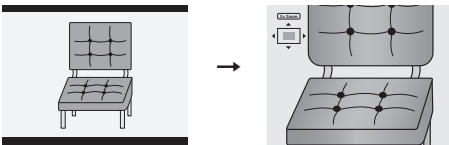

Repeated presses cycle between zoom off, 2x zoom and 4x zoom. The zoom factor is displayed on-screen.

2 Use the ↑/↓/←/→ to move the zoomed area within the picture.

Rotating an image

You can rotate the displayed picture during a slideshow so you can always view pictures the right way up, whichever way they were taken.

• During a slideshow, press ANGLE (SHIFT + 3) to rotate the displayed picture clockwise by 90°.

Press **ANGLE (SHIFT + 3)** repeatedly to continue rotating the picture in increments of 90°.



Note

¹You can press **HOME MENU** to exit the PhotoViewer screen while the recorder is reloading images. (If you enter the PhotoViewer again, it will resume reloading.)

Chapter 11

The Disc Setup menu

Introduction

From the Disc Setup menu you can name discs, lock the contents to prevent accidental recording and erasure, initialize and finalize discs. The Disc Setup menu is accessed from the Home menu:

- Press **HOME MENU** and select 'Disc Setup'.

Basic settings

Input Disc Name

VR mode **Video mode**

When you initialize a disc for recording, the recorder automatically assigns a name for the disc ranging from **DISC 1** to **DISC 99**. You can use the Input Disc Name function¹ to change the default disc name to something more descriptive. This name appears when you load the disc and when you display disc information on-screen.

- 1 Select 'Input Disc Name' from the Basic options, then 'Next Screen'.

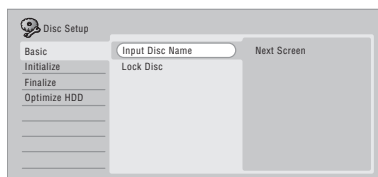

- 2 Input a name for the disc up to 64 characters long for a VR mode disc, or 40 for a Video mode disc.

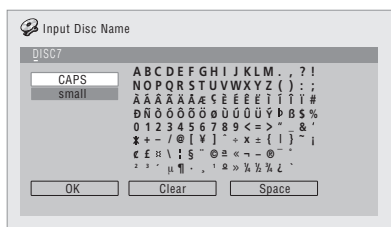

- Use the **↑/↓/←/→** and **ENTER** to select characters.

Note

1. You cannot input a name for a disc if the TV line system of the disc is different to the current setting of the recorder. See *Additional information about the TV system settings* on page 99 for how to change the recorder's setting.
2. You cannot change the lock setting for a disc if the TV line system of the disc is different to the current setting of the recorder. See *Additional information about the TV system settings* on page 99 for how to change the recorder's setting.

- Use the **◀◀/▶▶** buttons to change the cursor position.
- Select **CAPS** or **small** to change to upper or lower-case, or use the **CASE SELECTION** buttons (**◀◀/▶▶**).
- You can also use the **CLEAR** button to delete characters directly (press and hold for two seconds to delete the whole name).
- For discs formatted on a different DVD recorder, you will see only a limited character set.

Lock Disc

VR mode

- Default setting: **Off**

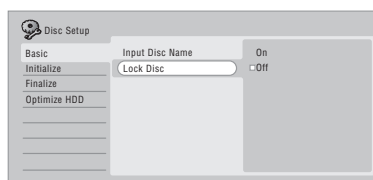

Set to **On** to prevent accidental recording, editing or erasing of the disc loaded². If you need to unlock the disc to make edits, select **Off**.

Important

- A locked disc can still be initialized (which will completely erase the disc).

Initialize settings

DVD-R **DVD-RW**

You can initialize a recordable DVD disc for either VR mode or Video mode recording.

The first time you load a new DVD-RW disc, it will be automatically initialized for recording according to the DVD-RW Auto Init. setting in the Initial Setup menu (see page 97).

New DVD-R discs are ready for Video mode recording when you load them, but it is also possible to initialize them for VR mode recording.

The initialize menu here lets you reinitialize a disc, for example if you want to change the recording format of the disc. See *Initializing a recordable DVD disc* on page 52 for detailed instructions.

Finalize settings¹

Finalize

DVD-R DVD-RW

Finalizing 'fixes' the recordings in place so that the disc can be played on a regular DVD player or computer equipped with a suitable DVD-ROM drive.

See *Playing your recordings on other DVD players* on page 51 for detailed instructions.

Undo Finalize

DVD-RW

You can undo the finalization on DVD-RW discs recorded on this recorder in Video mode. You need to do this if you want to record more material or edit material already on the disc.

You can also undo the finalization of VR mode discs which have been finalized on other DVD recorders. If when you load a disc the message **This disc cannot be recorded. Undo the finalization** is displayed, use this command to be able to record on the disc using this recorder.

1 From the Disc Setup menu, select 'Finalize', then 'Undo Finalize' from the finalize options.

2 Select 'Start'.

Optimize HDD

HDD

You'll see a message appear on-screen recommending you optimize the HDD.

As you record, erase and edit recordings, the HDD file system gradually becomes fragmented. Periodically, the HDD will need optimizing to 'clean up' all the fragmented files.

Important

- Optimizing the HDD can take as long as eight hours. During optimization, playback and recording are not possible.
- Canceling optimization mid-way does not undo the optimization already done, so the HDD will be partly optimized.
- **Select 'Optimize HDD' from the disc Setup menu.**

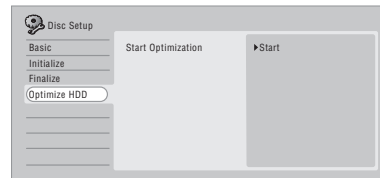

- **Select 'Start' to optimize.**

A progress bar indicates how long there is left to go.

Initialize HDD

HDD

When your DVD recorder is working without a problem this option is not visible in the Disc Setup menu. However, if the HDD file system becomes corrupted for some reason, you initialize the HDD to fix the problem. Note that initializing the HDD will erase all the data on it.

- **Select 'Initialize HDD' from the disc Setup menu.**



- **Select 'Start' to initialize.**

Note

1. You cannot finalize a disc or use the Undo Finalize command if the TV line system of the disc is different to the current setting of the recorder. See *Additional information about the TV system settings* on page 99 for how to change the recorder's setting.

Chapter 12

The Video/Audio Adjust menu

Using the Video/Audio Adjust menu you can set up the picture quality for the built-in tuner and external inputs, for disc playback, and for recording.

Setting the picture quality for TV and external inputs

Picture Creation lets you choose a set of picture quality settings for the built-in TV tuner and for each external input. There are several preset settings that suit various sources, or you can create up to three of your own sets.

Choosing a preset

1 With the recorder stopped, press **HOME MENU** and select 'Video/Audio Adjust'.



2 Select 'Video Adjust'.

3 Use the **←/→** buttons to change the preset.

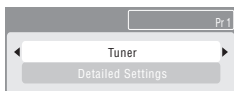

- Use the **INPUT SELECT** button to switch between the built-in TV tuner and the external inputs.
- Use the **CHANNEL +/-** buttons to change the channel of the built-in TV tuner.

There are six presets available:

- **Tuner** – suitable for general TV broadcasts
- **VCR** – suitable for video cassettes
- **LDP** – suitable for Laserdiscs
- **Memory1** – user preset 1
- **Memory2** – user preset 2
- **Memory3** – user preset 3

You can press **DISPLAY (SHIFT + HELP)** to see the individual settings for the current preset (**Tuner, VCR or LDP**).

4 Press **ENTER** to select the preset.

Creating your own set

There are three user presets in which you can save your own set of picture quality settings.

1 Follow *Choosing a preset* above and select one of the user presets (**Memory 1, 2 or 3**).

2 Select 'Detailed Settings'.

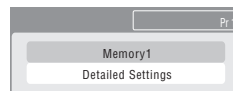

3 Use the **↑/↓** buttons to select the picture quality setting you want to adjust.

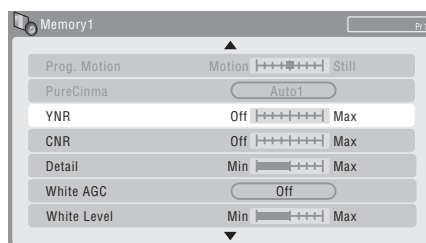

You can adjust the following settings:¹

- **Prog. Motion** – Adjusts the motion and still picture quality when video output is set to progressive.
- **PureCinema** – This setting optimizes the picture for film material when the video output is set to progressive. Usually this is best left set to **Auto**; try switching to **Off** if the picture appears unnatural.
- **YNR** – Adjusts the amount of noise reduction (NR) applied to the Y (brightness) component.
- **CNR** – Adjusts the amount of noise reduction (NR) applied to the C (colour) component.
- **Detail** – Adjusts how sharp edges appear.

Note

1. When the DV input is selected, only **Prog. Motion** and **PureCinema** settings can be adjusted.

- **White AGC** – Turn on for automatic white level adjustment.¹
- **White Level** – Adjusts the intensity of white.
- **Black Level** – Adjusts the intensity of black.
- **Black Setup** – Corrects the standard reference black level (NTSC video input only).
- **Gamma Correction** – Adjusts the brightness of darker images.
- **Hue** – Adjusts overall balance between red and green.
- **Chroma Level** – Adjusts how rich the colours appear.

4 Use the **←/→** buttons to adjust the currently selected picture quality setting.

5 When you have all the settings as you want them, press **HOME MENU** to exit.

You can now use the preset for any other input or the built-in TV tuner.



Tip

- To see more of the picture as you adjust different settings, press **ENTER** after selecting the setting you want to adjust.

Setting the picture quality for disc playback

This setting determines how the picture will look when playing discs.

Choosing a preset

- 1 With a disc playing (or paused), press **HOME MENU** and select '**Video/Audio Adjust**'.
- 2 Select '**Video Adjust**'
- 3 Use the **←/→** buttons to change the setting.

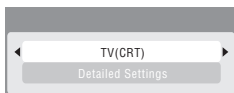

There are six presets available:

- **TV(CRT)** – suitable for standard cathode-ray tube TVs
- **PDP** – suitable for plasma display screens
- **Professional** – suitable for professional monitors

- **Memory1** – user preset 1
- **Memory2** – user preset 2
- **Memory3** – user preset 3

You can press **DISPLAY (SHIFT + HELP)** to see the individual settings for the current preset (**TV(CRT)**, **PDP** or **Professional**).

4 Press **ENTER** to select the preset.

Creating your own set

There are three user presets in which you can save your own set of picture quality settings for disc playback.

1 Follow *Choosing a preset* above and select one of the user presets (**Memory 1, 2 or 3**).

2 Move the cursor down and select '**Detailed Settings**'.

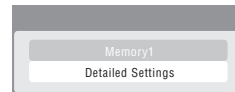

3 Select the picture quality setting you want to adjust.

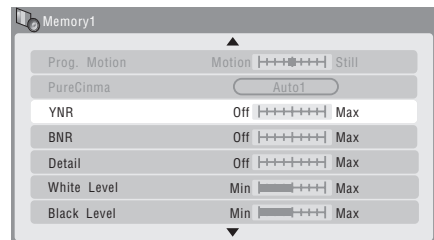

You can adjust the following settings:

- **Prog. Motion** – Adjusts the motion and still picture quality when video output is set to progressive.
- **PureCinema** – This setting optimizes the picture for film material when the video output is set to progressive. Usually this is best left set to **Auto 1**; try switching to **Auto 2**, **On** or **Off** if the picture appears unnatural.
- **YNR** – Adjusts the amount of noise reduction (NR) applied to the Y (brightness) component.
- **BNR** – Adjusts the amount of noise reduction (NR) applied to the block noise (artefacts visible in areas of flat colour, caused by MPEG compression).
- **Detail** – Adjusts how sharp edges appear.
- **White Level** – Adjusts the intensity of white.

Note

1. When **White AGC** is **On**, the **White Level** setting can't be adjusted.

- **Black Level** – Adjusts the intensity of black.
- **Black Setup** – Corrects the standard reference black level (NTSC video playback only).
- **Gamma Correction** – Adjusts the brightness of darker images.
- **Hue** – Adjusts overall balance between red and green.
- **Chroma Level** – Adjusts how rich the colours appear.

4 Use the ←/→ buttons to adjust the currently selected picture quality setting.

5 When you have all the settings as you want them, press HOME MENU to exit.



Tip

- To see more of the picture as you adjust different settings, press **ENTER** after selecting the setting you want to adjust.

Audio DRC

- Default setting: **Off**

When watching Dolby Digital material at low volume, it's easy to lose low level sounds completely—including some of the dialog. Switching on Audio DRC (Dynamic Range Control) can help by bringing up the low level sounds, while controlling high level peaks.

- 1 During playback or when paused, press HOME MENU and select 'Video/Audio Adjust'.**
- 2 Select 'Audio Adjust'.**
- 3 Use the ←/→ buttons to adjust DRC from 'Off' to 'Max'.**

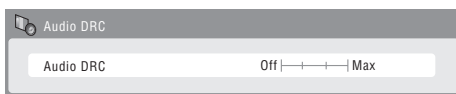

Exactly how much difference you can hear between the settings will depend on the material.



Tip

- Audio DRC is not effective when listening to a disc via the digital output when **Dolby Digital Out** is set to **Dolby Digital**. In this case adjust the dynamic range from your AV amplifier/receiver.

Chapter 13

The Initial Setup menu

Using the Initial Setup menu

The Initial Setup menu is where you can set various recorder options for sound, picture, language and so on.

Some settings can only be changed when the recorder is stopped. During playback and recording these settings are grayed out in the Initial Setup menu.

Except for the Setup Navigator, menu screens are exited automatically after 20 minutes of inactivity.

- Press **HOME MENU** and select 'Initial Setup'.

In the table below, the default option is marked with a •.

Setting	Options	Explanation
Basic Settings		
Clock Setting	Auto	Set the channel that broadcasts a clock signal and the clock will be set automatically.
	Manual •	If there is no channel that broadcasts a clock signal in your area, you can set the time and date manually.
<i>The clock must be set in order to use timer recording.</i>		
Input Line System	525 System	Use for NTSC or PAL-60 recording from an external input.
	625 System •	Use for standard PAL or SECAM recording.
<i>See also About the input line system on page 99 for more information on this setting.</i>		
Power Save	Mode 1	Only signals arriving at the antenna input are passed through to the antenna output when the recorder is in standby.
	Mode 2	No input signals are passed through to the outputs when the recorder is in standby.
	Off •	When the recorder is in standby, all signals arriving at the SCART and antenna inputs are passed along to the outputs.
Help Setting	On •	Switches on the automatic Help screens for GUI displays.
	Off	Switches off the automatic Help screens for GUI displays. (Press HELP on the remote to manually display the Help screen.)
Setup Navigator	Start	Select to start the Setup Navigator. See also <i>Switching on and setting up</i> on page 25.

Setting	Options	Explanation
Tuner Settings		
Auto Channel Setting	Auto Scan	Select your country and then wait for the recorder to auto tune into channels in your area. After auto scan has finished, the channel mapping screen appears showing which channels have been assigned to which program numbers. You can skip unwanted channels using the Manual Channel Setting option below. Press HOME MENU to exit the channel mapping screen.
	Download from TV	If your TV supports this feature you can download all the channels that your TV is tuned to via the SCART input. Select your country and then wait for the download to complete. After the download is complete, the channel mapping screen appears, as above. See also the operating instructions that came with your TV for more information.
Manual CH Setting	Next Screen	Proceed to the next screen if you need to adjust any of the settings made by auto tuning. Select your country, then proceed to the manual channel setting screen: <ul style="list-style-type: none"> • Change channel presets using the CHANNEL +/- buttons. • To skip the displayed channel (because there is no station assigned to that channel), change the Skip setting to On. • Set the CH SYSTEM setting to match the channel system of your country or region. • Set the CHANNEL setting to the channel you want to assign to the current channel preset. • To manually fine tune the channel, change the AFT setting to Off then adjust the Level setting. • The Name field allows you to input a name of up to five characters for the current channel preset. • If the currently selected channel is scrambled requiring a decoder connected to the AV2/AUTO START REC (INPUT 1/DECODER), set the Decoder setting to On.
Channel Swapping	Next Screen	Proceed to the next screen to swap channel assignments of different presets so that you can group together presets that naturally go together. Select two presets to swap then press ENTER .
Set VIDEO Plus+ CH	Next Screen	Proceed to the next screen to assign channel numbers to the guide channels as necessary. Look in your TV guide to see which channel numbers should be assigned to which guide channels. Press ENTER when your done to leave this screen.
Video In/Out Settings		
Input Colour System	Next Screen	Proceed to the next screen to set the input colour system for each channel preset. Use the CHANNEL +/- buttons to change the preset. On the default Auto setting the recorder can generally correctly detect whether the input signal is PAL, SECAM, 3.58 NTSC or PAL-60, but in some cases you may have to set it manually if the picture is displayed incorrectly.

See also About the input colour system on page 99 for more information on this setting.

Setting	Options	Explanation
Component Video Out	Interlace •	Select if your monitor/TV is not compatible with progressive-scan video.
	Progressive	Select if your monitor/TV is progressive-scan compatible. Check the operating instructions that came with your monitor/TV if you're not sure.
<i>For Component Video Out to be effective, the AV1 Out setting (see below) must be set to something other than RGB.</i>		
AV1 Out	Video •	Sets the AV1(RGB)-TV SCART output to standard composite video (compatible with all TVs).
	S-Video	Sets the AV1(RGB)-TV SCART output to S-video. Recommended if you are using a long SCART cable.
	RGB	Sets the AV1(RGB)-TV SCART output to RGB. Good quality but check your TV for compatibility.
<i>If you choose a setting that is incompatible with your TV you may not be able to see any picture at all. In this case either switch off and reconnect using the supplied video cable, or reset the recorder (see <i>Resetting the recorder</i> on page 111). The Component Video Out setting (see above) has no effect when AV1 Out is set to RGB.</i>		
AV2/L1 In	Video •	Sets the AV2/AUTO START REC (INPUT 1/DECODER) SCART input to standard composite video.
	S-Video	Sets the AV2/AUTO START REC (INPUT 1/DECODER) SCART input to S-video.
	RGB	Sets the AV2/AUTO START REC (INPUT 1/DECODER) SCART input to RGB.
	Decoder	Use this setting if you connected a decoder to the AV2/AUTO START REC (INPUT 1/DECODER) SCART connector. For scrambled channels, make sure that the channel Decoder setting is set to On . (See <i>Manual CH Setting</i> on page 93.)
NTSC on PAL TV	On •	NTSC discs will play correctly on PAL-only TVs.
	Off	Use if your TV is already NTSC-compatible.
<i>Many recent PAL TVs are compatible with NTSC input and so this setting can be switched off. Check the operating instructions that came with your TV. See also <i>About NTSC on PAL TV</i> on page 99 for related information.</i>		
Audio In Settings		
Nicam Select	NICAM •	Record the NICAM audio in a NICAM broadcast.
	Regular Audio	Record the non-NICAM audio in a NICAM broadcast. (You can still switch the audio to record using the AUDIO (SHIFT + 1) button before recording.)
Tuner Level	Normal •	Standard setting.
	Compression	Use if the audio level from the built-in tuner is excessive, causing distortion.
External Audio	Stereo •	Select if the audio from the currently selected external input is standard stereo.
	Bilingual	Select if each channel carries a separate soundtrack.
<i>When the external audio is from the DV input, an audio subcode channel within the DV audio tells the recorder whether the audio is stereo or bilingual. This has priority over the setting you make here.</i>		

Setting	Options	Explanation
Bilingual Recording	A/L •	Record the left (A) channel of a bilingual source when recording to HDD with HDD Recording Format set to Video Mode ON, to DVD in Video mode or in LPCM mode, from an external source.
	B/R	As above, but for right (B) channel recording.
<i>When recording bilingual audio to DVD in VR mode (except in LPCM mode), or to HDD with HDD Recording Format set to Video Mode Off (except in LPCM mode), both audio channels are recorded and you can switch to the one you want on playback.</i>		
DV Input	Stereo 1 •	Select to use the 'live' audio track (recorded during the video shoot) from a camcorder that supports two stereo audio tracks.
	Stereo 2	Select to use the overdubbed audio track from a camcorder that supports two stereo audio tracks.
	Mix	Select one of the three settings to use a mix of the two stereo audio tracks.
Input Level (L1–L3)	-6dB – +6dB <i>(default: 0 dB)</i>	Adjust the input level separately for each of the external inputs from -6dB to +6dB in steps of 3dB.
Audio Out Settings		
Digital Out	On •	Activates the digital audio output.
	Off	Deactivates the digital audio output.
<i>When set to Off, all the following Audio Out settings are grayed out.</i>		
Dolby Digital Out	Dolby Digital •	Output a Dolby Digital signal when a Dolby Digital source is being played.
	Dolby Digital → PCM	Convert Dolby Digital sources to Linear PCM output. Use if your connected equipment doesn't have a Dolby Digital decoder.
DTS Out	On •	Output a DTS signal when a DTS source is being played.
	Off	Switch off the digital output when a DTS source is being played. Use when your connected equipment doesn't have a DTS decoder. In this case, use the analog audio outputs.
96 kHz PCM Out	96 kHz → 48 kHz •	Convert 96 kHz digital audio sources to 48 kHz output. Use if your connected equipment doesn't support 96 kHz sampling rate.
	96 kHz	Output 96 kHz digital audio when a 96 kHz source is being played.
MPEG Out	MPEG	Output an MPEG audio signal when a source using MPEG audio is being played.
	MPEG → PCM •	Convert sources with MPEG audio to Linear PCM output. Use if your connected equipment doesn't have an MPEG audio decoder.

Setting	Options	Explanation
Language Settings		
OSD Language	English •	Sets the language of the on-screen displays to English.
	<i>available languages</i>	Choose from the languages displayed for the on-screen displays.
Audio Language	English •	Sets the default audio language for DVD-Video playback to English.
	<i>available languages</i>	Choose from the languages displayed to set the default audio language for DVD-Video playback.
	Other	Select to set the default audio language to something other than the ones listed. See <i>Selecting other languages for language options</i> on page 100.
<i>Discs do not necessarily have audio in your selected language. Also, some discs override the Audio Language preference.</i>		
Subtitle Language	English •	Sets the default subtitle language for DVD-Video playback to English.
	<i>available languages</i>	Choose from the languages displayed to set the default subtitle language for DVD-Video playback.
	Other	Select to set the default subtitle language to something other than the ones listed. See <i>Selecting other languages for language options</i> on page 100.
<i>Discs do not necessarily have subtitles in your selected menu language. Also, some discs override the Subtitle Language preference.</i>		
Auto Language	On •	On this setting: <ul style="list-style-type: none"> • DVD-Video discs whose main audio track is in your default language will play using that language, without subtitles. • Discs whose main audio track is not in your default language but that have a subtitle track in your default language will play the original audio track with subtitles.
	Off	Select to play DVD-Video discs according to your audio and subtitle language preferences.
<i>For Auto Language to be effective, the Audio Language and Subtitle Language options must be set to the same language.</i>		
DVD Menu Language	w/Subtitle Language •	Sets the language of DVD-Video menus to the same as that set for the subtitle language.
	English	Sets the language of DVD-Video menus to English.
	<i>available languages</i>	Choose from the displayed languages to set the default language for DVD-Video menus.
	Other	Select to set the DVD menu language to something other than the ones listed. See <i>Selecting other languages for language options</i> on page 100.
<i>Discs do not necessarily have menus in your selected menu language.</i>		
Subtitle Display	On •	Select to have discs display subtitles according to your Subtitle Language and Auto Language preferences.
	Off	Select to switch off subtitle display.
	Assist Subtitle	Select to display special additional assistive subtitles, where available.
<i>Some discs may override these settings.</i>		

Setting	Options	Explanation
Recording Settings		
Manual Recording	On (go to setup)	All the standard recording modes, plus MN1–32, LPCM and XP+ modes can be set.
	Off •	Just the standard recording modes (XP, SP, LP, EP, SLP and SEP) can be set.
<i>See also Manual recording modes on page 107 for detailed information on manual recording levels.</i>		
Optimized Rec	On	The recording quality of timer recordings is automatically adjusted to fit on to the selected media if it will not fit at the selected quality setting. If the recording will not fit even at MN1 , then the recording will start at MN1 and stop when all the available space is used up.
	Off •	When a timer recording is set that won't fit on to the selected media, the recording starts but is cut off when no more recording is possible.
<i>Optimized Rec will only compensate for the next scheduled timer recording if more than one is set. It cannot be used together with VPS/PDC.</i>		
Set Thumbnail	0 seconds •	Sets the default thumbnail picture in the Disc Navigator to the first frame of the title.
	30 seconds	Sets the default thumbnail picture to 30 seconds into the title.
	3 minutes	Sets the default thumbnail picture to 3 minutes into the title.
Auto Chapter (Video)	No Separation	Automatic chapter marking is switched off.
	10 minutes •	When recording in Video mode, chapter markers are inserted every 10 minutes.
	15 minutes	Chapter markers are inserted every 15 minutes.
DVD-RW Auto Init.	VR Mode •	Blank DVD-RW discs are initialized for VR mode recording when loaded into the recorder for the first time.
	Video Mode	Blank DVD-RW discs are initialized for Video mode recording.
HDD Recording Format	Video Mode Off	Recordings made to the HDD are made in VR mode. Use this setting if you don't need to transfer the recording later to a Video mode DVD.
	Video Mode On •	Recordings made to the HDD are compatible with Video mode recordings. This setting is convenient if you want to transfer the recording to a Video mode DVD as high-speed copy can be used.
<i>When Video Mode On is used, you must select the audio channel you want to record when recording a bilingual broadcast. On the Video Mode Off setting, both channels will be recorded and you can switch between them on playback. See also Bilingual Recording on page 95.</i>		
Playback Settings		
TV Screen Size	4:3 (Letter Box) •	Select if you have a standard 4:3 TV and prefer the letter box format presentation for widescreen material.
	4:3 (Pan & Scan)	Select if you have a standard 4:3 TV and prefer the pan and scan presentation for widescreen material.
	16:9	Select if you have a widescreen 16:9 TV. Your TV settings determine how 4:3 material will look.
<i>Selecting 4:3 (Letter Box) or 4:3 (Pan & Scan) does not guarantee that all video material will be presented in that format as some discs override this setting.</i>		

Setting	Options	Explanation
Still Picture	Field	Produces a stable, generally shake-free image.
	Frame	Produces a sharper image, but more prone to shake than Field stills.
	Auto •	The recorder automatically selects Field or Frame type still, according to the material playing.
Seamless Playback	On	Playback is smooth, but with a trade-off against the accuracy of the edit points.
	Off •	You may notice momentary interruption at edited points during playback of a VR mode Play List.
Parental Lock	Set Password	In order to change the parental lock level or change the country/area code, set the password using this option. From the following screen, enter a four-digit number that will be your password.
	Change Password	In order to change the password, first enter your existing password and then a new one from the following screen.
	Change Level	From the following screen, first enter your password and then set a parental lock level.
	Country/Area Code	From the following screen, first enter your password and then set a country/area code.
<i>Only certain discs have parental lock and country code features. Check the disc packaging to see what features the disc has. If you forget your password you can reset it by resetting the recorder to its factory settings. See Resetting the recorder on page 111.</i>		
Angle Indicator	On •	A camera icon appears on-screen during multi-angle scenes on a DVD-Video disc.
	Off	Nothing is indicated on-screen when a multi-angle scene is showing.
Options		
On-Screen Display	On •	The recorder displays operation displays (Stop , Play , etc.) on-screen.
	Off	Switches off the on-screen operation displays.
Front Panel Display	On •	The time is shown in the front panel display when the recorder is in standby.
	Off	The front panel display is switched off in standby (although it still lights dimly when setting a timer recording).
Remote Control Mode	Recorder 1–3 (default: Recorder 1)	If you are using more than one recorder in the same room, set them to different IDs. This setting sets the recorder ID; to change the remote controller ID, press and hold RETURN then press 1 , 2 or 3 to set. The remote will only control a recorder with the same ID.
AV. Link	This Recorder Only •	Signals received through the AV input when the recorder is in standby are not passed through to the AV output.
	Pass Through	Signals received when in standby are passed though to the output for connected devices. (Note that during EPG data download, the EPG data is not passed through.)

When set to **Pass Through**, make sure to set Power Save (page 92) to **Off**.

Additional information about the TV system settings

About the input line system

This recorder is compatible with PAL, SECAM, 3.58 NTSC and PAL-60 TV systems. The Input Line System and Input Colour System settings determine how the recorder treats incoming video signals from an external input or the built-in TV tuner.

Please note the following points when changing the input line system:

- When the current input is a built-in tuner channel preset, changing the input line system will usually also affect the input line system of the **AV2/AUTO START REC (INPUT 1/DECODER)** input. However if the **AV2/L1 In** setting is set to **Decoder**, then the L2 input is affected instead.
- If, when the Input Line System setting is changed, the screen goes blank (due to incompatibility with your TV), you can switch back by pressing and holding the front panel **■** button then pressing **▲ OPEN/CLOSE** (front panel) while the recorder is stopped.
- When you switch the Input Line System setting the Copy List is erased. If you switch the setting using the **■** button and **▲ OPEN/CLOSE** buttons as described above, there is no confirmation, so please use with care.
- You can't mix recordings of different TV line systems on the same disc.
- When you change this setting, the **Input Colour System** setting also changes (see below).

About NTSC on PAL TV

Depending on the Input Line System setting and the NTSC on PAL TV setting, the signal format output when the recorder is stopped varies as shown in the table below.

Input Line System	NTSC on PAL TV	Output when stopped
625 System	Off	PAL
	On	PAL
525 System	Off	NTSC
	On	PAL-60

About the input colour system

The available options of the Input Colour System setting depend on the Input Line System setting. The table below shows the different options available.

Input Line System	Built-in tuner	External input
625 System	Auto	Auto
	PAL	PAL
	SECAM	SECAM
525 System	n/a	Auto
		3.58 NTSC
		PAL-60

Additional information about component video output

If you switch the Component Video Out setting to **Progressive** when using a TV that is not compatible with progressive-scan video, you will not be able to see anything displayed on your TV. If this happens, press and hold the **■** button on the front panel, then press **▶**. This will set the recorder's video output back to Interlace.

Compatibility of this unit with progressive-scan TVs

Consumers should note that not all high-definition television sets are fully compatible with this product and may cause artifacts to be displayed in the picture. In case of 525 progressive scan picture problems, it is recommended that the user switch the connection to the 'standard definition' output (**Interlace**). If there are questions regarding our TV set compatibility with this model, please contact our customer service center.

This recorder is compatible with the following Pioneer displays and monitors

Plasma display

- PDP-503HDE, PDP-433HDE, PDP-434HDE, PDP-504HDE, PDP-435XDE, PDP-435HDE, PDP-435FDE, PDP-505XDE, PDP-505HDE, PDP-615EX

Selecting other languages for language options

1 Select 'Other' from the language list.

This option appears in the settings for DVD Menu Language, Audio Language, and Subtitle Language.

2 Select the language you want.



- Select by language name: Use the \leftarrow/\rightarrow buttons to change the language.
- Select by code number: Press \downarrow then use the number buttons to enter the four-digit language code.

See *Language code list* on page 108 for a list of available languages and corresponding codes.







3 Press ENTER to confirm and exit the screen.

Chapter 14





Additional information

Screen sizes and disc formats

When viewing on a standard TV or monitor

Screen format of disc	Setting	Appearance
16:9 	4:3 (Letter Box) 	The program is shown in widescreen with black bars at the top and bottom of the screen.
	4:3 (Pan & Scan) 	The sides of the program are cropped so that the picture fills the whole screen.
4:3 	16:9 	The program appears squashed. Set to either 4:3 (Letter Box) or 4:3 (Pan & Scan) .
	4:3 (Letter Box) 4:3 (Pan & Scan) 	The program is presented correctly on either setting.

When viewing on a widescreen TV or monitor

Screen format of disc	Setting	Appearance
16:9 	16:9 	The program is presented in widescreen.
4:3 		Your TV will determine how the picture is presented—check the manual that came with the TV for details.
		

Minimum copying times

The table below shows the minimum HDD to DVD copying time for one hour of video.

Please note that not all discs are compatible with high-speed copying.¹ Check with the disc manufacturer for compatibility.

Rec mode	DVD disc type					
	DVD-RW Ver. 1.0, 1.1 ^{*1}	DVD-R Ver. 2.0 DVD-RW Ver. 1.1/2x ^{*2}	DVD-R Ver. 2.0/4x ^{*3} DVD-RW Ver. 1.2/4x ^{*3}	DVD-RW Ver. 1.2/6x	DVD-R Ver. 2.0/8x ^{*4} DVD-R Ver. 2.1/8x ^{*4}	DVD-R Ver. 2.0/16x ^{*5} DVD-R Ver. 2.1/16x ^{*5}
SEP	6 mins.	3 mins.	1.5 mins.	1.25 mins.	1.1 mins.	1 min.
SLP	7.5 mins.	4 mins.	2 mins.	1.5 mins.	1.25 mins.	1.1 mins.
EP	10 mins.	5 mins.	2.5 mins.	2 mins.	1.5 mins.	1.25 mins.
LP	15 mins.	7.5 mins.	4 mins.	2.5 mins.	2 mins.	1.5 mins.
SP	30 mins.	15 mins.	7.5 mins.	5 mins.	4 mins.	3 mins.
XP	60 mins.	30 mins.	15 mins.	10 mins.	8 mins.	6 mins.

Note that all times in the above table are approximate.

^{*1} Compatible with single speed recording only

^{*2} Compatible with 2x speed recording

^{*3} Compatible with 4x speed recording

^{*4} Compatible with 8x speed recording.

^{*5} Compatible with 12x speed recording.

Note that actual copy speed varies with the part of the disc being recorded.

The table below shows 16x DVD-R and 6x DVD-RW disc brands that have been tested for high-speed writing compatibility with this recorder.

16x DVD-R ^{*1}		6x DVD-RW ^{*2}	
Maker	Manufacturer ID	Maker	Manufacturer ID
Sony	"SONY16D1"	JVC	"JVC1Victord7"
That's	"TYG03"	MCC (MKM)	"MKM01RW6x"
TDK	"TTH02"		
Maxell	"MXL RG04"		

^{*1} Compatible with 12x speed recording

^{*2} Compatible with 6x speed recording

Note

1. There may be cases where even 2x/4x/6x/8x/16x compatible discs do not copy at full speed. High speed copying is not possible when using discs initialized on another recorder.

Troubleshooting

Incorrect operation is often mistaken for trouble and malfunction. If you think there is something wrong with this component, please check the points below. Sometimes the trouble may lie in another component. Investigate the other components and electrical appliances being used. If the trouble cannot be rectified even after checking the points below, ask your nearest Pioneer authorized service center or your dealer to carry out repair work.

General

Problem	Remedy
The disc is automatically ejected after closing the disc tray	<ul style="list-style-type: none"> • Check that the disc is not a DVD+R/RW, DVD-RAM or other incompatible format disc (page 9). • Check that the disc is loaded properly (aligned in disc tray and label-side up). • Take out the disc and clean it (page 111). • Check that the disc has a region code compatible with the recorder (page 114).
No picture	<ul style="list-style-type: none"> • Check that everything is connected properly (page 12). • Check that the connected TV and/or the AV amp/receiver is set to the correct input. • The recorder may be set to progressive scan with an incompatible TV. Reset to interlace by pressing and holding the front panel ■ button then pressing ▶.
Can't play a disc	<ul style="list-style-type: none"> • Check that the disc is a compatible format disc (page 9). • Take out the disc and clean it (page 111). • Check that the disc is loaded properly (aligned in disc tray and label-side up). • There may be condensation in the recorder. Leave the recorder for an hour or so for the condensation to evaporate. • During HDD recording, you can't play discs that are recorded with a Line System different to the current recorder setting.
Can't record a disc	<ul style="list-style-type: none"> • Check that the disc is not a DVD+R/RW, DVD-RAM or other incompatible format disc (page 9).
All settings are reset	<ul style="list-style-type: none"> • If the recorder is unplugged (or there is a power failure) while the recorder is on, all the settings will be lost. • Make sure that you switch the recorder into standby before unplugging the power cord.
Remote control does not work	<ul style="list-style-type: none"> • If you connected this recorder to another Pioneer product using the CONTROL IN jack, point the remote control at the other component to use (page 12). • Set the remote control to the same ID number as the recorder (page 98). (When the batteries run down, the remote mode is automatically reset to Recorder1.) • Use the remote within its operating range (page 8). • Replace the batteries (page 8).
No sound or sound is distorted	<ul style="list-style-type: none"> • Make sure that the amp/receiver or TV is set to the correct input and the volume turned up. • There is no sound when the picture is paused, or during scanning or slow motion play. Press ▶ to resume regular playback. • DTS discs can only be played if this recorder is connected to a DTS decoder or DTS compatible amp/receiver. If you have connected a suitable decoder, also make sure that the Initial Setup > Audio Out > DTS Out setting is On. • Some 96kHz discs do not output audio through the digital jack. In this case, switch the input of your amp/receiver to analog. • Check the audio cable connections (page 12). • If the sound is distorted, try cleaning the cable plugs.

Problem	Remedy
The picture from the external input is distorted	<ul style="list-style-type: none"> If the video signal from the external component is copy-protected, you cannot connect via this recorder. Connect the component directly to your TV.
The picture is distorted	<ul style="list-style-type: none"> Change the Input Line System setting (page 99). (You can also change it by pressing the ■ button and ▲ OPEN/CLOSE on the front panel simultaneously with the recorder stopped.)
Screen is stretched vertically or horizontally	<ul style="list-style-type: none"> Make sure that the TV Screen Size setting (page 97) is correct for the kind of TV you have (see also page 101). If you have a widescreen TV, check its aspect ratio settings. This recorder's input switches into wide mode automatically according to the input signal. When the unit connected is not compatible with VIDEO ID-1 (widescreen signalling), set the connected component to output 4:3 aspect ratio (standard) video.
Can't play a disc recorded using this recorder on another player	<ul style="list-style-type: none"> If the disc was recorded in Video mode, make sure that it's finalized (page 51). Some players will not play recordable DVD discs, even when recorded in Video mode and finalized. If the disc was recorded in VR mode, the other player must be specifically RW compatible in order to play it (page 9). Discs recorded with copy-once material cannot be played on non-CPRM compatible players (page 38).
During playback the picture is dark or distorted	<ul style="list-style-type: none"> When a copy-protected disc is played via a VCR, the picture will not display correctly. Connect the recorder directly to your TV.
Can't record or does not record successfully	<ul style="list-style-type: none"> Check that there is some remaining blank space on the DVD/HDD. For a Video mode disc, check that the disc isn't already finalized. The HDD may contain up to 999 titles; one DVD disc 99 (Original) titles and 999 chapters (VR mode), or 99 chapters (Video mode). Check that these limits have not been reached. Check that the source you are trying to record is not copy protected. For a VR formatted disc, check that the disc isn't locked (page 87). Check that you are recording with the same TV system (PAL, NTSC, etc.) as the disc has already been recorded in. All recordings on a disc must be in the same TV system. When recording to the HDD, it is also necessary to set the Input Line System setting to match what you want to record (page 99). The power may have failed during recording.
Timer program doesn't record successfully	<ul style="list-style-type: none"> When setting the recording channel, make sure you set the recorder's built-in TV tuner, not the TV's built-in tuner. When recording to a Video mode disc, programs that are copy-once protected cannot be recorded. Use a VR mode formatted disc for copy-once material (page 38). Two timer programs may have overlapped, in which case only the earlier one will record completely. The power may have failed during recording.
After briefly unplugging or after a power failure the front panel display shows '---:--'	<ul style="list-style-type: none"> A backup battery inside the recorder keeps the clock and other settings from being reset when there is no power to the recorder. This battery should last approximately five years from factory shipping. Reset the clock and other recorder settings to use the recorder again. To have the battery replaced, contact your dealer or a Pioneer Service Center.
Front panel display shows 'LOCK' when a button is pressed	<ul style="list-style-type: none"> The Child Lock is on; turn off in order to use the recorder (page 47).

Problem	Remedy
Can't use One Touch Copy (HDD to DVD)	<ul style="list-style-type: none"> • Make sure that there is a recordable DVD loaded with some free space for recording and fewer than 99 titles already on the disc. Also make sure that for a Video mode disc, the disc isn't finalized. • If the title currently playing contains material that is copy-once protected, One Touch Copy will not work. • If the currently playing HDD content was recorded in XP+ mode, the One Touch Copy feature can't be used. • One Touch Copy doesn't work if the recorder is already recording to DVD.
Can't use One Touch Copy (DVD to HDD)	<ul style="list-style-type: none"> • Make sure that there is space available on the HDD and that there are fewer than 999 titles on the HDD. • One Touch Copy doesn't work if the recorder is already recording to the HDD.
The picture freezes and the front panel and remote control buttons stop working	<ul style="list-style-type: none"> • Press ■ then try restarting playback. • Press the front panel ⏻ STANDBY/ON button to switch the power off, then switch back on and restart playback. If the power fails to switch off, press and hold ⏻ STANDBY/ON for 10 seconds until the power switches off.

If the unit does not operate normally due to external effects such as static electricity, disconnect the power plug from the outlet and insert again to return to normal operating conditions.

Frequently asked questions

In this section you can find answers to frequently asked questions on how to use your DVD recorder and what it can do.

- *How do I make a high-quality copy?*

We recommend that you use the high-speed copy mode. Although the copy is faster than real time, there is no loss of picture or sound quality compared to the original.

If there is not enough space on the disc to make a copy at the same picture quality as the original, we recommend that you change the recording mode to 'Optimized'. This will fit the recording on to the available space on the disc.

See also *Copying and back-up* on page 63.

- *Can I make a DVD copy of, say, a movie that has had the commercials edited out?*

Yes. There are two ways to do this. You can either edit the video on the HDD then copy the edited version to DVD, or you can assemble a Copy List that cuts out the commercials, then record that to DVD.

See also *Copying and back-up* on page 63.

- *I have a two-hour recording on the HDD made in XP mode. Can I copy this to DVD in high-speed mode?*

A standard DVD disc can hold only an hour of XP mode material, so you wouldn't be able to make a high-speed copy of this on to one disc. You could divide up the recording on the HDD into two titles of an hour each and copy these to two DVDs (using

high-speed copy). Alternatively, you could copy the material in **SP** (or Optimized) mode so as to fit it all on to one disc (note that there will be a loss in picture quality if you do this).

See also *Copying and back-up* on page 63.

- *Can I record a bilingual broadcast to the HDD, keeping both audio channels and switch them on playback?*

Yes. When HDD Recording Format is set to Video Mode Off (see *HDD Recording Format* on page 97), both channels of the broadcast are recorded (unless you set the recording mode to LPCM, in which case only the channel set using the Bilingual Recording setting will be recorded; see *Using the built-in TV tuner* on page 29).

- *Can I record continuously on the HDD for more than 12 hours?*

Yes, timer recordings made to the HDD can be set for up to 24 hours. However, because the maximum length of a title is 12 hours, the recording will be spread over two titles. Note that there will be a short break in the recording between titles.

See also *Setting a timer recording* on page 41.

- *Can I copy a finalized Video mode disc (DVD-R or DVD-RW) to the HDD?*

Yes. Start playing the Video mode disc and use the One Touch Copy button to copy the currently playing title to the HDD. Repeat for as many titles on the disc as you want to copy.

See also *Copying from DVD to HDD* on page 67.

- *Can I use high-speed copy to copy from DVD to HDD?*

You can only use high-speed copy from DVD to HDD when copying Original titles from a VR mode DVD-R or DVD-RW disc.

See also *Copying from DVD to HDD* on page 67.

- *Can I copy a copy-once protected program from a subscription satellite or cable channel to a DVD from the HDD?*

Yes, you can use high-speed copy to copy to a VR mode disc. You can also divide the recording on the HDD into a number of smaller titles if the whole recording won't fit on to one disc.

See also *Copying from HDD to DVD* on page 64.

- *Can I play a DVD I recorded on this recorder on another DVD player?*

Yes, you can generally play finalized Video mode discs recorded on this recorder on any standard DVD player. You may find, however, that some players will not play some recordable media.

For VR mode DVD-RW discs, look for the 'RW Compatible' mark to see if it will play the disc.

About DV

Using DV, also known as i.LINK, you can connect a DV-equipped camcorder to this recorder using a single DV cable for input of audio, video, data and control signals.

The i.LINK interface is also known as IEEE 1394-1995. "i.LINK" and the "i.LINK" logo are trademarks.

- This recorder is only compatible with DV-format (DVC-SD) camcorders. Digital satellite receivers and Digital VHS video recorders are not compatible.
- You cannot connect more than one DV camcorder at a time to this recorder.
- You cannot control this recorder from external equipment connected via the **DV IN** jack.
- It may not always be possible to control the connected camcorder via the **DV IN** jack.
- Digital camcorders can usually record audio as stereo 16-bit/48kHz, or twin stereo tracks of 12-bit/32kHz. This recorder can only record one stereo audio track. Set the **DV Input** setting as required (see *DV Input* on page 95).
- Audio input to the **DV IN** jack should be 32 or 48kHz (not 44.1kHz).

- Picture disturbance in the recording may occur if the source component pauses playback or plays an unrecorded section of tape, or if the power fails in the source component, or the DV cable becomes disconnected.

- The **DV IN** jack is an input only. There is no output functionality.

DV-related messages

You may see the following messages appear on your TV screen when using the **DV IN** jack.

- **No DV camcorder connected.** – The camcorder is not connected properly, or the camcorder is switched off.
- **The DV camcorder is recording.** – The camcorder is recording, so you cannot start recording from the camcorder to this recorder.
- **You cannot connect more than one DV camcorder at the same time.** – The DV jack on this recorder supports connection to just one camcorder.
- **No tape in the DV camcorder.** – There is no cassette loaded into the connected equipment.
- **The DV camcorder is in record-pause mode.** – The camcorder is in record-pause mode.
- **DV camcorder playback canceled. Recording has been paused.** – Recording was paused because the camcorder is not in playback mode.
- **Cannot operate the DV camcorder.** – This recorder cannot control the camcorder. Try switching off the camcorder then switching it back on.
- **Could not operate the DV camcorder.** – This recorder was not able to control the camcorder.
- **Recording has stopped because the recorded material on the tape finished.** – When the recorded part of the DV tape comes to an end, this recorder automatically stops recording.
- **Recording has stopped because DV camcorder playback stopped.** – Recording stopped because DV camcorder playback was stopped or the camcorder was disconnected.
- **The DV camcorder is not set for playback. Please select playback mode on the DV camcorder.** – The camcorder is in camera mode.

Manual recording modes

The table below shows the approximate recording times for a VR mode and Video mode DVD in each manual recording mode, as well as the standard recording mode equivalents. Levels separated by a bold line show where there is a noticeable change in picture quality.

Audio recording in all manual recording modes is in Dolby Digital 2ch format, except for LPCM mode, which is in Linear PCM format.

Video mode Off (HDD) VR mode (DVD)				Video mode On (HDD) Video mode (DVD)		
Resolution*	Level	Rec. time		Level	Rec. time	Resolution*
352 x 240 / 352 x 288	MN 1	802 mins.		MN 1	802 mins.	352 x 240 / 352 x 288
	MN 2	720 mins.		MN 2	720 mins.	
	MN 3	600 mins.	SEP	MN 3	600 mins.	
	MN 4	480 mins.	SLP	MN 4	480 mins.	
	MN 5	420 mins.		MN 5	420 mins.	
	MN 6	360 mins.	EP	MN 6	360 mins.	
352 x 480 / 352 x 576	MN 7	300 mins.		MN 7	300 mins.	352 x 480 / 352 x 576
	MN 8	270 mins.		MN 8	270 mins.	
480 x 480 / 480 x 576	MN 9	240 mins.	LP	MN 9	240 mins.	352 x 480 / 352 x 576
	MN 10	230 mins.		MN 10	230 mins.	
	MN 11	220 mins.		MN 11	220 mins.	
544 x 480 / 544 x 576	MN 12	210 mins.		MN 12	210 mins.	
	MN 13	200 mins.		MN 13	200 mins.	
	MN 14	190 mins.		MN 14	190 mins.	
	MN 15	180 mins.		MN 15	180 mins.	
	MN 16	170 mins.		MN 16	170 mins.	
720 x 480 / 720 x 576	MN 17	160 mins.		MN 17	160 mins.	720 x 480 / 720 x 576
	MN 18	150 mins.		MN 18	150 mins.	
	MN 19	140 mins.		MN 19	140 mins.	
	MN 20	130 mins.		MN 20	130 mins.	
	MN 21	120 mins.	SP	MN 21	120 mins.	
	MN 22	110 mins.		MN 22	110 mins.	
	MN 23	105 mins.		MN 23	105 mins.	
	MN 24	100 mins.		MN 24	100 mins.	
	MN 25	95 mins.		MN 25	95 mins.	
	MN 26	90 mins.		MN 26	90 mins.	
	MN 27	85 mins.		MN 27	85 mins.	
	MN 28	80 mins.		MN 28	80 mins.	
	MN 29	75 mins.		MN 29	75 mins.	
	MN 30	70 mins.		MN 30	70 mins.	
MN 31	65 mins.		MN 31	65 mins.		
MN 32	61 mins.	XP	MN 32	61 mins.		
LPCM	61 mins.		LPCM	61 mins.		
XP+**	41 mins.		XP+**	41 mins.		

* The first figure refers to when the Input Line System is set to 525 System; the second when set to 625 System.

** XP+ mode is available for HDD recording only. If set for a DVD recording, the DVD will be recorded in MN32 mode.

When recording to the HDD, recording for the times given will use approximately 4.7 GB of HDD space (equivalent to one recordable DVD).

See also *Recording* on page 37.

Language code list

Language (Language code letter), **Language code**

Japanese (ja), 1001	Bhutani (dz), 0426	Kirghiz (ky), 1125	Sinhalese (si), 1909
English (en), 0514	Esperanto (eo), 0515	Latin (la), 1201	Slovak (sk), 1911
French (fr), 0618	Estonian (et), 0520	Lingala (ln), 1214	Slovenian (sl), 1912
German (de), 0405	Basque (eu), 0521	Laothian (lo), 1215	Samoa (sm), 1913
Italian (it), 0920	Persian (fa), 0601	Lithuanian (lt), 1220	Shona (sn), 1914
Spanish (es), 0519	Finnish (fi), 0609	Latvian (lv), 1222	Somali (so), 1915
Chinese (zh), 2608	Fiji (fj), 0610	Malagasy (mg), 1307	Albanian (sq), 1917
Dutch (nl), 1412	Faroese (fo), 0615	Maori (mi), 1309	Serbian (sr), 1918
Portuguese (pt), 1620	Frisian (fy), 0625	Macedonian (mk), 1311	Siswati (ss), 1919
Swedish (sv), 1922	Irish (ga), 0701	Malayalam (ml), 1312	Sesotho (st), 1920
Russian (ru), 1821	Scots-Gaelic (gd), 0704	Mongolian (mn), 1314	Sundanese (su), 1921
Korean (ko), 1115	Galician (gl), 0712	Moldavian (mo), 1315	Swahili (sw), 1923
Greek (el), 0512	Guarani (gn), 0714	Marathi (mr), 1318	Tamil (ta), 2001
Afar (aa), 0101	Gujarati (gu), 0721	Malay (ms), 1319	Telugu (te), 2005
Abkhazian (ab), 0102	Hausa (ha), 0801	Maltese (mt), 1320	Tajik (tg), 2007
Afrikaans (af), 0106	Hindi (hi), 0809	Burmese (my), 1325	Thai (th), 2008
Amharic (am), 0113	Croatian (hr), 0818	Nauru (na), 1401	Tigrinya (ti), 2009
Arabic (ar), 0118	Hungarian (hu), 0821	Nepali (ne), 1405	Turkmen (tk), 2011
Assamese (as), 0119	Armenian (hy), 0825	Norwegian (no), 1415	Tagalog (tl), 2012
Aymara (ay), 0125	Interlingua (ia), 0901	Occitan (oc), 1503	Setswana (tn), 2014
Azerbaijani (az), 0126	Interlingue (ie), 0905	Oromo (om), 1513	Tonga (to), 2015
Bashkir (ba), 0201	Inupiak (ik), 0911	Oriya (or), 1518	Turkish (tr), 2018
Byelorussian (be), 0205	Indonesian (in), 0914	Panjabi (pa), 1601	Tsonga (ts), 2019
Bulgarian (bg), 0207	Icelandic (is), 0919	Polish (pl), 1612	Tatar (tt), 2020
Bihari (bh), 0208	Hebrew (iw), 0923	Pashto, Pushto (ps), 1619	Twi (tw), 2023
Bislama (bi), 0209	Yiddish (ji), 1009	Quechua (qu), 1721	Ukrainian (uk), 2111
Bengali (bn), 0214	Javanese (jw), 1023	Rhaeto-Romance (rm), 1813	Urdu (ur), 2118
Tibetan (bo), 0215	Georgian (ka), 1101	Kirundi (rn), 1814	Uzbek (uz), 2126
Breton (br), 0218	Kazakh (kk), 1111	Romanian (ro), 1815	Vietnamese (vi), 2209
Catalan (ca), 0301	Greenlandic (kl), 1112	Kinyarwanda (rw), 1823	Volapük (vo), 2215
Corsican (co), 0315	Cambodian (km), 1113	Sanskrit (sa), 1901	Wolof (wo), 2315
Czech (cs), 0319	Kannada (kn), 1114	Sindhi (sd), 1904	Xhosa (xh), 2408
Welsh (cy), 0325	Kashmiri (ks), 1119	Sangho (sg), 1907	Yoruba (yo), 2515
Danish (da), 0401	Kurdish (ku), 1121	Serbo-Croatian (sh), 1908	Zulu (zu), 2621

Country/Area code list

Country/Area, **Country/Area code**, **Code letter**

Argentina, 0118, ar	Finland, 0609, fi	Malaysia, 1325, my	Singapore, 1907, sg
Australia, 0121, au	France, 0618, fr	Mexico, 1324, mx	Spain, 0519, es
Austria, 0120, at	Germany, 0405, de	Netherlands, 1412, nl	Sweden, 1905, se
Belgium, 0205, be	Hong Kong, 0811, hk	New Zealand, 1426, nz	Switzerland, 0308, ch
Brazil, 0218, br	India, 0914, in	Norway, 1415, no	Taiwan, 2023, tw
Canada, 0301, ca	Indonesia, 0904, id	Pakistan, 1611, pk	Thailand, 2008, th
Chile, 0312, cl	Italy, 0920, it	Philippines, 1608, ph	United Kingdom, 0702, gb
China, 0314, cn	Japan, 1016, jp	Portugal, 1620, pt	USA, 2119, us
Denmark, 0411, dk	Korea, Republic of, 1118, kr	Russian Federation, 1821, ru	

On-screen displays and recorder displays

The table below shows a list of error messages that you may encounter when using the recorder and an explanation of their meaning.

Message	Explanation/Action
<ul style="list-style-type: none"> • Initializing disc. Please wait a moment. 	When you load a blank DVD-RW disc, the recorder automatically initializes it.
<ul style="list-style-type: none"> • Incompatible region number. 	The disc loaded has an incompatible region number for the recorder and so will not play.
<ul style="list-style-type: none"> • Cannot record any more titles. • No more space for file management data. • Cannot add any more chapter marks. 	The disc control data limit has been reached, or the maximum number of chapters and/or titles has been reached. Erase titles/chapters or combine chapters.
<ul style="list-style-type: none"> • This disc cannot be recorded. Undo the finalization. 	The disc was finalized on a non-Pioneer DVD recorder. Undo the finalization in order to recording/editing.
<ul style="list-style-type: none"> • Cannot play this disc. • This disc cannot be recorded. • Cannot read the CPRM information. • Could not record the information to the disc. • Cannot edit. • Could not initialize disc. • Could not complete finalization successfully. • Could not undo finalization successfully. • Could not successfully unlock the disc. 	The disc may be dirty or damaged. Take out the disc, clean it and retry. If the error persists, use a new disc. If the error appears even with a new disc, please consult a Pioneer Service Center.
<ul style="list-style-type: none"> • Incompatible or unreadable disc. 	The disc loaded is a DVD+R/RW, DVD-RAM or some other incompatible disc type. This display may also appear if the disc is dirty or damaged.
<ul style="list-style-type: none"> • Cannot record to a disc that is not CPRM compatible. • Cannot record this content using Video mode recording. 	The video source is copy-once protected. Use a VR mode DVD-R/RW disc with CPRM for recording.
<ul style="list-style-type: none"> • This content is copy protected. 	The video source is copy-protected and cannot be recorded.
<ul style="list-style-type: none"> • Incorrect CPRM information. 	The recorder could not read the CPRM information. The recorder may be damaged—please consult a Pioneer Service Center.
<ul style="list-style-type: none"> • The audio will conform to the [Bilingual Recording] setting. 	When recording from an external input in Video mode (DVD), Video Mode On (HDD), or in LPCM mode, you can only record the left or right channel; not both.
<ul style="list-style-type: none"> • Repairing disc. 	During recording, the power was cut. This display appears when the power is restored.
<ul style="list-style-type: none"> • Could not repair the disc. 	The recorder was unable to repair the disc after a power cut. The contents of the recording will be lost.
<ul style="list-style-type: none"> • Overheating has stopped operation. Press DISPLAY to clear this message. 	The internal temperature of the recorder has exceeded the operating limit. If this message reappears, please contact a Pioneer authorized service center.

Message	Explanation/Action
<ul style="list-style-type: none"> • There is no DV input or the input signal is unrecordable. • Cannot preview because there is no DV input or the input signal is unrecordable. 	No signal was detected at the DV IN jack. This may appear if a blank section of DV tape is playing in the connected camcorder.
<ul style="list-style-type: none"> • HDD optimization is recommended. This can be done using Disc Setup. 	The HDD should be optimized (basically, HDD housekeeping) to maintain playback and recording performance.
<ul style="list-style-type: none"> • Please perform HDD optimization. This can be done using Disc Setup. 	The HDD is in more urgent need of optimization in order to maintain performance.
<ul style="list-style-type: none"> • The HDD has not been sufficiently optimized. Please optimize again. 	If this message appears repeatedly after optimizing the HDD it is likely that there is not enough free space on the HDD for optimization to complete properly. Please erase some titles from the HDD and optimize again.
<ul style="list-style-type: none"> • This channel's TV system is different from the recorder's setting. 	The TV system (PAL, NTSC, etc.) of the current channel is different from the TV system settings of this recorder.
<ul style="list-style-type: none"> • Recording failed due to a TV system mismatch. Press DISPLAY to clear message. 	The timer recording failed because the TV system of the channel set for recording was different from the setting of the recorder.
<ul style="list-style-type: none"> • Playback has stopped because the TV system is different than the recording. 	During recording or timer recording standby, the TV System (PAL, NTSC, etc.) of the playback video changed, causing playback to stop automatically.

Resetting the recorder

If you need to, you can reset the recorder to all its factory settings.

- 1 **Make sure that the recorder is on.**
- 2 **Press and hold ■ and press ⏻ STANDBY/ON.**
The recorder turns off with all settings reset.

Handling discs

When holding discs of any type, take care not to leave fingerprints, dirt or scratches on the disc surface. Hold the disc by its edge or by the center hole and edge.

Damaged or dirty discs can affect playback and recording performance. Take care also not to scratch the label side of the disc. Although not as fragile as the recorded side, scratches can still result in a disc becoming unusable.

Should a disc become marked with fingerprints, dust, etc., clean using a soft, dry cloth, wiping the disc lightly from the center to the outside edge. Do not wipe with a circular motion.



If necessary, use a cloth soaked in alcohol, or a commercially available CD/DVD cleaning kit to clean a disc more thoroughly. Never use benzine, thinner or other cleaning agents, including products designed for cleaning vinyl records.

Storing discs

Although CDs and DVD discs are more durable than vinyl records, you should still take care to handle and store discs correctly. When you're not using a disc, return it to its case and store upright. Avoid leaving discs in excessively cold, humid, or hot environments (including under direct sunlight).

Don't glue paper or put stickers onto the disc, or use a pencil, ball-point pen or other sharp-tipped writing instrument. These could all damage the disc.



For more detailed care information see the instructions that come with discs.

Do not load more than one disc into the recorder.

Damaged discs

Discs spin at high speed inside the recorder. If you can see that a disc is cracked, chipped, warped, or otherwise damaged, don't risk using it; you could end up damaging the recorder.

This recorder is designed for use with conventional, fully circular discs only. Use of shaped discs is not recommended for this product. Pioneer disclaims all liability arising in connection with the use of shaped discs.

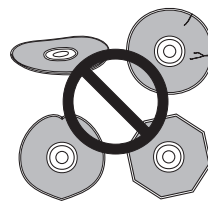

Cleaning the pickup lens

The DVD recorder's lens should not become dirty in normal use, but if for some reason it should malfunction due to dust or dirt, consult your nearest Pioneer-authorized service center. Although lens cleaners are commercially available, we do not recommend using them since some may damage the lens.

Condensation

Condensation may form inside the recorder if it is brought into a warm room from outside, or if the temperature of the room rises quickly. Although the condensation won't damage the recorder, it may temporarily impair its performance. For this reason you should leave it to adjust to the warmer temperature for about an hour before switching on and using.

Hints on installation

We want you to enjoy using this unit for years to come, so please bear in mind the following points when choosing a suitable location for it:

Do...

- ✓ Use in a well-ventilated room.
- ✓ Place on a solid, flat, level surface, such as a table, shelf or stereo rack.

Don't...

- ✗ Use in a place exposed to high temperatures or humidity, including near radiators and other heat-generating appliances.
- ✗ Place on a window sill or other place where the recorder will be exposed to direct sunlight.
- ✗ Use in a dusty or damp environment or in a room where it will be exposed to excessive cigarette smoke.
- ✗ Place directly on top of an amplifier, or other component in your stereo system that becomes hot in use.
- ✗ Use near a television or monitor as you may experience interference—especially if the television uses an indoor antenna.
- ✗ Use in a kitchen or other room where the recorder may be exposed to smoke or steam.
- ✗ Use on a thick rug or carpet, or cover with cloth—this may prevent proper cooling of the unit.
- ✗ Place on an unstable surface, or one that is not large enough to support all four of the unit's feet.

Moving the recorder

If you need to move the recorder, first remove the disc, if there's one loaded, and close the disc tray. Next, press **⏻** **STANDBY/ON** to switch the power to standby, checking that the **POWER OFF** indication in the display goes off. Wait at least two minutes. Lastly, disconnect the power cord. Never lift or move the unit during playback or recording—discs rotate at a high speed and may be damaged.

Glossary

Analog audio

An electrical signal that directly represents sound. Compare this to digital audio which can be an electrical signal, but is an indirect representation of sound. See also *Digital audio*.

Aspect ratio

The width of a TV screen relative to its height. Conventional TVs are 4:3 (in other words, the screen is almost square); widescreen models are 16:9 (the screen is almost twice as wide as it is high).

Chapter

Just as a book is split up into several chapters, a title on the HDD/a DVD disc is usually divided into chapters. See also *Title*.

Digital audio

An indirect representation of sound by numbers. During recording, the sound is measured at discrete intervals (44,100 times a second for CD audio) by an analog-to-digital converter, generating a stream of numbers. On playback, a digital-to-analog converter generates an analog signal based on these numbers. See also *Sampling frequency* and *Analog audio*.

Dolby Digital



Dolby® Digital Stereo Creator enables consumers to create stereo DVD-Videos with stunning Dolby Digital sound tracks at home. The technology, when utilized instead of PCM recording, also saves recordable disc space, allowing for higher video resolution or extended recording time on each DVD. DVDs mastered using Dolby Digital Stereo Creator will play back on all DVD-Video players.

Manufactured under license from Dolby Laboratories. "Dolby" and the double-D symbol are trademarks of Dolby Laboratories.

DRM (Digital Rights Management)

DRM (Digital Rights Management) copy protection is a technology designed to prevent unauthorized copying by restricting playback, etc. of material on devices other than the PC (or other WMA recording equipment) used to record it. For detailed information, please see the instruction manuals or help files that came with your PC (or other WMA recording equipment) and/or software.

DTS



DTS stands for Digital Theater System. DTS is a surround system different from Dolby Digital that has become a popular surround sound format for movies.

"DTS" and "DTS Digital Out" are registered trademarks of Digital Theater Systems, Inc.

Dynamic range

The difference between the quietest and loudest sounds possible in an audio signal (without distorting or getting lost in noise). Dolby Digital and DTS soundtracks are capable of a wide dynamic range, delivering dramatic cinema-like effects.

EXIF (Exchangeable Image File)

A file format developed by Fuji Photo Film for digital still cameras. Digital cameras from various manufacturers use this compressed file format which carries date, time and thumbnail information, as well as the picture data.

File extension

A tag added to the end of a filename to indicate the type of file. For example, ".mp3" indicates an MP3 file.

ISO 9660 format

International standard for the volume and file structure of CD-ROM discs.

JPEG

A file format used for still images, such as photographs and illustrations. JPEG files are identified by the file extension ".jpg" or ".JPG". Most digital cameras use this format.

MP3

MP3 (MPEG1 audio layer 3) is a compressed audio file format. Files are recognized by their file extension ".mp3" or ".MP3".

MPEG audio**MPEG) (Multichannel**

An audio format used on Video CDs and some DVD discs. This unit can convert MPEG audio to PCM format for wider compatibility with digital recorders and AV amp/receivers. See also *PCM*.

MPEG video

The video format used for Video CDs and DVDs. Video CD uses the older MPEG-1 standard, while DVD uses the newer and much better quality MPEG-2 standard.

Optical digital output

A jack that outputs digital audio in the form of light pulses. Connect components with optical digital jacks using a special optical cord, available from specialist audio dealers.

PCM (Pulse Code Modulation)

The most common system of encoding digital audio, found on CDs and DAT. Excellent quality, but requires a lot of data compared to formats such as Dolby Digital and MPEG audio. For compatibility with digital audio recorders (CD, MD and DAT) and AV amp/receivers with digital inputs, this unit can convert Dolby Digital and MPEG audio to PCM. See also *Digital audio*.

PBC (PlayBack Control) (Video CD/Super VCD only)

A system of navigating a Video CD/Super VCD through on-screen menus recorded onto the disc. Especially good for discs that you would normally not watch from beginning to end all at once—karaoke discs, for example.

Regions (DVD-Video only)

(example region code marks)

Regions associate discs and players with particular areas of the world. This unit will only play discs that have compatible region codes. You can find the region code of your unit by looking on the rear panel. Some discs are compatible with more than one region (or all regions).

Sampling frequency

The rate at which sound is measured to be turned into digital audio data. The higher the rate, the better the sound quality, but the more digital information is generated. Standard CD audio has a sampling frequency of 44.1kHz, which means 44,100 samples (measurements) per second. See also *Digital audio*.

Title

A collection of chapters on a the HDD/DVD disc. See also *Chapter*.

Track

Audio CDs and Video CDs use tracks to divide up the content of a disc. The DVD equivalent is called a chapter. See also *Chapter*.

WMA

WMA is short for Windows Media Audio and refers to an audio compression technology developed by Microsoft Corporation. WMA data can be encoded by using Windows Media Player version 9 or 10, or Windows Media Player for Windows XP. Files are recognized by their file extension ".wma" or ".WMA".

Microsoft, Windows Media, and the Windows logo are trademarks, or registered trademarks of Microsoft Corporation in the United States and/or other countries.

Specifications

General

System	HDD, DVD-Video, DVD-R/RW, Video-CD, Super VCD, CD, CD-R/RW (WMA, MP3, JPEG, CD-DA)
Power requirements	220–240 V, 50/60 Hz
Power consumption	46 W
Power consumption in standby mode	0.93 W (Front panel display: off)
Weight	4.0 kg
Dimensions	420 (W) x 59 (H) x 273 (D) mm
Operating temperature	+5°C to +35°C
Operating humidity	.5% to 85% (no condensation)
TV system	PAL/SECAM/NTSC (external input only)

Recording

Recording format	DVD Video Recording DVD-VIDEO
------------------	----------------------------------

Recordable discs

DVD-RW (DVD Re-recordable disc)
DVD-R (DVD Recordable disc)

Video recording format

Sampling frequency	13.5MHz
Compression format	MPEG

Audio recording format

Sampling frequency	48kHz
Compression format	Dolby Digital or Linear PCM (uncompressed)

Recording time

HDD (80GB)

XP+	Approx. 11 hours
Fine (XP)	Approx. 17 hours
Standard Play (SP)	Approx. 34 hours
Long Play (LP)	Approx. 68 hours
Extended Play (EP)	Approx. 102 hours
Super Long Play (SLP)	Approx. 136 hours
Super Extended Play (SEP)	Approx. 170 hours
Manual Mode (MN)	Approx. 17–227 hours

DVD-R/DVD-RW

Fine (XP)	Approx. 1 hour
Standard Play (SP)	Approx. 2 hours
Long Play (LP)	Approx. 4 hours
Extended Play (EP)	Approx. 6 hours
Super Long Play (SLP)	Approx. 8 hours
Super Extended Play (SEP)	Approx. 10 hours
Manual Mode (MN)	Approx. 1–13 hours

Tuner

Receiveable channels

	SECAM B/G PAL B/G		PAL I	
	Frequency	Channel	Frequency	Channel
VHF (low)	47 - 89 MHz	E2 - E4 X - Z	44 - 89 MHz	A - C X - Z
VHF (high)	104 - 300 MHz	E5 - E12 S1 - S20 M1 - M10 U1 - U10	104 - 300 MHz	D - J 11, 13 S1 - S20
Hyper	302 - 470 MHz	S21 - S41	302 - 470 MHz	S21 - S41
UHF	470 - 862 MHz	E21 - E69	470 - 862 MHz	E21 - E69

	SECAM L		SECAM D/K PAL D/K	
	Frequency	Channel	Frequency	Channel
VHF (low)	49 - 65 MHz	FB, FC1, FC	49 - 94 MHz	R1 - R5
VHF (high)	104 - 300 MHz	F1 - F6 B - Q	104 - 300 MHz	R6 - R12 S1 - S20
Hyper	300 - 470 MHz	S21 - S41	302 - 470 MHz	S21 - S41
UHF	470 - 862 MHz	21 - 69	470 - 862 MHz	E21 - E69

STEREO
B/G - A2
I - NICAM
L - NICAM
B/G - NICAM
D/K - NICAM

Timer

Programs	1 month/32 programs
Clock	Quartz lock (24-hour digital display)
Power off memory	Approx. 5 years (after manufacture)

Input/Output

VHF/UHF antenna input/output terminal	VHF/UHF set 75 Ω (IEC connector)
Video input	Input 1,3 (rear), 2 (front)
Input level	1 Vp-p (75 Ω)
Jacks	AV connector 2 (Input 1), RCA jack (Input 2, 3)
Video output	AV1, Output
Output level	1 Vp-p (75 Ω)
Jacks	AV connector (AV1) RCA jack (Output)
S-Video input	Input 1, 3 (rear), 2 (front)
Y (luminance) - Input level	1 Vp-p (75 Ω)
C (colour) - Input level	300 mVp-p (75 Ω)
Jacks	AV connector 2 (Input 1), 4 pin mini DIN (Input 2, 3)
S-Video output	AV1, Output
Y (luminance) - Output level	1 Vp-p (75 Ω)
C (colour) - Output level	300 mVp-p (75 Ω)
Jacks	AV connector 1 (AV1), 4 pin mini DIN (Output)

Component video output	
Output level	Y: 1.0 Vp-p (75 Ω) P _B , P _R : 0.7 Vp-p (75 Ω)
Jacks	RCA jacks
RGB input	
Input level	0.7 Vp-p (75 Ω)
Jacks	AV connector 2 (Input 1)
RGB output	
Output level	0.7 Vp-p (75 Ω)
Jacks	AV connector 1 (AV1)
Audio input	
Input level	Input 1, 3 (rear), 2 (front) L/R
During audio input	.2V rms (Input impedance: more than 22 k Ω)
Jacks	AV connector 2 (Input 1), RCA jacks (Input 2, 3)
Audio output	
During audio output	AV1, Output .2V rms (Output impedance: less than 1.5 k Ω)
Jacks	AV connector 1 (AV1), RCA jacks (Output)
Control input	Mini jack
DV input	.4 pin (front) (i.LINK/IEEE 1394 standard)

AV Connectors (21-pin connector assignment)

AV connector input/output 21-pin connector
This connector provides the video and audio signals for connection to a compatible colour TV or monitor.

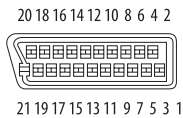

PIN no.	AV1(RGB)-TV / AV2(INPUT 1)
1	Audio 2/R out / Audio 2/R out
2	- / Audio 2/R in
11	G out / G in
3	Audio 1/L out / Audio 1/L out
6	- / Audio 1/L in
15	R or C out / R or C in
4	GND
17	GND
7	B out / B in
19	Video out or Y out / Video out
20	- / Video in or Y in
8	Status
21	GND

Supplied accessories

Remote control	1
Dry cell batteries (AA/R6P)	2
Audio / Video cable (red/white/yellow)	1
RF antenna cable	1
Power cable	1
Operating Instructions	
Warranty card	1

Note: The specifications and design of this product are subject to change without notice, due to improvement.

Index

A

Audio

- digital output settings **95**
- DV audio settings **50**
- dynamic range control **91**
- external audio settings **94**
- input settings **94**
- setting preferences for audio language **96**
- switching on playback **61**
- switching TV audio **29**

Auto start recording **49**

Automatic channel setup **25**

AV amplifier, connecting to **19**

C

CD Audio

- compatibility **9**
- playback controls for **33, 55–61**

Chapter

- automatic chapter marking **97**
- definition **113**
- editing **69, 78**
- maximum number per title/disc **37**

Component video **15**

Copying

- from DVD to HDD **64, 67**
- from HDD to DVD **64–66, 102**
- high-speed **63, 70, 102**
- One Touch Copy **63**
- real-time **63, 70**
- restrictions and copyright **63**
- Video mode compatible and frame accurate **68, 69, 70**

D

Dolby Digital

- explained **113**
- output setting **95**

Downloading channel presets from the TV **13, 25**

DTS

- CD audio encoded with **33**
- explained **113**
- output setting **95**

DV camcorder

- error messages **106**
- recording from **50**

DVD

- activity display **35**
- aspect ratios **97, 101**
- backing up **71**
- compatibility **9, 37, 102**
- DVD-R vs DVD-RW **9, 10, 37, 102**
- finalizing **10, 51, 88**
- initializing **37, 87**
- playback controls for **32, 53–62**
- selecting for playback/recording **27**
- Video mode vs VR mode **9, 10, 37, 74, 87, 97**

E

Easy Timer Recording **42**

Editing **73–81**

- Video mode compatibility and frame accuracy **74, 97**
- Video mode vs VR mode **74**

H

HDD

- activity display **35**
- backing up content to DVD **71**
- disk space and recording quality **107**
- playback controls for **32**
- precautions **11**
- selecting for playback/recording **27**
- Video mode compatibility **37, 74, 97**

Home menu **34**

J

JPEG

- file compatibility **10**
- viewing in the PhotoViewer **85**

Jukebox **82**

L

Language

- audio **61, 96**
- code list **108**
- DVD menu **96**
- setting for menus and displays (OSD) **96**
- settings for DVD playback **96**
- subtitle **96**

M

MP3 audio files **9, 113**
MPEG audio **114**

N

NexTView **13**
NTSC **24**

O

Optimized recording **45**

P

Picture quality
 recording time vs **38, 107**
 setting for playback **90**
 setting for recording **89**
Play List
 compared to Original **11**
 creating on a VR mode disc **75**
 switching to Play List view **73**
Playback **29–33, 53–62**
 on-screen displays **36**
 parental lock for DVD-Video **98**
 picture quality settings for **90**
 settings **97**
Progressive scan video **27**

R

Recording **28, 37–52**
 audio format **38**
 automatic chapter marking **97**
 copyright and **38**
 from a camcorder **50**
 from an external input **48**
 on-screen displays **36**
 optimized **97**
 settings **97**
 simultaneous playback and **48**
 time and picture quality **38, 107**
 TV programs **28, 39**
 Video mode vs VR mode **37**
Recovery recording **41, 45**
Remote control
 buttons explained **22–23**
 changing the batteries **8**
 operating range **8**
 setting the remote ID **98**

S

Subtitles
 setting preferences for **96**
 switching during playback **60**

T

Timer recording **41–47**
Title
 defined **114**
 maximum number recordable **37**
 maximum recordable length **37**
 thumbnails **76, 97**
TV channels
 changing **29**
 manual setting **93**
 numbering **29**
 Recording - see Recording TV programs

V

Video CD
 compatibility **9**
 playback control (PBC) **33, 53**
 playback controls for **33, 55–61**
VIDEO Plus+® **43–44**

W

WMA audio files **9, 10, 114**

Published by Pioneer Corporation.
Copyright © 2005 Pioneer Corporation.
All rights reserved.

PIONEER CORPORATION

4-1, Meguro 1-Chome, Meguro-ku, Tokyo 153-8654, Japan

PIONEER ELECTRONICS (USA) INC.

P.O. BOX 1540, Long Beach, California 90810-1540, U.S.A. TEL: (800) 421-1404

PIONEER ELECTRONICS OF CANADA, INC.

300 Allstate Parkway, Markham, Ontario L3R OP2, Canada TEL: (905) 479-4411

PIONEER EUROPE NV

Haven 1087, Keetberglaan 1, B-9120 Melsele, Belgium TEL: 03/570.05.11

PIONEER ELECTRONICS ASIACENTRE PTE. LTD.

253 Alexandra Road, #04-01, Singapore 159936 TEL: 656-472-1111

PIONEER ELECTRONICS AUSTRALIA PTY. LTD.

178-184 Boundary Road, Braeside, Victoria 3195, Australia, TEL: (03) 9586-6300

PIONEER ELECTRONICS DE MEXICO S.A. DE C.V.

Bldv.Manuel Avila Camacho 138 10 piso Col.Lomas de Chapultepec, Mexico,D.F. 11000 TEL: 55-9178-4270

K002E

Free Manuals Download Website

<http://myh66.com>

<http://usermanuals.us>

<http://www.somanuals.com>

<http://www.4manuals.cc>

<http://www.manual-lib.com>

<http://www.404manual.com>

<http://www.luxmanual.com>

<http://aubethermostatmanual.com>

Golf course search by state

<http://golfingnear.com>

Email search by domain

<http://emailbydomain.com>

Auto manuals search

<http://auto.somanuals.com>

TV manuals search

<http://tv.somanuals.com>