

**Pioneer** *sound.vision.soul*

DVD Recorder

**DVR-640H-S**

**DVR-543H-S**

**DVR-540H-S**

**HDD**  
HARD DISK DRIVE

**DVD**  
VIDEO

**DVD MULTI**  
RECORDER

**RW**  
DVD • ReWritable

**DIVX**

COMPACT  
**disc**  
DIGITAL AUDIO

COMPACT  
**disc**  
DIGITAL VIDEO

**VCR** *plus+*

Register Your Product on

[www.pioneerelectronics.com](http://www.pioneerelectronics.com) (US)

[www.pioneerelectronics.ca](http://www.pioneerelectronics.ca) (Canada)

Operating Instructions

**RW**  
COMPATIBLE

Thank you for buying this Pioneer product.  
Please read through these operating instructions so you will know how to operate your model properly.  
After you have finished reading the instructions, put them away in a safe place for future reference.



The lightning flash with arrowhead, within an equilateral triangle, is intended to alert the user to the presence of uninsulated "dangerous voltage" within the product's enclosure that may be of sufficient magnitude to constitute a risk of electric shock to persons.

### CAUTION

**RISK OF ELECTRIC SHOCK  
DO NOT OPEN**

**CAUTION:**  
TO PREVENT THE RISK OF ELECTRIC SHOCK, DO NOT REMOVE COVER (OR BACK). NO USER-SERVICEABLE PARTS INSIDE. REFER SERVICING TO QUALIFIED SERVICE PERSONNEL.



The exclamation point within an equilateral triangle is intended to alert the user to the presence of important operating and maintenance (servicing) instructions in the literature accompanying the appliance.

D1-4-2-3\_En

**IMPORTANT NOTICE** – THE SERIAL NUMBER FOR THIS EQUIPMENT IS LOCATED IN THE REAR. PLEASE WRITE THIS SERIAL NUMBER ON YOUR ENCLOSED WARRANTY CARD AND KEEP IN A SECURE AREA. THIS IS FOR YOUR SECURITY.

D1-4-2-6-1\_En

### Information to User

Alteration or modifications carried out without appropriate authorization may invalidate the user's right to operate the equipment.

D8-10-2\_En

**NOTE:** This equipment has been tested and found to comply with the limits for a Class B digital device, pursuant to Part 15 of the FCC Rules. These limits are designed to provide reasonable protection against harmful interference in a residential installation. This equipment generates, uses, and can radiate radio frequency energy and, if not installed and used in accordance with the instructions, may cause harmful interference to radio communications. However, there is no guarantee that interference will not occur in a particular installation. If this equipment does cause harmful interference to radio or television reception, which can be determined by turning the equipment off and on, the user is encouraged to try to correct the interference by one or more of the following measures:

- Reorient or relocate the receiving antenna.
- Increase the separation between the equipment and receiver.
- Connect the equipment into an outlet on a circuit different from that to which the receiver is connected.
- Consult the dealer or an experienced radio/TV technician for help.

D8-10-1-2\_En

**CAUTION :** USE OF CONTROLS OR ADJUSTMENTS OR PERFORMANCE OF PROCEDURES OTHER THAN THOSE SPECIFIED HEREIN MAY RESULT IN HAZARDOUS RADIATION EXPOSURE.

**CAUTION :** THE USE OF OPTICAL INSTRUMENTS WITH THIS PRODUCT WILL INCREASE EYE HAZARD. D6-8-2-1\_En

**WARNING** – TO PREVENT FIRE OR SHOCK HAZARD, DO NOT EXPOSE THIS APPLIANCE TO RAIN OR MOISTURE.

D1-4-2-1\_En

**CAUTION:** This product satisfies FCC regulations when shielded cables and connectors are used to connect the unit to other equipment. To prevent electromagnetic interference with electric appliances such as radios and televisions, use shielded cables and connectors for connections.

D8-10-3a\_En

This Class B digital apparatus complies with Canadian ICES-003.

Cet appareil numérique de la Classe B est conforme à la norme NMB-003 du Canada.

D8-10-1-3\_EF

# IMPORTANT SAFETY INSTRUCTIONS

**READ INSTRUCTIONS** — All the safety and operating instructions should be read before the product is operated.

**RETAIN INSTRUCTIONS** — The safety and operating instructions should be retained for future reference.

**HEED WARNINGS** — All warnings on the product and in the operating instructions should be adhered to.

**FOLLOW INSTRUCTIONS** — All operating and use instructions should be followed.

**CLEANING** — The product should be cleaned only with a polishing cloth or a soft dry cloth. Never clean with furniture wax, benzene, insecticides or other volatile liquids since they may corrode the cabinet.

**ATTACHMENTS** — Do not use attachments not recommended by the product manufacturer as they may cause hazards.

**WATER AND MOISTURE** — Do not use this product near water — for example, near a bathtub, wash bowl, kitchen sink, or laundry tub; in a wet basement; or near a swimming pool; and the like.

**ACCESSORIES** — Do not place this product on an unstable cart, stand, tripod, bracket, or table. The product may fall, causing serious injury to a child or adult, and serious damage to the product. Use only with a cart, stand, tripod, bracket, or table recommended by the manufacturer, or sold with the product. Any mounting of the product should follow the manufacturer's instructions, and should use a mounting accessory recommended by the manufacturer.

**CART** — A product and cart combination should be moved with care. Quick stops, excessive force, and uneven surfaces may cause the product and cart combination to overturn.



**VENTILATION** — Slots and openings in the cabinet are provided for ventilation and to ensure reliable operation of the product and to protect it from overheating, and these openings must not be blocked or covered. The openings should never be blocked by placing the product on a bed, sofa, rug, or other similar surface. This product should not be placed in a built-in installation such as a bookcase or rack unless proper ventilation is provided or the manufacturer's instructions have been adhered to.

**POWER SOURCES** — This product should be operated only from the type of power source indicated on the marking label. If you are not sure of the type of power supply to your home, consult your product dealer or local power company.

**LOCATION** — The appliance should be installed in a stable location.

**NONUSE PERIODS** — The power cord of the appliance should be unplugged from the outlet when left un-used for a long period of time.

## GROUNDING OR POLARIZATION

- If this product is equipped with a polarized alternating current line plug (a plug having one blade wider than the other), it will fit into the outlet only one way. This is a safety feature. If you are unable to insert the plug fully into the outlet, try reversing the plug. If the plug should still fail to fit, contact your electrician to replace your obsolete outlet. Do not defeat the safety purpose of the polarized plug.
- If this product is equipped with a three-wire grounding type plug, a plug having a third (grounding) pin, it will only fit into a grounding type power outlet. This is a safety feature. If you are unable to insert the plug into the outlet, contact your electrician to replace your obsolete outlet. Do not defeat the safety purpose of the grounding type plug.

**POWER-CORD PROTECTION** — Power-supply cords should be routed so that they are not likely to be walked on or pinched by items placed upon or against them, paying particular attention to cords at plugs, convenience receptacles, and the point where they exit from the product.

**OUTDOOR ANTENNA GROUNDING** — If an outside antenna or cable system is connected to the product, be sure the antenna or cable system is grounded so as to provide some protection against voltage surges and built-up static charges. Article 810 of the National Electrical Code, ANSI/NFPA 70, provides information with regard to proper grounding of the mast and supporting structure, grounding of the lead-in wire to an antenna discharge unit, size of grounding conductors, location of antenna-discharge unit, connection to grounding electrodes, and requirements for the grounding electrode. See Figure A.

**LIGHTNING** — For added protection for this product during a lightning storm, or when it is left unattended and unused for long periods of time, unplug it from the wall outlet and disconnect the antenna or cable system. This will prevent damage to the product due to lightning and power-line surges.

**POWER LINES** — An outside antenna system should not be located in the vicinity of overhead power lines or other electric light or power circuits, or where it can fall into such power lines or circuits. When installing an outside antenna system, extreme care should be taken to keep from touching such power lines or circuits as contact with them might be fatal.

**OVERLOADING** — Do not overload wall outlets, extension cords, or integral convenience receptacles as this can result in a risk of fire or electric shock.

**OBJECT AND LIQUID ENTRY** — Never push objects of any kind into this product through openings as they may touch dangerous voltage points or short-out parts that could result in a fire or electric shock. Never spill liquid of any kind on the product.

**SERVICING** — Do not attempt to service this product yourself as opening or removing covers may expose you to dangerous voltage or other hazards. Refer all servicing to qualified service personnel.

**DAMAGE REQUIRING SERVICE** — Unplug this product from the wall outlet and refer servicing to qualified service personnel under the following conditions:

- When the power-supply cord or plug is damaged.
- If liquid has been spilled, or objects have fallen into the product.
- If the product has been exposed to rain or water.
- If the product does not operate normally by following the operating instructions. Adjust only those controls that are covered by the operating instructions as an improper adjustment of other controls may result in damage and will often require extensive work by a qualified technician to restore the product to its normal operation.
- If the product has been dropped or damaged in any way.
- When the product exhibits a distinct change in performance — this indicates a need for service.

**REPLACEMENT PARTS** — When replacement parts are required, be sure the service technician has used replacement parts specified by the manufacturer or have the same characteristics as the original part. Unauthorized substitutions may result in fire, electric shock, or other hazards.

**SAFETY CHECK** — Upon completion of any service or repairs to this product, ask the service technician to perform safety checks to determine that the product is in proper operating condition.

**WALL OR CEILING MOUNTING** — The product should not be mounted to a wall or ceiling.

**HEAT** — The product should be situated away from heat sources such as radiators, heat registers, stoves, or other products (including amplifiers) that produce heat.

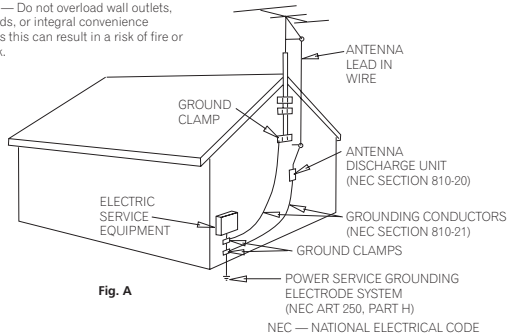

## DANGER

VISIBLE AND INVISIBLE LASER RADIATION WHEN OPEN. AVOID DIRECT EXPOSURE TO BEAM.

**CAUTION** – PREVENT ELECTRIC SHOCK DO NOT USE THIS (POLARIZED) PLUG WITH AN EXTENSION CORD, RECEPTACLE OR OTHER OUTLET UNLESS THE BLADES CAN BE FULLY INSERTED TO PREVENT BLADE EXPOSURE.

**ATTENTION** – POUR PREVENIR LES CHOCS ELECTRIQUES NE PAS UTILISER CETTE FICHE POLARISEE AVEC UN PROLONGATEUR UNE PRISE DE COURANT OU UNE AUTRE SORTIE DE COURANT, SAUF SI LES LAMES PEUVENT ETRE INSEREES A FOND SANS EN LAISSER AUCUNE PARTIE A DECOUVERT.

D2-4-4-1\_EF

## NOTE TO CATV SYSTEM INSTALLER

THIS REMINDER IS PROVIDED TO CALL THE CATV SYSTEM INSTALLER'S ATTENTION TO ARTICLE 820-40 OF THE NEC THAT PROVIDES GUIDELINES FOR PROPER GROUNDING AND, IN PARTICULAR, SPECIFIES THAT THE CABLE GROUND SHALL BE CONNECTED TO THE GROUNDING SYSTEM OF THE BUILDING, AS CLOSE TO THE POINT OF CABLE ENTRY AS PRACTICAL.

D1-4-2-8\_En

**Recording equipment and copyright:** You may use this product only to reproduce or copy materials for which you own the copyright or have obtained permission to copy from the copyright owner or for which you otherwise have a legal right to reproduce or copy. Unless you own the copyright or have obtained permission from the copyright owner or otherwise have a legal right to reproduce or copy, you may be violating the law, including copyright law, and may be subject to payment of damages and other remedies.

K018U5\_En

## POWER-CORD CAUTION

Handle the power cord by the plug. Do not pull out the plug by tugging the cord and never touch the power cord when your hands are wet as this could cause a short circuit or electric shock. Do not place the unit, a piece of furniture, etc., on the power cord, or pinch the cord. Never make a knot in the cord or tie it with other cords. The power cords should be routed such that they are not likely to be stepped on. A damaged power cord can cause a fire or give you an electrical shock. Check the power cord once in a while. When you find it damaged, ask your nearest PIONEER authorized service center or your dealer for a replacement. **5002\_En**

This product is for general household purposes. Any failure due to use for other than household purposes (such as long-term use for business purposes in a restaurant or use in a car or ship) and which requires repair will be charged for even during the warranty period. **K041\_En**

This product includes FontAvenue® fonts licenced by NEC corporation. FontAvenue is a registered trademark of NEC Corporation.

**WARNING:** Handling the cord on this product or cords associated with accessories sold with the product will expose you to chemicals listed on proposition 65 known to the State of California and other governmental entities to cause cancer and birth defect or other reproductive harm.

**Wash hands after handling**

D36-P4\_A\_En

This product contains mercury. Disposal of this material may be regulated due to environmental considerations. For disposal or recycling information, please contact your local authorities or the Electronics Industries Alliance : [www.eiae.org](http://www.eiae.org). **K057\_En**



## Dear Customer:

Selecting fine audio equipment such as the unit you've just purchased is only the start of your musical enjoyment. Now it's time to consider how you can maximize the fun and excitement your equipment offers. This manufacturer and the Electronic Industries Association's Consumer Electronics Group want you to get the most out of your equipment by playing it at a safe level. One that lets the sound come through loud and clear without annoying blaring or distortion-and, most importantly, without affecting your sensitive hearing.

Sound can be deceiving. Over time your hearing "comfort level" adapts to higher volumes of sound. So what sounds "normal" can actually be loud and harmful to your hearing. Guard against this by setting your equipment at a safe level BEFORE your hearing adapts.

### To establish a safe level:

- Start your volume control at a low setting.
- Slowly increase the sound until you can hear it comfortably and clearly, and without distortion.

### Once you have established a comfortable sound level:

- Set the dial and leave it there.

Taking a minute to do this now will help to prevent hearing damage or loss in the future. After all, we want you listening for a lifetime.

## We Want You Listening For A Lifetime

Used wisely, your new sound equipment will provide a lifetime of fun and enjoyment. Since hearing damage from loud noise is often undetectable until it is too late, this manufacturer and the Electronic Industries Association's Consumer Electronics Group recommend you avoid prolonged exposure to excessive noise. This list of sound levels is included for your protection.

### Decibel Level Example

30	Quiet library, soft whispers
40	Living room, refrigerator, bedroom away from traffic
50	Light traffic, normal conversation, quiet office
60	Air conditioner at 20 feet, sewing machine
70	Vacuum cleaner, hair dryer, noisy restaurant
80	Average city traffic, garbage disposals, alarm clock at two feet.

### THE FOLLOWING NOISES CAN BE DANGEROUS UNDER CONSTANT EXPOSURE

90	Subway, motorcycle, truck traffic, lawn mower
100	Garbage truck, chain saw, pneumatic drill
120	Rock band concert in front of speakers, thunderclap
140	Gunshot blast, jet plane
180	Rocket launching pad

Information courtesy of the Deafness Research Foundation.



5001\_En

### CAUTION

This product is a class 1 laser product, but this product contains a laser diode higher than Class 1.

To ensure continued safety, do not remove any covers or attempt to gain access to the rear of the product.

Refer all servicing to qualified personnel.

The following caution label appears on your unit.

Location: top of the unit

**CLASS 1 LASER PRODUCT**  
**APPAREIL À LASER DE CLASSE 1**

**CAUTION**  
**ATTENTION**  
**ADVARSEL**  
**VARNING**  
**VORSICHT**  
**PRECAUCIÓN**  
**VARO!**  
**注意**  
**注意**

CLASS 3B VISIBLE AND INVISIBLE LASER RADIATION WHEN OPEN, AVOID EXPOSURE TO THE BEAM.  
RADIATIONS LASER VISIBLES ET INVISIBLES DE CLASSE 3B QUAND OUVERT. ÉVITEZ TOUT EXPOSITION AU FASCEAU.  
KLASSE 3B SYNLIG OG USYNLIG LASERSTRÅLING VED ÅBNING. UNDGÅ UDSÆTTELSE FOR STRÅLING.  
KLASSE 3B SYNLIG OCH OSYNLIG LASERSTRÅLING NÄR DENNA DEL ÄR ÖPPNAD. UNDVIK ATT UTSÄTTA DIG FÖR STRÅLEN.  
BE GEÖFFNETER ABDECKUNG IST SICHTBARE UND UNSICHTBARE LASERSTRALHUNG DER KLASSE 3B IM GERÄTEINNEREN VORHANDEN.  
NIGIT DENI LASERSTRÅK. AUSSETZEN!  
CUANDO SE ABRE HAY RADIACIÓN LASER DE CLASE 3B VISIBLE E INVISIBLE. EVITE LA EXPOSICIÓN A LOS RAYOS LASER.  
AVATTAESSA OLET ALTIINA NÄKYVÄLLE JA NÄKYMÄTTÖMÄLLE LUOKAN 3B LASERSÄTELYLLE. ÄLÄ KATSO SÄTEESEEN.  
打開時會有CLASS 3B可見和不可見鐳射輻射。請勿受鐳射束輻射。  
ここを開くとCLASS 3Bの可視レーザー光及び不可視レーザー光が出ます。ビームを直接見たり、触れたりしないこと。

VRW2262 - A

D3-4-2-1-8\_B\_En

# Contents

## 01 Before you start

What's in the box .....	8
Putting the batteries in the remote control .....	8
Using the remote control .....	8
Disc / content format playback compatibility .....	9
About the internal hard disk drive .....	14
Symbols used in this manual .....	15

## 02 Connecting up

Rear panel connections .....	16
Front panel connections .....	17
Easy connections .....	18
Using other types of video output .....	19
Connecting to a cable box or satellite receiver (1) .....	20
Connecting to a cable box or satellite receiver (2) .....	21
Connecting to an AV amplifier or receiver .....	22
Connecting other AV sources .....	23
Connecting a USB device .....	23
Plugging in .....	24

## 03 Controls and displays

Front panel .....	25
Remote control .....	26
Display .....	28

## 04 Getting started

Switching on and setting up .....	30
-----------------------------------	----

## 05 Recording

About DVD recording .....	33
About HDD recording .....	34
Recorded audio .....	34
Restrictions on video recording .....	35
Using the built-in TV tuner .....	36
Setting the picture quality/ recording time .....	37
Basic recording from the TV .....	37
Setting a timer recording .....	38
Timer recording FAQ .....	46
Simultaneous recording and playback (Chase Play) .....	46
Recording from an external component .....	47
Automatic recording from a satellite tuner .....	47
Playing your recordings on other DVD players .....	49
Initializing recordable DVD discs .....	51

## 06 Playback

Introduction .....	52
Basic playback .....	52
Using the Disc Navigator to browse the contents of a disc .....	57
Scanning discs .....	58
Playing in slow motion .....	59
Frame advance/frame reverse .....	59
The Play Mode menu .....	59
Displaying and switching subtitles .....	62
Switching DVD and DivX soundtracks ..	63
Switching audio channels .....	63
Switching camera angles .....	64
Displaying disc information on-screen ..	64



## 07 Editing

The Disc Navigator screen . . . . . 66

## 08 Copying and backup

Introduction . . . . . 80

One Touch Copy . . . . . 81

Using Copy Lists . . . . . 82

Using disc backup . . . . . 88

## 09 Using the Jukebox

Copying music to the HDD . . . . . 90

Copying files from a USB device to  
the HDD . . . . . 91

Playing music from the Jukebox . . . . . 91

Editing Jukebox albums . . . . . 92

## 10 The PhotoViewer (DVR-640H-S/ DVR-543H-S)

Locating JPEG picture files . . . . . 93

Playing a slideshow . . . . . 94

Importing files to the HDD . . . . . 95

Importing files from a USB device . . . . . 97

Copying selected files to a DVD-R/-RW . . 97

Editing files on the HDD . . . . . 98

Printing files . . . . . 100

## 11 The PhotoViewer (DVR-540H-S)

Locating JPEG picture files . . . . . 101

Playing a slideshow . . . . . 101

## 12 The Disc Setup menu

Basic settings . . . . . 103

Initialize settings . . . . . 104

Finalize settings . . . . . 104

Optimize HDD . . . . . 105

Initialize HDD . . . . . 105

## 13 The Video Adjust menu

Setting the picture quality for TV and  
external inputs . . . . . 106

Setting the picture quality for disc  
playback . . . . . 108

## 14 The Initial Setup menu

Using the Initial Setup menu . . . . . 110

Selecting other languages for language  
options . . . . . 118

## 15 Additional information

Minimum copying times . . . . . 119

Screen sizes and disc formats . . . . . 120

Troubleshooting . . . . . 121

Manual recording modes . . . . . 125

Language code list . . . . . 126

Country/Area code list . . . . . 127

Additional information for cable/  
satellite/STB (set-top box) users . . . . . 127

On-screen displays and recorder  
displays . . . . . 128

Handling discs . . . . . 131

Cleaning the pickup lens . . . . . 131

Condensation . . . . . 132

Hints on installation . . . . . 132

Moving the recorder . . . . . 132

Resetting the recorder . . . . . 132

Specifications . . . . . 133

## Chapter 1

# Before you start

### What's in the box

Please confirm that the following accessories are in the box when you open it.

- Remote control
- AA/R6P dry cell batteries x 2
- Audio/video cable (red/white/yellow)
- RF antenna cable
- Power cable
- These operating instructions
- Quick start guide
- Warranty card

### Putting the batteries in the remote control

1 Insert two AA/R6P batteries into the battery compartment following the indications (+, -) inside the compartment.

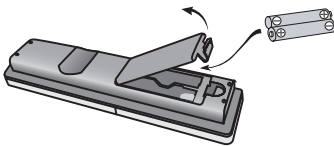

#### Important

Incorrect use of batteries can result in hazards such as leakage and bursting. Please observe the following:

- Don't mix new and old batteries together.

- Don't use different kinds of batteries together—although they may look similar, different batteries may have different voltages.
- Make sure that the plus and minus ends of each battery match the indications in the battery compartment.
- Remove batteries from equipment that isn't going to be used for a month or more.
- When disposing of used batteries, please comply with governmental regulations or environmental public instruction's rules that apply in your country or area.

#### WARNING

Do not use or store batteries in direct sunlight or other excessively hot place, such as inside a car or near a heater. This can cause batteries to leak, overheat, explode or catch fire. It can also reduce the life or performance of batteries.

D3-4-2-3-3\_En

### Using the remote control

Please keep in mind the following when using the remote control:

- Make sure that there are no obstacles between the remote and the remote sensor on the unit.
- Remote operation may become unreliable if strong sunlight or fluorescent light is shining on the unit's remote sensor.
- Remote controllers for different devices can interfere with each other. Avoid using remotes for other equipment located close to this unit.



## Before you start

- Replace the batteries when you notice a fall off in the operating range of the remote.
- When the batteries run down or you change the batteries, the remote control mode is reset to Recorder 1. See *Remote Control Mode* on page 117.
- Use within the operating range in front of the remote control sensor on the front panel, as shown.

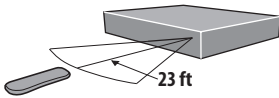

- You can control this recorder using the remote sensor of another Pioneer component using the **CONTROL IN** jack on the rear panel. See *Rear panel connections* on page 16 for more information.

## Disc / content format playback compatibility

### Compatible media

- DVD-RW ver. 1.1 / 1 x / 1 x to 2 x, ver. 1.2 / 2 x to 4 x / 2 x to 6 x
- DVD-R ver. 2.0 / 1 x / 1 x to 4 x / 1 x to 8 x / 1 x to 16 x, ver. 2.1 / 1 x to 8 x / 1 x to 16 x
- DVD+RW 1 x to 2.4 x / 1 x to 4 x / 3.3 x to 8 x
- DVD+R 1 x to 2.4 x / 1 x to 4 x / 1 x to 8 x / 1 x to 16 x
- DVD-RAM ver. 2.0 / 2 x, ver. 2.1 / 2 x / 2 x to 3 x / 2 x to 5 x, ver. 2.2 / 2 x / 2 x to 3 x / 2 x to 5 x
- DVD-R DL ver. 3.0 / 2 x to 4 x

- DVD+R DL 2.4 x / 2.4 x to 8 x

Note that older models of DVD recorders and DVD writers may reject DVD-RW ver. 1.2 discs and/or corrupt the data on the disc. If you want to share DVD-RW discs between this recorder and an older recorder/writer, we recommend using ver. 1.1 discs.

The following table shows older Pioneer DVD recorders' limited compatibility with DVD-RW ver. 1.2 discs.

Model	Playable	Recordable
DVR-7000	Yes <sup>1,2,3</sup>	No
DVR-810 H DVR-57H DVR-210 DVR-310 DVR-510H	Yes <sup>1</sup>	No

















<sup>1</sup> Discs should be finalized in this recorder before playing. Unfinalized VR mode and Video mode discs may not play.

<sup>2</sup> **Cannot read the CPRM information** will show in the display when you load a disc. However, this will not affect playback.

<sup>3</sup> Copy-once protected disc titles will not play.

### DVD/HDD Recording and playback compatibility

This recorder can play and record all the currently popular DVD disc types, as well as providing HDD functionality. The table below shows some specific compatibility differences between the different disc types.

	HDD	DVD-R	DVD-RW	DVD+R	DVD+RW	DVD-RAM
Marks used in this manual		 	 			
		*1	*1 *2			*13, 16
Logos			 		 	
Re-recordable / Erasable	●	● *3	● *3	●	● *3	● *14
Editing of recorded programs	●	●	● *4	●	● *4	● *4
Recording of Copy-once protected material	●	● *12		● *12		● *12
Playback in other players/recorders	n/a	● *5	● *6	● *7	● *6	● *8
					● *6, 15	● *9
Chase play	●					
16:9 and 4:3 program recording	●	●		●		●
Bilingual broadcast recording of both audio channels	● *10, 11	● *11		● *11		● *11

### Notes to table

\*1 Must be initialized for VR mode recording (page 104)

\*2 Must be initialized for Video mode recording

(page 104)

\*3 Erasable, but free space does not increase

\*4 Cannot erase sections, edit chapters or use playlist editing

\*5 Must be compatible with DVD-R(VR) playback

\*6 Finalize using this recorder (may not playback in some units) (page 49)

\*7 Must be compatible with DVD-RW(VR) playback

\*8 Must be compatible with DVD+RW playback

\*9 Must be compatible with DVD-RAM playback

\*10 Only when HDD Recording Format is set to Video Mode Off (page 115)

\*11 Only when the recording mode is not set to LPCM

\*12 CPRM-compatible discs only

\*13 Take the disc out of the cartridge before use. Only Matsushita and Maxell discs have been tested to work reliably with this recorder. Discs from other makers may become unusable when recorded or edited.

\*14 Erasing a title does not increase the available recording time, nor increase the number of recordable titles left.

\*15 Must be compatible with DVD+R playback

\*16 Depending on the disc, it may have to be initialized before it can be recorded (page 104). In this case, initialization will take about 1 hour.

 is a trademark of DVD Format/Logo Licensing Corporation.

## Using DVD-R DL/DVD+R DL discs

DVD-R DL (dual-layer) and DVD+R DL (double-layer) discs contain two recordable layers on a single side, giving about 1.8 times the recording capacity of a conventional single-layer disc. This unit can record to both DVD-R DL and DVD+R DL discs.

- If you intend to play DVD-R DL (Video mode) or DVD+R DL discs recorded on this unit on other DVD recorders/players, you must finalize them. (Note that some DVD recorders/players may not play even finalized DL discs.)
- Please read the information provided on the disc packaging carefully before purchasing DVD-R DL/DVD+R DL discs:
- *Confirm the disc version:* Use ver. 3.0, 2 x to 4 x DVD-R discs.
- *Confirm the recording speed:* DVD-R should be compatible with 2 x or 4 x recording; DVD+R with 2.4 x to 8 x recording.
- This logo indicates that the disc is a DVD-R DL or DVD+R DL disc:



- Correct operation has been confirmed for DVD-R DL discs (ver. 3.0 / 2 x, 4 x) produced by the following manufacturers: Mitsubishi Kagaku Media, Verbatim (as of March 2005).

## About DualDisc playback

A DualDisc is a new two-sided disc, one side of which contains DVD content –video, audio, etc. –while the other side contains non-DVD content such as digital audio material.

The non-DVD, audio side of the disc is not compliant with the CD Audio specification and therefore may not play.

It is possible that when loading or ejecting a DualDisc, the opposite side to that being played will be scratched. Scratched discs may not be playable.

The DVD side of a DualDisc plays in this product. DVD-Audio content will not play.

For more detailed information on the DualDisc specification, please refer to the disc manufacturer or disc retailer.

## Other disc compatibility

In addition to DVD, this recorder is compatible with a wide range of disc types (media) and formats. Playable discs will generally feature one of the following logos on the disc and/or disc packaging. Note however that some disc types, such as recordable CD (and DVD), may be in an unplayable format—see below for further compatibility information.



## CD-R/RW compatibility

This recorder cannot record CD-R or CD-RW discs.

- Readable formats: CD-Audio, Video CD, ISO 9660 CD-ROM\* containing MP3, WMA, JPEG or DivX files.  
\* ISO 9660 Level 1 or 2 compliant. CD physical format: Mode1, Mode2 XA Form1. Romeo and Joliet file systems are both compatible with this recorder.
- Multi-session playback: Yes (except CD-Audio and Video CD)
- Unfinalized disc playback: CD-Audio only

### Compressed audio compatibility

- Compatible media: CD-ROM, CD-R, CD-RW, *DVR-640H-S/DVR-543H-S only*: USB
- Compatible formats: MPEG-1 Audio Layer 3 (MP3), Windows Media Audio (WMA)
- Sampling rates: 32 kHz, 44.1 kHz or 48 kHz
- Bit-rates: Any (128 Kbps or higher recommended)
- Variable bit-rate (VBR) MP3 playback: Yes
- VBR WMA playback: No
- WMA encoder compatibility: Windows Media Codec 8 (*files encoded using Windows Media Codec 9 may be playable but some parts of the specification are not supported; specifically, Pro, Lossless, Voice and VBR*)
- DRM (Digital Rights Management)<sup>1</sup> file playback: No
- File extensions: .mp3, .wma (these must be used for the recorder to recognize MP3 and WMA files – do not use for other file types)
- File structure: Up to 99 folders / 999 files (if these limits are exceeded, only files and folders up to these limits are playable)

### WMA (Windows Media Audio) compatibility



The Windows Media<sup>®</sup> logo printed on the box indicates that this recorder can playback Windows Media Audio content.

WMA is an acronym for Windows Media Audio and refers to an audio compression technology developed by Microsoft Corporation. WMA content can be encoded by using Windows Media<sup>®</sup> Player for Windows<sup>®</sup> XP, Windows Media<sup>®</sup> Player 9 or Windows Media<sup>®</sup> Player 10 series.

*Microsoft, Windows Media, and the Windows logo are trademarks, or registered trademarks of Microsoft Corporation in the United States and/or other countries.*

### DivX video compatibility



DivX is a compressed digital video format created by the DivX<sup>®</sup> video codec from DivX, Inc. This recorder can play DivX video files burned on CD-R/-RW/-ROM discs. Keeping the same terminology as DVD-Video, individual DivX video files are called "Titles." When naming files/titles on a CD-R/-RW disc prior to burning, keep in mind that by default they will be played in alphabetical order.

#### Note

<sup>1</sup> DRM (digital rights management) copy protection is a technology designed to prevent unauthorized copying by restricting playback, etc. of compressed audio files on devices other than the PC (or other recording equipment) used to record it. For detailed information, please see the instruction manuals or help files that came with your PC and/or software.

- Official DivX<sup>®</sup> Certified product.
- Plays all versions of DivX<sup>®</sup> video (including DivX<sup>®</sup> 6) with standard playback of DivX<sup>®</sup> media files.
- File extensions: .avi and .divx (these must be used for the recorder to recognize DivX video files). *Note that all files with the .avi extension are recognized as MPEG4, but not all of these are necessarily DivX video files and therefore may not be playable on this recorder.*
- File structure: Up to 99 folders or 999 files.

*DivX, DivX Certified, and associated logos are trademarks of DivX, Inc. and are used under license.*

### DivX<sup>®</sup> VOD content



In order to play DivX VOD (video on demand) content on this recorder, you first need to register the recorder with your DivX VOD content provider. You do this by generating a DivX VOD registration code, which you submit to your provider.

Some DivX VOD content may only be playable a fixed number of times. When you load a disc containing this type of DivX VOD content, the remaining number of plays is shown on-screen and you then have the option of playing the disc (thereby using up one of the remaining plays), or stopping. If you load a disc that contains expired DivX VOD content (for example, content that has zero remaining plays), the message **Rental Expired** is displayed.

If your DivX VOD content allows an unlimited number of plays, then you may load the disc into your recorder and play the content as often as you like, and no message will be displayed.



### Important

- DivX VOD content is protected by a DRM (Digital Rights Management) system. This restricts playback of content to specific, registered devices.
- If you load a disc that contains DivX VOD content not authorized for this recorder, the message **Authorization Error** is displayed and the content will not play.
- Resetting the recorder (as described in *Resetting the recorder* on page 132) will not cause you to lose your registration code.

### JPEG file compatibility

- Compatible formats: Baseline JPEG and EXIF 2.2\* still image files  
*\*File format used by digital still cameras*
- Sampling ratio: 4:4:4, 4:2:2, 4:2:0
- Horizontal resolution: 160 to 5120 pixels
- Vertical resolution: 120 to 3840 pixels
- Progressive JPEG compatible: No
- File extensions: .jpg, .jpeg, .jpe, .jif, .jfif (must be used for the recorder to recognize JPEG files – do not use for other file types)
- File structure: The recorder can load up to 99 folders / 999 files at one time (*if there are more files/folders than this on the disc then more can be reloaded*)

### PC-created disc compatibility

Discs recorded using a personal computer may not be playable in this unit due to the setting of the application software used to create the disc. In these particular instances, check with the software publisher for more detailed information.

Discs recorded in packet write mode (UDF format) are not compatible with this recorder.

Check the DVD-R/-RW or CD-R/-RW software disc boxes for additional compatibility information.

### Dolby Digital



*Manufactured under license from Dolby Laboratories. "Dolby" and the double-D symbol are trademarks of Dolby Laboratories.*

### DTS



*"DTS" and "DTS Digital Out" are registered trademarks of Digital Theater Systems, Inc.*

## About the internal hard disk drive

The internal hard disk drive (HDD) is a fragile piece of equipment. Depending on the conditions under which it is used, or through careless use, it is possible that the recorded

contents will be damaged or lost completely, or that normal playback and recording will not be possible. Please understand that in the event of repair or replacement of the HDD or related components, all your HDD recordings will be lost.

Please use the recorder following the guidelines below to protect against possible HDD failure.

*The HDD should not be regarded as a place to store recordings permanently. We recommend that you back up your important recordings onto DVD discs in order to protect against accidental loss.*

*Pioneer cannot under any circumstances accept responsibility for any direct or indirect loss arising from any inconvenience or loss of recorded material resulting from HDD failure.*

- Install and use the recorder on a stable, level surface.
- Do not block the rear vent/cooling fan.
- Do not use the recorder in excessively hot or humid places, or in places that may be subject to sudden changes in temperature. Sudden changes in temperature can cause condensation to form inside the recorder. This can be a cause of HDD failure.
- Do not move the recorder immediately after switching it off. If you need to move the recorder, please follow the steps below:
  - 1 After the message **POWER OFF** is shown in the display, wait at least two minutes.
  - 2 Unplug from the wall socket.
  - 3 Move the recorder.
- If there's a power failure while the recorder is on there is a chance that some data on the HDD will be lost.













- The HDD is very delicate. If used improperly or in an unsuitable environment, it is possible that the HDD will fail after a few years of use. Signs of problems include playback unexpectedly freezing and noticeable block noise (mosaic) in the picture. However, sometimes there will be no warning signs of HDD failure. If the HDD fails, no playback of recorded material will be possible. In this case it will be necessary to replace the HDD unit.

### Optimizing HDD performance

As you record and edit material on the HDD, the data on the disk becomes fragmented, eventually affecting the recorder's performance. Before this happens, the recorder will warn you that it is time to optimize the HDD (which you can do from the Disc Setup menu; see *Optimize HDD* on page 105).

## Symbols used in this manual

The following icons are provided to help you quickly identify which instructions you need for which kind of disc.

	HDD
	Any type of DVD disc (recordable or playback only), finalized or not.
	Commercially produced DVD, finalized Video mode DVD-R/-RW.
	Video mode DVD-R/-RW (unfinalized)
	VR mode DVD-R/-RW
	DVD+R
	DVD+RW
	DVD-RAM
	Audio CD
	Video CD
	WMA or MP3 files
	DivX files

## Chapter 2

# Connecting up

### Rear panel connections

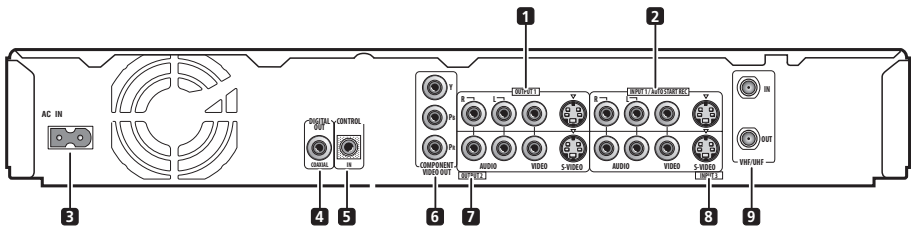

#### 1 OUTPUT 1

Stereo analog audio, S-video and composite video output for connection to a TV, monitor, AV receiver, etc.

#### 2 INPUT 1/AUTO START REC

Stereo analog audio, S-video and composite video input for connection to a satellite receiver, set top box, etc.

#### 3 AC IN

Connect to a power outlet using the supplied power cable after making all other connections.

#### 4 COAXIAL DIGITAL OUT

A digital audio output for connecting to an AV amp/receiver, Dolby Digital/DTS decoder or other equipment with coaxial digital input.

#### 5 CONTROL IN

Use to control this recorder from the remote sensor of another Pioneer component with a **CONTROL OUT** terminal and bearing the Pioneer  mark. Connect the **CONTROL OUT** of the other component to the **CONTROL IN** of this recorder using a mini-plug cord.

#### 6 COMPONENT VIDEO OUT

A high-quality video output for connecting to a TV or monitor with a component video input.

#### 7 OUTPUT 2

Stereo analog audio, S-video and composite video output for connection to a TV, monitor, AV receiver, etc.

#### 8 INPUT 3

Stereo analog audio, S-video and composite video input for connection to a satellite receiver, set top box, etc.

#### 9 VHF/UHF IN/OUT

Connect your TV antenna to the **VHF/UHF IN (RF IN)** jack. The signal is passed through to the **VHF/UHF OUT** jack for connection to your TV.



## Front panel connections

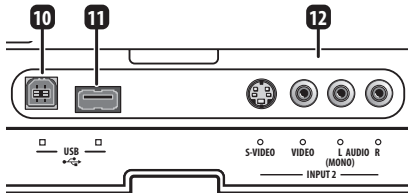

On the front panel a flip-down cover hides more connections.

### **10 USB port (type B)** (*DVR-640H-S/DVR-543H-S only*)

USB port for connecting a PictBridge-compatible printer.

### **11 USB port (type A)** (*DVR-640H-S/DVR-543H-S only*)

USB port for connecting a digital camera, USB memory or other USB device.

### **12 INPUT 2**

Audio/video input (stereo analog audio; composite and S-video video), especially suitable for camcorders, game consoles, portable audio, etc.

## Easy connections

The setup described here is a basic configuration that allows you to record TV programs on both this recorder and your VCR. When watching recordings from this recorder, set your TV to input 1; switch to input 2 to watch a video playing in the VCR.



### Important

- This recorder is equipped with copy protection technology. Do not connect this recorder to your TV via a VCR (or your VCR via this recorder) using AV cables, as the picture from this recorder will not appear properly on your TV.
- Before making or changing any rear panel connections, make sure that all components are switched off and unplugged from the wall outlet.

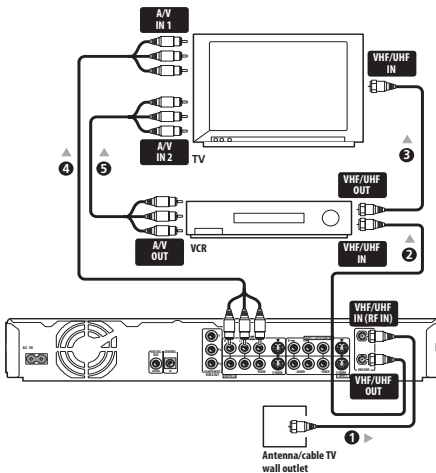

**1** Connect your TV antenna/cable TV outlet to the **VHF/UHF IN** jack on this recorder.

**2** Use an RF antenna cable (one is supplied) to connect the **VHF/UHF OUT** jack on this recorder to the antenna input on your VCR.

- If you are not connecting a VCR in the chain, connect this recorder directly to your TV and skip the next step.

**3** Use an RF antenna cable to connect the antenna output on your VCR to the antenna input on your TV.

**4** Connect the **AUDIO and VIDEO OUTPUT** jacks (1 or 2) to a set of audio/video inputs on your TV.

Use the supplied three-pin audio/video cable. It is color-coded to help you match them up (red/white for the right/left audio connections and yellow for video in/outs). Make sure you match up the left and right outputs with their corresponding inputs for correct stereo sound.

**5** Connect your VCR to your TV (A/V IN 2 above) using a set of audio and video cables.

- See the following page if you want to use S-video or component video cables for the video connection.

## Using other types of video output

This recorder has standard (composite), S-video and component video outputs. The main difference between them is the quality of the picture. S-video delivers a better picture than composite video, while component video gives better picture quality still. The variety of outputs also gives you the flexibility of connecting your particular equipment using the best connection type available.

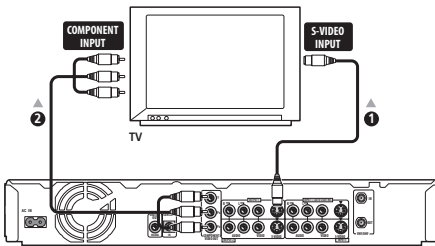

### 1 Connecting using an S-video output

S-video carries the picture as separate color and luminance (brightness) signals.

There are two S-video outputs for connection to TVs, monitors, VCRs or other equipment.

- Use an S-video cable (not supplied) to connect an S-VIDEO OUTPUT (1 or 2) to an S-VIDEO INPUT on your TV, monitor (or other equipment).

### 2 Connecting using the component video output

Component video carries the picture as two separate color signals, plus a luminance (brightness) signal.

See also *Component Video Out* on page 111 for how to set up the component video output for use with a progressive scan-compatible TV.

- Use a component video cable (not supplied) to connect the COMPONENT VIDEO OUT jacks to a component video input on your TV, monitor (or other equipment).

## Connecting to a cable box or satellite receiver (1)

If you are using a cable box or satellite receiver with only a few scrambled channels, follow the setup on this page<sup>1</sup>. If many or all the channels are scrambled, we recommend using the setup on the following page.

Using the setup on this page you can:

- Record unscrambled channels by selecting them on this recorder.
- Record scrambled channels by selecting them on the cable box/satellite receiver.
- Watch one channel while recording another.



### Important

- Do not connect this recorder 'through' your VCR, satellite receiver or cable box. Always connect each component directly to your TV or AV amp/receiver.

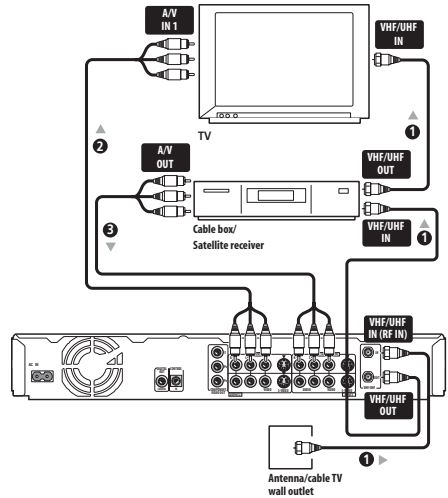

### 1 Connect RF antenna cables as shown.

This enables you to watch and record TV channels.

### 2 Connect the AUDIO and VIDEO OUTPUT jacks (1 or 2) on this recorder to a set of audio/video inputs on your TV using a set of A/V cables (as supplied).

This enables you to watch the output from this recorder.

### 3 Connect the audio/video output of your cable box/satellite receiver to the INPUT 1 jacks on this recorder using a set of A/V cables.

This enables you to record scrambled TV channels.

#### Note

<sup>1</sup> The diagram shows standard video connections, but you can alternatively use the S-video or component video connections if they're available.

## Connecting to a cable box or satellite receiver (2)

If many or all the channels you receive by cable or satellite are scrambled, we recommend using this setup.<sup>1</sup>

Using the setup on this page you can:

- Record any channel by selecting it on the cable box/satellite receiver.

### Important

- Do not connect this recorder 'through' your VCR, satellite receiver or cable box. Always connect each component directly to your TV or AV amp/receiver.

**1 Connect RF antenna cables as shown.**  
This enables you to watch and record TV channels.

**2 Connect the AUDIO and VIDEO OUTPUT jacks (1 or 2) on this recorder to a set of audio/video inputs on your TV using a set of A/V cables (as supplied).**  
This enables you to watch discs.

**3 Connect the audio/video output of your cable box/satellite receiver to the INPUT 1 jacks on this recorder using a set of A/V cables.**  
This enables you to record scrambled TV channels.

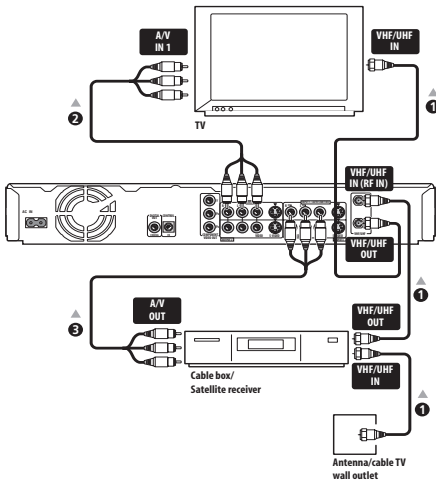

### Note

- The setup on this page does not allow you to watch one channel and record another.
- The diagram shows standard video connections, but you can alternatively use the S-video or component video connections if they're available.

## Connecting to an AV amplifier or receiver

To enjoy multichannel surround sound you need to connect this recorder to an AV amp/receiver using the digital coaxial output. In addition to the digital connection, we recommend also connecting using the stereo analog connection.

You'll probably also want to connect a video output to your AV amp/receiver. Use the standard (composite) video output (as shown here), or the S-video or component video connections.

See also *Audio Out* on page 112 for how to set up the digital audio output. (Noise may be output from your speakers if the recorder is not set up to work with your AV amp/receiver.)



### Important

- Do not connect this recorder to your TV 'through' your VCR or other component using A/V cables. Always connect it directly to your TV.

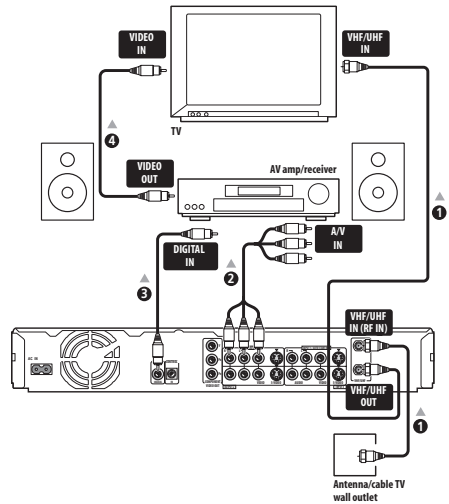

#### 1 Connect RF antenna cables as shown.

This enables you to watch and record TV channels.

#### 2 Connect the AUDIO and VIDEO OUTPUT jacks (1 or 2) on this recorder to a set of audio/video inputs on your AV amp/receiver.

#### 3 Use an coaxial digital audio cable (not supplied) to connect the COAXIAL DIGITAL OUT jack on this recorder to an coaxial digital input on your AV amp/receiver.

This enables you to listen to multichannel surround sound.<sup>1</sup>

#### 4 Connect the AV amp/receiver's video output to a video input on your TV.

### Note

<sup>1</sup> If your AV amp/receiver doesn't have an coaxial digital input, but has an optical type, converter boxes that convert from coaxial to optical are available at specialist audio dealers.

## Connecting other AV sources

### Connecting a VCR or analog camcorder

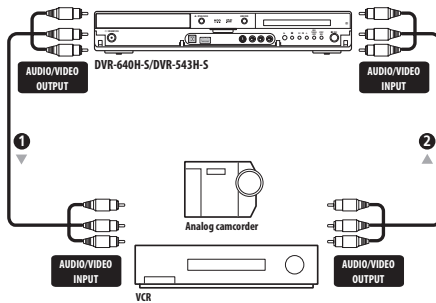

**1 Connect a set of audio and video inputs of your VCR or camcorder to a set of outputs on this recorder.**

This enables you to record from this recorder to your VCR or camcorder.

- You can use standard video or S-video cables for the video connection.

**2 Connect a set of audio and video outputs of your VCR or camcorder to a set of inputs on this recorder.**

This enables you to record tapes from your VCR or camcorder.

- You can use standard video or S-video cables for the video connection.
- The front panel connections make convenient connections for a camcorder input.

## Connecting a USB device

*DVR-640H-S/DVR-543H-S only*

Using the USB ports on the front of the recorder you can connect USB devices such as digital cameras and printers. Please also see the instructions that came with the device you want to connect before using.

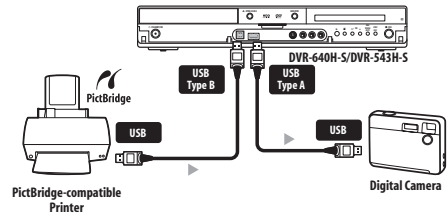

### Important

- Devices may not work reliably if connected to this recorder via a USB hub.

### JPEG file storage devices

- Digital still camera
- Memory card reader (any type of memory card)
- USB memory

The Mass Storage Class (MSC) device should be FAT-compatible. Note that if the device is partitioned, this recorder may not recognize it.

The Picture Transfer Protocol (PTP) can be used to transfer up to about 4000 files.

### WMA/MP3 file storage devices

- Memory card reader (any type of memory card)
- USB memory

The Mass Storage Class (MSC) device should be FAT-compatible. Note that if the device is partitioned, this recorder may not recognize it.

Note that although multi-slot card readers can be used, the recorder will only recognize the first card inserted. To read another card, remove all the cards and insert the card to be read again.

### Using a USB printer

- Use a PictBridge-compatible printer.

## Plugging in

---

After checking all the connections, plug in the recorder.

- 1 Use the supplied power cable to connect this recorder to a power outlet.**



## Chapter 3

# Controls and displays

### Front panel

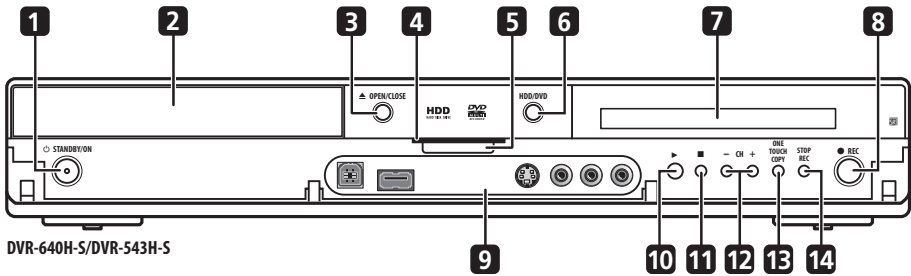

DVR-640H-S/DVR-543H-S

#### 1 STANDBY/ON

Press to switch the recorder on/into standby.

#### 2 **Disc tray**

#### 3 OPEN/CLOSE

Press to open/close the disc tray.

#### 4 **HDD / DVD indicators**

Indicator lights blue when the hard disk (HDD) is selected; orange when the DVD drive is selected.

#### 5 **HELP FUNCTION**

Press to display the on-screen help.

#### 6 **HDD/DVD**

Press to switch between HDD and DVD for recording and playback.

#### 7 **Front panel display and IR remote sensor**

See *Display* on page 28 for details.

#### 8 REC

Press to start recording. Press repeatedly to set the recording time in 30 minute blocks.

#### 9 **Front panel inputs**

See *Front panel connections* on page 17 for more information on these.

#### 10

Press to start or restart playback.

#### 11

Press to stop playback.

#### 12 **CH +/-**

Use to change channels, skip chapters/tracks, etc.

#### 13 **ONE TOUCH COPY** (page 81)

Press to start One Touch Copy of the currently playing title to DVD or the HDD.

#### 14 **STOP REC**

Press to stop recording.

## Remote control

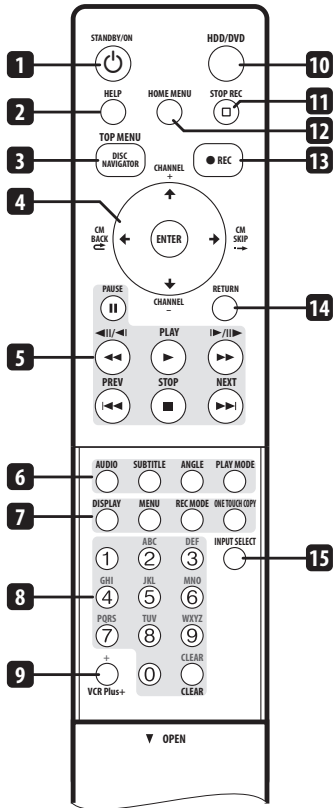

### 1 STANDBY/ON

Press to switch the recorder on/into standby.

### 2 HELP

Press for help on how to use the current GUI screen.

### 3 DISC NAVIGATOR (page 57, 66) / TOP MENU (page 53)

Press to display the Disc Navigator screen, or the top menu if a DVD-Video or finalized DVD-R/-RW (Video) disc is loaded.

### 4 and ENTER

Used to navigate all on-screen displays. Press **ENTER** to select the currently highlighted option.

### CM BACK (commercial back)

Press repeatedly to skip progressively backward through the audio or video playing.

### CM SKIP (commercial skip)

Press repeatedly to skip progressively forward through the audio or video playing.

### CHANNEL +/- (page 36)

Press to change the channel of the built-in TV tuner.

### 5 Playback controls (page 52)

#### PAUSE

Press to pause playback or recording.

#### PLAY (page 52)

Press to start playback.

#### STOP (page 52)

Press to stop playback.

#### 

Press to skip to the previous or next title/ chapter/track/folder; or to display the previous or next menu page.

#### (page 58)

Press to start reverse or forward scanning. Press again to change the speed.

◀||/◀| ▶|/||▶ (page 59)

While paused, press and hold to start slow-motion playback. Press repeatedly to change the playback speed.

While paused, press to advance a single frame in either direction.

## 6 playback function buttons

**AUDIO** (page 36, 63)

Press to change the audio language or channel. (When the recorder is stopped, press to change the tuner audio.)

**SUBTITLE** (page 62)

Press to display/change the subtitles included in multilingual DVD-Video discs.

**ANGLE** (page 64)

Press to switch camera angles on discs with multi-angle scenes.

**PLAY MODE** (page 59)

Press to change the play mode (search, repeat, program play, etc.)

## 7 DISPLAY (page 64)

Displays/changes the on-screen information displays.

**MENU** (page 53)

Press to display the disc menu if a DVD-Video, finalized DVD-R/-RW or finalized DVD+R/+RW disc is loaded.

**REC MODE** (page 37)

Press repeatedly to change the recording mode (picture quality).

**ONE TOUCH COPY** (page 81)

Press to start One Touch Copy of the currently playing title to DVD or the HDD.

## 8 Number buttons, CLEAR

Use the number buttons for track/ chapter/title selection; channel selection, and so on. The same buttons can also be used to enter names for titles, discs and so on.

Use **CLEAR** to clear an entry and start again.

## 9 VCR Plus+®

Press then use the number buttons to enter a PlusCode® programming number for timer recording.

## 10 HDD/DVD (page 37)

Press to select the hard disk (HDD) or DVD for recording and playback.

## 11 □ STOP REC

Press to stop recording.

## 12 HOME MENU

Press to display the Home Menu, from which you can navigate all the functions of the recorder.

## 13 ● REC

Press to start recording. Press repeatedly to set the recording time in blocks of 30 mins.

## 14 RETURN

Press to go back one level in the on-screen menu or display.

## 15 INPUT SELECT (page 47)

Press to change the input to use for recording.

## Display

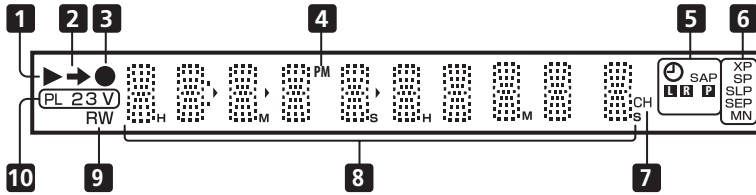

### 1 ▶

Lights during playback; blinks when playback is paused.

### 2 ➡

Lights when copying.

### 3 ●

Lights during recording; blinks when recording is paused.

### 4 PM

Lights to indicate PM (after midday) for the clock display.

### 5 ⌚ (page 38)

Lights when a timer recording has been set. (Indicator blinks if the timer has been set to DVD but there isn't a recordable disc loaded, or the timer has been set to HDD but the HDD is not recordable.)

### SAP

Lights when the currently selected TV channel has a Second Audio Program channel.

### Ⓛ Ⓡ (page 111)

Indicates which channels are recorded when dual mono is selected.

### Ⓜ (page 111)

Lights when the component video output is set to progressive scan.

### 6 Recording quality indicators (page 37)

#### XP

Lights when the recording mode is set to **XP** (best quality).

#### SP

Lights when the recording mode is set to **SP** (standard play).

#### LP / SLP

Lights when the recording mode is set to **LP** (long play) or **SLP** (super-long play).

#### EP / SEP

Lights when the recording mode is set to **EP** (extended play) or **SEP** (super-extended play).

#### MN

Lights when the recording mode is set to **MN** (manual recording level) mode.

### 7 CH (page 36)

Channel indicator for the built-in TV tuner.

### 8 Character display

### 9 R / RW

Lights when a recordable DVD-R or DVD-RW disc is loaded.

### 10 PL (page 66)

Lights when a VR mode disc is loaded and the recorder is in Play List mode.

### **2 3** (page 117)

Shows the remote control mode (if nothing is displayed, the remote control mode is 1).

### **V**

Lights when an unfinalized Video mode disc is loaded.

## Chapter 4

# Getting started

### Switching on and setting up

When you switch the recorder on for the first time, you can make several basic settings using the Setup Navigator feature. This takes you through setting the clock, the internal TV tuner and the video output.

If you're using the recorder for the first time, we strongly recommend you use the Setup Navigator before starting to use the recorder.

#### 1 Switch on your TV and set the video input to this recorder.

STANDBY/ON

#### 2 Switch on the recorder.

When you switch on for the first time, your TV should display the Setup Navigator screen (If the Setup Navigator doesn't appear, you can also access it from the Initial Setup menu; see page 110).

#### 3 Choose a language (then press ENTER).

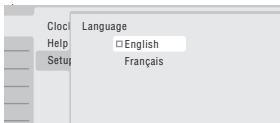

This will also set the audio, subtitle and DVD menu language preferences.

#### 4 Start the Setup Navigator.

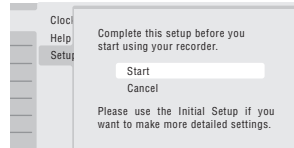

- If you don't want to use the Setup Navigator, press **↓** to select **Cancel**, then press **ENTER** to exit the Setup Navigator.

#### 5 Select 'Antenna' or 'Cable' depending on how you receive your terrestrial TV channels.

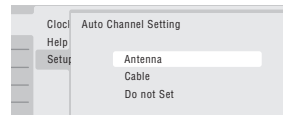

After selecting **Antenna** or **Cable** the recorder starts automatic tuning. This takes a couple of minutes to complete.

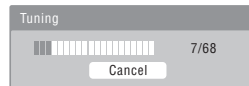

- Select **Do not set** if you want to skip channel setup (because they have already been set up, for example).
- You can go back to the previous screen at anytime in the Setup Navigator by pressing **RETURN**.



- 6** Select 'Auto' for automatic time setting, or 'Manual' to set the clock manually.

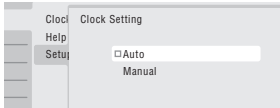

- Auto clock setting**

Some TV channels broadcast time signals together with the program. This recorder can use these signals to set the clock automatically.

**Set 'Clock Set CH' to the channel preset number that broadcasts a time signal, then move the cursor down to 'Start' and press ENTER.**

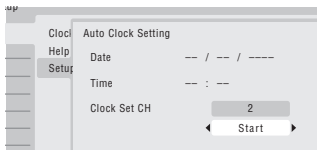

The recorder takes a short while to set the time. After you see that it's set, select **Next** to proceed.

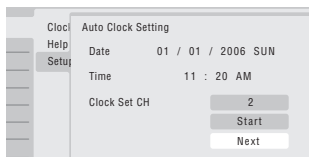

If the time could not be set automatically, press **RETURN** to go back to the previous screen and select **Manual**.

- Manual clock setting**

If no stations in your area are broadcasting time signals, you can set the clock manually.

**Use the ←/→ buttons to set your time zone.**

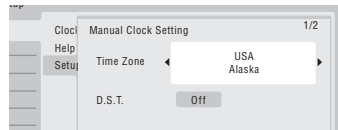

**Press ↓ then use the ←/→ buttons to set 'On' or 'Off' for daylight saving (D.S.T), then press ENTER.**

Select **On** if you are currently using daylight saving.

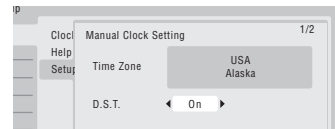

**Set the date (month/day/year) and time, then press ENTER to make all the settings.**

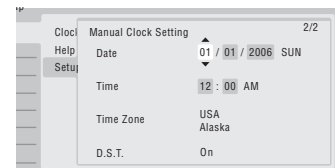

- Use the ↑/↓ buttons to change the value in the highlighted field.
- Use the ←/→ buttons to move from one field to another.
- Press **ENTER** to finish setting the time.



- 7** Select the TV screen type, 'Wide (16:9)' or 'Standard (4:3)'.

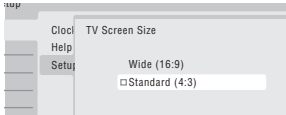

- 8** Select whether or not your TV is compatible with progressive scan video.



- Note that progressive scan video is only output through the component video outputs.



- 9** Press to continue after reading the HDD caution.

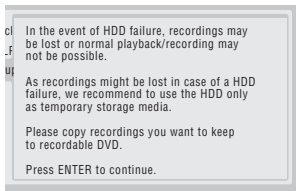

- 10** Select 'Finish Setup' to exit the Setup Navigator, or 'Go Back' if you want to start again.

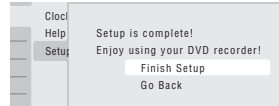

That completes basic setup using the Setup Navigator.

- If there are blank channels with no station, you can set these to skip using the manual channel setting. See *Manual CH Setting* on page 111.



## Chapter 5

# Recording

### About DVD recording

This recorder can record to DVD-R, DVD-RW, DVD+R, DVD+RW, DVD-RAM, DVD-R DL and DVD+R DL media.

DVD-R and DVD-RW discs can be initialized for *Video mode* or *VR mode* recording. Each has its advantages, and it depends on what you want to do with the recording which mode you choose.

If you want to edit your recordings in any significant way, VR mode offers greater possibilities for cutting, copying, and changing the way the video is presented.

Video mode is less flexible when it comes to editing, but it has the advantage that it is compatible with standard DVD players (many of which won't play VR mode discs<sup>1</sup>).

Once a disc is initialized for a particular mode, all recording on that disc will be in that mode.

DVD+RW discs can be initialized for *+VR mode* recording.

DVD-RAM discs can be initialized for VR mode recording.

DVD+R discs do not require initializing.



#### Important

- The table below shows the maximum number of titles recordable per disc and the maximum number of chapters per title:

Disc type/rec. format	Max. titles (per disc)	Max. chapters (per title)
DVD-R/-RW Video mode	99	99
DVD-R/-RW/-RAM VR mode	99	999 <sup>*1</sup>
DVD+R/+RW	49	99 <sup>*2</sup>

<sup>\*1</sup> A maximum of 999 chapters are recordable per disc.

<sup>\*2</sup> A maximum of 254 chapters are recordable per disc.

- This recorder cannot play or record unfinalized Video mode and DVD+R discs recorded on another recorder. DVD+RW discs recorded on another recorder are playable on this recorder but are not recordable.
- The maximum continuous recording time for one title is eight hours when using a DVD+R/+RW disc.
- If you delete a title from a DVD+R/+RW disc, the total number of recordable titles remaining may not increase.
- Fingerprints, dirt and small scratches on a disc can affect playback and/or recording performance. Please take proper care of your discs.

#### Note

<sup>1</sup> Some DVD players, such as some Pioneer models, are compatible with VR mode discs. Check the operating instructions for your player for VR mode compatibility information.

- Pioneer takes no responsibility for recording failure due to power cuts, defective discs, or damage to the recorder.
- See also *Disc / content format playback compatibility* on page 9 for detailed disc compatibility information.

### Recording to DVD-R DL/DVD+R DL discs

Recording to DVD-R DL/DVD+R DL discs is generally the same as recording to regular single-layer discs; however, please note the following points:

- When the recorder switches from the first layer to the second during recording a DVD-R DL (Video mode) disc, a new title is automatically started on the new layer.
- Up to 99 titles can be recorded on a DVD-R DL (Video mode) disc. If the 99th title is being recorded when the layer is switched, recording will stop.
- Up to 49 titles can be recorded on a DVD+R DL disc.
- You cannot play, record additional material to, edit or finalize a DVD-R DL or DVD+R DL disc that has been recorded on but not yet finalized on another DVD recorder.

### About HDD recording

Recording to the internal hard disk drive (HDD) is very flexible; you have the full choice of recording quality options, including manual mode, and of course you can record, erase and re-record as many times as you like.

The capacity of the hard disk drive means that you can store many hours of video on it, even using the higher quality recording modes.



#### Important

- The maximum number of titles/chapters per title that can be recorded on the HDD is 999 and 99 respectively. No more recording is possible on the HDD after the maximum number of titles has been reached.
- The maximum continuous recording time for one title is 12 hours.

### HDD Video mode compatibility

When recording to the HDD you can choose to record in one of two formats. Set the format from the HDD Recording Format item in the Initial Setup menu (see page 115).

When set to Video Mode On, high-speed copying from HDD to Video mode DVD-R/-RW or DVD+R/+RW is possible. When recording a broadcast with a Secondary Audio Program (SAP) channel, set which channel you want to record from the Initial Setup menu (see *Dual Mono Recording* on page 111).

When HDD Recording Format is set to Video Mode Off, high-speed copying isn't possible. However, both the main and SAP channels are recorded and you can switch the audio on playback.

### Recorded audio

In all except the **LPCM** mode, sound is recorded in two channel Dolby Digital format (only *Dolby Digital 2.0* can be recorded; *Dolby Digital 5.1* recording is not possible). When

set to **LPCM**, sound is recorded in high quality, uncompressed Linear PCM format. If the broadcast audio has a SAP channel and you are recording to Video mode DVD-R/-RW, DVD+R/+RW, or to the HDD with the HDD Recording Format set to Video Mode On, or on the **LPCM** setting, use the **AUDIO** button to select the **Mono**, **Stereo** or **SAP** audio channel to record before recording starts. In other cases, if SAP is selected then both the main and SAP audio channels will be recorded and you can switch on playback. The table below shows the different audio output possibilities:

Audio setting	Audio output	
	Left (L)	Right (R)
<b>MONO</b>	L + R	L + R
<b>STEREO</b>	L	R
<b>SAP</b>	L + R	SAP

## Restrictions on video recording

You cannot record copy-protected video using this recorder. Copy-protected video includes DVD-Video discs and some satellite broadcasts. If copy-protected material is encountered during a recording, recording will pause automatically and an error message will be displayed on-screen.

Video that is 'copy-once only' can only be recorded to HDD, CPRM-compatible VR mode DVD-R/-RW (see below), or DVD-RAM.

When recording a TV broadcast or through an external input, you can display copy control information on screen (see *Displaying disc information on-screen* on page 64).

## CPRM

CPRM is a copy protection/scrambling system developed for the recording of 'copy once' broadcast programs. CPRM stands for *Content Protection for Recordable Media*.

This recorder is CPRM compatible, which means that you can record copy-once broadcast programs, but you cannot then make a copy of those recordings. CPRM recordings can only be made on CPRM-compatible DVD-R (ver. 2.0 / 8x or higher) or DVD-RW (ver. 1.1 or higher) discs formatted in VR mode, DVD-RAM discs or on the HDD. DVD CPRM recordings can only be played on players that are specifically compatible with CPRM.

## Recording equipment and copyright

You may use this product only to reproduce or copy materials for which you own the copyright or have obtained permission to copy from the copyright owner or for which you otherwise have a legal right to reproduce or copy. Unless you own the copyright or have obtained permission from the copyright owner or otherwise have a legal right to reproduce or copy, you may be violating the law, including copyright law, and may be subject to payment of damages and other remedies.

*This product incorporates copyright protection technology that is protected by method claims of certain U.S. patents and other intellectual property rights owned by Macrovision Corporation and other rights owners. Use of this copyright protection technology must be authorized by Macrovision Corporation, and is intended for home and other limited viewing uses only unless otherwise authorized by Macrovision Corporation. Reverse engineering or disassembly is prohibited.*

## Using the built-in TV tuner

There are three different ways to select TV channels. Note that you can't change the TV channel during playback, recording or during recording standby.



- **CHANNEL +/- buttons**



- **Number buttons**

For example, to select channel 4, press **4** then **ENTER**; for channel 34, press **3**, **4**, **ENTER**.<sup>1</sup>

- **CH +/- buttons** on the front panel

## Changing cable channels

When a cable box is connected, you can use the remote to change cable channels (up to 999).

*If your cable box is connected to the RF antenna input on this recorder:*



- Use **CHANNEL +/- buttons** or **Change the cable channel.**

In this case, you can't change the channel of the built-in tuner.

*If your cable box is connected to a set of AV inputs:*



- 1 **Select the cable box input.**



- 2 Use **CHANNEL +/- buttons** or **Number buttons** to change the cable channel.

## Changing audio channels

Some TV programs are broadcast with both a main and a Second Audio Program (SAP). You can change the TV audio using the **AUDIO** button.

- **AUDIO** **Press to change the audio type.**

The current audio channel is displayed on-screen.

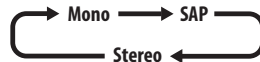

- If **SAP** is selected, but there is no SAP channel being broadcast, you will still hear the main audio channel.
- If the sound is poor quality when set to **Stereo**, you can often improve it by changing to **Mono**.

### Note

- When recording to the HDD with HDD Recording Format set to Video Mode On, to DVD in Video mode, or on the **LPCM** setting, only one channel of a dual mono broadcast is recorded. In this case, decide which language you want to record before recording by setting the Dual Mono Recording setting (see *Dual Mono Recording* on page 111).

### Note

1 Antenna channels are numbered 2 through 69. Cable channels are numbered 1 through 125.

## Setting the picture quality/recording time

DVD (VR) DVD (Video) DVD+R DVD+RW DVD-RAM

HDD

Before starting a recording, you will usually want to set the picture quality/recording time. There are six standard settings available, which allow you to choose a balance between picture quality and recording time.

When Manual Recording is set to On (see *Manual Recording* on page 114), a further option will be available (**MN1 to MN32** or **LPCM**, depending on what you set).

When recording to DVD+R/+RW, **SLP** is the longest recording time available. If you select **SEP** or **MN1 to MN3**, the recording mode will automatically revert to **SLP**.

**REC MODE**  
 **Press repeatedly to select the recording quality.**

- **XP** – High quality setting, gives about one hour of recording time on a DVD disc.
- **SP** (Standard Play) – Default quality, used for most applications, gives about two hours of recording time on a DVD.
- **LP** (Long Play) – Lower video quality than SP, but doubles the recording time on a DVD to about four hours.
- **EP** (Extended Play) – Lower quality than LP, but gives about six hours of recording time on a DVD disc.
- **SLP** (Super Long Play) – Lower quality than EP, but gives about eight hours of recording time on a DVD disc.

- **SEP** (Super Extended Play) – Lowest video quality but gives about ten hours of recording time on a DVD disc.
- **MN1 to MN32 / LPCM**<sup>1</sup> – Manual / Linear PCM (available only when manual recording is on)

The setting is indicated in the front panel display, and shown on-screen together with the recording time for a blank recordable disc. If a recordable disc is loaded, the approximate remaining recording time for that disc is also shown. (Note that if the On Screen Display setting (see *On Screen Display* on page 117) is **Off** then this information is not displayed.)

## Basic recording from the TV

DVD (VR) DVD (Video) DVD+R DVD+RW DVD-RAM

HDD

Basic recording from the TV involves just setting the channel to record, choosing whether to record to the HDD or a DVD and selecting the recording quality.

**HDD/DVD**  
 **1 Select the HDD or DVD for recording.**

- If you're recording to DVD, load a recordable disc (if you load a new blank DVD-RW or DVD+RW disc, the recorder takes a short while to initialize the disc).
- If you want to record a VR mode DVD-R or a Video mode DVD-RW, you must initialize it before proceeding (see *Initializing recordable DVD discs* on page 51).

### Note

<sup>1</sup> Audio is recorded in 16-bit Linear PCM format, video is recorded at XP quality. When recording a broadcast with a SAP channel select which audio channel to record (see *Dual Mono Recording* on page 111).



## 2 Select a TV channel to record.

The front panel display shows the channel number:



- While the recorder is stopped, you can also use the number buttons on the remote to select the channel. (For channel 24, press **2, 4** then **ENTER**)
- If the recorder is stopped, you can also use the **CH +/-** buttons on the front panel to select the channel number.

## 3 Set the picture quality/recording time.

- See *Setting the picture quality/recording time* on page 37 for detailed instructions.

## 4 Select the audio channel to record.

See *Changing audio channels* on page 36 for more on this.

- When recording in VR mode (DVD) or with HDD Recording Format set to Video Mode Off (HDD), both mono and SAP audio channels are recorded, allowing you to switch the audio channel on playback. The only exception to this is when the picture quality is set to **LPCM**, in which case you do need to select the audio channel before recording.

## 5 Start recording.

If you want to set a recording end time, press the **● REC** button repeatedly. The recording time increases in 30 minute increments, up to a maximum of six hours. The time the recording will end is shown on-screen and in

the front panel display. When the recording ends, the recorder automatically switches into standby if no other operation is being performed.

- To cancel the set recording time, press **● REC**.
- If you want to pause recording at any time, press **II PAUSE**. Press again to restart the recording. (If recording to the HDD, DVD-RAM or in VR mode, a new chapter is started after recording restarts)

**STOP REC**



## 6 Press to stop recording.

- If you set the recording time in the previous step, you can still stop the recording anytime by pressing **STOP REC**.
- Recording will stop automatically when there is no more space on the HDD/DVD, or after 12 hours of HDD recording (whichever is sooner).

## Setting a timer recording

### **ALL**

Using the timer recording features you can program up to 32 timer recordings up to a month in advance. Timer recording programs can be set to record just once, every day, or every week.

There are three ways to set a timer recording; using the Easy Timer Recording feature (see *Easy Timer Recording* on page 39), using the VCR Plus+ programming system (see *Timer recording using the VCR Plus+®\** programming system on page 40), or using manual timer recording (see *Setting a manual timer recording* on page 42).

You can set the recording quality for your timer recording in the same way as for a regular recording, but with the added option of an **AUTO** mode, which maximizes the recording quality for the space available on the disc (if recording to DVD), or to fit on to a blank DVD disc (if recording to HDD).

You can set timer recordings to record to a recordable DVD or to the hard disk drive. For regular (daily or weekly) HDD timer recordings that you don't need to keep, you can use the Auto Replace Recording feature to automatically replace the previous timer recording with the new one. Note that when you use this feature, the previous recording made on that timer program will be replaced by the next one, regardless of whether you have watched it yet or not.

You can also set the recorder so that it will adjust the recording quality to try and fit the recording on to the disc if it would not otherwise fit at the recording quality you set (see *Optimized Rec* on page 114 for more on this).

Finally, if you set a timer recording to record to DVD but there isn't a recordable DVD loaded at the time of the recording, the Recovery Recording feature will automatically record the program to the HDD for you.





### Important

- A timer recording can't be set if there are already 32 timer programs waiting to be recorded.
- Timer recording will not start if:
  - The recorder is already recording.
  - A disc is being initialized, finalized or unfinalized.
- Timer recording will start when the operation preventing timer recording has finished.

- The timer indicator (⊕) lights in the front panel display when the timer is active. If the indicator is blinking it means that (for a DVD timer recording) there is no disc loaded, or the disc loaded is not recordable (for an HDD timer recording it means that the HDD is not recordable).
- Approximately two minutes before a timer recording is set to start, the recorder will go into timer recording standby. In timer recording standby you cannot use some functions.
- The maximum length for timer recordings made to the HDD is 24 hours. However, because one title (HDD) is limited to 12 hours, recordings over 12 hours will be spread over two titles. Note that there will be a break in the recording of a few seconds between titles.

## Easy Timer Recording

As the name suggests, Easy Timer Recording makes setting up a timer recording as simple as possible.

- 1  Select 'Timer Recording' then 'Easy Timer' from the Home Menu.
- 2   Set the TV channel to record.

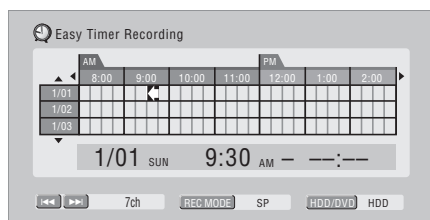

- 3  Set the recording quality.

- **DVD recording:** The **AUTO** option automatically sets the best recording quality for the space available on the disc loaded at the time of recording.
- **HDD recording:** The **AUTO** option automatically sets the best recording quality that would fit on to a blank DVD disc.

4  Select the HDD or DVD for recording.

5  Move the cursor to the recording start date and time on the grid.

- You can move the cursor forward or back an hour at a time using the ◀◀ and ▶▶ buttons.

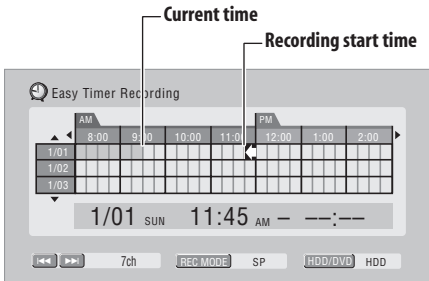

Each row of the grid is one day (you can set the timer recording for up to a month in advance). Each column is a 15 minute interval.

The darker area represents time that has already passed and can't therefore be selected. The lighter area is time that's available.

6  Set the start time.

The start date and time is displayed in the middle of the screen.

- You can go back and reset the start time if you need to by pressing **RETURN**.

7  Move the cursor to the recording end time on the grid.

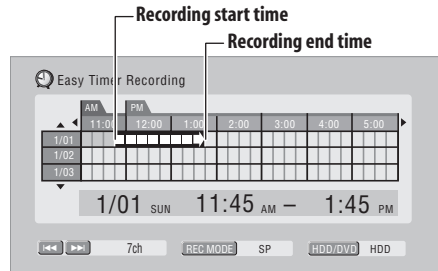

As you move the cursor around the grid, an arrow stretches from the start time to the current cursor position, representing the length of the recording. A recording of up to six hours can be set.

8  Set the end time.

9  Select 'Yes' to set the timer recording and exit, or 'No' to go back to the Easy Timer Recording screen.

- You can check the timer recording details you just set from the main timer recording screen (see *Setting a manual timer recording* on page 42).

## Timer recording using the VCR Plus+®\* programming system

This system makes programming timer recordings very simple. Most TV guides publish PlusCode programming numbers with their program details. If you want to make a timer recording of a program, you



just input the corresponding code. The date, start, stop and channel settings are made automatically. All you have to do is tell the recorder the recording mode, and whether it's a once-only recording or a regular recording.

*\*VCR Plus+ and PlusCode are registered trademarks of Gemstar Development Corporation.*

*The VCR Plus+ system is manufactured under license from Gemstar Development Corporation.*

### 1 Press 'VCR Plus+' to display the VCR Plus+ program screen.

You can also access this screen from the Home Menu (press **HOME MENU**, select **Timer Recording**, then **VCR Plus+**).

PlusCode#			
-----			
1	2	3	
4	5	6	Cancel
7	8	9	Details
0	Clear	Enter	

- Use the number buttons to enter the PlusCode number. (To clear the last digit entered, press **CLEAR**.)
- You can also use the **↑/↓/←/→** buttons to select digits from the on-screen display.

### 2 After making the settings, select 'Enter' and press ENTER.

The timer recording screen appears with the timer program you just set.

### 3 Confirm that the settings are correct.

If the channel number isn't displayed, use the **←/→** buttons to highlight **CH**, then use the **↑/↓** buttons to set the correct channel number.

- If the channel number is set, but incorrectly, set up the guide channel (see *VCR Plus+ CH Setting* on page 111).

### 4 Select 'Store Program' to finish.

- Other options in the same menu panel allow you to name the program, and change the recording destination and/or recording mode.

## Checking/editing timer recording settings

You can check and/or edit the timer recording settings made by the VCR Plus+ system by selecting **Details** from the PlusCode# setting screen.



### 1 Select 'Details' from the PlusCode# setting screen.

The Timer Program Set screen appears, filled out with the timer recording details.

### 2 Check and edit the fields as necessary.

See *Setting a manual timer recording* on page 42 for more on this.



### 3 Select 'Store Program' to save the timer program and exit.

## VCR Plus+ programming with the power off

You can enter a PlusCode programming number when the recorder is in standby.

Note that the recording is always made to the HDD. If you want to record to a DVD disc, you'll need to switch on the power and use the full VCR Plus+ program screen.



### Important

- You can't use this feature until you have set up the guide channels. see *VCR Plus+ CH Setting* on page 111.
- You can't change the recording mode.
- You can't program daily or weekly timer recordings.

### 1 Press 'VCR Plus+'.

The front panel display shows the current recording mode and prompts you to enter the PlusCode programming number.

PLUSCODE

### 2 Use the number buttons to enter the PlusCode number.

123456

- To clear the last digit entered, press **CLEAR**.

### 3 Press ENTER.

The display shows the timer settings:  
Date → Start time → End time → HDD and Recording channel → Recording mode.

- If **CODE ERROR** appears in the display, check that the number is correct and that the guide channel is set (see *VCR Plus+ CH Setting* on page 111), then set the timer recording again.

- If **CAN'T SET** appears in the display, it means that although you entered a valid PlusCode number, the program has already finished.

## Setting a manual timer recording

The timer recording screen you can see all the timer programs already set, clear programs and set up new ones.

### 1 Press HOME MENU, select Timer Recording, then Timer Recording.

This screen shows all the timer programs currently set.

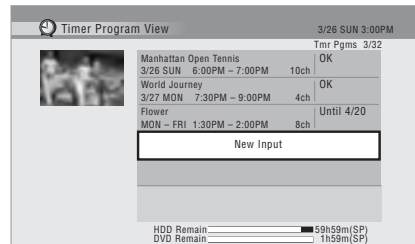

- Each row is for one timer recording program, with the date and time information, channel, recording mode, DVD or HDD and recording status.
- The amount of free space available on the HDD and the currently loaded recordable DVD is shown towards the bottom of the screen.
- In the upper-right corner, the number of timer programs already set is shown next to **Tmr Pgms**.
- If there are more than five timer programs already set, press **NEXT** ►► to switch page (go back using the **PREV** ◄◄ button).
- You can also delete a timer program before it's started (before the recorder enters timer recording standby) by highlighting it and pressing **CLEAR**. See

also *Deleting a timer program* on page 44.

## 2 Select 'New Input' to set a new timer program, then press ENTER.

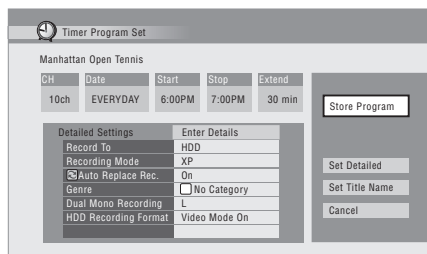

## 3 Enter the timer recording settings.

Use the  $\leftarrow/\rightarrow$  buttons to select a field; use the  $\uparrow/\downarrow$  buttons to change the value.

- **CH** – Choose a channel (2 to 69 for antenna channels; 1 to 125 for cable, excluding skip channels), or one of the external inputs from which to record.
- **Date** – Choose a date up to one month in advance, or select a daily or weekly program.
- **Start** – Set the recording start time.
- **Stop** – Set the recording end time (maximum length of a timer recording is 24 hours).
- **Extend** – Extend the end time of the timer recording (select **Off**, **30**, **60**, **90** or **120** mins).

## 4 If you want to change the recording mode, recording destination, etc., select 'Set Detailed'.

In this area you can set:

**Record to** – Select **HDD** for hard disk recording or **DVD** for DVD recording. Select **HDD** for Auto Replace Recording (daily or weekly timer recording only).

**Recording Mode** – Select **XP**, **SP**, **LP**, **EP**, **SLP** or **SEP**. (See *Setting the picture quality/recording time* on page 37). If Manual Recording is on, then you can also select the **LPCM** setting, or **MN** (press **ENTER** then use the  $\leftarrow/\rightarrow$  buttons to select the level).

**Auto Replace Rec.** – automatically erases the previous daily or weekly recording when the next one is recorded.

**Genre** – Select a record genre (for HDD recording only).

**Dual Mono Recording** – Select which channel of a dual mono broadcast to record (necessary if recording to a Video mode DVD).

**HDD Recording Format** – Select **Video Mode On** or **Video Mode Off** depending on whether you need high-speed copying to Video mode DVD capability or not.

## 5 After entering all the timer recording information, highlight 'Store Program' and press ENTER.

The timer recording list screen is displayed again. The timer program you just input appears in the list. The rightmost column shows various timer recording status messages:

- **OK** – Can be recorded.
- **Time Over** – Not enough space on the HDD (the recording won't finish).
- **Over 12h** – Recording time of over 12 hours set (when recording to the HDD the recording will be split into two titles).
- **Overlap** – Two timer programs partially or completely overlap. The one starting earlier will take priority.
- **Until ...** (e.g., **Until 8/13**) – For a regular recording, the last program that could be recorded is shown.
- **Data Over** – Can't record because the disc management area of the disc is full.

- **Cancel Once** – A regular timer program is set to skip.
- **Can't Rec** – Not possible to record.
- **Title Over** – Can't record because there is already the maximum number of titles on the disc (HDD: 999; DVD: 99).
- **Recording** – The program is currently recording.
- **Standby** – The recorder is in timer recording standby.
- *nothing displayed* – Another timer recording or copying is in progress.

## 6 To exit the timer recording screen, press HOME MENU.



### Tip

- To enter a title name for the timer recording in advance, select **Set Title Name** and follow the on-screen display.



### Note

- If you set a DVD timer recording but there is no recordable DVD disc loaded, or the disc loaded doesn't have enough free space for the complete recording, **Recovery** is shown. In this case (unless you load a suitable disc before the recording actually starts), the recorder will use the HDD for recording. (The message **Can't Rec** will appear if there are already 999 titles on the HDD or if there is not enough free space on the HDD for recording.)
- For a DVD timer recording, if **Optimized Rec** (see *Optimized Rec* on page 114) is set to **On**, the recorder will adjust the recording quality to try and fit the recording on the disc. If the recording will not fit onto the disc even on **MN1** (**MN4** for DVD+R/+RW) recording

quality then the Recovery Recording feature will automatically make the recording to the HDD instead.

- If there is very little free space left on the HDD, an Auto Replace Recording may not complete successfully.
- If the HDD is being used for playback or high-speed copying when an Auto Replace Recording is due to start, the new timer recording will not replace the old one. However, the next time the timer recording starts, both of the older two programs will be erased.

## Editing a timer program

You can change any of the settings in a timer program before the recording is due to start.

**1 Press HOME MENU, select Timer Recording, then Timer Recording.**

**2 Highlight the timer program you want to change.**

**3 Press → then select 'Modify' from the command menu panel.**

Alternatively, press **ENTER**.

The Timer Program Set screen appears from which you can edit the settings.

**4 Edit the timer recording settings as necessary.**

**5 Select 'Store Program' to finish.**

Confirm the settings you made from the following screen.

## Deleting a timer program

You can delete timer programs you no longer need.

**1 Press HOME MENU, select Timer Recording, then Timer Recording.**

2 Highlight the timer program you want to erase.

3 Press **→** then select 'Erase' from the command menu panel.

- Select **Yes** to confirm or **No** to cancel.
- You can also just press **CLEAR** when the timer program is highlighted.

### Skipping a regular timer program

If you've set a regular daily or weekly timer program, you can set the recorder to skip the next scheduled recording.

1 Press **HOME MENU**, select **Timer Recording**, then **Timer Recording**.

2 Highlight the timer program you want to skip.

3 Press **→** then select 'Cancel Once' from the command menu panel.

- In the timer program list, **Cancel Once** appears by the program.
- You can also just press **II** when the timer program is highlighted.

### Extending a timer recording in progress

You can extend a timer recording beyond the programmed end time in two different ways. This can be useful if a broadcast program overruns, for example.

#### Canceling or extending the timer

1  Press and hold for three seconds during a timer recording.

Recording continues, but the timer indicator disappears from the front panel display indicating that the timer has been canceled.

2  Press repeatedly to extend recording in 30 minute blocks.

### Programming a new end time

You can edit the end time of a timer recording you have previously set.

1  Select 'Timer Recording' then 'Timer Recording' from the Home Menu.

2  Highlight the timer recording you want to change.

3  Press **→** then select 'Modify' from the command menu panel. Alternatively, press **ENTER**.

The Timer Program Set screen appears, from which you can edit the settings.

4  Edit the end time as necessary.

You can also edit the **Extend** time parameter.

5  Select 'Store Program'.

6  Press to exit the Timer Recording screen.

### Stopping a timer recording

1  Press during a timer recording.

2  Select 'Yes' to confirm.

## Preventing use of the recorder before a timer recording (child lock)

You can make all the front panel and remote control buttons inoperative using the child lock feature. This is useful when you set a timer recording and want to make sure that the timer settings are not changed before recording has finished.

STANDBY

1  If the recorder is on, switch it into standby.

2  (front panel) Press and hold for three seconds to lock the controls.

The front panel display briefly shows **LOCK**. If any buttons are pressed on the remote or front panel, **LOCK** is briefly displayed again.

- To unlock the recorder, press and hold  **STOP** on the front panel (while the recorder is stopped) for three seconds until the display shows **UNLOCK**.

## Timer recording FAQ



### Frequently Asked Questions

- *Even though the timer is set, the recorder doesn't start recording!*

Check that the disc loaded or HDD is recordable, not locked (see *Lock Disc* on page 103), and that there are fewer than 99/999 titles already on the DVD/HDD.

- *The recorder won't let me enter a timer program! Why not?*

You can't enter a timer program if the clock isn't set.

- *What happens when two or more timer programs overlap?*

Basically, the program with the earlier recording start time has priority. However, the recorder will start recording the program with the later start time after the earlier program is finished. If two programs have the same times (but different channels, for example), the program set most recently takes priority.

## Simultaneous recording and playback (Chase Play)



Chase Play allows you to watch a recording that is still in progress from the start, without having to wait until the recording has finished (i.e., playback is 'chasing' the recording).

In fact, you're not just limited to watching the recording in progress. You can watch anything else already on the HDD (or on a DVD if you're recording to the HDD) by selecting it from the Disc Navigator screen (see *Using the Disc Navigator with recordable discs and the HDD* on page 57).

-  Press during recording to start playback from the beginning of the current recording<sup>1</sup>.

### Note

<sup>1</sup> You can't start playback immediately after recording starts. Simultaneous playback and recording doesn't work while copying or backing up.

-  **Press during recording to select another title to play.**

You can use all the usual playback controls, such as pause, slow-motion play, scan and skip.

- To stop playback, press **■ STOP** (recording will continue).
- To stop recording, press **STOP REC** (playback will continue).

## Recording from an external component

DVD (VR) DVD (Video) DVD+R DVD+RW DVD-RAM



You can record from an external component, such as a camcorder or VCR, connected to one of the recorder's external inputs.

- 1 **Make sure that the component you want to record from is connected properly to the DVD recorder.**

See Chapter 2 (*Connecting up*) for connection options.

- 2  **Press repeatedly to select one of the external inputs to record from.**

There are three analog inputs. The current input is shown on-screen and in the front panel display:

- **L1** – INPUT 1/AUTO START REC
- **L2** – INPUT 2 (front panel)
- **L3** – INPUT 3

### Note

- <sup>1</sup> You can't set Auto Start Recording when:
- the recorder is recording or in timer recording standby.
  - the HDD is not recordable.
  - the HDD already contains the maximum number of titles (999).

Check that the **Audio In** settings for **External Audio**, and **Dual Mono Recording** are as you want them (see *Audio In* on page 111).

- If the aspect ratio is distorted (squashed or stretched), adjust on the source component or your TV before recording.

- 3  **Set the recording quality.**

- See *Setting the picture quality/recording time* on page 37 for detailed information.

- 4  **Select the HDD or DVD for recording.**

- 5  **Press to start recording.**

- If your source is copy-protected using Copy Guard, you will not be able to record it. See *Restrictions on video recording* on page 35 for more details.

## Automatic recording from a satellite tuner



If you have a satellite tuner or some other kind of set top box connected to the **INPUT 1/AUTO START REC** input, you can have the recorder start and stop recording automatically with the timer settings of the connected component. (If the other component doesn't have a built-in timer, you'll need to use it with an external timer unit.)<sup>1</sup>

After setting up for Auto Start Recording, this recorder starts recording when it detects a signal from the other component. When the signal ceases, the recorder stops recording.

If you want to use this recorder with the timer features of your satellite tuner, see *Additional information for cable/satellite/STB (set-top box) users* below.



### Important

- It takes a little while for this recorder to switch on and start recording after detecting a signal. Please bear this in mind when setting the timer.
- If Auto Start Recording is set, it will not start if another timer recording is in progress.
- Timer recordings take precedence over Auto Start Recording. Auto Start Recording will stop if a timer recording is due to start. After the timer recording has finished, Auto Start Recording will resume.

#### 1 Set the timer for the satellite receiver (or other component), then switch it into standby (if necessary).

Check the manual that came with the receiver if you're not sure how to do this.

#### 2 Check that the 'Audio In' settings for 'External Audio' and 'Dual Mono Recording' are as you want them.

See *Audio In* on page 111 for more on these settings.

#### 3 Set up the recorder.

- Use **REC MODE** to set the recording quality. See *Setting the picture quality/recording time* on page 37 for detailed information.

#### 4 Select 'Timer Recording', then 'Auto Start Recording' from the Home Menu.



#### 5 Select 'Yes' to switch Auto Start Recording on, or 'No' to switch off.

If you choose 'Yes' the recorder automatically goes into standby.

The **AUTO** indicator in the front panel display lights.

The recorder will automatically switch on and start recording when the other component comes on. Recording stops when the external component switches off.

- To cancel Auto Start Recording, press **STANDBY/ON** while the recorder is in standby. The **AUTO** indicator goes off.
- To cancel Auto Start Recording once recording has already started, press **REC** for three seconds (this cancels Auto Start Recording, but recording continues), then **STOP REC** to stop recording.
- You can also stop recording by pressing **STOP REC** then selecting **Yes** to confirm.



### Tip

- Alternatively, with no OSD displayed, press and hold the front panel **STOP REC** button for more than three seconds to switch Auto Start Recording on directly. After switching on, switch the recorder into standby (step 6).



### Additional information for cable/satellite/STB (set-top box) users

The following instructions show how to use the timer features of your STB with this recorder.

#### Setting up

**1 Connect the STB's audio/video outputs to a set of audio/video inputs on this recorder.**

**2 Switch on both the STB and this recorder and switch the recorder's input function to the STB (L1, L2 or L3).**

To check that everything is connected properly, switch on your TV and select this recorder as the video input. You should see whatever the STB is tuned to.

**3 Program the IR controller supplied with your STB to send start/stop recording codes for a Pioneer VCR.**

See the manual that came with the STB for how to do this.

Only the **REC** and **STOP** codes have any effect when used with this recorder:

- **REC** – Start recording
- **STOP** – Stop recording

**4 Position the IR controller so that it will control this recorder.**

The IR sensor on the recorder is located just above the  mark on the front panel.

#### Making a timer recording

**1 Set the timer on the STB.**

See the manual that came with your STB for how to do this.

**2 Switch on this recorder.**

You must leave the recorder on until the recording finishes.

- At the programmed times, the STB will start and stop recording on this recorder.

## Playing your recordings on other DVD players

Most regular DVD players can play finalized discs recorded in Video mode and DVD+R discs. A number of players (including many Pioneer models) can also play DVD-RW discs recorded in VR mode, finalized or not. Most players will not play VR mode DVD-R discs, although some DVD-ROM drives and DVD recorders may be able to (finalization might be necessary). Check the manual that came with the player to check what kinds of discs it will play.

When you finalize a Video mode or DVD+R disc, a title menu is created from which you can select titles when you play the disc. There are a number of different styles of title menu to choose from to suit the content of the disc.

All the title menus are navigated in the usual way, pressing **MENU** or **TOP MENU** to display the menu, then using the **↑/↓/←/→** followed by **ENTER** to select titles and start playback.

### Finalizing a disc

Finalizing 'fixes' the recordings on the disc so that it can be played on a regular DVD player or computer equipped with a suitable DVD-ROM drive.

Note that the disc name will appear in the title menu after you finalize a disc. Make sure the disc name is as you want it before you finalize the disc as it can't be changed afterwards. If you want to rename the disc, see *Input Disc Name* on page 103 before starting the steps below.

DVD+RW discs don't generally need finalizing. However, if you want a title menu to appear when you play the disc, then you will need to finalize. When using a DVD+RW, you can still record and edit even after finalizing, although the title menu will disappear if you do so. Finalize the disc again to generate a new title menu.



### Important

- Once you've finalized a Video mode or DVD+R disc, you can't edit or record anything else on that disc. However, the finalization on a DVD-RW disc maybe 'undone'; see *Undo Finalize* on page 104 for how to do this.
- A VR mode DVD-R/-RW (excluding DVD-R DL) disc can still be recorded and edited on this recorder even after finalizing.
- Video mode DVD-R DL discs and DVD+R DL discs must be finalized in order to play in other recorders/players. Note however that some recorders/players will not play even finalized dual-layer discs.

#### 1 Load the disc you want to finalize.

Make sure that the recorder is stopped before proceeding.

HOME MENU

#### 2 Select 'Disc Setup' from the Home Menu.



#### 3 Select 'Finalize' > 'Finalize' > 'Next Screen'.

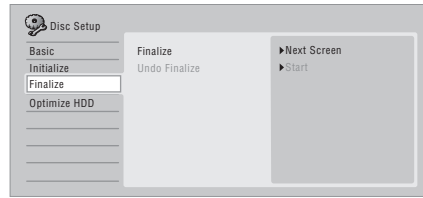

#### 4 For Video mode and DVD+R/+RW discs only, select a title menu style, then select 'Yes' to start finalization or 'No' to cancel.

The menu you select will be the one that appears when the 'top menu' (or 'menu' for a DVD+R/+RW) is selected on any DVD player.



- Discs recorded partially or fully on the Pioneer DVR-7000 DVD recorder do not support this feature. These discs will have only a text title menu when finalized on this recorder.

#### 5 The recorder will now start finalizing the disc.

During finalization:

- If the finalization process of a DVD-RW or DVD+R/+RW disc is going to take more than around four minutes, you can press **ENTER** to cancel. Around four minutes before completion, the option to cancel disappears.

- You can't cancel the finalization of a VR mode DVD-R disc.
- How long finalization takes depends on the type of disc, how much is recorded on the disc and the number of titles on the disc. A disc recorded in VR mode can take up to one hour to finalize. Video mode DVD-R/+RW and DVD+R/+RW discs can take up to 20 minutes.

## Initializing recordable DVD discs

DVD-R DVD-RW DVD+RW DVD-RAM

DVD-R/+RW discs can be initialized for either Video mode recording or VR mode recording.<sup>1</sup>

When you first load a blank DVD-RW or DVD+RW disc, the recorder initializes it for recording automatically. By default, blank DVD-RW discs are initialized for VR mode recording. See *DVD-RW Auto Init.* on page 115 if you want to change the default to Video mode.

DVD-R discs are ready for Video mode recordings out of the box; if you want to use a DVD-R for VR mode recording, you must initialize it before recording anything on the disc.

DVD+RW and DVD-RAM discs can also be initialized in order to erase the contents of the disc.





### Important

- Initializing a DVD-RW, DVD+RW or DVD-RAM disc will erase everything recorded on it. Make sure there is

nothing on the disc that you want to keep!

- You may not be able to re-initialize a DVD-RW disc in a different format if it was originally initialized on an older DVD recorder.
- Once initialized for VR mode recording, you can't re-initialize a DVD-R back to Video mode.

- 1  Select 'Disc Setup' from the Home Menu.

- 2  Select 'Initialize' > 'Video Mode', 'VR Mode' or 'Initialize DVD+RW'.

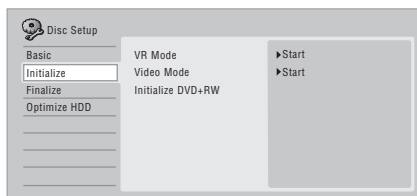

- 3  Select 'Start'.

It takes about 30 seconds to initialize the disc (except DVD-RAM discs, which can take up to 1 hour).

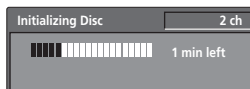

### Note

<sup>1</sup> If a disc was previously finalized on an older DVD recorder, you may not be able to re-initialize and/or initialize it for Video mode recording.

## Chapter 6

# Playback

### Introduction

Most of the features described in this chapter make use of on-screen displays. Navigate these using the cursor buttons and **ENTER**. To go back one level from any screen, use the **RETURN** button.

Remember also that the button guide at the bottom of every screen shows which buttons do what.

Many of the functions covered in this chapter apply to the HDD, DVD discs, Video CDs, WMA/MP3/DivX discs and CDs, although the exact operation of some varies slightly with the kind of disc loaded.

- Many functions are not available when a Video CD is playing in PBC mode. Stop playback, then press **▶▶** for non-PBC playback.
- For discs that contain JPEG picture files, see *The PhotoViewer (DVR-640H-S/DVR-543H-S)* on page 93 and *The PhotoViewer (DVR-540H-S)* on page 101.

### Basic playback



This section shows you how to use your recorder for playback of discs (DVD, CD, etc.), and for playback of video from the HDD.



#### Important

- Throughout this manual, the term 'DVD' means any kind of playable or recordable DVD. If a function is specific to a particular kind of DVD disc, it is specified.
- Some DVD-Video, DVD+R and DVD+RW discs don't allow certain playback controls to operate at certain points in the disc. This is not a malfunction.

HDD/DVD

#### 1 Select the HDD or DVD for playback.

If playing video from the HDD, skip to step 5 below.

Select DVD for any kind of disc playback.

▲ OPEN/CLOSE

#### 2 Load a disc.

Load a disc with the label side facing up, using the disc tray guide to align the disc (if you're loading a double-sided DVD-Video disc, load it with the side you want to play face down).

- If you want to play a DTS audio CD, please first read the note on page 55.

### 3 Start playback.

- If you're playing a DVD-Video or Video CD, a disc menu may appear when you start playback. Use the **↑/↓/←/→** buttons and **ENTER** to navigate DVD disc menus, and the number buttons and **ENTER** for Video CD menus.
- When playing video from the HDD, playback will automatically stop after the end of a title is reached.
- There may be a slight pause when playback switches from the first to the second layer of a dual-layer disc.
- See the following sections for more details on playing specific kinds of discs.

### 4 Press to stop playback.

**5 When you've finished using the recorder, eject the disc and switch the recorder back into standby.**



## Playing DVD discs



The table below shows the basic playback controls for DVD-Video, and recordable DVD discs.

 **PLAY** Press to start playback. If **RESUME** is displayed on-screen, playback starts from the place last stopped.

 **STOP** Press to stop playback. You can resume playback from the same point by pressing **▶ PLAY**. (Press **■ STOP** again to cancel the resume function.)

 **PAUSE** Pauses playback, or restarts playback when paused.

  Press to start scanning. Press repeatedly to increase the scanning speed.

  **PREV** **NEXT** Press to skip to previous/next chapter/title. (During playback you can also use the front panel **CH +/-** buttons.) *DVD+R/DVD+RW only:* **PREV**  may not always skip to the previous title.



 **ENTER** On some discs, you can also use the number buttons to select numbered items in the disc menu.

*VR mode only:* During playback, enter a title number then press **ENTER**.

*All:* Press **CLEAR** a number entry and start again.

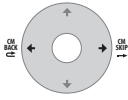

*DVD-R/RW, DVD-RAM only:*  
(Commercial back/skip) Each press skips backward/forward progressively up to a maximum of ten minutes forward or three minutes back.



While paused, press and hold to start slow-motion playback. Press repeatedly to change the playback speed. While paused, press to advance a single frame in either direction.



Press to display the menu of a DVD-Video disc. (DVD+R/+RW discs finalized on this recorder will display the Disc Navigator. Press **MENU** to display the disc menu.)



Use the cursor buttons to navigate DVD-Video disc menus; press **ENTER** to select items.



Press to return to the previous level of a DVD-Video disc menu.

## Playing from the HDD

The table below shows the basic playback controls when playing video recorded on the hard disk (HDD).



Press to start playback. If **RESUME** is displayed on-screen, playback starts from the place last stopped. Playback automatically stops after the end of a title is reached.



Press to stop playback. You can resume playback from the same point by pressing **▶ PLAY**. (Press **■ STOP** again to cancel the resume function.)



Pauses playback, or restarts playback when paused.



Press to start scanning. Press repeatedly to increase the scanning speed.



Press to skip to previous/next chapter/title. (During playback you can also use the front panel **CH +/-** buttons.)



During playback, enter a title number then press **ENTER** to skip directly to that title. Press **CLEAR** to clear a number entry and start again.

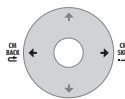

(Commercial back/skip) Each press skips backward/forward progressively up to a maximum of ten minutes forward or three minutes back.





While paused, press and hold to start slow-motion playback. Press repeatedly to change the playback speed. While paused, press to advance a single frame in either direction.

## Playback



### Playing CDs and WMA/MP3 discs



The table below shows the basic playback controls for audio CDs<sup>1</sup>, and WMA/MP3 files.

 Press to start playback.

 Press to stop playback.

 Pauses playback, or restarts playback when paused.

  *Except WMA:* Press to start scanning. Press again to increase the scanning speed. (There are two scan speeds; the current scan speed is shown on-screen.)

  Press to skip to previous/next track (or folder for WMA/MP3 disc). (During playback you can also use the front panel **CH +/-** buttons.)



During playback, enter a track number then press **ENTER** to skip directly to that track.

Press **CLEAR** to clear a number entry and start again.







### Playing Video CD



The table below shows the basic playback controls for Video CD.



Some discs feature Playback Control (PBC for short) menus. These discs show PBC in the display when you load them and display a menu on-screen from where you can select what to watch.<sup>2</sup>

 Press to start playback. If **RESUME** is displayed on-screen, playback starts from the place last stopped.

 Press to stop playback. You can resume playback from the same point by pressing  **PLAY**. (Press  **STOP** again to cancel the resume function.)



 Pauses playback, or restarts playback when paused.

  Press to start scanning. Press repeatedly to increase the scanning speed.

  Press to skip to previous/next track. When a PBC menu is displayed, press to display the previous/next page. (During playback you can also use the front panel **CH +/-** buttons.)

#### Note

<sup>1</sup> If you want to play a DTS audio CD, make sure the recorder is connected to a DTS-compatible amp/receiver with a digital connection. Noise will be output through the analog outputs. Also make sure that **Stereo** is selected using the **AUDIO** button (see *Switching audio channels* on page 63).

<sup>2</sup> When playing in PBC mode, some playback features, such as search, repeat and program play are not available. You can play a PBC Video CD in non-PBC mode by pressing  to start playback instead of  **PLAY**.



During playback, enter a track number then press **ENTER** to skip directly to that track.

Press **CLEAR** to clear a number entry and start again.

While a PBC menu screen is displayed, use to select numbered menu items.

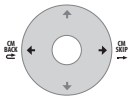

*Video CD only:* Each press skips backward/forward progressively up to a maximum of ten minutes forward or three minutes back. Note that this function doesn't work when playing in PBC mode.



While paused, press and hold to start slow-motion playback. Press repeatedly to change the playback speed (forward only).

While paused, press to advance a single frame (forward only).



Press to display the disc menu of a Video CD playing in PBC mode.



Press to stop playback. You can resume playback from the same point by pressing **▶ PLAY**. (Press **■ STOP** again to cancel the resume function.)



Pauses playback, or restarts playback when paused.



Press to start scanning. Press repeatedly to increase the scanning speed.



Press to skip to previous/next title. (During playback you can also use the front panel **CH +/-** buttons.)



While paused, press to advance one frame. Press and hold to start slow motion playback (press repeatedly to change the slow motion play speed).



Press to display the playback audio type; press repeatedly to change the playback audio type.



Press to display subtitle information; press repeatedly to change subtitles.

## Playing DivX video files

The table below shows the basic playback controls for DivX video files.



Press to start playback. If **RESUME** is displayed on-screen, playback starts from the place last stopped. Playback of titles (DivX files) proceeds in alphabetical order.



## Using the Disc Navigator to browse the contents of a disc

Use the Disc Navigator to browse the contents of a disc and start playback.

## Using the Disc Navigator with recordable discs and the HDD

DVD-R DVD-RW DVD+R DVD+RW DVD-RAM HDD

You can use the Disc Navigator to browse and edit video on recordable DVDs and the HDD, and to view information on titles.

See also *Editing* on page 66 for more on editing recordable discs.

**1**  Select the hard disk drive or DVD.

**2**  Open the Disc Navigator.

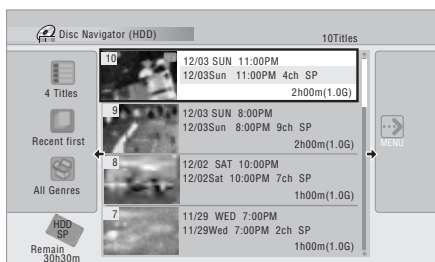

- You can also access the Disc Navigator from the Home Menu.

**3**  Browse the list of titles.

- Use the   buttons to display the previous/next page of titles.

- To change the thumbnail picture displayed for a title see *Set Thumbnail* on page 71.
- For HDD recordings, you should be able to see a thumbnail title digest. If it doesn't display, set *Set Preview* to **Normal**. See *Set Preview* on page 117.

**4**  Play the highlighted title.

- You can also select **Play** from the command menu options.

## Changing the display style of the Disc Navigator

You can choose to display titles in the Disc Navigator in various different ways, sorted alphabetically, by recording date, by genre, and so on. You can also choose whether to display four or eight titles on the screen at the same time.

**1**  Display the View Options panel.

### The View Options panel

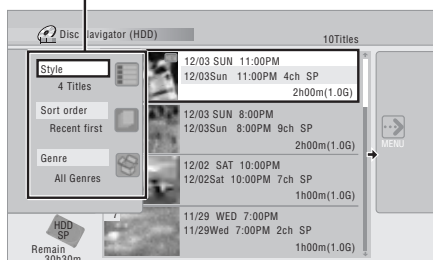



**2** Choose 'Style', 'Sort order' or 'Genre', then press **ENTER** to see the available view options.

- **Style** – Select four or eight titles per screen view
- **Sort order** – Sort by date (most recent first), unwatched first, title name or recording date (oldest first)
- **Genre** – Display all genres or just a selected genre



**3** Choose a view option, then press **ENTER**.

The title list display is updated according to the new display preferences.

## Using the Disc Navigator with playback-only discs

DVD-Video Video CD

**1** Display the Home Menu.



**2** Select 'Disc Navigator'.

Alternatively, for a CD, Video CD or WMA/MP3/DivX disc, you can press **DISC NAVIGATOR**, which takes you straight to the Disc Navigator screen.



**3** Select what you want to play.

Depending on the type of disc you have loaded, the Disc Navigator looks slightly different, but they are all navigated in the same way.

The screen below shows a WMA/MP3/DivX disc. Navigate to the folder, or the track/title within a folder that you want to play.

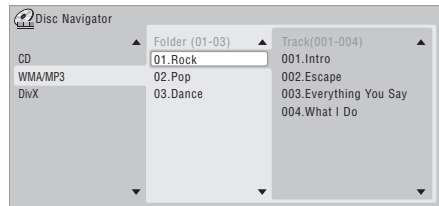

Playback starts after you press **ENTER**.

- For discs that contain CD-Audio tracks and WMA/MP3 tracks or DivX titles, you can switch the playback area between **CD**, **WMA/MP3** and **DivX**. This can only be done while the disc is stopped.

## Scanning discs

(except WMA)

You can fast scan discs at various speeds, forwards or backward.<sup>1</sup>

### Note

- Only analog audio is output when scanning audio CDs.
- No subtitles are displayed when scanning DVDs and DivX titles.
- Analog and digital sound is output when scanning DVDs and DivX titles with Dolby Digital or Linear PCM sound on forward **SCAN 1** (Linear PCM is output from the optical digital output, except during chase playback and simultaneous recording/playback). No sound is output when using other scan speeds.
- No sound is output when scanning from the HDD, except on forward **SCAN 1** (Linear PCM is output from the optical digital output during forward **SCAN 1**).
- Depending on the disc, normal playback may automatically resume when a new chapter is reached on a DVD disc.

## Playback

- 1  **During playback, start reverse or forward scanning.**
- The scanning speed is shown on-screen.

- 2  **Press repeatedly to change the scanning speed.**

There are four scanning speeds available when playing HDD video, a DVD or a DivX title. Reverse playback is also possible with HDD and DVD video.<sup>1</sup>

There are two scanning speeds for other types of disc.

- 3  **Resume normal playback.**

## Playing in slow motion

   

You can play video at various slow motion speeds. DVDs and video on the HDD can be played in slow motion in either direction, while Video CDs and DivX titles can only be played forwards in slow motion.

There is no sound when playing in slow motion.

- 1  **Pause playback.**

- 2  **Press and hold to start slow motion reverse or forward play.**

- 3  **Press repeatedly to change the slow motion speed.**
- The current playback speed is indicated on-screen.

- 4  **Resume normal playback.**

## Frame advance/frame reverse

You can advance or back up video on a DVD disc<sup>2</sup> or the HDD frame-by-frame.

With Video CD and DivX titles, you can only use frame advance.

- 1  **Pause playback.**

- 2  **Back up or advance one frame with each press.**

- 3  **Resume normal playback.**

## The Play Mode menu



The Play Mode menu gives you access to search functions, repeat and program play functions.

### Note

<sup>1</sup> Reverse playback may not be smooth.

<sup>2</sup> Depending on the disc, normal playback may automatically resume when a new chapter is reached.

Press  to display the Play Mode menu.

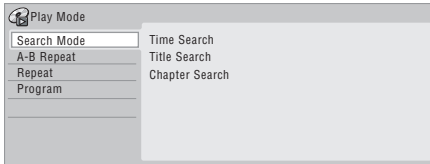

- You can also access the Play Mode menu from the Home Menu (press **HOME MENU**).
- To exit the Play Mode menu, press **HOME MENU** or **PLAY MODE**.

## Search Mode

**ALL**

The Search Mode feature lets you start playback from a specified point in a disc by time<sup>1</sup> or by title/chapter/folder/track number.



**1** Select 'Search mode' from the Play Mode menu, then choose a search option.

The available search options depend on the type of disc.

**2**  Enter a title/chapter/folder/track number or a search time.

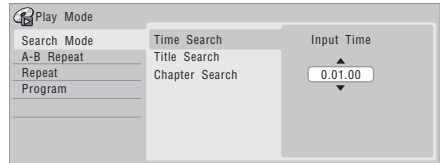

*Time Search (HDD, DVD):* For example, for 25 minutes into the current title, press **2, 5, 0, 0**. For 1 hour and 15 minutes and 20 seconds into the title, press **1, 1, 5, 2, 0**.

*Time Search (Video CD):* For example, for 2 minutes and 30 seconds into the current track, press **2, 3, 0**.

*Title/Chapter/Folder/Track Search:* For example, for track 6, press **6**.

**3**  Start playback.

## A-B Repeat

    

The A-B Repeat function allows you to specify two points (A and B) within a track or title that form a loop which is played over and over.<sup>2</sup>

**1**  During playback, select 'A-B Repeat' from the Play Mode menu.

### Note

- When using time search, playback may occasionally start slightly before or after the time you input.
- If you switch camera angles on a DVD during A-B repeat play, A-B repeat is canceled.

**2**  **With 'A (Loop Start)' highlighted, press at the point you want the loop to start.**

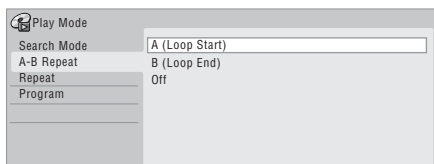

**3**  **With 'B (Loop End)' highlighted, press at the point you want the loop to end.**

Playback immediately jumps back to the start point and plays the loop round and round.

- When playing a DVD-Video/Video mode DVD, or from the HDD, the start and end points of the loop must be in the same title.
- To resume normal playback, select **Off** from the A-B Repeat menu, or press **CLEAR** if no menu OSD (such as the Play Mode menu) is displayed.

## Repeat play



There are various repeat play options, depending on the kind of disc loaded, or if you're using the HDD for playback. It's also possible to use repeat play together with program play to repeat the tracks/chapters in the program list (see *Program play* on page 61).<sup>1</sup>

**1**  **Select 'Repeat' from the Play Mode menu, then choose a repeat play mode.**

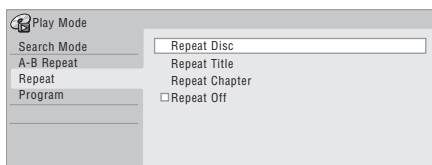

- To resume normal playback, select **Repeat Off** from the Repeat Play menu, or press **CLEAR** if no menu OSD (such as the Play Mode menu) is displayed.

## Program play

**HDD** **DVD-Video** **CD** **Video CD** **WMA/MP3**

This feature lets you program the play order of titles/chapters<sup>2</sup>/folders/tracks on a disc or the HDD.

**1**  **Select 'Program' from the Play Mode menu, then 'Input/Edit Program'.**

The Input/Edit Program screen varies according to the disc type. Below is the DVD input screen.

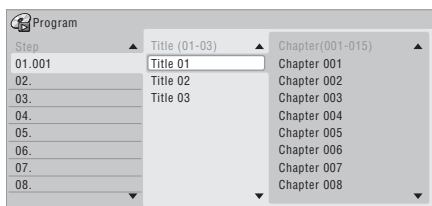

### Note

- <sup>1</sup> If you switch the camera angle during repeat play of a DVD-Video disc, repeat play is canceled.
- <sup>2</sup> When playing a program list of DVD-Video chapters, chapters not included in the program list may be sometimes be played, depending on the disc.



## 2 Select a title, chapter, folder or track for the current step in the program list.

After pressing **ENTER** to add the title/chapter/folder/track, the step number automatically moves down one.

- To insert a step into the program list, highlight the step number where you want to insert another step, then select a chapter/title/folder/track as usual. After pressing **ENTER**, all the subsequent steps move down one.
- To delete a step from the program list, highlight the step you want to delete, then press **CLEAR**.

## 3 Repeat step 2 to build up a program list.

A program list can contain up to 24 titles/chapters/folders/tracks.



## 4 Play the program list.

Program play remains active until you cancel program play, erase the program list, eject the disc or switch off the recorder.



### Tip

- To save your program list and exit the program edit screen without starting playback, press **HOME MENU** or **PLAY MODE**.
- During program play, press **▶▶I** to skip to the next program step.
- To repeat play the program list, select **Program Repeat** from the Repeat Play Mode menu (see *Repeat play* on page 61).
- Press **CLEAR** during playback to switch off program play (if no menu OSD, such as the Disc Navigator, is displayed). Press while stopped to erase the program list.
- From the Program menu you can also:
  - Start Program Play** – Starts playback of a saved program list
  - Cancel Program Play** – Turns off program play, but does not erase the program list
  - Erase Program List** – Erases the program list and turns off program play

## Displaying and switching subtitles

### DVD-Video DivX

Some DVD and DivX discs have subtitles in one or more languages; the disc box will usually tell you which subtitle languages are available. You can switch subtitle language during playback.<sup>1</sup>

### Note

- Some discs only allow you to change subtitle language from the disc menu. Press **MENU** or **TOP MENU** to access.
  - To set subtitle preferences, see *Subtitle Language* on page 113.

Check the disc packaging for details of the subtitle options.

-  **Select/change the subtitle language.**

The current subtitle language is shown on-screen and in the front panel display.

- To switch off subtitles, press **SUBTITLE** then **CLEAR**.

## Switching DVD and DivX soundtracks

When playing a DVD disc or DivX title recorded with two or more soundtracks (often in different languages), you can switch the soundtrack during playback.<sup>1</sup>

Check the disc packaging for details of the soundtrack options.

-  **Change the audio soundtrack.**

The current audio language is shown on-screen and in the front panel display.

- The sound may drop out for a few seconds when switching soundtracks.
- Some discs feature both Dolby Digital and DTS soundtracks. There is no analog audio output when DTS is selected. To listen to the DTS soundtrack, connect this recorder to a DTS decoder or AV

amp/receiver with built-in DTS decoder via the digital output. See *Connecting to an AV amplifier or receiver* on page 22 for connection details.

## Switching audio channels

For HDD<sup>2</sup> and VR mode content that has both a main and a SAP (Secondary Audio Program) audio channels, you can switch between main (**L**), SAP (**R**), or both (**L+R**).<sup>3</sup>

When playing Video CDs and audio CDs you can switch between stereo, just the left channel or just the right channel.

-  **Press repeatedly to display/switch the audio channel.**

The audio channel(s) currently playing are indicated on-screen.

- L+R** – Both channels (default)
- L** – Left/main channel only
- R** – Right/SAP channel only

- Stereo** – Stereo (default)
- 1/L** – Left channel only
- 2/R** – Right channel only

### Note

- Some discs only allow you to change audio language from the disc menu. Press **MENU** or **TOP MENU** to access.
  - To set audio language preferences, see *Audio Language* on page 113.
- Only when HDD Recording Format is set to Video Mode Off (*HDD Recording Format* on page 115).
- When playing a dual mono recording on a VR mode disc, if you are listening to the Dolby Digital soundtrack via the digital output, you cannot switch the audio channel. Set **Dolby Digital Out** to **Dolby Digital** → **PCM** (see *Dolby Digital Out* on page 112) or listen via the analog outputs if you need to switch the audio channel.

## Switching camera angles

### DVD-Video

Some DVD-Video discs feature scenes shot from two or more angles—check the disc box for details: it should be marked with a  icon if it contains multi-angle scenes. When a multi-angle scene is playing, the same icon appears on screen to let you know that other angles are available (this can be switched off if you prefer—see *Angle Indicator* on page 117).

-  **Switch the camera angle.**
- The angle number is displayed on-screen.
- If the disc was paused, playback starts again with the new angle.

## Displaying disc information on-screen

You can display various on-screen information about the disc loaded or the HDD.

### DISPLAY

-  **Display/change the on-screen information.**
  - Press once to show the HDD and removable disc (DVD, etc.) activity together. Press again to show the status of just the currently selected playback/recording device (HDD or removable disc).
- To hide the information display, press **DISPLAY** repeatedly until it disappears.

## HDD and removable disc activity display

Press **DISPLAY** once to see the HDD and removable disc (DVD, etc.) activity. Use the **HDD/DVD** button to switch between the two kinds of display.

The example displays below show high-speed copying from HDD to DVD, and HDD chase playback.

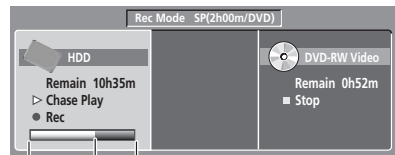
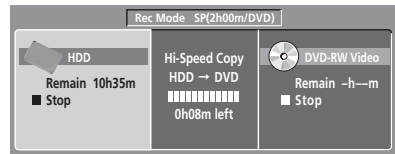

Recording time

Relative playback position

Shows recording restrictions for the current channel program

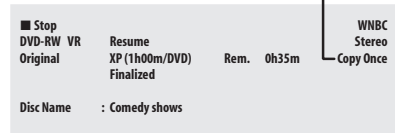

Indicates copy-protected material

Indicates a multi-angle scene

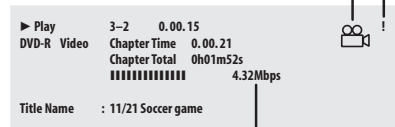

Indicates the data transfer rate





### Tip



- See *Switching camera angles* on page 64 for more on multi-angle scene switching.
- When using the simultaneous play and record feature, the display shows information for playback only.
- During real-time copy, the copy source playback information is displayed.
- The Video mode disc displays become the same as a DVD-Video disc once the disc is finalized.
- The total recording time figure shown in parenthesis is calculated based on a 12 cm / 4.7 GB disc at the displayed record setting.
- Recording and playback times for TV recordings are approximately 0.1 % shorter than the actual time. This is because of the slightly different frame rates of TV broadcasts versus DVD.
- The frame number is shown next to the elapsed time display when the disc is paused.
- **Copy Once** or **Can't Record** messages may appear in the stop or recording displays. These indicate that the broadcast TV program contains copy control information.

## Chapter 7

# Editing

### The Disc Navigator screen



The Disc Navigator screen is where you can edit video content on unfinalized Video mode and VR mode DVD-R/-RW discs, DVD+R/+RW and DVD-RAM, as well as video content on the internal hard disk drive.

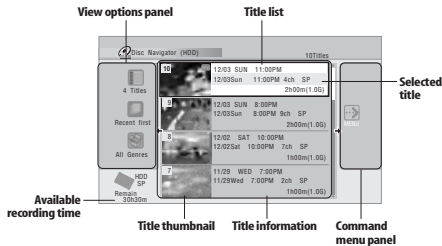

-  **Select the HDD or DVD.**
-  **Display the Disc Navigator screen.**

Playback will automatically stop when you do this.

- The Disc Navigator is also accessible from the Home Menu.



-  Press to display the command menu panel. Use the **↑/↓** and **ENTER** buttons to navigate the menus.
-  When in the title list, press to display the previous/next page if there are more titles than can be displayed.

-  Press to change the title information displayed in the title list.
-  Press to switch between the HDD and DVD Disc Navigator screens.
- If you are editing a VR mode DVD-R/-RW or DVD-RAM disc you can display the Play List by selecting **Play List** from the view options panel (press **←**, then select **Play List** from the view options, then **Play List**).

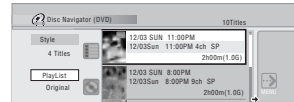

- Titles on the HDD marked with a  icon are timer recordings set to Auto Replace Recording (see *Setting a manual timer recording* on page 42).
- Titles on the HDD marked with a **NEW** icon are recently recorded titles that haven't yet been played.

-  **Press to exit the Disc Navigator.**

## Command menu panel options

The table below shows which commands you can use with the HDD and different disc types.

	HDD	DVD-R/-RW (Video mode), DVD+R/+RW	DVD-R/-RW, DVD-RAM (VR mode)	
			Original	Play List
<b>Create</b> (page 68)				●
<b>Play</b> (page 69)	●	●	●	●
<b>Erase</b> (page 69)	●	●	●	●
<b>Edit &gt; Title Name</b> (page 70)	●	●	●	●
<b>Edit &gt; Set Thumbnail</b> (page 71)	●	●	●	●
<b>Edit &gt; Erase Section</b> (page 72)	●		●	●
<b>Edit &gt; Divide</b> (page 73)	●			●
<b>Edit &gt; Chapter Edit</b> (page 73)	●		●	●
<b>Edit &gt; Set Genre</b> (page 75)	●			
<b>Edit &gt; Lock</b> (page 75)	●	●	●	
<b>Edit &gt; Move</b> (page 76)				●
<b>Edit &gt; Combine</b> (page 76)				●
<b>Genre Name</b> (page 77)	●			
<b>Multi-Mode</b> (page 78)	●			
<b>Undo</b> (page 79)		●	● <sup>*1</sup>	● <sup>*1</sup>

<sup>\*1</sup> DVD-R/-RW only

## Editing accuracy

Some editing commands ask you whether you want to keep Video mode compatibility or frame accuracy (*Video Mode Compatible Editing* or *Frame Accurate Editing*).

Frame accurate editing is very precise. The edit point is accurate to the exact frame you choose. However, this accuracy is not preserved in any copy you make if you use the high-speed copy function to make a Video mode DVD.

Video mode compatible editing is less precise. The edit point you choose will only be accurate to within 0.5 to 1 second. On the other hand, these edit points will be preserved if you use high-speed copy to make a Video mode DVD or DVD+R/+RW.

## HDD genres

The large capacity of the HDD means that there may be many hours of video in the recorder. To help you organize your HDD video content you can assign different genres to titles. There are 10 genres in total, including ten user-definable ones that you can name as you like.

## Create

### DVD (VR) DVD-RAM Play List only

Use this function to create a Play List and add titles to it.

Before you can use this command, make sure that the Play List is switched on in the view options panel on the left.



- 1 **Select 'Create' from the command menu panel.**

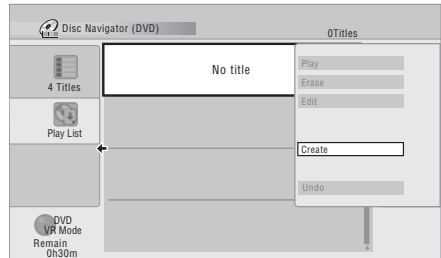

- 2 **Select an original title to add to the Play List.**

Repeat these two steps to add as many titles as necessary to the Play List.

## Play

DVD (Video) DVD (VR) DVD+R DVD+RW DVD-RAM

HDD

Use this function to start playback of a title.

1  Highlight the title you want to play.

2  Select 'Play' from the command menu panel.

Playback of the title you selected starts.

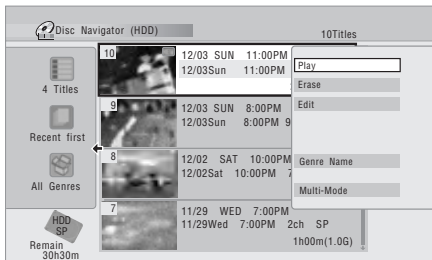

## Erase

DVD (Video) DVD (VR) DVD+R DVD+RW DVD-RAM

HDD

Use this function to erase unwanted titles.

When you erase titles from the HDD or Original titles from a VR mode DVD-RW, the available recording space increases accordingly. Erasing a title from a Video mode DVD-RW or DVD+RW disc increases the available recording time only if it is the last title on the disc.<sup>1</sup>

Erasing Play List titles, or titles from a DVD-R (VR mode or Video mode) or DVD+R, will not result in any more free space on the disc.

1  Highlight the title you want to erase.

2  Select 'Erase' from the command menu panel.

3  Select 'Yes' to confirm or 'No' to cancel.

### Tip

- You can erase a title quickly by pressing **CLEAR** when the title is highlighted. Confirm the edit by pressing **ENTER**.

### Note

1 There may be cases where erasing a title from a DVD+R/+RW disc will result in non-contiguous title numbers.

## Title Name

DVD (Video) DVD (VR) DVD+R DVD+RW DVD-RAM

HDD

You can give titles new names of up to 64 characters long for VR mode, DVD-RAM and HDD recordings, and up to 40 characters for Video mode recordings and DVD+R/+RW discs.

**1**  Highlight the title you want to name (or rename).

**2**  Select 'Edit' > 'Title Name' from the command menu panel.

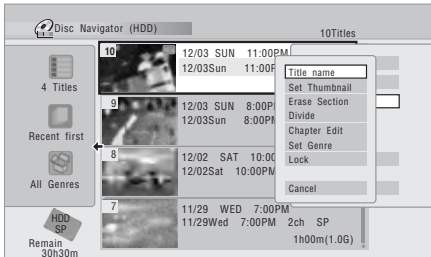

**3**  Input a name for the selected title.

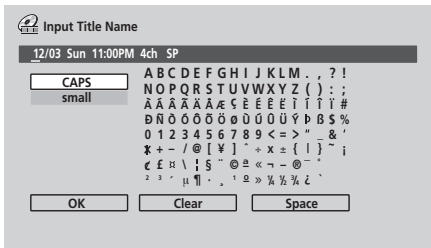

- A name generated automatically by the recorder will already be in the name input section of the screen. Use the ◀◀/▶▶ buttons to change the cursor position.
- Select **CAPS** or **small** to change to upper or lower-case, or use the **CASE SELECTION** buttons (◀◀/▶▶).
- You can also use the **CLEAR** button to delete characters directly (press and hold for two seconds to delete the whole name). For other remote control key shortcuts, see *Using the remote key shortcuts to input a name* below.
- For discs formatted on a different DVD recorder, you will see only a limited character set.

**4**  Select 'OK' to enter the name and return to the main Disc Navigator screen.

- To return to the main Disc Navigator screen without saving changes to the title name, press **RETURN**.

## Using the remote key shortcuts to input a name

The table below shows the remote control key shortcuts that you can use to input characters in the name input screen. Pressing a button repeatedly cycles through the characters shown.

If you want to enter two characters in succession that are both on the same button (for example a **P** and an **R**), press ▶▶ to advance the cursor one space manually between inputting the two characters.

Key	Characters	Key	Characters
1	, . ' ? ! - & # 1	6	m n o 6 ö ð ò ó ø ñ
2	a b c 2 ä å á â ä å æ ç	7	p q r s 7 \$ ÿ / ß * <sup>1</sup>
3	d e f 3 è é ê ë	8	t u v 8 ü ù ú ú
4	g h i 4 î ï ð ñ	9	w x y z 9
5	j k l 5 £	0	0
◀◀	[cursor back]	▶▶	[cursor forward]
◀◀/▶▶	[change case]	CLEAR	[clear character]
⏏	<space>	■	[finish name input]
+	~ ( ) _ / : ; " ` ^ @ # * % ¥   + = { } [ ] < >		

\*1 lower-case: ÿ; upper-case: ß

## Set Thumbnail

HDD DVD (Video) DVD (VR) DVD+R DVD+RW

### DVD-RAM

You can change the thumbnail picture that appears in the Disc Navigator for a title to any frame that appears in that title.



1 Highlight the title you want to change the thumbnail picture for.



2 Select 'Edit' > 'Set Thumbnail' from the command menu panel.

The thumbnail setting screen appears from which you can find the frame you want.

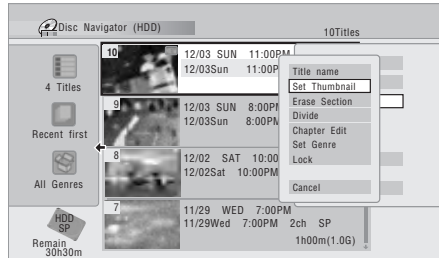

3 Use the playback controls (▶, ⏏, ◀◀, ▶▶, etc.) to find a suitable frame, then press ENTER to set.

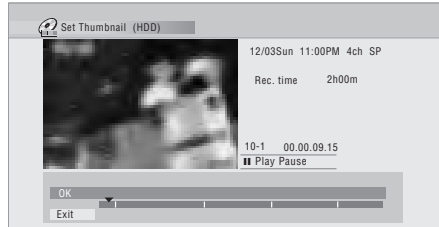

You can also use the chapter and time search features (press **PLAY MODE**), and the **CM SKIP** buttons.



4 Select 'Exit' to return to the Edit screen.

## Erase Section

HDD DVD (VR) DVD-RAM

Using this command you can delete a part of a title, ideal for cutting out the commercial breaks in a recording made from the TV.

1  Highlight the title containing the section you want to erase.

2  Select 'Edit' > 'Erase Section' from the command menu panel.

3  *HDD only:* Select the type of edit.

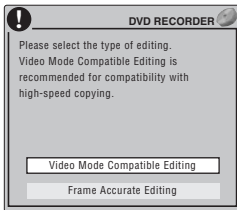

- For more information about these options, see *Editing accuracy* on page 68.

4 Highlight 'From' then use the playback controls (▶, II, ◀◀, ▶▶, etc.) to find the start of the section to erase, then press ENTER.

The bar at the bottom of the screen indicates the current play position in the title. After pressing ENTER, a marker shows the start of the section.

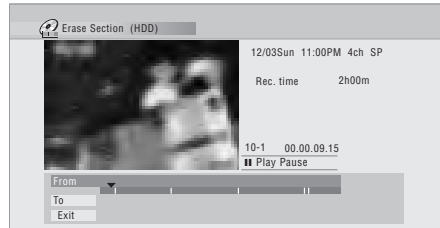

5  Highlight 'To' then, in the same way, find the end of the section to erase, then press ENTER.

After pressing ENTER, another marker indicates the end of the section, with the section itself marked in red.

6  Select 'Yes' to confirm, or 'No' to cancel.

In the thumbnail viewer you can see a few seconds of video either side of the marked section to see how the edit will look.

- When editing VR mode Original content, you may not be able to erase very short sections (less than five seconds).



## Divide

**HDD DVD (VR) DVD-RAM** *Play List only*

Use this command to divide a title into two. Note that once divided, the two new HDD titles cannot be recombined into one again.

**1**  **Highlight the title you want to divide.**

**2**  **Select 'Edit' > 'Divide' from the command menu panel.**

**3** *HDD only:* **Select the type of edit.**

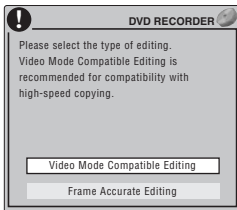

- For more information about these options, see *Editing accuracy* on page 68.

**4** Use the playback controls (▶, II, ◀◀, ▶▶, etc.) to find the place you want to divide the title.



**5**  **Press to divide the title at the current playback position.**

**6**  **Select 'Yes' to confirm or 'No' to cancel.**

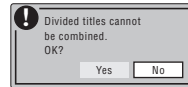

## Chapter Edit

**DVD (VR) DVD-RAM** **HDD**

When editing a VR mode DVD or video on the HDD you can edit individual chapters within a title, with commands for erasing, combining and dividing.

**1** **Highlight the title that contains the chapters you want to edit.**

**2**  **Select 'Edit' > 'Chapter Edit' from the command menu panel.**

**3**  *HDD only:* **Select the type of edit.**

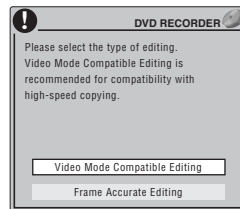

- For more information about these options, see *Editing accuracy* on page 68.

#### 4 Select the command you want:

- **Divide** – Divide a chapter into two or more parts: Use the playback controls (▶, II, ◀◀, ▶▶, etc.) to find the point at which you want to divide the chapter, then press **ENTER**.



You can keep dividing the chapter as many times as you wish (up to 999 chapters per DVD-R/-RW/-RAM disc or 99 chapters per HDD title).

- **Erase<sup>1</sup>/Move<sup>2</sup>** – Erase or move chapters: Select the chapter you want to erase/move and press **ENTER**. Select whether you want to erase or move the chapter.

*Move command only:* Select the destination for the chapter, and press **ENTER**.

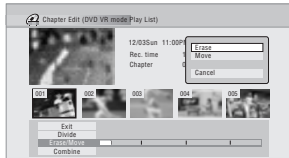

- **Combine<sup>3</sup>** – Combine two adjacent chapters into one: Highlight the bar divider between two adjacent chapters and press **ENTER**.

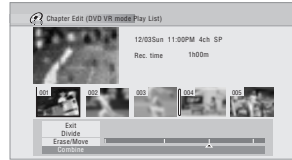

- #### 5 Select 'Exit' to get back to the main Disc Navigator screen.

#### Note

- 1 When editing VR mode Original content, it may not be possible to erase chapters less than five seconds long.
- 2 VR mode Play List only.
- 3 It may not always be possible to combine two chapters, even though they are adjacent. If a chapter has been divided into three, then the middle chapter erased, it is not possible to combine the two remaining chapters into one.

## Set Genre

**HDD**

Use this command to assign a genre to a title.

1  Highlight the title you want to assign a genre to.

2  Select 'Edit' > 'Set Genre' from the command menu panel.

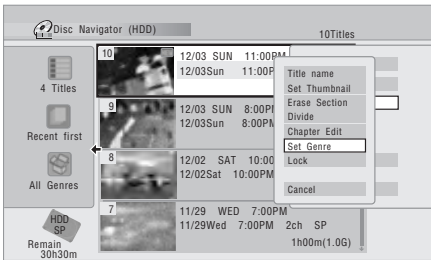

3  Select a genre for the title.

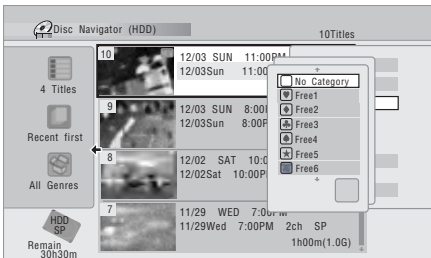

## Lock

**HDD DVD (Video) DVD (VR) DVD+R DVD+RW**

**DVD-RAM**

*Original only*

You can lock a title so that it can't be edited or erased accidentally. If you do need to edit it, you can always unlock it later.

### Important

- You can't undo any edits made before changing the lock status. You also can't undo a lock/unlock command using the **Undo** option from the Disc Navigator menu.

1 Highlight the title you want to lock (or unlock).

2  Select 'Edit' > 'Lock' from the command menu panel.

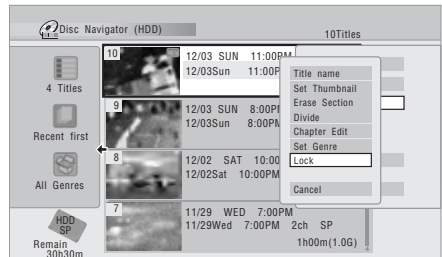

An unlocked title will become locked; a locked title will be unlocked. Locked titles are shown in the Disc Navigator with a padlock icon.

## Move

DVD (VR) DVD-RAM Play List only

Use this function to re-arrange the playing order of Play List titles.

- 1  Highlight the title you want to move.

- 2  Select 'Edit' > 'Move' from the command menu panel.

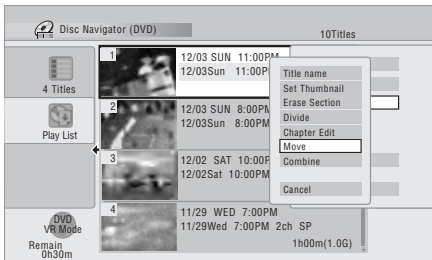

- 3  Select a new position for the title.

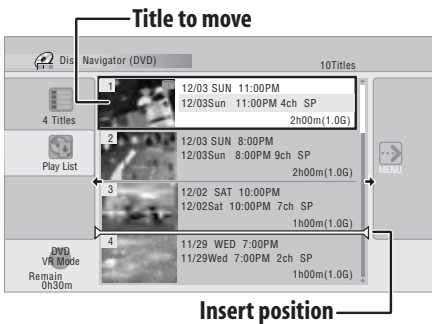



After pressing **ENTER**, the new, updated Play List is displayed.

## Combine

DVD (VR) DVD-RAM Play List only

Use this function to combine two Play List titles into one.

- 1  Highlight the title you want to combine.
- This title will remain in the same place after combining with another title.

- 2  Select 'Edit' > 'Combine' from the command menu panel.

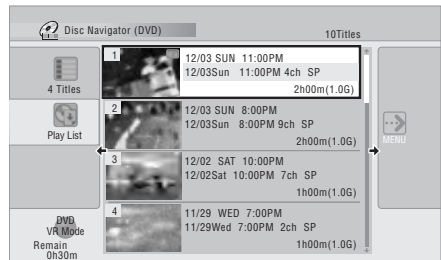



**3 Select another title to combine with the first.**

This title will be appended to the first title selected.

The screen below shows title 3 selected to be appended to title 1:

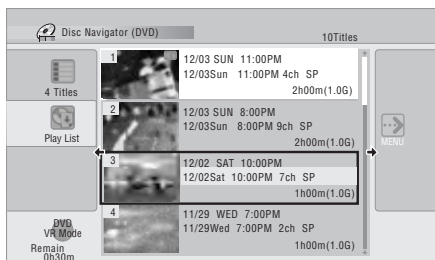

**4 Select 'Yes' to confirm or 'No' to cancel.**

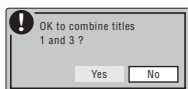

## Genre Name



Use this command to rename one of the ten user-definable genres (**Free 1** to **Free 10**).



**1 Select 'Genre Name' from the command menu panel.**

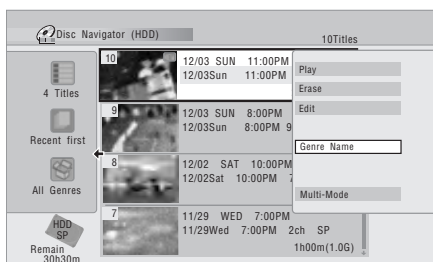

**2 Select one of the user-definable genre names.**

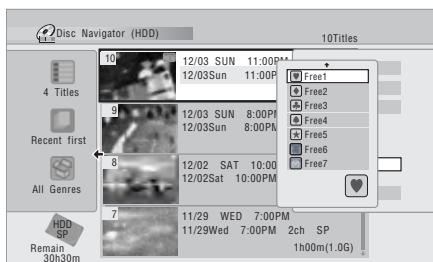



### 3 Input a name for the genre.

- The name can be up to 12 characters long.
- For information on remote control key short cuts, see *Using the remote key shortcuts to input a name* on page 70.

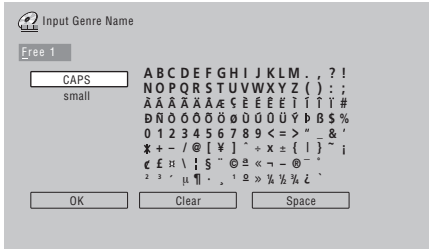

### 4 Select 'OK' to enter the name and exit.

## Multi-Mode



Multi-Mode allows you to select several titles, then select a command that will be applied to all of them. In this way you can select multiple titles and then erase them all at once, for example.



### 1 Select 'Multi-Mode' from the command menu panel.

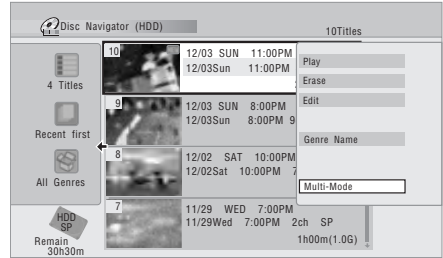

### 2 Select titles from the title list. Selected titles are marked with a .



### 3 Select the command that you want applied to all the marked titles.

For example, select **Erase** to erase all the marked titles.

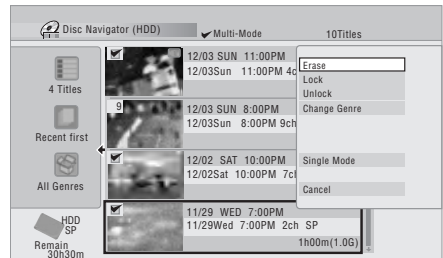

Once the command is completed, Multi-Mode is automatically exited.

## Undo

DVD (Video) DVD (VR) DVD+R DVD+RW

If you make a mistake while editing, you can generally undo it. There is one level of undo (in other words, you can only undo the last edit you made).



- **Select 'Undo' from the command menu panel.**

- You can't undo anything after exiting the Disc Navigator screen.

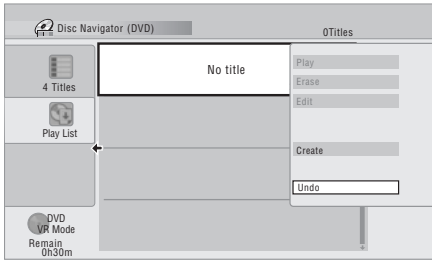

about your edits requires a certain amount of disc space. As you edit, this information builds up, eventually preventing you from editing further.



## Frequently asked questions

- *Why doesn't the available recording time increase when I erase titles from a VR mode DVD-R?*

When you erase titles from a DVD-R (or DVD+R), the titles are no longer displayed, but the content remains on the disc. DVD-R/+R are write-once media; they can't be erased or rewritten.

- *I can't edit my disc!*

You may find that as the available recording time is reduced on a VR mode DVD-R disc, editing is no longer possible. This is because information

## Chapter 8

# Copying and backup

## Introduction

Use the copying features of this recorder to:

- Back up important recordings stored on the HDD to a DVD.
- Make a DVD copy of a recording on the HDD to play in another player.
- Transfer video from a DVD to the HDD for editing.
- Transfer edited video from the HDD to DVD.

The simplest way to copy a title is to use the One Touch Copy feature. This copies the currently playing HDD title to DVD, or DVD title to the HDD. See *One Touch Copy* on page 81 for detailed instructions.

For more sophisticated copying tasks you can build a Copy List of titles to copy, and edit titles so that you only copy the bits you want. See *Using Copy Lists* on page 82 for detailed instructions.

Where possible, the recorder will copy your recordings at high-speed. Depending on the recording mode, the kind of disc loaded and various other factors, copying can be as fast as one minute per hour of video. See *Minimum copying times* on page 119 for more on copying times. (Please note that additional time is required for initializing and finalizing a disc.)

If you want to save disc space you can copy video at a lower recording quality (for example, an XP recording on the HDD copied to SP on a DVD). Copying in this way is always done in real-time.

When real-time copying from the HDD to a Video mode DVD-R/-RW or DVD+R/+RW, the chapter markers in the original material are not copied. Chapter markers are put into the copy at intervals, according to the Auto Chapter settings (see also *Auto Chapter (Video)* and *Auto Chapter (DVD+R/+RW)* on page 115).

## Restrictions on copying

Commercial DVD-Video discs are protected using Copy Guard. These discs cannot be copied to the HDD.

Some video material is copy-once protected. This means that it can be recorded to HDD, but it can't then be freely copied again. If you want to transfer copy-once protected material from HDD to DVD, you'll need to a CPRM ver. 1.1 or higher VR mode DVD-RW, ver. 2.0 or 2.1 VR mode DVD-R, or CPRM-compatible DVD-RAM disc (see *CPRM* on page 35 for more on this). Only one instance of a copy-once protected title can be added to the Copy List, and after it's been copied, the title is erased from the HDD (it is therefore not possible to copy a locked title that is copy-once protected).

You can identify copy-once protected material during playback by displaying disc information on-screen. If the current title is copy-once protected, an exclamation mark (!) is shown.



## Copyright

You may use this product only to reproduce or copy materials for which you own the copyright or have obtained permission to copy from the copyright owner or for which you otherwise have a legal right to reproduce or copy. Unless you own the copyright or have obtained permission from the copyright owner or otherwise have a legal right to reproduce or copy, you may be violating the law, including copyright law, and may be subject to payment of damages and other remedies.

## One Touch Copy

\* See also *Copyright* above.

The One Touch Copy feature copies the currently playing or selected (in the Disc Navigator) HDD title to DVD, or DVD title to HDD. The whole title is copied, regardless of where in the title you start the copy.

HDD to DVD copies are made in the same recording mode. When copying DVD to HDD, the copy is made in whatever recording mode is currently set.

Make sure that a recordable DVD disc is loaded when trying to copy from the HDD.

**1**  **If you're copying from DVD to the HDD, select a recording mode.**

Note that selecting a recording mode higher than the title playing will not result in a better quality recording.

**2**  **Press during playback to copy the current title.**

The front panel display indicates that the title is being copied.

- High-speed copying is used when copying from the HDD to DVD. Playback continues while copying.
- Real-time copying is used when copying from DVD to the HDD. Playback restarts from the beginning of the title.

## Canceling One Touch Copy

You can cancel a One Touch Copy once it's started.

-  **Press and hold for more than a second.**

Copying is canceled and the video already copied is erased.

- If you cancel a HDD to DVD-R/+R copy, the space available for recording does not return to the pre-copy figure.

## Notes on copying using One Touch Copy

### Copying to DVD

- Title name, chapter markers, as well as thumbnail picture markers for the Disc Navigator, are also copied. However, if you copy to a Video mode DVD-R/+RW or DVD+R/+RW, only the first 40 characters of a name are copied.
- The chapter markers in the copy may not be in exactly the same positions as the original when recording on to a Video mode DVD-R/+RW or DVD+R/+RW.
- You can't use the One Touch Copy function to copy a title if any part of the title is copy-once protected.
- A title that contains mixed aspect ratios can't be copied to a Video mode disc. Use a VR mode DVD-R/+RW or DVD-RAM disc for this type of material.

- Low resolution (**SEP** through **LP** modes<sup>1</sup>) widescreen material can't be copied to a Video mode disc. Use a VR mode DVD-R/-RW or DVD-RAM disc for this type of material.
- When HDD Recording Format is set to Video Mode Off, titles recorded in **LP/MN9** to **MN15** modes cannot be high-speed copied to a Video mode disc. Please use a VR mode DVD-R/-RW or DVD-RAM.
- Recordings of dual mono broadcasts cannot be high-speed copied to a Video mode DVD. Please use a VR mode DVD-R/-RW or DVD-RAM.
- Titles over 8 hours cannot be copied to single-layer DVD+R/+RW discs using One Touch Copy. Use DVD+R DL discs for titles over 8 hours.
- Titles recorded in **MN1** to **MN6**, **SEP**, **SLP** or **EP** mode cannot be copied to DVD+R/+RW using One Touch Copy.

### Copying to the HDD

- The maximum title length for copying is 12 hours.
- Title name and chapter markers are also copied, except when copying from a finalized Video mode disc.
- Thumbnail picture markers and chapter markers for the Disc Navigator are copied, but their position in the copy may be slightly changed from the original.
- If some part of the title being copied is copy-protected, copying will start, but the copy-protected portions will not be copied.

## Using Copy Lists

\* See also *Copyright* on page 81.

At its simplest, a Copy List is just a list of HDD or DVD titles that you want to copy. When copying HDD titles to DVD, you can, however, edit the titles in your copy list, erasing chapters you don't need, or re-naming titles, for example. Edits you make to titles in the Copy List do not affect the actual video content; only the 'virtual' content of the Copy List. So you can freely erase and modify anything in your Copy List safe in the knowledge that the actual content is not being altered.

### Copying from HDD to DVD



#### Important

- The recorder can only store one Copy List at a time.
- Resetting the recorder to its factory settings (see *Resetting the recorder* on page 132) will erase the Copy List.

#### 1 Load a recordable DVD.

- It is possible to complete the following steps without having a recordable DVD loaded (or having an uninitialized DVD loaded); however, the steps are slightly different.
- If you want to use a DVD-RW (VR mode) disc for the copy, make sure it is initialized before you start.

#### 2 Select 'Copy' from the Home Menu.

#### Note

<sup>1</sup> In manual recording mode these equate to **MN1–15** (Video Mode Off) or **MN1–8** (Video Mode On).



### 3 Select 'HDD → DVD'.

If this is the first time to create a Copy List, skip to step **5** below.

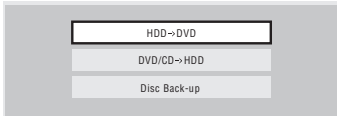

### 4 If there is already a Copy List stored in the recorder, choose whether to 'Create New Copy List' or 'Continue Using Previous Copy List'.



- If you select **Continue Using Previous Copy List**, skip to step 10 below.
- Selecting **Create New Copy List** will erase any Copy List already stored in the recorder.



### 5 Add titles to the Copy List (highlight a title and press ENTER to add).

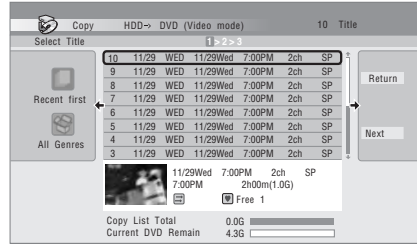

Titles you've added to the Copy List are highlighted in pink.

There are some restrictions on titles that can be added to the Copy List if you are copying to a Video mode DVD or DVD+R/+RW:

- When adding titles that contain copy-once protected material, the copy-once parts will not be added.
- When adding titles that contain material of more than one aspect ratio (screen size), each part with a different aspect ratio will be added as a separate title if high-speed copying is possible.

Depending on the title<sup>1</sup>, high-speed copying may not be possible to a Video mode disc.

#### Note

- Widescreen titles recorded at low resolution (**SEP** through **LP/MN1 to MN15** (Video Mode Off) or **MN1 to MN8** (Video Mode On)).
  - **LP/MN9 to MN15** recordings when HDD Recording Format is set to Video Mode Off.
  - Dual mono recordings.
  - Combined titles that were originally recorded using different recording modes.

6 Press **→** to display the command menu panel.

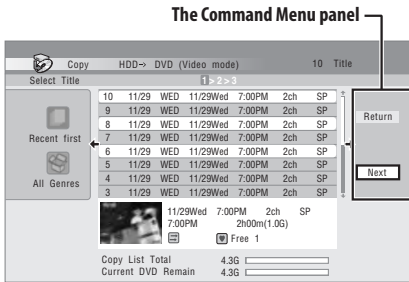

7 Select 'Next' to move on to the Title Edit screen.

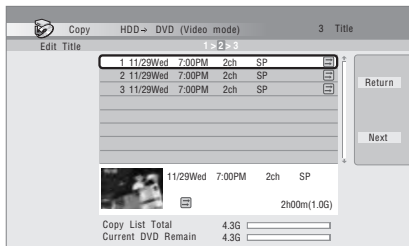

8 To edit a title, highlight it using the **↑/↓** buttons, then press **ENTER**.

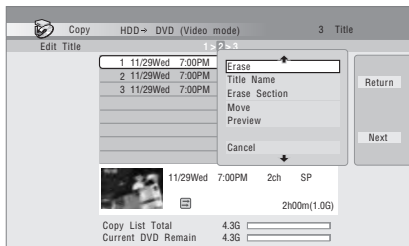

A menu of editing commands appears:

- **Erase** – Erase individual titles from the Copy List (see *Erase* on page 69).

- **Title Name** – Name or rename a title in the Copy List (see *Title Name* on page 70).
- **Erase Section** – Erase part of a title (see *Erase Section* on page 72).
- **Move** – Change the order of titles in the Copy List (see *Move* on page 76).
- **Preview** – Check the content of a title in the Copy List.
- **Divide** – Divide a title in the Copy List into two (see *Divide* on page 73).
- **Combine** – Combine two titles in the Copy List into one (see *Combine* on page 76).
- **Chapter Edit** – Edit chapters within a Copy List title (see *Chapter Edit* on page 73):
  - **Divide** – Divide a chapter into two.
  - **Erase/Move** – Erase a chapter/ Change the chapter order.
  - **Combine** – Combine two chapters into one.
- **Set Thumbnail** – Set the thumbnail frame for a title (see *Set Thumbnail* on page 71).
- **Recording Mode** – Set the picture quality of the copy (see *Recording Mode* on page 87).
- **Dual Mono Audio** – Set how dual mono audio should be copied when copying from HDD to Video mode DVD (see *Dual Mono Audio* on page 87).
- **Cancel** – Exit the menu.

Repeat this step for as many titles you have that need editing.

9  **Display the command menu panel.**

10  Select 'Next' to proceed.

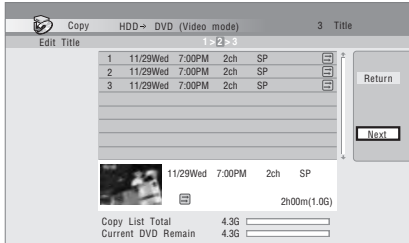

There are several options available from the next screen:

- Select **Recording Mode** if you want to change the recording quality (see *Recording Mode* on page 87).<sup>1</sup>
- Select **Input Disc Name** if you want to change the disc name. Input a name of up to 64 characters for a VR mode disc or 40 characters for a Video mode disc or DVD+R/+RW. (The input method is similar to that of naming titles; see *Title Name* on page 70.)
- Select **Finalize** if you want to automatically finalize a Video mode DVD or DVD+R after copying.<sup>2</sup> Select a title menu style from the following screen.

11  Select 'Start Copy' to start copying.

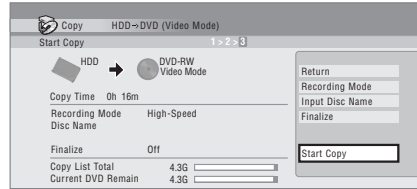

- If you're using a DVD-R DL or DVD+R DL disc and the copy will span both layers, the **Copy List Total** bar will be purple.
- The **Current DVD Remain** bar will be half-length if the first layer of a DVD-R DL or DVD+R DL disc is already full.

## Copying from DVD to HDD

### Important

- The DVD to HDD Copy screen isn't accessible when a finalized Video mode disc or a DVD-Video is loaded. As long as the disc is not CopyGuard protected, you can still use the One Touch Copy function, however (See *One Touch Copy* on page 81).
- The recorder can only store one Copy List at a time.
- The Copy List will be erased if:
  - any of the titles on the DVD disc are erased or edited.
  - the disc tray is opened.
  - playback is switched between Play List and Original.
  - the DVD disc is re-initialized or

### Note

<sup>1</sup> Titles recorded in **MN1** to **MN6**, **SEP**, **SLP** or **EP** mode cannot be copied to DVD+R/+RW using high-speed copy.  
<sup>2</sup> If a timer recording is scheduled to start during copying, the disc will not be finalized.

finalized.

– the recorder is reset to its factory settings (see *Resetting the recorder* on page 132).

- It may not be possible to copy from a DVD disc that was recorded on a different DVD recorder or a PC.

**1**  **Select 'Copy' from the Home Menu.**

**2**  **Select 'DVD/CD → HDD'.**

**3**  **Select a Copy List type.**

- Selecting **Create New Copy List** will erase any Copy List already stored in the recorder.

**4**  **Add titles to the Copy List (highlight a title and press ENTER to add).**

Titles you've added to the Copy List are highlighted in pink.

**5**  **Select 'Next' from the command menu panel to proceed to the title edit screen.**



**6** **Select a title to edit.**

A menu appears of Copy List editing commands:

- **Erase** – Erase individual titles from the Copy List (see *Erase* on page 69).
- **Move** – Change the order of titles in the Copy List (see *Move* on page 76).
- **Preview** – Check the content of a title in the Copy List.
- **Cancel** – Exit the menu.

Repeat this step for as many titles you have that need editing.



**7** **Select 'Next' from the command menu panel to proceed to the copy options screen.**

- Select **Recording Mode** if you want to change the recording quality (see *Recording Mode* on page 87).



**8** **Select 'Start Copy' to start copying.**

## Recording Mode

1  Select 'Recording Mode' from the command menu panel.

2  Select a recording mode for the copy.

- **High-Speed Copy**<sup>1</sup> – The Copy List is copied at the same recording quality as the original.
- **XP, SP, LP, EP, SLP, SEP, MN**<sup>2</sup> – The Copy List is copied at the specified recording quality in real-time. (Note that if you copy at a higher quality setting than the original, the copy will not be better quality than the original.)

If you select **MN** above, you can also change the level setting (**MN1** to **MN32**<sup>3</sup> or **LPCM**) from the Recording Quality box that appears.

- **Optimized**<sup>2,4</sup> – The recording quality is automatically adjusted so that the Copy List fits on to the space available on the disc. Copying is carried out in real-time.

When you change the recording mode setting, you can see how much disc space it will require. If this is more than is available, it shows up in red and you won't be able to start copying. In this case, either change the recording quality, or press **RETURN** to go back to the Copy List screen and erase one or more titles from the Copy List.

### Note

- 1 When copying to a Video mode DVD or DVD+R/+RW, the chapter markers in the copy may not be in exactly the same position as the original.
- 2 When the copy mode is set to something other than High-Speed Copy for copying to a Video mode DVD or DVD+R/+RW, the chapter markers of the original are not copied. Chapter markers are put into the copy at regular intervals, according to the Auto Chapter setting (see also *Auto Chapter (Video)* and *Auto Chapter (DVD+R/+RW)* on page 115.
- 3 When copying to a DVD+R/+RW, **MN1** to **MN3** and **SEP** modes are not available.
- 4 Optimized mode only available when copying to DVD.

## Dual Mono Audio

1  Select the title containing the audio you want to change.

2  Select 'Dual Mono Audio' from the command menu panel.

3  Select a dual mono audio option.

## Using disc backup

\* See also *Copyright* on page 81.

This feature offers a simple way to make a backup copy of a finalized Video mode disc or DVD+R/+RW. The data is copied first to the hard disk drive<sup>1</sup>, then on to another recordable DVD disc.

**1**  Select 'Copy', then 'Disc backup' from the Home Menu.

**2**  Select a backup option.

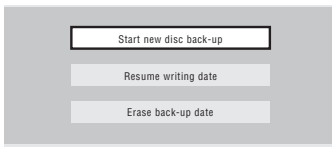

There are three backup options:

- **Start new disc backup** – Start making a backup of a disc.
- **Resume writing data** – Record the backup data already on the HDD to a recordable DVD.
- **Erase backup data** – Erase the backup data on the HDD.

**3** Load the disc you want to make a backup of.

You can only make backup copies of finalized Video mode discs or finalized DVD+R or DVD+RW discs (excluding DVD-R DL/DVD+R DL discs).

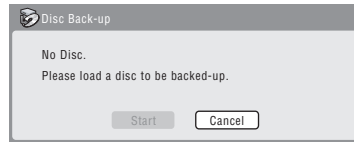

**4**  Select 'Start'.

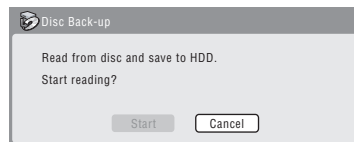

- To see the progress of the backup, press **DISPLAY**.
- You can cancel the backup process by pressing **ONE TOUCH COPY** for more than one second.

**5** When the data has been copied, take out the disc and load a blank\* recordable DVD.

\* If you're using a DVD-RW or DVD+RW, the disc doesn't have to be blank, although the previous contents of the disc will be erased in the backup process.

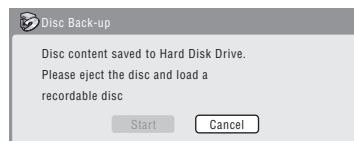

### Note

<sup>1</sup> It is not possible to play this material directly from the HDD.



You can use a DVD-R ver. 2.0 or 2.1 disc, or DVD-RW ver. 1.1 or ver. 1.2 disc for the backup.

- If you backup a DVD-R disc to DVD-RW, you cannot undo the finalization later.
- Actual recordable capacity of discs vary so there may be cases where the contents of the disc you're backing-up will not fit on to a particular blank disc. If this happens, please try another brand of disc.
- DVD-R/-RW discs can only be backed up to DVD-R/-RW discs; DVD+R/+RW discs can only be backed up to DVD+R/+RW discs.

### 6 Select 'Start' to start writing the backed-up data to the blank disc.

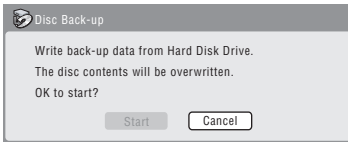

- To see the progress of the backup, press **DISPLAY**.
- You can cancel the backup process by pressing **ONE TOUCH COPY** for more than one second. However, this will make the disc unusable (although if you are using a DVD-RW or DVD+RW disc you can re-initialize it in order to make it usable again—see *Initializing recordable DVD discs* on page 51.)

### 7 After the recorder has finished recording the backup disc, you can select whether to make another backup of the same data or exit.

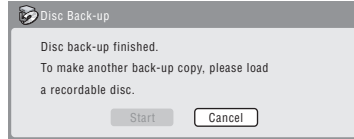

- Select **Start** to make another backup copy or **Cancel** to finish. If you want to make another backup copy, return to step 6 above.

### 8 If you don't need to keep the backup data on the HDD, you can delete it now. Select **Yes** to delete the data from the HDD; select **No** to keep it (you can delete it later if you want to).

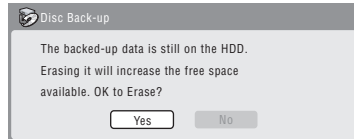

- If you decide to leave the backup data on the HDD, you can make backup copies to recordable DVD discs anytime from the Disc backup menu.

## Chapter 9

# Using the Jukebox

The Jukebox feature allows you to use the recorder's HDD to store and playback music from up to 999 of your CDs. You can also transfer WMA/MP3 files stored on CD-R/-RW/-ROM or a USB device. Once on the HDD, you can name albums, assign them a genre, and set tracks that you don't want to play to Jump.

### Copying music to the HDD

The first step is to copy some music to the HDD. CD audio is copied in real-time, while WMA and MP3 files are copied at high speed. All tracks are copied from each CD<sup>1</sup> as an album.

WMA/MP3 album and track names are copied along with the audio. CD album and track names are not copied, but you can add these later (see *Editing Jukebox albums* on page 92).

Usually, the tracks are copied to the HDD in the order they appear on the CD. When copying CD audio, you can copy them in some other order using the program play mode. See *Program play* on page 61 for how to do this.

Note that once copied to the HDD, audio tracks cannot be copied to a recordable DVD disc.



#### Important

- While copying CD audio, no other recorder operation is possible.



#### Note

<sup>1</sup> The recorder can copy up to 999 CDs; a CD can contain up to 99 tracks. The recorded audio format is 256 kbps Dolby Digital.

- When copying CD audio, scheduled timer recordings will not start until copying is complete.
- Copy protected CDs may not copy successfully.

#### 1 Load the CD you want to copy to the HDD.

#### 2 Select 'Copy' from the Home Menu.

#### 3 Select 'DVD/CD to HDD'.

On pressing **ENTER** all tracks (or files) on the CD are copied to the HDD.

- You can also start copying by starting playback of the CD (including program play) and then pressing **ONE TOUCH COPY**.
- To cancel copying an audio CD, press and hold **ONE TOUCH COPY** for more than one second.
- To cancel copying a WMA/MP3 disc, press **ENTER**.
- If the CD loaded contains both CD audio tracks and WMA/MP3 files, the part currently selected will play.

## Copying files from a USB device to the HDD

*DVR-640H-S/DVR-543H-S only*

You can copy WMA or MP3 files from a connected USB device, such as a USB drive, to the HDD.

### 1 Connect the USB device.

### 2 Select 'Jukebox' from the Home Menu.

### 3 Select 'Listen to Music from USB Device'.

### 4 Select 'Copy Album' from the command menu panel.

### 5 Select 'Yes' to confirm or 'No' to cancel.

The selected folder on the USB device will be copied to the HDD.

- Up to 99 folders/999 files on the USB device are copyable/displayable.

## Playing music from the Jukebox

You can select albums or individual tracks from the Jukebox to play.<sup>1</sup>

### 1 Select 'Jukebox' from the Home Menu.

- ### 2 Select a Jukebox option.
- **Listen to Music/Edit** – Listen to CDs that have been copied to the HDD.
  - **Listen to Music (WMA/MP3)/Edit** – Listen to WMA or MP3 files that have been stored on the HDD.
  - **Listen to Music from USB Device** – Listen to music from an external USB device. *(DVR-640H-S/DVR-543H-S only)*

- ### 3 Select what you want to play.
- The screen below shows CD albums stored on the HDD:

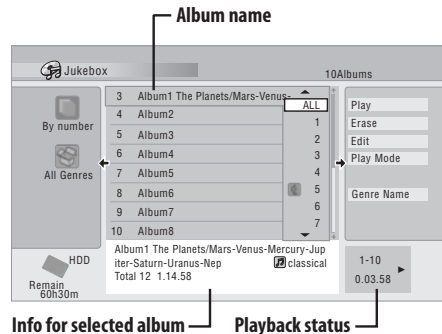



- If you select a whole album to play, all tracks that are not set to Jump will play.
- If you want to start playback from a selected track in an album, or play a track that is set to Jump, press **→** to enter the track list then select a track to play.
- Press **SUBTITLE** or **ANGLE** to change the page.

### Note

<sup>1</sup> The digital audio output contains a copy-prohibit signal when albums are playing from the HDD.

## Changing the album view

1  From the album list, display the view options menu panel.

2  Select a view option.

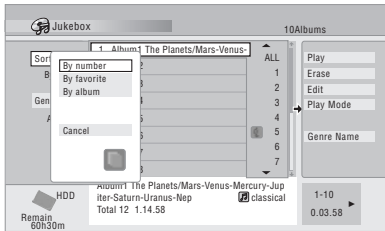

### • Sort order

**By number** – Albums are listed by the album number.

**By favorite** – Most often listened to music appears at the top of the list.

**By album** – Albums are listed alphabetically.

### • Genre

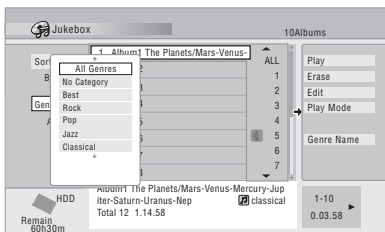

**All Genres** – All albums are displayed.

**Genre** – Only albums in the selected genre are displayed.

## Editing Jukebox albums

A number of commands are available for editing and changing the playback behavior of albums.

1  Select 'Jukebox' from the Home Menu.

2  Select 'Listen to Music/Edit' or 'Listen to Music (WMA/MP3)/Edit'.

3  Select what you want to edit.

4  Select an edit function from the command menu panel.

- **Erase** – Erase the selected track (if all tracks in an album are selected, the whole album is erased).
- **Edit > Edit Title** – Enter a name of up to 64 characters for the album. See page *Title Name* on page 70 for how to enter names.
- **Edit > Set Genre** – Set or change the genre for the album.
- **Edit > Jump Set**<sup>1</sup> – Set a track to jump so that it doesn't play (choose this command again to cancel the Jump setting).
- **Play Mode** – Change the playback order for albums and tracks.
- **Genre Name** – Enter a name of up to 12 characters for a genre. See page *Title Name* on page 70 for how to enter names.

### Note

<sup>1</sup> Tracks set to Jump will be skipped during consecutive track playback.

## Chapter 10

# The PhotoViewer (DVR-640H-S/DVR-543H-S)

From the PhotoViewer you can view JPEG photos and picture files stored on the HDD, recordable DVD or CD-ROM/-R/-RW, or on a USB-equipped digital camera.<sup>1</sup> You can also import files and save them to the recorder's HDD or a DVD-R/-RW disc.

- **Copy photos from a USB device** – Copy all photos on a connected USB device to the HDD.

## Locating JPEG picture files

**1**  Select 'PhotoViewer' from the Home Menu.

**2**  Select the location of the files you want to view or edit.



- **View/Edit photos on the HDD** – View or edit photos already stored on the recorder's HDD.
- **View photos on a CD/DVD** – View photos on a Fujicolor CD, CD-ROM, CD-R/RW, or DVD-R/RW.
- **View photos on a USB device** – View photos on a digital camera (or other USB device) connected to the USB port.

**3**  Select the folder containing the files you want to view, copy or edit.

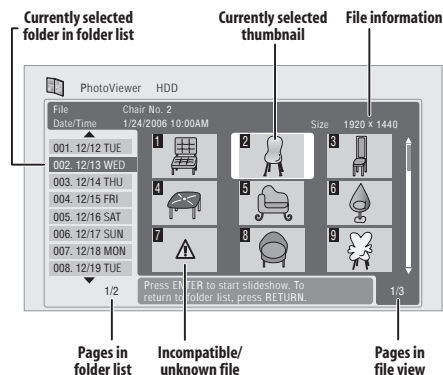

- If you encounter a disc that will not play, check that the disc and file formats are compatible with this recorder (see *JPEG file compatibility* on page 13 and *PC-created disc compatibility* on page 14).

 **Note**

<sup>1</sup> Up to 999 files or 99 folders are viewable, but if there are more files/folders than this on the disc or connected USB camera it is still possible to view them all using the Reload function (see the following page).

## Playing a slideshow



### 1 Select a folder from the folder list.

The first nine images from the selected folder are displayed as thumbnails in the main part of the screen.

- The larger the file size, the longer it takes the recorder to load the file.
- To start the slideshow from the first file in the folder, skip to step 4 after pressing **ENTER**.



### 2 Select 'File Selection' from the menu.

The first thumbnail image is highlighted.

- You can also select a folder, then press **→** to get to the thumbnail view area.
- To get back to the folder list, press **RETURN** (or **←** when the leftmost thumbnail is highlighted).



### 3 Select a thumbnail.

- Use the **◀◀** and **▶▶** buttons to display the previous/next page of thumbnails.



### 4 Select 'Start Slideshow' from the menu.

- You can also select a file or folder then press **▶ PLAY** to start playing the slideshow.

- Use **◀◀ PREV / NEXT ▶▶** to display the previous/next picture, or **|| PAUSE** to pause the slideshow.
- Depending on the aspect ratio, some pictures may be displayed with black bars top and bottom, or left and right.
- Large picture files may take a few seconds to display. This is normal.
- During playback of the slideshow you can listen to WMA/MP3 files in the **Slideshow** genre (see *Editing Jukebox albums* on page 92).

STOP



### 5 Press to return to the thumbnail view area.

- You can also use the **RETURN** button.

RETURN



### 6 Press to return to the folder view area.

- With the leftmost thumbnail highlighted, you can use the **←** button.
- To exit the PhotoViewer, press **HOME MENU**.

## Reloading files from a disc or USB device

If you have a disc with more than 1000 files and/or 100 folders, you can still view all the images using the reload function.



### 1 Navigate to the last entry in the folder list ('Read next: ...').

**2**  **Load the next batch of up to 999 files/99 folders from the disc or connected USB device.**

It will take a moment (at most a few minutes) to load in the images.<sup>1</sup>

## Zooming an image

During a slideshow you can zoom in to enlarge a portion of the picture by a factor of two or four. You can also move the area of the picture displayed.

**1**  **Press during the slideshow to zoom the picture.**

Repeated presses cycle between zoom off, 2 x zoom and 4 x zoom. The zoom factor is displayed on-screen.

**2**  **Use to move the zoomed area.**

## Rotating an image

You can rotate the displayed picture during a slideshow so you can always view pictures the right way up, whichever way they were taken.

**•**  **Press during the slideshow to rotate the displayed picture clockwise by 90°.**

Press repeatedly to continue rotating the picture in increments of 90°.

## Importing files to the HDD

You can import files and save them on to the HDD<sup>2</sup> from a CD, DVD or a connected USB camera. Once on the HDD you can edit and organize your pictures and print them out if you've connected a PictBridge-compatible printer.

**1**  **Select the location of folders/files you want to import.**

To import a whole folder, press **ENTER** here and skip to step **4** below.

- To import multiple folders, use the Multi-Mode; see *Selecting multiple files or folders* on page 96.

**2**  **Select 'File Selection' from the menu.**

**3** **Select a file to import, then press ENTER.**

- To import multiple folders, use the Multi-Mode; see *Selecting multiple files or folders* below.

### Note

<sup>1</sup> You can press **HOME MENU** to exit the PhotoViewer screen while the recorder is reloading images. (If you enter the PhotoViewer again, it will resume reloading if from a CD or DVD.)

<sup>2</sup> For files you want to keep permanently, we recommend backing up to DVD-R/-RW.

4  Select 'Copy to HDD' from the menu.

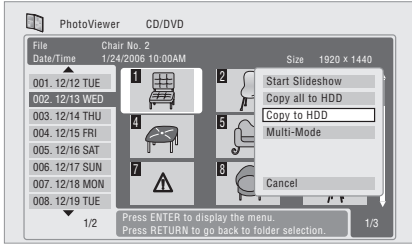

5  Select 'Yes' to confirm and copy the folder(s)/file(s), or 'No' to cancel.

- The files will be copied to the HDD with the same folder structure as the original.
- Importing to the HDD will not work if there is insufficient space on the HDD, or if there are already the maximum number of files and/or folders on the HDD (999 folders/999 files per folder).

### Selecting multiple files or folders

The Multi-Mode allows you to select multiple folders/files at once for importing or editing.

1  Select the folder containing the files you want to import.

2  Select 'Multi-Mode' from the menu.

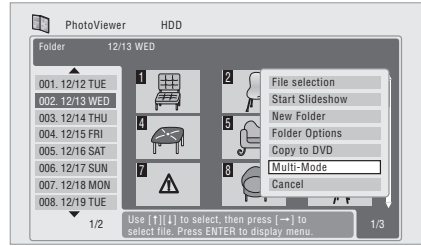

3  To add a file/folder to the list, select it, then choose 'Select' from the menu.

A checkbox mark () is shown by the item you selected.

- You can also select a file or folder and press **STOP** to add it to the list.
- To remove a file/folder from the list, select **Cancel Selection** from the menu.

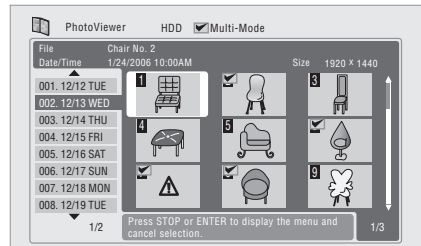

4  Display the command menu.

5  Select the command you want to apply to all the selected items.



## Importing files from a USB device

Use this feature to copy all the files on a connected USB device to this recorder's HDD.

### Important

- After backing up the pictures on your USB device to HDD, we recommend verifying that they have been recorded properly before deleting anything from the camera.



- 1 **Select 'Copy photos from a USB device' from the main PhotoViewer menu.**



- 2 **Select 'Yes' to confirm or 'No' to cancel.**

- While the files are being imported, any timer programs set to start will not begin, and no other operation is possible.

## Copying selected files to a DVD-R/RW

This feature allows you just to copy some of the files stored on HDD to a DVD.

A slideshow of the files is also recorded on the disc as a Video mode title, making it possible to view the photos on other DVD players/recorders that may not be compatible with JPEG file playback. Note

however that you may need to finalize the disc before it will play on another DVD player (copying selected files doesn't automatically finalize the disc).

### Important

- A maximum of 99 titles can be recorded.
- Slideshows can contain up to 99 files. If there are more files than this in the slideshow, multiple slideshows are created on the disc.
- If you erase a slideshow title from a DVD the slideshow will become unplayable but the free space will not increase.

- 1 **Load a blank (or unfinalized Video mode) DVD-R or DVD-RW disc.**



- 2 **Select 'View/Edit Photos on the HDD' from the menu.**



- 3 **Select the file(s) or folder(s) you want to copy.**

- Copying a folder will copy all the files contained in it.
- To copy multiple folders, use the Multi-Mode; see *Selecting multiple files or folders* on page 96.



- 4 **Select 'Copy to DVD' from the menu.**



- 5 **Select 'Yes' to confirm or 'No' to cancel.**

- Folder names on the disc will be *number PIONR*. File names will be *PHOT number*.

# 10 The PhotoViewer (DVR-640H-S/DVR-543H-S)

- Note that during copying, any timer programs set to start will not begin, and no other operation is possible.
- While 'Cancel' is displayed, you can press **ENTER** to cancel.

## Editing files on the HDD

There are a number of commands you can use to edit and organize your pictures stored on the HDD.

### Creating a new folder

- 1  From the folder list, display the menu.



- 2 Select 'New Folder'.

The folder appears at the bottom of the folder list with the name **F\_number**.

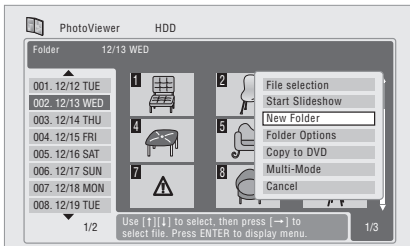

- There can be up to 999 folders on the HDD.

### Erasing a file or folder

- 1  Select the file(s) or folder(s) you want to erase.

- To erase multiple folders, use the Multi-Mode; see *Selecting multiple files or folders* on page 96.
- Erasing a folder will erase all the files contained in it. Please be careful!
- You can't erase files that have been locked.
- Folders containing locked files can't be erased. Unlocked files in the folder, however, will be erased.

- 2  Select 'File Options' or 'Folder Options'.

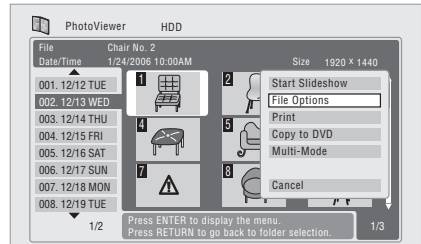

- 3  Select 'Erase' or 'Erase Folder'.

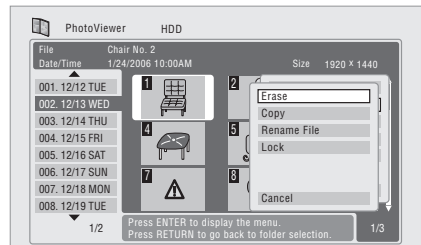



**4** Select 'Yes' to confirm, or 'No' to cancel.

- You can also erase a file or folder by pressing **CLEAR** when the file or folder is highlighted. Press **ENTER** to confirm.



**5** Select 'Yes' to confirm, or 'No' to cancel.

- Copying to the HDD will not work if there is insufficient space on the HDD; if there are already the maximum number of files and/or folders on the HDD.

## Copying files



**1** Select the file(s) or folder(s) you want to copy.

- Copying a folder will copy all the files contained in it.
- To copy multiple folders, use the Multi-Mode; see *Selecting multiple files or folders* on page 96.



**2** Select 'File Options' or 'Folder Options'.



**3** Select 'Copy' or 'Copy Folder Contents'.

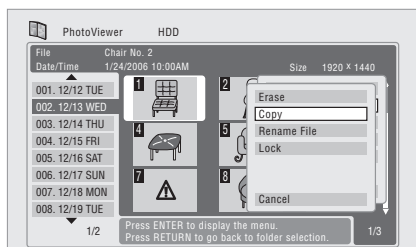

**4** Select a folder to copy the folder(s)/file(s) to.

## Naming files and folders

**1** Select the file or folder you want to rename.

You can't rename files that have been locked.

**2** Select 'File Options' or 'Folder Options'.

**3** Select 'Rename File' or 'Rename Folder'.

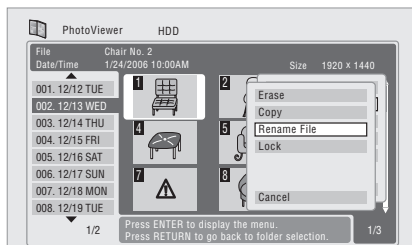

**4** Enter a new name for the file/folder.

File names or folder names can be up to 64 characters long.

See *Using the remote key shortcuts to input a name* on page 70 for how to enter a name.

## Locking/Unlocking files

Locking files will protect them from accidental erasure and prevent them from being renamed.

Use the same process to both lock and unlock files. Locked files are displayed in the PhotoViewer with a padlock icon.



### 1 Select the file(s) you want to lock (or unlock).

- To lock/unlock multiple folders, use the Multi-Mode; see *Selecting multiple files or folders* on page 96.



### 2 Select 'File Options' or 'Folder Options'.



### 3 Select 'Lock' or 'Lock Folder Contents'.

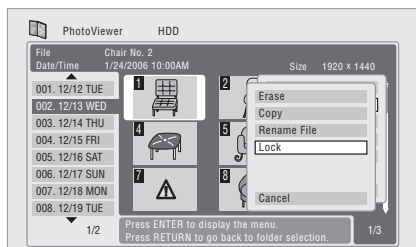

Locked files are shown with a padlock icon next to them.

## Printing files

Connecting a PictBridge-compatible printer to the USB port will enable you to print out picture files<sup>1</sup> stored on the HDD, or directly from a digital camera.

Make sure that the printer (and your digital camera if you are using that as a source) is connected to the recorder before starting.



### 1 Select the file(s) you want to print.

- To print multiple folders, use the Multi-Mode; see *Selecting multiple files or folders* on page 96.



### 2 Select 'Print' from the menu.

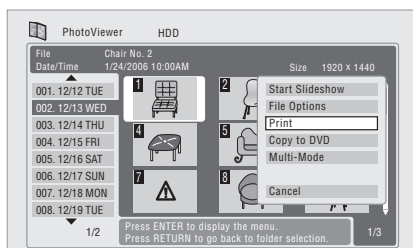

It takes a moment for the recorder to communicate with the printer. During this time you can press **ENTER** to cancel the print.



### 3 Select 'Start' to confirm, or 'Cancel' to cancel.

- Once printing has started, you can cancel by pressing **ENTER**.

### Tip

- Paper size and layout can be set; the options available depend on your printer—check the printer manual for details.

#### Note

<sup>1</sup> Picture files should be standard DCF format. Non-standard files may not print properly.

## Chapter 11 The PhotoViewer (DVR-540H-S)

From the PhotoViewer you can view JPEG photos and picture files stored on CD-ROM/-R/-RW.<sup>1</sup>

### Locating JPEG picture files

1  Select 'PhotoViewer' from the Home Menu.

2  Select the folder containing the files you want to view.

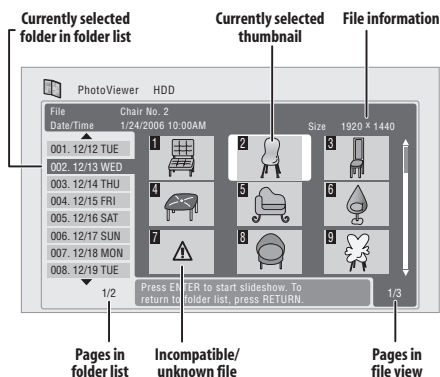

- If you encounter a disc that will not play, check that the disc and file formats are compatible with this recorder (see *JPEG file compatibility* on page 13 and *PC-created disc compatibility* on page 14).

### Playing a slideshow

1  Select a folder from the folder list.

The first nine images from the selected folder are displayed as thumbnails in the main part of the screen.

- The larger the file size, the longer it takes the recorder to load the file.

Press **ENTER** to start slideshow. To return to folder list, press **RETURN**.

The first thumbnail image is highlighted.

- You can also select a folder, then press **→** to get to the thumbnail view area.
- To get back to the folder list, press **RETURN** (or **←** when the leftmost thumbnail is highlighted).

2  Select a thumbnail from which to start the slideshow.

- Use the **◀◀** and **▶▶** buttons to display the previous/next page of thumbnails.
- You can also select a file or folder then press **▶ PLAY** to start playing the slideshow.

#### Note

<sup>1</sup> Up to 999 files or 99 folders are viewable, but if there are more files/folders than this on the disc or connected USB camera it is still possible to view them all using the Reload function (see the following page).

- Use **◀◀ PREV / NEXT ▶▶** to display the previous/next picture, or **|| PAUSE** to pause the slideshow.
- Depending on the aspect ratio, some pictures may be displayed with black bars top and bottom, or left and right.
- Large picture files may take a few seconds to display. This is normal.

**3**  **Press to return to the thumbnail view area.**

- You can also use the **RETURN** button.

**4**  **Press to return to the folder view area.**

- With the leftmost thumbnail highlighted, you can use the **◀** button.
- To exit the PhotoViewer, press **HOME MENU**.

## Zooming an image

During a slideshow you can zoom in to enlarge a portion of the picture by a factor of two or four. You can also move the area of the picture displayed.

**1**  **Press during the slideshow to zoom the picture.**

Repeated presses cycle between zoom off, 2 x zoom and 4 x zoom. The zoom factor is displayed on-screen.

**2**  **Use to move the zoomed area.**

## Rotating an image

You can rotate the displayed picture during a slideshow so you can always view pictures the right way up, whichever way they were taken.

-  **Press during the slideshow to rotate the displayed picture clockwise by 90°.**

Press repeatedly to continue rotating the picture in increments of 90°.

## Chapter 12 The Disc Setup menu

From the Disc Setup menu you can name discs, lock the contents to prevent accidental recording and erasure, initialize and finalize discs. The Disc Setup menu is accessed from the Home menu:

### Basic settings

#### Input Disc Name

DVD (VR) DVD (Video) DVD+R DVD+RW DVD-RAM

When you initialize a disc for recording, the recorder automatically assigns a name for the disc ranging from **DISC 1** to **DISC 99**. You can use the Input Disc Name function to change the default disc name to something more descriptive. This name appears when you load the disc and when you display disc information on-screen.

1  Select 'Disc Setup' from the Home Menu.

2  Select 'Basic' > 'Input Disc Name' > 'Next Screen'.

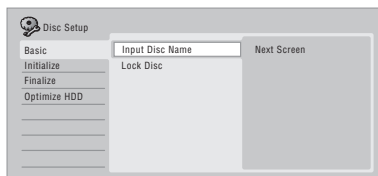

3  **Input a name for the disc.**

The disc name can be up to 64 characters long for a VR mode disc, or 40 for a Video mode discs and DVD+R/+RW.

- See *Title Name* on page 70 for more on navigating the input screen.

#### Lock Disc

DVD (VR) DVD-RAM

- Default setting: **Off**

Locking the disc will prevent accidental recording, editing or erasing of the disc.

#### Important

- A locked disc can still be initialized (which will completely erase the disc).

1  Select 'Disc Setup' from the Home Menu.

2  Select 'Basic' > 'Lock disc' then 'On' or 'Off'.

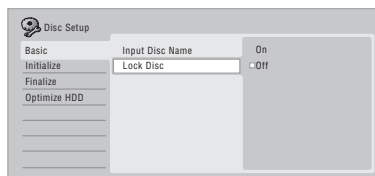

Set to **On** to prevent accidental recording, editing or erasing of the disc loaded. If you need to unlock the disc to make edits, select **Off**.

## Initialize settings

DVD-R DVD-RW DVD+RW DVD-RAM

You can initialize a recordable DVD-R/-RW disc for either VR mode or Video mode recording.

The first time you load a new DVD-RW disc, it will be automatically initialized for recording according to the DVD-RW Auto Init. setting in the Initial Setup menu (see page 115).

New DVD-R discs are ready for Video mode recording when you load them, but it is also possible to initialize them for VR mode recording.<sup>1</sup>

DVD+RW and DVD-RAM discs can also be initialized as a way of erasing the entire disc. When initializing a DVD-RAM disc, select VR mode.

See *Initializing recordable DVD discs* on page 51 for detailed instructions.

## Finalize settings

### Finalize

DVD-R DVD-RW DVD+R DVD+RW

Finalizing 'fixes' the recordings in place so that the disc can be played on a regular DVD player or computer equipped with a suitable DVD-ROM drive.

It is also possible to finalize DVD+RW discs. This is only necessary if you want to a player to display a title menu for the disc.

See *Playing your recordings on other DVD players* on page 49 for detailed instructions.

### Undo Finalize

DVD-RW

You can undo the finalization on DVD-RW discs recorded on this recorder in Video mode. You need to do this if you want to record more material or edit material already on the disc.

You can also undo the finalization of VR mode discs which have been finalized on other DVD recorders. If when you load a disc the message **This disc cannot be recorded. Undo the finalization** is displayed, use this command to be able to record on the disc using this recorder.

1  Select 'Disc Setup' from the Home Menu.

2  Select 'Finalize' > 'Undo Finalize' then 'Start'.

#### Note

<sup>1</sup> Once initialized for VR mode recording it is not possible to re-initialize the disc for Video mode recording. Also, once recorded in Video mode, the disc cannot be re-initialized for VR mode recording.



## Optimize HDD

**HDD**

As you record, erase and edit recordings, the HDD file system gradually becomes fragmented. Periodically, the HDD will need optimizing to 'clean up' all the fragmented files.

When the HDD needs optimizing the recorder will automatically display a message recommending optimization.

**Important**

- Optimizing the HDD can take as long as eight hours. During optimization, playback and recording are not possible.
- Canceling optimization mid-way does not undo the optimization already done, so the HDD will be partly optimized.

**1**  Select 'Disc Setup' from the Home Menu.



**2** Select 'Optimize HDD' then 'Start'.

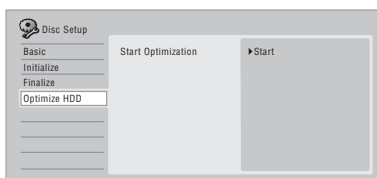

A progress bar indicates how long there is left to go.

## Initialize HDD

**HDD**

When your DVD recorder is working without a problem this option is not visible in the Disc Setup menu. However, if the HDD file system becomes corrupted for some reason, you can initialize the HDD to fix the problem. Note that initializing the HDD will erase all the data on it.

**1**  Select 'Disc Setup' from the Home Menu.



**2** Select 'Initialize HDD' then 'Start'.



## Chapter 13

# The Video Adjust menu

Using the Video Adjust menu you can set up the picture quality for the built-in tuner and external inputs, for disc playback, and for recording.

## Setting the picture quality for TV and external inputs

Picture Creation lets you choose a set of picture quality settings for the built-in TV tuner and for each external input. There are several preset settings that suit various sources, or you can create up to three of your own sets.

### Choosing a preset

1  With the recorder stopped, press to display the Home Menu.

2  Select 'Video Adjust'.

3  Select a preset.

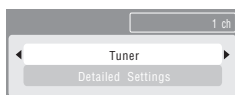

- Use the **INPUT SELECT** button to switch between the built-in TV tuner and the external inputs.
- Use the **◀◀/▶▶** buttons to change the channel of the built-in TV tuner.

There are six presets available:

- **Tuner** – suitable for general TV broadcasts
- **VCR** – suitable for video cassettes
- **DTV/LDP** – suitable for digital broadcasts and Laserdiscs
- **Memory1** – user preset 1
- **Memory2** – user preset 2
- **Memory3** – user preset 3

You can press **DISPLAY** to see the individual settings for the current preset (**Tuner**, **VCR** or **DTV/LDP**).

### Creating your own set

There are three user presets in which you can save your own set of picture quality settings.

1 **Follow** *Choosing a preset* above and **select one of the user presets (Memory 1, 2 or 3).**

2  Select 'Detailed Settings'.

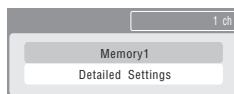

## The Video Adjust menu



- 3** Select the setting you want to adjust.

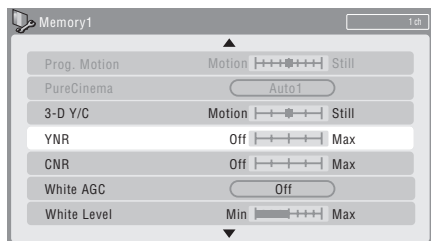

You can adjust the following settings:

- **Prog. Motion** – Adjusts the motion and still picture quality when video output is set to progressive.
- **PureCinema** – This setting optimizes the picture for film material when the video output is set to progressive. Usually this is best left set to **Auto 1**; try switching to **Auto 2**, **On** or **Off** if the picture appears unnatural.
- **3-D Y/C** – Adjusts the brightness / color separation.
- **YNR** – Adjusts the amount of noise reduction (NR) applied to the Y (brightness) component.
- **CNR** – Adjusts the amount of noise reduction (NR) applied to the C (color) component.

- **White AGC** – Turn on for automatic white level adjustment.<sup>1</sup>
- **White Level** – Adjusts the intensity of white.
- **Black Level** – Adjusts the intensity of black.
- **Black Setup** – Corrects the standard reference black level.
- **Hue** – Adjusts overall balance between red and green.
- **Chroma Level** – Adjusts how rich the colors appear.



- 4** Adjust the currently selected setting.

- 5**  Press to exit.

You can now use the preset for any other input or the built-in TV tuner.



### Tip

- To see more of the picture as you adjust different settings, press **ENTER** after selecting the setting you want to adjust.

### Note

<sup>1</sup> When **White AGC** is **On**, the **White Level** setting can't be adjusted.

## Setting the picture quality for disc playback

This setting determines how the picture will look when playing discs.

### Choosing a preset

1  With a disc playing (or paused), press to display the Home Menu.

2  Select 'Video Adjust'.

3  Select a setting.



There are six presets available:

- **TV** – suitable for LCD and cathode-ray tube TVs
- **PDP** – suitable for plasma display screens
- **Professional** – suitable for professional monitors
- **Memory1** – user preset 1
- **Memory2** – user preset 2
- **Memory3** – user preset 3

You can press **DISPLAY** to see the individual settings for the current preset (**TV**, **PDP** or **Professional**).

### Creating your own set

There are three user presets in which you can save your own set of picture quality settings for disc playback.

1 **Follow** *Choosing a preset above and select one of the user presets (Memory 1, 2 or 3).*

2 **Move the cursor down and select 'Detailed Settings'.**

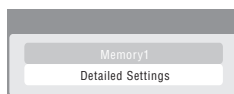

3 **Select the picture quality setting you want to adjust.**

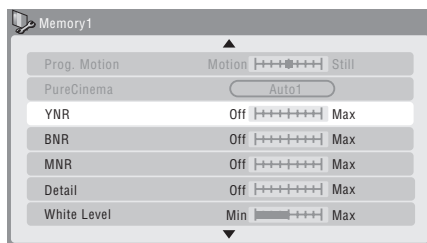

You can adjust the following settings:

- **Prog. Motion** – Adjusts the motion and still picture quality when video output is set to progressive.
- **PureCinema** – This setting optimizes the picture for film material when the video output is set to progressive. Usually this is best left set to **Auto 1**; try switching to **Auto 2**, **On** or **Off** if the picture appears unnatural.
- **YNR** – Adjusts the amount of noise reduction (NR) applied to the Y (brightness) component.

- **BNR** – Adjusts the amount of noise reduction (NR) applied to the block noise (artefacts visible in areas of flat color, caused by MPEG compression).
- **MNR** – Adjusts the amount of noise reduction (NR) applied to the mosquito noise (artefacts visible around the edges of an image, caused by MPEG compression).
- **Detail** – Adjusts how sharp edges appear.
- **White Level** – Adjusts the intensity of white.
- **Black Level** – Adjusts the intensity of black.
- **Black Setup** – Corrects the standard reference black level.
- **Gamma Correction** – Adjusts the brightness of darker images.
- **Hue** – Adjusts overall balance between red and green.
- **Chroma Level** – Adjusts how rich the colors appear.

**4 Use the ←/→ buttons to adjust the currently selected picture quality setting.**

**5 When you have all the settings as you want them, press HOME MENU to exit.**



### Tip

- To see more of the picture as you adjust different settings, press **ENTER** after selecting the setting you want to adjust.

## Chapter 14

# The Initial Setup menu

### Using the Initial Setup menu

The Initial Setup menu is where you can set various recorder options for sound, picture, language and so on.

Some settings can only be changed when the recorder is stopped. During playback and recording these settings are grayed out in the Initial Setup menu.

Except for the Setup Navigator, menu screens are exited automatically after 20 minutes of inactivity.

- **Press HOME MENU and select 'Initial Setup'.**

In the table below, the default option is marked with a •.

Setting	Options	Explanation
<b>Basic</b>		
<b>Clock Setting</b>	<b>Auto</b>	Set the channel that broadcasts a clock signal and the clock will be set automatically.
	<b>Manual •</b>	If there is no channel that broadcasts a clock signal in your area, you can set the time and date manually.
<i>The clock must be set in order to use timer recording.</i>		
<b>HELP Setting</b>	<b>On •</b>	Switches on the automatic Help screens for GUI displays.
	<b>Off</b>	Switches off the automatic Help screens for GUI displays. (Press <b>HELP</b> on the remote to manually display the Help screen.)
<b>Setup Navigator</b>	<b>Start</b>	Select to start the Setup Navigator. See also <i>Switching on and setting up</i> on page 30.
<b>Tuner</b>		
<b>Auto Channel Setting</b>	<b>Antenna •</b>	Select if you receive channels from an antenna. It takes a few moments for the auto tuning to complete.
	<b>Cable</b>	Select if you receive channels via cable. It takes a few moments for the auto tuning to complete.

Setting	Options	Explanation
<b>Manual CH Setting</b>	<b>Next Screen</b>	<p>Proceed to the next screen if you need to adjust any of the settings made by auto tuning.</p> <ul style="list-style-type: none"> <li>• Change channels using the <b>CH +/-</b> buttons.</li> <li>• To skip the displayed channel (because there is no station assigned to that channel), change the <b>Skip</b> setting to <b>On</b>.</li> <li>• To manually fine tune the channel, change the <b>AFT</b> setting to <b>Off</b> then adjust the <b>Level</b> setting.</li> </ul>
<b>VCR Plus+ CH Setting</b>		<p>Guide channels are used by the VCR Plus+ system so that the channel number specified in the VCR Plus+ programming numbers can be guaranteed to correspond to the correct station. Look in your TV guide to see which channel numbers should be assigned to which guide channels.</p> <ul style="list-style-type: none"> <li>• Use the <b>↑/↓</b> buttons to change the guide channel for setting.</li> <li>• Use the <b>←/→</b> buttons to change the channel number.</li> <li>• Use the <b>PREV ◀◀/ NEXT ▶▶</b> button to display the previous/next 10 guide channels.</li> <li>• To return to the Initial Setup menu, press <b>ENTER</b>.</li> </ul>
<b>Video In/Out</b>		
<b>Component Video Out</b>	<b>Interlace •</b>	Select if your monitor/TV is not compatible with progressive-scan video.
	<b>Progressive</b>	Select if your monitor/TV is progressive-scan compatible. Check the operating instructions that came with your monitor/TV if you're not sure.
<b>Audio In</b>		
<b>External Audio</b>	<b>Stereo •</b>	Select if the audio from the currently selected external input is standard stereo.
	<b>Dual Mono</b>	Select if each channel carries a separate soundtrack.
<b>Dual Mono Recording</b>	<b>L •</b>	Select to record the left channel of an external dual mono source when recording to DVD in Video mode, to HDD with HDD Recording Format set to Video Mode On, or in <b>LPCM</b> mode.
	<b>R</b>	As above, but for right channel recording.

Setting	Options	Explanation
<i>When recording dual mono audio to DVD in VR mode (except in LPCM mode), or to HDD with HDD Recording Format set to Video Mode Off (except in LPCM mode), both audio channels are recorded and you can switch to the one you want on playback.</i>		
<b>Audio Out</b>		
<b>Digital Out</b>	<b>On •</b>	Activates the digital audio output.
	<b>Off</b>	Deactivates the digital audio output.
<i>When set to <b>Off</b>, all the following Audio Out settings are grayed out.</i>		
<b>Dolby Digital Out</b>	<b>Dolby Digital •</b>	Output a Dolby Digital signal when a Dolby Digital source is being played.
	<b>Dolby Digital → PCM</b>	Convert Dolby Digital sources to Linear PCM output. Use if your connected equipment doesn't have a Dolby Digital decoder.
<b>DTS Out</b>	<b>On •</b>	Output a DTS signal when a DTS source is being played.
	<b>Off</b>	Switch off the digital output when a DTS source is being played. Use when your connected equipment doesn't have a DTS decoder. In this case, use the analog audio outputs.
<b>96 kHz PCM Out</b>	<b>96 kHz → 48 kHz •</b>	Convert 96 kHz digital audio sources to 48 kHz output. Use if your connected equipment doesn't support 96 kHz sampling rate.
	<b>96 kHz</b>	Output 96 kHz digital audio when a 96 kHz source is being played.
<b>MPEG Out</b>	<b>MPEG</b>	Output an MPEG audio signal when a source using MPEG audio is being played.
	<b>MPEG → PCM •</b>	Convert sources with MPEG audio to Linear PCM output. Use if your connected equipment doesn't have an MPEG audio decoder.
<b>Audio DRC</b>	<b>On</b>	Switches on Audio DRC (Dynamic Range Control). Use when listening to Dolby Digital material at low volume.
	<b>Off •</b>	Switches off Audio DRC.
<i>Audio DRC is not effective when listening via the digital output when the Dolby Digital Out setting is set to <b>Dolby Digital</b>.</i>		



Setting	Options	Explanation
<b>Language</b>		
<b>OSD Language</b>	<b>English •</b>	Sets the language of the on-screen displays to English.
	<b>Français</b>	Sets the language of the on-screen displays to French.
<b>Audio Language</b>	<b>English •</b>	Sets the default audio language for DVD-Video playback to English.
	<b>Français</b>	Sets the default audio language for DVD-Video playback to French.
	<b>Other</b>	Select to set the default audio language to something other than the ones listed. See <i>Selecting other languages for language options</i> on page 118.
<i>Discs do not necessarily have audio in your selected language. Also, some discs override the Audio Language preference.</i>		
<b>Subtitle Language</b>	<b>English •</b>	Sets the default subtitle language for DVD-Video playback to English.
	<b>Français</b>	Sets the default subtitle language for DVD-Video playback to French.
	<b>Other</b>	Select to set the default subtitle language to something other than the ones listed. See <i>Selecting other languages for language options</i> on page 118.
<i>Discs do not necessarily have subtitles in your selected menu language. Also, some discs override the Subtitle Language preference.</i>		
<b>Auto Language</b>	<b>On •</b>	On this setting: <ul style="list-style-type: none"> <li>• DVD-Video discs whose main audio track is in your default language will play using that language, without subtitles.</li> <li>• Discs whose main audio track is not in your default language but that have a subtitle track in your default language will play the original audio track with subtitles.</li> </ul>
	<b>Off</b>	Select to play DVD-Video discs according to your audio and subtitle language preferences.
<i>For Auto Language to be effective, the Audio Language and Subtitle Language options must be set to the same language.</i>		

Setting	Options	Explanation
<b>DVD Menu Language</b>	<b>w/Subtitle Language •</b>	Sets the language of DVD-Video menus to the same as that set for the subtitle language.
	<b>English</b>	Sets the language of DVD-Video menus to English.
	<b>Français</b>	Sets the language of DVD-Video menus to French.
	<b>Other</b>	Select to set the DVD menu language to something other than the ones listed. See <i>Selecting other languages for language options</i> on page 118.

*Discs do not necessarily have menus in your selected menu language.*

<b>Subtitle Display</b>	<b>On •</b>	Select to have discs display subtitles according to your Subtitle Language and Auto Language preferences.
	<b>Off</b>	Select to switch off subtitle display.
	<b>Assist Subtitle</b>	Select to display special additional assistive subtitles, where available.

*Some discs may override these settings.*

### Recording

<b>Manual Recording</b>	<b>On (go to setup)</b>	All the standard recording modes, plus <b>MN1</b> to <b>MN32</b> and <b>LPCM</b> modes can be set.
	<b>Off •</b>	Just the standard recording modes ( <b>XP</b> , <b>SP</b> , <b>LP</b> , <b>EP</b> , <b>SLP</b> and <b>SEP</b> ) can be set.

*See also Manual recording modes on page 125 for detailed information on manual recording levels.*

<b>Optimized Rec</b>	<b>On</b>	The recording quality of timer recordings is automatically adjusted to fit on to the selected media if it will not fit at the selected quality setting. If the recording will not fit even at <b>MN1</b> ( <b>MN4</b> for DVD+R/+RW), then the recording will start at <b>MN1</b> and stop when all the available space is used up.
	<b>Off •</b>	When a timer recording is set that won't fit on to the selected media, the recording starts but is cut off when no more recording is possible.

*Optimized Rec will only compensate for the next scheduled timer recording if more than one is set.*

Setting	Options	Explanation
<b>Set Thumbnail</b>	<b>0 seconds •</b>	Sets the default thumbnail picture in the Disc Navigator to the first frame of the title.
	<b>30 seconds</b>	Sets the default thumbnail picture to 30 seconds into the title.
	<b>3 minutes</b>	Sets the default thumbnail picture to 3 minutes into the title.
<b>Auto Chapter (Video)</b>	<b>No Separation</b>	Automatic chapter marking is switched off.
	<b>10 minutes •</b>	When recording in Video mode, chapter markers are inserted every 10 minutes.
	<b>15 minutes</b>	Chapter markers are inserted every 15 minutes.
<i>This settings applies to recording or real-time copying to Video mode DVD-R/-RW discs.</i>		
<b>Auto Chapter (DVD+R/+RW)</b>	<b>No Separation</b>	Automatic chapter marking is switched off.
	<b>10 minutes •</b>	When recording in Video mode, chapter markers are inserted every 10 minutes.
	<b>15 minutes</b>	Chapter markers are inserted every 15 minutes.
<b>DVD-RW Auto Init.</b>	<b>VR Mode •</b>	Blank DVD-RW discs are initialized for VR mode recording when loaded into the recorder for the first time.
	<b>Video Mode</b>	Blank DVD-RW discs are initialized for Video mode recording.
<b>HDD Recording Format</b>	<b>Video Mode Off</b>	Recordings made to the HDD are made in VR mode. Use this setting if you don't need to transfer the recording later to a Video mode DVD.
	<b>Video Mode On •</b>	Recordings made to the HDD are compatible with Video mode recordings. This setting is convenient if you want to transfer the recording to a Video mode DVD as high-speed copy can be used.

*When Video Mode On is used, you must select the audio channel you want to record when recording a broadcast with a SAP channel. On the Video Mode Off setting, both channels will be recorded and you can switch between them on playback. See also Dual Mono Recording on page 111.*

Setting	Options	Explanation
<b>Playback</b>		
<b>TV Screen Size</b>	<b>4:3 (Letter Box) •</b>	Select if you have a standard 4:3 TV and prefer the letter box format presentation for widescreen material.
	<b>4:3 (Pan &amp; Scan)</b>	Select if you have a standard 4:3 TV and prefer the pan and scan presentation for widescreen material.
	<b>16:9</b>	Select if you have a widescreen 16:9 TV. Your TV settings determine how 4:3 material will look.
<i>Selecting <b>4:3 (Letter Box)</b> or <b>4:3 (Pan &amp; Scan)</b> does not guarantee that all video material will be presented in that format as some discs override this setting.</i>		
<b>Still Picture</b>	<b>Field</b>	Produces a stable, generally shake-free image.
	<b>Frame</b>	Produces sharp image, but may be prone to shake.
	<b>Auto •</b>	Generates a generally less sharp but more stable still image.
<b>Seamless Playback</b>	<b>On</b>	Playback is smooth, but with a trade-off against the accuracy of the edit points.
	<b>Off •</b>	You may notice momentary interruption at edited points during playback of a VR mode Play List.
<i>This setting applies to HDD, DVD-R/-RW (VR) and DVD-RAM playback.</i>		
<b>Parental Lock</b>	<b>Set Password</b>	In order to change the parental lock level or change the country/area code, set the password using this option. From the following screen, enter a four-digit number that will be your password.
	<b>Change Password</b>	In order to change the password, first enter your existing password and then a new one from the following screen.
	<b>Change Level</b>	From the following screen, first enter your password and then set a parental lock level.
	<b>Country Code</b>	From the following screen, first enter your password and then set a country/area code.
<i>Only certain discs have parental lock and country/area code features. Check the disc packaging to see what features the disc has. If you forget your password you can reset it by resetting the recorder to its factory settings. See <i>Resetting the recorder on page 132.</i></i>		

Setting	Options	Explanation
<b>Angle Indicator</b>	<b>On</b> •	A camera icon appears on-screen during multi-angle scenes on a DVD-Video disc.
	<b>Off</b>	Nothing is indicated on-screen when a multi-angle scene is showing.
<b>Options</b>		
<b>On Screen Display</b>	<b>On</b> •	The recorder displays operation displays ( <b>Stop</b> , <b>Play</b> , etc.) on-screen.
	<b>Off</b>	Switches off the on-screen operation displays.
<b>Front Panel Display</b>	<b>On</b> •	The time is shown in the front panel display when the recorder is in standby.
	<b>Off</b>	The front panel display is switched off in standby (although it still lights dimly when setting a timer recording).
<b>Remote Control Mode</b>	<b>Recorder 1–3</b> (default: Recorder 1)	If you are using more than one recorder in the same room, set them to different IDs. This setting sets the recorder ID; to change the remote controller ID, press and hold <b>RETURN</b> then press <b>1</b> , <b>2</b> or <b>3</b> to set. The remote will only control a recorder with the same ID.
<b>DivX VOD</b>	<b>Registration Code</b>	Use to display the recorder's DivX registration code. See <i>DivX video compatibility</i> on page 12 and <i>DivX® VOD content</i> on page 13.
<b>Set Preview</b> (HDD only)	<b>Quick Preview</b> •	When in the Disc Navigator, the thumbnail video plays short excerpts from throughout the selected title. (Note that edited titles that will play normally from the beginning.)
	<b>Normal</b>	The thumbnail video plays from the beginning of the title.

### Additional information about component video output

If you switch the Component Video Out setting to **Progressive** when using a TV that is not compatible with progressive-scan video, you will not be able to see anything displayed on your TV. If this happens, press and hold the **■ STOP** button on the front panel, then press **▶ PLAY**. This will set the recorder's video output back to Interlace.

See *Language code list* on page 126 for a list of available languages and corresponding codes.

## Selecting other languages for language options



### 1 Select 'Other' from the language list.

This option appears in the settings for DVD Menu Language, Audio Language, and Subtitle Language.



### 2 Select the language you want.

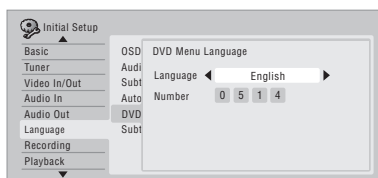

- Select by language name: Use the **←/→** buttons to change the language.
- Select by code number: Press **↓** then use the number buttons to enter the four-digit language code.

## Chapter 15

## Additional information

## Minimum copying times

The table below shows the minimum HDD to DVD copying time for one hour of video.

Please note that not all discs are compatible with high-speed copying.<sup>1</sup> Check with the disc manufacturer for compatibility.

Rec mode	DVD disc type					
	DVD-R / 1 x DVD-RW / 1 x	DVD-RW / 2 x DVD-R DL DVD-RAM / 2 x	DVD+R / 2.4 x DVD+RW / 2.4 x DVD+R DL	DVD-RAM / 3 x DVD-RAM / 5 x	DVD-R / 4 x DVD-RW / 4 x DVD+R / 4 x DVD+RW / 4 x	DVD-R / 8 x / 16 x DVD-RW / 6 x DVD+R / 8 x / 16 x DVD+RW / 8 x
	1 x	2 x	2.4 x	3 x	4 x	6 x
SEP	10 h 6 mins.	3 mins.	*1	2 mins.	1.5 mins.*1	1.25 mins.*1
SLP	8 h 7.5 mins.	4 mins.	*1	2.5 mins.	2 mins.*1	1.6 mins.*1
EP	6 h 10 mins.	5 mins.	*1	3.5 mins.	2.5 mins.*1	2.2 mins.*1
LP	4 h 15 mins.	7.5 mins.	6.3 mins.	5 mins.	4 mins.	3 mins.
SP	2 h 30 mins.	15 mins.	12.5 mins.	10 mins.	7.5 mins.	5.5 mins.
XP	1 h 60 mins.	30 mins.	25 mins.	20 mins.	15 mins.	11 mins.











Note that all times in the above table are approximate. Also that actual copy speed varies with the part of the disc being recorded.

\*1 Titles recorded on DVD+R/+RW in SEP, SLP or EP modes cannot be high-speed copied.

 Note

<sup>1</sup> Depending on the disc, the copy speed may be reduced (for example, although a 6 x disc is used, the copy may be made at 2 x speed).

## Screen sizes and disc formats

When viewing on a standard TV or monitor		
Screen format of disc	Setting	Appearance
<b>16:9</b> 	<b>4:3 (Letter Box)</b> 	The program is shown in widescreen with black bars at the top and bottom of the screen.
	<b>4:3 (Pan &amp; Scan)</b> 	The sides of the program are cropped so that the picture fills the whole screen.
<b>4:3</b> 	<b>4:3 (Letter Box)</b> <b>4:3 (Pan &amp; Scan)</b> 	The program is presented correctly on either setting.
When viewing on a widescreen TV or monitor		
Screen format of disc	Setting	Appearance
<b>16:9</b> 	<b>16:9</b> 	The program is presented in widescreen.
<b>4:3</b> 	<b>16:9</b>  	Your TV will determine how the picture is presented—check the manual that came with the TV for details.



## Troubleshooting

Incorrect operation is often mistaken for trouble and malfunction. If you think there is something wrong with this component, please check the points below. Sometimes the trouble may lie in another component. Investigate the other components and electrical appliances being used. If the trouble cannot be rectified even after checking the points below, ask your nearest Pioneer authorized service center or your dealer to carry out repair work.

### General

Problem	Remedy
<b>The disc is automatically ejected after closing the disc tray</b>	<ul style="list-style-type: none"> <li>• Check that the disc is not an incompatible format disc (page 9).</li> <li>• Check that the disc is loaded properly (aligned in disc tray and label-side up).</li> <li>• Take out the disc and clean it (page 131).</li> <li>• Check that the disc has a region code compatible with the recorder.</li> </ul>
<b>No picture</b>	<ul style="list-style-type: none"> <li>• Check that everything is connected properly (page 16).</li> <li>• Check that the connected TV and/or the AV amp/receiver is set to the correct input.</li> <li>• Make sure that the disc is NTSC format.</li> <li>• The recorder may be set to progressive scan with an incompatible TV. Reset to interlace by pressing and holding the front panel <b>■ STOP</b> button then pressing <b>▶ PLAY</b>.</li> </ul>
<b>Can't play a disc</b>	<ul style="list-style-type: none"> <li>• Check that the disc is a compatible format disc (page 9).</li> <li>• Take out the disc and clean it (page 131).</li> <li>• Check that the disc is loaded properly (aligned in disc tray and label-side up).</li> <li>• There may be condensation in the recorder. Leave the recorder for an hour or so for the condensation to evaporate.</li> <li>• DVD+R/+RW discs recorded using another recorder with copy-protect recordings will not play in this recorder.</li> </ul>
<b>Can't record a disc</b>	<ul style="list-style-type: none"> <li>• Check that the disc is not an incompatible format disc (page 9).</li> <li>• Some DVD-RAM discs are not recordable until they have been initialized (page 51). This can take up to 1 hour.</li> </ul>
<b>All settings are reset</b>	<ul style="list-style-type: none"> <li>• If the recorder is unplugged (or there is a power failure) while the recorder is on, all the settings will be lost.</li> <li>• Make sure that you switch the recorder into standby before unplugging the power cord.</li> </ul>

Problem	Remedy
<b>Remote control does not work</b>	<ul style="list-style-type: none"> <li>• If you connected this recorder to another Pioneer product using the <b>CONTROL IN</b> jack, point the remote control at the other component to use (page 16).</li> <li>• Set the remote control to the same ID number as the recorder (page 117). (When the batteries run down, the remote mode is automatically reset to <b>Recorder1</b>.)</li> <li>• Use the remote within its operating range (page 8).</li> <li>• Replace the batteries (page 8).</li> </ul>
<b>No sound or sound is distorted</b>	<ul style="list-style-type: none"> <li>• Make sure that the amp/receiver or TV is set to the correct input and the volume turned up.</li> <li>• There is no sound when the picture is paused, or during scanning or slow motion play. Press ► <b>PLAY</b> to resume regular playback.</li> <li>• DTS discs can only be played if this recorder is connected to a DTS decoder or DTS compatible amp/receiver. If you have connected a suitable decoder, also make sure that the <b>Initial Setup &gt; Audio Out &gt; DTS Out</b> setting is <b>On</b>.</li> <li>• Some 96 kHz discs do not output audio through the digital jack. In this case, switch the input of your amp/receiver to analog.</li> <li>• Check the audio cable connections (page 16).</li> <li>• If the sound is distorted, try cleaning the cable plugs.</li> </ul>
<b>Cannot switch a dual mono program</b>	<ul style="list-style-type: none"> <li>• During real-time copying it is not possible to switch audio channels. The main and sub channels are both output.</li> </ul>
<b>The picture from the external input is distorted</b>	<ul style="list-style-type: none"> <li>• If the video signal from the external component is copy-protected, you cannot connect via this recorder. Connect the component directly to your TV.</li> </ul>
<b>Screen is stretched vertically or horizontally</b>	<ul style="list-style-type: none"> <li>• Make sure that the <b>TV Screen Size</b> setting (page 116) is correct for the kind of TV you have (see also page 120).</li> <li>• If you have a widescreen TV, check its aspect ratio settings.</li> <li>• This recorder's input switches into wide mode automatically according to the input signal. When the unit connected is not compatible with VIDEO ID-1 (widescreen signalling), set the connected component to output 4:3 aspect ratio (standard) video.</li> </ul>

Problem	Remedy
<b>Can't play a disc recorded using this recorder on another player</b>	<ul style="list-style-type: none"> <li>• If the disc was recorded in Video mode, make sure that it's finalized (page 49).</li> <li>• Some players will not play recordable DVD discs, even when recorded in Video mode and finalized.</li> <li>• If the disc was recorded in VR mode, the other player must be specifically RW compatible in order to play it (page 9).</li> <li>• Discs recorded with copy-once material cannot be played on non-CPRM compatible players (page 35).</li> <li>• DVD+RW discs containing only a small amount of recorded material may not play on other players. Finalize the disc and try again.</li> </ul>
<b>During playback the picture is dark or distorted</b>	<ul style="list-style-type: none"> <li>• When a copy-protected disc is played via a VCR, the picture will not display correctly. Connect the recorder directly to your TV.</li> </ul>
<b>Can't record or does not record successfully</b>	<ul style="list-style-type: none"> <li>• Check that there is some remaining blank space on the DVD/HDD.</li> <li>• For a Video mode disc or DVD+R, check that the disc isn't already finalized.</li> <li>• Check the limits on the number of titles and chapters on a disc:               <ul style="list-style-type: none"> <li>– HDD: 999 titles</li> <li>– VR mode: 99 titles, 999 chapters per disc</li> <li>– Video mode disc: 99 titles per disc, 99 chapters per title</li> <li>– DVD+R/+RW: 49 titles per disc, 99 chapters per title (max 254 chapters per disc)</li> </ul> </li> <li>• Check that the source you are trying to record is not copy protected.</li> <li>• For a VR formatted disc, check that the disc isn't locked (page 103).</li> <li>• The power may have failed during recording.</li> </ul>
<b>Timer program doesn't record successfully</b>	<ul style="list-style-type: none"> <li>• When setting the recording channel, make sure you set the recorder's built-in TV tuner, not the TV's built-in tuner.</li> <li>• When recording to a Video mode disc, programs that are copy-once protected cannot be recorded. Use a VR mode formatted disc for copy-once material (page 35).</li> <li>• Two timer programs may have overlapped, in which case only the earlier one will record completely.</li> <li>• The power may have failed during recording.</li> </ul>
<b>After briefly unplugging or after a power failure the front panel display shows '---:--'</b>	<ul style="list-style-type: none"> <li>• A backup battery inside the recorder keeps the clock and other settings from being reset when there is no power to the recorder. After unplugging or a power failure, the battery keeps all settings for a period of several minutes. Reset the clock and other recorder settings to use the recorder again.</li> </ul>

Problem	Remedy
Front panel display shows 'LOCK' when a button is pressed	<ul style="list-style-type: none"> <li>The Child Lock is on; turn off in order to use the recorder (page 46).</li> </ul>
Can't use One Touch Copy (HDD to DVD)	<ul style="list-style-type: none"> <li>Make sure that there is a recordable DVD-R/+RW loaded with some free space for recording and fewer than 99 titles already on the disc. Also make sure that for a Video mode disc or a DVD+R, the disc isn't finalized.</li> <li>Make sure there is a recordable DVD+R/+RW loaded with some free space for recording and fewer than 49 titles already on the disc.</li> <li>If you delete a title from a DVD+R/+RW disc, the number of remaining recordable titles may not decrease.</li> <li>Further recording is not possible on a finalized DVD+R. Check that there isn't a disc menu on the disc you're trying to use.</li> <li>If the title currently playing contains material that is copy-once protected, One Touch Copy will not work.</li> <li>One Touch Copy can't be used for titles over 8 hours long when copying to DVD+R/+RW (though you can use a DVD+R DL).</li> <li>One Touch Copy can't be used for <b>MN1</b> to <b>MN6</b>, <b>SEP</b>, <b>SLP</b> or <b>EP</b> titles when copying to DVD+R/+RW.</li> <li>One Touch Copy doesn't work if the recorder is already recording to DVD.</li> </ul>
Can't use One Touch Copy (DVD to HDD)	<ul style="list-style-type: none"> <li>Make sure that there is space available on the HDD and that there are fewer than 999 titles on the HDD.</li> <li>One Touch Copy doesn't work if the recorder is already recording to the HDD.</li> </ul>
The picture freezes and the front panel and remote control buttons stop working	<ul style="list-style-type: none"> <li>Press <b>■ STOP</b> then try restarting playback.</li> <li>Press the front panel <b>⏻ STANDBY/ON</b> button to switch the power off, then switch back on and restart playback. If the power fails to switch off, press and hold <b>⏻ STANDBY/ON</b> for 5 seconds until the power switches off.</li> </ul>
A device connected via USB does to function. (DVR-640H-S/DVR-543H-S only)	<ul style="list-style-type: none"> <li>Check that it is a device that may be connected to this unit (digital camera, USB memory, memory card reader or printer).</li> <li>Use a USB cable less than 5 m in length.</li> <li>Check that the USB cable is inserted fully.</li> <li>Check that the USB device is powered on.</li> <li>Only the first digital camera, USB memory or memory card reader connected is readable by this unit. Unplug multiple devices and connect the device you want to use first.</li> </ul>

*If the unit does not operate normally due to external effects such as static electricity, disconnect the power plug from the outlet and insert again to return to normal operating conditions.*

## Manual recording modes

The table below shows the approximate recording times for the HDD and the different DVD types in each manual recording mode, as well as the standard recording mode equivalents.

Video mode Off (HDD) VR mode (DVD)				Video mode On (HDD) Video mode (DVD), DVD+R/+RW		
Resolution	Level	Rec. time		Level	Rec. time	Resolution
352 x 240	MN 1	802 mins.		MN 1 <sup>*1,2</sup>	802 mins.	352 x 240
	MN 2	720 mins.		MN 2 <sup>*1,2</sup>	720 mins.	
	MN 3	600 mins.	SEP	MN 3 <sup>*1,2</sup>	600 mins.	
	MN 4	480 mins.	SLP	MN 4 <sup>*2</sup>	480 mins.	
	MN 5	420 mins.		MN 5 <sup>*2</sup>	420 mins.	
	MN 6	360 mins.	EP	MN 6 <sup>*2</sup>	360 mins.	
352 x 480	MN 7	300 mins.		MN 7	300 mins.	352 x 480
	MN 8	270 mins.		MN 8	270 mins.	
480 x 480	MN 9	240 mins.	LP	MN 9	240 mins.	720 x 480
	MN 10	230 mins.		MN 10	230 mins.	
	MN 11	220 mins.		MN 11	220 mins.	
544 x 480	MN 12	210 mins.		MN 12	210 mins.	
	MN 13	200 mins.		MN 13	200 mins.	
	MN 14	190 mins.		MN 14	190 mins.	
	MN 15	180 mins.		MN 15	180 mins.	
	MN 16	170 mins.		MN 16	170 mins.	
720 x 480	MN 17	160 mins.		MN 17	160 mins.	
	MN 18	150 mins.		MN 18	150 mins.	
	MN 19	140 mins.		MN 19	140 mins.	
	MN 20	130 mins.		MN 20	130 mins.	
	MN 21	120 mins.	SP	MN 21	120 mins.	
	MN 22	110 mins.		MN 22	110 mins.	
	MN 23	105 mins.		MN 23	105 mins.	
	MN 24	100 mins.		MN 24	100 mins.	
	MN 25	95 mins.		MN 25	95 mins.	
	MN 26	90 mins.		MN 26	90 mins.	
	MN 27	85 mins.		MN 27	85 mins.	
	MN 28	80 mins.		MN 28	80 mins.	
	MN 29	75 mins.		MN 29	75 mins.	
	MN 30	70 mins.		MN 30	70 mins.	
	MN 31	65 mins.		MN 31	65 mins.	
	MN 32	61 mins.	XP	MN 32	61 mins.	
LPCM	61 mins.		LPCM	61 mins.		

<sup>\*1</sup> Modes **MN1** to **MN3** not available when using DVD+R/+RW.

<sup>\*2</sup> Titles recorded at **MN6** or lower cannot be high-speed copied to DVD+R/+RW.

- Levels separated by a bold line show where there is a noticeable change in picture quality.
- Audio recording in all manual recording modes is in Dolby Digital 2 ch format, except for LPCM mode, which is in Linear PCM format.
- When recording to the HDD, recording for the times given will use approximately 4.7 GB of HDD space (equivalent to one recordable DVD).
- See also Recording on page 33.

## Language code list

Language (Language code letter), **Language code**

Japanese (ja), <b>1001</b>	Bhutani (dz), <b>0426</b>	Kirghiz (ky), <b>1125</b>	Serbo-Croatian (sh), <b>1908</b>
English (en), <b>0514</b>	Esperanto (eo), <b>0515</b>	Latin (la), <b>1201</b>	Sinhalese (si), <b>1909</b>
French (fr), <b>0618</b>	Estonian (et), <b>0520</b>	Lingala (ln), <b>1214</b>	Slovak (sk), <b>1911</b>
German (de), <b>0405</b>	Basque (eu), <b>0521</b>	Laotian (lo), <b>1215</b>	Slovenian (sl), <b>1912</b>
Italian (it), <b>0920</b>	Persian (fa), <b>0601</b>	Lithuanian (lt), <b>1220</b>	Samoan (sm), <b>1913</b>
Spanish (es), <b>0519</b>	Finnish (fi), <b>0609</b>	Latvian (lv), <b>1222</b>	Shona (sn), <b>1914</b>
Chinese (zh), <b>2608</b>	Fiji (fj), <b>0610</b>	Malagasy (mg), <b>1307</b>	Somali (so), <b>1915</b>
Dutch (nl), <b>1412</b>	Faroese (fo), <b>0615</b>	Maori (mi), <b>1309</b>	Albanian (sq), <b>1917</b>
Portuguese (pt), <b>1620</b>	Frisian (fy), <b>0625</b>	Macedonian (mk), <b>1311</b>	Serbian (sr), <b>1918</b>
Swedish (sv), <b>1922</b>	Irish (ga), <b>0701</b>	Malayalam (ml), <b>1312</b>	Siswati (ss), <b>1919</b>
Russian (ru), <b>1821</b>	Scots-Gaelic (gd), <b>0704</b>	Mongolian (mn), <b>1314</b>	Sesotho (st), <b>1920</b>
Korean (ko), <b>1115</b>	Galician (gl), <b>0712</b>	Moldavian (mo), <b>1315</b>	Sundanese (su), <b>1921</b>
Greek (el), <b>0512</b>	Guarani (gn), <b>0714</b>	Marathi (mr), <b>1318</b>	Swahili (sw), <b>1923</b>
Afar (aa), <b>0101</b>	Gujarati (gu), <b>0721</b>	Malay (ms), <b>1319</b>	Tamil (ta), <b>2001</b>
Abkhazian (ab), <b>0102</b>	Hausa (ha), <b>0801</b>	Maltese (mt), <b>1320</b>	Telugu (te), <b>2005</b>
Afrikaans (af), <b>0106</b>	Hindi (hi), <b>0809</b>	Burmese (my), <b>1325</b>	Tajik (tg), <b>2007</b>
Amharic (am), <b>0113</b>	Croatian (hr), <b>0818</b>	Nauru (na), <b>1401</b>	Thai (th), <b>2008</b>
Arabic (ar), <b>0118</b>	Hungarian (hu), <b>0821</b>	Nepali (ne), <b>1405</b>	Tigrinya (ti), <b>2009</b>
Assamese (as), <b>0119</b>	Armenian (hy), <b>0825</b>	Norwegian (no), <b>1415</b>	Turkmen (tk), <b>2011</b>
Aymara (ay), <b>0125</b>	Interlingua (ia), <b>0901</b>	Occitan (oc), <b>1503</b>	Tagalog (tl), <b>2012</b>
Azerbaijani (az), <b>0126</b>	Interlingue (ie), <b>0905</b>	Oromo (om), <b>1513</b>	Setswana (tn), <b>2014</b>
Bashkir (ba), <b>0201</b>	Inupiak (ik), <b>0911</b>	Oriya (or), <b>1518</b>	Tonga (to), <b>2015</b>
Byelorussian (be), <b>0205</b>	Indonesian (in), <b>0914</b>	Panjabi (pa), <b>1601</b>	Turkish (tr), <b>2018</b>
Bulgarian (bg), <b>0207</b>	Icelandic (is), <b>0919</b>	Polish (pl), <b>1612</b>	Tsonga (ts), <b>2019</b>
Bihari (bh), <b>0208</b>	Hebrew (iw), <b>0923</b>	Pashto, Pushto (ps), <b>1619</b>	Tatar (tt), <b>2020</b>
Bislama (bi), <b>0209</b>	Yiddish (ji), <b>1009</b>	Quechua (qu), <b>1721</b>	Twi (tw), <b>2023</b>
Bengali (bn), <b>0214</b>	Javanese (jw), <b>1023</b>	Rhaeto-Romance (rm), <b>1813</b>	Ukrainian (uk), <b>2111</b>
Tibetan (bo), <b>0215</b>	Georgian (ka), <b>1101</b>	Kirundi (rn), <b>1814</b>	Urdu (ur), <b>2118</b>
Breton (br), <b>0218</b>	Kazakh (kk), <b>1111</b>	Romanian (ro), <b>1815</b>	Uzbek (uz), <b>2126</b>
Catalan (ca), <b>0301</b>	Greenlandic (kl), <b>1112</b>	Kinyarwanda (rw), <b>1823</b>	Vietnamese (vi), <b>2209</b>
Corsican (co), <b>0315</b>	Cambodian (km), <b>1113</b>	Sanskrit (sa), <b>1901</b>	Volapük (vo), <b>2215</b>
Czech (cs), <b>0319</b>	Kannada (kn), <b>1114</b>	Sindhi (sd), <b>1904</b>	Wolof (wo), <b>2315</b>
Welsh (cy), <b>0325</b>	Kashmiri (ks), <b>1119</b>	Sangho (sg), <b>1907</b>	Xhosa (xh), <b>2408</b>
Danish (da), <b>0401</b>	Kurdish (ku), <b>1121</b>		Yoruba (yo), <b>2515</b>
			Zulu (zu), <b>2621</b>

## Country/Area code list

Country/Area, Country/Area code, Code letter

Argentina, <b>0118, ar</b>	Finland, <b>0609, fi</b>	Malaysia, <b>1325, my</b>	Singapore, <b>1907, sg</b>
Australia, <b>0121, au</b>	France, <b>0618, fr</b>	Mexico, <b>1324, mx</b>	Spain, <b>0519, es</b>
Austria, <b>0120, at</b>	Germany, <b>0405, de</b>	Netherlands, <b>1412, nl</b>	Sweden, <b>1905, se</b>
Belgium, <b>0205, be</b>	Hong Kong, <b>0811, hk</b>	New Zealand, <b>1426, nz</b>	Switzerland, <b>0308, ch</b>
Brazil, <b>0218, br</b>	India, <b>0914, in</b>	Norway, <b>1415, no</b>	Taiwan, <b>2023, tw</b>
Canada, <b>0301, ca</b>	Indonesia, <b>0904, id</b>	Pakistan, <b>1611, pk</b>	Thailand, <b>2008, th</b>
Chile, <b>0312, cl</b>	Italy, <b>0920, it</b>	Philippines, <b>1608, ph</b>	United Kingdom, <b>0702, gb</b>
China, <b>0314, cn</b>	Japan, <b>1016, jp</b>	Portugal, <b>1620, pt</b>	USA, <b>2119, us</b>
Denmark, <b>0411, dk</b>	Korea, Republic of, <b>1118, kr</b>	Russian Federation, <b>1821, ru</b>	

## Additional information for cable/satellite/STB (set-top box) users

The following instructions show how to use the timer features of your STB with this recorder.

### Setting up

**1 Connect the STB's audio/video outputs to a set of audio/video inputs on this recorder.**

**2 Switch on both the STB and this recorder and switch the recorder's input function to the STB (L1, L2 or L3).**

To check that everything is connected properly, switch on your TV and select this recorder as the video input. You should see whatever the STB is tuned to.

**3 Program the IR controller supplied with your STB to send start/stop recording codes for a Pioneer VCR.**

See the manual that came with the STB for how to do this.

Only the **REC** and **STOP** codes have any effect when used with this recorder:

- **REC** – Start recording
- **STOP** – Stop recording

**4 Position the IR controller so that it will control this recorder.**

The IR sensor on the recorder is located just above the  mark on the front panel.

### Making a timer recording

**1 Set the timer on the STB.**

See the manual that came with your STB for how to do this.

**2 Switch on this recorder.**

You must leave the recorder on until the recording finishes.

- At the programmed times, the STB will start and stop recording on this recorder.

## On-screen displays and recorder displays

The table below shows a list of error messages that you may encounter when using the recorder and an explanation of their meaning.

Message	Explanation/Action
<ul style="list-style-type: none"> <li>• <b>Initializing disc. Please wait a moment.</b></li> </ul>	When you load a blank DVD-RW or DVD+RW disc, the recorder automatically initializes it.
<ul style="list-style-type: none"> <li>• <b>Incompatible region number.</b></li> </ul>	The disc loaded has an incompatible region number for the recorder and so will not play.
<ul style="list-style-type: none"> <li>• <b>Cannot record any more titles.</b></li> <li>• <b>No more space for file management data.</b></li> </ul>	The disc control data limit has been reached, or the maximum number of chapters and/or titles has been reached. Erase titles/chapters or combine chapters.
<ul style="list-style-type: none"> <li>• <b>This disc cannot be recorded. Undo the finalization.</b></li> </ul>	The disc was finalized on a non-Pioneer DVD recorder. Undo the finalization in order to recording/editing.
<ul style="list-style-type: none"> <li>• <b>Cannot play this disc.</b></li> <li>• <b>This disc cannot be recorded.</b></li> <li>• <b>Cannot read the CPRM information.</b></li> <li>• <b>Could not record the information to the disc.</b></li> <li>• <b>Cannot edit.</b></li> <li>• <b>Could not initialize disc.</b></li> <li>• <b>Could not complete finalization successfully.</b></li> <li>• <b>Could not undo finalization successfully.</b></li> <li>• <b>Could not successfully unlock the disc.</b></li> </ul>	The disc may be dirty or damaged. Take out the disc, clean it and retry. If the error persists, use a new disc. If the error appears even with a new disc, please consult a Pioneer Service Center.
<ul style="list-style-type: none"> <li>• <b>Incompatible or unreadable disc.</b></li> </ul>	The disc loaded is a playback-only disc type. This display may also appear if the disc is dirty or damaged.
<ul style="list-style-type: none"> <li>• <b>Cannot record to a disc that is not CPRM compatible.</b></li> <li>• <b>Cannot record this content using Video mode recording.</b></li> <li>• <b>This video cannot be recorded to DVD+R/+RW.</b></li> </ul>	The video source is copy-once protected. Use a VR mode DVD-R/-RW disc with CPRM for recording.



Message	Explanation/Action
<ul style="list-style-type: none"> <li>• <b>This content is copy protected.</b></li> </ul>	The video source is copy-protected and cannot be recorded.
<ul style="list-style-type: none"> <li>• <b>Incorrect CPRM information.</b></li> </ul>	The recorder could not read the CPRM information. The recorder may be damaged—please consult a Pioneer Service Center.
<ul style="list-style-type: none"> <li>• <b>Repairing disc.</b></li> <li>• <b>Repairing the HDD.</b></li> </ul>	During recording, the power was cut. This display appears when the power is restored.
<ul style="list-style-type: none"> <li>• <b>Could not repair the disc.</b></li> </ul>	The recorder was unable to repair the disc after a power cut. The contents of the recording will be lost.
<ul style="list-style-type: none"> <li>• <b>Overheating has stopped operation. Press DISPLAY to clear this message.</b></li> </ul>	The internal temperature of the recorder has exceeded the operating limit. If this message reappears, please contact a Pioneer authorized service center.
<ul style="list-style-type: none"> <li>• <b>HDD optimization is recommended. This can be done using Disc Setup.</b></li> </ul>	The HDD should be optimized (basically, HDD housekeeping) to maintain playback and recording performance.
<ul style="list-style-type: none"> <li>• <b>Please perform HDD optimization. This can be done using Disc Setup.</b></li> </ul>	The HDD is in more urgent need of optimization in order to maintain performance.
<ul style="list-style-type: none"> <li>• <b>The HDD has not been sufficiently optimized. Please optimize again.</b></li> </ul>	If this message appears repeatedly after optimizing the HDD it is likely that there is not enough free space on the HDD for optimization to complete properly. Please erase some titles from the HDD and optimize again.
<p><b>Searching for printer. Please wait a moment.</b></p>	This message is displayed when the recorder is scanning for a connected printer, or when the printer is not yet ready for printing. If there is no printer connected, please connect one.
<p><b>The printer is not ready or there is no printer connected. Please check the printer status.</b></p>	This message is displayed when communication could not be established with the printer. See the Troubleshooting section if you do not know the cause.

Message	Explanation/Action
<b>Printing has stopped because ...</b>	This message is displayed when there is a printer error during printing. After checking the printer for the cause of the error, select "Yes" to resume printing. Select "No" to cancel the print job. See also the operating instructions that came with your printer for possible causes of print errors.
<b>The print job has been canceled because ...</b>	This message is displayed when there is a printer error during printing. After checking the printer for the cause of the error, reconnect the printer and start the printing job again. See also the operating instructions that came with your printer for possible causes of print errors.

## Handling discs

When holding discs of any type, take care not to leave fingerprints, dirt or scratches on the disc surface. Hold the disc by its edge or by the center hole and edge.

Damaged or dirty discs can affect playback and recording performance. Take care also not to scratch the label side of the disc. Although not as fragile as the recorded side, scratches can still result in a disc becoming unusable.

Should a disc become marked with fingerprints, dust, etc., clean using a soft, dry cloth, wiping the disc lightly from the center to the outside edge. Do not clean discs with a circular motion.



If necessary, use a cloth soaked in alcohol, or a commercially available CD/DVD cleaning kit to clean a disc more thoroughly. Never use benzine, thinner or other cleaning agents, including products designed for cleaning vinyl records.

## Storing discs

Although CDs and DVD discs are more durable than vinyl records, you should still take care to handle and store discs correctly. When you're not using a disc, return it to its case and store upright. Avoid leaving discs in excessively cold, humid, or hot environments (including under direct sunlight).

Don't glue paper or put stickers onto the disc, or use a pencil, ball-point pen or other sharp-tipped writing instrument. These could all damage the disc.



For more detailed care information see the instructions that come with discs.

Do not load more than one disc into the recorder.

## Damaged discs

Discs spin at high speed inside the recorder. If you can see that a disc is cracked, chipped, warped, or otherwise damaged, don't risk using it; you could end up damaging the recorder.

This recorder is designed for use with conventional, fully circular discs only. Use of shaped discs is not recommended for this product. Pioneer disclaims all liability arising in connection with the use of shaped discs.

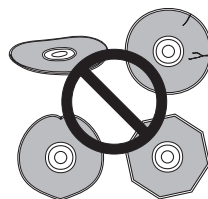

## Cleaning the pickup lens

The DVD recorder's lens should not become dirty in normal use, but if for some reason it should malfunction due to dust or dirt, consult your nearest Pioneer-authorized service center. Although lens cleaners are commercially available, we do not recommend using them since some may damage the lens.

## Condensation

Condensation may form inside the recorder if it is brought into a warm room from outside, or if the temperature of the room rises quickly. Although the condensation won't damage the recorder, it may temporarily impair its performance. For this reason you should leave it to adjust to the warmer temperature for about an hour before switching on and using.

## Hints on installation

We want you to enjoy using this unit for years to come, so please bear in mind the following points when choosing a suitable location for it:

### Do...

- ✓ Use in a well-ventilated room.
- ✓ Place on a solid, flat, level surface, such as a table, shelf or stereo rack.

### Don't...

- ✗ Use in a place exposed to high temperatures or humidity, including near radiators and other heat-generating appliances.
- ✗ Place on a window sill or other place where the recorder will be exposed to direct sunlight.
- ✗ Use in a dusty or damp environment or in a room where it will be exposed to excessive cigarette smoke.
- ✗ Place directly on top of an amplifier, or other component in your stereo system that becomes hot in use.
- ✗ Use near a television or monitor as you may experience interference—especially if the television uses an indoor antenna.

- ✗ Use in a kitchen or other room where the recorder may be exposed to smoke or steam.
- ✗ Use on a thick rug or carpet, or cover with cloth—this may prevent proper cooling of the unit.
- ✗ Place on an unstable surface, or one that is not large enough to support all four of the unit's feet.

## Moving the recorder

If you need to move the recorder, first remove the disc, if there's one loaded, and close the disc tray. Next, press **⏻ STANDBY/ON** to switch the power to standby, checking that the **POWER OFF** indication in the display goes off. Wait at least two minutes. Lastly, disconnect the power cord. Never lift or move the unit during playback or recording—discs rotate at a high speed and may be damaged.

## Resetting the recorder

If you need to, you can reset the recorder to all its factory settings.

- 1 Make sure that the recorder is on.**
- 2 Using the front panel controls, press and hold **■ STOP** and press **⏻ STANDBY/ON**.**

The recorder turns off with all settings reset.

## Specifications

### General

Power requirements	120 V, 60 Hz
Power consumption	37 W
Power consumption in standby mode	0.29 W (Front panel display: off)
Weight	
DVR-640H-S/DVR-543H-S	4.3 kg(9 lb. 8 oz.)
DVR-540H-S	4.2 kg(9 lb. 5 oz.)
Dimensions	420 mm (W) x 69 mm (H) x 318 mm (D) (16 9/16 in. (W) x 2 3/4 in. (H) 12 9/16 in. (D))
Operating temperature	+5 °C to +35 °C (+41 °F to +95 °F)
Operating humidity	5 % to 85 % (no condensation)
TV system	NTSC

### Readable discs

DVD-Video, DVD-RW, DVD-R, DVD+R, DVD+RW, DVD-RAM, Video CD, CD, CD-R/RW (WMA, MP3, JPEG, CD-DA)

### Recording discs and formats

DVD-R/RW: VR mode and Video mode  
 DVD+R/+RW: +VR mode  
 DVD-RAM: VR mode  
 DVD-R DL: VR mode and Video mode  
 DVD+R DL: +VR mode

### Video recording format

Sampling frequency 13.5 MHz  
 Compression format MPEG

### Audio recording format

Sampling frequency 48 kHz  
 Compression format Dolby Digital or Linear PCM  
 (uncompressed)

### Recording time

#### HDD

#### DVR-640H-S (160 GB)

Fine (XP)	Approx. 34 h
Standard Play (SP)	Approx. 68 h
Long Play (LP)	Approx. 136 h
Extended Play (EP)	Approx. 204 h
Super Long Play (SLP)	Approx. 272 h
Super Extended Play (SEP)	Approx. 340 h
Manual Mode (MN)	Approx. 34 h to 455 h

#### DVR-543/540H-S (80 GB)

Fine (XP)	Approx. 17 h
Standard Play (SP)	Approx. 34 h
Long Play (LP)	Approx. 68 h
Extended Play (EP)	Approx. 102 h
Super Long Play (SLP)	Approx. 136 h
Super Extended Play (SEP)	Approx. 170 h
Manual Mode (MN)	Approx. 17 h to 227 h

#### DVD-R/-RW, DVD+R/+RW, DVD-RAM

Fine (XP)	Approx. 1 h
Standard Play (SP)	Approx. 2 h
Long Play (LP)	Approx. 4 h
Extended Play (EP)	Approx. 6 h
Super Long Play (SLP)	Approx. 8 h
Super Extended Play (SEP)	Approx. 10 h (DVD-R/-RW, DVD-RAM only)

#### Manual Mode (MN)

DVD-R/-RW/-RAM	Approx. 1 h to 13 h
DVD+R/+RW	Approx. 1 h to 8 h

#### DVD-R DL/DVD+R DL

Fine (XP)	Approx. 1 h 51 m
Standard Play (SP)	Approx. 3 h 35 m
Long Play (LP)	Approx. 7 h 11 m
Extended Play (EP)	Approx. 10 h 46 m
Super Long Play (SLP)	Approx. 14 h 21 m
Super Extended Play (SEP)	Approx. 17 h 57 m (DVD-R DL only)

#### Manual Mode (MN)

DVD-R DL	Approx. 1 h 51 m to 24 h
DVD+R DL	Approx. 1 h 51 m to 14 h 21 m

## Tuner

### Receivable channels

VHF	2 ch to 13 ch
UHF	14 ch to 69 ch
CATV	C1 ch to C125 ch

## Timer

Programs	1 month/32 programs
Clock	Quartz lock (12-hour digital display)

## Input/Output

VHF/UHF antenna input/output terminal VHF/UHF set	75 $\Omega$ (F-shape connector)
Video input	Input 1,3 (rear), 2 (front)
Input level	1 Vp-p (75 $\Omega$ )
Jacks	RCA jack
Video output	Output 1,2
Output level	1 Vp-p (75 $\Omega$ )
Jacks	RCA jack
S-Video input	Input 1, 3 (rear), 2 (front)
Y (luminance) - Input level	1 Vp-p (75 $\Omega$ )
C (color) - Input level	300 mVp-p (75 $\Omega$ )
Jacks	.4 pin mini DIN
S-Video output	Output 1,2
Y (luminance) - Output level	1 Vp-p (75 $\Omega$ )
C (color) - Output level	300 mVp-p (75 $\Omega$ )
Jacks	.4 pin mini DIN
Component video output	
Output level	Y: 1.0 Vp-p (75 $\Omega$ ) P <sub>B</sub> , P <sub>R</sub> : 0.7 Vp-p (75 $\Omega$ )
Jacks	RCA jacks
Audio input	Input 1, 3 (rear), 2 (front) L/R
Input level	
During audio input	2V rms (Input impedance: more than 22 k $\Omega$ )
Jacks	RCA jacks
Audio output	Output 1,2 L/R
During audio output	2V rms (Output impedance: less than 1.5 k $\Omega$ )
Jacks	RCA jacks
Control input	Mini jack
Digital audio output	Coaxial
USB	Type A (front), Type B (front) (DVR-640H-S/DVR-543H-S only)

## Supplied accessories

Remote control	1
Dry cell batteries (AA/R6P)	2
Audio / Video cable (red/white/yellow)	1
RF antenna cable	1
Power cable	1
Quick start guide	
Operating Instructions	
Warranty card	1

*Note: The specifications and design of this product are subject to change without notice, due to improvement.*

Should this product require service in the U.S.A. and you wish to locate the nearest Pioneer Authorized Independent Service Company, or if you wish to purchase replacement parts, operating instructions, service manuals, or accessories, please call the number shown below.

8 0 0 - 4 2 1 - 1 4 0 4

Please do not ship your product to Pioneer without first calling the Customer Support Division at the above listed number for assistance.

Pioneer Electronics (USA) Inc.  
Customer Support Division  
P.O. BOX 1760, Long Beach,  
CA 90801-1760, U.S.A.

For warranty information please see the Limited Warranty sheet included with your product.

Should this product require service in Canada, please contact a Pioneer Canadian Authorized Dealer to locate the nearest Pioneer Authorized Service Company in Canada. Alternatively, please contact the Customer Satisfaction Department at the following address:

Pioneer Electronics of Canada, Inc.  
Customer Satisfaction Department  
300 Allstate Parkway, Markham, Ontario L3R OP2  
1(877)283-5901

For warranty information please see the Limited Warranty sheet included with your product.

Si ce produit doit être réparé au Canada, veuillez vous adresser à un distributeur autorisé Pioneer du Canada pour obtenir le nom du Centre de Service Autorisé Pioneer le plus près de chez-vous. Vous pouvez aussi contacter le Service à la clientèle de Pioneer:

Pioneer Électroniques du Canada, Inc.  
Service à la clientèle  
300, Allstate Parkway, Markham, Ontario L3R OP2  
1(877)283-5901

Pour obtenir des renseignements sur la garantie, veuillez vous reporter au feuillet sur la garantie restreinte qui accompagne le produit.

S018\_A\_EF

Published by Pioneer Corporation.  
Copyright © 2006 Pioneer Corporation.  
All rights reserved.

## PIONEER CORPORATION

4-1, Meguro 1-Chome, Meguro-ku, Tokyo 153-8654, Japan

### PIONEER ELECTRONICS (USA) INC.

P.O. BOX 1540, Long Beach, California 90810-1540, U.S.A. TEL: (800) 421-1404

### PIONEER ELECTRONICS OF CANADA, INC.

300 Allstate Parkway, Markham, Ontario L3R OP2, Canada TEL: 1-877-283-5901

### PIONEER EUROPE NV

Haven 1087, Keetberglaan 1, B-9120 Melsele, Belgium TEL: 03/570.05.11

### PIONEER ELECTRONICS ASIACENTRE PTE. LTD.

253 Alexandra Road, #04-01, Singapore 159936 TEL: 65-6472-7555

### PIONEER ELECTRONICS AUSTRALIA PTY. LTD.

178-184 Boundary Road, Braeside, Victoria 3195, Australia, TEL: (03) 9586-6300

### PIONEER ELECTRONICS DE MEXICO S.A. DE C.V.

Bldv.Manuel Avila Camacho 138 10 piso Col.Lomas de Chapultepec, Mexico,D.F. 11000 TEL: 55-9178-4270

K002\_A\_En

## Free Manuals Download Website

<http://myh66.com>

<http://usermanuals.us>

<http://www.somanuals.com>

<http://www.4manuals.cc>

<http://www.manual-lib.com>

<http://www.404manual.com>

<http://www.luxmanual.com>

<http://aubethermostatmanual.com>

Golf course search by state

<http://golfingnear.com>

Email search by domain

<http://emailbydomain.com>

Auto manuals search

<http://auto.somanuals.com>

TV manuals search

<http://tv.somanuals.com>