

Pioneer *sound.vision.soul*

DVD Recorder

DVR-420H

DVR-520H

DVR-720H

HDD
HARD DISK DRIVE

DVD
VIDEO

DVD
R

DVD
RW

COMPACT
disc
DIGITAL AUDIO

COMPACT
disc
DIGITAL VIDEO

VIDEO *plus+*

Operating Instructions

RW
COMPATIBLE

IMPORTANT



The lightning flash with arrowhead symbol, within an equilateral triangle, is intended to alert the user to the presence of uninsulated "dangerous voltage" within the product's enclosure that may be of sufficient magnitude to constitute a risk of electric shock to persons.

CAUTION

**RISK OF ELECTRIC SHOCK
DO NOT OPEN**

CAUTION:

TO PREVENT THE RISK OF ELECTRIC SHOCK, DO NOT REMOVE COVER (OR BACK). NO USER-SERVICEABLE PARTS INSIDE. REFER SERVICING TO QUALIFIED SERVICE PERSONNEL.



The exclamation point within an equilateral triangle is intended to alert the user to the presence of important operating and maintenance (servicing) instructions in the literature accompanying the appliance.

D3-4-2-1-1_En-A

WARNING: The apparatus is not waterproofs, to prevent fire or shocks hazard, do not expose this apparatus to rain or moisture and do not put any water source near this apparatus, such as vase, flower pot, cosmetics container and medicine bottle etc.

D3-4-2-1-3_En

WARNING:

BEFORE PLUGGING IN THE UNIT FOR THE FIRST TIME, READ THE FOLLOWING SECTION CAREFULLY. The voltage of the available power supply differs according to country or region. Be sure that the power supply voltage of the area where this unit will be used meets the required voltage (e.g., 230V or 120V) written on the rear panel.

D3-4-2-1-4_En

CAUTION

This product contains a laser diode of higher class than 1. To ensure continued safety, do not remove any covers or attempt to gain access to the inside of the product.

Refer all servicing to qualified personnel.

The following caution label appears on your unit.



D3-4-2-1-8_En

This product complies with the Low Voltage Directive (73/23/EEC, amended by 93/68/EEC), EMC Directives (89/336/EEC, amended by 92/31/EEC and 93/68/EEC).

D3-4-2-1-9a_En

The STANDBY/ON switch is secondary connected and therefore, does not separate the unit from mains power in STANDBY position. Therefore install the unit suitable places easy to disconnect the MAINS plug in case of the accident. The MAINS plug of unit should be unplugged from the wall socket when left unused for a long period of time.

D3-4-2-2-2a_En

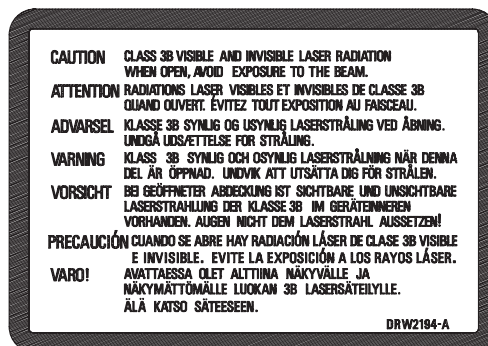

WARNING: No naked flame sources, such as lighted candle, should be placed on the apparatus. If naked flame sources accidentally fall down, fire spread over the apparatus then may cause fire.

D3-4-2-1-7a_En

Operating Environment

Operating environment temperature and humidity:
+5 °C – +35 °C (+41 °F – +95 °F); less than 85 %RH
(cooling vents not blocked)

Do not install in the following locations

- Location exposed to direct sunlight or strong artificial light
- Location exposed to high humidity, or poorly ventilated location

D3-4-2-1-7c_En

VENTILATION: When installing this unit, make sure to leave space around the unit for ventilation to improve heat radiation (at least 10 cm at top, 10 cm at rear, and 10 cm at each side).

WARNING: Slots and openings in the cabinet are provided for ventilation and to ensure reliable operation of the product and to protect it from overheating, to prevent fire hazard, the openings should never be blocked and covered with items, such as newspapers, table-cloths, curtains, etc. Also do not put the apparatus on the thick carpet, bed, sofa, or fabric having a thick pile.

D3-4-2-1-7b_En

This product incorporates copyright protection technology that is protected by method claims of certain U.S. patents and other intellectual property rights owned by Macrovision Corporation and other rights owners. Use of this copyright protection technology must be authorized by Macrovision Corporation, and is intended for home and other limited viewing uses only unless otherwise authorized by Macrovision Corporation. Reverse engineering or disassembly is prohibited.

This product is for general household purposes. Any failure due to use for other than household purposes (such as long-term use for business purposes in a restaurant or use in a car or ship) and which requires repair will be charged for even during the warranty period.

K041_En

This product includes FontAvenue® fonts licenced by NEC corporation. FontAvenue is a registered trademark of NEC Corporation.

POWER-CORD CAUTION

Handle the power cord by the plug. Do not pull out the plug by tugging the cord and never touch the power cord when your hands are wet as this could cause a short circuit or electric shock. Do not place the unit, a piece of furniture, etc., on the power cord, or pinch the cord. Never make a knot in the cord or tie it with other cords. The power cords should be routed such that they are not likely to be stepped on. A damaged power cord can cause a fire or give you an electrical shock. Check the power cord once in a while. When you find it damaged, ask your nearest PIONEER authorized service center or your dealer for a replacement.

5002_En

Replacement and mounting of an AC plug on the power supply cord of this unit should be performed only by qualified service personnel.

IMPORTANT FOR USE IN THE UNITED KINGDOM

The wires in this mains lead are coloured in accordance with the following code:

Blue : Neutral
Brown : Live

If the plug provided is unsuitable for your socket outlets, the plug must be cut off and a suitable plug fitted.

The cut-off plug should be disposed of and must not be inserted into any 13 amp socket as this can result in electric shock. The plug or adaptor or the distribution panel should be provided with 5 A fuse. As the colours of the wires in the mains lead of this appliance may not correspond with coloured markings identifying the terminals in your plug, proceed as follows :

The wire which is coloured blue must be connected to the terminal which is marked with the letter N or coloured black.

The wire which is coloured brown must be connected to the terminal which is marked with the letter L or coloured red.

Do not connect either wire to the earth terminal of a three pin plug.

NOTE

After replacing or changing a fuse, the fuse cover in the plug must be replaced with a fuse cover which corresponds to the colour of the insert in the base of the plug or the word that is embossed on the base of the plug, and the appliance must not be used without a fuse cover. If lost replacement fuse covers can be obtained from your dealer. Only 5 A fuses approved by B.S.I or A.S.T.A to B.S.1362 should be used.

D3-4-2-1-2-2_En

Contents

01 Before you start

Features	6
What's in the box	8
Putting the batteries in the remote control	8
Using the remote control	8
Disc / content format playback compatibility	9
About the internal hard disk drive	11

02 Connecting up

Rear panel connections	12
Front panel connections	12
Extra features for use with compatible TVs	13
Easy connections	14
Using other types of audio/video output	15
Connecting to a cable box or satellite receiver	16
Connecting an external decoder box (1)	17
Connecting an external decoder box (2)	18
Connecting to an AV amplifier/receiver	19
Connecting other AV sources	20
Plugging in	20

03 Controls and displays

Front panel	21
Display	22
Remote control	23

04 Getting started

Switching on and setting up	25
Selecting the hard disk or DVD for playback and recording	28
Making your first recording	28
Using the built-in TV tuner	29
Basic playback	30
Using the Home Menu	33
Displaying disc information on-screen	33

05 Playback

Introduction	36
Using the Disc Navigator to browse the contents of a disc	36
Navigating discs and the HDD	38
Scanning discs	38
Playing in slow motion	39
Frame advance/frame reverse	39
The Play Mode menu	40
Displaying and switching subtitles	43

Switching DVD soundtracks	43
Switching audio channels	44
Switching camera angles	44

06 Recording

About DVD recording	45
About HDD recording	45
Recording time and picture quality	46
Restrictions on video recording	46
Setting the picture quality/recording time	47
Basic recording from the TV	47
Setting a timer recording	49
Timer recording FAQ	55
Simultaneous recording and playback	55
Recording from an external component	56
Automatic recording from a satellite tuner	56
Recording from a DV camcorder (DVR-520H/720H only)	57
Recording from the DV output (DVR-520H/720H only)	59
Playing your recordings on other DVD players	59
Initializing a DVD-RW disc	60

07 Copying and back-up

Introduction	61
One Touch Copy (HDD to DVD)	62
One Touch Copy (DVD to HDD)	62
Copying from HDD to DVD	63
HDD to DVD Copy List menu options	64
Recording the Copy List	65
HDD to DVD Copy List commands	65
Copying from DVD to HDD	71
DVD to HDD Copy List menu options	72
Recording the Copy List	72
DVD to HDD Copy List commands	73
Using disc back-up	74

08 Editing

The Disc Navigator screen	76
Disc Navigator menu options	78
Editing VR mode Original, Video mode and HDD content	79
Editing HDD groups	84
Creating and editing a VR mode Play List	84



09 Disc History

Using the Disc History 89

10 The PhotoViewer

Playing a slideshow 90

11 The Disc Setup menu

Basic settings 92

Initialize settings 93

HDD Initialize 93

Finalize settings 93

12 The Video/Audio Adjust menu

Setting the picture quality for TV and external inputs 94

Setting the picture quality for disc playback 95

Audio DRC 96

13 The Initial Setup menu

Using the Initial Setup menu 97

Basic settings 97

Tuner settings 99

Video In / Out settings 102

Audio In settings 103

Audio Out settings 104

Language settings 105

Recording settings 107

Playback settings 109

14 Additional information

Resetting the recorder 112

Setting up the remote to control your TV 112

Screen sizes and disc formats 113

Troubleshooting 114

Frequently asked questions 116

About DV (DVR-520H/720H only) 117

Manual recording modes 118

Language code list 119

Country code list 119

On-screen displays and recorder displays 120

Handling discs 121

Storing discs 121

Damaged discs 121

Cleaning the pickup lens 122

Condensation 122

Hints on installation 122

Moving the recorder 122

Glossary 122

Specifications 125

15 Index

Chapter 1

Before you start

Features

- **HDD recording** **HDD**

You can record up to 102 hours of video (in EP mode) on the internal 80GB (gigabyte) hard disk (HDD) on the DVR-420H/520H, or up to 204 hours on the 160GB DVR-720H.

With both recordable DVD and a high-capacity HDD in the same recorder, you have the flexibility to keep recordings on the HDD for quick access anytime, or record to DVD for archiving or playing on other DVD players.

- **Copy between HDD and DVD**

You can copy recordings from the HDD to recordable DVD, or from DVD to the HDD. Usually you can use the high-speed copy feature, which can copy an hour of video in under two minutes (when recorded in EP mode using a DVD-R Ver. 2.0 / 8x disc).

You can also choose to copy material at a different recording quality from the original. For example, you might want to copy a FINE mode (highest quality) recording on the HDD to SP (standard play) quality on a DVD so that you can fit other recordings on the same disc.

- **One Touch Copy**

One Touch Copy makes copying the currently playing title from HDD to DVD, or DVD to HDD as simple as pressing a button.

- **Chase play** **VR mode** **HDD**

Using chase play you can start watching a recording before the recording has finished. For example, you could set a timer recording for a program that you're going to miss the first 15 minutes of, then start watching while the recorder is still recording the program 15 minutes ahead of you.

- **Simultaneous recording and playback**

VR mode **HDD**

Playback and recording for both DVDs and the built-in hard disk drive (HDD) are completely independent. For example you can record a broadcast program to either a recordable DVD or the HDD, while watching another recording you already made on the same DVD or on the HDD.

- **Disc Navigator**

The on-screen Disc Navigator makes finding your way around the contents of a disc or the HDD easy. For recordable DVD and HDD content, moving thumbnail images are displayed for ease of use. The Disc Navigator is also where you can edit HDD and recordable DVD content.

- **Disc History**

The Disc History screen shows disc information, including how much free space remains for recording, for the last 30 recordable discs loaded in the recorder. Every time you load a recordable disc, the Disc History is automatically updated with the latest information.

- **Home Menu**

The Home Menu gives you on-screen access to all the recorder's features in one convenient place, from setting up the recorder, to programming a timer recording and editing a recording.

- **Cinema surround sound in your home**

Connect this recorder to a Dolby Digital and/or DTS-compatible AV amp/receiver to enjoy full surround sound effects from Dolby Digital and DTS DVD discs.

- **Easy Timer Recording**

Setting the recorder to record a program is simple from the Easy Timer Recording screen. Set the channel to record and the recording quality, then graphically set the start and end times of the recording. That's it!

- **Program up to 32 timer recordings**

You can program the recorder to record up to 32 programs, up to a month in advance, using the VIDEO Plus+[®] system* for easy programming if you want. As well as single programs, you can specify daily or weekly recordings, too.

This recorder is also compatible with VPS/PDC systems, which ensure you don't miss a timer recording, even if the broadcast is not running to schedule.

*1 **VIDEO Plus+** is a registered trademark of Gemstar Development Corporation.

The VIDEO Plus+ system is manufactured under license from Gemstar Development Corporation.

- **One Touch Recording**

Use One Touch Recording to start recording immediately in 30 minute blocks. Each time you press the **● REC** button, the recording time is extended by another 30 minutes.

- **Optimized recording**

Optimized recording adjusts the recording quality automatically if a timer recording will not fit onto a disc with the settings that you made.

- **Auto Start Recording from satellite receiver or other set top box**

With a satellite receiver or other set top box connected to the **AV2/AUTO START REC (INPUT 1/DECODER)** inputs of this recorder, you can start and stop recording automatically according to the timer settings of the set top box.

- **High quality 16-bit Linear PCM audio**

When recording using one of the high quality record settings (**FINE** or **MN32**), the audio is recorded in uncompressed 16-bit Linear PCM format. This delivers great sounding audio to accompany the high picture quality.

- **Picture quality adjustment features**

During playback, you can adjust various picture quality settings to improve the picture. You can also adjust the recording picture quality. For example, if you want to make a DVD copy of an old video tape, you can optimize the picture quality before transferring it to disc.

- **Find what you want to watch quickly and easily**

Unlike video tape that needs to be wound to the correct place, you can jump right to the part of a DVD disc or the HDD that you want to watch. Search for a point on a disc by title, chapter or time.

- **Manual recording**

In addition to the four preset recording quality modes (**FINE**, **SP**, **LP** and **EP**), the manual recording mode allows you to access 32 different recording quality/time settings, giving you precise control over the recording.

- **Record to and from a DV camcorder (DVR-520H/720H only)**

This recorder has a built-in DV (Digital Video) input/output jack for connection to a DV camcorder. This makes it ideal for transferring camcorder footage to DVD or HDD for editing. You can also transfer DVD or HDD content back to the camcorder if you need to.

- **Safe, non-destructive editing** **VR mode**

When you edit a DVD-RW, the actual content of the disc (the Original content) is not touched. The edited version (the Play List content) just points to various parts of the Original content.

- **Chapter marking** **VR mode** **HDD**

You can easily add chapter markers anywhere in your recordings for easy editing.

- **Play Video mode recordings on a regular DVD**

player **Video mode**

Discs recorded using the Video mode can be played back on regular DVD players, including computer DVD drives compatible with DVD-Video playback*.

* 'DVD-Video format' recording: The use of the DVD-Video format for recording on DVD-R and DVD-RW discs is referred to as recording in 'Video mode' on Pioneer's DVD recorders. Supporting playback of DVD-R / DVD-RW discs is optional for manufacturers of DVD playback equipment, and there is DVD playback equipment that does not play DVD-R or DVD-RW discs recorded in the DVD-Video format.

Note: 'Finalization' is required.

- **WMA, MP3 and JPEG file playback**

This recorder can play WMA and MP3 audio files and JPEG picture files on CD-R, CD-RW or CD-ROM discs.

- **Disc Back-up**

The disc back-up feature gives you a convenient way to back-up important material on DVD to another recordable DVD disc. The material is first copied to the HDD, then on to a second DVD disc.

- **Recovery Recording** **HDD**

When a timer recording is set to use DVD but the disc loaded at the time of the recording is unrecordable, the program will automatically be recorded to the HDD.

- **Auto Replace Recording** **HDD**

This feature is useful for regular timer recordings of a TV program which you don't want to keep after watching. Each time the program is recorded, it replaces the one currently on the HDD. There's no need to manually delete it later.

Note on copying:

Recording equipment should be used only for lawful copying and you are advised to check carefully what is lawful copying in the country in which you are making a copy. Copying of copyright material such as films or music is unlawful unless permitted by a legal exception or consented to by the rightowners.

What's in the box

Please confirm that the following accessories are in the box when you open it.

- Remote control
- AA/R6P dry cell batteries x2
- Audio/video cable (red/white/yellow)
- RF antenna cable
- Power cable
- These operating instructions
- Warranty card

Putting the batteries in the remote control

1 Open the battery compartment cover on the back of the remote control.

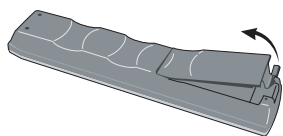

2 Insert two AA/R6P batteries into the battery compartment following the indications (+, -) inside the compartment.

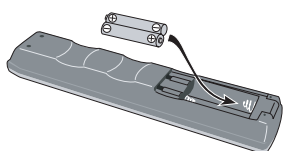

3 Close the cover.

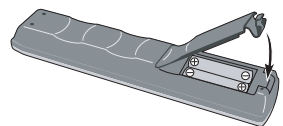

Note

Incorrect use of batteries can result in hazards such as leakage and bursting. Please observe the following:

- Don't mix new and old batteries together.
- Don't use different kinds of batteries together—although they may look similar, different batteries may have different voltages.
- Make sure that the plus and minus ends of each battery match the indications in the battery compartment.
- Remove batteries from equipment that isn't going to be used for a month or more.
- When disposing of used batteries, please comply with governmental regulations or environmental public instruction's rules that apply in your country or area.

Using the remote control

Please keep in mind the following when using the remote control:

- Make sure that there are no obstacles between the remote and the remote sensor on the unit.
- Remote operation may become unreliable if strong sunlight or fluorescent light is shining on the unit's remote sensor.
- Remote controllers for different devices can interfere with each other. Avoid using remotes for other equipment located close to this unit.
- Replace the batteries when you notice a fall off in the operating range of the remote.
- When the batteries run down or you change the batteries, the remote control mode and TV preset codes are automatically reset. See *Remote Control Set* on page 99 and *Setting up the remote to control your TV* on page 112 to reset them.
- Use within the operating range and angle, as shown.

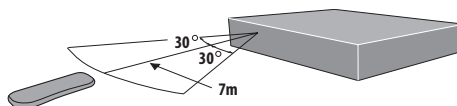

- You can control this recorder using the remote sensor of another Pioneer component using the **CONTROL IN** jack on the rear panel. See *Rear panel connections* on page 12 for more information.

Disc / content format playback compatibility

General disc compatibility

This recorder is compatible with a wide range of disc types (media) and formats. Playable discs will generally feature one of the following logos on the disc and/or disc packaging. Note however that some disc types, such as recordable CD and DVD, may be in an unplayable format—see below for further compatibility information.



- Also compatible with KODAK Picture CD
- **DVD** is a trademark of DVD Format/Logo Licensing Corporation.
-  is a trademark of Fuji Photo Film Co. Ltd.

This recorder also supports the IEC's Super VCD standard. Compared to the Video CD standard, Super VCD offers superior picture quality, and allows two soundtracks to be recorded. Super VCD also supports the widescreen size.



DVD-R/RW compatibility

This recorder will play and record DVD-R/RW discs.

Compatible media:

- DVD-RW Ver. 1.1, Ver. 1.1 / 2x and Ver. 1.2 / 4x
- DVD-R Ver. 2.0 and Ver. 2.0 / 4x / 8x

Recording formats:

- DVD-R: DVD-Video format (Video mode)
- DVD-RW: Video Recording (VR) format and DVD-Video format (Video mode)

Note that older models of DVD recorders and DVD writers may reject DVD-RW Ver. 1.2 / 4x discs. If you want to share DVD-RW discs between this recorder and an older recorder/writer, we recommend using Ver. 1.1 discs.

The following table shows older Pioneer DVD recorder compatibility with DVD-RW Ver. 1.2 / 4x discs.

Model	Playable	Recordable
DVR-7000	Yes ^{1,2,3}	No
DVR-3100/ DVR-5100H	Yes ¹	No

¹ Discs should be finalized in this recorder before playing. Unfinalized VR mode and Video mode discs may not play.

² Cannot read the CPRM information will show in the display when you load a disc. However, this will not affect playback.

³ Copy-once protected disc titles will not play.

CD-R/RW compatibility

This recorder cannot record CD-R or CD-RW discs.

- Compatible formats: CD-Audio, Video CD/Super VCD, ISO 9660 CD-ROM* containing MP3, WMA or JPEG files
* ISO 9660 Level 1 or 2 compliant. CD physical format: Mode1, Mode2 XA Form1. Romeo and Joliet file systems are both compatible with this recorder.
- Multi-session playback: Yes (except CD-Audio and Video CD/Super VCD)
- Unfinalized disc playback: CD-Audio only

Compressed audio compatibility

- Compatible media: CD-ROM, CD-R, CD-RW
- Compatible formats: MPEG-1 Audio Layer 3 (MP3), Windows Media Audio (WMA)
- Sampling rates: 44.1 or 48kHz
- Bit-rates: Any (128Kbps or higher recommended)
- Variable bit-rate (VBR) MP3 playback: Yes
- VBR WMA playback: No
- WMA encoder compatibility: Windows Media Codec 8 (files encoded using Windows Media Codec 9 may be playable but some parts of the specification are not supported; specifically, Pro, Lossless, Voice and VBR)
- DRM (Digital Rights Management) file playback: No (see also DRM in the Glossary on page 122)
- File extensions: .mp3, .wma (these must be used for the recorder to recognize MP3 and WMA files – do not use for other file types)
- File structure: Up to 99 folders / 999 files (if these limits are exceeded, only files and folders up to these limits are playable)

WMA (Windows Media Audio) compatibility



The Windows Media[®] logo printed on the box indicates that this recorder can playback Windows Media Audio content.

WMA is an acronym for Windows Media Audio and refers to an audio compression technology developed by Microsoft Corporation. WMA content can be encoded by using Windows Media[®] Player version 7, 7.1, Windows Media[®] Player for Windows[®] XP, or Windows Media[®] Player 9 Series.

Microsoft, Windows Media, and the Windows logo are trademarks, or registered trademarks of Microsoft Corporation in the United States and/or other countries.

JPEG file compatibility

- Compatible formats: Baseline JPEG and EXIF 2.2* still image files
*File format used by digital still cameras
- Sampling ratio: 4:4:4, 4:4:2, 4:2:0
- Horizontal resolution: 160 – 5120 pixels
- Vertical resolution: 120 – 3840 pixels
- Progressive JPEG compatible: No
- File extensions: .jpg, jpeg, jif, jfif (must be used for the recorder to recognize JPEG files – do not use for other file types)
- File structure: The recorder can load up to 99 folders / 999 files at one time (if there are more files/folders that this on the disc then more can be reloaded)

PC-created disc compatibility

Discs recorded using a personal computer may not be playable in this unit due to the setting of the application software used to create the disc. In these particular instances, check with the software publisher for more detailed information.

Discs recorded in packet write mode (UDF format) are not compatible with this recorder.

Check the DVD-R/RW or CD-R/RW software disc boxes for additional compatibility information.

Frequently asked questions

- *What's the difference between DVD-R and DVD-RW?*

The most important difference between DVD-R and DVD-RW is that DVD-R is a record-once medium, while DVD-RW is a re-recordable/erasable medium. You can re-record/erase a DVD-RW disc approximately 1,000 times.

For more information, see *About DVD recording* on page 45.

- *What's VR mode?*

VR (Video Recording) mode is a special mode designed for home DVD recording. It allows flexible editing of recorded material compared to 'Video mode'. On the other hand, Video mode discs are more compatible with other DVD players.

- *Can I play my recordable discs in a regular DVD player?*

Generally, DVD-R discs and DVD-RW discs recorded in Video mode* are playable in a regular DVD player, but they must be 'finalized' first. This process fixes the contents of the disc to make them readable to other DVD players as DVD-Video discs.

DVD-RW discs recorded in VR mode are playable in some players.

RW COMPATIBLE This label indicates playback compatibility with DVD-RW discs recorded in VR mode (Video Recording format). However, for discs recorded with a record-only-once encrypted program, playback can only be achieved using the CPRM compatible device.

Note that Pioneer cannot guarantee that discs recorded using this recorder will play on other players.

* 'DVD-Video format' recording: The use of the DVD-Video format for recording on DVD-R and DVD-RW discs is referred to as recording in 'Video mode' on Pioneer's DVD recorders. Supporting playback of DVD-R / DVD-RW discs is optional for manufacturers of DVD playback equipment, and there is DVD playback equipment that does not play DVD-R or DVD-RW discs recorded in the DVD-Video format.

Note: 'Finalization' is required.

This recorder supports the recording of 'copy-once' broadcast programs using the CPRM copy protection system (see CPRM on page 46) on CPRM-compliant DVD-RW discs in VR mode. CPRM recordings can only be played on players that are specifically compatible with CPRM.

- Do I need two DVD recorders for editing? What kind of editing can I do?

Unlike editing video tape, you only need one DVD recorder to edit discs. With DVD, you edit by making a 'Play List' of what to play and when to play it. On playback, the recorder plays the disc according to the Play List.

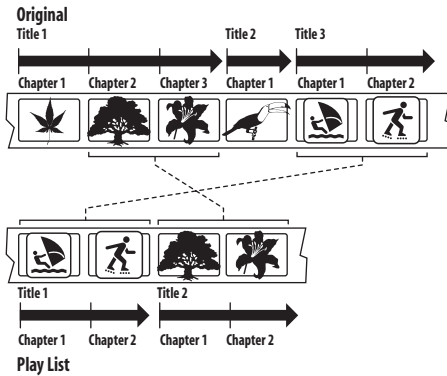

Throughout this manual, you will often see the words Original and Play List to refer to the actual content and the edited version.

- **Original** content refers to what's actually recorded on the disc.
- **Play List** content refers to the edited version of the disc—how the Original content is to be played.

About the internal hard disk drive

The internal hard disk drive (HDD) is a fragile piece of equipment. Please use the recorder following the guidelines below to protect against possible HDD failure. *We recommend that you back up your important recordings onto DVD-R/RW discs in order to protect against accidental loss.*

- Do not move the recorder while it is on.
- Install and use the recorder on a stable, level surface.
- Do not block the rear vent/cooling fan.
- Do not use the recorder in excessively hot or humid places, or in places that may be subject to sudden changes in temperature. Sudden changes in temperature can cause condensation to form inside the recorder. This can be a cause of HDD failure.
- While the recorder is switched on, do not unplug from the wall socket or switch the electricity off from the breaker switch.
- Do not move the recorder immediately after switching it off. If you need to move the recorder, please follow the steps below:
 - 1 After the message **POWER OFF** is shown in the display, wait at least two minutes.
 - 2 Unplug from the wall socket.
 - 3 Move the recorder.
- If there's a power failure while the recorder is on there is a chance that some data on the HDD will be lost.
- The HDD is very delicate. If used improperly or in an unsuitable environment, it is possible that the HDD will fail after a few years of use. Signs of problems include playback unexpectedly freezing and noticeable block noise (mosaic) in the picture. However, sometimes there will be no warning signs of HDD failure.
 If the HDD fails, no playback of recorded material will be possible. In this case it will be necessary to replace the HDD unit.

Chapter 2

Connecting up

Rear panel connections

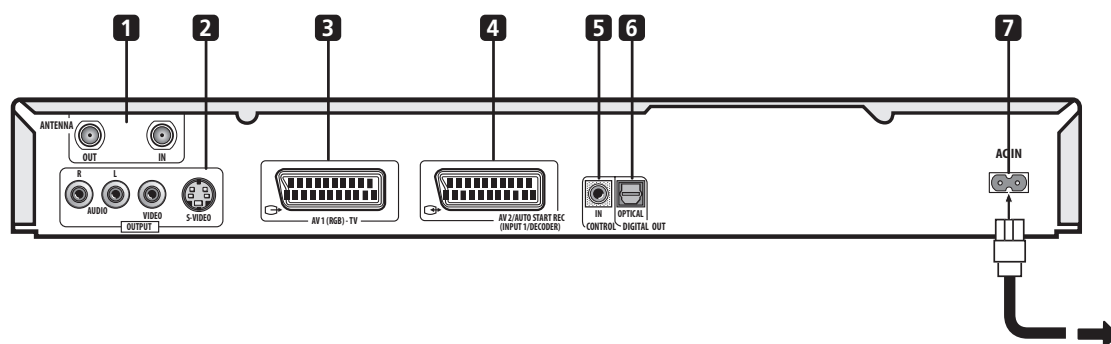
**1 ANTENNA IN/OUT**

Connect your TV antenna to the **ANTENNA IN** jack. The signal is passed through to the **ANTENNA OUT** jack for connection to your TV.

2 OUTPUT jacks

Stereo analog audio, video and S-video outputs for connection to a TV or AV amplifier/receiver.

3 AV1(RGB)-TV AV connector

Audio/video output SCART-type AV connector for connecting to a TV or other equipment with a SCART connector. The video output is switchable between video, S-video and RGB. See page *AV1 Out* on page 102 for how to set this up.

4 AV2/AUTO START REC (INPUT 1/DECODER) AV connector

Audio/video input/output SCART-type AV connector for connecting to a VCR, or other equipment with a SCART connector. The input accepts video, S-video and RGB. See *AV2/L1 In* on page 102 for how to set this up.

5 CONTROL IN

Use to control this recorder from the remote sensor of another Pioneer component with a **CONTROL OUT** terminal and bearing the Pioneer  mark. Connect the **CONTROL OUT** of the other component to the **CONTROL IN** of this recorder using a mini-plug cord.

6 DIGITAL OUT OPTICAL

For connecting to an AV amplifier/receiver, Dolby Digital/DTS/MPEG decoder or other equipment with optical digital input.

7 AC IN – Power inlet

Front panel connections



On the left side of the front panel a flip-down cover hides a second audio/video input, consisting of an S-video and standard (composite) video jack, and stereo analog audio jacks.

DV-520H/720H only: On the right side is the DV input/output i.LINK connector. This is for connection to a DV camcorder.

Extra features for use with compatible TVs

When this recorder is connected to a TV that features T-V Link, EasyLink, MegaLogic, SMARTLINK, Q-Link, DATA LOGIC or NexTVview Link using a fully-wired 21-pin SCART cable (not supplied), the following functions are available:

- Direct TV recording
- Channel preset download
- Electronic Program Guide (EPG) download
- TV auto power on
- System configuration

Direct TV recording

Direct TV recording allows you to record the TV program that you're watching, without having to worry about whether this recorder is set to the same channel. See *Direct recording from TV* on page 48 for more on this feature.

Channel preset download

This feature allows you to set up the channel presets of this recorder very simply using the channel presets and preset names already in your TV. See *Switching on and setting up* on page 25 and *Auto Channel Setting : Download from TV* on page 100 for more on this feature.

EPG download

EPG download allows you to program a timer recording directly from the electronic program guide displayed on your TV.

See the manual that came with your TV for more information on how to use this feature. Note that the **SP** and **LP** options displayed on your TV correspond to the **SP** and **LP** recording modes on this recorder.

TV auto power on

When you play a disc in this recorder, the TV automatically turns on and switches to the correct video input. See the manual that came with your TV for how to use this feature.

System configuration

Basic settings, including language, country and TV screen size (aspect ratio), can be downloaded from your TV to help set up this recorder for use.



Note

- For further details and compatibility information, see also the manual that came with your TV.

Easy connections

The setup described below is a basic setup that allows you to watch and record TV programs, and play discs. Other types of connections are explained starting on the following page.

Important

- These connections use SCART cables (not supplied). If your TV (or VCR) does not have a SCART connection, see the following page for connecting up using the supplied audio/video cable.
- The **AV1(RGB)-TV** AV connector can output ordinary (composite), S-video or RGB video, plus stereo analog audio. The **AV2/AUTO START REC (INPUT 1/DECODER)** connector accepts ordinary, S-video and RGB video input, as well as stereo analog audio. See *AV1 Out* on page 102 and *AV2/L1 In* on page 102 for how to set them up.
- Before making or changing any rear panel connections, make sure that all components are switched off and unplugged from the wall outlet.

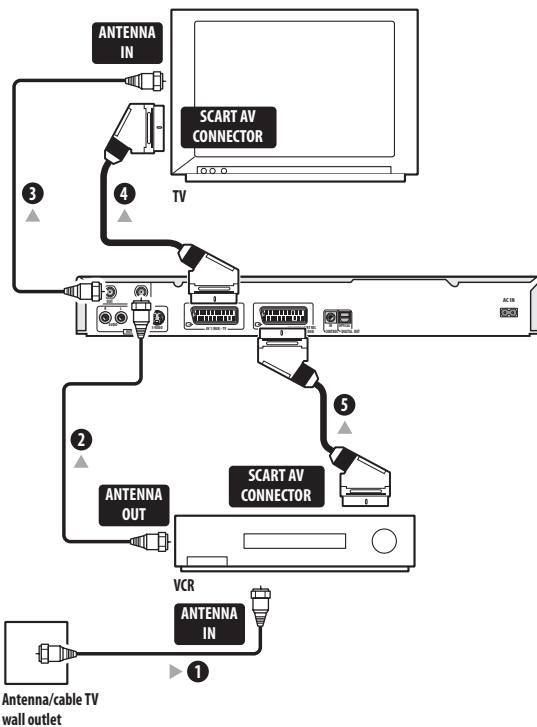

1 Connect the cable from the antenna/cable TV outlet to the antenna input on your VCR.

- If you are not connecting a VCR in the chain, connect it to the **ANTENNA IN** jack on this recorder and skip the next step.

2 Use an RF antenna cable (one is supplied) to connect the antenna output of your VCR to the ANTENNA IN of this recorder.

3 Use another RF antenna cable to connect the ANTENNA OUT of this recorder to the antenna input on your TV.

4 Use a SCART cable (not supplied) to connect the AV1(RGB)-TV AV connector on this recorder to the SCART AV connector on your TV.

5 Use another SCART cable to connect the AV2/AUTO START REC (INPUT 1/DECODER) AV connector to a SCART AV connector on your VCR.

Note

- See the following page if you want to use one of the other kinds of audio/video connection.

Tip

- This recorder has a 'through' function which allows you to record a TV program from the built-in TV tuner in this recorder while watching a video playing on your VCR. (To use this feature when the recorder is in standby, **Power Save** must be set to **Off**—see *Power Save* on page 98).

Using other types of audio/video output

If you can't use the SCART AV connector to connect your TV to this recorder, there are standard audio/video output jacks, as well as an S-video output.

Using the supplied audio/video cable

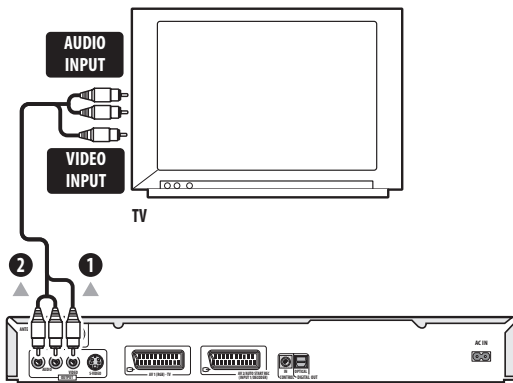

1 Connect the VIDEO OUTPUT jack to a video input on your TV.

Use the yellow jack of the supplied audio/video cable for the video connection.

2 Connect the AUDIO OUTPUT jacks to the corresponding audio inputs on your TV.

Use the red and white jacks of the supplied audio/video cable for the audio connection. Make sure you match up the left and right outputs with their corresponding inputs for correct stereo sound.

Using the S-video output

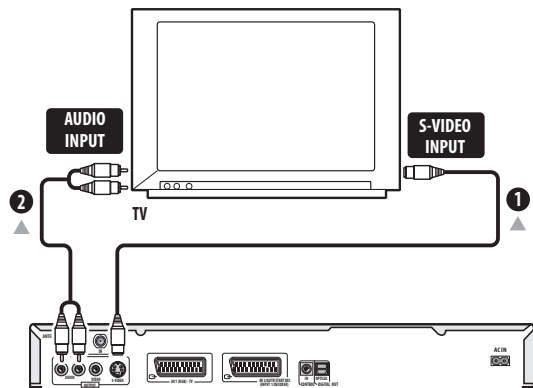

1 Use an S-video cable (not supplied) to connect the S-VIDEO OUTPUT to an S-video input on your TV, monitor (or other equipment).

2 Connect the AUDIO OUTPUT jacks to the corresponding audio inputs on your TV.

You can use the supplied audio/video cable, leaving the yellow video plug disconnected. Make sure you match up the left and right outputs with their corresponding inputs for correct stereo sound.

Connecting to a cable box or satellite receiver

If you have a cable or satellite receiver with a built-in decoder, connect it to this recorder and your TV as shown on this page. If you are using a separate decoder box for your cable/satellite TV, set up following the instructions on the next page.

Using the setup on this page you can:

- Record any channel by selecting it on the cable box/satellite tuner.

Important

- Do not connect this recorder 'through' your VCR, satellite receiver or cable box. Always connect each component directly to your TV or AV amplifier/receiver.

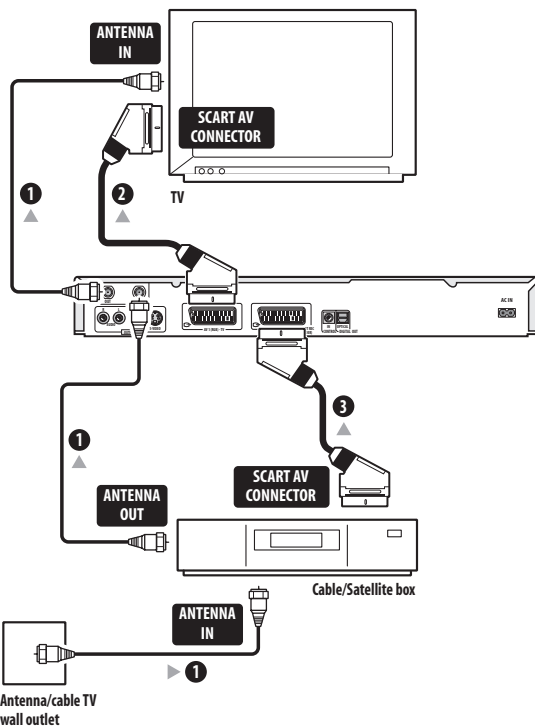

1 Connect RF antenna cables as shown.

This enables you to watch and record TV channels.

2 Use a SCART cable (not supplied) to connect the AV1(RGB)-TV AV connector to a SCART AV connector on your TV.

This enables you to watch discs.

3 Use another SCART cable to connect the AV2/AUTO START REC (INPUT 1/DECODER) AV connector to a SCART AV connector on your satellite/cable box.

This enables you to record scrambled TV channels.

Note

- The diagram shows SCART video connections, but you can alternatively use any of the other audio/video connections.

Tip

- This recorder has a 'through' function which allows you to record a TV program from the built-in TV tuner in this recorder while watching a video playing on your VCR. (To use this feature when the recorder is in standby, **Power Save** must be set to **Off**—see *Power Save* on page 98).

Connecting an external decoder box (1)

If you have an external, dedicated decoder box for your satellite or cable TV system, use the setup described on this page.

Important

- Do not connect your decoder box directly to this recorder.
- Information from the decoder (for example, relating to pay TV services), is only viewable when this recorder is off (in standby).
- For timer recording to work properly on this recorder, the VCR/satellite receiver/cable box must also be switched on during recording.
- It is not possible to watch one TV program and record another using this setup.

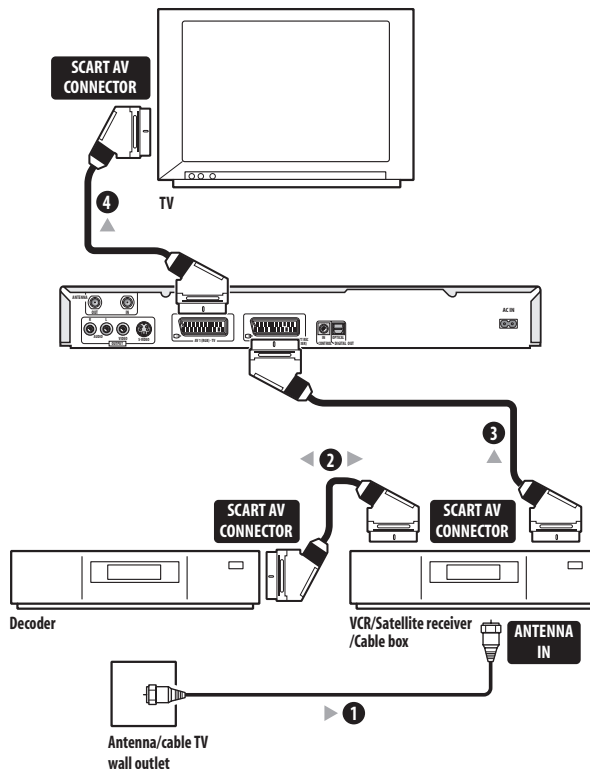

1 Connect the cable from the antenna/cable TV outlet to the antenna input on your VCR/satellite receiver/cable box.

2 Use a SCART cable (not supplied) to connect your decoder to your VCR/satellite receiver/cable box.

See the manual for your decoder box for more detailed instructions.

3 Use a SCART cable to connect your VCR/satellite receiver/cable box to the AV2/AUTO START REC (INPUT 1/DECODER) AV connector on this recorder.

4 Use a SCART cable to connect the AV1(RGB)-TV AV connector to your TV.

Connecting an external decoder box (2)

If you only have a decoder, connect it to this recorder and your TV as shown on this page.

Using the setup on this page you can:

- Record scrambled channels received using the recorder's built-in TV tuner.

Important

- Do not connect this recorder 'through' your VCR, satellite receiver or cable box. Always connect each component directly to your TV or AV amplifier/receiver.

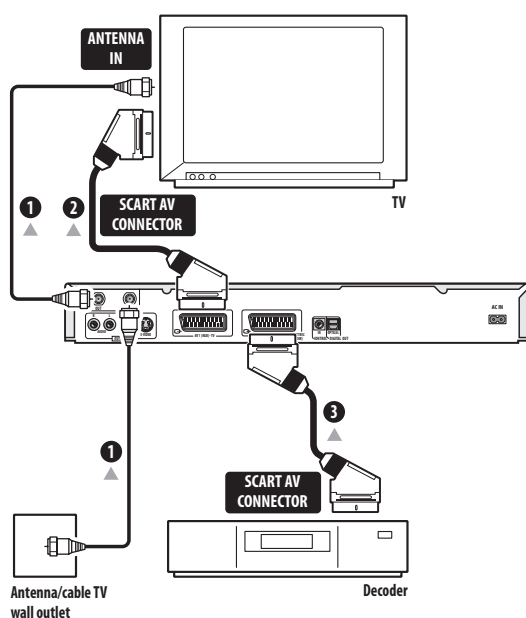

1 Connect RF antenna cables as shown.

This enables you to watch and record TV channels.

2 Use a SCART cable (not supplied) to connect the AV1(RGB)-TV AV connector to a SCART AV connector on your TV.

This enables you to watch discs.

3 Use another SCART cable to connect the AV2/ AUTO START REC (INPUT 1/DECODER) AV connector to a SCART AV connector on your decoder box.

This enables you to record scrambled TV channels.

Note

- In order to use this setup, you will need to make the following settings from the Initial Setup menu:
 - Set the **AV2/L1 In** setting to **Decoder** from the Initial Setup menu (see *AV2/L1 In* on page 102).
 - From the **Manual CH Setting** screen, set the **Decoder** setting for the scrambled channels to **On** (see *Manual CH Setting* on page 100).

Connecting to an AV amplifier/receiver

To enjoy multichannel surround sound you need to connect this recorder to an AV amplifier/receiver using the digital optical output.

In addition to a digital connection, we recommend also connecting using the stereo analog connection for compatibility with all discs and sources.

You'll probably also want to connect a video output to your AV amplifier/receiver. Use the ordinary video output (as shown here), or the S-video output.

Important

- Noise may be output from your speakers if the recorder is not set up to work with your AV amplifier/receiver properly (see *Audio Out settings* on page 104).

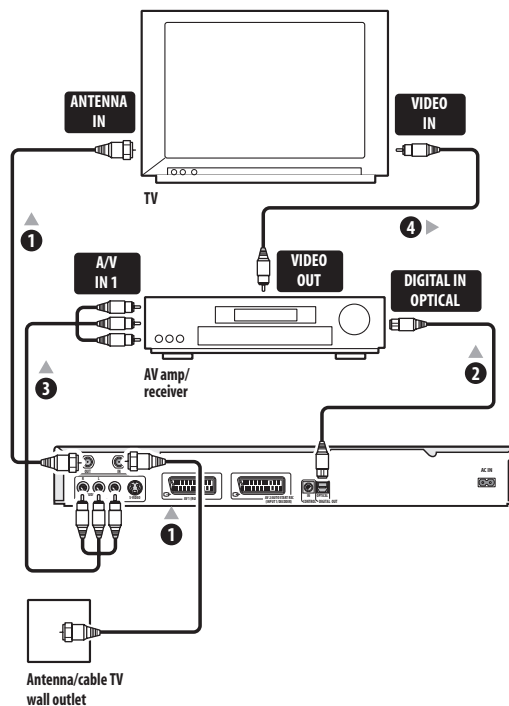

1 Connect RF antenna cables as shown.

This enables you to watch and record TV channels.

2 Connect one of the DIGITAL OUT OPTICAL jack on this recorder to an optical digital input on your AV amplifier/receiver.

This enables you to listen to multichannel surround sound.

3 Connect the analog AUDIO OUTPUT and VIDEO OUTPUT jacks on this recorder to an analog audio and video input on your AV amplifier/receiver.

4 Connect the AV amplifier/receiver's video output to a video input on your TV.

Note

- The diagram shows ordinary video connections, but you can alternatively use an AV connector or S-video connections, if they're available.

Important

- Do not connect this recorder to your TV 'through' your VCR using A/V cables. Always connect it directly to your TV.

Connecting other AV sources

Connecting a VCR or analog camcorder

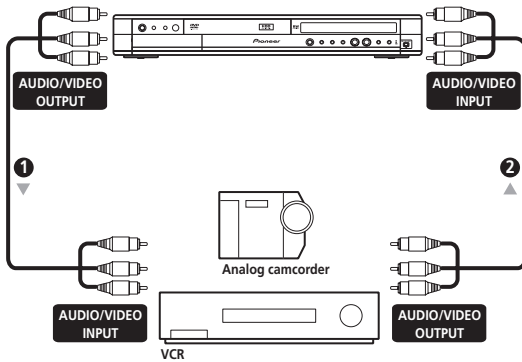

1 Connect a set of audio and video outputs on your VCR or camcorder to a set of inputs on this recorder.

This enables you to record tapes from your VCR or camcorder.

- You can use ordinary video or S-video cables for the video connection.
- The front panel connections make convenient connections for a camcorder.

2 Connect a set of audio and video inputs on your VCR or camcorder to a set of outputs on this recorder.

This enables you to record from this recorder to your VCR or camcorder.

- You can use ordinary video or S-video cables for the video connection.
- Alternatively, you can use the **AV2/AUTO START REC (INPUT 1/DECODER)** SCART connector for audio/video input and output with just one SCART cable.

Connecting a DV camcorder (DVR-520H/720H only)

Using the front panel **DV IN/OUT** jack, it is possible to connect a DV camcorder or video deck, or DVD-R/RW recorder and digitally transfer DV tapes or DVD-R/RW discs to DVD-R/RW.

Important

- This jack is for connection to DV equipment only. It is not compatible with digital satellite tuners or D-VHS video decks.

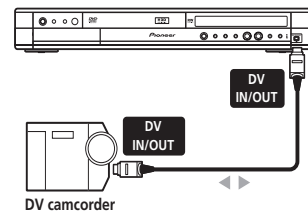

1 Use a DV cable (not supplied) to connect the DV in/out jack on your DV camcorder/deck to the front panel DV IN/OUT jack of this recorder.

Plugging in

Before plugging in for the first time, make sure that everything is connected properly.

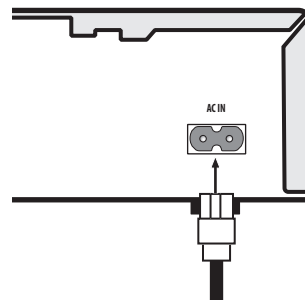

1 Plug the supplied AC power cable into the AC IN inlet and the other end into a standard household power outlet.

Chapter 3

Controls and displays

Front panel

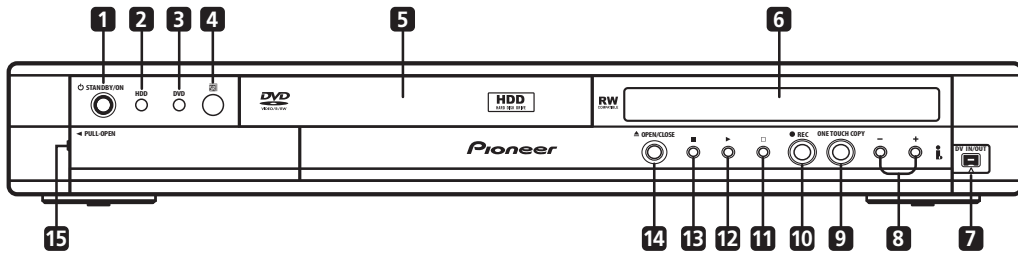

Illustration shows DVR-520H

1 **STANDBY/ON**

Press to switch the recorder on/into standby.

2 **HDD**

Press to switch to the hard disk drive (HDD) for recording and playback. The button lights when HDD is selected.

3 **DVD**

Press to switch to DVD for recording and playback. The button lights when DVD is selected.

4 **IR remote sensor** (page 8)**5** **Disc tray****6** **Front panel display**

See *Display* on page 22 for details.

7 **DV IN/OUT jack (DVR-520H/720H only)** (page 12, 20, 56, 57, 59, 104, 117)

Digital input/output jack for use with a DV camcorder.

8 **+/-** (page 29, 31, 48)

Use to change TV channels, skip chapters/tracks, etc.

9 **ONE TOUCH COPY** (page 62)

Press to start One Touch Copy of the currently playing title to DVD or the HDD.

10 **● REC**

Press to start recording.

11

Press to stop recording.

12

Press to start or restart playback.

13

Press to stop playback.

14 **▲ OPEN/CLOSE**

Press to open/close the disc tray.

15 **Front panel inputs** (page 12)

Pull the cover down where indicated to access the front panel input jacks. Especially convenient for connecting camcorders and other portable equipment.

Display

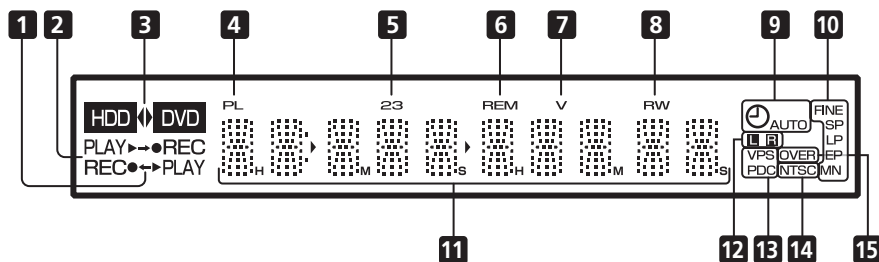

1 ← / →

Arrows indicate the copy direction between the HDD (HDD) and DVD (DVD).

2 ► PLAY / ● REC indicators

Lights during playback / recording; blinks when playback / recording is paused.

3 HDD ◀▶ DVD (page 28)

The '◀' and '▶' indicators light to indicate that the HDD or DVD is selected for recording/playback.

4 PL (page 78, 84)

Lights when a VR mode disc is loaded and the recorder is in Play List mode.

5 23 (page 99)

Shows the remote control mode (if nothing is displayed, the remote control mode is 1).

6 REM

Lights when the character display is showing the remaining available recording time.

7 V

Lights when an unfinalized Video mode disc is loaded.

8 R / RW

Indicates the type of recordable DVD loaded: DVD-R or DVD-RW.

9 ⏸ (page 49)

Lights when a timer recording has been set. (Indicator blinks if the timer has been set to DVD but there isn't a recordable disc loaded, or the timer has been set to HDD but the HDD is not recordable.)

AUTO (page 56)

Lights when Auto Start Recording has been set, and during Auto Start Recording.

10 Recording quality indicators (page 46)

FINE

Lights when the recording mode is set to **FINE** (best quality).

SP

Lights when the recording mode is set to **SP** (standard play).

LP

Lights when the recording mode is set to **LP** (long play).

EP

Lights when the recording mode is set to **EP** (extended play).

MN

Lights when the recording mode is set to **MN** (manual recording level) mode.

11 Character display

12 L R (page 104)

Indicates which channels of a bilingual broadcast are recorded.

13 VPS / PDC (page 49)

Lights when receiving a VPS/PDC broadcast during a VPS/PDC-enabled timer recording.

14 NTSC

Lights when playing NTSC format video.

15 OVER (page 104)

Lights when the analog audio input level is too high.

Remote control

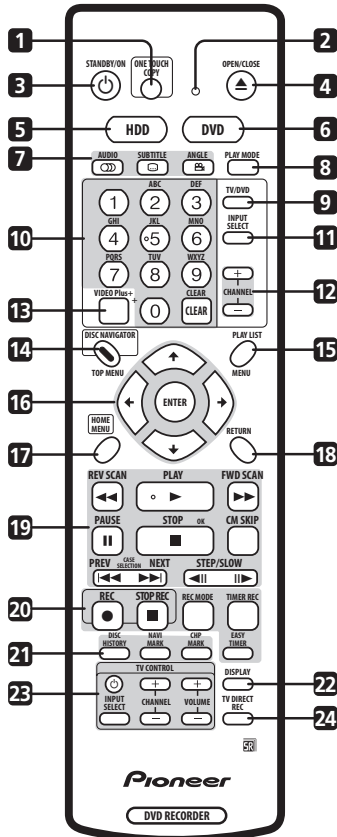

- 1 ONE TOUCH COPY** (page 62)
Press to start One Touch Copy of the currently playing title to DVD or the HDD.
- 2 Remote control indicator**
Lights when setting up the remote control for use with a TV (page 112) and when setting the remote control mode (page 99).
- 3 STANDBY/ON**
Press to switch the recorder on/into standby.
- 4 OPEN/CLOSE**
Press to open/close the disc tray.
- 5 HDD** (page 28)
Press to select the hard disk (HDD) for recording or playback.
- 6 DVD** (page 28)
Press to select the DVD for recording or playback.

7 DVD playback functions

- AUDIO** (page 29, 43, 44)
Changes the audio language or channel. (When the recorder is stopped, press to change the tuner audio.)
- SUBTITLE** (page 43)
Displays/changes the subtitles included in multilingual DVD-Video discs.
- ANGLE** (page 44)
Switches camera angles on discs with multi-angle scenes.

8 PLAY MODE (page 40)

Press to display the Play Mode menu (for features such as search, repeat and program play).

9 TV/DVD (page 29)

Press to switch between 'TV mode', in which you get the picture and sound from the TV's tuner, and 'DVD mode', in which you get picture and sound from the recorder's tuner (or an external input).

10 Alphanumeric buttons and CLEAR

Use the number buttons for track/chapter/title selection; channel selection, and so on. The same buttons can also be used to enter names for titles, discs and so on.

Use **CLEAR** to clear an entry and start again.

11 INPUT SELECT (page 56)

Press to change the input to use for recording.

12 CHANNEL +/- (page 29)

Press to change the channel of the built-in TV tuner.

13 VIDEO Plus+ (page 52)

Press, then use the number buttons to enter a PlusCode® programming number for timer recording.

14 DISC NAVIGATOR (page 36, 76) / TOP MENU (page 31)

Press to display the Disc Navigator screen, or the top menu if a DVD-Video disc is loaded.

15 PLAY LIST (page 78, 84) / MENU (page 31)

Press to switch between Original and Play List content on VR mode discs, or display the disc menu if a DVD-Video disc is loaded.

16 (cursor buttons) and ENTER

Used to navigate all on-screen displays. Press **ENTER** to select the currently highlighted option.

17 HOME MENU (page 33)

Press to display the Home Menu, from which you can navigate all the functions of the recorder.

18 RETURN

Press to go back one level in the on-screen menu or display.

19 Playback controls (page 30)**◀◀ REV SCAN / FWD SCAN ▶▶** (page 38)

Press to start reverse or forward scanning. Press again to change the speed.

▶ PLAY

Press to start playback.

⏸ PAUSE

Press to pause playback or recording.

■ STOP

Press to stop playback.

CM BACK (commercial back)

Press repeatedly to skip progressively backward through the audio or video playing.

CM SKIP (commercial skip)

Press repeatedly to skip progressively forward through the audio or video playing.

⏮ PREV / NEXT ▶▶

Press to skip to the previous or next title/chapter/track/folder; or to display the previous or next menu page.

◀◀ STEP/SLOW ▶▶ (page 39)

During playback, press to start slow-motion playback; while paused, press to show the previous or next video frame.

20 Recording controls (page 28)**● REC**

Press to start recording. Press repeatedly to set the recording time in blocks of 30 mins.

□ STOP REC

Press to stop recording.

REC MODE (page 47)

Press repeatedly to change the recording mode (picture quality).

TIMER REC (page 51)

Press to set a timer recording from the standard Timer Recording screen.

EASY TIMER (page 50)

Press to set a timer recording from the Easy Timer Recording screen.

21 DISC HISTORY (page 89)

Press to display summary information (disc name, recording time left, etc.) from the last 30 recordable discs loaded.

NAVI MARK (page 37)

Press to select a thumbnail picture for the current title for use in the Disc Navigator screen.

CHP MARK (page 81)

Press to insert a chapter marker when playing/recording a VR mode DVD-RW disc or the HDD.

22 DISPLAY (page 33)

Displays/changes the on-screen information displays.

23 TV CONTROL (page 112)

After setting up, use these controls to control your TV.

24 TV DIRECT REC (page 48)

Press to start recording whatever channel your TV is set to.

Chapter 4

Getting started

Switching on and setting up

When you switch the recorder on for the first time, you can make several basic settings using the Setup Navigator feature. This takes you through setting the clock, the internal TV tuner and the video and audio output settings.

If you're using the recorder for the first time, we strongly recommend you use the Setup Navigator before starting to use the recorder.

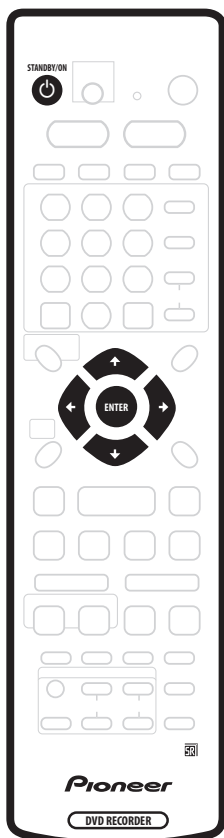

1 Switch on your TV and set the video input to this recorder.

2 Press the \odot STANDBY/ON button on the remote control or the front panel to switch on.

When you switch on for the first time, your TV should display the Setup Navigator screen. (If the Setup Navigator doesn't appear, you can also access it from the Initial Setup menu; see page 99).

- If this recorder is connected to a compatible TV using a fully-wired 21-pin SCART cable, the recorder will take a few seconds to download country, TV screen size and language information. (Check the manual that came with your TV for compatibility information.)

3 Use the \uparrow/\downarrow (cursor up/down) buttons to choose a language, then press ENTER.

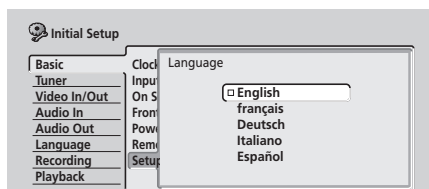

4 Press ENTER to start setting up using the Setup Navigator.

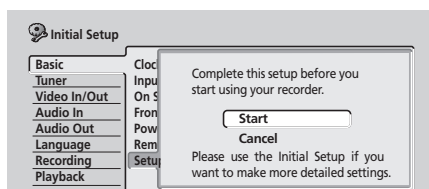

- If you don't want to use the Setup Navigator, press \downarrow (cursor down) to select **Cancel**, then press **ENTER** to exit the Setup Navigator.

5 Select the Auto Channel Setting ('Auto Scan' or 'Download from TV'), or 'Do not set', then press ENTER.

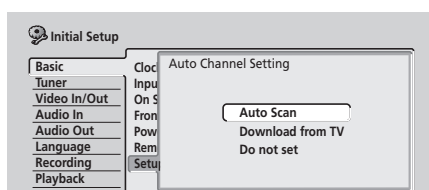

- Select **Do not set** if you want to skip setting up the channels (because they have already been set up, for example).
- You can only use the **Download from TV** feature if you connected this recorder to your TV using a fully-wired 21-pin SCART cable connected to the **AV1(RGB)-TV** connector, and if your TV supports this function (check your TV's instruction manual for more details).
- Use the **←/→** (cursor left/right) buttons to choose your country, then press **ENTER**.

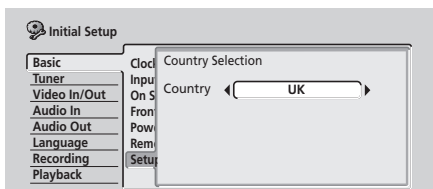

• Auto-tuning channels

The **Auto Scan** option automatically scans and sets the channel presets.

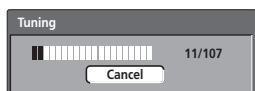

• Downloading channels from your TV

Use the **Download from TV** option to download all the channels that your TV is tuned to.

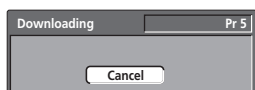

6 Select 'Auto' for automatic time setting, or 'Manual' to set the clock manually, then press ENTER.

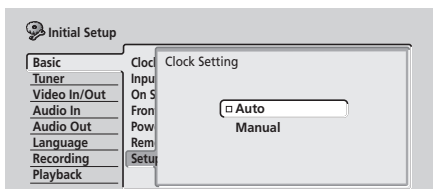

• Auto clock setting

Some TV channels broadcast time signals together with the program. This recorder can use these signals to set the clock automatically.

Set 'Clock Set CH' to the channel preset number that broadcasts a time signal, then move the cursor down to 'Start' and press ENTER.

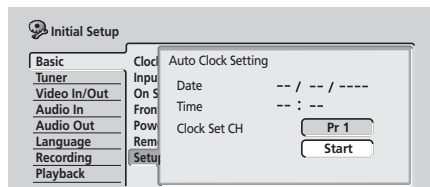

The recorder takes a short while to set the time. After you see that the time has been set, select **Next** to proceed.

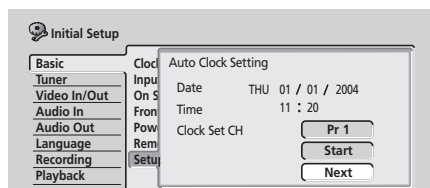

If the time could not be set automatically, press **RETURN** to go back to the previous screen and select **Manual**.

• Manual clock setting

If no stations in your area are broadcasting time signals, you can set the clock manually.

Use the ←/→ (cursor left/right) buttons to set your time zone.

You can set this by selecting a city or a time relative to GMT.

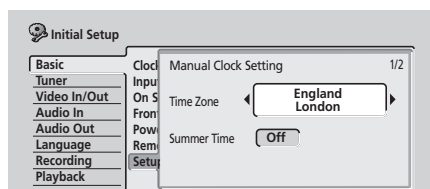

Press ↓ (cursor down) then use the ←/→ (cursor left/right) buttons to select 'On' or 'Off' for summer time, then press ENTER.

Select **On** if you are currently using summer time.

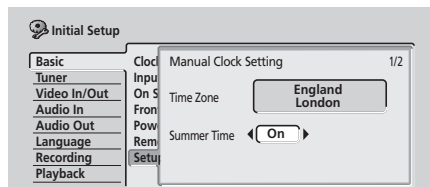

Set the date (day/month/year) and time, then press **ENTER** to make all the settings.

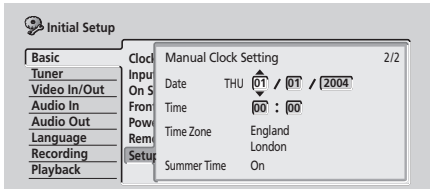

Use the **↑/↓** (cursor up/down) buttons to change the value in the highlighted field.

Use the **←/→** (cursor left/right) buttons to move from one field to another.

- You can go back to the previous screen at anytime in the Setup Navigator by pressing **RETURN**.

7 Select the TV screen type, 'Standard (4:3)' or 'Wide (16:9)'.

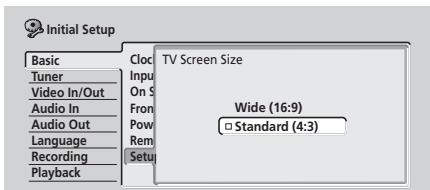

Use the **↑/↓** (cursor up/down) buttons to select, then press **ENTER**.

8 Is this recorder connected to an AV amplifier/receiver for digital audio?

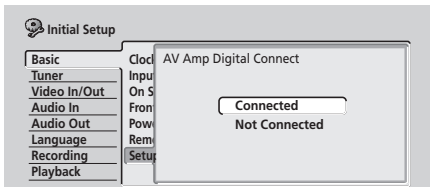

Use the **↑/↓** (cursor up/down) buttons to select **Connected**, or **Not Connected**, then press **ENTER**.

- If you select **Not Connected**, that completes the setup. Press **ENTER** to exit the Setup Navigator, or select **Go Back** if you want to go back and start again.
- Select the digital audio formats your AV amplifier/receiver is compatible with.

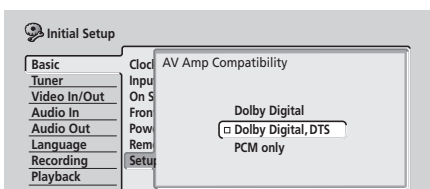

Use the **↑/↓** (cursor up/down) buttons to select **Dolby Digital**, **Dolby Digital**, **DTS** or **PCM only**, then press **ENTER**.

- Check the operating instructions that came with your AV amplifier/receiver if you're not sure what it's compatible with.

9 Is your AV amplifier/receiver compatible with 96 kHz PCM digital audio?

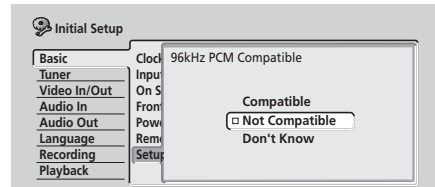

Use the **↑/↓** (cursor up/down) buttons to select **Compatible**, **Not Compatible**, or **Don't Know**, then press **ENTER**.

- Check the operating instructions that came with your AV amplifier/receiver if you're not sure.

10 Press **ENTER** to exit the Setup Navigator, or select 'Go Back' if you want to start again.

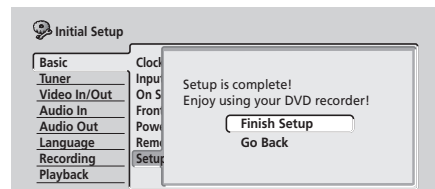

That completes basic setup using the Setup Navigator.

Other settings you can make

After setting up using the Setup Navigator, you should be ready to start enjoying your DVD recorder. It's possible, however, that you may want to make a couple of additional settings, depending on how the recorder is set up for terrestrial TV broadcasts.

- Manual channel setting – This setting lets you skip channels where there is no station, as well as manually tune to stations. See *Manual CH Setting* on page 100.
- VIDEO Plus+ channel setting – This setting lets you assign guide channels to ensure that the VIDEO Plus+ programming system works correctly. See *Set VIDEO Plus+ CH* on page 101.
- Setting up the remote to control your TV – You can set up the supplied remote control to control many brands of TV. See *Setting up the remote to control your TV* on page 112.

Selecting the hard disk or DVD for playback and recording

The **HDD** and **DVD** buttons (remote control and front panel) are used to select the hard disk (HDD) or DVD for playback and recording. The indicator in the front panel display shows which is currently selected.



Making your first recording

This quick guide shows you how to make a basic recording of a TV program on either the HDD, or to a recordable DVD.

Recording is covered in much more detail in chapter 6 (*Recording*).

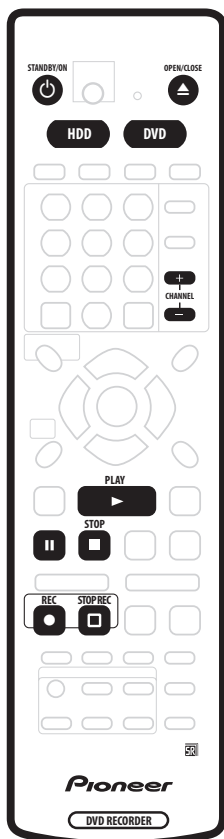

1 If they aren't already on, switch on your TV and this recorder.

Press **STANDBY/ON** to switch on.

- Make sure that the video input on your TV is set to this recorder.

2 Press **HDD** to record to the HDD, or **DVD** to record to a recordable DVD.

If you choose to record to the HDD, skip to step 5 now.

3 Press **▲ OPEN/CLOSE** to open the disc tray.

4 Load a blank DVD-R or DVD-RW disc with the label side face-up, using the disc guide to align the disc.

- When you load a new, blank DVD-RW disc, the recorder will take a moment to initialize it for recording.

5 Use the **CHANNEL +/-** buttons to select the TV channel you want to record from.

- You can also use the **+/-** buttons on the front panel if the recorder is stopped.
- Channel presets are numbered 1–99.
- If the recorder is connected to your TV using a SCART cable and your TV supports Direct Recording, it's possible to quickly start recording whatever channel your TV is tuned to. See *Direct recording from TV* on page 48 for detailed instructions.

6 Press **● REC** to start recording.

- By default, the recording will be in **SP** (standard play) mode, which will give you around two hours of recording from a blank DVD disc.
- You can pause recording by pressing **▢ PAUSE**. Press **● REC** or **▢ PAUSE** again to restart recording.

7 When you want to stop recording, press **□ STOP REC**.

Playing back your recording

The TV program you just recorded should be on the HDD or DVD disc as a single title with one or more chapters.

- Press **▶ PLAY** to start playback.

If you want to stop playback before the end of the recording, press **■ STOP**.

Using the built-in TV tuner

Changing TV channels

There are three different ways to select TV channels. Note that you can't change the TV channel during playback, recording or during recording standby.



- **CHANNEL +/-** buttons on the remote
- **Number buttons** on the remote – For example, to select channel 4, press **4** then **ENTER**; for channel 34, press **3**, **4**, **ENTER**.
- **+/-** buttons on the front panel

Note

- Channel presets are numbered 1–99.
- You can't change TV channels during playback or recording, or while in recording standby.

Changing audio channels

You can change the audio channel of the broadcast or external input signal.

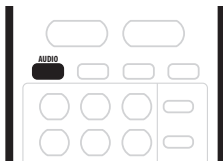

- **Press AUDIO to change the audio.** The current audio channel is displayed on-screen.
- If the NICAM audio setting (see *NICAM Select* on page 103) is set to **NICAM** and you are watching a NICAM broadcast, you can switch between **NICAM** and **Regular** (non-NICAM) audio.



- If the NICAM broadcast is bilingual, you can also select the language.

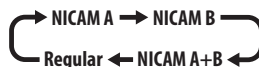

- You can also select the language for a non-NICAM bilingual broadcast.

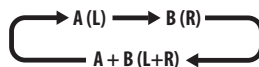

- When watching a recording made from an external input with **Bilingual** recording selected (see *External Audio* on page 103), you can switch the audio channel between left (**L**), right (**R**) or both (**L+R**).



Note

- When recording to the HDD, or in Video mode, or in VR mode using the **FINE/MN32** setting, only one channel of a bilingual broadcast is recorded. In this case, decide which language you want to record before recording by setting the Bilingual Recording setting (see *Bilingual Recording* on page 104).

Switching between TV and DVD

When the recorder is stopped or recording you can choose whether to have the audio/video from the built-in TV tuner (or external input) play on your TV ('DVD mode'), or watch the channel that the TV is currently set to ('TV mode').

During playback or when a menu is being displayed on-screen, the sound and video is always routed to your TV and is unaffected by the **TV/DVD** mode setting.

Note that the recorder must be connected to your TV using a SCART cable to be able to use this feature.

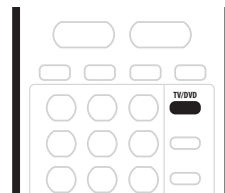

- **Press TV/DVD to switch between TV mode and DVD mode.**

Basic playback

This section shows you how to use your recorder for playback of discs (DVD, CD, etc.), and for playback of video from the HDD. More playback features, such as repeat and program play, are covered in the next chapter.

Important

- Throughout this manual, the term 'DVD' means playback-only DVD-Video discs and DVD-R/RW. If a function is specific to a particular kind of DVD disc, it is specified.
- Some DVD-Video discs don't allow certain playback controls to operate at certain points in the disc. This is not a malfunction.

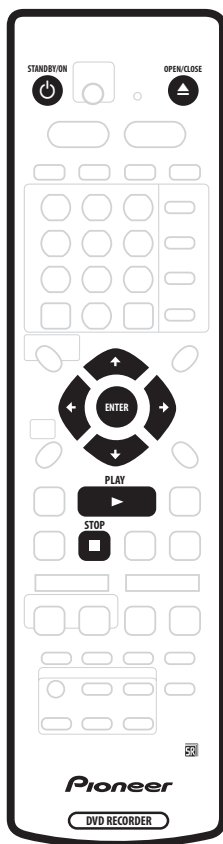

1 Press STANDBY/ON to switch on.

Also turn on your TV and make sure that it is set to the correct video input.

2 Press **HDD** to playback from the HDD, or **DVD** to play a DVD.

If playing video from the HDD, skip to step **5** below.

3 Press OPEN/CLOSE to open the disc tray.

4 Load a disc.

Load a disc with the label side facing up, using the disc tray guide to align the disc (if you're loading a double-sided DVD-Video disc, load it with the side you want to play face down).



- If you want to play a DTS audio CD, please first read the note on page 32.

5 Press PLAY to start playback.

- If you're playing a DVD-Video or Video CD, a disc menu may appear when you start playback. Use the  (cursor) buttons and **ENTER** to navigate DVD disc menus, and the number buttons and **ENTER** for Video CD menus.
- When playing video from the HDD, playback will automatically stop after the end of a title is reached.
- See the following sections for more details on playing specific kinds of discs.

6 To stop playback, press STOP.

7 When you've finished using the recorder, eject the disc and switch the recorder back into standby.

- To open/close the disc tray, press  OPEN/CLOSE. Remove the disc before putting the recorder into standby.
- Press  STANDBY/ON to switch the recorder into standby.

Playing DVD discs

The table below shows the basic playback controls for DVD-Video, and recordable DVD discs.



Press to start playback.
If **RESUME** is displayed on-screen, playback starts from the place last stopped.



Press to stop playback.
You can resume playback from the same point by pressing ► **PLAY**. (Press ■ **STOP** again to cancel the resume function.)



Pauses playback, or restarts playback when paused.



Press to start scanning. Press repeatedly to increase the scanning speed.



Press to skip to previous/next chapter/title. (You can also use the front panel +/- buttons to do this during playback.)



Except VR mode: During playback, enter a chapter number then press **ENTER** to skip directly to that chapter within the currently playing title.

On some discs, you can also use the number buttons to select numbered items in the disc menu.

VR mode only: During playback, enter a title number then press **ENTER**.

All: Press **CLEAR** to clear a number entry and start again.



(Commercial back/skip) Each press skips backward/forward progressively up to a maximum of 10 minutes forward or three minutes back.



During playback, press to start slow-motion playback. Press repeatedly to change the playback speed.
While paused, press to advance a single frame in either direction.



Press to display the 'top' menu or menu of a DVD-Video disc (these are often the same).



Use the cursor buttons to navigate DVD-Video disc menus; press **ENTER** to select items.



Press to return to the previous level of a DVD-Video disc menu.

Playing from the HDD

The table below shows the basic playback controls when playing video recorded on the hard disk (HDD).



Press to start playback.
If **RESUME** is displayed on-screen, playback starts from the place last stopped. Playback automatically stops after the end of a title is reached.



Press to stop playback.
You can resume playback from the same point by pressing ► **PLAY**. (Press ■ **STOP** again to cancel the resume function.)



Pauses playback, or restarts playback when paused.



Press to start scanning. Press repeatedly to increase the scanning speed.



Press to skip to previous/next chapter/title. (You can also use the front panel +/- buttons to do this during playback.)



During playback, enter a title number then press **ENTER** to skip directly to that title. Press **CLEAR** to clear a number entry and start again.



(Commercial back/skip) Each press skips backward/forward progressively up to a maximum of 10 minutes forward or three minutes back.



During playback, press to start slow-motion playback. Press repeatedly to change the playback speed.
While paused, press to advance a single frame in either direction.

Playing CDs and WMA/MP3 discs

The table below shows the basic playback controls for audio CDs, and WMA/MP3 files.

 Press to start playback.

 Press to stop playback.

 Pauses playback, or restarts playback when paused.

 *CD and MP3 only:* Press to start scanning. Press again to increase the scanning speed. (There are two scan speeds; the current scan speed is shown on-screen.)

 Press to skip to previous/next track (or folder for WMA/MP3 disc). (You can also use the front panel +/- buttons to do this during playback.)

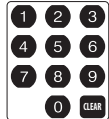
 During playback, enter a track number then press **ENTER** to skip directly to that track. Press **CLEAR** to clear a number entry and start again.



Note

- If you want to play a DTS audio CD, make sure the recorder is connected to a DTS-compatible amp/receiver with a digital connection. Noise will be output through the analog outputs. Also make sure that **STEREO** is selected using the **AUDIO** button (see *Switching audio channels* on page 44).
- Scanning doesn't work with WMA tracks.

Playing Video CD/Super VCDs

The table below shows the basic playback controls for Video CD/Super VCDs.

Some discs feature Playback Control (PBC for short) menus. These discs show PBC in the display when you load them and display a menu on-screen from where you can select what to watch.

 Press to start playback.
Video CD only: If **RESUME** is displayed on-screen, playback starts from the place last stopped.

 Press to stop playback.
Video CD only: You can resume playback from the same point by pressing **▶ PLAY**. (Press **■ STOP** again to cancel the resume function.)

 Pauses playback, or restarts playback when paused.

 Press to start scanning. Press repeatedly to increase the scanning speed.

 Press to skip to previous/next track. (You can also use the front panel +/- buttons to do this during playback.)
When a PBC menu is displayed, press to display the previous/next page.

 During playback, enter a track number then press **ENTER** to skip directly to that track. Press **CLEAR** to clear a number entry and start again.

 While a PBC menu screen is displayed, use to select numbered menu items.

 *Video CD only:* Each press skips backward/forward progressively up to a maximum of 10 minutes forward or three minutes back. Note that this function doesn't work when playing in PBC mode.

 During playback, press to start slow-motion playback. Press repeatedly to change the playback speed. While paused, press to advance a single frame (forward direction only).

 Press to display the disc menu of a Video CD/Super VCD playing in PBC mode.

Note

- When playing in PBC mode, some playback features, such as search, repeat and program play are not available. You can play a PBC Video CD/Super VCD in non-PBC mode by pressing **▶▶▶** to start playback instead of **▶ PLAY**.

Note

- Some options in the Home Menu may be grayed out sometimes, indicating that they are not available at the present time. For example, the Photoviewer option is grayed out unless there is a disc loaded that contains JPEG image files.

Using the Home Menu

From the Home Menu screen you can access all the features of the recorder. Press **HOME MENU** to display the Home Menu screen:



DVR-520H/720H screen

Use the **↑/↓/←/→** (cursor) buttons followed by **ENTER** to select the option you want. To exit the Home Menu, press **HOME MENU**.

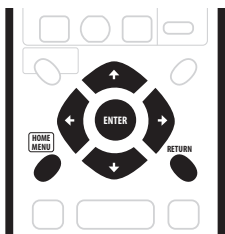

Displaying disc information on-screen

You can display various on-screen information about the disc loaded or the HDD.

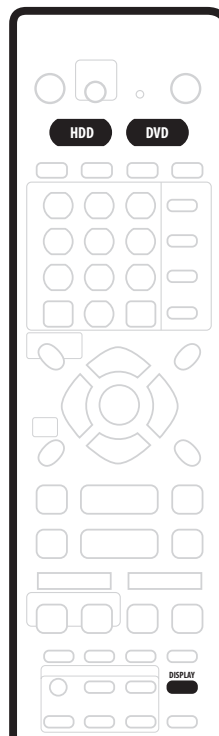

Home menu options	
Timer Recording (page 49)	Disc Setup (page 92)
Disc Navigator (page 36, page 76)	Initial Setup (page 97)
Copy (page 61)	Video/Audio Adjust (page 94)
Disc History (page 89)	Play Mode (page 40)
PhotoViewer (page 90)	DV Record (DVR-520H/720H only) (page 57)

1 Press DISPLAY repeatedly to display/change the on-screen information.

- Press once to show the HDD and removable disc (DVD, etc.) activity together. Press again to show the status of just the currently selected playback/recording device (HDD or removable disc).
- The on-screen display automatically disappears after 150 minutes.

2 To hide the information display, press DISPLAY repeatedly until it disappears.

The example displays below are a guide only; actual displays vary according to the disc loaded, etc.

HDD and removable disc activity display

Press **DISPLAY** once to see the HDD and removable disc (DVD, etc.) activity. Use the **HDD** and **DVD** buttons to switch between the two kinds of display.

The example displays below show high-speed copying from HDD to DVD, and HDD chase playback.

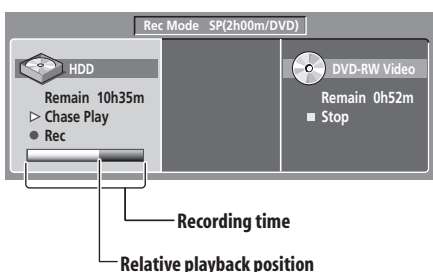
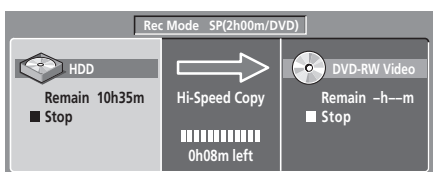

Stop display 1

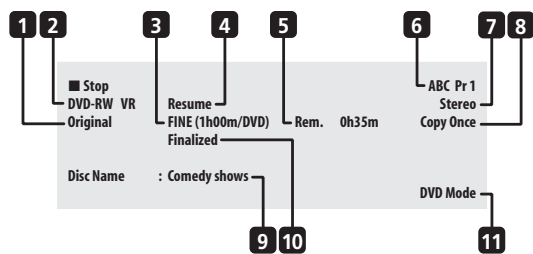

1 DVD-RW Original / Play List

If a VR mode disc is loaded, this shows whether playback is currently set to **Original** or **Play List**.

During preview playback of the Copy List, this shows **Copy List**.

2 Disc type and mode

Shows the disc type (**HDD**, **DVD-R**, **DVD-RW**, **CD**, etc.), and the disc mode for recordable DVD, if applicable (**VR** or **Video**).

3 Recording mode and time

Shows the current recording mode (**FINE**, **SP**, **LP**, etc.), and the total recording time of the disc.

4 Resume

Shows **Resume** if playback can be resumed from the last place stopped.

5 Recording time remaining

Shows the approximate recording time left on the disc in the current recording mode.

6 Preset name and number

Shows the preset name and preset number for the currently selected channel.

7 Audio mode

Shows the broadcast audio mode for the current channel preset (**Mono**, **Stereo**, etc.).

8 Copy control information

Shows recording restrictions of the current channel program.

9 Disc name

Shows the disc name.

(For CDs, this area shows playable files other than CD audio tracks; for example, **Multi-format: WMA/MP3**.)

10 Finalized

Shows **Finalized** if a recordable DVD is finalized.

11 TV/DVD mode

Shows the current mode of the recorder (see *Switching between TV and DVD* on page 29).

Stop display 2

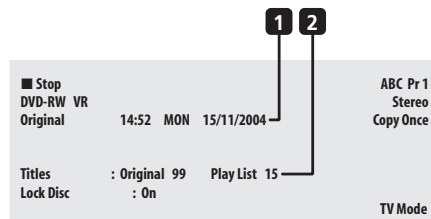

1 Date and time

2 Number of titles/tracks on disc

For a VR mode DVD-RW, the number of Original and Play List titles are shown separately.

Play display 1

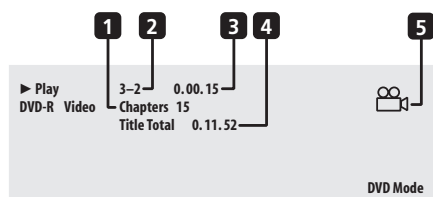

1 Number of chapters in title**2 Current title and chapter number**

(For CD/Video CD/Super VCD, shows current track; for WMA/MP3, shows current folder and track; for JPEG disc, shows current folder and file.)

3 Elapsed title time

(For CD, WMA, MP3, Super VCD, shows elapsed track time; for Video CD, shows elapsed disc time.)

4 Total running time of title**5 Angle indicator**

Lights during multi-angle scenes.

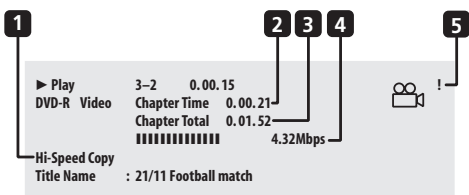
Play display 2**1 Chase playback, simultaneous record/playback, copy, disc back-up**

Indicates that recording, copying or back-up is in progress.

2 Elapsed chapter time**3 Total running time of chapter****4 Data transfer rate**

Shows the current data rate being read from the disc.

5 Copy protected material (!)

Shows '!' if the playback material is copy-once protected.

4 Remaining recording time available

Shows the amount of space left on the disc in the current recording mode.

5 Recording mode

Shows the current recording mode (**FINE**, **SP**, **LP**, etc.), and the total recording time of the disc.

Note

- When using the simultaneous play and record feature, the display shows information for playback only.
- During real-time copy, the copy source playback information is displayed.
- Data transfer rate shows the amount of video and audio information recorded on the disc. It is not an indication of picture/audio quality.
- The Video mode disc displays become the same as a DVD-Video disc once the disc is finalized.
- The total recording time figure shown in parenthesis is calculated based on a 12cm/4.7GB disc at the displayed record setting.
- Recording and playback times for TV recordings are approximately 0.1% shorter than the actual time. This is because of the slightly different frame rates of TV broadcasts versus DVD.
- The frame number is shown next to the elapsed time display when the disc is paused.
- **Copy Once** or **Can't Record** messages may appear in the stop or recording displays. These indicate that the broadcast TV program contains copy control information.

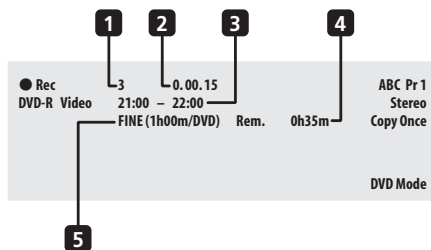
Recording display**1 Current title number****2 Elapsed recording time****3 Timer recording start and stop times**

Shows the start and stop times if the current recording is a timer recording.

Chapter 5

Playback

Introduction

Most of the features described in this chapter make use of on-screen displays. Navigate these using the **↑/↓/←/→** (cursor buttons) and **ENTER**. To go back one level from any screen, use the **RETURN** button. Remember also that the button guide at the bottom of every screen shows which buttons do what.

Many of the functions covered in this chapter apply to the HDD, DVD discs, Video CDs, Super VCDs, WMA/MP3 discs and CDs, although the exact operation of some varies slightly with the kind of disc loaded. The following icons are provided to help you quickly identify which instructions you need for which kind of disc.

- DVD** Any kind of DVD, DVD-R or DVD-RW
- DVD-Video** Commercially produced DVD or finalized Video mode DVD-R/RW
- Video mode** Video mode DVD-R/RW (unfinalized)
- VR mode** VR mode DVD-RW
- HDD** HDD
- CD** Audio CD
- Video CD** Video CD
- Super VCD** Super VCD
- WMA/MP3** WMA or MP3 files
- MP3** MP3 files

- Some DVD-Video discs don't allow certain playback controls to operate at certain points in the disc. This is not a malfunction.
- When playing Video CDs, some functions, such as making a program list, are not available in PBC mode. Stop the disc first, then start playback by pressing **▶▶**.
- For discs that contain JPEG picture files, see *The PhotoViewer* on page 90.

Using the Disc Navigator to browse the contents of a disc.

Use the Disc Navigator to browse the contents of a disc and start playback.

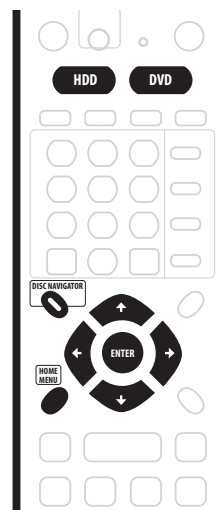

Using the Disc Navigator with playback-only discs

DVD-Video **CD** **Video CD** **Super VCD** **WMA/MP3**

1 Press HOME MENU and select 'Disc Navigator' from the on-screen display.

Alternatively, for a CD, Video CD, Super VCD or WMA/MP3 disc, you can press **DISC NAVIGATOR**, which takes you straight to the Disc Navigator screen.



DVR-520H/720H screen

2 Select what you want to play.

Use the **↑/↓/←/→** (cursor buttons) to highlight items and **ENTER** to select.

Depending on the type of disc you have loaded, the Disc Navigator looks slightly different.

The screen for DVD discs shows the titles on the left and the chapters on the right. Select a title, or a chapter within a title.

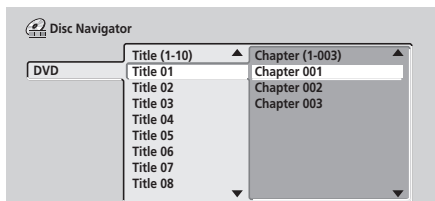

The screen for CDs and Video CDs shows a list of tracks.

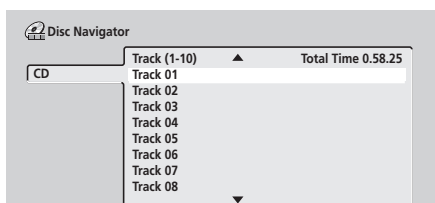

The screen for WMA/MP3 discs shows a list of folders and tracks. Select a folder or a track within a folder.

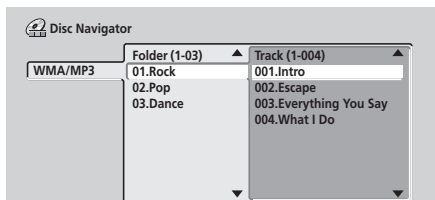

Playback starts after you press **ENTER**.

- For discs that contain both CD-Audio tracks and WMA/MP3 tracks, you can switch the playback area between **CD** and **WMA/MP3**. This can only be done while the disc is stopped.

Using the Disc Navigator with recordable discs and the HDD

VR mode **Video mode** **HDD**

When used with a recordable disc or the HDD, the Disc Navigator gives you access to all the editing features of this recorder as well as the ability to browse and play titles. See also *Editing* on page 76 for more on editing recordable discs.

1 Press HDD or DVD to select the hard disk drive or the DVD drive.

2 Press HOME MENU and select 'Disc Navigator' from the on-screen display.

Alternatively, you can press **DISC NAVIGATOR** to go straight to the Disc Navigator screen.

3 Select 'Play' from the menu options.

Press **ENTER** to move to the thumbnails area of the screen.

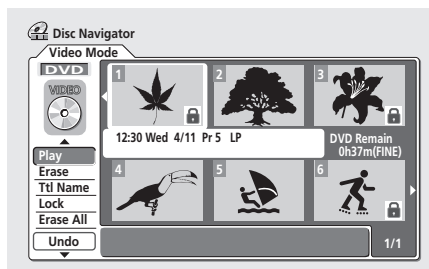

4 Use the ↑/↓/←/→ (cursor buttons) to select a title to play.

5 Press ENTER to start playback.

Note

- It's not possible to use the Disc Navigator when playing a Video CD in PBC mode.
- Another way to find a particular place on a disc is to use the time search mode. See *Search Mode* on page 40.

Changing the thumbnail picture for a title

VR mode **Video mode** **HDD**

You can change the thumbnail picture that appears for each title in the Disc Navigator screen using the **NAVI MARK** button.

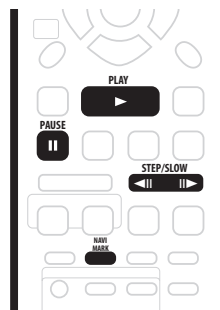

- 1 Start playback of the title you want to change the thumbnail for.
- 2 Press **NAVI MARK** anywhere in the title to make the displayed picture the thumbnail for that title.
 - For greater control over the exact frame you want to use, you can use the **II PAUSE** and/or slow-motion/frame advance/reverse controls (**◀II / II▶**).

Navigating discs and the HDD

ALL

During playback you can easily jump to another title, chapter or track on a disc using the number buttons on the remote.



DVD-Video Video mode

- 1 During playback use the number buttons to enter a chapter number within the current title. For example, for chapter 6, press **6**; for chapter 24, press **2**, then **4**.
 - To clear and start again, press **CLEAR**.
- 2 **Optionally: Press ENTER.**
 - Alternatively, just wait a few seconds and playback will jump to the new chapter.

VR mode HDD

- 1 During playback, use the number buttons to input a title number. For example, for title 6, press **6**; for title 24, press **2**, then **4**.
 - To clear and start again, press **CLEAR**.
- 2 **Optionally: Press ENTER.**
 - Alternatively, just wait a few seconds and playback will jump to the new title.

CD Video CD Super VCD WMA/MP3

- 1 During playback, use the number buttons to input a track number. For example, for track 6, press **6**; for track 24, press **2**, then **4**.
 - To clear and start again, press **CLEAR**.
- 2 **Optionally: Press ENTER.**
 - Alternatively, just wait a few seconds and playback will jump to the new track.

Scanning discs

You can fast scan discs at various speeds, forwards or backward.

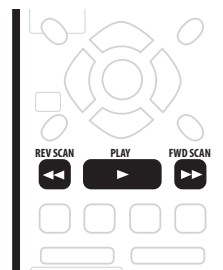

- 1 During playback, press **◀◀** or **▶▶** to start reverse or forward scanning.
 - The scanning speed is shown on-screen.
- 2 Press the same button repeatedly to increase the scanning speed.

DVD HDD

- **Forward:**
SCAN 1 → SCAN 2 → SCAN 3 → SCAN 4
- **Reverse:**
Reverse play → SCAN 1 → SCAN 2 → SCAN 3 → SCAN 4

CD Video CD Super VCD MP3

- **Forward/Reverse:**
SCAN 1 → SCAN 2
- 3 To resume normal playback, press **▶ PLAY**.

Note

- Depending on the disc, reverse playback may not be smooth.
- Sound can be heard while scanning audio CDs (analog output only).
- Scanning is not possible with WMA files.

- No subtitles are displayed while scanning DVD-Video discs.
- Analog and digital sound is output when scanning DVDs with Dolby Digital or Linear PCM sound on forward **SCAN 1**. (Linear PCM is output from the optical digital output.*) No sound is output when using other scan speeds.
* Except during chase playback and simultaneous recording/playback.
- No sound is output when scanning from the HDD, except on forward **SCAN 1**. (Linear PCM is output from the optical digital output during forward **SCAN 1**).
- Depending on the disc, normal playback may automatically resume when a new chapter is reached on a DVD disc.

Note

- The picture quality during slow motion playback is not as good as during normal playback and depends on the disc being played.
- Reverse slow-motion playback may not be as smooth as forward and may be better with some discs than others.
- Depending on the disc, normal playback may automatically resume when a new chapter is reached on a DVD disc.
- No sound is output during slow-motion playback.

Playing in slow motion

DVD HDD Video CD Super VCD

You can play video at various slow motion speeds. DVDs and video on the HDD can be played in slow motion in either direction, while Video CD/Super VCDs can only be played forwards in slow motion.

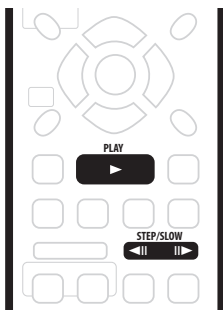

- 1 Press ◀|| or ||▶ to start slow motion reverse or forward playback.
- 2 Press the same button repeatedly to change the slow motion speed.

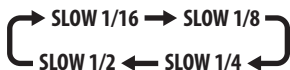

- 3 To resume normal playback, press ▶ PLAY.

Frame advance/frame reverse

DVD HDD Video CD Super VCD

You can advance or back up video on a DVD disc or the HDD frame-by-frame. With Video CD/Super VCDs, you can only use frame advance.

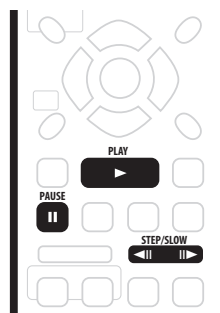

- 1 During playback, press || PAUSE.
- 2 Press ◀|| or ||▶ to back up or advance one frame.
 - Hold down ◀|| or ||▶ for continuous frame reverse/frame advance.
- 3 To resume normal playback, press ▶ PLAY.

Note

- The picture quality when using frame reverse is not as good as frame advance.
- Depending on the disc, normal playback may automatically resume when a new chapter is reached on a DVD disc.

The Play Mode menu

ALL

The Play Mode menu gives you access to search functions, repeat and program play functions.



Important

- You can't use the Play Mode features with Video CD/ Super VCDs playing in PBC mode, or while a DVD disc menu is being displayed. For other restrictions, see the following sections.



- 1 Press **PLAY MODE** to display the Play Mode menu screen.

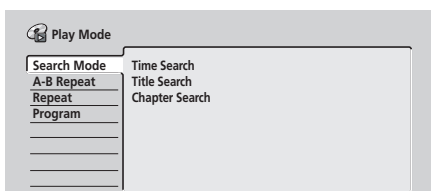

- You can also access the Play Mode menu from the Home Menu (press **HOME MENU**).

- 2 Use the **↑/↓/←/→** (cursor buttons) and **ENTER** to navigate.
 - To exit the Play Mode menu, press **HOME MENU** or **PLAY MODE**.

Search Mode

ALL

The Search Mode feature lets you start playback from a specified point in a disc by time or by title/chapter/folder/track number.

- 1 Select '**Search Mode**' from the Play Mode menu.
- 2 Select one of the search options.
- 3 Use the number buttons to enter a title/chapter/folder/track number or the search time (in hours, minutes & seconds).

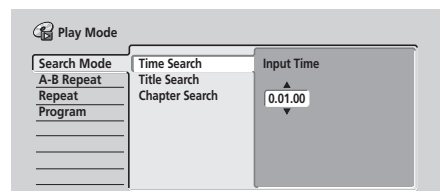

Time Search (HDD, DVD): For example, for 25 minutes into the current title, press **2, 5, 0, 0**. For 1 hour and 15 minutes and 20 seconds into the title, press **1, 1, 5, 2, 0**.

Time Search (Video CD): For example, for 45 minutes into the disc, press **4, 5, 0, 0**.

Title/Chapter/Folder/Track Search: For example, for track 6, press **6**. Alternatively, you can use the **↑/↓** (cursor up/down) buttons.

- 4 Press **ENTER**.



Tip

- You can often select what you want to watch on a DVD disc from the disc menu. Press **MENU** or **TOP MENU** to display the disc menu.



Note

- When using time search, playback may occasionally start slightly before or after the time you input.
- Time search doesn't work with Super VCDs.

A-B Repeat

DVD

CD

Video CD

HDD

The A-B Repeat function allows you to specify two points (A and B) within a track or title that form a loop which is played over and over.



Important

- You can't use A-B Repeat with WMA/MP3 or Super VCD discs.

- 1 During playback, select 'A-B Repeat' from the Play Mode menu.
- 2 With 'A (Loop Start)' highlighted, press ENTER at the point you want the loop to start.

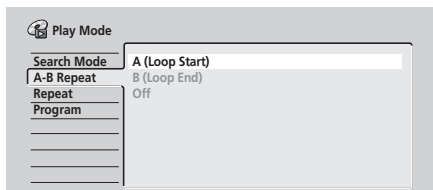

After setting the loop start point, the highlight will automatically move down to **B(Loop End)**.

- 3 With 'B (Loop End)' highlighted, press ENTER at the point you want the loop to end. Playback immediately jumps back to the start point and plays the loop round and round.

- When playing a DVD-Video/Video mode DVD, or from the HDD, the start and end points of the loop must be in the same title.

- 4 To resume normal playback, select 'Off' from the A-B Repeat menu.

- You can also press **CLEAR** to cancel A-B Repeat play if no menu OSD (such as the Play Mode menu) is displayed.



Note

- If you switch camera angles while using A-B Repeat with a DVD-Video disc, A-B repeat is canceled.

Repeat play

ALL

There are various repeat play options, depending on the kind of disc loaded, or if you're using the HDD for playback. It's also possible to use repeat play together with program play to repeat the tracks/chapters in the program list (see *Program play* below).

- 1 Select 'Repeat' from the Play Mode menu.
- 2 Select a repeat play mode.

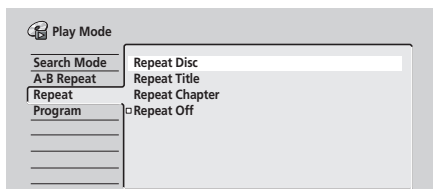

VR mode

- For VR mode DVD discs, select **Repeat Disc**, **Repeat Title** or **Repeat Chapter** (or **Repeat Off**).

DVD-Video Video mode HDD

- For HDD, DVD-Video and Video mode DVD discs, select **Repeat Title** or **Repeat Chapter** (or **Repeat Off**).

CD Video CD Super VCD

- For CDs and Video CD/Super VCDs, select **Repeat Disc** or **Repeat Track** (or **Repeat Off**).

WMA/MP3

- For WMA/MP3 discs, select **Repeat Disc**, **Repeat Folder** or **Repeat Track** (or **Repeat Off**).

- 3 To resume normal playback, select 'Repeat Off' from the Repeat Play menu.

- You can also press **CLEAR** to cancel repeat play if no menu OSD (such as the Play Mode menu) is displayed.



Note

- If you switch the camera angle during repeat play of a DVD-Video disc, repeat play is canceled.
- If there is a program list, you can also select **Repeat Program** to repeat the program list.

Program play

DVD-Video CD Video CD Super VCD WMA/MP3

This feature lets you program the play order of titles/chapters/folders/tracks on a disc.

- 1 Select 'Program' from the Play Mode menu.
- 2 Select 'Input/Edit Program' from the list of program options.

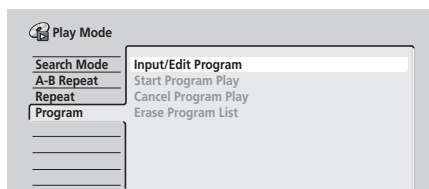

The Program edit screen that appears depends on the kind of disc loaded.

On the left side is the program list, then to the right is a list of titles (DVD), folders (WMA/MP3), or tracks (CD, Video CD/Super VCDs). On the far right is a list of chapters (DVD) or tracks (WMA/MP3).

3 Select a title, chapter, folder or track for the current step in the program list.

For a DVD disc, you can add a whole title, or a chapter within a title to the program list.

- To add a title, select the title.
- To add a chapter, first highlight the title, then press **→** (cursor right) and select a chapter from the list.

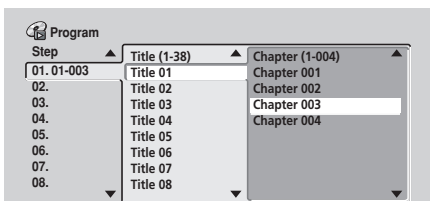

For a CD or Video CD/Super VCD, select a track to add to the program list.

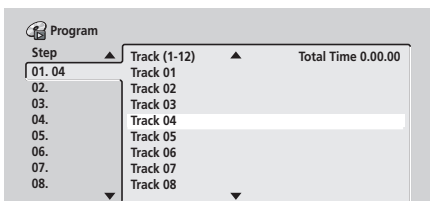

For a WMA/MP3 disc, you can add a whole folder, or a track within a folder to the program list.

- To add a folder, select the folder.
- To add a track, first highlight the folder, then press **→** (cursor right) and select a track from the list.

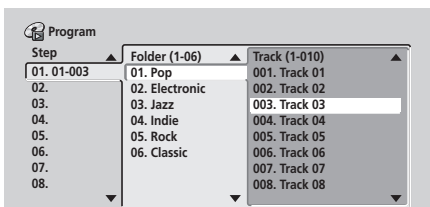

After pressing **ENTER** to add the title/chapter/folder/track, the step number automatically moves down one.

- To insert a step into the program list, highlight the step number where you want to insert another step, then select a chapter/title/folder/track as usual. After pressing **ENTER**, all the subsequent steps move down one.
- To delete a step from the program list, highlight the step you want to delete, then press **CLEAR**.

4 Repeat step 3 to build up a program list.

A program list can contain up to 24 titles/chapters/folders/tracks.

5 To play the program list, press **▶ PLAY**.

Program play remains active until you turn off program play (see below), erase the program list (see below), eject the disc or switch off the recorder.



Tip

- To save your program list and exit the program edit screen without starting playback, press **HOME MENU** or **PLAY MODE**.
- You can change the program list by selecting **Input/Edit Program** from the Play Mode Program menu.
- During program play, press **▶▶** to skip to the next program step.
- Press **CLEAR** during playback to switch off program play (if no menu OSD, such as the Disc Navigator, is displayed). Press while stopped to erase the program list.

Other Program play functions

As well as creating and editing a program list, you can start program play, cancel program play, and erase the program list from the Play Mode menu.

1 Press **PLAY MODE** and select 'Program' from the list of functions on the left.

2 Select a program play function.

- **Input/Edit Program** – See above
- **Start Program Play** – Starts playback of a saved program list
- **Cancel Program Play** – Turns off program play, but does not erase the program list
- **Erase Program List** – Erases the program list and turns off program play



Note

- When playing a program list of DVD-Video chapters, chapters not included in the program list may be sometimes be played, depending on the disc.
- You can use repeat play with program play. Start playback of the program list then select **Program Repeat** from the Repeat Play Mode menu (see *Repeat play* on page 41).

Displaying and switching subtitles

DVD-Video

Some DVD discs have subtitles in one or more languages; the disc box will usually tell you which subtitle languages are available. You can switch subtitle language during playback.

Check the disc packaging for details of the subtitle options.

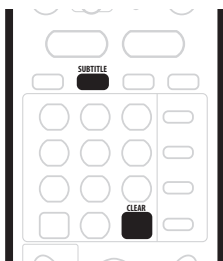

1 Press SUBTITLE repeatedly to select a subtitle option.

The current subtitle language is shown on-screen and in the front panel display.

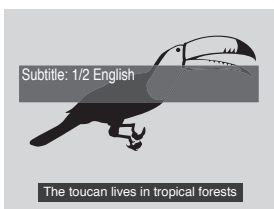

2 To switch off subtitles, press SUBTITLE then CLEAR.

Note

- Some discs only allow you to change subtitle language from the disc menu. Press **TOP MENU** to access.
- To set subtitle preferences, see *Subtitle Language* on page 106.

Switching DVD soundtracks

DVD-Video

When playing a DVD disc recorded with two or more soundtracks (often in different languages), you can switch the soundtrack during playback.

Check the disc packaging for details of the soundtrack options.



• Press AUDIO repeatedly to select an audio soundtrack.

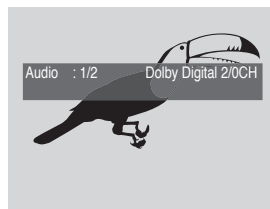

Note

- The sound may drop out for a few seconds when switching soundtracks.
- Some discs only allow you to change audio language from the disc menu. Press **TOP MENU** to access.
- To set audio language preferences, see *Audio Language* on page 105.
- Some discs feature both Dolby Digital and DTS soundtracks. There is no analog audio output when DTS is selected. To listen to the DTS soundtrack, connect this recorder to a DTS decoder or AV amp/receiver with built-in DTS decoder via the digital output. See *Connecting to an AV amplifier/receiver* on page 19 for connection details.

Switching audio channels

VR mode CD Video CD Super VCD WMA/MP3

For VR mode content recorded with bilingual audio, you can switch between left (L) channel, right (R) channel, or both (L+R).

When playing Video CDs and audio CDs you can switch between stereo, just the left channel or just the right channel.

Some Super VCD discs have two soundtracks. With these discs you can switch between the two soundtracks as well as individual channels in each.



1 To display/switch the audio channel, press **AUDIO** repeatedly.

The audio channel(s) currently playing are indicated on-screen.

VR mode

- **L+R** – Both channels (default)
- **L** – Left channel only
- **R** – Right channel only

CD

Video CD WMA/MP3

- **Stereo** – Stereo (default)
- **1/L** – Left channel only
- **2/R** – Right channel only

Super VCD

- **1 Stereo** – Soundtrack 1 / Stereo (default)
- **1 L** – Soundtrack 1 / Left channel
- **1 R** – Soundtrack 1 / Right channel
- **2 Stereo** – Soundtrack 2 / Stereo
- **2 L** – Soundtrack 2 / Left channel
- **2 R** – Soundtrack 2 / Right channel

Note

- When playing a Bilingual recording on a VR mode disc, if you are listening to the Dolby Digital soundtrack via the digital output, you cannot switch the audio channel. Set **Dolby Digital Out** to **Dolby Digital** → **PCM** (see *Dolby Digital Out* on page 104) or listen via the analog outputs if you need to switch the audio channel.

Switching camera angles

DVD-Video

Some DVD-Video discs feature scenes shot from two or more angles—check the disc box for details: it should be marked with a  icon if it contains multi-angle scenes. When a multi-angle scene is playing, the same icon appears on screen to let you know that other angles are available (this can be switched off if you prefer—see *Angle Indicator* on page 111).

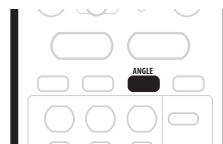

- **To switch the camera angle, press ANGLE.**
- The angle number is displayed on-screen.
- If the disc was paused, playback starts again with the new angle.
- Repeat play is canceled if you change the angle while repeat playback is active.

Note

- You can also change the angle from some DVD-Video disc menus. Press **TOP MENU** to access.

Chapter 6

Recording

About DVD recording

This recorder can record on both DVD-R and DVD-RW media. The main difference between the two is that DVD-R discs can only be recorded once, while DVD-RW can be recorded, erased and re-recorded many times.

A further difference between the two disc types is that only DVD-RW can be initialized for *VR mode* recording, which offers much more comprehensive editing functions compared to *Video mode* recording.

The big advantage, however, of Video mode is its compatibility with standard DVD players, most of which will not play VR mode DVD-RW discs (see also the notes below).

While DVD-R discs can only be recorded using the Video mode, you can initialize a DVD-RW disc for Video or VR mode recordings. Once initialized (any previous content is erased in this operation), all recordings on that disc will be in the chosen recording mode.

Important

- You cannot play, edit or record on unfinalized DVD-R/RW discs recorded in Video mode on other DVD recorders. (Likewise, unfinalized Video mode discs recorded on this recorder are not playable on other players/recorders.)
- This recorder cannot record onto CD-R or CD-RW discs.
- Pioneer takes no responsibility for recording failure due to power cuts, defective discs, or damage to the recorder.
- Fingerprints and small scratches on a disc can affect playback and/or recording performance. Please take proper care of your discs.
- Although this recorder can record PAL, SECAM, NTSC and PAL-60, you can't mix multiple TV line systems on one disc. A disc can contain PAL and SECAM recordings, or NTSC and PAL-60. See also *Input Line System* on page 98.

Note

- Some DVD players, such as some Pioneer models, are compatible with VR mode DVD-RW discs. Check the operating instructions for your player for VR mode compatibility information.

- The maximum number of titles that can be recorded on a DVD-R/RW disc is 99.
- The maximum number of chapters recordable on a DVD-R/RW disc is 999.
- No more recording is possible on a disc that already contains the maximum number of chapters/titles.

About HDD recording

Recording to the internal hard disk drive (HDD) is basically similar to recording to a VR mode DVD-RW disc. You have the full choice of recording quality options, including the manual mode, and of course you can record, erase and re-record as many times as you like.

The capacity of the hard disk drive means that you can store many hours of video on it, even in the higher quality recording modes. To help you organize the contents, the HDD is divided into four groups. You can name and use these groups as you like—for example, you might have a group for movies, another for TV shows, and one for camcorder recordings.

Important

- It is possible to record both PAL and NTSC titles on the HDD. Before recording, you need to make sure that the Input Line System setting (page 98) matches the TV line system of the source you're recording.

Note

- The maximum number of titles that can be recorded on the HDD is 250.
- You can record up to 102 hours of video (in EP mode) on the internal 80GB (gigabyte) hard disk (HDD) on the DVR-420H/ 520H, or up to 204 hours on the 160GB DVR-720H.
- The maximum number of chapters per title recordable on the HDD is 99.
- No more recording is possible on the HDD after the maximum number of titles has been reached.
- The maximum continuous recording time is six hours.

Recording time and picture quality

There are four preset recording quality modes:

- **FINE** – Highest quality setting, gives about one hour of recording time on a DVD disc.
- **SP** (Standard Play) – Default quality, sufficient for most applications, gives about two hours of recording time on a DVD.
- **LP** (Long Play) – Slightly lower video quality, but doubles the recording time on a DVD to around four hours.
- **EP** (Extended Play) – Use when maximum recording time is most important; EP gives you around six hours of recording time on a DVD disc.

In addition to these settings, you can access 32 different recording quality/time settings when manual recording mode is on (see *Manual Recording* on page 107), giving you precise control over the recording.

When setting a timer recording there is a further option, **AUTO**, which maximizes the recording quality for the space available on the disc loaded at the time of recording. (If recording to the HDD, the recording quality is maximized to fit on to a DVD disc.)

In all except the **FINE/MN32** modes, sound is recorded in two channel Dolby Digital format. When set to **FINE/MN32**, sound is recorded in high quality, uncompressed Linear PCM format.

If the broadcast audio is bilingual and you are recording in Video mode or to the HDD, or in VR mode on the **FINE/MN32** setting, use the Bilingual Recording setting (page 104) to select the **A/L** or **B/R** audio channel to record before recording starts.

- Although this recorder can record PAL, SECAM, NTSC and PAL-60, you can't mix multiple TV line systems on one disc. A disc can contain PAL and SECAM recordings, or NTSC and PAL-60. See also *Input Line System* on page 98.



Note

- Note that all recording times (both here and those shown by the recorder) are only approximate. This is because of the way that the video is recorded; you may get slightly more or slightly less, depending on what you're recording.

Restrictions on video recording

- You cannot record copy-protected video using this recorder. Copy-protected video includes DVD-Video discs and some satellite broadcasts. If copy-protected material is encountered during a recording, recording will pause automatically and an error message will be displayed on-screen.
- Video that is 'copy-once only' can only be recorded on the HDD or a DVD-RW disc in VR mode (see below).
- When recording a TV broadcast or through an external input, you can display copy control information on screen. (see *Displaying disc information on-screen* on page 33).

CPRM

CPRM is a copy protection system with scramble system regarding the recording of 'copy once' broadcast programs. CPRM stands for *Content Protection for Recordable Media*.

This recorder is CPRM compatible, which means that you can record copy-once broadcast programs, but you cannot then make a copy of those recordings. CPRM recordings can only be made on CPRM-compatible DVD-RW (ver. 1.1 or higher) discs formatted in VR mode or on the HDD.

DVD CPRM recordings can only be played on players that are specifically compatible with CPRM.

Recording equipment and copyright

Recording equipment should be used only for lawful copying and you are advised to check carefully what is lawful copying in the country in which you are making a copy. Copying of copyright material such as films or music is unlawful unless permitted by a legal exception or consented to by the rightowners.

- This product incorporates copyright protection technology that is protected by method claims of certain U. S. patents and other intellectual property rights owned by Macrovision Corporation and other rights owners. Use of this copyright protection technology must be authorized by Macrovision Corporation, and is intended for home and other limited viewing uses only unless otherwise authorized by Macrovision Corporation. Reverse engineering or disassembly is prohibited.

Setting the picture quality/recording time

VR mode Video mode HDD

Before starting a recording, you will usually want to set the picture quality/recording time. There are four standard settings available, which allow you to choose a balance between picture quality and recording time.

It's also possible to create a fifth, 'manual' setting for picture quality/recording time. Before you can select this, however, you will need to set the **Manual Recording** option in the Initial Settings menu (see *Manual Recording* on page 107).

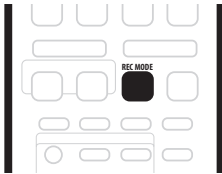

- **Press REC MODE repeatedly to select a recording setting.**
 - **FINE** – Fine picture quality
 - **SP** – Standard play
 - **LP** – Long play
 - **EP** – Extended play
 - **MN** – Manual (available only when manual recording is on)

The setting is indicated in the front panel display, and shown on-screen together with the recording time for a blank recordable disc. If a recordable disc is loaded, the approximate remaining recording time for that disc is also shown. (Note that if the On Screen Display setting (see *On Screen Display* on page 98) is **Off** then this information is not displayed.)

Basic recording from the TV

VR mode Video mode HDD

Follow the instructions below to record a TV program. Recording starts immediately and continues until the disc is full or you stop the recording.

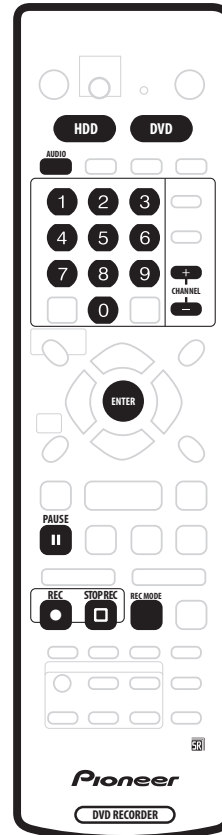

- 1 Press HDD or DVD to record to the hard disk drive or a recordable DVD respectively.**

- If you're recording to DVD, load a recordable disc (if you load a new blank DVD-RW disc, the recorder takes a short while to initialize the disc).

- 2 Use the CHANNEL +/- buttons to select the TV channel to record.**

The front panel display shows the channel number:



- While the recorder is stopped, you can also use the number buttons on the remote to select the channel. (For channel 6, press **6** then **ENTER**; for channel 24, press **2, 4** then **ENTER**)

- If the recorder is stopped, you can also use the +/- buttons on the front panel to select the channel number.

3 Use the REC MODE button to set the picture quality/recording time.

- See *Setting the picture quality/recording time* above for detailed instructions.

4 Use the AUDIO button to select the audio channel to record.

See *Changing audio channels* on page 29 for more on this.

- When recording in VR mode, if a broadcast is bilingual, both audio channels are recorded, allowing you to switch the audio channel on playback. The only exception to this is when the picture quality is set to **FINE/MN32**, in which case you do need to select the audio channel before recording.

5 Press ● REC to start recording.

If you want to set a recording end time, press the ● REC button repeatedly. The recording time increases in 30 minute increments, up to a maximum of six hours. The time the recording will end is shown on-screen and in the front panel display. When the recording ends, the recorder automatically switches into standby if no other operation is being performed.

- To cancel the set recording time, press ● REC.
- If you want to pause recording at any time, press **II PAUSE**. Press again to restart the recording. (If recording to the HDD or in VR mode, a new chapter is started after recording restarts)

6 To stop the recording, press □ STOP REC.

- If you set the recording time in the previous step, you can still stop the recording anytime by pressing □ STOP REC.
- Recording will stop automatically when there is no more space on the HDD/DVD, or after six hours of HDD recording (whichever is sooner).

Tip

- During recording you can turn on/off the SCART loop through function. During recording, press the front panel + button to switch to **SCART THRU** (loop through on), or – to switch to **SCART NORM** (loop through off). Note that you can't switch loop through on if recording from the **AV2/(INPUT 1/DECODER)** or **AV1(RGB)-TV** connectors. Also, loop through is automatically reset to off after recording has finished.

Direct recording from TV

If you connected this recorder to your TV using a SCART cable, and your TV supports Direct Recording, you can record whatever is currently being shown on the TV without having to worry about what channel preset the recorder is on. Check the instructions that came with your TV if you're not sure whether your TV supports this feature.

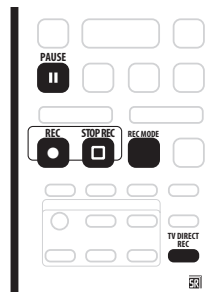

1 If necessary, load a recordable disc.

2 Set the picture quality/recording time using the REC MODE button.

3 Press TV DIRECT REC to start recording.

If you want to set a recording time, press the ● REC button repeatedly. The recording time increases in 30 minute increments, up to a maximum of six hours. You can see the recording time on-screen and in the front panel display. When the recording ends, the recorder automatically switches into standby if no other operation is being performed.

- To cancel the set recording time, press ● REC.
- If you want to pause recording at any time, press **II PAUSE**. Press again to restart the recording. (If recording to the HDD or in VR mode, a new chapter is started after recording restarts)

4 To stop the recording, press □ STOP REC.

- If you set the recording time in step 3, you can still stop the recording anytime by pressing □ STOP REC.
- Recording will stop automatically when there is no more space on the HDD/DVD, or after six hours of HDD recording (whichever is sooner).

Tip

- You can press **TV DIRECT REC** while the recorder is in standby to switch on and immediately start recording.
- Please note that you can't record from another component (VCR, etc.) that is connected by a SCART cable to the **AV2/(INPUT 1/DECODER)** connector using the TV Direct Recording feature.

Setting a timer recording

VR mode Video mode HDD

Using the timer recording features you can program up to 32 timer recordings up to a month in advance. Timer recording programs can be set to record just once, every day, or every week.

You can set the recording quality for your timer recording in the same way as for a regular recording, but with the added option of an **AUTO** mode, which maximizes the recording quality for the space available on the disc (if recording to DVD), or to fit on to a blank DVD disc (if recording to HDD).

You can set timer recordings to record to a recordable DVD or to the hard disk drive. For regular (daily or weekly) HDD timer recordings that you don't need to keep, you can use the Auto Replace Recording feature to automatically replace the previous timer recording with the new one. Note that when you use this feature, the previous recording made on that timer program will be replaced by the next one, regardless of whether you have watched it yet or not.

You can also set the recorder so that it will adjust the recording quality to try and fit the recording on to the disc if it would not otherwise fit at the recording quality you set (see *Optimized Rec* on page 108 for more on this).

Finally, if you set a timer recording to record to DVD but there isn't a recordable DVD loaded at the time of the recording, the Recovery Recording feature will automatically record the program to the HDD for you.

This recorder is compatible with VPS (Video Programming System) and PDC (Program Delivery Control) systems used by many TV stations to ensure that a timer recording catches the whole program even when the program is not running to schedule. Up to eight timer programs can be set with VPS/PDC on.



Important

- A timer recording can't be set if:
 - Auto Start Recording is in progress.
 - There are already 32 timer programs waiting to be recorded.
- Timer recording will not start if:
 - The recorder is already recording.
 - A disc is being initialized, finalized or unfinalized.
- Timer recording will start when the operation preventing timer recording has finished.
- If a recordable DVD that doesn't support simultaneous playback and recording (see *Simultaneous recording and playback* on page 55) is playing when a DVD timer recording is due to start, playback will automatically stop to allow the recording to start.
- The timer indicator (⌚) lights in the front panel display when the timer is active. If the indicator is blinking it means that (for a DVD timer recording) there is no disc loaded, or the disc loaded is not recordable (for an HDD timer recording it means that the HDD is not recordable).
- Timer recordings have higher priority than the Auto Start Recording function (see *Automatic recording from a satellite tuner* on page 56). A timer recording will interrupt an Auto Start Recording. (Auto Start Recording will resume after the timer recording has finished.)
- Approximately two minutes before a timer recording is set to start, the recorder will go into timer recording standby. In timer recording standby you cannot use some functions.
- The maximum length for timer recordings made to the HDD is 24 hours. However, because one title is limited to six hours, recordings over six hours will be spread over two or more titles. Note that there will be a break in the recording of a few seconds between titles.
- VPS/PDC may not work with all broadcast stations in your country/area. Check with the stations for compatibility.

Easy Timer Recording

As the name suggests, Easy Timer Recording makes setting up a timer recording as simple as possible.

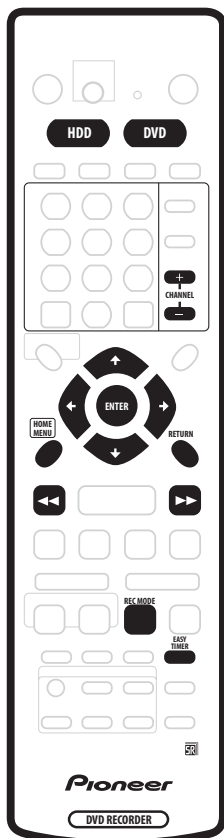

1 Press EASY TIMER.

Alternatively, you can also access from the Home Menu (press **HOME MENU** and select **Timer Recording** then **Easy Timer Recording**).

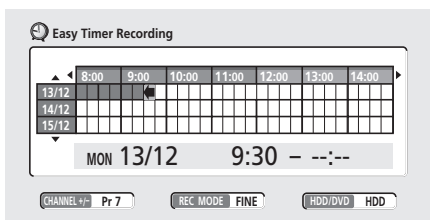

2 Set the TV channel and recording quality.

- Use the **CHANNEL +/-** buttons to set the channel you want to record.
- Use the **REC MODE** button to set the recording quality. Press repeatedly to switch between **FINE**, **SP**, **LP**, **EP** and **AUTO** (and **MN** if manual recording mode is on).

- DVD recording:** The **AUTO** option automatically sets the best recording quality for the space available on the disc loaded at the time of recording.
- HDD recording:** The **AUTO** option automatically sets the best recording quality that would fit on to a blank DVD disc.
- Press **DVD** to record to DVD disc, or **HDD** if you want to record to the hard disk drive.

3 Use ↑/↓/←/→ (cursor buttons) to move the cursor to the recording start date and time on the grid.

- You can move the cursor forward or back an hour at a time using the ◀◀ and ▶▶ buttons.

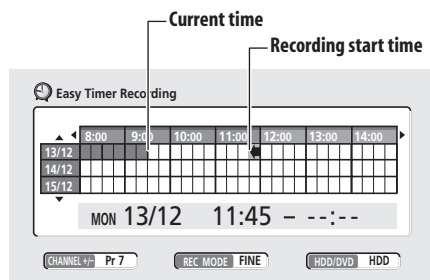

Each row of the grid is one day (you can set the timer recording for up to a month in advance). Each column is a 15 minute interval.

The darker area represents time that has already passed and can't therefore be selected. The lighter area is time that's available.

4 Press ENTER to set the start time.

The start date and time is displayed in the middle of the screen.

- You can go back and reset the start time if you need to by pressing **RETURN**.

5 Use the ←/→ (cursor left/right) to move the cursor to the recording end time on the grid.

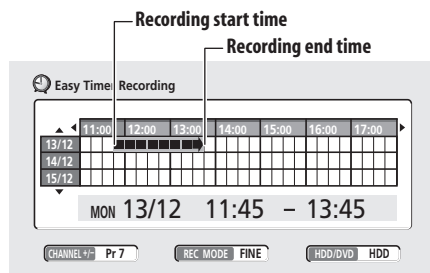

As you move the cursor around the grid, an arrow stretches from the start time to the current cursor position, representing the length of the recording. A recording of up to six hours can be set.

VPS/PDC on.

Note that VPS/PDC may not work with every station and that Optimized Recording will not work if VPS/PDC is on.

- **Ttl Name Input** – Optionally, you can enter a name for the recording up to 32 characters. (Highlight **Program Set** then press ↓ (cursor down) to access this option.)

4 After entering all the timer recording information, highlight 'Program set' and press ENTER.

The timer recording list screen is displayed again. The timer program you just input appears in the list. The rightmost column shows various timer recording status messages:

- **Standby** is displayed when the recorder is in timer recording standby.
- **Recording** is displayed when a timer recording is in progress.

5 To exit the timer recording screen, press HOME MENU.

Note

- For a DVD timer recording, if **Optimized Rec** (see *Optimized Rec* on page 108) is set to **On** (and VPS/PDC is off), the recorder will adjust the recording quality to try and fit the recording on the disc. If the recording will not fit onto the disc even on MN1 recording quality then the Recovery Recording feature will automatically make the recording to the HDD instead.
- If there is very little free space left on the HDD, an Auto Replace Recording may not complete successfully.
- If the HDD is being used for playback or high-speed copying when an Auto Replace Recording is due to start, the new timer recording will not replace the old one. However, the next time the timer recording starts, both of the older two programs will be erased.
- If you set the timer recording to use VPS/PDC, you must switch the recorder into standby before the timer recording is due to start for it to work correctly. For non-VPS/PDC timer recordings there is no need to switch the recorder into standby.

Tip

- Stations that use VPS/PDC typically include VPS/PDC information in the teletext TV guide pages. Please refer to these when setting your timer recording.

Timer recording using the VIDEO Plus+® programming system

This system makes programming timer recordings very simple. Most TV guides publish PlusCode programming numbers with their program details. If you want to make a timer recording of a program, you just input the corresponding code. The date, start, stop and channel settings are made automatically. All you have to do is tell the recorder the recording mode, and whether it's a once-only recording or a regular recording.

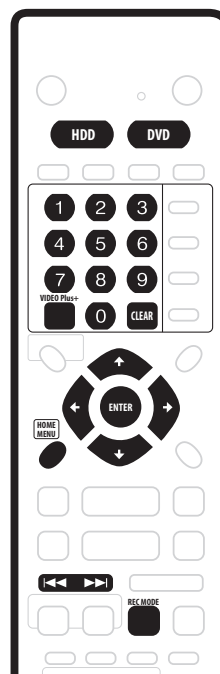

1 Press 'VIDEO Plus+' to display the VIDEO Plus+ program screen.

You can also access this screen from the Home Menu (press **HOME MENU**, select **Timer Recording**, then **VIDEO Plus+**).

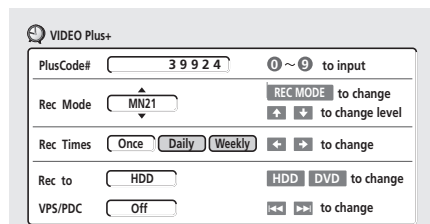

- Use the number buttons to enter the PlusCode programming number. (To clear the last digit entered, press **CLEAR**.)

- Press **REC MODE** to select **FINE**, **SP**, **LP**, **EP** or **AUTO** (See *Recording time and picture quality* on page 46). If Manual Recording is on, then you can also select the **MN** setting.
- Use the **←/→** (cursor left/right) buttons to select the **Once**, **Daily** or **Weekly** recording option.
- Press **HDD** to record to the hard disk drive, or **DVD** to record to a DVD.
- Use the **◀◀** and **▶▶** buttons to switch VPS/PDC **On** or **Off**.

2 After making the settings, press ENTER.

The program details are shown at the bottom of the screen for a few seconds then the screen is automatically exited.

- If you haven't set up the guide channels (or at least the guide channel for the PlusCode programming number that you entered), the recorder will prompt you to enter the channel number that the TV program is showing on.



Tip

- You can check the timer program settings by pressing **TIMER REC** to display the timer recording screen.

VIDEO Plus+ programming with the power off

You can enter a PlusCode programming number when the recorder is in standby. Note that the recording is always made to the HDD. If you want to record to a DVD disc, you'll need to switch on the power and use the full VIDEO Plus+ program screen.

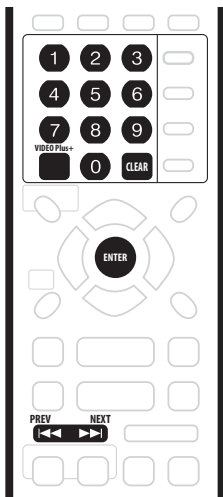

Important

- You can't use this feature until you have set up the guide channels. See *Set VIDEO Plus+ CH* on page 101.
- You can't change the recording mode.
- You can't program daily or weekly timer recordings.

1 Press 'VIDEO Plus+'.

The front panel display shows the current recording mode and prompts you to enter the PlusCode programming number.

PLUS CODE

2 Use the number buttons to enter the PlusCode programming number.

2 9 3 2 4

- To clear the last digit entered, press **CLEAR**.
- Use the **PREV ◀◀** / **NEXT ▶▶** button to switch VPS/PDC on/off. With VPS/PDC on, the front panel VPS/PDC indicator lights. (Note that a maximum of 8 timer recordings can be set with VPS/PDC on.)

3 Press ENTER.

The display shows the timer settings:

Date → Start time → End time → HDD and Recording channel.

- If **CODE ERROR** appears in the display, check that the PlusCode programming number is correct and that the guide channel is set (see *Set VIDEO Plus+ CH* on page 101), then set the timer recording again.
- If **CAN'T SET** appears in the display, it means that although you entered a valid PlusCode programming number, the program has already finished.

Extending a timer recording in progress

You can extend a timer recording beyond the programmed end time in two different ways. This can be useful if a broadcast program overruns, for example.

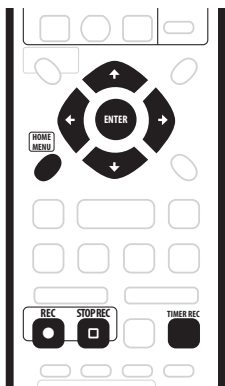

Moving the end time by 30-minute blocks

1 During timer recording, press and hold ● REC for three seconds.

The timer indicator disappears from the front panel display.

2 Press ● REC repeatedly to extend recording in 30 minute increments.

Programming a new end time

Note that it is only possible to program a new end time for a timer recording when VPS/PDC is off.

1 During timer recording, press TIMER REC to display the Timer Recording screen.

You can also access the Timer Recording screen from the Home Menu (press HOME MENU, select Timer Recording, then Timer Recording (View)).

Date	Start	Stop	CH	Mode	Rec to	VPS/PDC
12/13 MON	7:00	8:00	Pr 3	FINE	HDD	Recording
EVERY TUE	9:00	10:00	Pr 5	FINE	HDD	On
New Input						

HDD Remain --h--m(FINE) 1/1
 DVD Remain 0h43m(FINE)

2 Use the ↑ (cursor up) button to highlight the current timer recording ('Recording' is shown in the 'VPS/PDC' column), then press ENTER.

A screen showing details of the timer recording appears. From this screen, only the recording stop time can be changed.

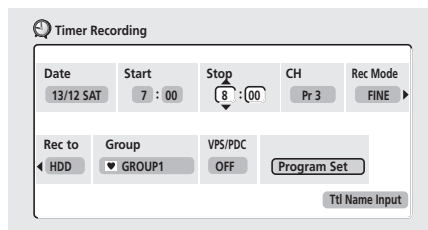

3 Set a new Stop time for the timer recording.

Use the ←/→ (cursor left/right) buttons to select the hour or minute field, then use the ↑/↓ (cursor up/down) buttons to change the time.

4 Press ENTER to set the new time and exit the screen.

Recording will continue until the new stop time is reached.

Canceling and stopping a timer recording in progress

After a timer recording has started, you can cancel the program (but continue recording), or stop recording completely if you need to.

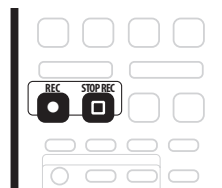

1 During timer recording, press and hold ● REC for three seconds.

Only the program is canceled (the timer indicator disappears); recording continues so that you can manually stop recording whenever you like.

2 When you want to stop recording completely, press □ STOP REC.

Preventing use of the recorder before a timer recording (child lock)

You can make all the front panel and remote control buttons inoperative using the child lock feature. This is useful when you set a timer recording and want to make sure that the timer settings are not changed before recording has finished.

1 If the recorder is on, switch it into standby.

2 Press and hold ■ STOP on the front panel for three seconds to lock the controls.

The front panel display briefly shows **LOCK**. If any buttons are pressed on the remote or front panel, **LOCK** is briefly displayed again.

- To unlock the recorder, press and hold ■ **STOP** on the front panel for three seconds until the display shows **UNLOCK**.
- To cancel a timer recording when the recorder is locked, first unlock the recorder (see above), then press and hold ● **REC** for three seconds.

Timer recording FAQ



Frequently Asked Questions

- *Even though the timer is set, the recorder doesn't start recording!*

Check that the disc loaded or HDD is recordable, not locked (see *Lock Disc* on page 92), and that there are fewer than 99/250 titles already on the DVD/HDD.

- *The recorder won't let me enter a timer program! Why not?*
You can't enter a timer program if the clock isn't set.

- *What happens when two or more timer programs overlap?*

Basically, the program with the earlier recording start time has priority. However, the recorder will start recording the program with the later start time after the earlier program is finished. If two programs have the same times (but different channels, for example), the program set most recently takes priority.

If VPS/PDC is active for two timer programs that are programmed to start at the same time, then the program that actually starts first takes priority.

Simultaneous recording and playback

VR mode

HDD

A feature called Chase Play makes it possible to watch a recording in progress (DVD or HDD) from the start of the recording (as in, playback is 'chasing' the recording). For example, perhaps you have to miss the first 30 minutes of a movie on TV; you can start recording, then start watching the movie, from the beginning, while the recorder is still recording 30 minutes ahead of you.

In fact, you're not just limited to watching the recording in progress; you can watch anything else already on the DVD or HDD by selecting it from the Disc Navigator screen (see *Using the Disc Navigator with recordable discs and the HDD* on page 37).



Important

- Note that you must use a DVD-RW Ver. 1.1 / 2x or Ver. 1.2 / 4x disc to be able to use this feature.
- You may not be able to use this feature with a DVD-RW disc that was first initialized on another recorder.
- **During recording, press ► PLAY to start playback from the beginning of the current recording, or press DISC NAVIGATOR and select another title to play from there.**

You can use all the usual playback controls, such as pause, slow-motion play, scan and skip.

- To stop playback, press ■ **STOP** (recording will continue).
- To stop recording, press □ **STOP REC** (playback will continue).



Note

- You can't start playback immediately after recording starts.
- When scanning a DVD, no sound is output if the recorder is also recording the DVD (see *Scanning discs* on page 38).
- You can't use this feature during Auto Start Recording, or in Auto Start Recording standby (the **AUTO** indicator is lit in the front panel display).
- You can't use simultaneous playback and recording while copying or backing up.
- During recording or in timer recording standby, you can't play an HDD title, DVD or Video CD/Super VCD disc if the Input Line System setting doesn't match the TV line system of the disc/HDD title (see also

Input Line System on page 98). Also, during simultaneous recording and playback, if the TV line system of the playback track/title changes then playback will automatically stop.

Recording from an external component

VR mode Video mode HDD

You can record from an external component, such as a camcorder or VCR, connected to one of the recorder's external inputs.

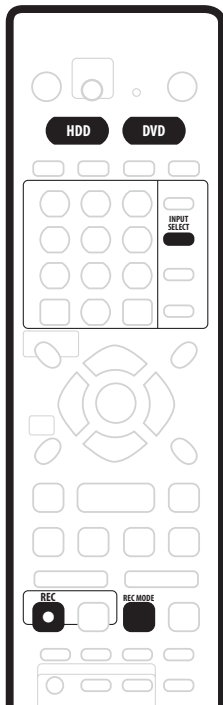

1 Make sure that the component you want to record from is connected properly to the DVD recorder.

See Chapter 2 (*Connecting up*) for connection options.

2 Press INPUT SELECT repeatedly to select one of the external inputs to record from.

There are two analog inputs and a DV digital input (DVR-520H/720H only). The current input is shown on-screen and in the front panel display:

- **AV2/L1** – Input 1/Auto Start Rec
- **L2** – Input 2 (front panel)
- **DV** – DV input/output (front panel) (DVR-520H/720H only)

Check that the **Audio In** settings for **External Audio**, **Bilingual Recording** and **DV Input** are as you want them (see *Audio In settings* on page 103).

- If the aspect ratio is distorted (squashed or stretched), adjust on the source component or your TV before recording.

3 Set up the recorder.

- Use **REC MODE** to set the recording quality. See *Setting the picture quality/recording time* on page 47 for detailed information.
- Press **HDD** to record to the hard disk drive, or **DVD** to record to a DVD.

4 Press ● REC when you're ready to start recording.

- DVR-520H/720H only: The recorder will only start recording from the **DV IN/OUT** jack if there is a valid signal. Recording will also pause if the signal is interrupted during recording.

Note

- If your source is copy-protected using CopyGuard, you will not be able to record it. See *Restrictions on video recording* on page 46 for more details.

Automatic recording from a satellite tuner

HDD

If you have a satellite tuner or some other kind of set top box connected to the **AV2/L1** input, you can have the recorder start and stop recording automatically with the timer settings of the connected component. (If the other component doesn't have a built-in timer, you'll need to use it with an external timer unit.)

After setting up for Auto Start Recording, this recorder starts recording when it detects a signal from the other component. When the signal ceases, the recorder stops recording.

Important

- It takes a little while for this recorder to switch on and start recording after detecting a signal. Please bear this in mind when setting the timer.
- If Auto Start Recording is set, it will not start if another timer recording is in progress.
- Timer recordings take precedence over Auto Start Recording. Auto Start Recording will stop if a timer recording is due to start. After the timer recording has finished, Auto Start Recording will resume.

1 Set the timer for the satellite receiver (or other component), then switch it into standby (if necessary).

Check the manual that came with the receiver if you're not sure how to do this.

2 Check that the 'Audio In' settings for 'External Audio' and 'Bilingual Recording' are as you want them.

See *Audio In settings* on page 103 for more on these settings.

3 Set up the recorder.

- Use **REC MODE** to set the recording quality. See *Setting the picture quality/recording time* on page 47 for detailed information.

4 Press HOME MENU and select 'Timer Recording', then 'Auto Start Recording'.

5 Select 'Yes' to switch Auto Start Recording on, or 'No' to switch off.

6 Switch the recorder into standby.

The **AUTO** indicator in the front panel display lights.

The recorder will automatically switch on and start recording when the other component comes on.

Recording stops when the external component switches off.

- To cancel Auto Start Recording, press **STANDBY/ON** while the recorder is in standby. The **AUTO** indicator goes off.
- To cancel Auto Start Recording once recording has already started, press **REC** for three seconds, then **STOP REC**.
- When a timer recording is in progress ahead of Auto Start Recording, some functions, such as extending the timer recording and chase play, are not available. Press the front panel **+** button for three seconds to cancel Auto Start Recording without affecting the timer recording. The **AUTO** indicator goes off.



Note

- Auto Start Recordings are always on the HDD. Auto Start Recording to DVD is not possible.
- You can't set Auto Start Recording when:
 - the recorder is recording or in timer recording standby.
 - the HDD is not recordable.
 - the HDD already contains the maximum number of titles (250).
 - **AV2/L1 In** is set to **Decoder** (see *AV2/L1 In* on page 102).

Recording from a DV camcorder (DVR-520H/720H only)

VR mode Video mode HDD

You can record from a DV camcorder connected to the **DV IN/OUT** jack on the front panel of this recorder. Using the recorder's remote, you can control both the camcorder and this recorder.

Before recording, make sure that the audio input for the **DV IN/OUT** jack is setup (see *DV Input (DVR-520H/720H only)* on page 104).

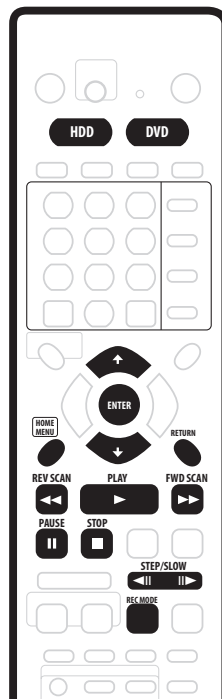

Important

- The source signal must be DVC-SD format
- Some camcorders cannot be controlled using this recorder's remote.
- If you connect a second recorder using a DV cable, you cannot control the second unit from this one.
- You can't control this unit remotely from a component connected to the **DV IN/OUT** jack.
- You can't record date and time information from DV cassette.

- During DV recording, if a part of the tape is blank, or has copy-protected material on it, this recorder will pause recording. Recording will restart automatically when there is a recordable signal. However, if there is more than 10 seconds of blank tape, the recorder will stop recording and the camcorder should stop (depending on the camcorder).
- For best results when recording from a DV camcorder to this recorder, we recommend cueing the camcorder to the place you want to start recording from and setting the camcorder to play-pause.

1 Make sure your digital camcorder is connected to the front panel DV IN/OUT jack.

Also, set the camcorder to VTR mode.

2 Set up the recorder.

- Use **REC MODE** to set the recording quality. See *Setting the picture quality/recording time* on page 47 for detailed information.
- Make sure a recordable disc is loaded if you want to record to DVD.

3 From the Initial Settings menu, check that the DV audio input is setup as you require.

See *DV Input (DVR-520H/720H only)* on page 104 for more on this.

- Check also that the **Audio In** settings for **External Audio** and **Bilingual Recording** are as you want them (see *Audio In settings* on page 103).

4 Press HOME MENU and select 'DV Record' from the menu.

- DV recording only works when the digital camcorder is in VTR mode with a tape loaded.

5 Select 'Record to HDD' or 'Record to DVD' to record to the hard disk drive or a recordable DVD respectively.

6 Find the place on the camcorder tape that you want to start recording from.

For best results, pause playback at the point from which you want to record.

- Depending on your camcorder, you can use this recorder's remote to control the camcorder using the **■**, **▶**, **⏸**, **◀◀**, **▶▶**, **◀||** and **||▶** buttons.

7 Use the **↑/↓** (cursor up/down) buttons to select 'Start Rec' and press ENTER.

- Recording is automatically paused if the recorder detects no signal, or a copy-protected signal. Recording restarts when there is a non-copy-protected signal.
- You can pause or stop the recording by selecting **Pause Rec** or **Stop Rec** from the on-screen display. You cannot control the camcorder from this remote control during recording.
- If you restart recording after stopping the camcorder, the first few seconds of the camcorder tape will not be recorded. Use the pause button on your camcorder instead and recording will start immediately.
- *HDD and DVD-RW (VR Mode) only:* A chapter marker is inserted every time there is a break in the timecode on the DV tape. This happens when the recording is stopped or paused then restarted, for example.
- While recording, you cannot exit the DV recording screen using the **HOME MENU** or **RETURN** button.



Note

- Depending on the connected camcorder, you may not be able to control it using the remote control supplied with this recorder.
- If the audio subcode on the DV tape cannot be read correctly, the audio type will not switch automatically. You can switch the audio manually from the **External Audio** setting (page 103).
- See also *DV-related messages* on page 117 if you encounter an error while using the **DV IN/OUT** jack.



Frequently Asked Questions

- *I can't get my DV camcorder to work with the recorder!*
Check that the DV cable is properly connected. Also make sure that what you're trying to record is not copy-protected.
If it still doesn't work, try switching off the camcorder then switch back on.
- *There's a picture, but no sound!*
Try switching the **DV Input** setting (see *DV Input (DVR-520H/720H only)* on page 104) between **Stereo 1** and **Stereo 2**.



Recording from the DV output (DVR-520H/720H only)

VR mode Video mode HDD

You can record non-copy-protected material from the hard disk drive or from a DVD to a camcorder connected to the **DV IN/OUT** jack.

- 1 Connect the camcorder to the DV IN/OUT jack of this recorder.
- 2 Select the HDD or DVD for playback.
- 3 Find the place you want to start recording from.
- 4 Start recording on the camcorder.
- 5 Play the source material.

Playing your recordings on other DVD players

VR mode Video mode

Most regular DVD players can play finalized discs recorded in Video mode. A number of players (including many Pioneer models) can also play DVD-RW discs recorded in VR mode, finalized or not. Check the manual that came with the player to check what kinds of discs it will play.

When you finalize a Video mode disc, a title menu is created from which you can select titles when you play the disc. There are a number of different styles of title menu to choose from to suit the content of the disc.

All the title menus are navigated in the usual way, pressing **MENU** or **TOP MENU** to display the menu, then using the **↑/↓/←/→** (cursor buttons) followed by **ENTER** to select titles and start playback.

Finalizing a disc

VR mode Video mode

Finalizing 'fixes' the recordings in place so that the disc can be played on a regular DVD player or computer equipped with a suitable DVD-ROM drive.

Note that the disc name will appear in the title menu after you finalize a disc. Make sure the disc name is as you want it before you finalize the disc as it can't be changed afterwards. If you want to rename the disc, see *Input Disc Name* on page 92 before starting the steps below.

Important

- Once you've finalized a disc recorded in Video mode, you can't edit or record anything else on that disc. However, the finalization on a DVD-RW disc maybe 'undone'; see *Undo Finalize* on page 93 for how to do this.
- A VR mode disc can still be recorded and edited on this recorder even after finalizing.

- 1 Load the disc you want to finalize.
Make sure that the recorder is stopped before proceeding.
- 2 Press **HOME MENU** and select 'Disc Setup'.
- 3 Select 'Finalize'.

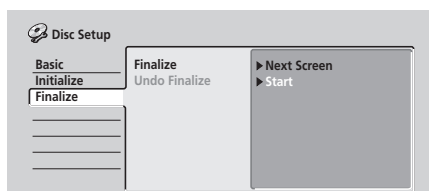

- 4 Select 'Finalize' from the finalize options, then 'Next Screen'.

- 5 For Video mode discs only, select a title menu style, then select 'Yes' to start finalization or 'No' to cancel.

The menu you select will be the one that appears when the 'top menu' is selected on any DVD player.

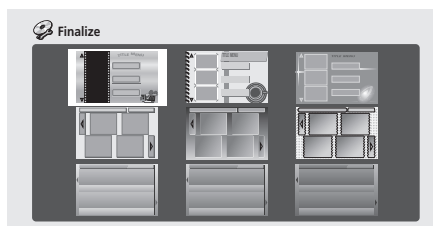

- Discs recorded partially or fully on the Pioneer DVR-7000 DVD recorder do not support this feature. These discs will have only a text title menu when finalized on this recorder.

- 6 The recorder will now start finalizing the disc.
During finalization:

- If the finalization process is going to take more than around four minutes, you can press **ENTER** to cancel. Around four minutes before completion, the option to cancel disappears.

- How long finalization takes depends on the type of disc, how much is recorded on the disc and the number of titles on the disc. A disc recorded in VR mode can take up to one hour to finalize. A disc recorded in Video mode can take up to 20 minutes.

Note

- If the TV line system of the disc is different to the current setting of the recorder, you will not be able to finalize the disc. See *Input Line System* on page 98 for how to change the recorder's setting.

Note

- By default, the recorder initializes blank DVD-RW discs for VR mode recording. See *DVD-RW Auto Init.* on page 108 if you want to change the default to Video mode.
- If a disc was previously finalized on an older DVD recorder, you may not be able to re-initialize and/or initialize it for Video mode recording.

Initializing a DVD-RW disc

DVD-RW

When you first load a blank disc, the recorder will initialize it automatically for recording. You can also manually initialize DVD-RW discs.

You can initialize a disc for either Video mode recording or VR mode recording.

Important

- Initializing a disc will erase everything recorded on it. Make sure there is nothing on the disc that you want to keep!
- You may not be able to re-initialize a disc in a different format if it was originally initialized on an older DVD recorder.

1 Press HOME MENU and select 'Disc Setup'.

2 Select 'Initialize'.

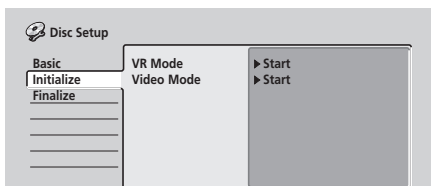

3 Select 'Video Mode' or 'VR Mode' from the initialize options.

4 Select 'Start'.

It takes about 30 seconds to initialize the disc.

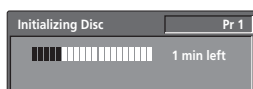

Chapter 7

Copying and back-up

Introduction

Use the copying features of this recorder to:

- Back up important recordings stored on the HDD to a DVD
- Make a DVD copy of a recording on the HDD to play in another player.
- Transfer video from a DVD to the HDD for editing.
- Transfer edited video from the HDD to DVD.

The simplest method of copying is to use the One Touch Copy feature. Using this you can simply copy the title that's currently playing from HDD to DVD, or the other way around.

For more complicated copying tasks you can make a Copy List which specifies precisely what needs to be copied. A Copy List is similar to a VR mode Play List in many ways, and you'll find that the Copy List commands are similar to those available for editing a Play List.

A message showing that copying has finished is displayed after copying. If the recorder is inactive and no button is pressed (remote or front panel) then the recorder will automatically go into standby after 20 minutes.

High-speed copying

Copying between DVD and HDD is a completely digital process and therefore involves no loss of quality in the audio or video. This means that you can transfer back and forth without having to worry about the quality getting worse with each copy 'generation'. It also means

that copying can be carried out at the maximum speed possible.

When copying from HDD to DVD, the speed of copying depends on the recording mode and the kind of DVD disc you're using. The table at the bottom of the page shows the minimum copying time for one hour of material.

 **Note**

- Not all discs are compatible with high-speed copying. Check with the disc manufacturer for compatibility.
- There may be cases where even 2x/4x/8x compatible discs do not copy at full speed.
- High-speed copying is not possible when using discs initialized on another recorder.
- The table below shows disc brands that have been tested for 8x speed writing compatibility with this recorder.

Maker

Sony
That's
JVC
Fujifilm
TDK
Maxell
Verbatim
Ritek

(As of April, 2004)

Rec mode	DVD disc type			
	DVD-RW Ver. 1.1*1	DVD-R Ver. 2.0 DVD-RW Ver. 1.1/2x*2	DVD-R Ver. 2.0/4x*3 DVD-RW Ver. 1.2/4x*3	DVD-R Ver. 2.0/8x*4
EP	10 mins.	5 mins.	2.5 mins.	1.25 mins.
LP	15 mins.	7.5 mins.	4 mins.	2 mins.
SP	30 mins.	15 mins.	7.5 mins.	4 mins.
FINE	60 mins.	30 mins.	15 mins.	8 mins.

Note that all times in the above table are approximate.

*1 Compatible with single speed recording only

*2 Compatible with 2x speed recording

*3 Compatible with 4x speed recording

*4 Compatible with 8x speed recording. Note that actual copy speed varies with the part of the disc being recorded.

Real-time copying

Real-time copying is also possible, with the advantage that you can manually set a different recording mode from the original. For example, you can record a title originally recorded in **FINE** mode in **SP** mode.

When real-time copying from the HDD to a Video mode DVD, the chapter markers in the original material are not copied. Chapter markers are put into the copy at intervals, according to the Auto Chapter (Video) setting (see also *Auto Chapter (Video)* on page 108).

Frame accuracy and copying

The Frame Accurate setting (see *Frame Accurate* on page 108) does not affect the actual video content on the HDD, but it does affect what can be copied and whether high-speed copying can be used.

When Frame Accurate is set to **Off**, high-speed copying can generally be used to copy titles in the Copy List using a DVD-R or DVD-RW disc in VR or Video mode. However, copy-once protected material (see *Restrictions on copying* below) can't be added to the Copy List, and the divide points in edited titles may be out by as much as 0.5 seconds when compared to the original.

When Frame Accurate is **On**, you can add copy-once protected titles to the Copy List and divide points in edited titles are maintained accurately. However, depending on the content of the Copy List and the disc, it may not be possible to use high-speed copying.

Restrictions on copying

Some video material is copy-once protected. This means that it can be recorded to HDD, but it can't then be freely copied again. If you want to transfer copy-once protected material from HDD to DVD, you'll need to use a VR mode DVD-RW disc compatible with CPRM Ver. 1.1 or higher (see *CPRM on page 46* for more on this). Only one instance of a copy-once protected title can be added to the Copy List, and after it's been copied, the title is erased from the HDD (it is therefore not possible to copy a locked title that is copy-once protected).

You can identify copy-once protected material during playback by displaying disc information on-screen. If the current title is copy-once protected, an exclamation mark (!) is shown (see *Play display 2* on page 35).

Copyright

Recording equipment should be used only for lawful copying and you are advised to check carefully what is lawful copying in the country in which you are making a copy. Copying of copyright material such as films or music is unlawful unless permitted by a legal exception or consented to by the rightowners.

One Touch Copy* (HDD to DVD)

The One Touch Copy feature copies the currently playing title (or currently selected title in the Disc Navigator) from the HDD to DVD. The whole title is copied, regardless of where in the title you start copying. The recorder copies at the maximum speed possible.

For One Touch Copy to work, make sure that a recordable DVD-R/RW disc is loaded.

* See also *Copyright* above.

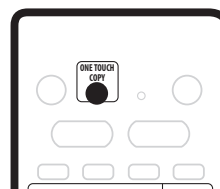

- **During HDD playback, press ONE TOUCH COPY to copy the current title to DVD.**

The front panel display indicates that the title is being copied. Playback continues while copying.

Note

- Title name, chapter markers, as well as thumbnail picture markers (Navimark) for the Disc Navigator, are also copied. However, if you copy to a Video mode DVD-R/RW, only the first 32 characters of a name are copied.
- The chapter markers in the copy may not be in exactly the same positions as the original when recording on to a Video mode disc.
- You can't use the One Touch Copy function to copy a title if any part of the title is copy-once protected.
- A title that contains mixed aspect ratios can't be copied to a Video mode disc. Use a VR mode DVD-RW disc for this type of material.
- Low resolution (**EP** or **LP**, or **MN1-18**) widescreen material can't be copied to a Video mode disc. Use a VR mode DVD-RW disc for this type of material.

One Touch Copy* (DVD to HDD)

One Touch Copy from DVD to HDD copies a single title to the HDD in real time. You can copy the currently playing title or the currently selected title in the Disc Navigator. When you start copying, playback jumps back to the start of the title, then continues through to the end of the title, when recording automatically stops. The copy will be made in the recording mode (**FINE**, **SP**, etc.) that is currently set.

* See also *Copyright* above.

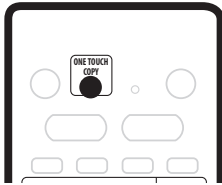

- During DVD playback, press **ONE TOUCH COPY** to copy the current title to HDD.

Playback starts again from the beginning of the current title. The front panel display and an on-screen display indicate that the title is being copied.

Note

- The maximum title length for copying is six hours.
- Title name and chapter markers are also copied, except when copying from a finalized Video mode disc.

- Thumbnail picture markers (Navimark) and chapter markers for the Disc Navigator are copied, but their position in the copy may be slightly changed from the original.
- If some part of the title being copied is copy-protected, copying will start, but the copy-protected portions will not be copied.

Canceling One Touch Copy

You can cancel a One Touch Copy once it's started.

- **Press and hold ONE TOUCH COPY for more than a second.**

Copying is canceled and the video already copied is erased.

Note

- If you cancel a HDD to DVD-R copy, the space available for recording does not return to the pre-copy figure.

Copying from HDD to DVD*

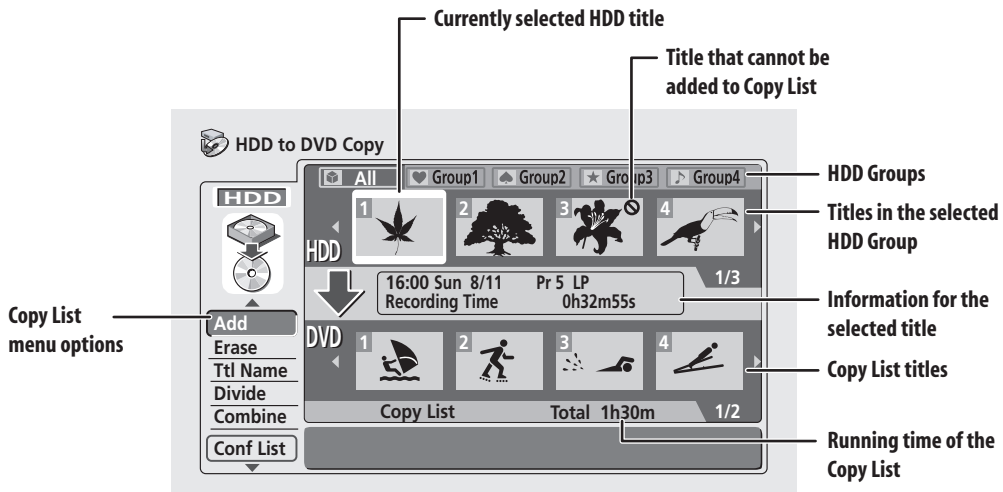

From the HDD to DVD Copy screen you can build up a Copy List of titles to copy to DVD. From this screen you can also edit chapters so that the titles appear as you want them on your finished DVD.

* See also *Copyright* on page 62.

Important

- The recorder can only store one Copy List at a time.
- The Copy List is erased if the Frame Accurate setting is changed in the Initial Settings menu (see *Frame Accurate* on page 108), or if the Input Line System setting is changed (see *Input Line System* on page 98).

- Resetting the recorder to its factory settings (see *Resetting the recorder* on page 112) will also erase the Copy List.

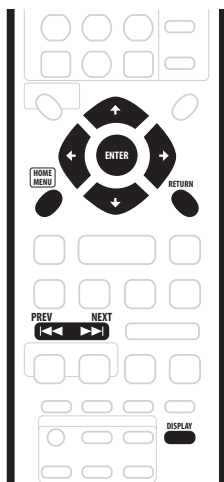

- 1 Make sure that there's a recordable DVD disc loaded.
- 2 Press HOME MENU and select 'Copy'.



DVR-520H/720H screen

- 3 Select 'HDD → DVD'.
The HDD to DVD Copy List screen appears.

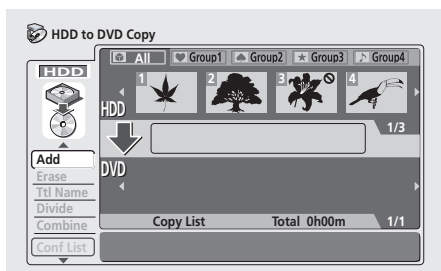

- Use the **↑/↓** (cursor up/down) buttons to highlight the command you want from the menu options on the left, then press **ENTER**. Most commands require you then to select a title (or chapter) or location from the thumbnail views area of the screen. Use the **←/→** (cursor left/right) followed by **ENTER** to do this.

- When in the thumbnails area of the screen, use the **PREV** (**←**) and **NEXT** (**→**) buttons to display the previous/next page if there are more titles/chapters than will fit on the screen.
- As you highlight different thumbnails, information about the title/chapter is shown in the central area of the screen. Press **DISPLAY** to change the information displayed.
- Press **RETURN** to get back to the menu options on the left from the thumbnail area of the Copy List screen.
- When selecting HDD titles, you can display titles from a particular HDD group by pressing **↑** (cursor up), then using the **←/→** (cursor left/right) buttons and **ENTER** to select a group. Press **↓** (cursor down) to get back to the HDD title thumbnail area.

DVD Copy



HDD to DVD Copy List menu options

Use the following commands when making an HDD to DVD Copy List:

- Add** – Add titles from the HDD to the Copy List (see page 65).
- Erase** – Erase individual titles from the Copy List (see page 66).
- Title Name (Ttl Name)** – Name or rename a title in the Copy List (see page 66).
- Divide** – Divide a title in the Copy List into two (see page 66).
- Combine** – Combine two adjacent titles in the Copy List into one (see page 67).
- Preview** – Check the content of a title in the Copy List (see page 67).
- Move** – Change the order of titles in the Copy List (see page 67).
- Erase All** – Erase the Copy List (see page 68).
- Chapter Edit (Chpt Edit)** – Edit chapters within a Copy List title (see page 68):
 - Erase** – Erase a chapter.
 - Divide** – Divide a chapter into two.
 - Combine** – Combine two chapters into one.
 - Move** – Change the chapter order.
 - Preview** – Check the chapter content.
- Erase Section (Erase Sec)** – Erase a section of a title in the Copy List (see page 70).
- Confirm List (Conf List)** – Confirm the Copy List and go to the recording settings screen (see *Recording the Copy List* below).

Recording the Copy List

After putting together your Copy List, you're ready to record it.

- 1 Select 'Conf List' to display the Copy List settings screen.
- 2 Use the ←/→ (cursor left/right) buttons to select the Recording Mode.

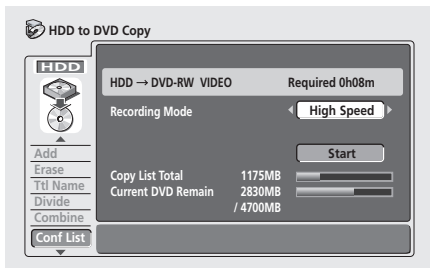

- **High-Speed Copy** – The Copy List is copied at the same recording quality as the original. (See page 61 for more information on high-speed copying.)
- **FINE, SP, LP, EP, MN** – The Copy List is copied at the specified recording quality in real-time. (Note that if you copy at a higher quality setting than the original, the copy will not be better quality than the original.)
- If you select **MN** above, you can also change the level setting (**MN1–MN32**) from the Recording Quality box that appears.
- **Optimized** – The recording quality automatically adjusted so that the Copy List fits on to the space available on the disc. Copying is carried out in real-time.

When you change the recording mode setting, you can see how much disc space it will require. If this is more than is available, it shows up in red and you won't be able to start copying. In this case, either change the recording quality, or press **RETURN** to go back to the Copy List screen and erase one or more titles from the Copy List.

- 3 Select 'Start' to begin copying.

Note

- When the copy mode is set to something other than High-Speed Copy for copying to a Video mode DVD, the chapter markers of the original are not copied. Chapter markers are put into the copy at regular intervals, according to the Auto Chapter setting (see also *Auto Chapter (Video)* on page 108).

HDD to DVD Copy List commands

Add

Use this command to add titles to the Copy List.

- 1 Select 'Add' from the Copy List menu options.
- 2 Use the ←/→ (cursor left/right) buttons to select a title from the HDD to add to the Copy List, then press **ENTER**.

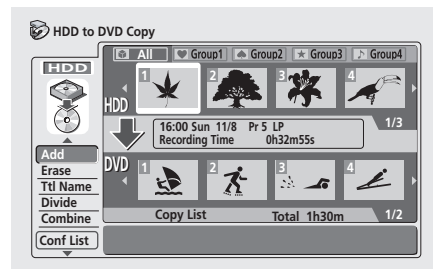

The thumbnail appears in the Copy List section in the lower half of the screen. If there are already titles in the Copy List, the title is added at the end.

- 3 Repeat step 2 to add more titles to the Copy List, or press **RETURN** to go back to the Copy List menu options.

Note

- When Frame Accurate is set to **Off** (see *Frame Accurate* on page 108), the following limitations on adding titles to the Copy List apply:
 - When adding titles that contain copy-once protected material, the copy-once parts will not be added to the Copy List.
 - When adding titles that contain material of more than one aspect ratio (screen size), each part with a different aspect ratio will be added as a separate title.
 - Widescreen material recorded in **LP, EP** or **MN1–18** will not be added to the Copy List.
 - Chapter markers on the copy may be up to 0.5 seconds off compared to the original.
- Only titles which were recorded in the same TV system as the recorder is currently set to can be added to the Copy List.

Erase

Use this command to erase individual titles from the Copy List.

- 1 Select 'Erase' from the Copy List menu options.
- 2 Use the \leftarrow/\rightarrow (cursor left/right) buttons to select a title from the Copy List to erase, then press ENTER.

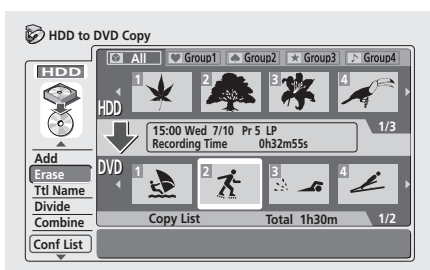

- 3 Select 'Yes' to confirm that you want to erase the title, or 'No' to cancel.
- 4 Repeat steps 2 and 3 to erase more titles from the Copy List, or press RETURN to go back to the Copy List menu options.

Title Name (Ttl Name)

Use this command to name or rename titles in the Copy List (the names of the original titles remain unchanged).

- 1 Select 'Ttl Name' from the Copy List menu options.
- 2 Use the \leftarrow/\rightarrow (cursor left/right) buttons to select a title from the Copy List to name or rename, then press ENTER.

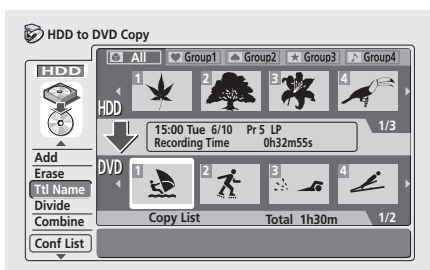

- 3 Input a name for the selected title.

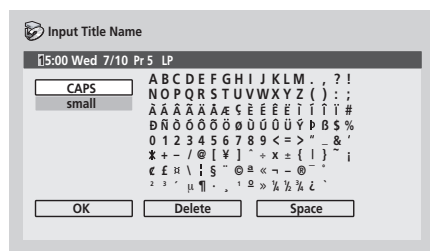

- Use the $\uparrow/\downarrow/\leftarrow/\rightarrow$ (cursor buttons) and **ENTER** to select characters.
- A name generated automatically by the recorder will already be in the name input section of the screen. Use the \leftarrow/\rightarrow buttons to change the cursor position.
- Select **CAPS** or **small** to change to upper or lower case, or use the **CASE SELECTION** buttons (\leftarrow/\rightarrow).
- You can also use the **CLEAR** button to delete characters directly (press and hold for two seconds to delete the whole name). For other remote control key shortcuts, see *Using the remote key shortcuts to input a name* on page 80.
- Press **RETURN** to go back to the Copy List screen without changing the name.

- 4 To confirm the name and return to the main Copy List screen, highlight 'OK' and press ENTER.

- 5 Repeat steps 2 to 4 to name other titles in the Copy List, or press RETURN to go back to the Copy List menu options.

Divide

Use this command to make two titles from a title already in the Copy List.

- 1 Select 'Divide' from the Copy List menu options.
- 2 Use the \leftarrow/\rightarrow (cursor left/right) buttons to select a title from the Copy List to divide, then press ENTER.

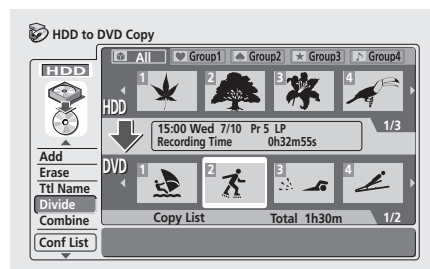

3 Use the playback controls to find the place you want to divide the title.

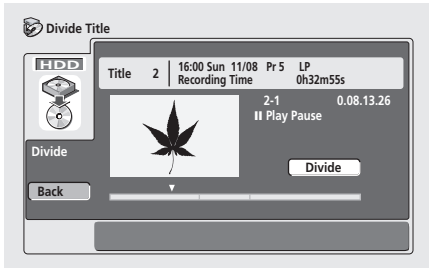

You can use all the usual playback controls, including ► **PLAY**, ■ **PAUSE**, scan (◀◀, ▶▶), and slow-motion (◀◀◀, ▶▶▶).

- Press **RETURN** or highlight **Back** and press **ENTER** to go back to the main Copy List screen, leaving the title intact.

4 With 'Divide' highlighted, press **ENTER** to divide the title at the current playback position.

5 Repeat steps 2 to 4 to divide other titles in the Copy List, or press **RETURN** to go back to the Copy List menu options.

Note

- When Frame Accurate is set to **Off** (see *Frame Accurate* on page 108), the divide points may move by up to half a second after selecting **Divide**.

Combine

Use this command to make a single title from two adjacent titles in the Copy List.

1 Select 'Combine' from the Copy List menu options.

2 Use the ◀/▶ (cursor left/right) buttons to select two adjacent titles from the Copy List to combine, then press **ENTER**.

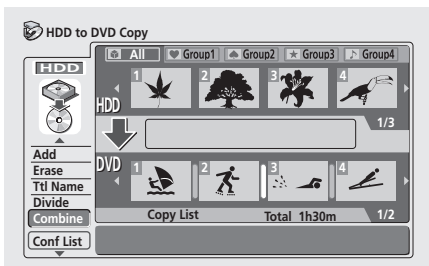

3 Repeat step 2 to combine more titles, or press **RETURN** to go back to the Copy List menu options.

Note

- When Frame Accurate is set to **Off** (see *Frame Accurate* on page 108), the following limitations apply when combining titles:
 - Mixed aspect ratios (16:9, 4:3, 4:3 (letter box)) can't be combined.
 - Mixed recording modes (**EP/MN1–6**, **LP/MN7–18**, **SP/MN19–31**, **FINE/MN32**) can't be combined.

Preview

Use this command to check the content of a title in the Copy List.

1 Select 'Preview' from the Copy List menu options.

2 Use the ◀/▶ (cursor left/right) buttons to select a title from the Copy List to preview, then press **ENTER**.

The selected title starts playing. You can return to the Copy List screen by pressing ■ **STOP**, otherwise playback will continue until the end of the Copy List.

- During preview, you can select a new thumbnail for the Disc Navigator by pressing **NAVI MARK**.

3 Repeat step 2 to preview other titles, or press **RETURN** to go back to the Copy List menu options.

Move

Use this command to change the order of titles in the Copy List.

1 Select 'Move' from the Copy List menu options.

2 Use the ◀/▶ (cursor left/right) buttons to select a title from the Copy List to move, then press **ENTER**.

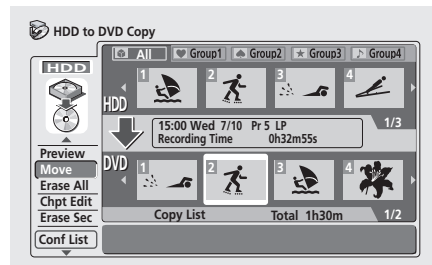

The thumbnail appears in the Copy List section in the lower half of the screen.

- 3 Use the \leftarrow/\rightarrow (cursor left/right) buttons to select a new position for the title, then press **ENTER**.

The thumbnails in the Copy List reflect the new order.

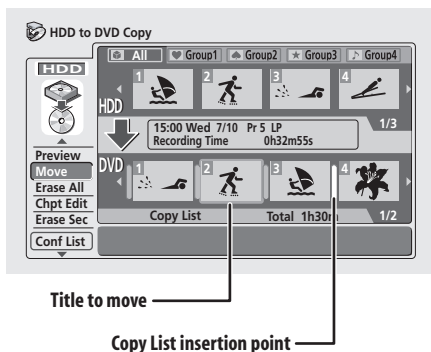

- 4 Repeat steps 2 and 3 to move other titles in the Copy List, or press **RETURN** to go back to the Copy List menu options.

Erase All

Use this command to erase the Copy List.

- 1 Select 'Erase All' from the Copy List menu options.
- 2 Select 'Yes' to confirm, or 'No' to cancel, then press **ENTER**.

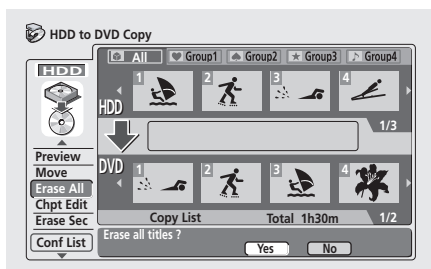

Chapter Edit (Chpt Edit)

The Chapter Edit option gives you access to several commands that you can use to edit chapters within a Copy List title.

Editing chapters in a Copy List title does not change any actual content on the HDD. It affects only how the chapters appear after copying.

- 1 Select 'Chpt Edit' from the Copy List menu options.

- 2 Use the \leftarrow/\rightarrow (cursor left/right) buttons to select a title from the Copy List to edit, then press **ENTER**.

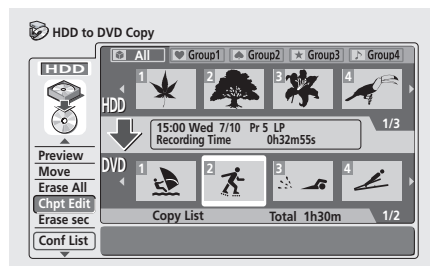

The chapter editing screen appears with thumbnails of each chapter.

- 3 Select a command from the chapter edit menu options.

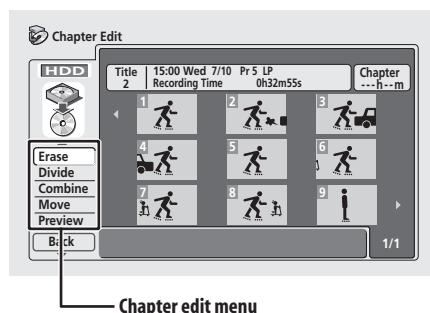

The following commands are available:

- **Erase** – Erase individual chapters: Use the $\uparrow/\downarrow/\leftarrow/\rightarrow$ (cursor buttons) and **ENTER** to select a chapter to erase. The chapter is erased after confirming.
- **Divide** – Divide a chapter into two or more new chapters: See *Chapter Edit: Divide* below.
- **Combine** – Combine two chapters into one: See *Chapter Edit: Combine* below.
- **Move** – Change the order of the chapters: See *Chapter Edit: Move* below.
- **Preview** – Check the content of a chapter: Use the $\uparrow/\downarrow/\leftarrow/\rightarrow$ (cursor buttons) to select a chapter, then press **ENTER**. Once the preview has started, press **■ STOP** to return to the chapter edit screen.

- 4 Press **RETURN** to get back to the chapter editing options on the left, or select another chapter

- 5 Select 'Back' (or press **RETURN**) to go back to the main Copy List screen.

Chapter Edit: Divide

You can divide a chapter into as many new chapters as necessary.

- 1 Use the **↑/↓/←/→** (cursor buttons) to select the chapter to divide, then press **ENTER**.
- 2 Use the playback controls to find the place you want to divide the chapter.

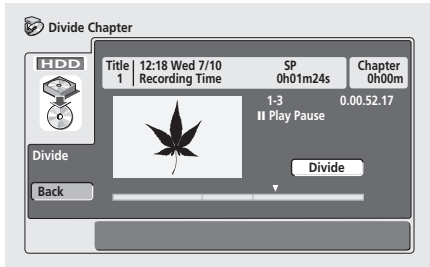

You can use all the usual playback controls, including **▶ PLAY**, **⏸ PAUSE**, scan (**◀◀**, **▶▶**), and slow-motion (**◀◀||**, **||▶▶**).

- 3 With 'Divide' highlighted, press **ENTER** to divide the chapter at the current playback position.

You can divide the chapter as many times as you want (up to 99 per title).

- 4 Select 'Back' (or press **RETURN**) to get back to the main Chapter Edit screen.

Note

- When Frame Accurate is set to **Off** (see *Frame Accurate* on page 108), the divide point may move by up to half a second after selecting **Divide**.

Chapter Edit: Combine

This command lets you combine two chapters into one.

- 1 Use the **↑/↓/←/→** (cursor buttons) to select the space between the chapters to combine.

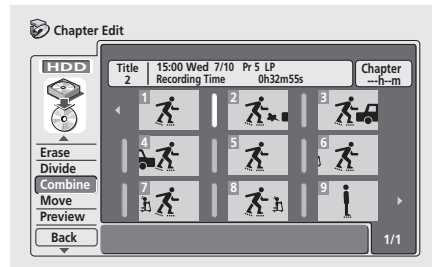

- 2 Press **ENTER** to combine.

Chapter Edit: Move

This command lets you rearrange the chapters within a Copy List title.

- 1 Use the **↑/↓/←/→** (cursor buttons) to select the chapter you want to move, then press **ENTER**.

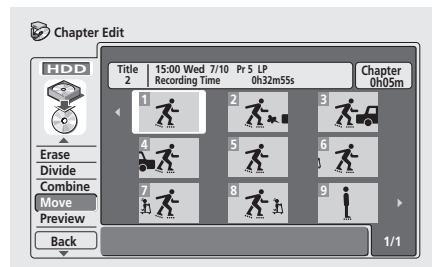

- 2 Use the **↑/↓/←/→** (cursor buttons) to select a new position for the chapter, then press **ENTER**.

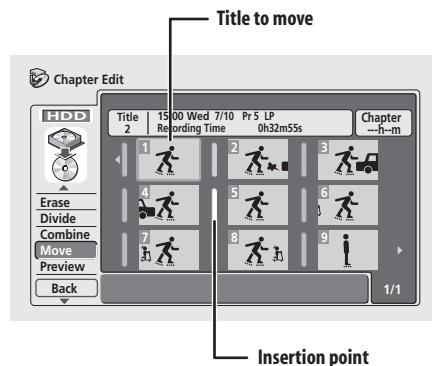

The thumbnails in the chapter list reflect the new order.

Erase Section (Erase Sec)

Using this command you can delete a part of a Copy List title, ideal for cutting out the commercial breaks in a recording made from the TV.

- 1 Select 'Erase Sec' from the Copy List menu options.
- 2 Use the \leftarrow/\rightarrow (cursor left/right) buttons to select the title you want to erase a section from, then press **ENTER**.

After selecting a title, a screen appears from which you can mark the start and end points of the section to erase.



- 3 Use the playback controls to find the start of the section to erase, then (with 'From' highlighted) press **ENTER**.

You can use all the usual playback controls, including **▶ PLAY**, **II PAUSE**, scan (\lll, \ggg), and slow-motion (\lll, \ggg).

The bar at the bottom of the screen shows the current play position in the title. After pressing **ENTER**, a marker appears under the bar to show the start of the section.

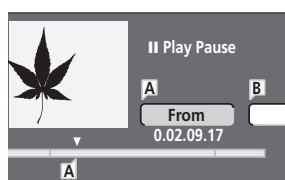

- 4 In the same way, find the end of the section to erase, then (with 'To' highlighted) press **ENTER**.

After pressing **ENTER**, another marker appears under the bar to show the end of the section, with the section itself marked in red.

- 5 Select 'Yes' to confirm, or 'No' to cancel, then press **ENTER**.

In the thumbnail viewer you can see a few seconds of video either side of the marked section to see how the edit will look.

- 6 Repeat steps 3 to 5 if you want to erase more sections from the same title.

- 7 Select 'Back' (or press **RETURN**) to get back to the main Copy List screen.

Note

- When Frame Accurate is set to **Off** (see *Frame Accurate* on page 108), the 'From' time and length of the erased section may differ by up to 0.5 seconds from that set.

Copying from DVD to HDD*

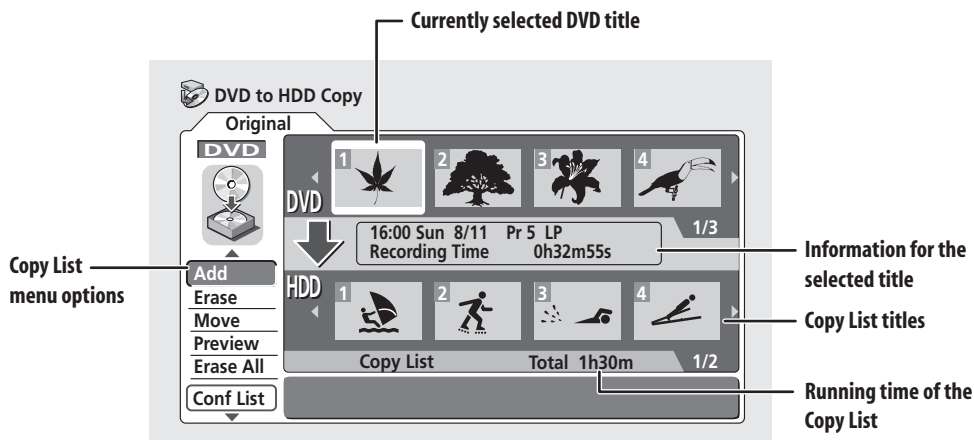

Use the DVD to HDD Copy screen to transfer video on DVD to the hard disk.

* See also *Copyright* on page 62.

Important

- The DVD to HDD Copy screen is not accessible when a finalized Video mode disc is loaded. However, you can still use the One Touch Copy function (see *One Touch Copy* (DVD to HDD)* on page 62).
- The recorder can only store one Copy List at a time.
- The copy list will be erased if:
 - any of the titles on the DVD disc are erased or edited.
 - the disc tray is opened.
 - playback is switched between Original and Play List.
 - the DVD disc is re-initialized or finalized.
 - the recorder is reset to its factory settings (see *Resetting the recorder* on page 112).
- It may not be possible to copy from a DVD disc that was recorded on a different DVD recorder or PC.

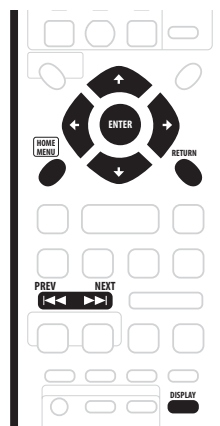

- 1 Load the recordable DVD disc that contains the material you want to copy to the HDD.
- 2 Press HOME MENU and select 'Copy'.



DVR-520H/720H screen

- Note that the **Copy** option will not be available if the TV system of the recorder and the disc do not match. (See *Input Line System* on page 98 for how to change the TV system of the recorder.)

3 Select 'DVD → HDD'.

The DVD to HDD Copy screen appears.

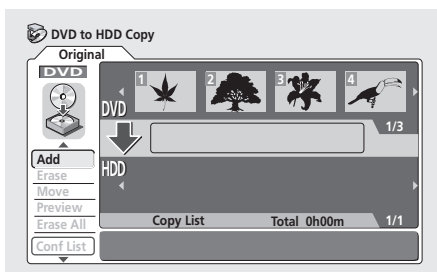

- Use the **↑/↓** (cursor up/down) buttons to highlight the command you want from the menu options on the left, then press **ENTER**. Most commands require you then to select a title or location from the thumbnail views area of the screen. Use the **←/→** (cursor left/right) followed by **ENTER** to do this.
- When in the thumbnails area of the screen, use the **PREV** (**◀◀**) and **NEXT** (**▶▶**) buttons to display the previous/next page if there are more titles than will fit on the screen.
- As you highlight different thumbnails, information about the title is shown in the central area of the screen. Press **DISPLAY** to change the information displayed.
- Press **RETURN** to get back to the menu options on the left from the thumbnail area of the Copy List screen.

DVD to HDD Copy List menu options

Use the following commands when making a DVD to HDD Copy List:

- **Add** – Select and add titles to the Copy List (see page 73).
- **Move** – Change the order of titles in the Copy List (see page 73).
- **Erase All** – Erase the Copy List (see page 74).
- **Preview** – Check the content of a title in the Copy List (see page 74).
- **Erase** – Erase individual titles from the Copy List (see page 73).
- **Confirm List (Conf List)** – Confirm the Copy List and go to the recording settings screen (see *Recording the Copy List* below).

Recording the Copy List

After putting together your Copy List, you're ready to record it.

- 1 Select 'Conf List' to display the Copy List settings screen.
- 2 Use the **←/→** (cursor left/right) buttons to select the Recording Mode.

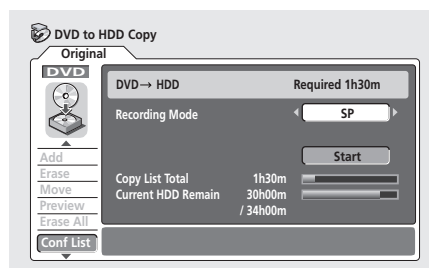

- **High-Speed Copy** – Only available when copying Original content from a VR mode disc. The Copy List is copied at the same recording quality as the original. (See page 61 for more information on high-speed copying.)
- **FINE, SP, LP, EP, MN** – The Copy List is copied at the specified recording quality in real-time. (Note that if you copy at a higher quality setting than the original, the copy will not be better quality than the original.)
- If you select **MN** above, you can also change the level setting (**MN1–MN32**) from the Recording Quality box that appears.

When you change the recording mode setting, you can see how much hard disk space it will require. If this is more than is available, it shows up in red and you won't be able to start copying. In this case, either change the recording quality, or press **RETURN** to go back to the Copy List screen and erase one or more titles from the Copy List.

- 3 Select 'Start' to begin copying.

DVD to HDD Copy List commands

Add

Use this command to add titles to the Copy List.

- 1 Select 'Add' from the Copy List menu options.
- 2 Use the \leftarrow/\rightarrow (cursor left/right) buttons to select a title from the DVD to add to the Copy List, then press ENTER.

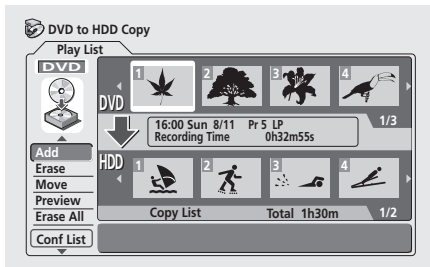

The thumbnail appears in the Copy List section in the lower half of the screen. If there are already titles in the Copy List, the title is added at the end.

- 3 Repeat step 2 to add more titles to the Copy List, or press RETURN to go back to the Copy List menu options.

Note

- Titles which were recorded directly to a VR mode disc or have already been copied real-time, and which contain bilingual audio or are recorded in recording modes **MN12–MN20** can be added to the Copy List, however if **High-Speed Copy** is selected they will not actually be copied.
- Similarly, a copy-once protected title, recorded from the TV for example, can be added to the Copy List, but it will not be copied if **High-Speed Copy** is selected.
- You may not be able to copy titles when copying a disc that was created using a PC or another recorder.

Erase

Use this command to erase individual titles from the Copy List.

- 1 Select 'Erase' from the Copy List menu options.
- 2 Use the \leftarrow/\rightarrow (cursor left/right) buttons to select a title from the Copy List to erase, then press ENTER.

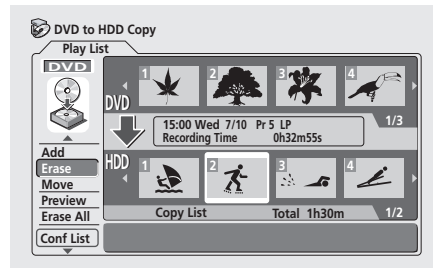

- 3 Select 'Yes' to confirm that you want to erase the title, or 'No' to cancel.

- 4 Repeat steps 2 and 3 to erase more titles from the Copy List, or press RETURN to go back to the Copy List menu options.

Move

Use this command to change the order of titles currently in the Copy List.

- 1 Select 'Move' from the Copy List menu options.
- 2 Use the \leftarrow/\rightarrow (cursor left/right) buttons to select a title from the Copy List to move, then press ENTER.

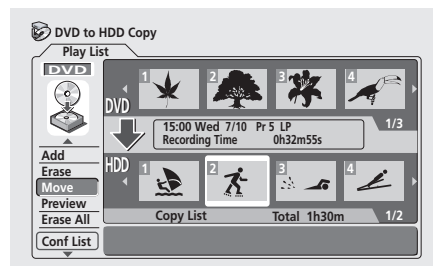

- 3 Use the ←/→ (cursor left/right) buttons to select the insertion point for the title, then press ENTER.

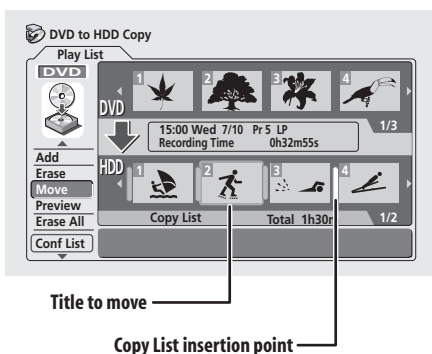

The thumbnails in the Copy List are updated to reflect the new order.

- 4 Repeat steps 2 and 3 to move other titles in the Copy List, or press RETURN to go back to the Copy List menu options.

Preview

Use this command to check the content of a title in the Copy List.

- 1 Select 'Preview' from the Copy List menu options.
- 2 Use the ←/→ (cursor left/right) buttons to select a title from the Copy List to preview, then press ENTER.
The selected title starts playing. You can return to the Copy List screen by pressing ■ STOP, otherwise playback will continue until the end of the Copy List.
- 3 Repeat step 2 to preview other titles, or press RETURN to go back to the Copy List menu options.

Erase All

Use this command to erase the Copy List.

- 1 Select 'Erase All' from the Copy List menu options.
- 2 Select 'Yes' to confirm, or 'No' to cancel, then press ENTER.

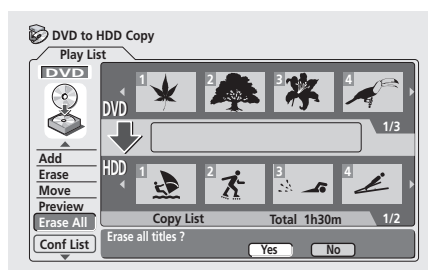

Using disc back-up*

This feature offers a simple way to make a back-up copy of a finalized Video mode disc. The data is copied first to the hard disk drive, then on to another recordable DVD disc.

* See also *Copyright* on page 62.

- 1 Press HOME MENU.
- 2 Select 'Copy'
- 3 Select 'Disc Back-up'.
- 4 Select a back-up option.

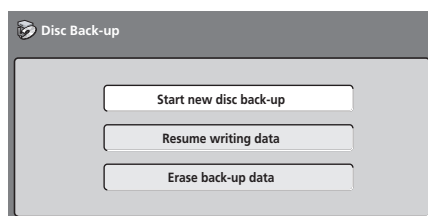

There are three back-up options:

- **Start new disc back-up** – Start making a back-up of a disc.
- **Resume writing data** – Record the back-up data already on the HDD to a recordable DVD.
- **Erase back-up data** – Erase the back-up data on the HDD.

5 Press ▲ OPEN/CLOSE to open the disc tray and load the disc you want to make a back-up of, then close the disc tray.

You can only make back-up copies of finalized Video mode discs.

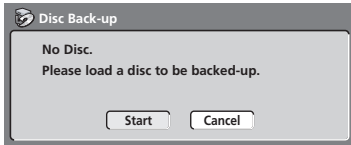

6 Select 'Start'.

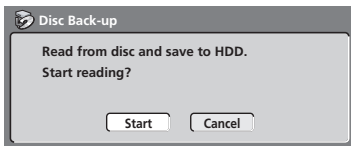

- To see the progress of the back-up, press **DISPLAY**.
- You can cancel the back-up process by pressing **ONE TOUCH COPY** for more than one second.

7 When the data has been copied, press ▲ OPEN/CLOSE to open the disc tray. Take out the disc and load a blank* recordable DVD.

** If you're using a DVD-RW, the disc doesn't have to be blank, although the previous contents of the disc will be erased in the back-up process.*

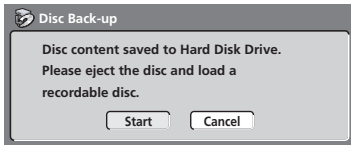

You can use a DVD-R Ver. 2.0 disc, or DVD-RW Ver. 1.1 or Ver. 1.2 / 4x for the back-up.

- If you back-up a DVD-R disc to DVD-RW, you cannot undo the finalization later.
- Actual recordable capacity of discs vary so there may be cases where the contents of the disc you're backing-up will not fit on to a particular blank disc. If this happens, please try another brand of disc.

8 Select 'Start' to start writing the backed-up data to the blank disc.

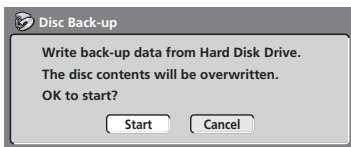

- To see the progress of the back-up, press **DISPLAY**.

- You can cancel the back-up process by pressing **ONE TOUCH COPY** for more than one second. However, this will make the disc unusable (although if you are using a DVD-RW disc you can re-initialize it in order to make it usable again—see *Initializing a DVD-RW disc* on page 60.)

9 After the recorder has finished recording the back-up disc, you can select whether to make another back-up of the same data or exit.

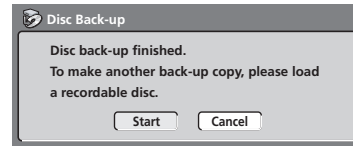

- Select **Start** to make another back-up copy or **Cancel** to finish. If you want to make another back-up copy, return to step 6 above.

10 If you don't need to keep the back-up data on the HDD, you can delete it now.

Select **Yes** to delete the data from the HDD; select **No** to keep it (you can delete it later if you want to).

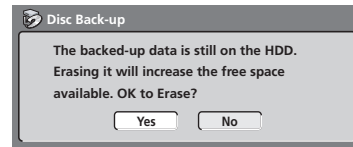

- If you decide to leave the back-up data on the HDD, you can make back-up copies to recordable DVD discs anytime from the Disc Back-up menu.

Note

- It is not possible to play material on the HDD that has been backed-up from DVD.

Chapter 8

Editing

Using the Disc Navigator you can edit video content on unfinalized Video mode and VR mode DVD discs, as well as video content on the internal hard disk drive (HDD). The editing features available in the Disc Navigator depend on whether you are editing video on a Video mode or VR mode DVD, or the HDD, and whether you're editing Original content, or a Play List.

With unfinalized Video mode DVDs, there are a limited number of editing commands, including naming, locking and erasing titles. Once a Video mode disc has been finalized, further editing is not possible.

There are two ways to edit VR mode DVD-RW discs. You can directly edit the Original content of the disc, or you can create and edit a Play List. The Play List doesn't actually change any of the content on the disc, but just controls how the content is played back (rather like the program play feature found on CD players).

Editing material recorded on the HDD is similar to editing the Original content of a VR mode DVD-RW, with similar commands for erasing, naming and locking titles, as well as fine control over the content of chapters within titles.

The Disc Navigator screen

DVD Disc Navigator

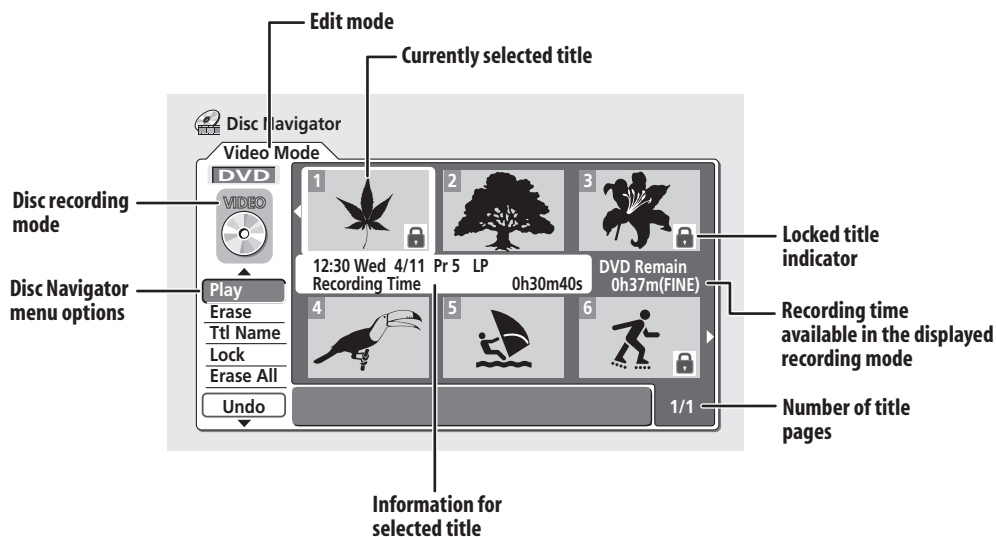

HDD Disc Navigator

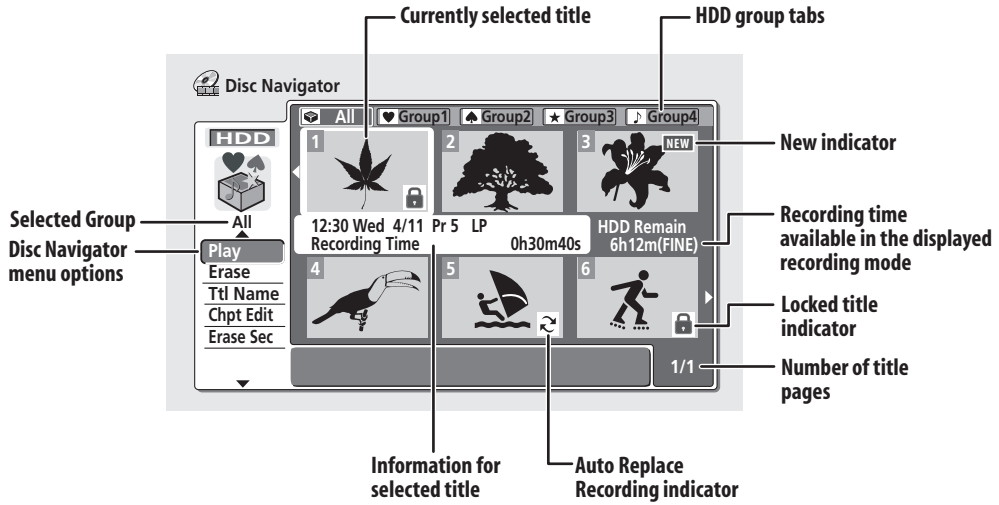

Important

- Titles that have been recorded with a Line Input setting different to the current setting of the recorder are shown in the Disc Navigator with a blank thumbnail image. See also *Input Line System* on page 98.
- During recording, if you display the Disc Navigator for the HDD, some of the titles may appear with a  mark. These titles were recorded with a Line Input setting different to the current setting of the recorder. During recording, these titles cannot be played.

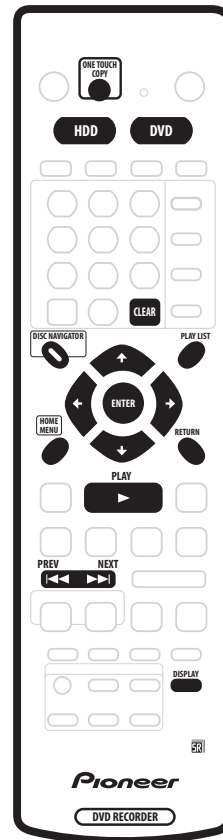

1 Press HDD or DVD to select the hard disk drive or the DVD.

2 Press DISC NAVIGATOR to display the Disc Navigator screen.

Playback will automatically stop when you do this.

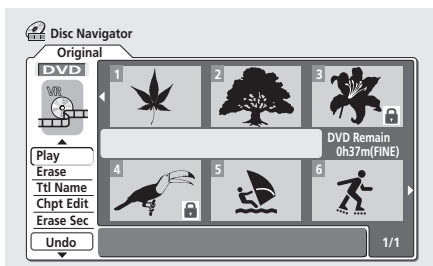

- You can also access the Disc Navigator from the Home Menu (press **HOME MENU**, select **Disc Navigator** then press **ENTER**).
- Use the **↑/↓** (cursor up/down) buttons to highlight the command you want from the menu options on the left, then press **ENTER**. Most commands require you then to select a title (or chapter) or location from the thumbnail views area of the screen. Use the **↑/↓/←/→** (cursor buttons) followed by **ENTER** to do this.
- When in the thumbnails area of the screen, use the **PREV** (◀◀) and **NEXT** (▶▶) buttons to display the previous/next page if there are more than six titles/nine chapters.
- As you highlight different thumbnails, information about the title is shown in the central area of the screen. Press **DISPLAY** to change the information displayed.
- If you are editing a VR mode disc, press **PLAYLIST** to switch between Original and Play List Disc Navigator screens.

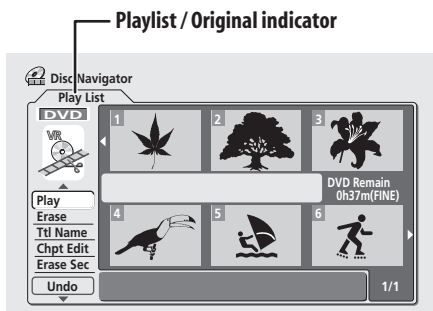

- Press **RETURN** to get back to the menu options on the left from the thumbnail area of the Disc Navigator.

- You can switch between the HDD and the DVD Disc Navigator screens using the **HDD** and **DVD** buttons (front panel or remote).

You can copy a selected HDD title to DVD, or DVD title to HDD by pressing **ONE TOUCH COPY** (see also page 62 for more on One Touch Copy).

When editing HDD content, a row of group names appears above the title thumbnails (see *Editing HDD groups* on page 84 for more details). You can access these by pressing **↑** (cursor up) repeatedly until the **All** group is highlighted, then using the **←/→** (cursor left/right) buttons to select a group. Press **ENTER** to 'open' the highlighted group.

Titles on the HDD marked with a **⌚** icon are timer recordings set to Auto Replace Recording (see *Standard timer recording* on page 51).

Titles on the HDD marked with a **NEW** icon are recently recorded titles that haven't yet been played.

3 To exit the Disc Navigator, press HOME MENU.

Remember

- You can change the thumbnail pictures used for titles using the **NAVI MARK** button—see *Changing the thumbnail picture for a title* on page 37.

Disc Navigator menu options

The commands available from the Disc Navigator for the VR mode and Video mode discs and the HDD are shown below.

Video mode

- Play** – Play a title (page 79)
- Title Name (Ttl Name)** – Name or rename a title (page 80)
- Lock/Unlock** – Lock or unlock a title to prevent accidental changes being made (page 82)
- Erase** – Erase a title (page 79)
- Erase All** – Erase all titles (page 83)
- Undo** – Undo the last change (page 83)

VR mode (Original)

- Play** – Play a title (page 79)
- Title Name (Ttl Name)** – Name or rename a title (page 80)
- Lock/Unlock** – Lock or unlock a title to prevent accidental changes being made (page 82)
- Erase** – Erase a title (page 79)
- Erase All** – Erase all titles (page 83)

- **Undo** – Undo the last change (page 83)
- **Chapter Edit (Chpt Edit)** – Make detailed changes to chapters in a title (page 81)
- **Erase Section (Erase Sec)** – Erase a part of a title (page 82)

HDD

- **Play** – Play a title (page 79)
- **Title Name (Ttl Name)** – Name or rename a title (page 80)
- **Lock/Unlock** – Lock or unlock a title to prevent accidental changes being made (page 82)
- **Erase** – Erase a title (page 79)
- **Erase All** – Erase all titles (page 83)
- **Chapter Edit (Chpt Edit)** – Make detailed changes to chapters in a title (page 81)
- **Divide** – Divide a title into two (page 83)
- **Change Group (Chg Group)** – Assign a title to a group on the HDD (page 84)
- **Group Name (Grp Name)** – Name or rename an HDD group (page 84)
- **Erase Section (Erase Sec)** – Erase part of a title (page 82)

VR mode (Play List)

- **Create** – Make a new Play List title (page 87)
- **Chapter Edit (Chpt Edit)** – Make detailed changes to chapters in a Play List title (page 86)
- **Move** – Move the position of a title in the Play List (page 87)
- **Erase All** – Erase all titles in the Play List (page 88)
- **Undo** – Undo the last change (page 88)
- **Play** – Play a title (page 85)
- **Erase** – Erase a title from the Play List (page 85)
- **Title Name (Ttl Name)** – Name or rename a title in the Play List (page 85)
- **Combine** – Combine two Play List titles into one (page 88)
- **Divide** – Divide a Play List title into two (page 88)
- **Erase Section (Erase Sec)** – Erase a part of a title (page 86)

Editing VR mode Original, Video mode and HDD content

These commands affect the actual content stored on the DVD-R/RW or HDD.

Remember

- If you are editing a VR mode disc, use the **PLAYLIST** button to switch to the Disc Navigator Original screen.

Play

VR mode **Video mode** **HDD**

Use this function to start playback of a title.

- 1 Select 'Play' from the Disc Navigator menu options.
- 2 Use the **↑/↓/←/→** (cursor buttons) to select the title you want to play, then press **ENTER** or **▶ PLAY**.

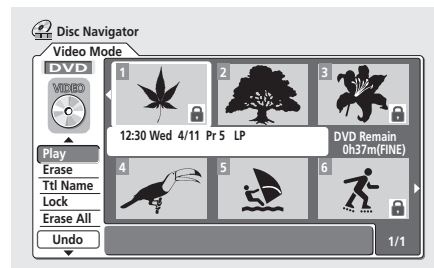

Playback of the title you selected starts.

Erase

VR mode **Video mode** **HDD**

The Erase title command does slightly different things depending on what you are currently editing. If you are editing Original content on a VR mode disc or content on the HDD, the title will be erased from the disc and the available recording time will increase accordingly.

If you erase titles from a Video mode DVD-R disc, the title will disappear from the list of titles, but the available recording time will not increase. Erasing a title from a Video mode DVD-RW disc increases the available recording time only if it is the last title on the disc.

- 1 Select 'Erase' from the Disc Navigator menu options.
- 2 Use the $\uparrow/\downarrow/\leftarrow/\rightarrow$ (cursor buttons) to select the title you want to erase, then press ENTER.

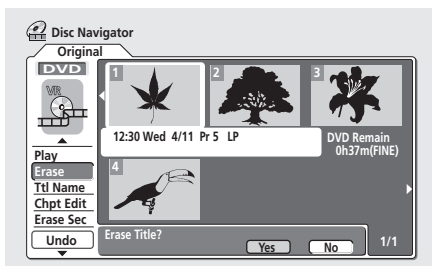

- 3 Highlight 'Yes' to confirm, or 'No' to cancel, then press ENTER.
- 4 Press RETURN to go back to the Disc Navigator menu options, or select another title to erase.

Tip

- You can erase a title quickly by pressing **CLEAR** when the title is highlighted. Confirm the edit by pressing **ENTER**. (You can also use this method to erase titles when using the *Play* function, above.)

Title Name (Ttl Name)

VR mode Video mode HDD

You can give titles new names of up to 64 characters long for VR mode and HDD recordings and 32 characters for Video mode recordings.

- 1 Select 'Ttl Name' from the Disc Navigator menu options.
- 2 Use the $\uparrow/\downarrow/\leftarrow/\rightarrow$ (cursor buttons) to select the title you want to name, then press ENTER to go to the name input screen.
- 3 Input a name for the selected title.

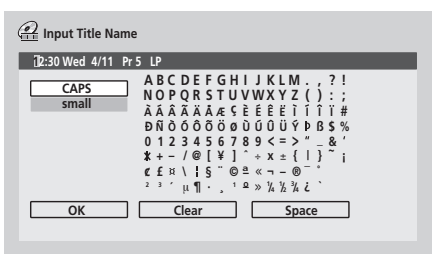

- Use the $\uparrow/\downarrow/\leftarrow/\rightarrow$ (cursor buttons) and **ENTER** to select characters.

- A name generated automatically by the recorder will already be in the name input section of the screen. Use the \leftarrow/\rightarrow buttons to change the cursor position.
- Select **CAPS** or **small** to change to upper or lower-case, or use the **CASE SELECTION** buttons (\leftarrow/\rightarrow).
- You can also use the **CLEAR** button to delete characters directly (press and hold for two seconds to delete the whole name). For other remote control key shortcuts, see *Using the remote key shortcuts to input a name* below.
- For discs formatted on a different DVD recorder, you will see only a limited character set.

- 4 Highlight 'OK' then press ENTER to enter the name and return to the main Disc Navigator screen.
 - To return to the main Disc Navigator screen without saving changes to the title name, press **RETURN**.
- 5 Press RETURN to go back to the Disc Navigator menu options, or select another title to name.

Using the remote key shortcuts to input a name

The table below shows the remote control key shortcuts that you can use to input characters in the name input screen. Pressing a button repeatedly cycles through the characters shown.

If you want to enter two characters in succession that are both on the same button (for example a **P** and an **R**), press \rightarrow to advance the cursor one space manually between inputting the two characters.

Key	Characters	Key	Characters
1	, ' ? ! - & 1	6	m n o 6 ö ö ð ó ø ñ
2	a b c 2 ä å á â ã æ ç	7	p q r s 7 \$ ÿ/ß *1
3	d e f 3 è é ê ë ê	8	t u v 8 ù ú û ü
4	g h i 4 î ï ï ï	9	w x y z 9
5	j k l 5 £	0	0
\leftarrow	[cursor back]	\rightarrow	[cursor forward]
\leftarrow/\rightarrow	[change case]	CLEAR	[clear character]
II	<space>	■	[finish name input]
VIDEO Plus+	~ () _ / ; : " ` ^ @ # * % ¥ + = { } [] < >		

*1 lower-case: ÿ; upper-case: ß

Chapter Edit (Chpt Edit)

VR mode HDD

When editing VR mode DVDs or video on the HDD you can edit individual chapters within a title, with commands for erasing, combining and dividing. You can also play individual chapters to check their content.

- 1 Select 'Chpt Edit' from the Disc Navigator menu options.
- 2 Use the **↑/↓/←/→** (cursor buttons) to select the title that contains the chapters you want to edit, then press **ENTER**.

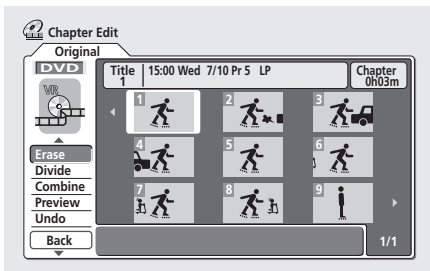

After selecting a title, thumbnails of each chapter appear and you'll see that the Disc Navigator menu items change to the chapter editing commands:

- **Erase** – Erase chapters: Select the chapter you want to erase and press **ENTER** (see also the note below).
- **Divide** – Divide a chapter into two or more parts: Select the chapter you want to divide. From the following screen use the playback controls (**▶**, **⏏**, **◀◀**, **▶▶**, etc.) to find the point at which you want to divide the chapter. With **Divide** highlighted, press **ENTER**.

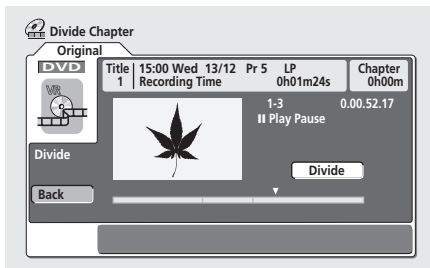

You can keep dividing the chapter as many times as you wish (up to 999 chapters per DVD disc or 99 chapters per HDD title). Highlight **Back** and press **ENTER** to return to the Chapter Edit screen.

- **Combine** – Combine two adjacent chapters into one: Highlight the bar divider between two adjacent chapters and press **ENTER** (see also the note below)

- **Preview** – Preview chapters: Select the chapter you want to play; press **■ STOP** to return to the chapter edit screen.
- **Undo** – Undo the last command (only works with VR mode disc edits).

3 Press RETURN to get back to the menu options on the left side of the screen.

4 To return to the Disc Navigator screen, press RETURN again, or select 'Back' from the menu options on the left.

Note

- When editing VR mode Original content, it may not be possible to erase chapters less than five seconds long.
- It may not always be possible to combine two chapters, even though they are adjacent. If a chapter has been divided into three, then the middle chapter erased, it is not possible to combine the two remaining chapters into one.

Inserting chapter markers into a title

VR mode HDD

You can create new chapters within a title using the **CHP MARK** button while playing the title or during recording. This is useful not just for navigation of the disc content but also for editing purposes.

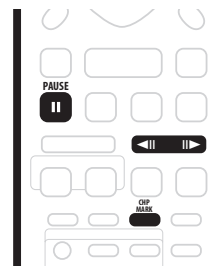

1 Start playback of the title you want to create new chapter markers in.

You can use the **Play** command from the Disc Navigator menu to do this.

2 Press CHP MARK at any point where you want a new chapter to begin.

A chapter marker icon appears on-screen briefly to confirm a new chapter mark has been inserted:



- For greater control over the exact position of chapter markers it can be useful to use the **II PAUSE** button and/or the slow-motion and frame advance/reverse controls (◀II/II▶).

Note

- You cannot insert chapter markers during Auto Start Recording.
- If you pause a recording in VR mode, the recorder automatically starts a new chapter when you restart the recording.
- When recording in Video mode, the recorder automatically puts chapter markers in at regular intervals. It is not possible to add extra chapter markers manually after recording (see also *Auto Chapter (Video)* on page 108).
- The Play List and Original content on a disc can each contain up to 999 chapters.
- Each HDD title can contain a maximum of 99 chapters.
- Similar chapter editing commands are available for HDD content from the HDD to DVD copy screen. See also *Copying from HDD to DVD** on page 63.

Erase Section (Erase Sec)

VR mode

HDD

Using this command you can delete a part of an Original title, ideal for cutting out the commercial breaks in a recording made from the TV.

1 Select 'Erase Sec' from the Disc Navigator menu options.

2 Use the ↑/↓/←/→ (cursor buttons) to select a title.

After selecting a title, the Erase Sec screen appears from which you can mark the start and end points of the section to erase.

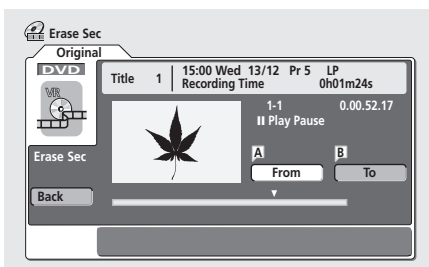

3 Use the playback controls (▶, II, ◀◀, ▶▶, etc.) to find the start of the section to erase, then (with 'From' highlighted) press ENTER.

The bar at the bottom of the screen shows the current play position in the title. After pressing **ENTER**, a marker appears under the bar to show the start of the section.



4 In the same way, find the end of the section to erase, then (with 'To' highlighted) press ENTER.

After pressing **ENTER**, another marker appears under the bar to show the end of the section, with the section itself marked in red.

5 Select 'Yes' to confirm, or 'No' to cancel, then press ENTER.

In the thumbnail viewer you can see a few seconds of video either side of the marked section to see how the edit will look.

- When editing VR mode Original content, you may not be able to erase very short sections (less than five seconds).

6 Erase another section from the same title, or press RETURN to get back to the main Disc Navigator screen.

Lock / Unlock

VR mode

Video mode

HDD

You can lock a title so that it can't be edited or erased accidentally. If you do need to edit it, you can always unlock it later.



Important

- You can't undo any edits made before changing the lock status. You also can't undo a lock/unlock command using the **Undo** option from the Disc Navigator menu.

- 1 Select 'Lock' from the Disc Navigator menu options.
- 2 Use the $\uparrow/\downarrow/\leftarrow/\rightarrow$ (cursor buttons) to select the title you want to lock (or unlock), then press ENTER.

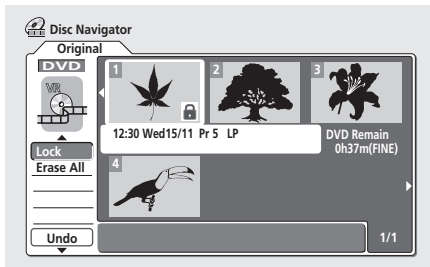

An unlocked title will become locked; a locked title will be unlocked. Locked titles are shown in the Disc Navigator with a padlock icon.

- 3 Press RETURN to go back to the Disc Navigator menu options, or select another title to lock/unlock.

Erase All

VR mode Video mode HDD

This erases all unlocked titles from the disc (see also *Lock / Unlock* on page 82).

- 1 Select 'Erase All' from the Disc Navigator menu options.
- 2 Select 'Yes' to confirm, or 'No' to cancel, then press ENTER.

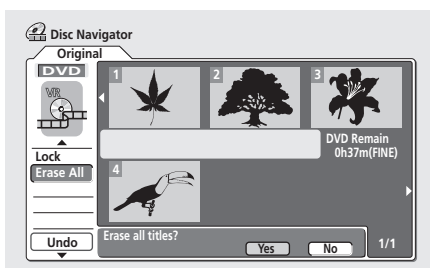

Undo

VR mode Video mode

If you make a mistake while editing, you can generally undo it. There are three levels of undo (in other words, you can undo the last three edits you made).

- Select 'Undo' from the Disc Navigator menu options.
 - You can't undo anything after ejecting the disc from the recorder or switching the recorder into standby.
 - You can't undo the following operations: initializing, recording or finalizing a disc, locking and unlocking titles.

Divide

HDD

Use this command to divide a title on the HDD into two. Note that once divided, the two new titles cannot be recombined into one again.

- 1 Select 'Divide' from the Disc Navigator menu options.
- 2 Select the title that you want to divide, then press ENTER.

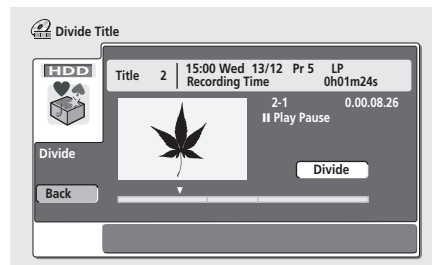

- 3 Use the standard playback controls to find the place you want to divide the title.
- 4 With 'Divide' highlighted, press ENTER to divide the title at the current playback position.
- 5 Select 'Yes' to confirm you want to divide the title. Select **No** if you want to cancel and leave the title intact.
- 6 Press RETURN to go back to the Disc Navigator menu options, or select another title to divide.

Editing HDD groups

HDD

The large capacity of the HDD means that there may be many hours of video in the recorder. To help you organize your HDD video content there are four 'groups'. You can move content from group to group, and rename the groups as you want.

Change Group (Chg Group)

HDD

Use this command to assign titles to a particular group.

- 1 Select 'Chg Group' from the Disc Navigator menu, then press ENTER.
- 2 Select the title that you want to put into a different group, then press ENTER.
- 3 Use the ↑/↓ (cursor up/down) buttons to select a group for the title, then press ENTER.
 - You can select one of the four groups, or choose **No Group**, in which case it will only appear when **All** is selected.

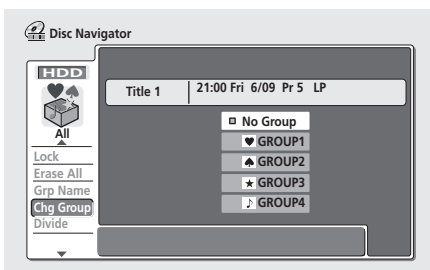

- 4 Press RETURN to go back to the Disc Navigator menu options, or select another title to change the group of.

Group Name (Grp Name)

HDD

Use this command to rename a group.

- 1 Select 'Grp Name' from the Disc Navigator menu.
- 2 Use the ←/→ (cursor left/right) buttons to select the group that you want to name or rename, then press ENTER.

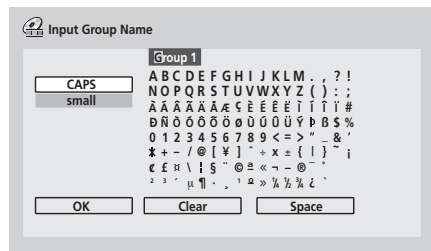

- 3 Input a name for the group. The name can be up to six characters long.
- 4 To finish entering the name, highlight 'Exit' and press ENTER.
- 5 Press RETURN to go back to the Disc Navigator menu options, or select another group to name.

Creating and editing a VR mode Play List

VR mode

A Play List is a kind of virtual content based on the actual (Original) content of the disc. The main advantages of this type of editing is that it is non-destructive of the video content on the disc, and it allows greater control over editing, so that you end up with the content exactly as you want it.

Remember

- Use the **PLAYLIST** button to switch to the Play List edit screen.
- The Play List can contain a maximum of 99 titles.

Play

VR mode

Use this function to start playback of a title.

- 1 Select 'Play' from the Disc Navigator Play List menu options.
- 2 Select the title you want to play, then press ENTER.

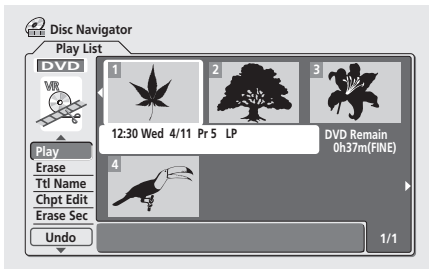

Playback of the title you selected starts.

Erase

VR mode

This command erases a title only from the Play List. The title remains in the Original content and the available recording time does not increase.

- 1 Select 'Erase' from the Disc Navigator Play List menu options.
- 2 Select the title you want to erase, then press ENTER.

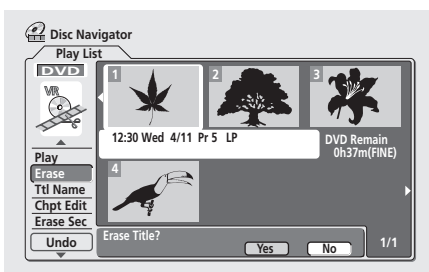

- 3 Highlight 'Yes' to confirm, or 'No' to cancel, then press ENTER.
- 4 Press RETURN to go back to the Disc Navigator menu options, or select another title to erase.

Note

- The remaining recording time doesn't change when you erase something from the Play List.

Title Name (Ttl Name)

VR mode

You can give titles new names of up to 64 characters long.

- 1 Select 'Ttl Name' from the Disc Navigator Play List menu options.
- 2 Select the title you want to name, then press ENTER.
- 3 Input a name for the selected title.

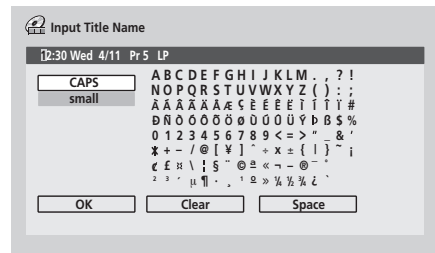

Press ENTER after selecting each character.

- A name generated automatically by the recorder will already be in the name input section of the screen. Use the ◀▶/▶▶ buttons to change the cursor position.
 - Select **CAPS** or **small** to change to upper or lower-case, or use the **CASE SELECTION** buttons (◀◀/▶▶).
 - You can also use the **CLEAR** button to delete characters directly (press and hold for two seconds to delete the whole name). For other remote control key shortcuts, see *Using the remote key shortcuts to input a name* on page 80.
 - For discs formatted on a different DVD recorder, you will see only a limited character set.
- 4 Highlight 'OK', then press ENTER to fix the name and return to the main Disc Navigator screen.
 - To return to the main Disc Navigator screen without saving changes to the title name, press RETURN.
 - 5 Press RETURN to go back to the Disc Navigator menu options, or select another title to name.

Chapter Edit (Chpt Edit)

VR mode

When editing VR mode DVDs you can edit individual chapters within a title, with commands for erasing, moving, combining and dividing. You can also play individual chapters to check their content.

1 Select 'Chpt Edit' from the Disc Navigator Play List menu options.

2 Select the title that contains the chapters you want to edit, then press ENTER.

After selecting a title, thumbnails of each chapter appear and you'll see that the Disc Navigator menu items change to the chapter editing commands:

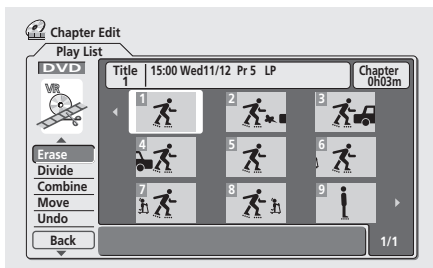

- **Erase** – Erase chapters: Select the chapter you want to erase and press **ENTER**.
- **Divide** – Divide a chapter into two or more parts: Select the chapter you want to divide. From the following screen use the playback controls (▶, II, ◀◀, ▶▶, etc.) to find the point at which you want to divide the chapter. With **Divide** highlighted, press **ENTER**.

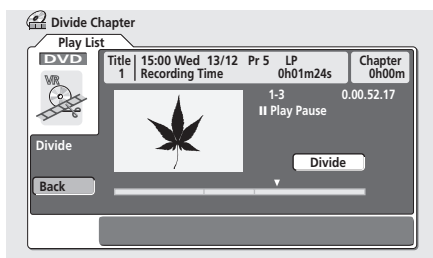

You can keep dividing the chapter as many times as you want (up to 999 chapters per disc). Highlight **Back** and press **ENTER** to return to the Chapter Edit screen.

- **Combine** – Combine two adjacent chapters into one: Select the dividing line between two adjacent chapters and press **ENTER**.
- **Move** – Rearrange chapters: Select the chapter you want to move, press **ENTER**, then highlight the new location for it, then press **ENTER** again.

- **Preview** – Preview chapters: Select the chapter you want to play; press **■ STOP** to return to the chapter edit screen.
- **Undo** – Undo the last command.

3 Press RETURN to get back to the menu options on the left side of the screen.

4 To return to the Disc Navigator screen, press RETURN again, or select 'Back' from the menu options on the left.

Erase Section (Erase Sec)

VR mode

Using this command you can delete a part of a Play List title, ideal for cutting out the commercial breaks in a recording made from the TV.

1 Select 'Erase Sec' from the Disc Navigator menu options.

2 Use the ↑/↓/←/→ (cursor buttons) to select a title.

After selecting a title, the Erase Sec screen appears from which you can mark the start and end points of the section to erase.

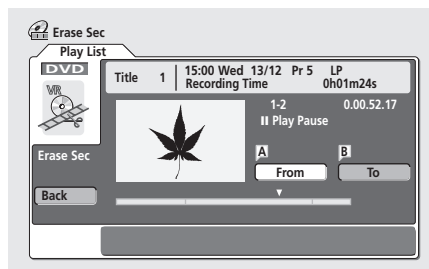

3 Use the playback controls (▶, II, ◀◀, ▶▶, etc.) to find the start of the section to erase, then (with 'From' highlighted) press ENTER.

The bar at the bottom of the screen shows the current play position in the title. After pressing **ENTER**, a marker appears under the bar to show the start of the section.

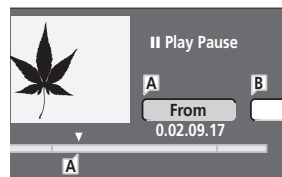

4 In the same way, find the end of the section to erase, then (with 'To' highlighted) press ENTER.

After pressing **ENTER**, another marker appears under the bar to show the end of the section, with the section itself marked in red.

5 Select 'Yes' to confirm, or 'No' to cancel, then press ENTER.

In the thumbnail viewer you can see a few seconds of video either side of the marked section to see how the edit will look.

6 Erase another section from the same title, or press RETURN to get back to the main Disc Navigator screen.

Create

VR mode

Use this function to add an Original title to the Play List. When you do this, the whole title is put into the Play List (you can erase bits you don't need later—see *Chapter Edit (Chpt Edit)* on page 86).

The title appears in the Play List complete with the chapter markers that appear in the Original. However, if you add more chapter markers to the Original later, these are not automatically copied over into the Play List title.

You can add up to 99 titles to the Play List.

1 Select 'Create' from the Disc Navigator Play List menu options.

2 Use the ↑/↓/←/→ (cursor buttons) to select the insertion point for the new title, then press ENTER.

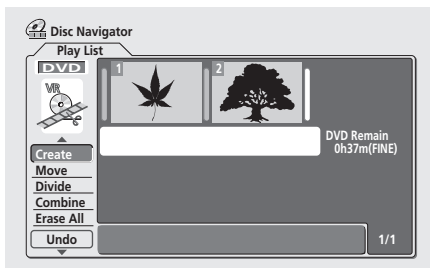

If there are no titles in the Play List yet, this step does not apply.

3 Use the ↑/↓/←/→ (cursor buttons) to select an Original title to put into the Play List.

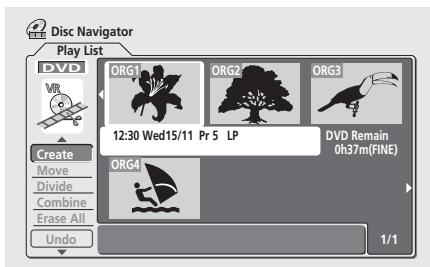

4 Press ENTER to add the title.

The new title appears in the updated Play List.

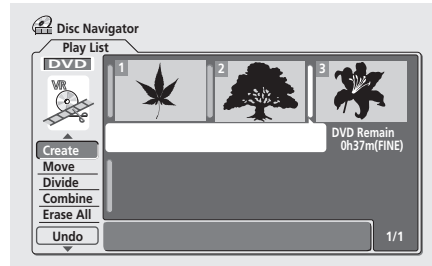

5 Press RETURN to go back to the Disc Navigator menu options, or select another location for a new title.

Move

VR mode

Use this function to re-arrange the playing order of Play List titles.

1 Select 'Move' from the Disc Navigator Play List menu options.

2 Select the title you want to move, then press ENTER.

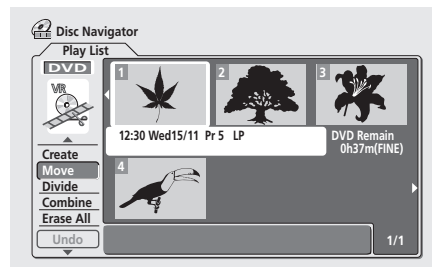

3 Select a new position in the Play List for the title, then press ENTER.

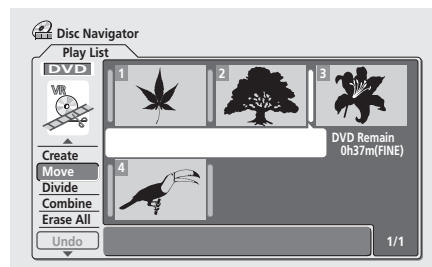

After pressing **ENTER**, the new, updated Play List is displayed.

4 Press **RETURN** to go back to the Disc Navigator menu options, or select another title to move.

Divide

VR mode

Use this command to split a title up into two new titles.

1 Select 'Divide' from the Disc Navigator Play List menu options.

2 Select the title that you want to divide, then press **ENTER**.

3 Use the playback controls to find the place you want to divide the title.

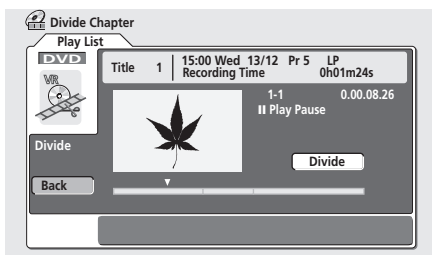

You can use all the usual playback controls, including **▶ PLAY**, **II PAUSE**, scan (**◀◀**, **▶▶**), and slow-motion (**◀II**, **II▶**).

4 With 'Divide' highlighted, press **ENTER** to divide the title at the current playback position.

5 To return to the Disc Navigator menu options, select 'Back' and press **ENTER**.

Combine

VR mode

Use this function to combine two adjacent Play List titles into one.

1 Select 'Combine' from the Disc Navigator Play List menu options.

2 Highlight the bar divider between the two titles you want to combine, then press **ENTER**.

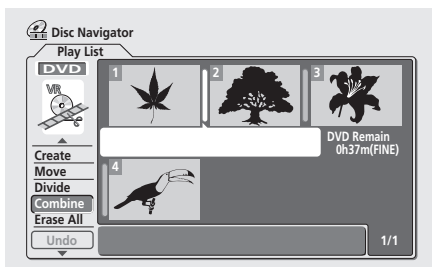

After pressing **ENTER**, the new, updated Play List is displayed.

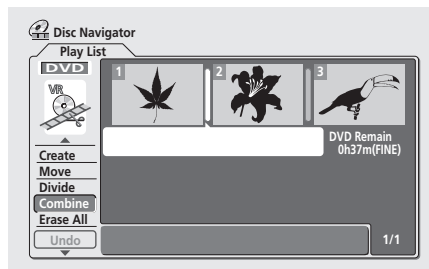

3 Press **RETURN** to go back to the Disc Navigator menu options, or continue combining more titles.

Erase All

VR mode

This command erases all the titles from the Play List.

1 Select 'Erase All' from the Disc Navigator Play List menu options.

2 Select 'Yes' to confirm, or 'No' to cancel, then press **ENTER**.

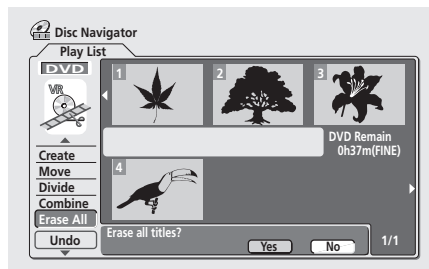

Undo

VR mode

If you make a mistake while editing, you can generally undo it. There are three levels of undo (in other words, you can undo the last three edits you made).

• Select 'Undo' from the Disc Navigator Play List menu options.

- You can't undo anything after ejecting the disc from the recorder or switching the recorder into standby.
- You can't undo the following operations: initializing, recording or finalizing a disc, locking and unlocking titles.

Chapter 9

Disc History

VR mode Video mode

The Disc History screen lets you see how much recording space remains on the last 30 recordable DVD discs loaded. It also displays information such as disc name, the first three title names, number of titles recorded, recording mode and the lock status of the disc.

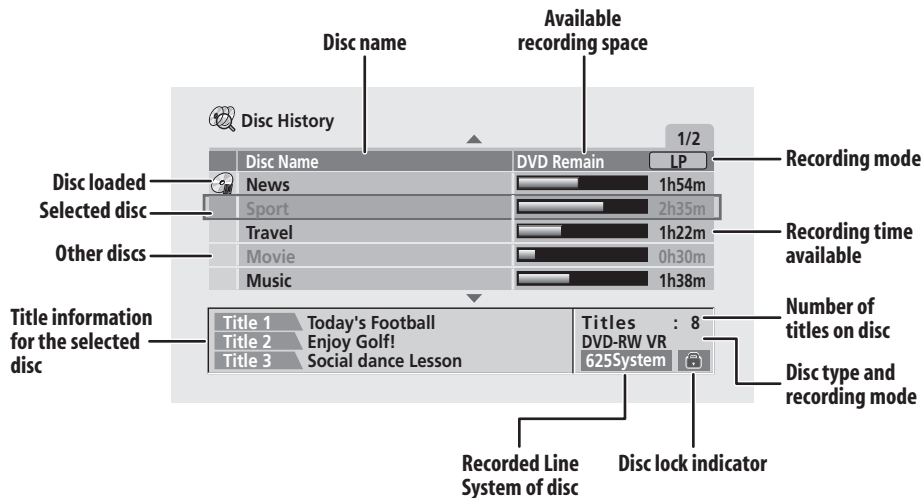

Using the Disc History

1 Press DISC HISTORY to display the Disc History screen.

The most recently loaded disc appears at the top of the list, with previously loaded discs below it. If there is a disc loaded, it is shown in the list with a 'disc in' icon.

- The Disc History screen is also accessible from the Home Menu.

2 Use the ↑/↓ (cursor up/down) buttons to see title information for other discs in the list.

- To remove a disc from the list, press **CLEAR** (you can't remove the currently loaded disc).
- You can see the available recording time for different recording modes by pressing the **REC MODE** button.

3 To exit the Disc History screen, press HOME MENU or DISC HISTORY.

Note

- When you initialize a DVD-RW disc or record a DVD-R disc for the first time, the recorder automatically names the disc **DISC **** (where ** is a number from 1 to 99). You can rename the disc if you want to (see *Input Disc Name* on page 92).
- When you change the display for the available recording time using the **REC MODE** button, only the display is changed; the actual recording mode is not affected.
- The following discs appear in the Disc History list in gray:
 - Discs with no available recording space left
 - Locked discs
 - Discs that contain the maximum 99 titles and/or 999 chapters
 - Discs recorded with a Line Input setting different to the recorder's current setting.
- When a Video mode disc is finalized, the information for that disc disappears from the Disc History.

Chapter 10

The PhotoViewer

From the PhotoViewer you can view JPEG photos and picture files stored on a CD-ROM/R/RW on your TV.

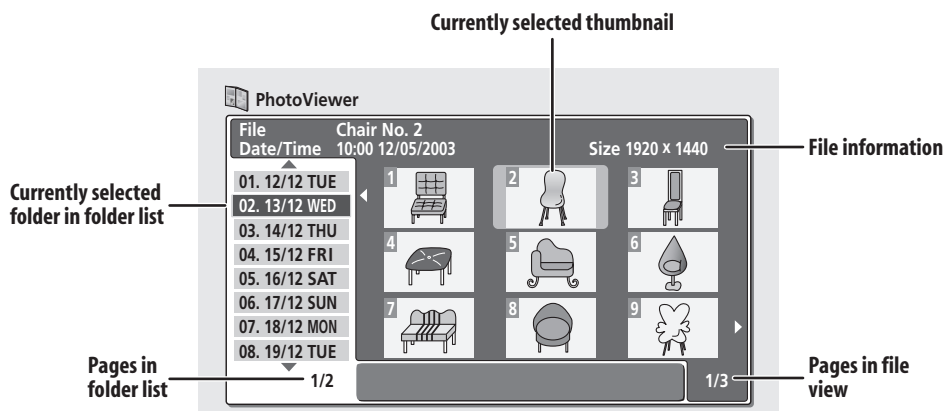

Playing a slideshow

1 Press HOME MENU and select 'PhotoViewer' to display the PhotoViewer screen.

- The PhotoViewer is only accessible when a disc containing JPEG files is loaded.

2 Use the ↑/↓ (cursor up/down) buttons to select a folder from the folder list.

The first nine images from the selected folder are displayed as thumbnails in the main part of the screen.

3 Press ENTER to move to the thumbnail view area.

The first thumbnail image is highlighted.

- To get back to the folder list, press RETURN.

4 Use the ↑/↓/←/→ (cursor buttons) to select a thumbnail.

- Use the ◀◀ and ▶▶ buttons to display the previous/next page of thumbnails.

5 Press ENTER or ► PLAY to start playing a slideshow from the selected thumbnail.

- Use the ◀◀ PREV / NEXT ▶▶ buttons to display the previous/next picture, or the || PAUSE button to pause the slideshow.

6 Press ■ STOP or RETURN to return to the thumbnail view area.

7 To return to the folder view area, press RETURN.

- To exit the PhotoViewer, press HOME MENU.

Note

- Up to 999 files or 99 folders are viewable, but if there are more files/folders than this on the disc it is still possible to view them all using the Reload function (see below).
- The time it takes for the recorder to load a file increases with large file sizes.
- Pictures with an aspect ratio different to your TV screen will appear with black bars top and bottom, or either side (depending on the picture).
- If you encounter a disc that will not play, check that the disc and file formats are compatible with this recorder (see *JPEG file compatibility* on page 10).

Reloading files from a disc

If you have a disc with a large number of files and/or folders, you can still view all the images using the reload function.

1 Use the ↓ (cursor down) button to navigate to the last entry in the folder list ('Read next: ...').

2 Press ENTER to load the next batch of up to 999 files/99 folders from the disc.

It will take a moment (at most a minute) to load in the images.

 **Note**

- You can press **HOME MENU** to exit the PhotoViewer screen while the recorder is reloading images. (If you enter the PhotoViewer again, it will resume reloading.)

Zooming the screen

During a slideshow you can zoom in to enlarge a portion of the picture by a factor of two or four. You can also move the area of the picture displayed.

- During a slideshow, use the **CHANNEL +** button to zoom the picture.

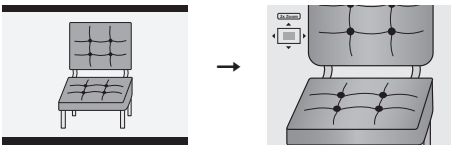

Repeated presses cycle between zoom off, 2x zoom and 4x zoom. The zoom factor is displayed on-screen.

- Use the **↑/↓/←/→** (cursor buttons) to move the zoomed area within the picture.

Rotating the screen

You can rotate the displayed picture during a slideshow so you can always view pictures the right way up, whichever way they were taken.

- During a slideshow, press **ANGLE** to rotate the displayed picture clockwise by 90°.

Press **ANGLE** repeatedly to continue rotating the picture in increments of 90°.



Chapter 11

The Disc Setup menu

From the Disc Setup menu you can name discs, lock the contents to prevent accidental recording and erasure, initialize and finalize discs. The Disc Setup menu is accessed from the Home menu:

- Press **HOME MENU** and select 'Disc Setup'.



DVR-520H/720H Screen

Basic settings

Input Disc Name

VR mode **Video mode**

When you initialize a disc for recording, the recorder automatically assigns a name for the disc ranging from **DISC 1** to **DISC 99**. You can use the Input Disc Name function to change the default disc name to something more descriptive. This name appears when you load the disc and when you display disc information on-screen.

- 1 Select 'Input Disc Name' from the Basic options, then 'Next Screen'.

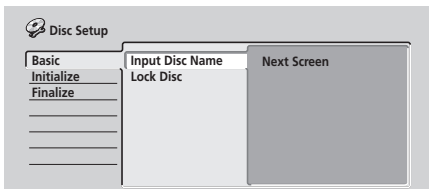

- 2 Input a name for the disc up to 64 characters long for a VR mode disc, or 32 for a Video mode disc.

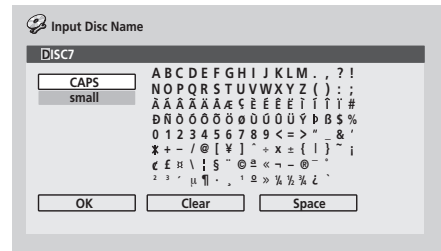

- Use the **↑/↓/←/→** (cursor buttons) and **ENTER** to select characters.
- Use the **◀◀/▶▶** buttons to change the cursor position.
- Select **CAPS** or **small** to change to upper or lower-case, or use the **CASE SELECTION** buttons (**⏪/▶▶**).
- You can also use the **CLEAR** button to delete characters directly (press and hold for two seconds to delete the whole name). For other remote control key shortcuts, see *Using the remote key shortcuts to input a name* on page 80.
- For discs formatted on a different DVD recorder, you will see only a limited character set.

Note

- You cannot input a name for a disc if the TV line system of the disc is different to the current setting of the recorder. See *Input Line System* on page 98 for how to change the recorder's setting.

Lock Disc

VR mode

- Default setting: **Off**

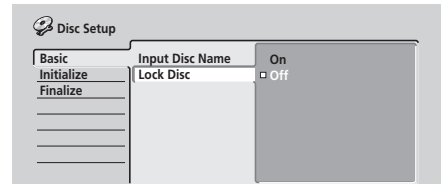

Set to **On** to prevent accidental recording, editing or erasing of the disc loaded. If you need to unlock the disc to make edits, select **Off**.

Important

- A locked disc can still be initialized (which will completely erase the disc).

Note

- You cannot change the lock setting for a disc if the TV line system of the disc is different to the current setting of the recorder. See *Input Line System* on page 98 for how to change the recorder's setting.

Initialize settings

DVD-RW

You can initialize a DVD-RW disc for either VR mode recording or Video mode recording. The first time you load a new DVD-RW disc, it will be automatically initialized for recording according to the DVD-RW Auto Init. setting in the Initial Setup menu (see page 108).

The initialize menu here lets you reinitialize a disc, for example if you want to change the recording format of the disc. See *Initializing a DVD-RW disc* on page 60 for detailed instructions.

HDD Initialize

HDD

When your DVD recorder is working without a problem this option is not visible in the Disc Setup menu. However, if the HDD file system becomes corrupted for some reason, you initialize the HDD to fix the problem. Note that initializing the HDD will erase all the data on it.

- **Select 'Initialize HDD' from the disc Setup menu.**

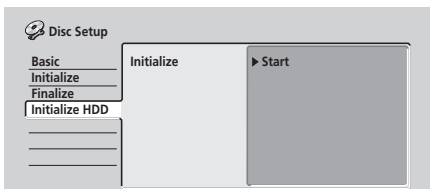

- **Select 'Start' to initialize.**

Finalize settings

Finalize

DVD-R

DVD-RW

Finalizing 'fixes' the recordings in place so that the disc can be played on a regular DVD player or computer equipped with a suitable DVD-ROM drive.

See *Playing your recordings on other DVD players* on page 59 for detailed instructions.

Undo Finalize

DVD-RW

You can undo the finalization on DVD-RW discs recorded on this recorder in Video mode. You need to do this if you want to record more material or edit material already on the disc.

You can also undo the finalization of VR mode discs which have been finalized on other DVD recorders. If when you load a disc the message **This disc cannot be recorded. Undo the finalization** is displayed, use this command to be able to record on the disc using this recorder.

1 From the Disc Setup menu, select 'Finalize', then 'Undo Finalize' from the finalize options.

2 Select 'Start'.

Note

- You cannot finalize a disc or use the Undo Finalize command if the TV line system of the disc is different to the current setting of the recorder. See *Input Line System* on page 98 for how to change the recorder's setting.

Chapter 12

The Video/Audio Adjust menu

Using the Video/Audio Adjust menu you can set up the picture quality for the built-in tuner and external inputs, for disc playback, and for recording.

Setting the picture quality for TV and external inputs

Picture Creation lets you choose a set of picture quality settings for the built-in TV tuner and for each external input. There are several preset settings that suit various sources, or you can create up to three of your own sets.

Choosing a preset

1 With the recorder stopped, press HOME MENU and select 'Video/Audio Adjust'.



DVR-520H/720H screen

2 Select 'Video Adjust'.

3 Use the ←/→ (cursor left/right) buttons to change the preset.

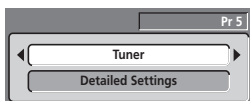

- Use the **INPUT SELECT** button to switch between the built-in TV tuner and the external inputs.
- Use the **CHANNEL +/-** buttons to change the channel of the built-in TV tuner.

There are six presets available:

- **Tuner** – suitable for general TV broadcasts
- **VCR** – suitable for video cassettes
- **LDP** – suitable for Laserdiscs
- **Memory1** – user preset 1
- **Memory2** – user preset 2
- **Memory3** – user preset 3

You can press **DISPLAY** to see the individual settings for the current preset (**Tuner**, **VCR** or **LDP**).

4 Press **ENTER** to select the preset.

Creating your own set

There are three user presets in which you can save your own set of picture quality settings.

1 Follow *Choosing a preset* above and select one of the user presets (**Memory 1, 2 or 3**).

2 Select 'Detailed Settings'.

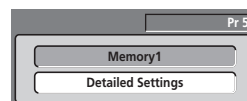

3 Use the ↑/↓ (cursor up/down) buttons to select the picture quality setting you want to adjust.

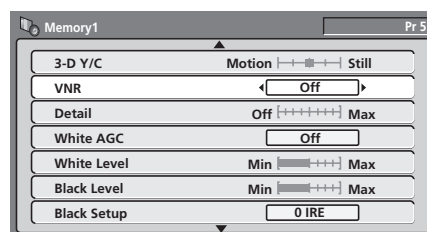

You can adjust the following settings:

- **3-D Y/C** – Adjusts the brightness/colour separation (NTSC video only).
- **VNR** – Adjusts the amount of noise reduction applied to the video signal.
- **Detail** – Adjusts how sharp edges appear.
- **White AGC** – Turn on for automatic white level adjustment.
- **White Level** – Adjusts the intensity of white.
- **Black Level** – Adjusts the intensity of black.
- **Black Setup** – Corrects the standard reference black level (NTSC video only).
- **Hue** – Adjusts overall balance between red and green.
- **Chroma Level** – Adjusts how rich the colours appear.

4 Use the **←/→** (cursor left/right) buttons to adjust the currently selected picture quality setting.

5 When you have all the settings as you want them, press **HOME MENU** to exit.

You can now use the preset for any other input or the built-in TV tuner.



Tip

- To see more of the picture as you adjust different settings, press **ENTER** after selecting the setting you want to adjust.



Note

- DVR-520H/720H only: When the DV input is selected, only **VNR** and **Detail** settings can be adjusted.
- When **White AGC** is **On**, the **White Level** setting can't be adjusted.
- The **3-D Y/C** and **Black Setup** settings apply only to NTSC video input.

Setting the picture quality for disc playback

This setting determines how the picture will look when playing discs.

Choosing a preset

1 With a disc playing (or paused), press **HOME MENU** and select 'Video/Audio Adjust'.

2 Select 'Video Adjust'

3 Use the **←/→** (cursor left/right) buttons to change the setting.

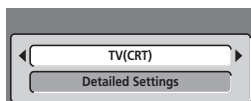

There are six presets available:

- **TV(CRT)** – suitable for standard cathode-ray tube TVs
- **PDP** – suitable for plasma display screens
- **Professional** – suitable for professional monitors
- **Memory1** – user preset 1
- **Memory2** – user preset 2
- **Memory3** – user preset 3

You can press **DISPLAY** to see the individual settings for the current preset (**TV(CRT)**, **PDP** or **Professional**).

4 Press **ENTER** to select the preset.

Creating your own set

There are three user presets in which you can save your own set of picture quality settings for disc playback.

1 Follow *Choosing a preset* above and select one of the user presets (**Memory 1, 2 or 3**).

2 Move the cursor down and select 'Detailed Settings'.

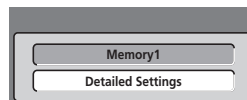

3 Select the picture quality setting you want to adjust.

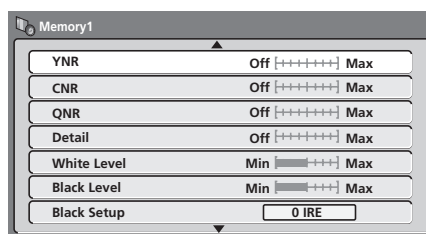

You can adjust the following settings:

- **YNR** – Adjusts the amount of noise reduction (NR) applied to the Y (brightness) component.
- **CNR** – Adjusts the amount of noise reduction (NR) applied to the C (colour) component.
- **QNR** – Adjusts the amount of noise reduction (NR) applied to the block noise.
- **Detail** – Adjusts how sharp edges appear.
- **White Level** – Adjusts the intensity of white.
- **Black Level** – Adjusts the intensity of black.
- **Black Setup** – Corrects the standard reference black level (NTSC video only).
- **Hue** – Adjusts overall balance between red and green.
- **Chroma Level** – Adjusts how rich the colours appear.

4 Use the **←/→** (cursor left/right) buttons to adjust the currently selected picture quality setting.

5 When you have all the settings as you want them, press **HOME MENU** to exit.



Tip

- To see more of the picture as you adjust different settings, press **ENTER** after selecting the setting you want to adjust.

 **Note**

- The **Black Setup** setting applies only when playing NTSC discs.

Audio DRC

- Default setting: **Off**

When watching Dolby Digital material at low volume, it's easy to lose low level sounds completely—including some of the dialog. Switching on Audio DRC (Dynamic Range Control) can help by bringing up the low level sounds, while controlling high level peaks.

- 1 During playback or when paused, press HOME MENU and select 'Video/Audio Adjust'.**
- 2 Select 'Audio Adjust'.**
- 3 Use the ←/→ (cursor left/right) buttons to adjust DRC from 'Off' to 'Max'.**

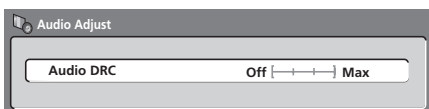

Exactly how much difference you can hear between the settings will depend on the material.

 **Remember**

- Audio DRC is not effective when listening to a disc via the digital output when **Dolby Digital Out** is set to **Dolby Digital**. In this case adjust the dynamic range from your AV amplifier/receiver.

Chapter 13

The Initial Setup menu

Using the Initial Setup menu

The Initial Setup menu is where you can set various recorder options for sound, picture, language and so on.

- Press HOME MENU and select 'Initial Setup'.



DVR-520H/720H screen

- Some settings can only be changed when the recorder is stopped. During playback these settings are grayed out in the Initial Setup menu.
- Except for the Setup Navigator, menu screens are exited automatically after 20 minutes of inactivity.

Basic settings

Clock Setting

The date (day, month, year) and time must be set before you can use any of the timer recording features.

The clock can be set automatically if there is a broadcast station transmitting clock signals, or manually.

Select **Auto** to set the clock automatically or **Manual** to display the clock setting screen.

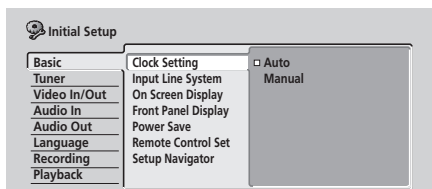

- **Auto clock setting**

Some TV channels broadcast time signals together with the program. This recorder can use these signals to set the clock automatically.

Set 'Clock Set CH' to the channel preset number that broadcasts a clock signal, then move the cursor down to 'Start' and press ENTER.

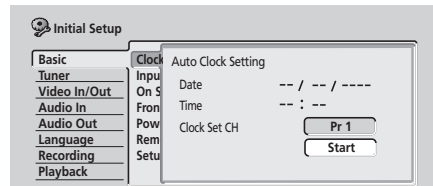

If the time could not be set automatically, press **RETURN** to go back to the previous screen and select **Manual**.

- **Manual clock setting**

If no stations in your area are broadcasting time signals, you can set the clock manually:

Set your time zone.

You can set this by selecting a city or a time relative to GMT.

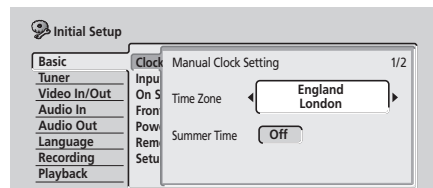

Move the cursor down and select 'On' for summer time if you are currently on summer time, then press ENTER.

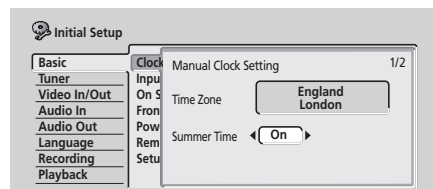

Set the date (day/month/year) and time, then press ENTER to make all the settings.

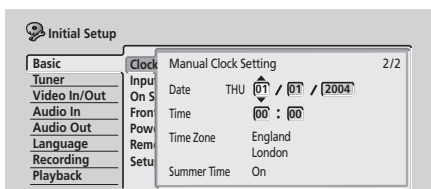

Use the \uparrow/\downarrow (cursor up/down) buttons to change the value in the highlighted field.

Use the \leftarrow/\rightarrow (cursor left/right) buttons to move from one field to another.

Input Line System

- Default setting: **625System**

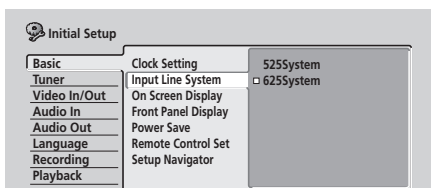

For standard PAL or SECAM recording, leave the input line system to **625System**. When recording an NTSC or PAL-60 signal through an external input, change to **525System**.

Note

- When the current input is a built-in tuner channel preset, changing the input line system will usually also affect the input line system of the **AV2/AUTO START REC (INPUT 1/DECODER)** input. However if the **AV2/L1 In** setting is set to **Decoder** (see *AV2/L1 In* on page 102), then the L2 input is affected instead.
- If when this setting is changed, the screen goes blank (due to incompatibility with your TV), you can switch back by pressing and holding the front panel **+** button then pressing **DVD** (also front panel) while the recorder is stopped.
- When you switch the Line Input System setting the Copy List is erased. If you switch the setting using the **+** button and **DVD** buttons as described above, there is no confirmation, so please use with care.
- You can't mix recordings of different TV line systems on the same disc.
- When you change this setting, the **Input Colour System** setting also changes (see *Input Colour System* on page 102).

On Screen Display

- Default setting: **On**

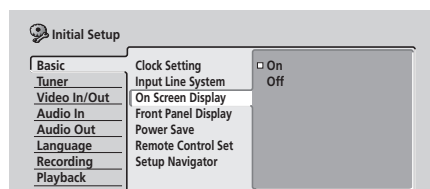

On the default setting, the recorder shows on-screen operation displays (**Play**, **Stop** and so on). Change to **Off** to hide these displays.

Front Panel Display

- Default setting: **On**

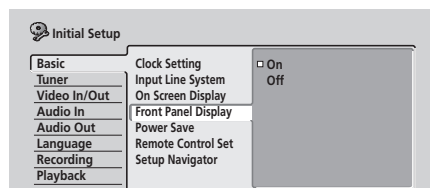

On the default setting, the time is shown in the front panel display when the recorder is in standby. Switch to **Off** to have the front panel display switch off completely when in standby.

Note

- When set to **Off**, the display still lights dimly in standby when setting a timer recording, or during Auto Start Recording.

Power Save

- Default setting: **Off**

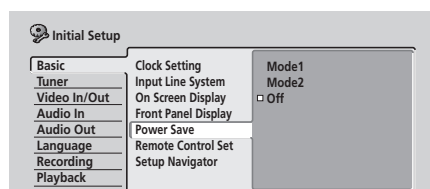

When set to **Off**, signals arriving at the **ANTENNA IN** terminal and at the **AV2/AUTO START REC (INPUT 1/DECODER)** AV connector are passed through to the **ANTENNA OUT** terminal and to the **AV1(RGB)-TV AV** connector, respectively, when the recorder is in standby.

You can cut the standby power consumption of the recorder by turning off the through function for one or both terminals:

- **Mode1** – Through function only for the antenna terminal
- **Mode2** – No through function
- **Off** – Through function for both antenna terminal and AV connector

Note

- When a timer recording is set with VPS/PDC on, SCART through is always active.

Remote Control Set

- Default setting: **Recorder1**

You only need to set this if you are using more than one Pioneer DVD recorder in the same room.

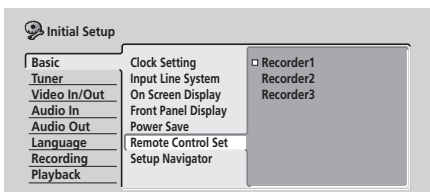

So that each remote control operates only its own recorder, make this setting different for each recorder and remote in the room.

There are three different recorder IDs. When set to **Recorder2** or **Recorder3**, the remote control mode is shown in the front panel display.

After selecting a new recorder ID, you have to confirm the change by selecting **Yes** or **No** (use the **←/→** (cursor left/right) buttons), then pressing **ENTER**.

Note that as soon as you change the recorder ID, the remote becomes inoperative until you change the remote to the same ID.

To set the remote, press and hold **RETURN** and a number button (**1**, **2** or **3**) until the indicator on the remote lights.

Setup Navigator

- Default setting: *n/a*

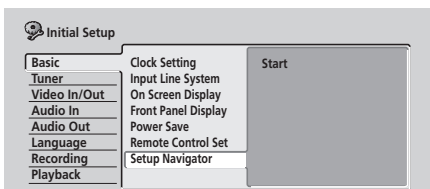

The Setup Navigator appears automatically when you switch on the recorder for the first time (or after resetting the recorder). It is also available from the Initial Settings menu should you need it at any other time.

See also *Switching on and setting up* on page 25.

Tuner settings

Auto Channel Setting : Auto Scan

This recorder has a built-in TV tuner for recording PAL B/G, PAL I, SECAM L and SECAM D/K TV programs off the air or from analog cable TV. We recommend that you first use the Auto Channel Setting described here to tune into the channels in your area, then if there are any unwanted channels, you can disable them using Channel Skip (described below).

- 1 Choose 'Tuner' from the Initial Setup menu, then 'Auto Channel Setting', then 'Auto Scan'.

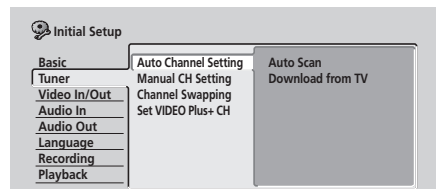

- 2 Select your country then press ENTER to start tuning.

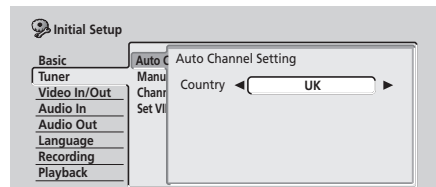

- You can cancel before auto tuning has finished by pressing **ENTER** again.

After auto scanning has finished, the channel mapping screen appears showing which channels have been assigned to which program numbers.

Pr	System	CH	Name	Pr	System	CH	Name
1	I	26		9	I	9	
2	I	33		10	I	25	
3	I	23		11	I	11	
4	I	30		12	I	12	
5	I	37		13	I	13	
6	I	35		14	I	14	
7	I	39		15	I	15	
8	I	26		16	I	16	

Use the **PREV/NEXT** buttons to display the previous/next page.

- 3 Press **HOME MENU** to exit this screen.

Note

- You can fine-tune individual stations using the **Manual CH Setting** feature. See *Manual CH Setting* below for how to use this.

Auto Channel Setting : Download from TV

If you connected this recorder to your TV using the **AV1(RGB)-TV** AV connector, and if your TV supports this function, you can download all the channels that your TV is tuned to. Check your TV's instruction manual for more details.

1 Choose 'Download from TV'.

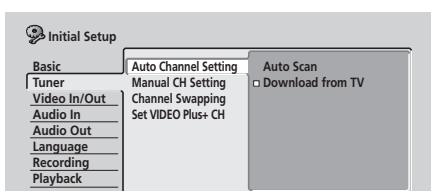

2 Select your country.

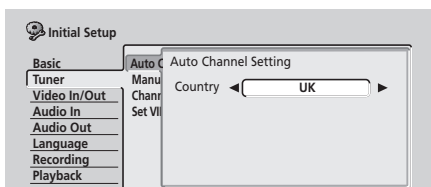

3 Press ENTER to start downloading.

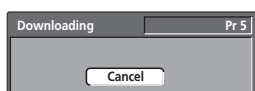

After downloading has finished, the channel mapping screen appears showing which channels have been assigned to which program numbers.

Tip

- If the channel tuning information is updated in the TV, the recorder will automatically download the new information.

Manual CH Setting

The channel skip function lets you skip channels where there is no station so that as you change channels using the **CHANNEL +/-** buttons or the number buttons, you only change to channels that have a station.

The manual tuning function allows you to manually tune to stations, should you need to.

1 Select 'Manual CH Setting', then 'Next Screen'.

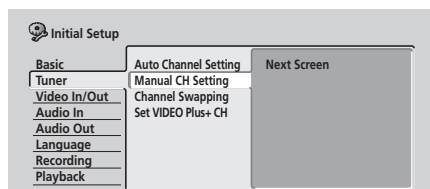

Press **ENTER** to go to the country setting screen.

2 Select your country.

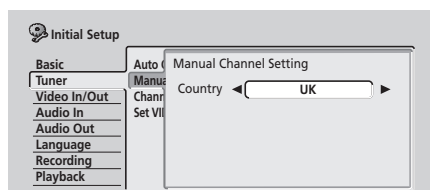

3 Press ENTER to go to the manual channel setting screen.

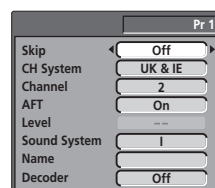

- Use the **CHANNEL +/-** buttons or the number buttons to change channels.

From this screen there are eight parameters you can set:

- Skip** – If you want to skip the displayed channel (because there is no station assigned to that channel), change the **Skip** setting to **On**.
- CH System** – Set the channel system used in your area or region.
- Channel** – Change the channel number assigned to the current preset.
- AFT** (Auto Fine Tune) – When set to **On**, the station is automatically tuned; set to **Off** to manually fine tune (see below).
- Level** – Set the AFT level (see above).
- Sound System** – Set the sound system used for the current channel.
- Name** – Move the cursor right then input a name for the current station, (up to five characters) then press **ENTER**.
- Decoder** – If the current channel is scrambled, requiring a decoder connected to the **AV2/AUTO START REC (INPUT 1/DECODER)** connector, set this to **On**. (See also *AV2/L1 In* on page 102.)

Channel Swapping

The preset swap feature lets you swap the channel assignments of different programs. This is so that you can group together station presets which naturally go together.

1 Select 'Channel Swapping'.

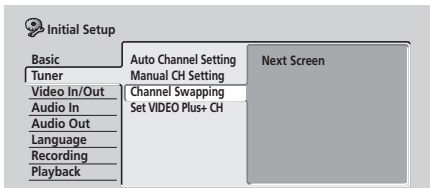

2 Select 'Next Screen' to go to the swap presets screen.

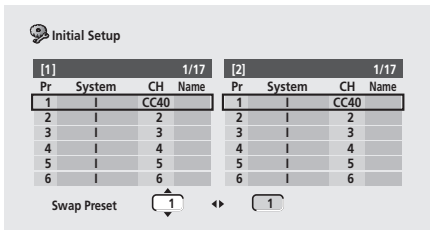

3 Use the ↑/↓ (cursor up/down) buttons to select a preset station to swap.

- Use the **PREV/NEXT** buttons to display the previous/next page.

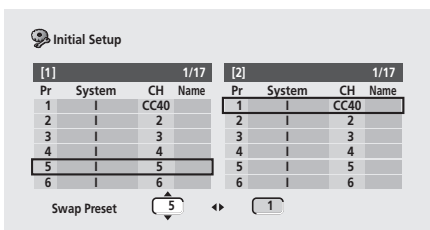

4 Press → (cursor right), then select a preset station to swap with the first preset.

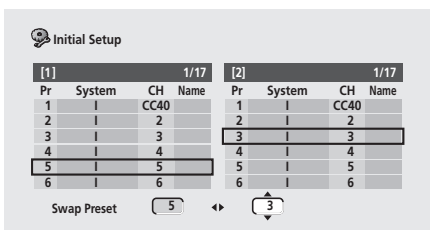

5 Press ENTER to swap the presets.

6 If you want to swap more presets, press ← (cursor left), then repeats steps 3 to 5.

7 Press HOME MENU to finish and exit.

Set VIDEO Plus+ CH

- Default setting: *n/a*

Guide channels are used by the VIDEO Plus+ system so that the channel number specified in the PlusCode programming numbers can be guaranteed to correspond to the correct station.

1 Select 'Set VIDEO Plus+ CH', then 'Next Screen'.

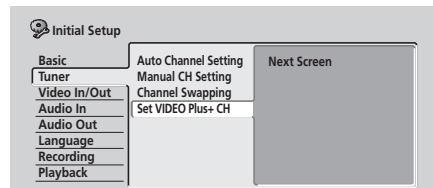

2 Assign channel numbers to the guide channels as necessary.

Look in your TV guide to see which channel numbers should be assigned to which guide channels.

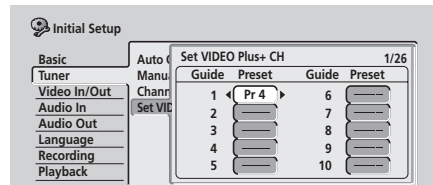

- Use the ↑/↓ (cursor up/down) buttons to change the guide channel for setting.
- Use the ←/→ (cursor left/right) buttons to change the channel number.
- Use the **PREV / NEXT** button to display the previous/next 10 guide channels.

3 To return to the Initial Setup menu, press ENTER.

Video In / Out settings

Input Colour System

- Default setting: **Auto**

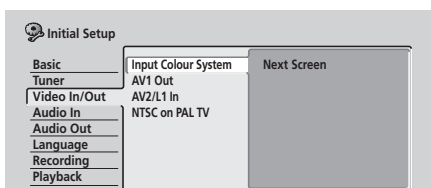

On the default setting, the recorder automatically detects whether the video signal from the built-in tuner or from one of the external inputs is PAL, SECAM, 3.58 NTSC or PAL-60. You may, however, occasionally need to set it manually if the picture is not displayed properly.

- 1 Select 'Input Colour System', then 'Next Screen'.
- 2 Use the CHANNEL +/- buttons or the INPUT SELECT button to switch between the built-in tuner and the external inputs.
- 3 Use the ←/→ (cursor left/right) buttons to change the input colour system for the current input or built-in tuner.

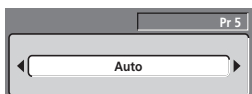

- The available settings depend on the Input Line System setting (see *Input Line System* on page 98). The table below shows the different options available.

Input Line System	Built-in tuner	External input
625 System	Auto	Auto
	PAL	PAL
	SECAM	SECAM
525 System	n/a	Auto
		3.58 NTSC
		PAL-60

AV1 Out

- Default setting: **Video**

You only need to make this setting if you connected this recorder to your TV using the **AV1(RGB)-TV SCART AV connector**.



Important

- If you make a setting here that is incompatible with your TV, the TV may not display any picture at all. If this happens either switch everything off and reconnect to the TV using either the supplied video cable, or an S-video cable (see *Using the S-video output* on page 15 for more on this), or reset the recorder (see *Resetting the recorder* on page 112 for how to do this).

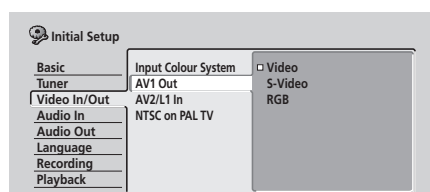

- **Video** – Compatible with all TVs, but lowest quality of the three AV settings.
- **S-Video** – Almost the same quality as RGB, but can give better results if you are using a long SCART cable.
- **RGB** – If your TV is compatible, this setting gives the best picture quality.

AV2/L1 In

- Default setting: **Video**

You only need to make this setting if you connected this recorder to another component using the **AV2/AUTO START REC (INPUT 1/DECODER) AV connector**.

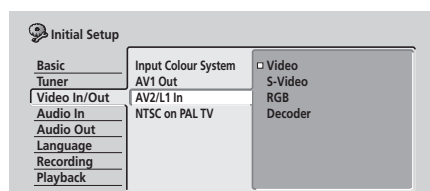

The **AV2/AUTO START REC (INPUT 1/DECODER)** connector input can be set to one of the following settings:

- **Video** – Sets the input signal type to composite video.
- **S-Video** – Sets the input signal type to S-video.
- **RGB** – Sets the input signal type to RGB video.

- **Decoder** – Use this setting if you are using a decoder connected to the **AV2/AUTO START REC (INPUT 1/ DECODER)** input. (For scrambled channels, make sure that the manual channel **Decoder** setting is set to **On**—see also *Manual CH Setting* on page 100). Note that on this setting, it is not possible to use Auto Start Recording.

Note

- When the **Input Line System** setting is set to **525 System**, **RGB** can't be selected.
- When the **Input Line System** setting is set to **625 System**, **RGB** can be selected, but if the **Input Line System** is then changed to **525 System**, the **AV2/L1 In** setting automatically changes to **Video**.
- See also *Input Line System* on page 98.

NTSC on PAL TV

- Default setting: **On**

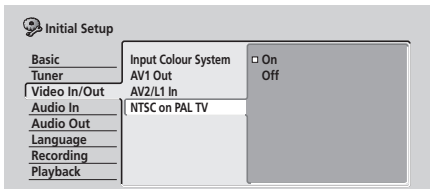

When set to **On**, NTSC discs (from the U.S., for example) will play correctly on a PAL-only TV. Change to **Off** if your TV is already NTSC-compatible.

Depending on this setting and the Input Line System setting (see *Input Line System* on page 98), the signal format output when the recorder is stopped varies as shown in the table below.

Input Line System	NTSC on PAL TV	Output when stopped
625 System	Off	PAL
	On	PAL
525 System	Off	NTSC
	On	PAL-60

Note

- Many recent PAL TVs are capable of correctly displaying NTSC pictures without the need for this setting. Check the manual that came with your TV if you're not sure whether yours has this feature.

Audio In settings

NICAM Select

- Default setting: **NICAM**

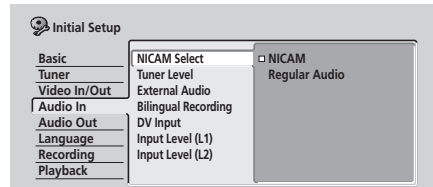

If you want to record the non-NICAM audio in a TV broadcast, select **Regular Audio**, otherwise set to **NICAM**. (When set to **NICAM**, you can still select **Regular Audio** using the **AUDIO** button. See *Changing audio channels* on page 29.)

Tuner Level

- Default setting: **Normal**

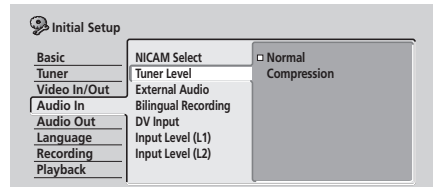

Set to **Compression** if the audio level from the built-in tuner is excessively high causing distortion.

External Audio

- Default setting: **Stereo**

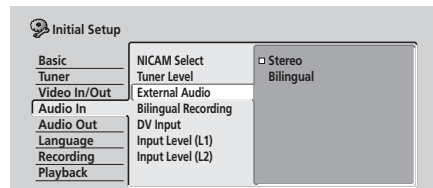

If the external source is standard stereo, leave set to **Stereo**. If each channel carries a separate soundtrack, change to **Bilingual**.

DVR-520H/720H only: When the external audio is from the DV input, an audio subcode channel within the DV audio tells the recorder whether the audio is stereo or bilingual. This has priority over the setting you make here.

Bilingual Recording

- Default setting: **A/L**

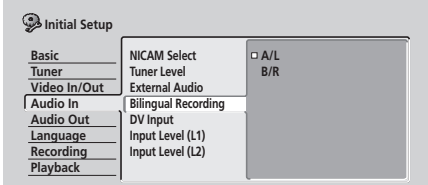

When recording a bilingual source from an external input in Video mode or VR mode set to **FINE/MN32**, or to the HDD, you can choose to record either the **A/L** (left), or the **B/R** (right) audio channel.

Note

- If you're recording in VR mode (except when set to **FINE/MN32**), both channels will be recorded and you can switch them as you like on playback.

DV Input (DVR-520H/720H only)

- Default setting: **Stereo1**

You need to set this if you have a camcorder using 32kHz/12-bit sound connected to the front panel **DV IN/OUT** jack.

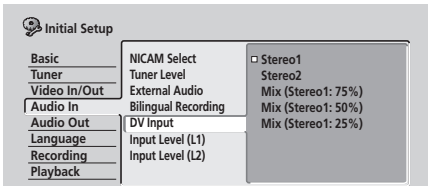

Some digital camcorders have two stereo tracks for audio. One is recorded at the time of shooting; the other is for overdubbing after shooting.

On the **Stereo1** setting, the sound that was recorded while shooting is used. On the **Stereo2** setting, the overdubbed sound is used. You can also choose a **Mix** setting of 25%, 50% or 75% for the Stereo 1 with a corresponding Stereo 2 setting of 75%, 50% or 25%.

Input Level (L1 / L2)

- Default setting: **0dB**

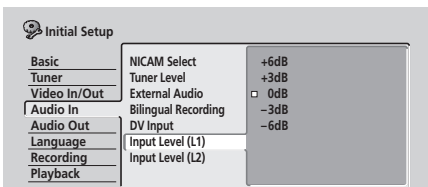

You can adjust the gain of the audio from each external input individually, from **-6dB** to **+6dB** in steps of 3 dB to optimize the recorded audio level.

Audio Out settings

Digital Out

- Default setting: **On**

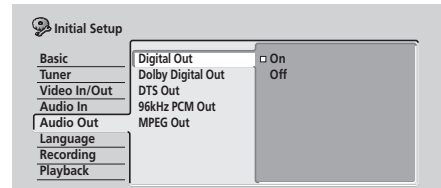

If at any time you need to switch off the digital audio output, set this to **Off**, otherwise leave it **On**.

Note

- When set to **Off**, all the other **Audio Out** settings are grayed out and can't be set.

Dolby Digital Out

You only need to make this setting if you connected this recorder to an AV amp/receiver (or other component) using the digital output.

- Default setting: **Dolby Digital**

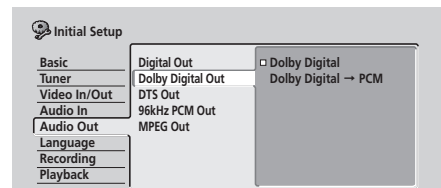

If your AV amp/receiver (or other connected component) is Dolby Digital compatible, set to **Dolby Digital**, otherwise set to **Dolby Digital → PCM**. Check the manual that came with the connected component if you're unsure whether it is Dolby Digital compatible.

DTS Out

You only need to make this setting if you connected this recorder to an AV amp/receiver (or other component) using the digital output.

- Default setting: **On**

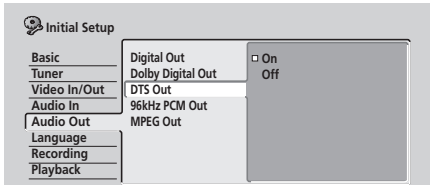

If your AV amp/receiver (or other connected component) has a built-in DTS decoder, set to **On**, otherwise set to **Off**. Check the manual that came with the connected component if you're unsure whether it is DTS compatible.

Important

- If you set to **On** with a non-DTS compatible amp/receiver, noise will be output when you play a DTS disc.
- When set to **On**, there is no analog audio output when playing a DTS DVD-Video disc.
- When playing a DTS audio CD (even when **DTS Out** is **Off**), noise is output from the analog outputs. *Do not play this through your amplifier and speakers.*
- When playing a DTS audio CD, make sure that **Stereo** is selected using the **AUDIO** button. See *Switching audio channels* on page 44.

96kHz PCM Out

You only need to make this setting if you connected this recorder to an AV amp/receiver (or other component) using the digital output.

- Default setting: **96kHz → 48kHz**

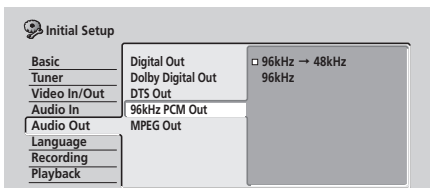

If your AV amp/receiver (or other connected component) is compatible with high sampling rate audio (88.2 / 96 kHz), set to **96kHz**, otherwise set to **96kHz → 48kHz**. Check the manual that came with the connected component if you're unsure whether it is compatible with high sampling rate audio.

MPEG Out

You only need to make this setting if you connected this recorder to an AV amp/receiver (or other component) using the digital output.

- Default setting: **MPEG → PCM**

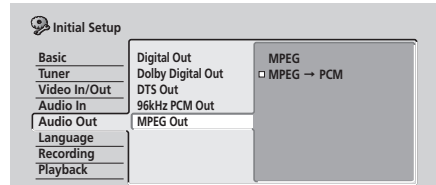

If your AV amp/receiver (or other connected component) is MPEG audio compatible, set to **MPEG**, otherwise set to **MPEG → PCM**. Check the manual that came with the connected component if you're unsure whether it is MPEG compatible.

Language settings

OSD Language

- Default setting: **English**

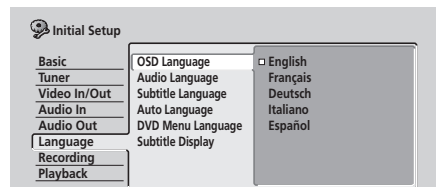

This sets the language of the on-screen menus and displays.

Audio Language

- Default setting: **English**

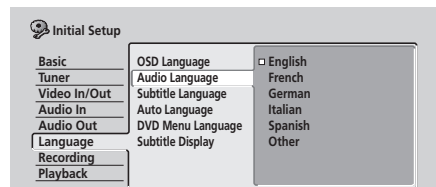

This setting is your preferred audio language for DVD discs. If the language you specify here is recorded on a disc, the recorder automatically plays the disc in that language (although this depends on the **Auto Language** setting—see *Auto Language* on page 106).

Choose **Other** if you want to specify a language other than those listed (see *Selecting 'Other' languages* on page 107).



Tip

- You can switch between the languages recorded on a DVD disc any time during playback using the **AUDIO** button. (This does not affect this setting.)

Subtitle Language

- Default setting: **English**

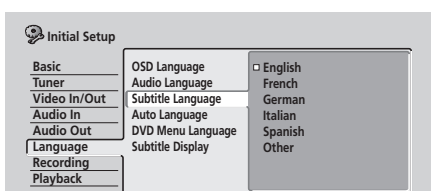

This setting is your preferred subtitle language for DVD discs. If the language you specify here is recorded on a disc, the recorder automatically plays the disc with those subtitles (although this depends on the **Auto Language** setting—see *Auto Language* below).

Choose **Other** if you want to specify a language other than those listed (see *Selecting 'Other' languages* on page 107).



Tip

- You can change or switch off the subtitles on a DVD disc any time during playback using the **SUBTITLE** button. (This does not affect this setting.)

Auto Language

- Default setting: **On**

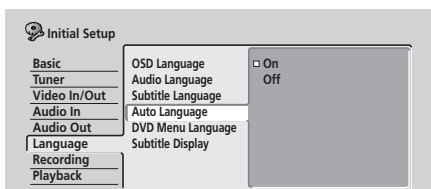

When set to **On**, the recorder selects the default audio language on a DVD disc (French dialog for a French movie, for example), and displays subtitles in your preferred subtitle language only if that is set to something different. In other words, movies in your native language won't have any subtitles, while foreign language movies will be shown with subtitles.

Set to **Off** to have the recorder play discs strictly according to your **Audio Language** and **Subtitle Language** settings.

For **Auto Language** to work, the **Audio Language** and **Subtitle Language** settings must be the same—see *Audio Language* on page 105 and *Subtitle Language* above.



Note

- Even when set to **On**, Auto Language may not work with some discs. In this case, set the audio and subtitle languages using the **AUDIO** and **SUBTITLE** buttons.



Tip

- You can still switch audio and subtitle languages on playback using the **AUDIO** and **SUBTITLE** buttons.

DVD Menu Language

- Default setting: **w/Subtitle Language**

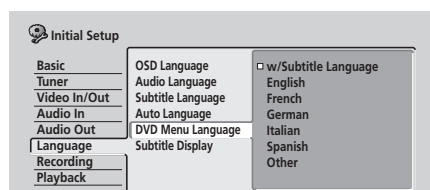

Some multilingual discs have disc menus in several languages. This setting specifies in which language the disc menus should appear. Leave on the default setting for menus to appear in the same language as your **Subtitle Language**—see *Subtitle Language* above.

Choose **Other** if you want to specify a language other than those listed (see *Selecting 'Other' languages* on page 107).

Subtitle Display

- Default setting: **On**

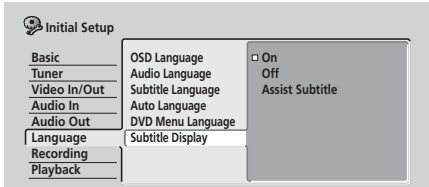

When set to **On**, the recorder displays subtitles according to the **Subtitle Language** and **Auto Language** settings. Set to **Off** to switch subtitles off altogether (although you may find that some discs override this setting). Set to **Assist Subtitle** to have the recorder display the extra assistive subtitles recorded on to some DVD discs.

Selecting 'Other' languages

1 Select 'Other' from the language list.

This option appears in the settings for DVD Menu Language, Audio Language, and Subtitle Language.

2 Select the language you want.

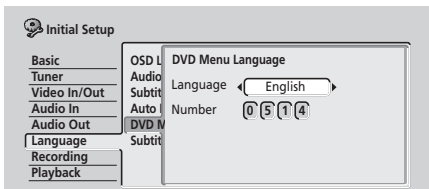

- Select by language name: Use the \leftarrow/\rightarrow (cursor left/right) buttons to change the language.
- Select by code number: Press \downarrow (cursor down) then use the number buttons to enter the four-digit language code.

See *Language code list* on page 119 for a list of available languages and corresponding codes.

3 Press ENTER to confirm and exit the screen.

Recording settings

Manual Recording

- Default setting: **Off**

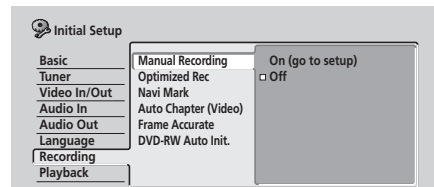

On the default setting there are four different recording time/picture quality settings, **FINE**, **SP**, **LP** and **EP**. If you want to create a custom setting, switch on Manual Recording and select one of the 32 manual settings.

When recording, you can select your Manual Recording setting using the **REC MODE** button.

1 Select 'On (go to setup)' to display the manual recording setting screen.

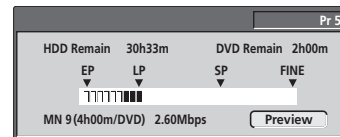

2 Use the \leftarrow/\rightarrow (cursor left/right) buttons to change the manual recording level.

- You can also use the \ll and \gg buttons to cycle between levels **MN1**, **MN9**, **MN21** and **MN32**.
- To preview the recording quality, press \downarrow (cursor down) and select **Preview**. To return to the level adjust screen, press **ENTER**.

3 Press ENTER to set the manual recording level and return to the menu screen.

Note

- The preset picture quality settings correspond to the following manual settings: **FINE**: **MN32**, **SP**: **MN21**, **LP**: **MN9**, **EP**: **MN1**.
- See *Manual recording modes* on page 118 for detailed information on the manual recording levels.

Optimized Rec

- Default setting: **Off**

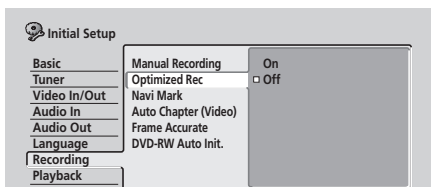

On the default setting, if a timer program (standard, easy or VIDEO Plus+ programming system) is set but there isn't enough space on the disc at the recording quality set, the recording will start, but it will be cut off when the disc is full. Set **Optimized Rec** to **On** to have the recorder automatically adjust the recording quality to fit the available disc space.

Note

- You may notice a reduction in picture quality if the recorder has to fit a lot of extra material into the remaining time available on the disc.
- If, even on recording level **MN 1**, there is insufficient space available on the disc, the recording is made on the HDD at the quality setting you originally specified.
- Optimized Recording only compensates for the first (earliest starting) timer program if more than one has been set.
- Optimized recording works only with DVD recordings.
- Optimized recording can't be used together with VPS/PDC.

Navi Mark

- Default setting: **0 seconds**

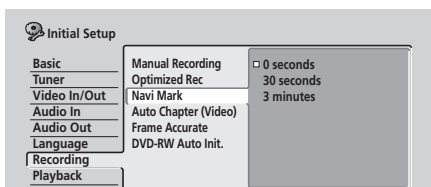

In the Disc Navigator, each title is shown with a still frame picture to remind you what it is. This setting lets you decide the default still frame. The default setting of **0 seconds** takes the first frame of the title, but you can also set it to **30 seconds** or **3 minutes** into the title (if the title is shorter than the setting, then the first frame is used).

Auto Chapter (Video)

- Default setting: **10 minutes**

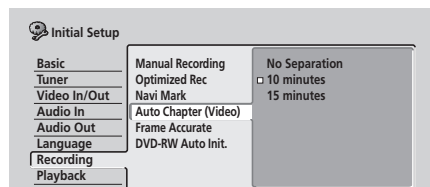

When recording in Video mode, a new chapter is started every 10 minutes on the default setting. You can change this interval to **15 minutes**, or switch off automatic chapter marking altogether with the **No Separation** setting.

Frame Accurate

- Default setting: **Off**

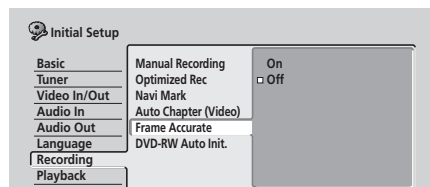

When Frame Accurate setting is **Off**, exact frame accuracy is traded for high-speed copying when recording a Copy List. Switch Frame Accurate **On** to preserve the accuracy of the Copy List. However, copying some edited Video mode titles will be done in real time.

Important

- When you change this setting the Copy List is erased. Make sure it is set how you want it before you start putting together a Copy List.
- The Frame Accurate setting has no effect on the actual video content stored on the HDD.

DVD-RW Auto Init.

- Default setting: **VR Mode**

When you load a new, blank DVD-RW disc the recorder automatically initializes it for recording. You can set it to initialize the disc for **VR mode** or **Video mode** recording.

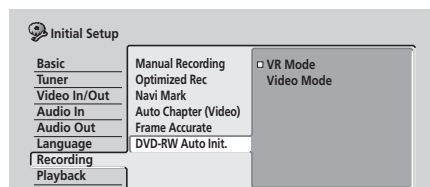

Playback settings

TV Screen Size

- Default setting: **4:3 (Letter Box)**

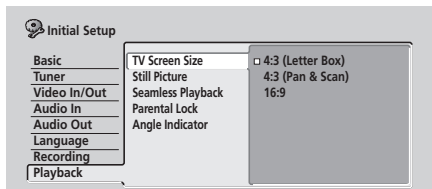

If you have a widescreen TV, select the **16:9** setting—widescreen DVD software is then shown using the full screen area. When playing software recorded in conventional (4:3) format, the settings on your TV will determine how the material is presented—see the manual that came with your TV for details on what options are available.

If you have a conventional TV, choose either **4:3 (Letter Box)** or **4:3 (Pan & Scan)**. In Letter Box mode, widescreen software is shown with black bars at the top and bottom of the screen. Pan & Scan chops the sides off widescreen material to make it fit the 4:3 screen (so even though the picture looks larger on the screen, you're actually seeing less of the movie). See *Screen sizes and disc formats* on page 113 for more information.

Still Picture

- Default setting: **Auto**

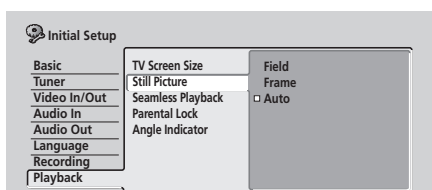

The recorder uses one of two processes when displaying a still frame from a DVD disc. The default **Auto** setting automatically chooses the best setting each time.

- **Field** – produces a stable, generally shake-free image.
- **Frame** – produces a sharper image, but more prone to shake than field stills.

Seamless Playback

VR mode **HDD**

- Default setting: **Off**

During playback of a VR mode Play List, you may notice momentary interruption in the picture at edited points. The Seamless Playback feature lets you trade-off accuracy of the edit points for more seamless playback. When switched **On**, you may notice that the edit points are a few frames earlier or later than you set.

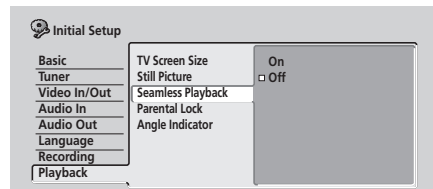

Parental Lock

- Default level: **Off**
- Default password: *none*
- Default Country code: **us (2119)**

Some DVD-Video discs feature a Parental Lock level. If the recorder is set to a lower level than the disc, it will require you to enter a password before the disc will play. This gives you some control about what your children watch on your DVD recorder.

Some discs also support the Country code feature. The recorder does not play certain scenes on these discs depending on the Country code you set.

Before you can set the Parental Lock level or the Country code you must set a password. As the password owner you can change the Parental Lock level or Country code whenever you like. You can also change the password.

Note

- Not all discs that you may consider inappropriate for your children use the Parental Lock feature. These discs will always play without requiring the password first.
- If you forget the password, you can reset the recorder to its factory settings (see *Resetting the recorder* on page 112), then set a new password.

Parental Lock : Set Password

The password you set will enable you to change the Parental Lock level and Country code setting. It is also the password that you will need to enter if you want to play a disc with a parental lock level higher than the recorder.

1 Select 'Set Password'.

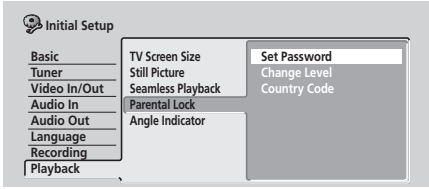

2 Use the number buttons to input a four-digit password.

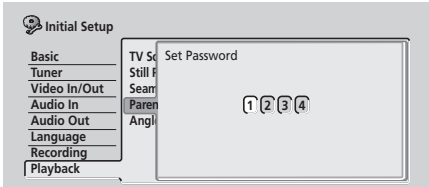

3 Press ENTER to set the password.

Parental Lock : Change Password

To change your password, confirm your existing password then enter a new one.

1 Select 'Change Password'.

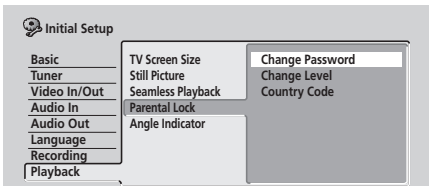

2 Use the number buttons to enter your existing password.

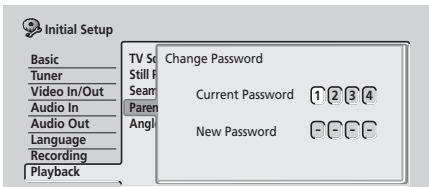

3 Press ENTER.

4 Enter a new password.

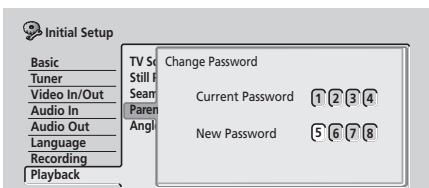

5 Press ENTER.

Parental Lock : Change Level

1 Select 'Change Level'.

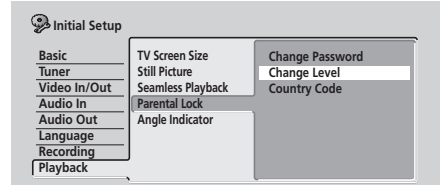

2 Use number buttons to enter your password, then press ENTER.

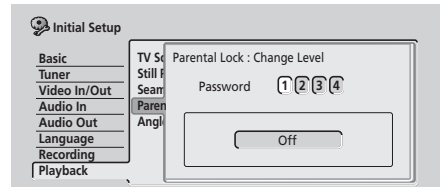

3 Use the ←/→ (cursor left/right) buttons to select a new parental lock level.

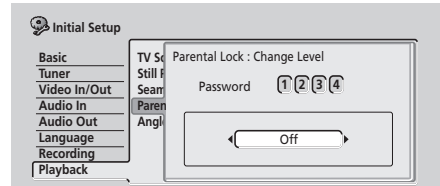

4 Press ENTER to set the new Parental Lock level.

Parental Lock : Country Code

You may also want to refer to the *Country code list* on page 119.

1 Select 'Country Code'.

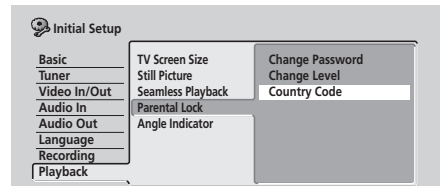

2 Use number buttons to enter your password, then press ENTER.

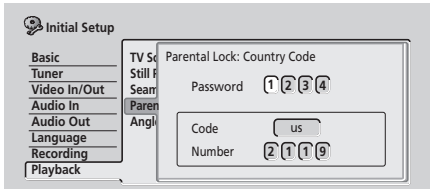

On the default setting, when playing a DVD-Video disc that features multi-angle scenes, an icon appears on-screen during the parts of the disc where angle switching is available. Change to **Off** to hide the on-screen indicator.

3 Select a Country code.

There are two ways you can do this.

- Select by code letter: Use ←/→ (cursor left/right) to change the country code.

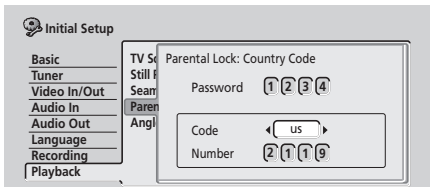

- Select by code number: Press ↓ (cursor down) then use the number buttons to enter the four-digit country code (you can find the *Country code list* on page 119.)

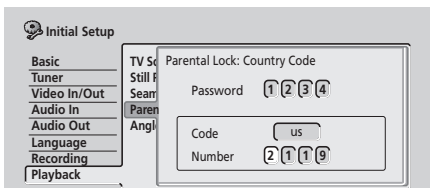

4 Press ENTER to set the new Country code.

Note

- Changing the country code does not take effect until the next disc is loaded (or the current disc is reloaded).

Angle Indicator

- Default setting: On

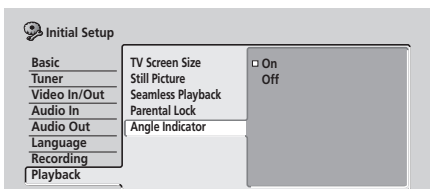

Chapter 14

Additional information

Resetting the recorder

If you need to, you can reset the recorder to all its factory settings.

- 1 Make sure that the recorder is on.**
- 2 Press and hold ■ STOP and press ⏻ STANDBY/ON.**

The recorder turns off with all settings reset.

Setting up the remote to control your TV

You can use the supplied remote to control your TV. To be able to use this feature you first have to program the remote with a maker code from the table below.

- 1 Press and hold down the CLEAR button, then enter the maker code for your TV.**

The LED indicator on the remote controls lights.

See the table below for the list of maker codes. If there is more than one code given for your make, input the first one in the list.

- If the maker's name of your TV doesn't appear in the table below, you will not be able to use this remote to control your TV.

- 2 Press ⏻ TV to check that the remote works with your TV.**

If the remote is set up correctly, the TV should switch on/off. If it doesn't and there is another code given for your maker, repeat step 1 with a new code.











Using the TV remote control buttons

The table below shows how to use this remote control with your TV.

Button	What it does
⏻ TV	Press to switch the TV on/off (standby)
INPUT SELECT	Press to change the TV's video input
TV VOLUME	Use to adjust the TV volume
TV CHANNEL	Use to change TV channels

Maker	Code
Alba	66
Bush	76
Finlux	84
Fisher	61, 65
Fujitsu	77
Funai	67
Goldstar	79
Grandiente	87
Grundig	51, 82
Hitachi	56, 60, 83, 86
ITT	70
Mitsubishi	59
Nokia	53, 81
Panasonic	58, 72
Philips	57, 85
Pioneer	50, 80
RCA	68
Salora	71
Samsung	73, 75
Sanyo	74
Sei	78
Sharp	52
Sony	54
Tandy	69
Telefunken	64
Thomson	62
Toshiba	55
Victor	63

Screen sizes and disc formats

When viewing on a standard TV or monitor		
Screen format of disc	Setting	Appearance
16:9 	4:3 (Letter Box) 	The program is shown in widescreen with black bars at the top and bottom of the screen.
	4:3 (Pan & Scan) 	The sides of the program are cropped so that the picture fills the whole screen.
4:3 	16:9 	The program appears squashed. Set to either 4:3 (Letter Box) or 4:3 (Pan & Scan) .
	4:3 (Letter Box) 4:3 (Pan & Scan) 	The program is presented correctly on either setting.
When viewing on a widescreen TV or monitor		
Screen format of disc	Setting	Appearance
16:9 	16:9 	The program is presented in widescreen.
4:3 	16:9  	Your TV will determine how the picture is presented—check the manual that came with the TV for details.



Troubleshooting

Incorrect operation is often mistaken for trouble and malfunction. If you think there is something wrong with this component, please check the points below. Sometimes the trouble may lie in another component. Investigate the other components and electrical appliances being used. If the trouble cannot be rectified even after checking the points below, ask your nearest Pioneer authorized service center or your dealer to carry out repair work.

General

Problem	Remedy
The disc is automatically ejected after closing the disc tray	<ul style="list-style-type: none"> • Check that the disc is not a DVD-RAM, DVD+R/RW or other incompatible format disc (page 9). • Check that the disc is loaded properly (aligned in disc tray and label-side up). • Take out the disc and clean it (page 121). • Check that the disc has a region code compatible with the recorder (page 123).
No picture	<ul style="list-style-type: none"> • Check that everything is connected properly (page 12). • Check that the connected TV and/or the AV amp/receiver is set to the correct input.
Can't play a disc	<ul style="list-style-type: none"> • Check that the disc is not a DVD-RAM, DVD+R/RW or other incompatible format disc (page 9). • Take out the disc and clean it (page 121). • Check that the disc is loaded properly (aligned in disc tray and label-side up). • There may be condensation in the recorder. Leave the recorder for an hour or so for the condensation to evaporate. • During HDD recording, you can't play discs that are recorded with a Line System different to the current recorder setting.
All settings are reset	<ul style="list-style-type: none"> • If the recorder is unplugged (or there is a power failure) while the recorder is on, all the settings will be lost. • Make sure that you switch the recorder into standby before unplugging the power cord.
Screen goes blank and controls are inoperative	<ul style="list-style-type: none"> • Press ■ STOP then restart playback.
Remote control does not work	<ul style="list-style-type: none"> • If you connected this recorder to another Pioneer product using the CONTROL IN jack, point the remote control at the other component to use (page 12). • Set the remote control to the same ID number as the recorder (page 99). (When the batteries run down, the remote mode is automatically reset to Recorder1.) • Use the remote within its operating range (page 8). • Replace the batteries (page 8).
No sound or sound is distorted	<ul style="list-style-type: none"> • Make sure that the amp/receiver or TV is set to the correct input and the volume turned up. • There is no sound when the picture is paused, or during scanning or slow motion play. Press ▶ PLAY to resume regular playback. • DTS discs can only be played if this recorder is connected to a DTS decoder or DTS compatible amp/receiver. If you have connected a suitable decoder, also make sure that the Initial Setup > Audio Out > DTS Output setting is On. • Some 96kHz discs do not output audio through the digital jack. In this case, switch the input of your amp/receiver to analog. • Check the audio cable connections (page 12). • If the sound is distorted, try cleaning the cable plugs.
The picture from the external input is distorted	<ul style="list-style-type: none"> • If the video signal from the external component is copy-protected, you cannot connect via this recorder. Connect the component directly to your TV.

Problem	Remedy
The picture is distorted	<ul style="list-style-type: none"> • Change the Input Line System setting (page 98). (You can also change it by pressing the + button and DVD on the front panel simultaneously with the recorder stopped.)
Screen is stretched vertically or horizontally	<ul style="list-style-type: none"> • Make sure that the TV Screen Size setting (page 109) is correct for the kind of TV you have (see also page 113). • If you have a widescreen TV, check its aspect ratio settings. • This recorder's input switches into wide mode automatically according to the input signal. When the unit connected is not compatible with VIDEO ID-1 (widescreen signalling), set the connected component to output 4:3 aspect ratio (standard) video.
Can't play a disc recorded using this recorder on another player	<ul style="list-style-type: none"> • If the disc was recorded in Video mode, make sure that it's finalized (page 59). • Some players will not play recordable DVD discs, even when recorded in Video mode and finalized. • If the disc was recorded in VR mode, the other player must be specifically RW compatible in order to play it (page 9). • Discs recorded with copy-once material cannot be played on non-CPRM compatible players (page 46).
During playback the picture is dark or distorted	<ul style="list-style-type: none"> • When a copy-protected disc is played via a VCR, the picture will not display correctly. Connect the recorder directly to your TV.
Can't control your TV using this remote control	<ul style="list-style-type: none"> • If there is more than one code listed for your make of TV, try each one in turn (page 112). • It is possible that none of the codes listed will work with your particular model of TV, even if the maker appears in the remote control code list.
Can't record or does not record successfully	<ul style="list-style-type: none"> • Check that there is some remaining blank space on the DVD/HDD. • For a Video mode disc, check that the disc isn't already finalized. • The HDD may contain up to 250 titles; one DVD disc 99 (Original) titles and 999 chapters. Check that these limits have not been reached. • Check that the source you are trying to record is not copy protected. • For a VR formatted disc, check that the disc isn't locked (page 92). • Check that you are recording with the same TV system (PAL, NTSC, etc.) as the disc has already been recorded in. All recordings on a disc must be in the same TV system. When recording to the HDD, it is also necessary to set the Input Line System setting to match what you want to record (page 98). • The power may have failed during recording.
Timer program doesn't record successfully	<ul style="list-style-type: none"> • When setting the recording channel, make sure you set the recorder's built-in TV tuner, not the TV's built-in tuner. • When recording to a Video mode disc, programs that are copy-once protected cannot be recorded. Use a VR mode formatted disc for copy-once material (page 46). • Two timer programs may have overlapped, in which case only the earlier one will record completely. • The power may have failed during recording.
After briefly unplugging or after a power failure the front panel display shows '---:---'	<ul style="list-style-type: none"> • A backup battery inside the recorder keeps the clock and other settings from being reset when there is no power to the recorder. This battery should last approximately five years from factory shipping. Reset the clock and other recorder settings to use the recorder again. To have the battery replaced, contact your dealer or a Pioneer Service Center.
Front panel display shows 'LOCK' when a button is pressed	<ul style="list-style-type: none"> • The Child Lock is on; turn off in order to use the recorder (page 55).

Problem	Remedy
Can't use One Touch Copy (HDD to DVD)	<ul style="list-style-type: none"> • Make sure that there is a recordable DVD loaded with some free space for recording and fewer than 99 titles already on the disc. Also make sure that for a Video mode disc, the disc isn't finalized. • If the title currently playing contains material that is copy-once protected, One Touch Copy will not work. • One Touch Copy doesn't work if the recorder is already recording to DVD.
Can't use One Touch Copy (DVD to HDD)	<ul style="list-style-type: none"> • Make sure that there is space available on the HDD and that there are fewer than 250 titles on the HDD. • One Touch Copy doesn't work if the recorder is already recording to the HDD.
The picture freezes and the front panel and remote control buttons stop working	<ul style="list-style-type: none"> • Press the front panel  STANDBY/ON button to switch the power off, then switch back on and restart playback. If the power fails to switch off, press and hold  STANDBY/ON for 10 seconds until the power switches off.



Note

- If the unit does not operate normally due to external effects such as static electricity, disconnect the power plug from the outlet and insert again to return to normal operating conditions.

Frequently asked questions

In this section you can find answers to frequently asked questions on how to use your DVD recorder and what it can do.

- *How do I make a high-quality copy?*

We recommend that you use the high-speed copy mode. Although the copy is faster than real time, there is no loss of picture or sound quality compared to the original.

If there is not enough space on the disc to make a copy at the same picture quality as the original, we recommend that you change the recording mode to 'Optimized'. This will fit the recording on to the available space on the disc.

See also *Copying and back-up* on page 61.

- *Can I make a DVD copy of, say, a movie that has had the commercials edited out?*

Yes. There are two ways to do this. You can either edit the video on the HDD then copy the edited version to DVD, or you can assemble a Copy List that cuts out the commercials, then record that to DVD.

See also *Copying and back-up* on page 61.

- *I have a two-hour recording on the HDD made in **FINE** mode. Can I copy this to DVD in high-speed mode?*

A standard DVD disc can hold only an hour of **FINE** mode material, so you wouldn't be able to make a high-speed copy of this on to one disc. You could divide up the recording on the HDD into two titles of an hour each and copy these to two DVDs (using

high-speed copy). Alternatively, you could copy the material in **SP** (or Optimized) so as to fit it all on to one disc (note that there will be some loss in picture quality if you do this).

See also *Copying and back-up* on page 61.

- *Can I record a bilingual broadcast to the HDD, keeping both audio channels and switch them on playback?*

No. Only the audio channel set in the Bilingual Recording setting in the Initial Settings menu will be recorded. If you need to record both channels of audio, please record using a VR mode DVD-RW disc.

See also *Bilingual Recording* on page 104.

- *Can I record continuously on the HDD for more than six hours?*

Yes, timer recordings made to the HDD can be set for up to 24 hours. However, because the maximum length of a title is six hours, the recording will be spread over two or more titles. Note that there will be a short break in the recording between titles.

See also *Setting a timer recording* on page 49.

- *Can I copy a finalized Video mode disc (DVD-R or DVD-RW) to the HDD?*

Yes. Start playing the Video mode disc and use the One Touch Copy button to copy the currently playing title to the HDD. Repeat for as many titles on the disc as you want to copy.

See also *One Touch Copy* (DVD to HDD)* on page 62.

- *Can I use high-speed copy to copy from DVD to HDD?*

You can only use high-speed copy from DVD to HDD when copying Original titles from a VR mode DVD-RW.

See also *Copying from DVD to HDD** on page 71.

- *Can I copy a copy-once protected program from a subscription satellite or cable channel to a DVD from the HDD?*

Yes, you can use high-speed copy to copy to a VR mode DVD-RW disc. You can also divide the recording on the HDD into a number of smaller titles if the whole recording won't fit on to one disc.

See also *Copying from HDD to DVD** on page 63.

- *Can I play a DVD I recorded on this recorder on another DVD player?*

Yes, you can generally play DVD-R discs and Video mode DVD-RW discs recorded on this recorder on any standard DVD player. You may find, however, that some players will not play some recordable media.

For VR mode DVD-RW discs, look for the 'RW Compatible' mark to see if it will play the disc.

About DV (DVR-520H/720H only)

Using DV, also known as i.LINK, you can connect a DV-equipped camcorder to this recorder using a single DV cable for input and output of audio, video, data and control signals.

The i.LINK interface is also known as IEEE 1394-1995. "i.LINK" and the "i.LINK" logo are trademarks.

- This recorder is only compatible with DV-format (DVC-SD) camcorders. Digital satellite tuners and Digital VHS video recorders are not compatible.
- You cannot connect more than one DV camcorder at a time to this recorder.
- You cannot control this recorder from external equipment connected via the **DV IN/OUT** jack.
- It may not always be possible to control the connected camcorder via the **DV IN/OUT** jack.
- This recorder only outputs HDD/DVD playback video from the **DV IN/OUT** jack; signals from the built-in TV tuner, CD, Video CD and other inputs are not output.
- Copy-protected or copy-once video is not output from the **DV IN/OUT** jack.
- Digital camcorders can usually record audio as stereo 16-bit/48kHz, or twin stereo tracks of 12-bit/32kHz. This recorder can only record one stereo audio track. Set the **DV Input** setting as required (see *DV Input (DVR-520H/720H only)* on page 104).

- Audio output from the **DV IN/OUT** jack is 16-bit only.
- Audio input to the **DV IN/OUT** jack should be 32 or 48kHz (not 44.1kHz).
- Picture disturbance in the recording may occur if the source component pauses playback or plays an unrecorded section of tape, or if the power fails in the source component, or the DV cable becomes disconnected.

DV-related messages

You may see the following messages appear on your TV screen when using the **DV IN/OUT** jack.

- **No DV camcorder connected.** – The camcorder is not connected properly, or the camcorder is switched off.
- **The DV camcorder is recording.** – The camcorder is recording, so you cannot start recording from the camcorder to this recorder.
- **You cannot connect more than one DV camcorder at the same time.** – The DV jack on this recorder supports connection to just one camcorder.
- **No tape in the DV camcorder.** – There is no cassette loaded into the connected equipment.
- **The DV camcorder is in record-pause mode.** – The camcorder is in record-pause mode.
- **DV camcorder playback canceled. Recording has been paused.** – Recording was paused because the camcorder is not in playback mode.
- **Cannot operate the DV camcorder.** – This recorder cannot control the camcorder. Try switching off the camcorder then switching it back on.
- **Could not operate the DV camcorder.** – This recorder was not able to control the camcorder.
- **Recording has stopped because the recorded material on the tape finished.** – When the recorded part of the DV tape comes to an end, this recorder automatically stops recording.
- **Recording has stopped because DV camcorder playback stopped.** – Recording stopped because DV camcorder playback was stopped or the camcorder was disconnected.
- **The DV camcorder is not set for playback. Please select playback mode on the DV camcorder.** – The camcorder is in camera mode.

Manual recording modes

The table below shows the approximate recording times for all of the 32 manual recording modes, as well as the standard recording mode equivalents. Levels separated by a bold line show where there is a noticeable change in picture quality. The divisions for HDD recording are the same as those for Video mode.

Audio recording in all manual recording modes is in Dolby Digital 2ch format, except for MN32 which is in Linear PCM format.

VR mode			Video mode / HDD	
Level	Rec. time		Level	Rec. time
MN 1	360 mins.	EP	MN 1	360 mins.
MN 2	345 mins.		MN 2	345 mins.
MN 3	330 mins.		MN 3	330 mins.
MN 4	315 mins.		MN 4	315 mins.
MN 5	300 mins.		MN 5	300 mins.
MN 6	285 mins.		MN 6	285 mins.
MN 7	270 mins.		MN 7	270 mins.
MN 8	255 mins.	LP	MN 8	255 mins.
MN 9	240 mins.		MN 9	240 mins.
MN 10	230 mins.		MN 10	230 mins.
MN 11	220 mins.		MN 11	220 mins.
MN 12	210 mins.		MN 12	210 mins.
MN 13	200 mins.		MN 13	200 mins.
MN 14	190 mins.		MN 14	190 mins.
MN 15	180 mins.		MN 15	180 mins.
MN 16	170 mins.		MN 16	170 mins.
MN 17	160 mins.		MN 17	160 mins.
MN 18	150 mins.		MN 18	150 mins.
MN 19	140 mins.		MN 19	140 mins.
MN 20	130 mins.		MN 20	130 mins.
MN 21	120 mins.	SP	MN 21	120 mins.
MN 22	110 mins.		MN 22	110 mins.
MN 23	105 mins.		MN 23	105 mins.
MN 24	100 mins.		MN 24	100 mins.
MN 25	95 mins.		MN 25	95 mins.
MN 26	90 mins.		MN 26	90 mins.
MN 27	85 mins.		MN 27	85 mins.
MN 28	80 mins.		MN 28	80 mins.
MN 29	75 mins.		MN 29	75 mins.
MN 30	70 mins.		MN 30	70 mins.
MN 31	65 mins.		MN 31	65 mins.
MN 32	61 mins.	FINE	MN 32	61 mins.

Language code list

Language (Language code letter), **Language code**

Japanese (ja), 1001	Bhutani (dz), 0426	Kirghiz (ky), 1125	Sinhalese (si), 1909
English (en), 0514	Esperanto (eo), 0515	Latin (la), 1201	Slovak (sk), 1911
French (fr), 0618	Estonian (et), 0520	Lingala (ln), 1214	Slovenian (sl), 1912
German (de), 0405	Basque (eu), 0521	Laothian (lo), 1215	Samoan (sm), 1913
Italian (it), 0920	Persian (fa), 0601	Lithuanian (lt), 1220	Shona (sn), 1914
Spanish (es), 0519	Finnish (fi), 0609	Latvian (lv), 1222	Somali (so), 1915
Chinese (zh), 2608	Fiji (fj), 0610	Malagasy (mg), 1307	Albanian (sq), 1917
Dutch (nl), 1412	Faroese (fo), 0615	Maori (mi), 1309	Serbian (sr), 1918
Portuguese (pt), 1620	Frisian (fy), 0625	Macedonian (mk), 1311	Siswati (ss), 1919
Swedish (sv), 1922	Irish (ga), 0701	Malayalam (ml), 1312	Sesotho (st), 1920
Russian (ru), 1821	Scots-Gaelic (gd), 0704	Mongolian (mn), 1314	Sundanese (su), 1921
Korean (ko), 1115	Galician (gl), 0712	Moldavian (mo), 1315	Swahili (sw), 1923
Greek (el), 0512	Guarani (gn), 0714	Marathi (mr), 1318	Tamil (ta), 2001
Afar (aa), 0101	Gujarati (gu), 0721	Malay (ms), 1319	Telugu (te), 2005
Abkhazian (ab), 0102	Hausa (ha), 0801	Maltese (mt), 1320	Tajik (tg), 2007
Afrikaans (af), 0106	Hindi (hi), 0809	Burmese (my), 1325	Thai (th), 2008
Amharic (am), 0113	Croatian (hr), 0818	Nauru (na), 1401	Tigrinya (ti), 2009
Arabic (ar), 0118	Hungarian (hu), 0821	Nepali (ne), 1405	Turkmen (tk), 2011
Assamese (as), 0119	Armenian (hy), 0825	Norwegian (no), 1415	Tagalog (tl), 2012
Aymara (ay), 0125	Interlingua (ia), 0901	Occitan (oc), 1503	Setswana (tn), 2014
Azerbaijani (az), 0126	Interlingue (ie), 0905	Oromo (om), 1513	Tonga (to), 2015
Bashkir (ba), 0201	Inupiak (ik), 0911	Oriya (or), 1518	Turkish (tr), 2018
Byelorussian (be), 0205	Indonesian (in), 0914	Panjabi (pa), 1601	Tsonga (ts), 2019
Bulgarian (bg), 0207	Icelandic (is), 0919	Polish (pl), 1612	Tatar (tt), 2020
Bihari (bh), 0208	Hebrew (iw), 0923	Pashto, Pushto (ps), 1619	Twi (tw), 2023
Bislama (bi), 0209	Yiddish (ji), 1009	Quechua (qu), 1721	Ukrainian (uk), 2111
Bengali (bn), 0214	Javanese (jw), 1023	Rhaeto-Romance (rm), 1813	Urdu (ur), 2118
Tibetan (bo), 0215	Georgian (ka), 1101	Kirundi (rn), 1814	Uzbek (uz), 2126
Breton (br), 0218	Kazakh (kk), 1111	Romanian (ro), 1815	Vietnamese (vi), 2209
Catalan (ca), 0301	Greenlandic (kl), 1112	Kinyarwanda (rw), 1823	Volapük (vo), 2215
Corsican (co), 0315	Cambodian (km), 1113	Sanskrit (sa), 1901	Wolof (wo), 2315
Czech (cs), 0319	Kannada (kn), 1114	Sindhi (sd), 1904	Xhosa (xh), 2408
Welsh (cy), 0325	Kashmiri (ks), 1119	Sangho (sg), 1907	Yoruba (yo), 2515
Danish (da), 0401	Kurdish (ku), 1121	Serbo-Croatian (sh), 1908	Zulu (zu), 2621

Country code list

Country, **Country code**, **Country code letter**

Argentina, 0118 , ar	Finland, 0609 , fi	Malaysia, 1325 , my	Singapore, 1907 , sg
Australia, 0121 , au	France, 0618 , fr	Mexico, 1324 , mx	Spain, 0519 , es
Austria, 0120 , at	Germany, 0405 , de	Netherlands, 1412 , nl	Sweden, 1905 , se
Belgium, 0205 , be	Hong Kong, 0811 , hk	New Zealand, 1426 , nz	Switzerland, 0308 , ch
Brazil, 0218 , br	India, 0914 , in	Norway, 1415 , no	Taiwan, 2023 , tw
Canada, 0301 , ca	Indonesia, 0904 , id	Pakistan, 1611 , pk	Thailand, 2008 , th
Chile, 0312 , cl	Italy, 0920 , it	Philippines, 1608 , ph	United Kingdom, 0702 , gb
China, 0314 , cn	Japan, 1016 , jp	Portugal, 1620 , pt	USA, 2119 , us
Denmark, 0411 , dk	Korea, Republic of, 1118 , kr	Russian Federation, 1821 , ru	

On-screen displays and recorder displays

The table below shows a list of error messages that you may encounter when using the recorder and an explanation of their meaning.

Message	Explanation/Action
<ul style="list-style-type: none"> • Initializing disc. Please wait a moment. 	When you load a blank DVD-RW disc, the recorder automatically initializes it.
<ul style="list-style-type: none"> • Incompatible region number. 	The disc loaded has an incompatible region number for the recorder and so will not play.
<ul style="list-style-type: none"> • Cannot record any more titles. • No more space for file management data. • Cannot add any more chapter marks. 	The disc control data limit has been reached, or the maximum number of chapters and/or titles has been reached. Erase titles/chapters or combine chapters.
<ul style="list-style-type: none"> • This disc cannot be recorded. Undo the finalization. 	The disc was finalized on a non-Pioneer DVD recorder. Undo the finalization in order to recording/editing.
<ul style="list-style-type: none"> • Cannot play this disc. • This disc cannot be recorded. • Cannot read the CPRM information. • Could not record the information to the disc. • Cannot edit. • Could not initialize disc. • Could not complete finalization successfully. • Could not undo finalization successfully. • Could not successfully unlock the disc. 	The disc may be dirty or damaged. Take out the disc, clean it and retry. If the error persists, use a new disc. If the error appears even with a new disc, please consult a Pioneer Service Center.
<ul style="list-style-type: none"> • Incompatible or unreadable disc. 	The disc loaded is a DVD-RAM, DVD+R/RW or some other incompatible disc type. This display may also appear if the disc is dirty or damaged.
<ul style="list-style-type: none"> • Cannot record to a disc that is not CPRM compatible. • Cannot record this content using Video mode recording. 	The video source is copy-once protected. Use a VR mode DVD-RW disc with CPRM for recording.
<ul style="list-style-type: none"> • This content is copy protected. 	The video source is copy-protected and cannot be recorded.
<ul style="list-style-type: none"> • Incorrect CPRM information. 	The recorder could not read the CPRM information. The recorder may be damaged—please consult a Pioneer Service Center.
<ul style="list-style-type: none"> • The audio will conform to the [Bilingual Recording] setting. 	When recording from an external input in Video mode, or in VR mode set to MN 32, audio is recorded in Linear PCM format. You can only record the left or right channel; not both.
<ul style="list-style-type: none"> • Repairing disc. 	During recording, the power was cut. This display appears when the power is restored.
<ul style="list-style-type: none"> • Could not repair the disc. 	The recorder was unable to repair the disc after a power cut. The contents of the recording will be lost.
<ul style="list-style-type: none"> • Overheating has stopped operation. Press DISPLAY to clear this message. 	The internal temperature of the recorder has exceeded the operating limit. If this message reappears, please contact a Pioneer authorized service center.

Message	Explanation/Action
<ul style="list-style-type: none"> • There is no DV input or the input signal is unrecordable. • Cannot preview because there is no DV input or the input signal is unrecordable. 	The no signal was detected at the DV input/output jack. This may appear if a blank section of DV tape is playing in the connected camcorder. (Applicable to DVR-520H/720H only.)
<ul style="list-style-type: none"> • This channel's TV system is different from the recorder's setting. 	The TV system (PAL, NTSC, etc.) of the current channel is different from the TV system settings of this recorder.
<ul style="list-style-type: none"> • Recording failed due to a TV system mismatch. Press DISPLAY to clear message. 	The timer recording failed because the TV system of the channel set for recording was different from the setting of the recorder.
<ul style="list-style-type: none"> • Playback has stopped because the TV system is different than the recording. 	During recording or timer recording standby, the TV System (PAL, NTSC, etc.) of the playback video changed, causing playback to stop automatically.

Handling discs

When holding discs of any type, take care not to leave fingerprints, dirt or scratches on the disc surface. Hold the disc by its edge or by the center hole and edge.

Damaged or dirty discs can affect playback and recording performance. Take care also not to scratch the label side of the disc. Although not as fragile as the recorded side, scratches can still result in a disc becoming unusable.

Should a disc become marked with fingerprints, dust, etc., clean using a soft, dry cloth, wiping the disc lightly from the center to the outside edge as shown in the diagram below.



If necessary, use a cloth soaked in alcohol, or a commercially available CD/DVD cleaning kit to clean a disc more thoroughly. Never use benzine, thinner or other cleaning agents, including products designed for cleaning vinyl records.

Storing discs

Although CDs and DVD discs are more durable than vinyl records, you should still take care to handle and store discs correctly. When you're not using a disc, return it to its case and store upright. Avoid leaving discs in excessively cold, humid, or hot environments (including under direct sunlight).

Don't glue paper or put stickers onto the disc, or use a pencil, ball-point pen or other sharp-tipped writing instrument. These could all damage the disc.



For more detailed care information see the instructions that come with discs.

Do not load more than one disc into the recorder.

Damaged discs

Discs spin at high speed inside the recorder. If you can see that a disc is cracked, chipped, warped, or otherwise damaged, don't risk using it; you could end up damaging the recorder.

This recorder is designed for use with conventional, fully circular discs only. Use of shaped discs is not recommended for this product. Pioneer disclaims all liability arising in connection with the use of shaped discs.

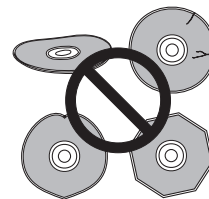

Cleaning the pickup lens

The DVD recorder's lens should not become dirty in normal use, but if for some reason it should malfunction due to dust or dirt, consult your nearest Pioneer-authorized service center. Although lens cleaners for CD players are commercially available, we do not recommend using them since some may damage the lens.

Condensation

Condensation may form inside the recorder if it is brought into a warm room from outside, or if the temperature of the room rises quickly. Although the condensation won't damage the recorder, it may temporarily impair its performance. For this reason you should leave it to adjust to the warmer temperature for about an hour before switching on and using.

Hints on installation

We want you to enjoy using this unit for years to come, so please bear in mind the following points when choosing a suitable location for it:

Do...

- ✓ Use in a well-ventilated room.
- ✓ Place on a solid, flat, level surface, such as a table, shelf or stereo rack.

Don't...

- ✗ Use in a place exposed to high temperatures or humidity, including near radiators and other heat-generating appliances.
- ✗ Place on a window sill or other place where the recorder will be exposed to direct sunlight.
- ✗ Use in a dusty or damp environment or in a room where it will be exposed to excessive cigarette smoke.
- ✗ Place directly on top of an amplifier, or other component in your stereo system that becomes hot in use.
- ✗ Use near a television or monitor as you may experience interference—especially if the television uses an indoor antenna.
- ✗ Use in a kitchen or other room where the recorder may be exposed to smoke or steam.
- ✗ Use on a thick rug or carpet, or cover with cloth—this may prevent proper cooling of the unit.
- ✗ Place on an unstable surface, or one that is not large enough to support all four of the unit's feet.

Moving the recorder

If you need to move the recorder, first remove the disc, if there's one loaded, and close the disc tray. Next, press **⏻** **STANDBY/ON** to switch the power to standby, checking that the **POWER OFF** indication in the display goes off. Wait at least two minutes. Lastly, disconnect the power cord. Never lift or move the unit during playback or recording—discs rotate at a high speed and may be damaged.

Glossary

Analog audio

An electrical signal that directly represents sound. Compare this to digital audio which can be an electrical signal, but is an indirect representation of sound. See also *Digital audio*.

Aspect ratio

The width of a TV screen relative to its height. Conventional TVs are 4:3 (in other words, the screen is almost square); widescreen models are 16:9 (the screen is almost twice as wide as it is high).

Chapter

Just as a book is split up into several chapters, a title on the HDD/a DVD disc is usually divided into chapters. See also *Title*.

Digital audio

An indirect representation of sound by numbers. During recording, the sound is measured at discrete intervals (44,100 times a second for CD audio) by an analog-to-digital converter, generating a stream of numbers. On playback, a digital-to-analog converter generates an analog signal based on these numbers. See also *Sampling frequency* and *Analog audio*.

Dolby Digital



With multichannel audio, this high quality surround system is used in many movie theaters around the world. *Manufactured under licence from Dolby Laboratories. "Dolby" and the double-D symbol are trademarks of Dolby Laboratories.*

DRM (Digital Rights Management)

DRM (Digital Rights Management) copy protection is a technology designed to prevent unauthorized copying by restricting playback, etc. of material on devices other than the PC (or other WMA recording equipment) used to record it. For detailed information, please see the instruction manuals or help files that came with your PC (or other WMA recording equipment) and/or software.

DTS

DTS stands for Digital Theater System. DTS is a surround system different from Dolby Digital that has become a popular surround sound format for movies.

"DTS" and "DTS Digital Out" are registered trademarks of Digital Theater Systems, Inc.

Dynamic range

The difference between the quietest and loudest sounds possible in an audio signal (without distorting or getting lost in noise). Dolby Digital and DTS soundtracks are capable of a wide dynamic range, delivering dramatic cinema-like effects.

EXIF (Exchangeable Image File)

A file format developed by Fuji Photo Film for digital still cameras. Digital cameras from various manufacturers use this compressed file format which carries date, time and thumbnail information, as well as the picture data.

File extension

A tag added to the end of a filename to indicate the type of file. For example, ".mp3" indicates an MP3 file.

ISO 9660 format

International standard for the volume and file structure of CD-ROM discs.

JPEG

A file format used for still images, such as photographs and illustrations. JPEG files are identified by the file extension ".jpg" or ".JPG". Most digital cameras use this format.

MP3

MP3 (MPEG1 audio layer 3) is a compressed audio file format. Files are recognized by their file extension ".mp3" or ".MP3".

MPEG audio**MPEG))(Multichannel**

An audio format used on Video CDs and some DVD discs. This unit can convert MPEG audio to PCM format for wider compatibility with digital recorders and AV amp/receivers. See also *PCM*.

MPEG video

The video format used for Video CDs and DVDs. Video CD uses the older MPEG-1 standard, while DVD uses the newer and much better quality MPEG-2 standard.

Optical digital output

A jack that outputs digital audio in the form of light pulses. Connect components with optical digital jacks using a special optical cord, available from specialist audio dealers.

PCM (Pulse Code Modulation)

The most common system of encoding digital audio, found on CDs and DAT. Excellent quality, but requires a lot of data compared to formats such as Dolby Digital and MPEG audio. For compatibility with digital audio recorders (CD, MD and DAT) and AV amp/receivers with digital inputs, this unit can convert Dolby Digital and MPEG audio to PCM. See also *Digital audio*.

PBC (PlayBack Control) (Video CD/Super VCD only)

A system of navigating a Video CD/Super VCD through on-screen menus recorded onto the disc. Especially good for discs that you would normally not watch from beginning to end all at once—karaoke discs, for example.

Regions (DVD only)

(example region code marks)

Regions associate discs and players with particular areas of the world. This unit will only play discs that have compatible region codes. You can find the region code of your unit by looking on the rear panel. Some discs are compatible with more than one region (or all regions).

Sampling frequency

The rate at which sound is measured to be turned into digital audio data. The higher the rate, the better the sound quality, but the more digital information is generated. Standard CD audio has a sampling frequency of 44.1kHz, which means 44,100 samples (measurements) per second. See also *Digital audio*.

Title

A collection of chapters on a the HDD/DVD disc. See also *Chapter*.

Track

Audio CDs and Video CDs use tracks to divide up the content of a disc. The DVD equivalent is called a chapter. See also *Chapter*.

WMA

WMA is short for Windows Media Audio and refers to an audio compression technology developed by Microsoft Corporation. WMA data can be encoded by using Windows Media Player version 9 or Windows Media Player for Windows XP. Files are recognized by their file extension ".wma" or ".WMA".

Microsoft, Windows Media, and the Windows logo are trademarks, or registered trademarks of Microsoft Corporation in the United States and/or other countries.

Specifications

General

System	HDD, DVD-Video, DVD-R/RW, Video-CD, Super VCD, CD, CD-R/RW (WMA, MP3, JPEG, CD-DA)
Power requirements	220–240 V, 50/60 Hz
Power consumption	
DVR-420	51 W
DVR-520	54 W
DVR-720	56 W
Power consumption in standby mode	0.68 W
	(Front panel display: off /Power Save Mode2)
Weight	4.7 kg
Dimensions	420 (W) x 59 (H) x 339 (D) mm
Operating temperature	+5°C to +35°C
Operating humidity	.5% to 85% (no condensation)
TV system	PAL/SECAM/ NTSC (external input only)

Recording

Recording format	DVD Video Recording DVD-VIDEO
------------------	----------------------------------

Recordable discs

DVD-RW (DVD Re-recordable disc)
DVD-R (DVD Recordable disc)

Video recording format

Sampling frequency	13.5MHz
Compression format	MPEG

Audio recording format

Sampling frequency	48kHz
Compression format	Dolby Digital or Linear PCM (uncompressed)

Recording time

HDD—DVR-720H

Fine (FINE)	Approx. 34 hours
Standard Play (SP)	Approx. 68 hours
Long Play (LP)	Approx. 136 hours
Extended Play (EP)	Approx. 204 hours
Manual Mode (MN)	Approx. 34–204 hours

HDD—DVR-420H/520H

Fine (FINE)	Approx. 17 hours
Standard Play (SP)	Approx. 34 hours
Long Play (LP)	Approx. 68 hours
Extended Play (EP)	Approx. 102 hours
Manual Mode (MN)	Approx. 17–102 hours

DVD-R/DVD-RW

Fine (FINE)	Approx. 1 hour
Standard Play (SP)	Approx. 2 hours
Long Play (LP)	Approx. 4 hours
Extended Play (EP)	Approx. 6 hours
Manual Mode (MN)	Approx. 1–6 hours

Tuner

Receiveable channels

	PAL B/G		PAL I	
	Frequency	Channel	Frequency	Channel
VHF (low)	47 - 89 MHz	E2 - E4 X - Z	44 - 89 MHz	A - C X - Z
VHF (high)	104 - 300 MHz	E5 - E12 S1 - S20 M1 - M10 U1 - U10	104 - 300 MHz	D - J 11, 13 S1 - S20
Hyper	302 - 470 MHz	S21 - S41	302 - 470 MHz	S21 - S41
UHF	470 - 862 MHz	E21 - E69	470 - 862 MHz	E21 - E69

	SECAM L		SECAM D/K	
	Frequency	Channel	Frequency	Channel
VHF (low)	49 - 65 MHz	2 - 4	49 - 94 MHz	R1 - R5
VHF (high)	104 - 300 MHz	5 - 10 B - Q	104 - 300 MHz	R6 - R12 S1 - S20
Hyper	300 - 470 MHz	S21 - S41	302 - 470 MHz	S21 - S41
UHF	470 - 862 MHz	21 - 69	470 - 862 MHz	E21 - E69

STEREO
B/G - A2
I - NICAM
L - NICAM
B/G - NICAM
D/K - NICAM

Timer

Programs	1 month/32 programs
Clock	Quartz lock (24-hour digital display)
Power off memory	Approx. 5 years (after manufacture)

Input/Output

VHF/UHF antenna input/output terminal	VHF/UHF set 75 Ω (IEC connector)
Video input	Input 1 (rear), 2 (front)
Input level	1 Vp-p (75 Ω)
Jacks	.AV connector 2 (Input 1), RCA jack (Input 2)
Video output	AV1 Output
Output level	1 Vp-p (75 Ω)
Jacks	.AV connector 1 (AV1) RCA jack (Output)
S-Video input	Input 1 (rear), 2 (front)
Y (luminance) - Input level	1 Vp-p (75 Ω)
C (colour) - Input level	286 mVp-p (75 Ω)
Jacks	.AV connector 2 (Input 1), 4 pin mini DIN (Input 2)
S-Video output	AV1 / Output
Y (luminance) - Output level	1 Vp-p (75 Ω)
C (colour) - Output level	286 mVp-p (75 Ω)
Jacks	.AV connector 1 (AV1), 4 pin mini DIN (Output)
RGB input	
Input level	0.7 Vp-p (75Ω)
Jacks	.AV connector 2 (Input 1)
RGB output	
Output level	0.7 Vp-p (75Ω)
Jacks	.AV connector 1 (AV1)

Audio input	Input 1 (rear), 2 (front) L/R
Input level	
During audio input2V rms (Input impedance: more than 22 k Ω)
Jacks	AV connector 2 (Input 1), RCA jacks (Input 2)
Audio output	AV1 Output
During audio output2V rms (Output impedance: less than 1.5 k Ω)
Jacks	AV connector 1 (AV1), RCA jacks (Output)
Control input	Mini jack
DV input/output (DVR-520H/720H only)	4 pin (i.LINK/IEEE 1394 standard)

AV Connectors (21-pin connector assignment)

AV connector input/output 21-pin connector
This connector provides the video and audio signals for connection to a compatible colour TV or monitor.

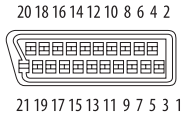

PIN no.	AV1(RGB)-TV / AV2(INPUT 1)
1	Audio 2/R out / Audio 2/R out
2	- / Audio 2/R in
11	G out / G in
3	Audio 1/L out / Audio 1/L out
6	- / Audio 1/L in
15	R or C out / R or C in
4	GND
17	GND
7	B out / B in
19	Video out or Y out / Video out
20	- / Video in or Y in
8	Status
21	GND

Supplied accessories

Remote control	1
Dry cell batteries (AA/R6P)	2
Audio / Video cable (red/white/yellow)	1
RF antenna cable	1
Power cable	1
Warranty card	1
Operating Instructions	

Note: The specifications and design of this product are subject to change without notice, due to improvement.

Index

A

Adjusting the picture quality **94–96**
 Audio DRC **96**
 Audio language **23, 43, 105**
 Audio settings **103–105**
 Auto language **105, 106**
 Auto Scan - see Automatic channel setup
 Automatic channel setup **25, 99**
 AV amplifier (connecting to) **19, 27**
 AV connector **12, 14–18, 98, 100, 102, 126**

B

Bilingual audio **22, 29, 44, 46, 48, 103, 104, 116**

C

Camcorder - see DV camcorder
 Changing TV channels **29, 112**
 Chase play - see Simultaneous recording and playback
 Copy List **63–74, 108, 116**
 CPRM **46, 120**

D

Disc and file formats **9, 113**
 Disc compatibility - see Disc and file formats
 Disc Navigator **36–37, 76–88, 108**
 Dolby Digital **6, 27, 43, 44, 46, 96, 104, 122**
 Downloading channel presets from the TV **13, 25, 100**
 DV camcorder **7, 20, 57, 58, 117**

E

Easy Timer Recording **6, 50**
 Editing recordings **76–88**

F

Finalizing discs **34, 59, 93**

I

Initializing discs **45, 60, 93, 108**
 Input colour system **98, 102**
 Input line system **98, 102, 103**

J

JPEG picture files **7, 10, 35, 90–91, 123**

M

Manual channel setup **100**
 Manual recording mode (MN) **22, 47, 107, 118**
 MP3 audio **7, 9, 32, 123**
 MPEG audio **12, 105, 123**

N

NICAM audio **29, 103**
 NTSC **22, 45, 46, 95, 96, 98, 102, 103**

O

One Touch Copy **6, 21, 23, 61, 62–63, 116**
 One Touch Recording **7, 48**
 On-screen display (OSD) **33, 105**
 Optimized recording **7, 52, 65, 107, 116**
 Original content **7, 11, 23, 34, 76, 78, 79–83, 87**
 OSD - see On-screen display (OSD)

P

PAL **45, 46, 98, 99, 102, 103**
 PBC (PlayBack Control for Video CD) **32, 36, 123**
 PhotoViewer **90–91**
 Picture quality - see Adjusting the picture quality and Recording quality
 Play List **7, 11, 22, 23, 34, 76, 79, 84–88**
 Play Mode menu **23, 40–42**
 Program play **41, 41–42**

R

Recording **6–7, 28, 35, 45–60**
 Recording quality **46, 47, 94**
 Recovery recording **7, 49**
 Remote control **8, 23, 99**
 Repeat play **41, 42**
 Rotating (a JPEG picture) **91**

S

Scanning **24, 38**
 SCART - see AV connector
 SECAM **45, 46, 98, 99, 102**
 Setting up **25–27, 112**
 Simultaneous recording and playback **6, 35, 55**
 Slow motion playback **39**
 Subtitle language **23, 43, 106**

T

Timer recording **6, 13, 17, 22, 24, 35, 49–55, 56**
 TV aspect ratio **108, 113**
 TV audio channel **29, 48, 103, 104**
 TV system - see Input line system and Input colour system

V

Video mode **7, 9, 10, 22, 35, 45, 59, 60, 62, 93, 108, 116, 118**
 VIDEO Plus+ **6, 23, 52–53, 101**
 Video settings **94–96, 102–103**
 VPS/PDC **6, 22, 49, 51, 52, 55**
 VR mode **10, 22, 45, 48, 59, 60, 62, 79, 84, 93, 108, 109, 117, 118**

W

WMA audio **7, 9, 32, 124**

Z

Zooming (a JPEG picture) **91**

Published by Pioneer Corporation.
Copyright © 2004 Pioneer Corporation.
All rights reserved.

PIONEER CORPORATION

4-1, Meguro 1-Chome, Meguro-ku, Tokyo 153-8654, Japan

PIONEER ELECTRONICS (USA) INC.

P.O. BOX 1540, Long Beach, California 90810-1540, U.S.A. TEL: (800) 421-1404

PIONEER ELECTRONICS OF CANADA, INC.

300 Allstate Parkway, Markham, Ontario L3R OP2, Canada TEL: 1-877-283-5901

PIONEER EUROPE NV

Haven 1087, Keetberglaan 1, B-9120 Melsele, Belgium TEL: 03/570.05.11

PIONEER ELECTRONICS ASIACENTRE PTE. LTD.

253 Alexandra Road, #04-01, Singapore 159936 TEL: 65-6472-7555

PIONEER ELECTRONICS AUSTRALIA PTY. LTD.

178-184 Boundary Road, Braeside, Victoria 3195, Australia, TEL: (03) 9586-6300

PIONEER ELECTRONICS DE MEXICO S.A. DE C.V.

Blvd.Manuel Avila Camacho 138 10 piso Col.Lomas de Chapultepec, Mexico,D.F. 11000 TEL: 55-9178-4270

K002_A_En

Free Manuals Download Website

<http://myh66.com>

<http://usermanuals.us>

<http://www.somanuals.com>

<http://www.4manuals.cc>

<http://www.manual-lib.com>

<http://www.404manual.com>

<http://www.luxmanual.com>

<http://aubethermostatmanual.com>

Golf course search by state

<http://golfingnear.com>

Email search by domain

<http://emailbydomain.com>

Auto manuals search

<http://auto.somanuals.com>

TV manuals search

<http://tv.somanuals.com>