

**Pioneer** *sound.vision.soul*

Plasma Display  
Écran à plasma  
プラズマディスプレイ  
**PDP-614MX**

Operating Instructions  
Mode d'emploi  
取扱説明書

JIS C 61000-3-2適合品

D50-5-10-1\_Ja

Published by Pioneer Corporation.  
Copyright © 2004 Pioneer Corporation.  
All rights reserved.

©2004 パイオニア株式会社 禁無断転載

この取扱説明書は再生紙を使用しています。

パイオニア株式会社 ☎153-8654 東京都目黒区目黒1丁目4番1号

**PIONEER CORPORATION** 4-1, Meguro 1-Chome, Meguro-ku, Tokyo 153-8654, Japan

**PIONEER ELECTRONICS (USA) INC.** P. O. BOX 1540, Long Beach, California 90801-1540, U.S.A. TEL: 1-310-952-2111

**PIONEER ELECTRONICS OF CANADA INC.** 300 Allstate Parkway, Markham, Ontario L3R 0P2, Canada TEL: 1-905-479-4411

Printed in Japan/ Imprimé au Japon

<7S801711>

Contents related to system specifications, power requirements, accessories, and other information differ with respect to the country where this unit is purchased. For customers living in the U.S.A. or Canada, please use and refer to the instructions written in either English or French. For customers in Japan, please use and refer to the instructions written in Japanese.

Les caractéristiques, les spécifications d'alimentation, les accessoires et d'autres informations diffèrent d'un pays à l'autre. Si vous vivez au Canada ou aux États-Unis, reportez-vous aux instructions en français ou en anglais. Si vous vivez au Japon, reportez-vous aux instructions en japonais.

電源、付属品などの差異がありますので、日本国内でご購入・ご使用の際は、本書の日本語ページをご覧ください。その他の国、地域でご購入・ご使用の際は、英語またはフランス語ページをご覧ください。

**「据付工事」について**

- 本機は十分な技術・技能を有する専門業者が据付けを行うことを前提に販売されているものです。据付け・取付けは必ず工事専門業者または販売店にご依頼ください。
- なお、据付け・取付けの不備、誤使用、改造、天災などによる事故損傷については、弊社は一切責任を負いません。



K042\_Ja

**販売店様へ**

この取扱説明書は据え付け終了後お客様に必ずお渡しして、取り扱い方法の説明を行ってください。

## Operating Instructions

Thank you very much for purchasing this PIONEER product. Before using your Plasma Display, please carefully read the "Important Information" and these "Operating Instructions" so you will know how to operate the Plasma Display properly. Keep this manual in a safe place. You will find it useful in the future.

### **Notes on Installation Work:**

This product is marketed assuming that it is installed by qualified personnel with enough skill and competence. Always have an installation specialist or your dealer install and set up the product. PIONEER cannot assume liabilities for damage caused by mistake in installation or routing, misuse, modification or a natural disaster.

### **Note for Dealers:**

After installation, be sure to deliver this manual to the customer and explain to the customer how to handle the product.

# Important Information

## Precautions

Please read this manual carefully before using your plasma monitor and keep the manual handy for future reference.



**CAUTION:** TO REDUCE THE RISK OF ELECTRIC SHOCK, DO NOT REMOVE COVER. NO USER-SERVICEABLE PARTS INSIDE. REFER SERVICING TO QUALIFIED SERVICE PERSONNEL.



This symbol warns the user that uninsulated voltage within the unit may have sufficient magnitude to cause electric shock. Therefore, it is dangerous to make any kind of contact with any part inside of this unit.



This symbol alerts the user that important literature concerning the operation and maintenance of this unit has been included. Therefore, it should be read carefully in order to avoid any problems.

## WARNING

TO PREVENT FIRE OR SHOCK HAZARDS, DO NOT EXPOSE THIS UNIT TO RAIN OR MOISTURE. ALSO DO NOT USE THIS UNIT'S POLARIZED PLUG WITH AN EXTENSION CORD RECEPTACLE OR OTHER OUTLETS, UNLESS THE PRONGS CAN BE FULLY INSERTED. REFRAIN FROM OPENING THE CABINET AS THERE ARE HIGH-VOLTAGE COMPONENTS INSIDE. REFER SERVICING TO QUALIFIED SERVICE PERSONNEL.

## Warning

Not for use in a computer room as defined in the Standard for the Protection of Electronic Computer/ Data Processing Equipment ANSI/NFPA 75.

This equipment has been tested and found to comply with the limits for a Class B digital device, pursuant to Part 15 of the FCC Rules. These limits are designed to provide reasonable protection against harmful interference in a residential installation. This equipment generates, uses, and can radiate radio frequency energy and, if not installed and used in accordance with the instructions, may cause harmful interference to radio communications. However, there is no guarantee that interference will not occur in a particular installation. If this equipment does cause harmful interference to radio or television reception, which can be determined by turning the equipment off and on, the user is encouraged to try to correct the interference by one or more of the following measures:

- Reorient or relocate the receiving antenna.
- Increase the separation between the equipment and receiver.
- Connect the equipment into an outlet on a circuit different from that to which the receiver is connected.
- Consult the dealer or an experienced radio / TV technician for help.

## Warnings and Safety Precaution

This plasma monitor is designed and manufactured to provide long, trouble-free service. No maintenance other than cleaning is required. Please see the section "Plasma monitor cleaning procedure" on the next page.

The plasma display panel consists of fine picture elements (cells) with more than 99.99 percent active cells. There may be some cells that do not produce light or remain lit.

For operating safety and to avoid damage to the unit, read carefully and observe the following instructions. To avoid shock and fire hazards:

1. Provide adequate space for ventilation to avoid internal heat build-up. Do not cover rear vents or install the unit in a closed cabinet or shelves.  
If you install the unit in an enclosure, make sure there is adequate space at the top of the unit to allow hot air to rise and escape. If the monitor becomes too hot, the overheat protector will be activated and the monitor will be turned off. If this happens, turn off the power to the monitor and unplug the power cord. If the room where the monitor is installed is particularly hot, move the monitor to a cooler location, and wait for 60 minutes to cool the monitor. If the problem persists, contact your dealer for service.
2. Do not use this unit's polarized plug with extension cords or outlets unless the prongs can be completely inserted.
3. Do not expose the unit to water or moisture.
4. Avoid damage to the power cord, and do not attempt to modify the power cord.
5. Unplug the power cord during electrical storms or if the unit will not be used over a long period.
6. Do not open the cabinet which has potentially dangerous high voltage components inside. If the unit is damaged in this way the warranty will be void. Moreover, there is a serious risk of electric shock.
7. Do not attempt to service or repair the unit. The manufacturer is not liable for any bodily harm or damage caused if unqualified persons attempt service or open the back cover. Refer all service to authorized Service Centers.

## NOTE:

When you connect a computer to this monitor, use an RGB cable including the ferrite core on both ends of the cable. And regarding DVI and power cable, attach the supplied ferrite cores. If you do not do this, this monitor will not conform to mandatory FCC standards.

Attaching the ferrite cores:

Set the ferrite cores on both ends of the DVI cable (not supplied), and both ends of the power cable (supplied). Close the lid tightly until the clamps click. Use the band to fasten the ferrite core (supplied) to the DVI cable.

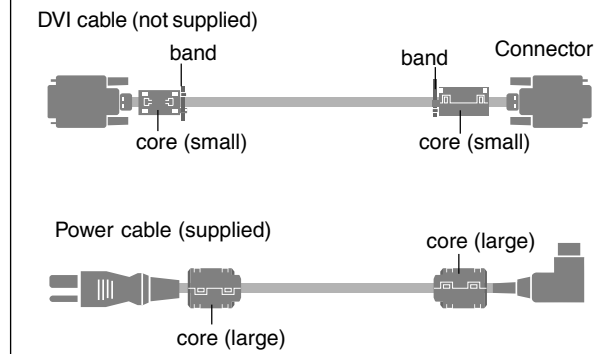

To avoid damage and prolong operating life:

1. Use only with 100-120V 50/60Hz AC power supply. Continued operation at line voltages greater than 100-120 Volts AC will shorten the life of the unit, and might even cause a fire hazard.
2. Handle the unit carefully when installing it and do not drop.
3. Set the unit away from heat, excessive dust, and direct sunlight.
4. Protect the inside of the unit from liquids and small metal objects. In case of accident, unplug the power cord and have it serviced by an authorized Service Center.
5. Do not hit or scratch the panel surface as this causes flaws on the surface of the screen.
6. For correct installation and mounting it is strongly recommended to use a trained, authorized dealer.
7. As is the case with any phosphor-based display (like a CRT monitor, for example) light output will gradually decrease over the life of a Plasma Display Panel.
8. To avoid sulfurization it is strongly recommended not to place the unit in a dressing room in a public bath or hot spring bath.
9. Do not use in a moving vehicle, as the unit could drop or topple over and cause injuries.
10. Do not place the unit on its side, upside-down or with the screen facing up or down, to avoid combustion or electric shock.

Plasma monitor cleaning procedure:

1. Use a wiping cloth (attached) or a soft dry cloth to clean the front panel and bezel area. Never use solvents such as alcohol or thinner to clean these surfaces.
2. Clean plasma ventilation areas with a vacuum cleaner with a soft brush nozzle attachment.

3. To ensure proper ventilation, cleaning of the ventilation areas must be carried out monthly. More frequent cleaning may be necessary depending on the environment in which the plasma monitor is installed.

Recommendations to avoid or minimize phosphor burn-in: Like all phosphor-based display devices and all other gas plasma displays, plasma monitors can be susceptible to phosphor burn under certain circumstances. Certain operating conditions, such as the continuous display of a static image over a prolonged period of time, can result in phosphor burn if proper precautions are not taken. To protect your investment in this plasma monitor, please adhere to the following guidelines and recommendations for minimizing the occurrence of image burn:

- \* Always enable and use your computer's screen saver function during use with a computer input source.
- \* Display a moving image whenever possible.
- \* Change the position of the menu display from time to time.
- \* Always power down the monitor when you are finished using it.

If the plasma monitor is in long term use or continuous operation take the following measures to reduce the likelihood of phosphor burn:

- \* Lower the Brightness and Contrast levels as much as possible without impairing image readability.
- \* Display an image with many colors and color gradations (i.e. photographic or photo-realistic images).
- \* Create image content with minimal contrast between light and dark areas, for example white characters on black backgrounds. Use complementary or pastel color whenever possible.
- \* Avoid displaying images with few colors and distinct, sharply defined borders between colors.

**\* Note:** Burn-in is not covered by the warranty.

Contact your dealer for other recommended procedures that will best suit your particular application needs.

## CAUTION:

WHEN POSITIONING THIS EQUIPMENT ENSURE THAT THE MAINS PLUG AND SOCKET IS EASILY ACCESSIBLE.

## Information to User

Alteration or modifications carried out without appropriate authorization may invalidate the user's right to operate the equipment.

## WARNING:

Handling the cord on this product or cords associated with accessories sold with the product will expose you to lead, a chemical known to the State of California and other governmental entities to cause cancer and birth defects or other reproductive harm. **Wash hands after handling.**

## IMPORTANT SAFETY INSTRUCTIONS

### Read before operating equipment

#### IMPORTANT NOTICE

The serial number for this equipment is located on the rear panel. Please write this serial number on your enclosed warranty card and keep in a secure place. This is for your security.

This Class B digital apparatus complies with Canadian ICES-003.

#### Caution

This model is for use with the following optional accessories. Use with other optional accessories is capable of resulting in instability causing possible injury.

Speakers: PDP-S29-LR  
Table top stand: PDK-TS06  
Wall mount unit: PDK-WM03

1. Read these instructions.
2. Keep these instructions.
3. Heed all warnings.
4. Follow all instructions.
5. Do not use this apparatus near water.
6. Clean only with a dry cloth.
7. Do not block any of the ventilation openings. Install in accordance with the manufacturers instructions.
8. Do not install near any heat sources such as radiators, heat registers, stoves, or other apparatus (including amplifiers) that produce heat.
9. Do not defeat the safety purpose of the polarized or grounding-type plug. A polarized plug has two blades with one wider than the other. A grounding type plug has two blades and third grounding prong. The wide blade or third prong are provided for your safety. When the provided plug does not fit into your outlet, consult an electrician for replacement of the obsolete outlet.
10. Protect the power cord from being walked on or pinched particularly at plugs, convenience receptacles, and the point where they exit from the apparatus.
11. Only use attachments/accessories specified by the manufacturer.
12.  Use only with a cart, stand, tripod, bracket, or table specified by the manufacturer, or sold with the apparatus. When a cart is used, use caution when moving the cart/apparatus combination to avoid injury from tip-over.
13. Unplug this apparatus during lightning storms or when unused for long periods of time.
14. Refer all servicing to qualified service personnel. Servicing is required when the apparatus has been damaged in any way, such as power-supply cord or plug is damaged, liquid has been spilled or objects have fallen into apparatus, the apparatus has been exposed to rain or moisture, does not operate normally, or has been dropped.
15. **Damage Requiring Service** - The appliance should be serviced by qualified service personnel when:
  - A. The power supply cord or the plug has been damaged; or
  - B. Objects have fallen, or liquid has been spilled into the appliance; or
  - C. The appliance has been exposed to rain; or
  - D. The appliance does not appear to operate normally or exhibits a marked change in performance; or
  - E. The appliance has been dropped, or the enclosure damaged.
16. **Tilt/Stability** - All televisions must comply with recommended international global safety standards for tilt and stability properties of its cabinets design.
  - Do not compromise these design standards by applying excessive pull force to the front, or top, of the cabinet which could ultimately overturn the product.
  - Also, do not endanger yourself, or children, by placing electronic equipment/toys on the top of the cabinet. Such items could unsuspectingly fall from the top of the set and cause product damage and/or personal injury.
17. **Wall Mounting** - The appliance should be mounted to a wall only as recommended by the manufacturer.
18. **Power Lines** - An outdoor antenna should be located away from power lines.
19. **Outdoor Antenna Grounding** - If an outside antenna is connected to the receiver, be sure the antenna system is grounded so as to provide some protection against voltage surges and built up static charges. Section 810 of the National Electric Code, ANSI/NFPA No. 70- 1984, provides information with respect to proper grounding of the mats and supporting structure grounding of the lead-in wire to an antenna-discharge unit, size of grounding connectors, location of antenna-discharge unit, connection to grounding electrodes and requirements for the grounding electrode.
20. **Objects and Liquid Entry** - Care should be taken so that objects do not fall and liquids are not spilled into the enclosure through openings.

Apparatus shall not be exposed to dripping or splashing and that no objects filled with liquids, such as vases, shall be placed on apparatus.

#### WARNING

To reduce the risk of fire or electric shock, do not expose this apparatus to rain or moisture.

## DECLARATION OF CONFORMITY

This device complies with Part 15 of FCC Rules. Operation is subject to the following two conditions. (1) This device may not cause harmful interference, and (2) this device must accept any interference received, including interference that may cause undesired operation.

<b>U.S. Responsible Party:</b>	<b>PIONEER ELECTRONICS (USA) INC.</b>
<b>Address:</b>	<b>P.O. BOX 1760, LONG BEACH, CA., 90801-1760 U.S.A.</b>
<b>Tel. No.:</b>	<b>800 (421-1625)</b>

Type of Product: Plasma Display  
Equipment Classification: Class B Peripheral  
Models: PDP-614MX

*We hereby declare that the equipment specified above conforms to the technical standards as specified in the FCC Rules.*



# Contents

<b>Installation .....</b>	<b>2</b>	Option2 Settings Menu .....	19
Ventilation Requirements for enclosure mounting .....	2	Setting the power management for computer images .....	19
How to use the safety metal fittings and the screws for safety metal fittings .....	2	STANDBY/ON indicator .....	19
Creating a video wall .....	3	Setting the picture to suit the movie .....	19
Cable Management .....	3	Reducing burn-in of the screen .....	19
Caution on when the plasma monitor is installed vertically .....	4	Setting the gray level for the SIDE MASK .....	21
How to use the remote control .....	4	Setting the screen size for S1/S2 video input .....	22
Battery Installation and Replacement .....	4	Setting the picture size for RGB input signals .....	22
Using the wired remote control mode .....	4	Setting the signal and black level for DVI signal .....	22
Operating Range .....	4	<b>Option3 Settings Menu .....</b>	<b>23</b>
Handling the remote control .....	4	Using the timer .....	23
<b>Part Names and Function .....</b>	<b>5</b>	Setting the power on mode .....	24
Front View .....	5	Enabling/disabling the front panel controls .....	24
Rear View/ Terminal Board .....	6	Enabling/disabling remote control wireless transmission .....	24
Remote Control .....	7	Loop Out setting .....	24
<b>Basic Operations .....</b>	<b>8</b>	ID number setting .....	25
POWER .....	8	Video Wall setting .....	25
To turn the unit ON and OFF: .....	8	Advanced OSD Settings Menu .....	27
VOLUME .....	8	Setting the menu mode .....	27
To adjust the sound volume: .....	8	Color System Settings Menu .....	28
MUTING .....	8	Setting the video signal format .....	28
To mute the sound: .....	8	Source Information Menu .....	28
DISPLAY .....	8	Checking the frequencies, polarities of input signals, and resolution .....	28
To check the settings: .....	8	<b>Pin Assignments .....</b>	<b>29</b>
DIGITAL ZOOM .....	8	mini D-Sub 15-pin connector (Analog) .....	29
AUTO SET UP .....	8	DVI-D 24-pin connector (Digital) .....	29
To adjust the size or quality of the picture automatically: .....	8	<b>Table of Signals Supported .....</b>	<b>30</b>
OFF TIMER .....	8	<b>Troubleshooting .....</b>	<b>32</b>
To set the off timer: .....	8	<b>Specifications .....</b>	<b>33</b>
To check the remaining time: .....	8		
To cancel the off timer: .....	8		
<b>WIDE Operations .....</b>	<b>9</b>		
SCREEN SIZE Operation (manual) .....	9		
When viewing videos or digital video discs .....	9		
SCREEN SIZE Operation with Computer Signals .....	10		
When "PICTURE SIZE" is set to "OFF" .....	10		
<b>OSD (On Screen Display) Controls .....</b>	<b>11</b>		
Menu Operations .....	11		
Setting the language for the menus .....	11		
Menu Tree .....	12		
Picture Settings Menu .....	14		
Adjusting the picture .....	14		
Setting the picture modes according to the brightness of the room .....	14		
Reducing noise in the picture .....	14		
Setting the color temperature .....	14		
Adjusting the color to the desired level .....	15		
Changing the Gamma Curve .....	15		
Making the Low Tone adjustments .....	15		
Adjusting the colors .....	15		
<b>SOUND Settings Menu .....</b>	<b>16</b>		
Adjusting the treble, bass and left/right balance and audio input select .....	16		
Setting the allocation of the audio connectors .....	16		
<b>SCREEN Settings Menu .....</b>	<b>16</b>		
Adjusting the Position, Size, PHASE, CLOCK .....	16		
<b>Option1 Settings Menu .....</b>	<b>17</b>		
Setting the on-screen display .....	17		
Setting the BNC connectors .....	17		
Checking the signal being transmitted to PC1 terminal .....	17		
Setting a computer image to the correct RGB select screen .....	17		
Setting high definition images to the suitable screen size .....	18		
Setting the Input Skip .....	18		
Resetting to the default values .....	18		

Should this product require service in the U.S.A. and you wish to locate the nearest Pioneer Authorized Independent Service Company, or if you wish to purchase replacement parts, operating instructions, service manuals, or accessories, please call the number shown below.

8 0 0 - 4 2 1 - 1 6 2 5

Please do not ship your product to Pioneer without first calling Pioneer Electronics (USA) Inc. at the above listed number for assistance.

Pioneer Electronics (USA) Inc.  
P.O. BOX 1760, Long Beach,  
CA 90801-1760, U.S.A.

For warranty information please see the Limited Warranty sheet included with your product.

Should this product require service in Canada, please contact a Pioneer Canadian Authorized Dealer to locate the nearest Pioneer Authorized Service Company in Canada. Alternatively, please contact the Customer Satisfaction Department at the following address:

Pioneer Electronics of Canada, Inc.  
Customer Satisfaction Department  
300 Allstate Parkway, Markham, Ontario L3R 0P2  
(905)479-4411  
1(877)283-5901

For warranty information please see the Limited Warranty sheet included with your product.

5021\_EF

## Contents of the Package

- Plasma monitor
- Power cord
- Remote control with two AAA Batteries
- Manual
- Warranty
- Safety metal fittings (2pcs)\*
- Ferrite cores (large 2pcs, small 2pcs)
- Bands (2pcs)
- Cable clamps (5pcs)
- Wiping cloth

\* These are fittings for fastening the unit to a wall to prevent tipping due to external shock when using the stand (optional). Fasten the safety fittings to the holes in the back of the monitor using the safety fitting mount screws (see page 2).

## Options

- Wall mount unit
- Stand
- Speakers

# Installation

You can attach your optional mounts or stand to the plasma monitor in one of the following two ways:

- \* While it is upright. (See Drawing A)
- \* As it is laid down with the screen face down (See Drawing B). Lay the protective sheet, which was wrapped around the monitor when it was packaged, beneath the screen surface so as not to scratch the screen face.
- \* Do not touch or hold the screen face when carrying the unit.

- **This device cannot be installed on its own. Be sure to use a stand or original mounting unit. (Wall mount unit, Stand, etc.)**
  - \* See page 1.
  - **For correct installation and mounting it is strongly recommended to use a trained, authorized dealer.**
- Failure to follow correct mounting procedures could result in damage to the equipment or injury to the installer.**
- Product warranty does not cover damage caused by improper installation.**

\* Use only the mounting kit or stand provided by manufacturer and listed under Options.

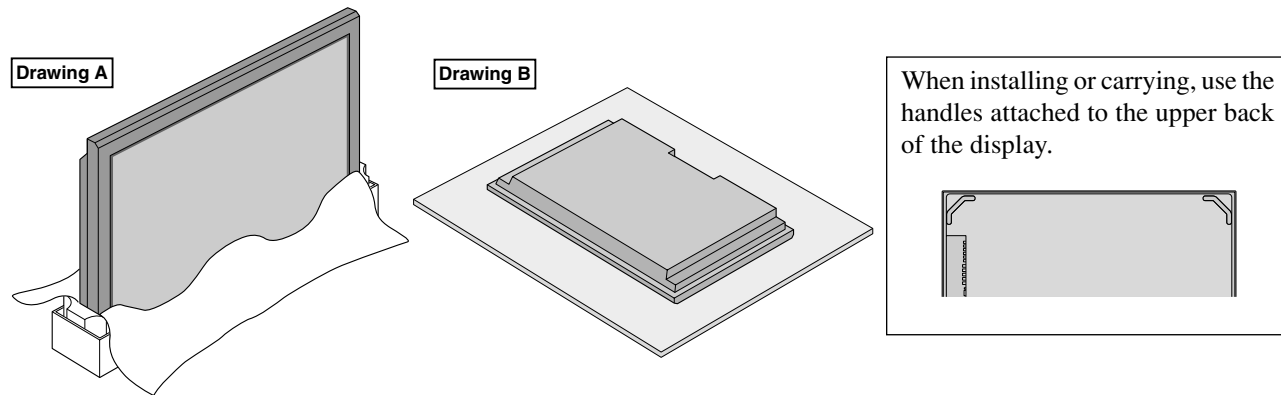

## Ventilation Requirements for enclosure mounting

To allow heat to disperse, leave space between surrounding objects as shown on the diagram below when installing.

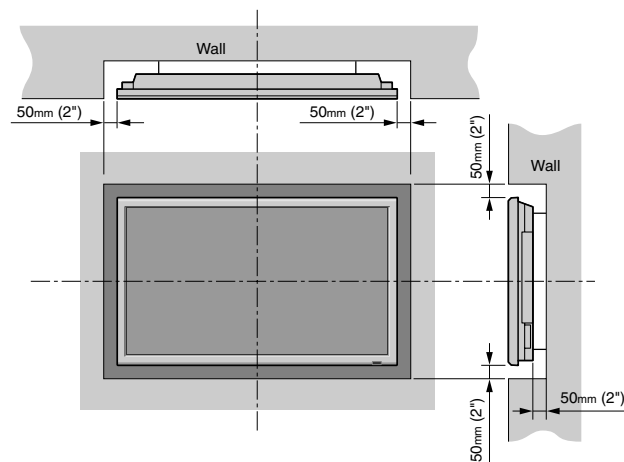

## How to use the safety metal fittings and the screws for safety metal fittings

These are fittings for fastening the unit to a wall to prevent tipping due to external shock when using the stand (optional). Fasten the safety fittings to the holes in the back of the monitor using the safety fitting mount screws.

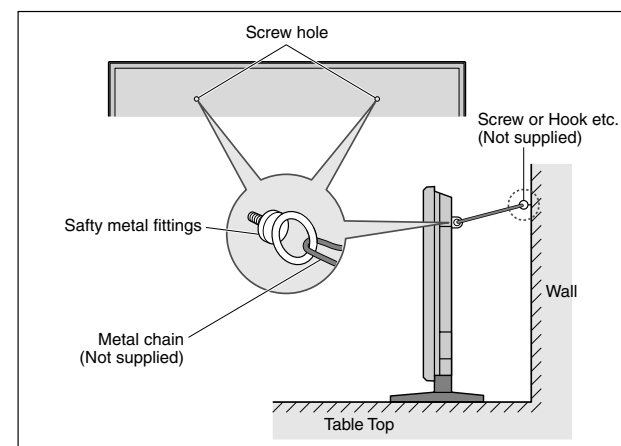

## Creating a video wall

With built-in matrix display capability, you can create a 4-25 video wall.

- Connect signal cables and remote cables as shown below.

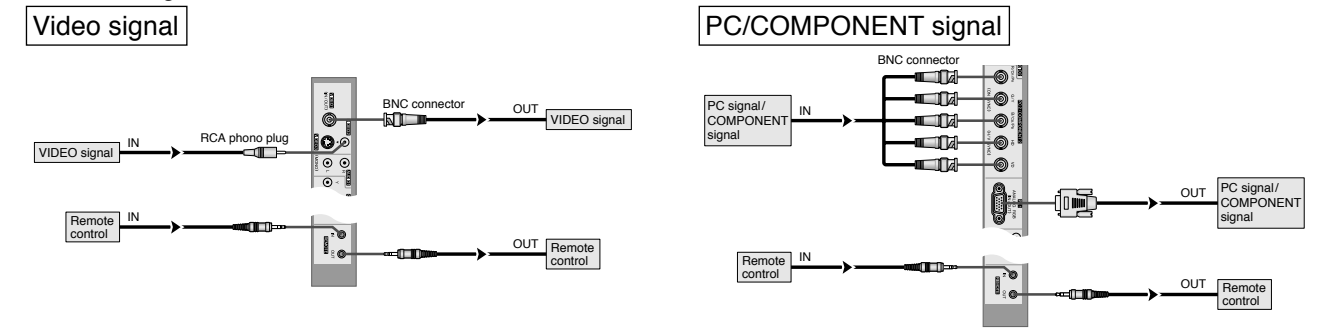

### Note:

1. The VIDEO1 and PC1 terminals can be used for either INPUT or OUTPUT. When LOOP OUT is ON, do not connect an OUTPUT signal from another unit, that will place an extraordinary load on the other unit and may damage it.
2. LOOP OUT can not be turned ON while signals are input to the PC1 terminal.
3. LOOP OUT can be turned ON while signals are input to the PC1 terminal if the POWER is switched ON.

### Information

- To loop signals out to another plasma display, set the LOOP OUT to ON.
- To create a video wall, set the VIDEO WALL menu items properly.
- To connect monitors, please use a 1~2m (3.3~6.6 feet) BNC cable (any commercially available cable).
- If the image quality is poor, do not use the monitor's out terminal. Use a distribution amplifier (any commercially available distribution amplifier) to connect the split signals to the respective monitor INPUT terminals.
- Being used as a video wall function, maximally 4-screen is rough-standard with lower than 1024×768, 60Hz signal.
- A distribution amplifier is particularly recommended when using 9-screen and over video wall.
- From the second monitor onward, connections require a BNC-RCA conversion cable or connector, a mini D-Sub 15 pin cable-BNC (×5) cable or a conversion connector.

## Cable Management

Using the cable clamps provided with the plasma display, bundle at the back of the unit the signal and audio cables connected to the display.

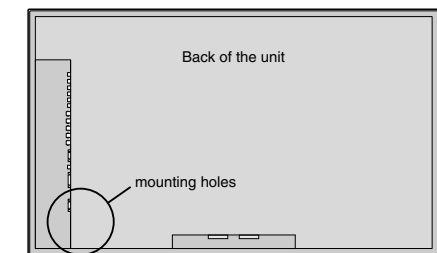

To attach

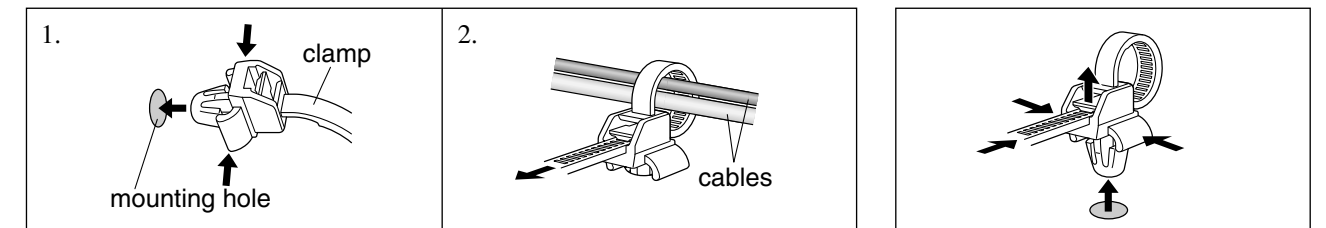

To detach

### Caution on when the plasma monitor is installed vertically

- Use the optional unit. Contact your store of purchase when installing.
- Rotate 90° clockwise as seen from the front when installing.
- After installing, check with the PIONEER logo mark as seen from the front.
- Be sure to set "OSD ANGLE" to "V" when using.
- \* Failure to heed the above cautions may lead to malfunction.

### How to use the remote control

#### Battery Installation and Replacement

Insert the 2 "AAA" batteries, making sure to set them in with the proper polarity.

1. Press and open the cover.

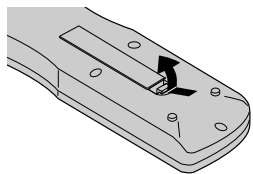

2. Align the batteries according to the (+) and (-) indication inside the case.

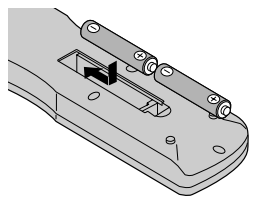

3. Replace the cover.

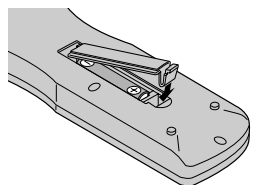

#### Using the wired remote control mode

Connect the remote cable\* to the remote control's remote jack and the "REMOTE IN" terminal on the monitor.

When the cable is connected, the mode automatically switches to wired remote control. When the wired remote control mode is used, the remote control can be operated even if no batteries are loaded.

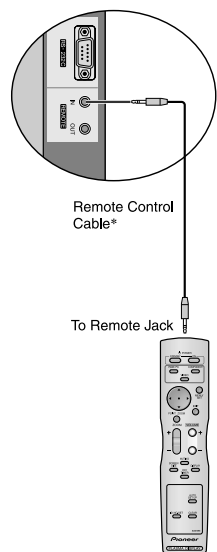

\* The 1/8 Stereo Mini cable must be purchased separately.

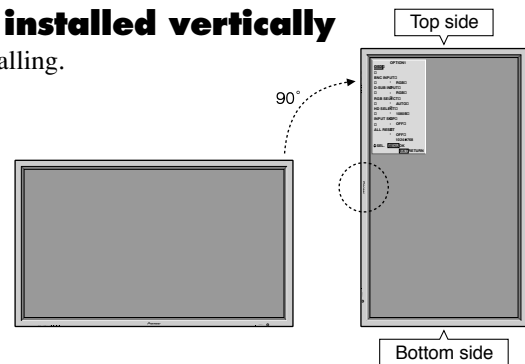

#### Operating Range

- \* Use the remote control within a distance of about 7 m / 23ft. from the front of the monitor's remote control sensor and at horizontal and vertical angles of up to approximately 30°.
- \* The remote control operation may not function if the monitor's remote control sensor is exposed to direct sunlight or strong artificial light, or if there is an obstacle between the sensor and the remote control.

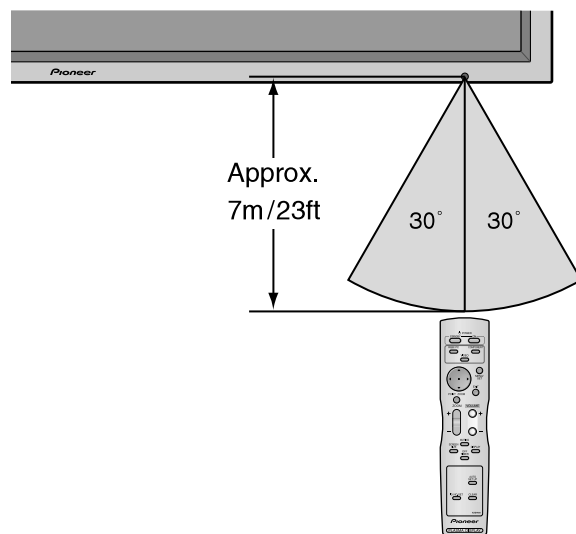

#### Handling the remote control

- Do not drop or mishandle the remote control.
- Do not get the remote control wet. If the remote control gets wet, wipe it dry immediately.
- Avoid heat and humidity.
- When not using the remote control for a long period, remove the batteries.
- Do not use new and old batteries together, or use different types together.
- Do not take apart the batteries, heat them, or throw them into a fire.
- When using the remote control in the wireless condition, be sure to unplug the remote cable from the REMOTE IN terminal on the monitor.
- When disposing of used batteries, please comply with governmental regulations or environmental public instruction's rules that apply in your country/area.

# Part Names and Function

## Front View

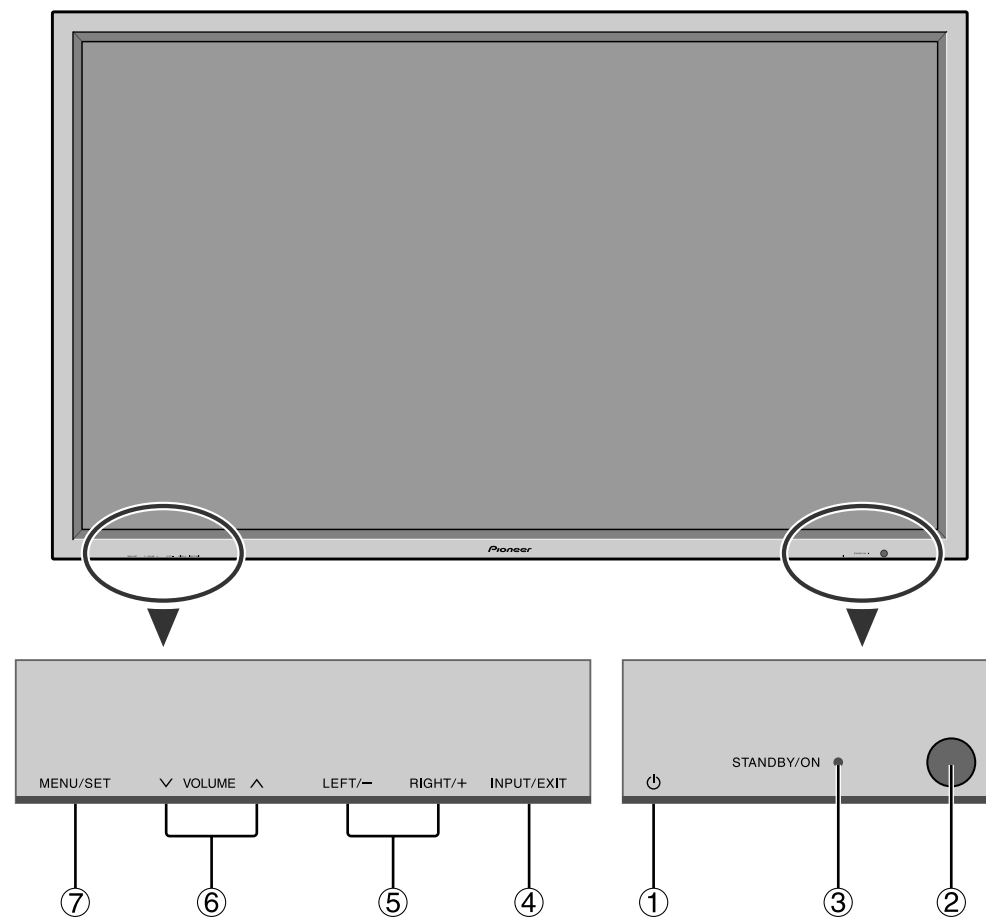

- ① **Power (⏻)**  
Turns the monitor's power on and off.
- ② **Remote sensor window**  
Receives the signals from the remote control.
- ③ **STANDBY/ON indicator**  
When the power is on ..... Lights green.  
When the power is in the standby mode ... Lights red.
- ④ **INPUT/EXIT**  
Switches the input.  
The available inputs depend on the setting of "BNC INPUT", "RGB SELECT" and "DVI SET UP".  
Functions as the EXIT buttons in the On-Screen Display (OSD) mode.
- ⑤ **LEFT/- and RIGHT/+**  
Functions as the CURSOR (◀/▶) buttons in the On-Screen Display (OSD) mode.
- ⑥ **VOLUME ∨ and ∧**  
Adjusts the volume. Functions as the CURSOR (▲/▼) buttons in the On-Screen Display (OSD) mode.
- ⑦ **MENU/SET**  
Sets the On-Screen Display (OSD) mode and displays the main menu.

### WARNING

The Power on/off switch does not disconnect the plasma display completely from the supply mains.

## Rear View/ Terminal Board

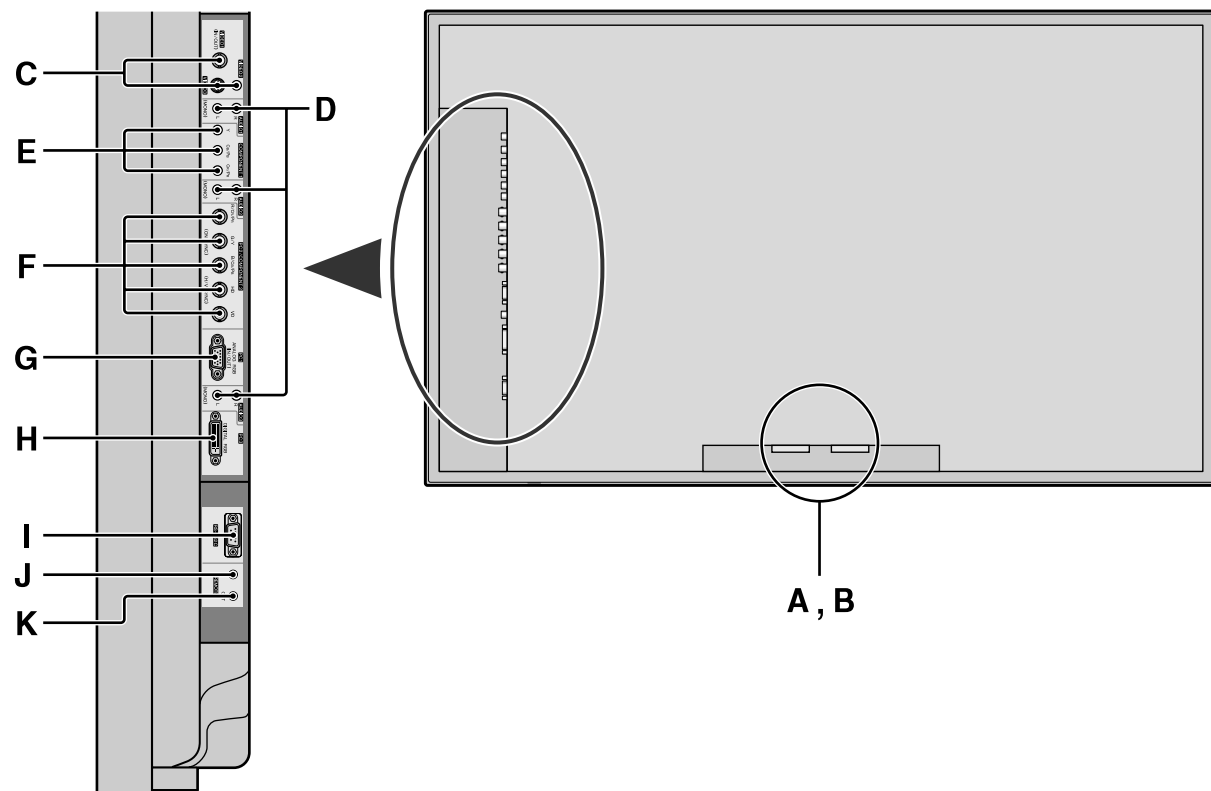

### A AC IN

Connect the included power cord here.

### B EXT SPEAKER L and R

Connect speakers (optional) here. Maintain the correct polarity. Connect the ⊕ (positive) speaker wire to the ⊕ EXT SPEAKER terminal and the ⊖ (negative) speaker wire to the ⊖ EXT SPEAKER terminal on both LEFT and RIGHT channels.

Please refer to your speaker's owner's manual.

### C VIDEO1, 2, 3 (BNC, RCA, S-Video)

Connect VCR's, DVD's or Video Cameras, etc. here. VIDEO1 can be used for Input or Output (see page 24).

### D AUDIO1, AUDIO2, AUDIO3

These are audio input terminals.

The input is selectable. Set which video image to allot them from the SOUND menu screen.

### E COMPONENT1

Connect DVD's, High Definition or Laser Discs, etc. here.

### F PC2/COMPONENT2

PC2: You can connect an analog RGB signal and the synchronization signal.

COMPONENT2: You can connect DVDs, High Definition sources, Laser Discs, etc. here.

This input can be set for use with an RGB or component source (see page 17).

### G PC1 (mini D-Sub 15pin)

Connect an analog RGB signal from a computer, etc. here. This input can be used for Input or Output (see page 24).

### H PC3 (DVI 24pin)

Connect a digital signal (TMDS) from a source with a DVI output.

### I RS-232C

**Never connect any component to this connector without first consulting your Pioneer installation technician.**

This connector is used for plasma display setup adjustments.

### J REMOTE IN

Connect the remote cable\* to the remote control's remote jack to obtain wired remote control.

### K REMOTE OUT

Connect the remote cable\* to the REMOTE IN jack of the other display monitor to obtain wired remote control.

\* The 1/8 Stereo Mini cable must be purchased separately.

## Remote Control

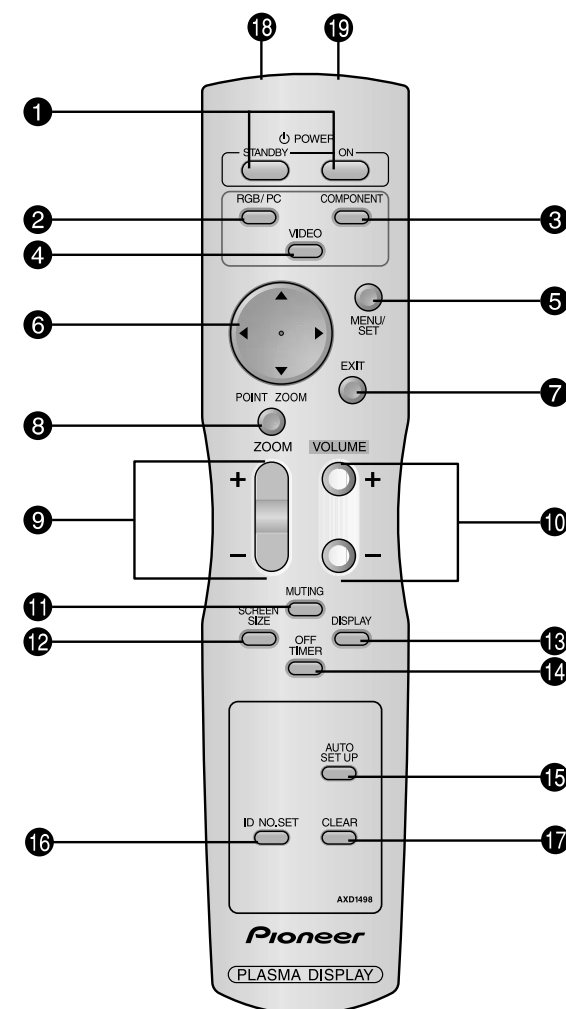

### 1 POWER ON/STANDBY

Switches the power on/standby. (This does not operate when STANDBY/ON indicator of the main unit is off.)

### 2 RGB/PC

Press this button to select RGB/PC as the source. RGB/PC can also be selected using the INPUT/EXIT button on the monitor.

### 3 COMPONENT

Press this button to select COMPONENT as the source. COMPONENT can also be selected using the INPUT/EXIT button on the monitor.

### 4 VIDEO

Press this button to select VIDEO as the source.



VIDEO can also be selected using the INPUT/EXIT button on the monitor.

### 5 MENU/SET

Press this button to access the OSD controls. Press this button during the display of the main menu to go to the sub menu.

### 6 CURSOR (▲/▼/◀/▶)

Use these buttons to select items or settings and to adjust settings.

### 7 EXIT

Press this button to exit the OSD controls in the main menu. Press this button during the display of the sub menu to return to the previous menu.

### 8 POINT ZOOM

Press this button to display the pointer.

### 9 ZOOM (+/-)

Enlarges or reduces the image.

### 10 VOLUME (+/-)

Adjusts the sound volume.

### 11 MUTING

Mutes the sound.

### 12 SCREEN SIZE

Automatically detects the signal and sets the aspect ratio. SCREEN SIZE button is not active for all signals.

### 13 DISPLAY

Displays the source settings on the screen.

### 14 OFF TIMER

Activates the off timer for the unit.

### 15 AUTO SET UP

Press this button to adjust PHASE, CLOCK, Position, and Contrast automatically, or to switch the screen size to ZOOM mode automatically with the superimposed caption displayed fully only when the picture contains dark areas above and below the picture.

### 16 ID NO. SET

Set the ID number in the remote control. The remote control can then be used only for a display with the same ID number. When several displays are used together they can be controlled individually.

### 17 CLEAR

Clears the number set by the ID NO. SET button.

### 18 Remote control signal transmitter

Transmits the remote control signals.

### 19 Remote Jack

Insert the plug of the remote cable (The 1/8 Stereo Mini cable) here when using the supplied remote control in the wired condition.



# Basic Operations

## POWER

### To turn the unit ON and OFF:

1. Plug the power cord into an active AC power outlet.
2. Press the Power button (on the unit).  
The monitor's STANDBY/ON indicator turns red and the standby mode is set.
3. Press the POWER ON button (on the remote control) to turn on the unit.  
The monitor's STANDBY/ON indicator will light up (green) when the unit is on.
4. Press the POWER STANDBY button (on the remote control) or the Power button (on the unit) to turn off the unit.  
The monitor's STANDBY/ON indicator turns red and the standby mode is set (only when turning off the unit with the remote control).

## VOLUME

### To adjust the sound volume:

1. Press and hold the VOLUME ⊕ button (on the remote control or the unit) to increase to the desired level.
2. Press and hold the VOLUME ⊖ button (on the remote control or the unit) to decrease to the desired level.

## MUTING

### To mute the sound:

Press the MUTING button on the remote control to mute the sound; press again to restore.

## DISPLAY

### To check the settings:

1. The screen changes each time the DISPLAY button is pressed.
2. If the button is not pressed for approximately three seconds, the menu turns off.

## DIGITAL ZOOM

Digital zoom specifies the picture position and enlarges the picture.

1. Press the POINT ZOOM button to display the pointer.  
()

### To change the size of the picture:

Press the ZOOM+ button and enlarge the picture.  
The pointer will change to resemble a magnifying glass.  
()  
A press of the ZOOM- button will reduce the picture and return it to its original size.

### To change the picture position:

Select the position with the ▲▼◀▶ buttons.

2. Press the POINT ZOOM button to delete the pointer.

## AUTO SET UP

### To adjust the size or quality of the picture automatically:

Press the AUTO SET UP button.

### Information

#### ■ AUTO SET UP ON setting

When RGB (still picture) input is selected:  
PHASE, CLOCK, Position, and Contrast will be adjusted automatically.

When RGB (motion picture), VIDEO, or Y/Pb/Pr (component) input is selected:

The screen size switches to ZOOM mode automatically with the superimposed caption displayed fully only when the picture contains dark areas above and below the picture.

## OFF TIMER

### To set the off timer:

The off timer can be set to turn the power off after 30, 60, 90 or 120 minutes.

1. Press the OFF TIMER button to start the timer at 30 minutes.
2. Press the OFF TIMER button to the desired time.
3. The timer starts when the menu turns off.

→ 30 → 60 → 90 → 120 → 0

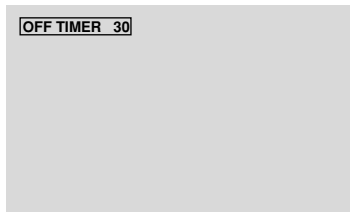

### To check the remaining time:

1. Once the off timer has been set, press the OFF TIMER button once.
2. The remaining time is displayed, then turns off after a few seconds.
3. When five minutes remain the remaining time appears until it reaches zero.

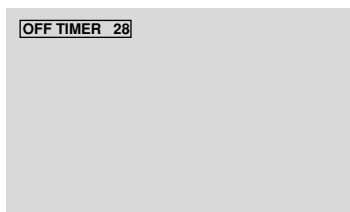

### To cancel the off timer:

1. Press the OFF TIMER button twice in a row.
2. The off timer is canceled.

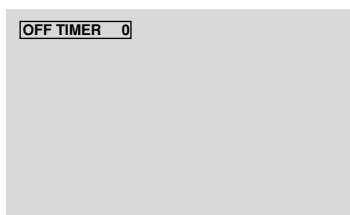

### Note:

After the power is turned off with the off timer ...  
A slight current is still supplied to the monitor. When you are leaving the room or do not plan to use the system for a long period of time, turn off the power of the monitor.

# WIDE Operations

## SCREEN SIZE Operation (manual)

With this function, you can select one of six screen sizes.

### When viewing videos or digital video discs

1. Press the SCREEN SIZE button on the remote control.
2. Within 3 seconds ...  
Press the SCREEN SIZE button again.  
The screen size switches as follows:

→ 4:3 → FULL → WIDE → ZOOM → 2.35:1 → 14:9

When a 720P or 1080I signal is input:

FULL ↔ 2.35:1

### 4:3 size screen

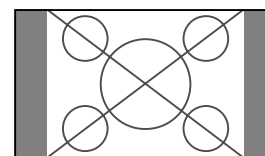

The normal size screen is displayed.

\* The picture has the same size as video pictures with a 4 : 3 aspect ratio.

### FULL size screen

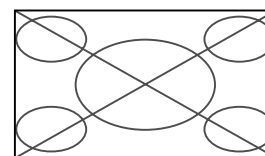

The image is expanded in the horizontal direction.

\* Images compressed in the horizontal direction ("squeezed images") are expanded in the horizontal direction and displayed on the entire screen with correct linearity. (Normal images are expanded in the horizontal direction.)

### WIDE size screen

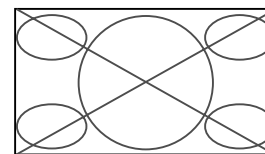

The picture is expanded in the horizontal and vertical directions at different ratios.

\* Use this for watching normal video programs (4:3) with a wide screen.

### ZOOM size screen

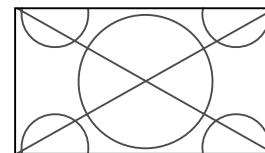

The picture is expanded in the horizontal and vertical direction, maintaining the original proportions.

\* Use this for theater size (wide) movies, etc.

### 2.35:1 size screen

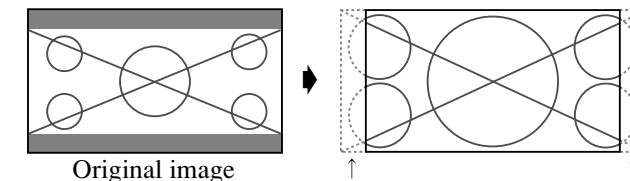

Original image

Information is lost on both sides.

The squeezed film image is expanded to fulfill the entire screen at a ratio of 2.35:1. Black bands do not appear at the top and bottom but information is lost on the left and right margins.

• This feature is available when the input signal is video, component (480I, 480P, 576I, 576P, 720P, 1080I) or RGB (525P or 625P signal from a scan converter).

\* If black bands appear on the top and bottom in the full size screen, select the 2.35:1 size screen to avoid phosphor burn-in.

### 14:9 size screen

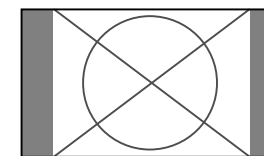

The image is displayed at a 14:9 aspect ratio.

\* This feature is available when the input signal is video, component (480I, 480P, 576I, 576P) or RGB (525P or 625P signal from a scan converter).

### Note:

Do not allow the displayed in 4:3 mode for an extended period. This can cause a phosphor burn-in.

## SCREEN SIZE Operation with Computer Signals

Switch to the wide screen mode to expand the 4 : 3 image to fill the entire screen.

1. Press the SCREEN SIZE button on the remote control.
2. Within 3 seconds ...

Press the SCREEN SIZE button again.  
The screen size switches as follows:

→ 4:3 → FULL → ZOOM

4:3 size screen (4:3 or SXGA 5:4)

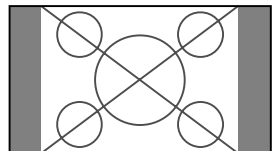

The picture has the same size as the normal computer image.

FULL size screen

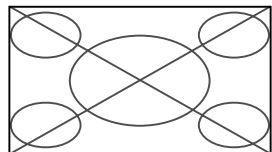

The image is expanded in the horizontal direction.

ZOOM size screen

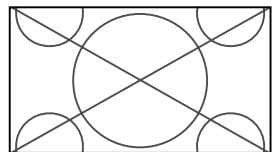

When wide signals are input.

FULL size screen

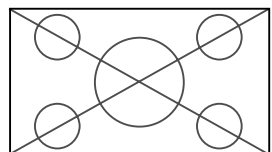

When "PICTURE SIZE" is set to "OFF"

\* This cannot be set in some models. "DOT BY DOT" will not be displayed in such cases.

The screen size switches as follows:

→ D BY D → FULL → ZOOM

DOT BY DOT screen (VGA, SVGA 4:3)

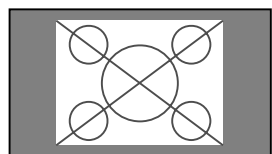

The image is dot by dot resolution.

FULL size screen

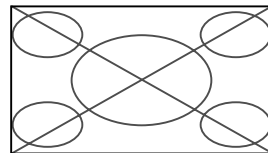

The image is expanded in the horizontal and vertical direction.

ZOOM size screen

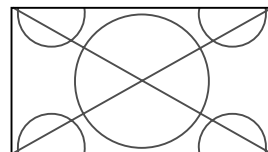

When wide signals are input.

FULL

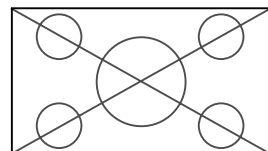

DOT BY DOT

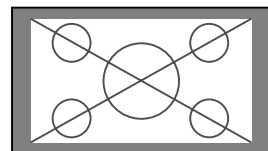

The image is dot by dot resolution.

\* "D BY D" can be switched only when a 1280 dot × 768 line signal is input.

### Information

#### Supported resolution

See page 30 for details on the display output of the various VESA signal standards supported by the monitor.

#### "PICTURE SIZE" setting

When the setting of "PICTURE SIZE" is OFF, the size of RGB-input pictures will be D BY D in place of 4:3.

#### When 852 (848) dot × 480 line wide VGA\* signals with a vertical frequency of 60 Hz and horizontal frequency of 31.7 (31.0) kHz are input

Select an appropriate setting for RGB SELECT mode referring to the "Table of Signals Supported" on page 30.

\* "VGA", "SVGA" and "SXGA" are registered trademarks of IBM, Inc. of the United States.

### Note:

Do not allow the displayed in 4:3 mode for an extended period. This can cause a phosphor burn-in.

# OSD (On Screen Display) Controls

## Menu Operations

The OSD window is displayed with respect to the screen as shown on the diagram.

\* Depending on the screen's mode, the OSD may be displayed differently.

In the explanation, the OSD section is shown close up.



The following describes how to use the menus and the selected items.

1. Press the MENU/SET button on the remote control to display the MAIN MENU.

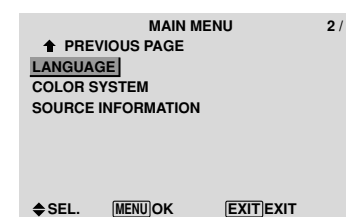
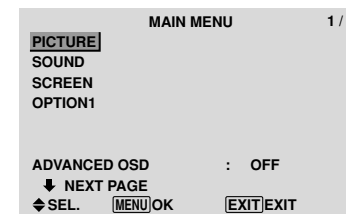

2. Press the cursor buttons ▲ ▼ on the remote control to highlight the menu you wish to enter.
3. Press the MENU/SET button on the remote control to select a sub menu or item.

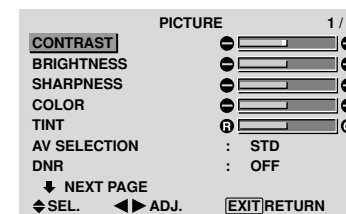

4. Adjust the level or change the setting of the selected item by using the cursor buttons ◀ ▶ on the remote control.
5. The adjustments or the settings that are stored in memory. The change is stored until you change it again.
6. Repeat steps 2 – 5 to adjust an additional item, or press the EXIT button on the remote control to return to the main menu.

\* When adjusting using the bar at the bottom of the screen, press the ◀ or ▶ button within 5 seconds. If not, the current setting is set and the previous screen appears.

**Note:** The main menu disappears by pressing the EXIT button.

### Information

#### Advanced menu mode

When "ADVANCED OSD" is set to "ON" in the main menu (1/2), full menu items will be shown.

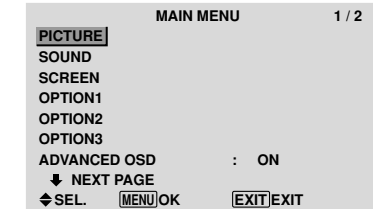

## Setting the language for the menus

The menu display can be set to one of seven languages.

Example: Setting the menu display to "DEUTSCH"

On "MAIN MENU", select "LANGUAGE", then press the MENU/SET button.

The "LANGUAGE" screen appears.

On "LANGUAGE", select "DEUTSCH", then press the MENU/SET button.

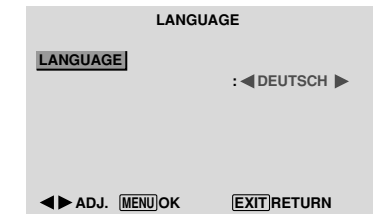

The "LANGUAGE" is set to "DEUTSCH" and return to the main menu.

### Information

#### Language settings

ENGLISH .....	English	ITALIANO .....	Italian
DEUTSCH .....	German	SVENSKA .....	Swedish
FRANÇAIS .....	French	日本語 .....	Japanese
ESPAÑOL .....	Spanish		







WIDE1: When an 852 dot × 480 line signal with a horizontal frequency of 31.7kHz is input, the image may be compressed horizontally. To prevent this, set RGB SELECT to WIDE1.

WIDE2: When an 848 dot × 480 line signal with a horizontal frequency of 31.0 kHz is input, the image may be compressed horizontally. To prevent this, set RGB SELECT to WIDE2.

WIDE3: When an 1920 dot × 1200 line signal with a horizontal frequency of 74.0 kHz is input, the image may be compressed horizontally. To prevent this, set RGB SELECT to WIDE3.

WIDE4: When an 1280 dot × 768 line signal with a horizontal frequency of 59.8 kHz or an 1680 dot × 1050 line signal with a horizontal frequency of 60 kHz is input, the image may be compressed horizontally. To prevent this, set RGB SELECT to WIDE4.

DTV: Set this mode when watching digital broadcasting (480P).

See page 30 for the details of the above settings.

Setting high definition images to the suitable screen size

Use this procedure to set whether the number of vertical lines of the input high definition image is 1035 or 1080.

Example: Setting the “HD SELECT” mode to “1035I”

On “HD SELECT” of “OPTION1” menu, select “1035I”.

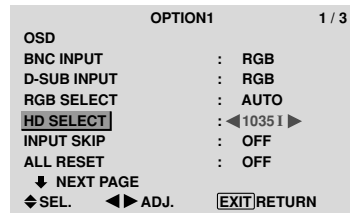

Information

HD SELECT modes

These 3 modes are not displayed in correct image automatically.

- 1080B: Standard digital broadcasts
1035I: Japanese “High Vision” signal format
1080A: Special Digital broadcasts (for example : DTC100)

Setting the Input Skip

When this is ON, signals which are not present will be skipped over and only pictures whose signals are being transmitted will be displayed.

This setting is valid only for the INPUT/EXIT button on the unit.

Example: Set to “ON”

On “INPUT SKIP” of “OPTION1” menu, select “ON”.

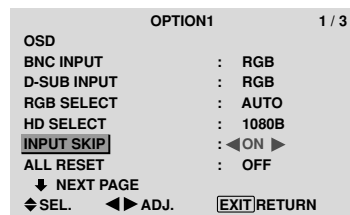

Information

INPUT SKIP settings

OFF: Regardless of the presence of the signal, scan and display all signals.

ON: If no input signal is present, skip that signal.

\* “SETTING NOW” will appear during the input search.

Resetting to the default values

Use these operations to restore all the settings (PICTURE, SOUND, SCREEN, OPTION1~3, etc) to the factory default values.

Refer to page 12 for items to be reset.

On “ALL RESET” of “OPTION1” menu, select “ON”, then press the MENU/SET button.

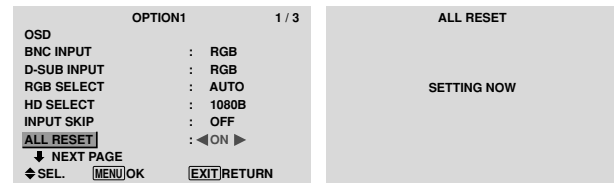

When the “SETTING NOW” screen disappears, then all the settings are restored to the default values.

Option2 Settings Menu

Setting the power management for computer images

This energy-saving (power management) function automatically reduces the monitor’s power consumption if no operation is performed for a certain amount of time.

Example: Turning the power management function on
Set “ADVANCED OSD” to “ON” in the main menu (1/2), then perform the following operations.

On “PWR. MGT.” of “OPTION2” menu, select “ON”.

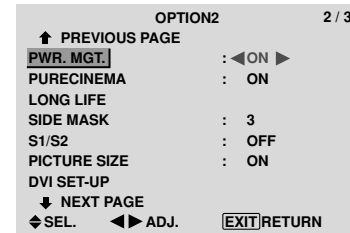

Information

Power management function

\* The power management function automatically reduces the monitor’s power consumption if the computer’s keyboard or mouse is not operated for a certain amount of time.

\* If the computer’s power is not turned on or if the computer and selector tuner are not properly connected, the system is set to the off state.

\* For instructions on using the computer’s power management function, refer to the computer’s operating instructions.

Power management settings

ON: In this mode the power management function is turned on.

OFF: In this mode the power management function is turned off.

Power management function and STANDBY/ON indicator

The STANDBY/ON indicator indicates the status of the power management function. See below for indicator status and description.

STANDBY/ON indicator

Table with 5 columns: Power management mode, STANDBY/ON indicator, Power management operating status, Description, Turning the picture back on.

Setting the picture to suit the movie

The film image is automatically discriminated and projected in an image mode suited to the picture.

[NTSC, PAL, PAL60, 480I (60Hz), 525I (60Hz), 576I (50Hz), 625I (50Hz), 1035I (60Hz), 1080I (60Hz) only]

Example: Setting the “PURECINEMA” to “OFF”

Set “ADVANCED OSD” to “ON” in the main menu (1/2), then perform the following operations.

On “PURECINEMA” of “OPTION2” menu, select “OFF”.

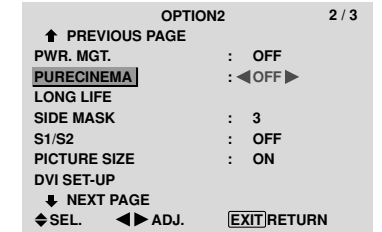

Information

PURECINEMA

ON: Automatic discrimination of the image and projection in PURECINEMA.

OFF: PURECINEMA does not function.

Reducing burn-in of the screen

The brightness of the screen, the position of the picture, positive/negative mode and screen wiper are adjusted to reduce burn-in of the screen.

Set “ADVANCED OSD” to “ON” in the main menu (1/2), then perform the following operations.

On “OPTION2” menu, select “LONG LIFE”, then press the MENU/SET button.

The “LONG LIFE” screen appears.

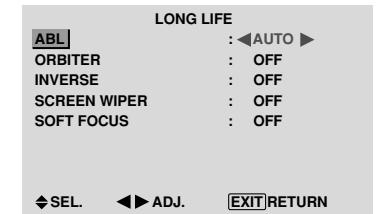

ABL (Auto Brightness Limiter)

Use this to activate the brightness limiter.

Example: Setting “ABL” to “LOCK1”

On “ABL” of “LONG LIFE” menu, select “LOCK1”.

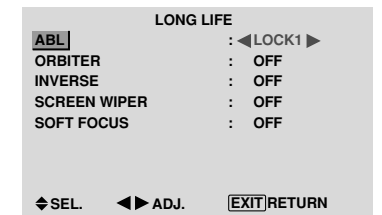

Information

ABL settings

AUTO: The brightness of the screen is adjusted automatically to suit the picture quality.

LOCK1, 2, 3: Sets maximum brightness.

The brightness level decreases in the order of LOCK 1, 2, 3. LOCK 3 provides minimum brightness.







## Setting the power on mode

This function sets the input mode at the time the power is switched on.

Example: Setting "VIDEO2"

Set "ADVANCED OSD" to "ON" in the main menu (1/2), then perform the following operations.

On "PWR. ON MODE" of "OPTION3" menu, select "VIDEO2".

The available inputs depend on the setting of input.

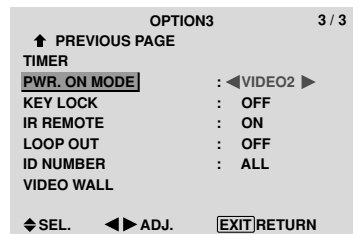

### Information

#### ■ PWR. ON MODE settings

LAST: Last mode (the input that was last selected at the time the power was switched off).

VIDEO1, 2, 3: VIDEO input mode.

PC1, 2, 3: PC input mode.

COMPONENT1, 2: COMPONENT input mode.

Follow the procedure used for PROGRAM TIMER. See page 23.

## Enabling/disabling the front panel controls

This function enables/disables the front panel controls.

Example: Setting "ON"

Set "ADVANCED OSD" to "ON" in the main menu (1/2), then perform the following operations.

On "KEY LOCK" of "OPTION3" menu, select "ON", then press the MENU/SET button.

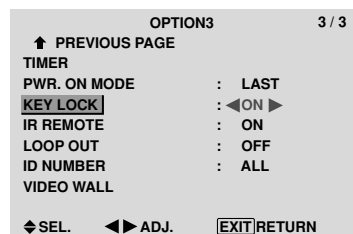

### Information

#### ■ KEY LOCK settings

ON: Disables the buttons on the front panel.

OFF: Enables the buttons on the front panel.

\* Even when the KEY LOCK is set, the POWER switch will not be locked.

\* This becomes effective when the OSD goes out.

## Enabling/disabling remote control wireless transmission

This function enables/disables remote control wireless transmission.

Example: Setting "OFF"

Set "ADVANCED OSD" to "ON" in the main menu (1/2), then perform the following operations.

On "IR REMOTE" of "OPTION3" menu, select "OFF", then press the MENU/SET button.

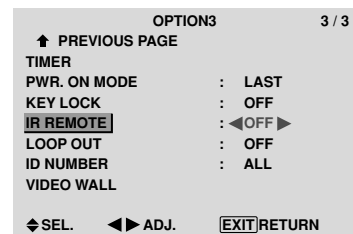

### Information

#### ■ IR REMOTE settings

ON: Enables remote control wireless transmission.

OFF: Disables remote control wireless transmission.

Set "OFF" to avoid unwanted control from other remote controls.

## Loop Out setting

When this feature is set to ON, the received signal will be looped out.

Example: Setting "ON"

Set "ADVANCED OSD" to "ON" in the main menu (1/2), then perform the following operations.

On "LOOP OUT" of "OPTION3" menu, select "ON".

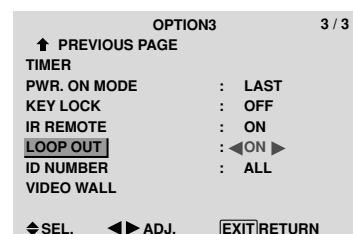

### Information

#### ■ LOOP OUT settings

ON: The received signal will be looped out via PC1 terminal or VIDEO1 terminal.

OFF: The received signal will not loop out.

\* Even if LOOP OUT is ON, signals won't be sent out if POWER is being turned off.

#### ■ To connect another display...

See page 3.

#### ■ If the PC1 signal is present at the time the power switched on...

The PC1 input will be displayed regardless of the setting of LOOP OUT.

## ID number setting

When using more than one of these displays, this function sets ID numbers so that operation of the remote control does not cause multiple monitors to operate at the same time.

Example: Setting "2"

Set "ADVANCED OSD" to "ON" in the main menu (1/2), then perform the following operations.

On "ID NUMBER" of "OPTION3" menu, select "2".

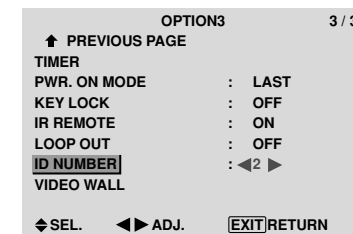

\* To reset back to ALL

Press the CLEAR button.

### Information

#### ■ ID NUMBER settings

ALL: ID NUMBER will not be set.

1 to 256: ID NUMBER will be set.

#### ■ When the ID NUMBER have been set

You can also set ID NUMBER for each remote control to operate the plasma display individually. To do so, see below.

## To set the ID number for the remote control

Example: Setting "2"

Press the ID NO. SET button on the remote control.

The "ID NO. SET" screen appears.

On "ID NUMBER" of "ID NO. SET" menu, select "2".

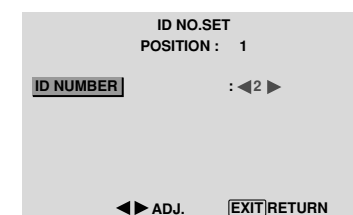

\* To reset back to ALL

Press the CLEAR button.

## Video Wall setting

When creating a video wall, use a distribution amplifier (any commercially available distribution amplifier) to connect the split signals to the respective monitor INPUT terminals.

Use this feature to configure a 4-25 video wall.

Set "ADVANCED OSD" to "ON" in the main menu (1/2), then perform the following operations.

On "OPTION3" menu, select "VIDEO WALL", then press the MENU/SET button.

The "VIDEO WALL" screen appears.

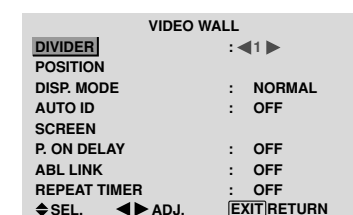

**Note:** A contingency method of shutting off the electric power should be used in cases of emergency during video wall setup.

## DIVIDER

Set the 4-25 video wall.

Example: Setting "4"

On "DIVIDER" of "VIDEO WALL" menu, select "4".



### Information

#### ■ DIVIDER settings

OFF, 1: 1 Screen (Matrix display function does not work)

4: 4 Screens (2x2 video wall)

9: 9 Screens (3x3 video wall)

16: 16 Screens (4x4 video wall)

25: 25 Screens (5x5 video wall)

\* When you select 4-25, set the VIDEO WALL POSITION.

## VIDEO WALL POSITION

Set the position of each display.

Example: Setting "4"

On "VIDEO WALL" menu, select "POSITION", then press the MENU/SET button.

The "VIDEO WALL POSITION" screen appears.

Select "NO. 4" of "POSITION NO.".

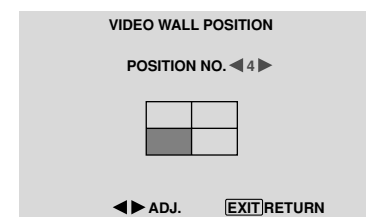

### Information

#### ■ VIDEO WALL POSITION settings

1 Screen: There is no need to set POSITION.

4 Screens

NO. 1	NO. 2
NO. 4	NO. 3

9 Screens

NO. 7	NO. 8	NO. 9
NO. 10	NO. 11	NO. 12
NO. 13	NO. 14	NO. 15

16 Screens

NO. 16	NO. 17	NO. 18	NO. 19
NO. 20	NO. 21	NO. 22	NO. 23
NO. 24	NO. 25	NO. 26	NO. 27
NO. 28	NO. 29	NO. 30	NO. 31

25 Screens

NO. 32	NO. 33	NO. 34	NO. 35	NO. 36
NO. 37	NO. 38	NO. 39	NO. 40	NO. 41
NO. 42	NO. 43	NO. 44	NO. 45	NO. 46
NO. 47	NO. 48	NO. 49	NO. 50	NO. 51
NO. 52	NO. 53	NO. 54	NO. 55	NO. 56

## DISP. MODE

Select the screen mode from between two options (NORMAL, ADJUST).

Example: Setting "ADJUST"

On "DISP. MODE" of "VIDEO WALL" menu, select "ADJUST".

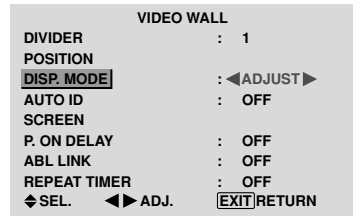

### Information

#### ■ DISP. MODE settings

**NORMAL:** Combines enlarged screens and creates multiple screens.

**ADJUST:** Corrects misalignment of combined screen portions and creates multiple screens

## AUTO ID

This feature automatically sets the ID numbers of multiple displays connected to each other.

Example: Setting "ON"

Set the ID number for the No. 1 display on ID NUMBER menu.

On "AUTO ID" of "VIDEO WALL" menu, select "ON", then press the MENU/SET button.

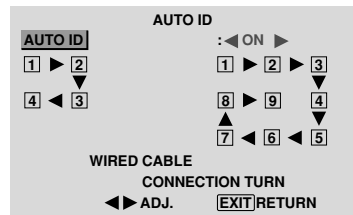

### Information

#### ■ AUTO ID settings

**ON:** Enables Auto ID function. In the case shown below, display 1 will be set as ID 1, display 2 as ID2, etc. This can be set only when a 2x2 or 3x3 video wall is selected.

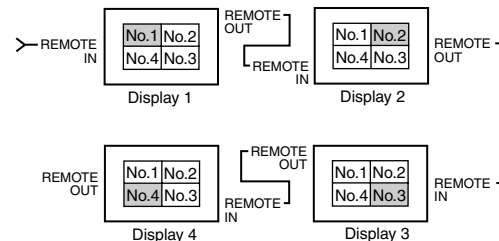

**OFF:** Disables Auto ID function.

## SCREEN

The position of the image can be adjusted and flickering of the image can be corrected.

Example: Adjusting the vertical position

On "VIDEO WALL" menu, select "SCREEN", then press the MENU/SET button.

The "SCREEN" screen appears.

On "V.POSITION" of "SCREEN" menu, adjust the position.

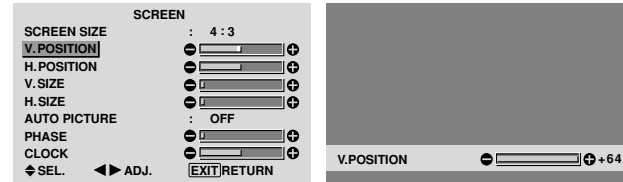

### Information

#### ■ SCREEN settings

These are the same functions as the SCREEN menu on page 16.

## P. ON DELAY (Power on delay)

Use this function to activate power-on delay.

Turn on the AUTO ID before the following operations.

Example: Setting "ON"

On "P. ON DELAY" of "VIDEO WALL" menu, select "ON".



### Information

#### ■ P. ON DELAY settings

**ON:** Turns on the main power of each display after a delay time.

**OFF:** Turns on the main power of all displays at the same time.

(Only for 16 and 25 screens)

**MODE1:** Turns on the main power of each display delayed.

**MODE2:** Turns on the main power of each display more delayed.

\* Once this function has been set to "ON", the POWER ON/OFF button on the remote control does not function except for the No.1 monitor.

By pressing the POWER ON button on the remote control the No.1 monitor will turn on and the others will be turned on one by one automatically.

\* From the second monitor onward, neither the POWER button on the unit nor the POWER ON button on the remote control works. However, by pressing and holding the POWER ON button for more than 3 seconds, the monitor will be turned on.

## ABL LINK

Use this function to set a uniform brightness for each display.

Turn on the AUTO ID and set the DIVIDER (at 1, 4 or 9) before the following operations.

Example: Setting "ON"

On "ABL LINK" of "VIDEO WALL" menu, select "ON", then press the MENU/SET button.

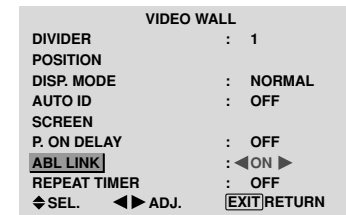

### Information

#### ■ ABL LINK settings

**ON:** Sets a uniform brightness for each screen in a video wall. This can be set only when a 2x2 or 3x3 video wall is selected.

**OFF:** Sets the individual screen brightness for each screen in a video wall.

\* When this function is set "ON", connect your plasma displays with the remote cable (optional) in the order of the position numbers for the 2x2 video wall. See the drawing below.

\* If there are changes in the DIVIDER or POSITION, the ABL LINK will automatically turn OFF.

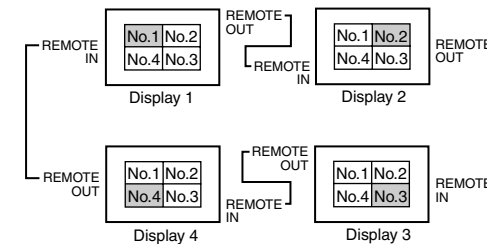

\* With the 3x3 video wall, connect the final display to the first display the same way as with 2x2 video wall.

**Note:** The remote control can be operated unless the IR REMOTE is set to "OFF".

## REPEAT TIMER

Use this to set two timers. Each timer can use the DIVIDER, SOURCE and WORK TIME functions.

Turn on the AUTO ID and set the DIVIDER (at 1, 4 or 9) before the following operations.

Example:

TIMER1...VIDEO1 will be displayed for 3 minutes. TIMER2...PC1 will be displayed for 6 minutes in a 2x2 video wall.

On "REPEAT TIMER" of "VIDEO WALL" menu, select "ON", then press the MENU/SET button.

The "REPEAT TIMER" screen appears.

Adjust the items.

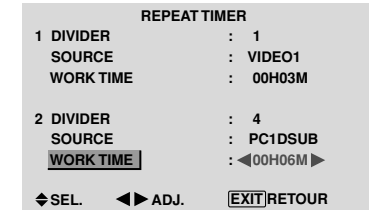

### Information

#### ■ REPEAT TIMER settings

**DIVIDER:** Divide the screen into 1, 4 or 9 sections.

**SOURCE:** Set the input mode to be displayed.

**WORK TIME:** Can be set to up to 4 hours 15 minutes in units of 1 minute.

If you set both timers, Timer 1 and Timer 2 run consecutively.

In the case of the Video wall, timer No.1 can be used to control all the displays simultaneously.

\* This becomes effective when the on-screen menu goes out.

## Advanced OSD Settings Menu

### Setting the menu mode

This allows you to access full menu items.

When P. ON DELAY or ABL LINK is ON, this won't be turned OFF.

Example: Setting "ON"

On "ADVANCED OSD" of "MAIN MENU", select "ON".

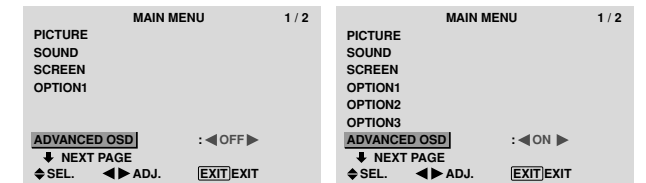

### Information

#### ■ ADVANCED OSD settings

**ON:** All of the main menu items are available for advanced users.

**OFF:** Some of the main menu items are not available (e.g. OPTION2 and OPTION3).

## Color System Settings Menu

### Setting the video signal format

Use these operations to set the color systems of composite video signals or Y/C input signals.

Example: Setting the color system to “3.58 NTSC”

On the MAIN MENU, select “COLOR SYSTEM”, then press the MENU/SET button.

The “COLOR SYSTEM” screen appears.

On “COLOR SYSTEM”, select “3.58NTSC”.

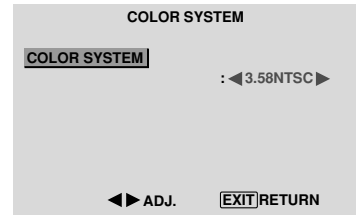

### Information

#### Video signal formats

Different countries use different formats for video signals. Set to the color system used in your current country.

**AUTO:** The color systems are automatically identified and the format is set accordingly.

**PAL:** This is the standard format used mainly in the United Kingdom and Germany.

**SECAM:** This is the standard format used mainly in France and Russia.

**4.43 NTSC, PAL60:** This format is used for videos in countries using PAL and SECAM video signals.

**3.58 NTSC:** This is the standard format used mainly in the United States and Japan.

**PAL-M:** This is the standard format used mainly in Brazil.

**PAL-N:** This is the standard format used mainly in Argentina.

## Source Information Menu

### Checking the frequencies, polarities of input signals, and resolution

Use this function to check the frequencies and polarities of the signals currently being input from a computer, etc.

On “MAIN MENU”, select “SOURCE INFORMATION”, then press the MENU/SET button.

The “SOURCE INFORMATION” is displayed.

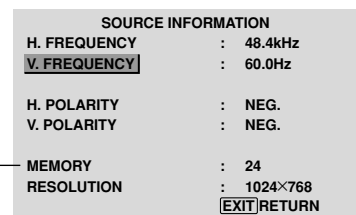

PC: MEMORY will be displayed.  
Others: MODE will be displayed.

# Pin Assignments

## mini D-Sub 15-pin connector (Analog)

PC 1

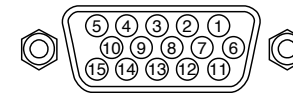

Pin No.	Signal (Analog)
1	Red
2	Green or sync-on-green
3	Blue
4	No connection
5	Ground
6	Red ground
7	Green ground
8	Blue ground
9	No connection
10	Sync signal ground
11	No connection
12	Bi-directional DATA (SDA)
13	Horizontal sync or Composite sync
14	Vertical sync
15	Data clock

## DVI-D 24-pin connector (Digital)

The unit is equipped with a type of connector commonly used for digital.

(This cannot be used for an analog input.)

(TMDS can be used for one link only.)

PC 3

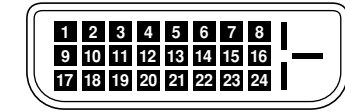

Pin No.	Signal (Digital)
1	T.M.D.S Data 2 -
2	T.M.D.S Data 2 +
3	T.M.D.S Data 2 Shield
4	No connection
5	No connection
6	DDC Clock
7	DDC Data
8	No connection
9	T.M.D.S Data 1 -
10	T.M.D.S Data 1 +
11	T.M.D.S Data 1 Shield
12	No connection
13	No connection
14	+5V Power
15	Ground
16	Hot Plug Detect
17	T.M.D.S Data 0 -
18	T.M.D.S Data 0 +
19	T.M.D.S Data 0 Shield
20	No connection
21	No connection
22	T.M.D.S Clock Shield
23	T.M.D.S Clock +
24	T.M.D.S Clock -



# Troubleshooting

If the picture quality is poor or there is some other problem, check the adjustments, operations, etc., before requesting service.

Symptom	Checks	Remedy
Mechanical sound is heard. The unit emits a crackling sound.	• Maybe the sound from the cooling fans used to prevent over heating. • Are the image and sound normal?	• If there are no abnormalities in the image and sound, the noise is caused by the cabinet reacting to changes in temperature. This will not affect performance.
Picture is disturbed. Sound is noisy. Remote control operates erroneously. The remote control does not work.	• Is a connected component set directly in front or at the side of the display? • Are the remote control's batteries worn out? • Is IR REMOTE set to ON? • Has an ID number been set for the main unit?	• Leave some space between the display and the connected components. • Replace both batteries with new ones. • Set IR REMOTE OFF on OPTION3 menu. • Set an ID number with the ID NO. SET button, or set the ID number to ALL.
Monitor's power does not turn on when the remote control's power button is pressed.	• Is the monitor's power cord plugged into a power outlet? • Are all the monitor's indicators off? • Are the remote control's batteries worn out? • Is IR REMOTE set to OFF? • Has an ID number been set for the main unit?	• Plug the monitor's power cord into a power outlet. • Press the power button on the monitor to turn on the power. • Replace both batteries with new ones. • Set IR REMOTE ON. • Set an ID number with the ID NO. SET button, or set the ID number to ALL.
Monitor does not operate when the remote control's buttons are pressed.	• Is the remote control pointed at the monitor, or is there an obstacle between the remote control and the monitor? • Is direct sunlight or strong artificial light shining on the monitor's remote control sensor? • Are the remote control's batteries worn out? • The remote cable is plugged into the REMOTE IN terminal (Wired).	• Point the remote control at the monitor's remote control sensor when pressing buttons, or remove the obstacle. • Eliminate the light by closing curtains, pointing the light in a different direction, etc. • Replace both batteries with new ones. • Unplug the remote cable from the monitor.
The front panel buttons of the main unit do not function.	• The front panel buttons do not function during KEY Lock.	• Set the KEY Lock to OFF.
No sound or picture is produced.	• Is the monitor's power cord plugged into a power outlet?	• Plug the monitor's power cord into a power outlet.
Picture appears but no sound is produced.	• Is the volume set at the minimum? • Is the MUTING mode set? • Are the speakers properly connected? • Is AUDIO INPUT set correctly?	• Increase the volume. • Press the remote control's MUTING button. • Connect the speakers properly. • Set AUDIO INPUT on the SOUND menu correctly.
Poor picture with VIDEO signal input.	• Improper control setting. Local interference. Cable interconnections. Input impedance is not correct level.	• Adjust picture control as needed. Try another location for the monitor. Be sure all connections are secure.
Poor picture with RGB signal input.	• Improper control setting. Incorrect RGB connector pin connections.	• Adjust picture controls as needed. Check pin assignments and connections.
Tint is poor or colors are weak.	• Are the tint and colors properly adjusted?	• Adjust the tint and color (under PICTURE).
Nothing appears on screen.	• Is the computer's power turned on? • Is a source connected? • Is the power management function in the standby or off mode? • Is LOOP OUT set to ON?	• Turn on the computer's power. • Connect source to the monitor. • Operate the computer (move the mouse, etc.). • Set LOOP OUT OFF.
Part of picture is cut off or picture is not centered.	• Is the position adjustment appropriate?	• Adjust the SCREEN properly.
Image is too large or too small.	• Is the screen size adjustment appropriate?	• Press the SCREEN SIZE button on the remote control and adjust properly.
Picture is unstable.	• Is the computer's resolution setting appropriate?	• Set to the proper resolution.
STANDBY/ON indicator is lighted in red.	• Horizontal and / or vertical sync signal is not present when the Intelligent Power Manager control is on.	• Check the input signal.
STANDBY/ON indicator is blinking in red.	• The temperature inside the main unit has become too high and has activated the protector.	• Promptly switch off the power of the main unit and wait until the internal temperature drops. See*1.
STANDBY/ON indicator is blinking in green and red, or green.		• Promptly switch off the power of the main unit. See *2.

#### \*1 Overheat protector

If the monitor becomes too hot, the overheat protector will be activated and the monitor will be turned off. If this happens, turn off the power to the monitor and unplug the power cord. If the room where the monitor is installed is particularly hot, move the monitor to a cooler location and wait for the monitor to cool for 60 minutes. If the problem persists, contact your dealer.

#### \*2 In the following case, power off the monitor immediately and contact your dealer or authorized Service Center.

The monitor turns off 5 seconds after powering on and then the STANDBY/ON indicator blinks. It indicates that the power supply circuit, plasma display panel, temperature sensor, or one or more fans have been damaged.

# Specifications

<b>Screen Size</b>	53.2"(H)×29.9"(V) inches 1351(H)×760(V) mm diagonal 61"
<b>Aspect Ratio</b>	16 : 9
<b>Resolution</b>	1365(H)×768(V) pixels
<b>Signals</b>	Synchronization Range Horizontal : 15.5 to 110 kHz (automatic : step scan) Vertical : 50.0 to 120 Hz (automatic : step scan)
<b>Input Signals</b>	RGB, NTSC (3.58/4.43), PAL (B,G,M,N), PAL60, SECAM, HD*1, DVD*1, DTV*1
<b>Input Terminals</b> (VIDEO1 and PC1 can also be used as OUTPUT terminals)	
<b>PC</b>	Visual 1 (Analog) mini D-sub 15-pin × 1 Visual 2 (Analog) BNC (R, G, B, H/CS, V) × 1*2 Visual 3 (Digital) DVI-D 24-pin × 1*3
<b>Video</b>	Visual 1 BNC × 1 Visual 2 RCA-pin × 1 Visual 3 S-Video: DIN 4-pin × 1
<b>COMPONENT</b>	Visual 1 RCA-pin (Y, PB[CB], PR[CR]) × 1*1 Visual 2 BNC (Y, PB[CB], PR[CR]) × 1*1,*2
<b>Audio</b>	Stereo RCA × 3 (Selectable)
<b>RS-232C</b>	D-sub 9-pin × 1
<b>Sound output</b>	9W+9W at 6 ohm
<b>Power Supply</b>	AC100-120V 50/60Hz
<b>Current Rating</b>	8.0A (maximum)
<b>Power Consumption</b>	540W (standby 0.9W)
<b>Dimensions</b>	57.9 (W) × 34.7 (H) × 4.7 (D) inches 1470 (W) × 880 (H) × 119(D) mm
<b>Weight</b>	134.5 lbs / 61.0 kg (without stand)
<b>Environmental Considerations</b>	Operating Temperature 0°C to 40°C / 32°F to 104°F
<b>Other Features</b>	Motion compensated 3D Scan Converter (NTSC, PAL, 480I, 576I, 525I, 625I, 1035I, 1080I), 2-3 pull down Converter (NTSC, 480I, 525I, 1035I, 1080I (60Hz)), 2-2 pull down Converter (PAL, 576I, 625I, NTSC, 480I, 525I), Digital Zoom Function (100-900% Selectable), Video Wall 4-25 multi screen, Self Diagnosis, Image Burn reduction tools (ABL LOCK1~3, INVERSE, WHITE, ORBITER (Auto 1.2/Manual), SCREEN WIPER), Color Temperature select (high/mid/low/low, user has 4 memories), Key lock (Except power SW), Auto Picture, Input Skip, Color Detail Adjustment, Low Tone (3 mode), Auto ID, Programmable Timer, Gamma Correction (4 mode), Loop through interface, Plug and play (DDC1, DDC2b, PC3: DDC2b only)

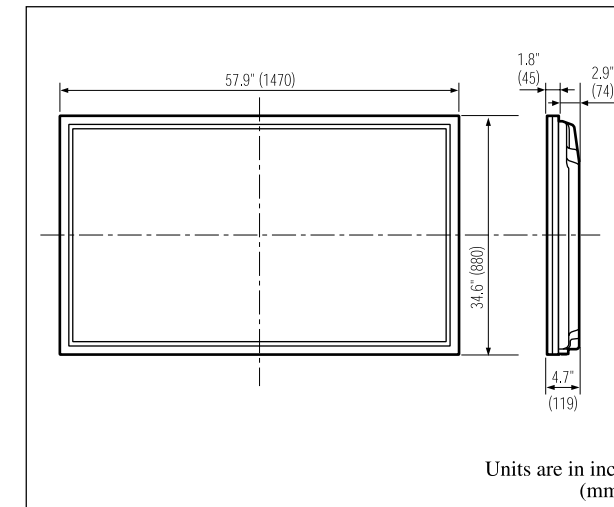

Units are in inch (mm)

The features and specifications may be subject to change without notice.

#### \*1 COMPONENT input signals supported on this system

480P (60 Hz)	480I (60 Hz)	525P (60 Hz)
525I (60 Hz)	576P (50 Hz)	576I (50 Hz)
625P (50 Hz)	625I (50 Hz)	720P (60 Hz)
1035I (60 Hz)	1080I (50 Hz)	1080I (60 Hz)

#### \*2 The 5-BNC connectors are used as PC2 and COMPONENT2 input. Select one of them under "BNC INPUT".

#### \*3 Compatible with HDCP.

#### Supported Signals

- 640 × 480P @ 59.94/60Hz
- 1280 × 720P @ 59.94/60Hz
- 1920 × 1080I @ 59.94/60Hz
- 720 × 480P @ 59.94/60Hz
- 1440 (720) × 480I @ 59.94/60Hz
- 1920 × 1080I @ 50Hz
- 720 × 576P @ 50Hz
- 1440 (720) × 576P @ 50Hz

**Note:** In some cases a signal on the plasma monitor may not be displayed properly. The problem may be an inconsistency with standards from the source equipment (DVD, Set-top box, etc...). If you do experience such a problem please contact your dealer and also the manufacturer of the source equipment.

## Free Manuals Download Website

<http://myh66.com>

<http://usermanuals.us>

<http://www.somanuals.com>

<http://www.4manuals.cc>

<http://www.manual-lib.com>

<http://www.404manual.com>

<http://www.luxmanual.com>

<http://aubethermostatmanual.com>

Golf course search by state

<http://golfingnear.com>

Email search by domain

<http://emailbydomain.com>

Auto manuals search

<http://auto.somanuals.com>

TV manuals search

<http://tv.somanuals.com>