

Pioneer

seeing and hearing like never before

KURO LX

DON'T JUST WATCH, DON'T JUST LISTEN, BE TRANSFORMED. BE CONSUMED.

BE CHANGED MIND, BODY AND SOUL BY EXPERIENCES SO INTENSE

THEY ALTER EVERYTHING FOREVER.

BY COLOURS SO VIBRANT THEY TWIST THE VERY FABRIC OF YOUR BEING.

BY SOUNDS SO PURE THEY YOU DON'T JUST HEAR THEM, YOU BECOME THEM.

BY A WORLD SO REAL, SO RICH, SO PURE, SO BEYOND ANYTHING YOU'VE EVER
EXPERIENCED IT SURROUNDS YOUR SENSES, TAKES HOLD OF YOUR EMOTIONS,

SHATTERS YOUR EXPECTATIONS AND NOTHING WILL EVER BE THE SAME.



seeing and hearing like never before



KURO LX

THERE'S A FASCINATING, ENTHRALLING WORLD AVAILABLE TO YOU.
A WORLD WHERE THE HIGHEST EXPRESSIONS OF SIGHT AND SOUND FINALLY
COME TOGETHER AND AWAKEN YOUR SENSES — ELEVATING THEM TO A NEW
LEVEL OF CONSCIOUSNESS. A WORLD WHERE EMOTIONS ARE BUILT WITH
FEELINGS SO DEEP THAT TEARS FALL LIKE LEAD, FEAR RAGES LIKE WILDFIRE,
AND PASSIONS SWELL LIKE A RISING FLOOD.

prepare to go beyond the limits of reality

AND IN THIS WORLD, EVERY EXPERIENCE YOU'LL EVER HAVE IS LIKE NOTHING
YOU'VE EVER KNOWN BEFORE. THAT'S BECAUSE EVERYTHING THAT EXISTS IN
THAT WORLD COMES FROM AN INSATIABLE DRIVE FOR PERFECTION AND AN
UNCOMPROMISING ATTENTION TO DETAIL.
WE SHOULD KNOW — WE BUILT THIS WORLD.



**KURO, ADJ. BLACK: BEING OF THE ACHROMATIC COLOUR
OF MAXIMUM DARKNESS: ORIGIN: JAPANESE.**

WHEN WE SET OUT TO MAKE A NEW DISPLAY, OUR ENGINEERS SOUGHT TO CREATE
THE MOST IMMERSIVE, EXPERIENTIAL, EMOTIONALLY POWERFUL TELEVISION
EXPERIENCE POSSIBLE. PERIOD. BECAUSE WE UNDERSTAND THE PASSION
THAT GOES INTO PRODUCING AMAZING IMAGES, SOUNDS, EMOTIONS AND ART, AND WE SHARE IT.

SO WE STARTED FROM SCRATCH AND DEDICATED OURSELVES TO MAKING
A TRULY REVOLUTIONARY DISPLAY THAT REPRODUCES WHAT THE ARTIST ORIGINALLY INTENDED.
AND THAT MEANT, ABOVE ALL, ACHIEVING THE BLACKEST BLACKS IMAGINABLE.

BECAUSE WHEN IT COMES TO TV, BLACK IS EVERYTHING. BLACK IS THE CANVAS.
BLACK IS THE FOUNDATION. BLACK GIVES EACH COLOUR GREATER DEFINITION,
ADDITIONAL SHADES, MORE DEPTH AND THE SHARPEST DETAILS. IN RED. IN GREEN.
IN BLUE, AND EVERYWHERE IN BETWEEN. A TRULY BLACK BLACK BREATHES LIFE INTO
COLOUR AND FOREVER CHANGES THE WAY YOU THINK ABOUT TV.

AND BLACK, AS YOU MIGHT EXPECT, IS AT THE VERY HEART OF
WHAT THIS TELEVISION IS ALL ABOUT.



KURO

KURO FLAT PANEL DISPLAY
KRP-600M





PIONEER'S NEW KURO FLAT SCREEN TV "PDP-LX6090" FOR EUROPE IS AWARDED 2008-2009 BEST PRODUCT IN EUROPEAN PLASMA-TV CATEGORY FROM EUROPEAN IMAGING AND SOUND ASSOCIATION.



KURO

KURO FLAT PANEL DISPLAY
KRP-500M



KURO

KURO FLAT SCREEN TV
KRP-500A



*KRP-500A WITH STAND KRP-TS02 AND SIDE SPEAKER KRP-S03

EXPERIENCE THE TRUE BLACK OF KURO

DEEPER BLACKS FOR A MORE VIVID PICTURE

KURO, JAPANESE FOR "BLACK," TAKES FLAT PANEL TVS TO A NEW LEVEL OF PERFORMANCE WITH THE RICHEST, DEEPEST BLACKS YET ACHIEVED. THIS WAS MADE POSSIBLE BY THE LATEST INNOVATIONS IN OUR PLASMA TECHNOLOGY, TOGETHER WITH THE DEVELOPMENT OF A NEW VIDEO PROCESSOR. WHY DID WE WORK SO HARD TO REACH THESE BLACK LEVELS? BECAUSE WE KNOW THAT ONLY THE DEEPEST BLACKS CAN CREATE THE HIGHEST PICTURE QUALITY. OUR NEW PLASMA DISPLAY PANELS ARE "BUILT FOR EMOTION" — OFFERING YOU A NEW DIMENSION OF DRAMATIC, REALISTIC VISUAL ENTERTAINMENT.

ADVANCED PLASMA TV TECHNOLOGIES

PIONEER DEVELOPED CRYSTAL EMISSIVE LAYER TECHNOLOGY TO ACHIEVE DEEP BLACK REPRODUCTION, AND FOR OUR LATEST PLASMA PANELS, WE'VE MADE IT EVEN BETTER. WE ALSO REFINED THE STRUCTURE OF THE LIGHT EMITTING CELLS AND EMPLOYED A NEW ELECTRON SOURCE MATERIAL TO SPEED UP THE DISCHARGE RATE IN ORDER TO PREVENT SPARK DISCHARGE DURING BLACK REPRODUCTION. AS A RESULT, WE SUCCEEDED IN REDUCING THE MINIMUM BRIGHTNESS TO ONE-FIFTH OF PREVIOUS MODELS. THIS ENABLES THE HIGHEST CONTRAST EVER ACHIEVED IN THE INDUSTRY, SO YOU CAN ENJOY TRULY A VIBRANT AND NATURAL PICTURE, EVEN DURING DARK SCENES.

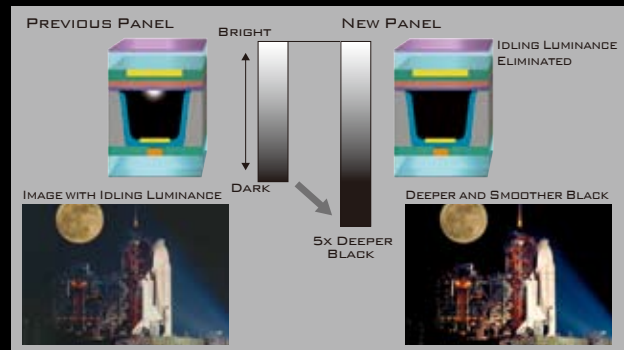

KURO IMPROVES COLOUR PERFORMANCE

DEEPER BLACKS MEAN MORE VIVID COLOURS

WHEN BLACKS ARE DEEP AND SOLID, COLOUR REPRODUCTION ALSO IMPROVES, WITH COLOURS STANDING OUT SHARPLY AND BRILLIANTLY. EVEN AT LOW BRIGHTNESS LEVELS, THE THREE PRIMARY COLOURS OF RED, GREEN, AND BLUE ARE DEEPLY AND VIVIDLY PRODUCED, MEANING THAT IN NIGHT-TIME OR SHADY SCENES, COLOURS WILL STAND OUT BEAUTIFULLY WITHOUT BEING ASSIMILATED INTO THE DARKNESS.

NEW DIRECT COLOUR FILTER

THE COLOUR FILTER IS ALSO A KEY ELEMENT DETERMINING PICTURE QUALITY. PIONEER'S PROPRIETARY HIGH PERFORMANCE FILTER, THE NEW DIRECT COLOUR FILTER, EFFECTIVELY REDUCES REFLECTIONS, ENSURING SOLID BLACKS, OPTIMUM CONTRAST AND BRILLIANT COLOURS REGARDLESS OF THE LIGHT CONDITIONS—FROM BRIGHT SUNLIGHT TO DARK HOME THEATRE ROOMS. IT ALSO CUTS ANNOYING GLARE. ALL PIONEER PDP MODELS USE NEW DIRECT COLOUR FILTERS THAT PROVIDE ENHANCED CHROMATIC PURITY FOR SUPERIOR COLOUR REPRODUCTION.

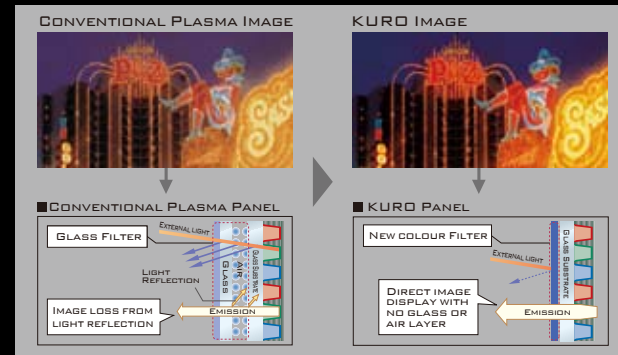

OPTIMUM PICTURE AND SOUND QUALITY, AUTOMATICALLY

NEW OPTIMUM MODE

PIONEER'S EXCLUSIVE NEW OPTIMUM MODE AUTOMATICALLY ANALYSES THE TYPE OF IMAGES BEING DISPLAYED AND USES A ROOM LIGHT SENSOR TO MONITOR THE AMBIENT BRIGHTNESS. THE KRP-500A ALSO ACCEPTS THE OPTIONAL KRP-SED1 COLOUR SENSOR FOR MONITORING THE COLOUR OF THE LIGHTING. BASED ON THE INFORMATION RECEIVED, PARAMETER SETTINGS ARE OPTIMISED SO YOU ENJOY THE BEST POSSIBLE PICTURE NO MATTER WHEN YOU'RE WATCHING OR WHETHER YOU'RE WATCHING MOVIES, CONCERTS, SPORTS OR OTHER TYPES OF CONTENT. EVEN IF THE ROOM BRIGHTNESS CHANGES, YOU STILL GET OPTIMUM PICTURE QUALITY.



OPTIONAL COLOUR SENSOR KRP-SED1

ADJUSTS FOR BEST SOUND ALSO

THE NEW OPTIMUM MODE NOT ONLY OPTIMISES PICTURE QUALITY, IT ALSO ADJUSTS FOR BEST SOUND QUALITY TO MATCH THE GENRE YOU ARE VIEWING. BASED ON THE RESULTS OF ANALYSING THE SOURCE CONTENT, IT PERFORMS DETAILED SOUND ADJUSTMENTS USING SRS, SRS FOCUS, SRS TRUBASS AND SRS DEFINITION. THE RESULT IS SOUND THAT ACCENTUATES THE EXCITEMENT OF THE VISUAL IMAGES. WHEN WATCHING A MOVIE, YOU HEAR SOUND LIKE YOU WOULD HEAR IN A MOVIE THEATRE, AND WHEN WATCHING A CONCERT, YOU HEAR DYNAMIC AND ENERGETIC SOUND.

NEW OPTIMUM MODE

ROOM ENVIRONMENT ANALYSIS

THE ROOM LIGHT AND ROOM COLOUR (TEMPERATURE) CHANGES THROUGHOUT THE DAY



CONTENTS ANALYSIS

OPTIMUM MODE AUTOMATICALLY DETECTS THE CONTENTS FROM PICTURE

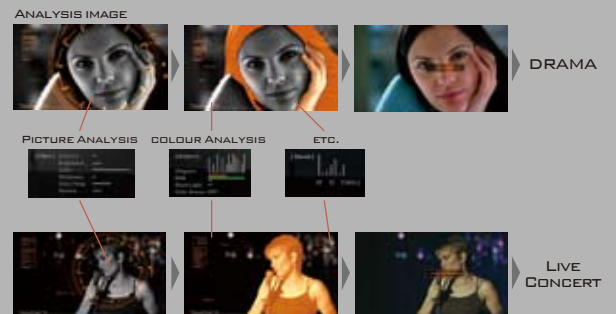

VARIOUS EXAMPLES OF CLASSIFIED CONTENTS

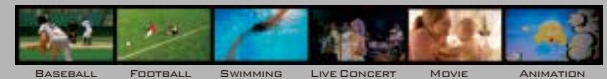

OPTIMUM MODE AUTOMATICALLY ADJUSTS PICTURE AND SOUND FOR VARIOUS CONTENT CATEGORIES

- OPTIMUM SOUND TUNING FOR THE PROGRAM

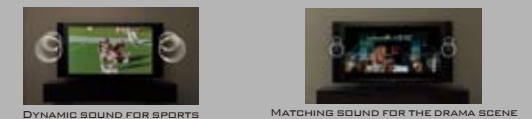

AUTOMATICALLY ADJUSTS FOR THE MOST SUITABLE AND PLEASING PICTURE AND SOUND UNDER ANY ENVIRONMENT

ENHANCED OPERATING AND MONITORING (KRP-600M/500M)

NETWORK AND E-MAIL FUNCTIONS

BY CONNECTING THE MONITOR TO A PC VIA A LAN CONNECTION, YOU CAN FINE-TUNE THE PICTURE QUALITY ON A WEB BROWSER, AND ALSO TRANSMIT RS-232C COMMANDS. AN E-MAIL FUNCTION LETS YOU SEND A VARIETY OF STATUS INFORMATION TO AN ADDRESS YOU HAVE SET. YOU CAN SEND PANEL USAGE TIME, INTERNAL TEMPERATURE, INPUT SIGNALS, AND PROBLEM NOTIFICATIONS. IT'S A SOPHISTICATED WAY TO MONITOR AND CONTROL THE PICTURE QUALITY OF YOUR MONITOR.



IP CONTROL SCREEN

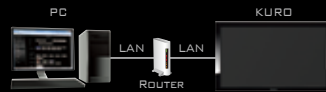

DETAILED IMAGE CONTROL (KRP-600M/500M)

120-INCREMENT IMAGE TUNING

THESE MODELS OFFER A NUMBER OF PRECISE TUNING FUNCTIONS GENERALLY FOUND ON PROFESSIONAL MONITORS: 5-STEP GAMMA ADJUSTMENT, AND EXTRA-FINE 120-INCREMENT VIDEO ADJUSTMENTS INCLUDING BRIGHTNESS AND COLOUR. YOU CAN PERFORM THESE ADJUSTMENTS BY SWITCHING THE IMAGE AT THE PUSH OF A BUTTON TO CHECK THE EFFECTS BEFORE AND AFTER TUNING. YOU'LL ENJOY THE ABILITY TO DELICATELY CONTROL COLOUR NUANCES, IMAGE TEXTURES, AND SO ON.

FINE-DETAIL TUNING OF COLOUR AND CONTRAST.



PRO ADJUST MENU

- 5-STEP GAMMA ADJUSTMENT
- 120-STEP BRIGHTNESS/COLOUR/TINT ADJUSTMENT
- 120-STEP ADJUSTMENT OF 6 PARAMETERS FOR RGB HIGH AND LOW

NEW, MORE EFFICIENT OSD

THE NEW PIONEER OSD LETS YOU DISPLAY MORE INFORMATION WITH FEWER OPERATIONS. DESIGNED TO MINIMISE THE NUMBER OF LEVELS AND MAKE THEM MORE UNIFORM, IT LETS YOU EASILY PERFORM DETAILED ADJUSTMENTS, WHILE QUICKLY DISPLAYING MENUS AND FUNCTIONS. YOU HAVE A CHOICE OF 15 DISPLAY LANGUAGES.



INPUT SETUP MENU OF KRP-600M/500M

SOUND THAT COMPLEMENTS THE BEAUTY OF THE IMAGES (KRP-500A)

ULTRA-CLEAR SOUND, INCLUDING DIALOGUE

PIONEER'S TRADITION OF HIGH SOUND QUALITY, FROM DEEPLY POWERFUL BASS TO CLEAR AND SHARP HIGHS, IS USED TO FULL ADVANTAGE IN THESE TVS. MOVIE DIALOGUE, EVEN WHEN WHISPERED, AS WELL AS THE WIDE RANGE OF OTHER DELICATE SOUNDS, ARE ALWAYS HEARD CLEARLY. THE POWER, TENSION, PRESENCE, AND RHYTHMIC FEEL OF MOVIES AND CONCERTS ARE FAITHFULLY REPRODUCED TO ADD GREATER EXCITEMENT TO THE HIGH RESOLUTION IMAGES.

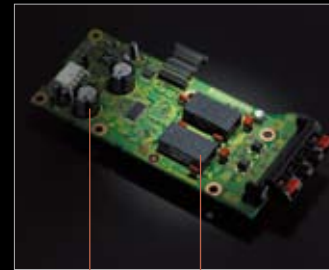

LOW IMPEDANCE CONDENSER LOW DISTORTION THIN CUSTOM COIL



HIGH SOUND QUALITY SPEAKER UNITS (LEFT: WOOFER, RIGHT: TWEETER)

OPTIMISE THE SOUND TO MATCH THE CONTENT

YOU CAN SET AND MEMORISE PARAMETERS FOR OPTIMUM SOUND QUALITY WITH VARIOUS PICTURE MODES, SUCH AS MOVIE MODE AND DIRECTOR MODE. EACH SOUND EFFECT CAN BE VARIED THROUGH FOUR STEPS. YOU ALSO GET AVC (AUTO VOLUME CONTROL) THAT MAINTAINS THE VOLUME AT A CONSTANT LEVEL EVEN WHEN THE SOURCE VOLUME VARIES (SO YOU ARE NOT BOTHERED BY LOUD COMMERCIALS).

BLENDS INTO YOUR INTERIOR

ELEGANTLY THIN AT ONLY 64MM

KURO TVS ENHANCE YOUR INTERIOR NOT ONLY WITH THEIR BEAUTIFUL IMAGES, BUT WITH THEIR REFINED, ELEGANT FORM. WITH A THICKNESS OF ONLY 64MM, THEY ARE NATURALLY LIGHTWEIGHT AS WELL. WHEN HUNG ON A WALL, THEY CAN BE MOUNTED SO THEY SEEM TO BE INTEGRATED WITH THE WALL SURFACE, AT A DISTANCE FROM THE WALL OF ONLY 89MM*. YOU WILL APPRECIATE HOW THEY BEAUTIFULLY BLEND INTO YOUR LIVING SPACE.

* KRP-600M WHEN INSTALLED USING KRP-WM01 WALL MOUNT UNIT.



LESS ELEMENT DESIGN

THESE KURO MODELS EMBODY PIONEER'S LESS ELEMENT DESIGN CONCEPT: ABSOLUTELY MINIMISING ELEMENTS NOT NEEDED FOR VIEWING. THEY HAVE A LOGO WHICH DISAPPEARS IF THE SURROUNDINGS BECOME DARK AND WHICH CREATES A CALM ATMOSPHERE IN THE VIEWING SPACE, A FRAME MADE OF LUXURIOUS MATERIAL, AND OTHER UNIQUE KURO FINISHINGS. AND BY MAKING THE BACK PANEL SIMPLER AND FLATTER, THE OVERALL FORM IS REFINED.



KURO LINK

BY CONNECTING THE KURO TV WITH A NEW LX A/V RECEIVER AND THE LX BLU-RAY DISC PLAYER, KURO LINK LETS YOU OPERATE THE WHOLE SYSTEM'S BASIC FUNCTIONS, SUCH AS POWER ON/OFF AND PLAYBACK THROUGH KURO'S REMOTE CONTROL.

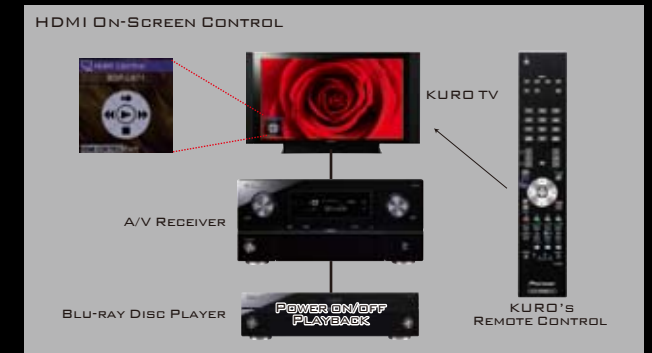

WITNESS PERFECTION

YOU ARE A WITNESS. TO VISIONS NEVER BEFORE SEEN. TO HEAVING OCEANS TOSSING MASSIVE SCHOONERS ABOUT LIKE A CHILD'S TOYS.

TO BLAZING WHITE MOUNTAINTOPS THAT PIERCE AN AZURE SKY. TO THE MENACE OF A RUNAWAY TRAIN.

TO COLOURS SO RICH, SO DETAILED, ALL YOUR SENSES COME ALIVE.

YOU ARE A WITNESS. TO A BREED OF BLU-RAY PLAYER THAT WAS DESIGNED FROM THE GROUND UP TO BE COMPLETELY, ABSOLUTELY,

UTTERLY TRANSPARENT. SO YOU EXPERIENCE IMAGES IN THEIR PRISTINE FORM. JUST AS THEY WERE FILMED,

JUST AS THEY WERE MASTERED. JUST AS THE DIRECTOR INTENDED.

YOU ARE TRANSPORTED. BY VISIONS SO BEAUTIFUL YOU HEAR THEM, YOU TASTE THEM, YOU FEEL THEM.

YOU ARE WITNESS TO THE DAWN OF A NEW AGE OF IMAGES THAT LIFT YOU OUT OF YOUR REALITY,

AND PLUNGE YOU HEADFIRST INTO WORLDS YOU HAVE NEVER IMAGINED.

THE BLU-RAY REVOLUTION IS UPON US, AND NOTHING WILL EVER BE THE SAME.



BLU-RAY DISC PLAYER
BDP-LX91



BLU-RAY DISC PLAYER
BDP-LX71



ADAPTIVE BIT LENGTH EXPANSION CIRCUIT (BDP-LX91)

THIS CIRCUIT EXPANDS 8-BIT BRIGHTNESS AND COLOUR SIGNALS FROM BLU-RAY DISCS AND DVDS UP TO 16 BITS, SO IMAGES ARE REPRODUCED WITH GREATER ACCURACY AND MORE NATURAL COLOURS.

BIT EXPANSION

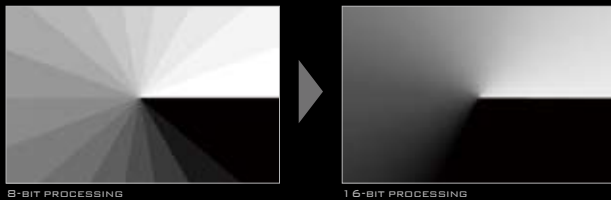

DEEP COLOUR AND X.V. COLOUR VIA HDMI

THE PIONEER BLU-RAY DISC PLAYERS SUPPORT HIGH-BIT DEEP COLOUR, OFFERING IMAGES WITH SUPERB COLOUR DETAIL. THE BDP-LX91 FEATURES 48-BIT (EXCEPT 1080P/50 AND 1080P/60 OUTPUT) COLOUR DEPTH, THE FIRST PLAYER TO OFFER THIS ULTRA HIGH PERFORMANCE CAPABILITY, WHILE THE BDP-LX71 FEATURES 36-BIT COLOUR DEPTH. THE BDP-LX91 ALSO PROVIDES X.V. COLOUR, AN ADVANCED FEATURE THAT GREATLY BROADENS THE COLOUR SPACE INPUT TO INCLUDE 1.8 TIMES AS MANY NATURAL COLOURS AS THE STANDARD RGB SIGNALS.

297MHz/14-BIT VIDEO D/A CONVERTER (BDP-LX91)

THE BDP-LX91 FEATURES A 297MHz/14-BIT VIDEO DAC WITH HIGH QUALITY OVERSAMPLING FOR NOISE-FREE PICTURES. THE FINEST VIDEO SIGNALS CAN BE FAITHFULLY REPRODUCED, OFFERING SUPERB IMAGE DISPLAY.

* 216MHz/14-BIT FOR SD OUTPUT

MOTION ADAPTIVE IP CONVERSION

PIONEER'S BLU-RAY DISC PLAYERS CAN CONVERT 1080/60i HIGH-DEFINITION SOURCES FOR 1080/60p DISPLAY. "MOTION ADAPTIVE" MEANS THAT IP CONVERSION PROCESSING IS DONE WHILE ANALYSING THE CONDITION OF THE MOVING IMAGE, ENSURING HIGHEST QUALITY WITH REDUCED PICTURE NOISE.

MOTION ADAPTIVE IP CONVERSION

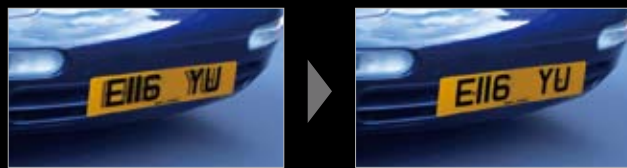

CONVENTIONAL IP CONVERSION

NEW IP CONVERSION

TRIPLE HIGH-DEFINITION NR

BOTH OF THESE BLU-RAY DISC PLAYERS INCORPORATE THREE HIGH-DEFINITION NOISE REDUCTION CIRCUITS. COMPONENT FRAME NR LOWERS GAUSSIAN NOISE WITHOUT BLURRING THE PICTURE. BLOCK NR MINIMISES BLOCK NOISE (MOSAIC-LIKE ARTIFACTS). AND MOSQUITO NR REDUCES THE FLUTTERY NOISE AROUND THE EDGES OF OBJECTS.



PRECISION QUARTZ LOCK SYSTEM

THIS IS THE WORLD'S FIRST JITTER-FREE CD AUDIO TRANSMISSION SYSTEM. CONNECT YOUR BLU-RAY DISC PLAYER TO THE LX AMPLIFIER OR ONE OF THE RECEIVERS AND THE SYSTEM WILL TRANSFER THE CD MUSIC DATA VIA THE HDMI CABLE WITH VIRTUALLY NO JITTER FOR THE BEST POSSIBLE SOUND QUALITY.

PQLS JITTER-FREE TRANSFER VIA HDMI

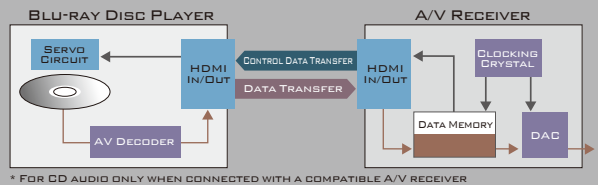

* FOR CD AUDIO ONLY WHEN CONNECTED WITH A COMPATIBLE A/V RECEIVER

PURE AUDIO MODE WITH HDMI DUAL OUTPUT (BDP-LX91)

THE BDP-LX91 COMES WITH TWO HDMI OUTPUT TERMINALS. WITH THE PURE AUDIO MODE, THE AUDIO AND VIDEO SIGNALS ARE SEPARATELY TRANSFERRED VIA THE MAIN AND SUB HDMI TERMINALS. THE ISOLATION OF THE AUDIO SIGNALS PROVIDES HIGH PURITY SOUND FREE OF INTERFERENCE.

PURE AUDIO MODE CONNECTION EXAMPLE

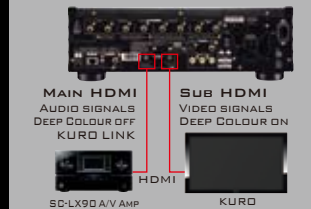

7.1-CH DUAL MODE DAC OUTPUT (BDP-LX91)

A SEPARATE D/A CONVERTER IS ALLOCATED FOR EACH OF THE FRONT LEFT, FRONT RIGHT, CENTRE, SUBWOOFER, SURROUND LEFT, SURROUND RIGHT, SURROUND BACK LEFT, AND SURROUND BACK RIGHT CHANNELS ON THE BDP-LX91. THIS DUAL-CHANNEL MODE OUTPUT FOR ALL 7.1 CHANNELS CREATES HIGH QUALITY SOUND EQUIVALENT TO THAT OF HIGH-CLASS PURE AUDIO COMPONENTS. EXPERIENCE THE IDEAL SOUND FIELD FOR YOUR HOME THEATRE.

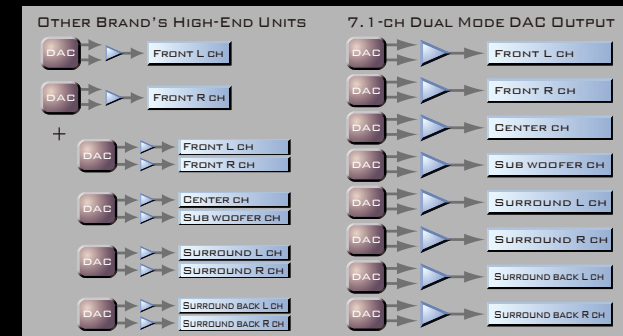

ANTI-VIBRATION, ANTI-NOISE CONSTRUCTION (BDP-LX91)

AN ADVANCED DOUBLE LAYERED CHASSIS AND DOUBLE LAYER TOP PANEL, WITH HEAVY ALUMINUM TOP AND SIDE PANELS, AS WELL AS CARBON COMPOSITE TADC INSULATOR FEET, ENSURE THAT NO VIBRATIONS CAN AFFECT SOUND QUALITY. ALL MAJOR PARTS AND CIRCUITRY ARE WELL ISOLATED TO PREVENT NOISE INTERFERENCE.



- BD-LIVE™ COMPATIBLE (BDP-LX91) WITH FIRMWARE UPDATE
- BONUSVIEW™ COMPATIBLE
- WOLFSON WM8740 Audio DAC
- PURECINEMA DEINTERLACER
- JITTER REDUCTION CIRCUIT
- NEW GUI WITH A/V CODEC INFORMATION
- AVCHD DISC COMPATIBLE
- KURO LINK

PURE SOUND, AS YOU HAVE NEVER HEARD IT BEFORE.

YOU ARE THERE. IN A GRAND CONCERT HALL AS THE CONDUCTOR TAPS HIS BATON. THERE IS SILENCE.

THEN, SUDDENLY, THE SPACE IS FILLED BY THE FULL POWER OF THE ORCHESTRA. YOU HEAR EVERY VIOLIN SING. THE CRY OF THE WOODWINDS. THE TIMPANI POUND AT THE HEART OF THE MUSIC, AND YOU DON'T JUST HEAR IT. YOU FEEL IT.

YOU ARE THERE. IN A FIGHTER JET AS THE ENGINES THRUST FULL THROTTLE.

THE CRAFT SCREAMS TOWARD THE SKY, AND YOUR HEART JUMPS INTO YOUR MOUTH AS THE SPINE-SHAKING RUMBLE OBLITERATES THE SOUND OF YOUR OWN GASPING BREATH.

PIONEER RECEIVERS ARE CONCEIVED AND DESIGNED TO BE OVERBUILT. WITH TREMENDOUS HEADROOM AND PROCESSING POWER, THEY HAVE THE MUSCLE AND BRAINS TO CREATE INCREDIBLY LIFE LIKE SOUNDSCAPE. THEY DON'T REPRODUCE SOUND.

THEY CREATE ASTONISHING, INSPIRING, TRANSPORTING, DEEPLY EMOTIONAL EXPERIENCES.

AND YOU ARE THERE, IN THE MIDDLE OF IT ALL. YOU HEAR, AND YOU SEE. TRULY LIKE NEVER BEFORE.



A/V MULTI-CHANNEL PRE-MAIN AMPLIFIER
SC-LX90



DIRECT ENERGY HD AMPLIFIER

ice power

FOR THE SC-LX90 POWER AMPLIFIER, PIONEER COLLABORATED WITH ICEPOWER TO DEVELOP AN ENTIRELY NEW DIRECT ENERGY HD (HIGH FIDELITY CLASS-D) AMPLIFIER. THIS AMP USES MULTIPLE FEEDBACK TECHNOLOGY TO ELIMINATE POWER SUPPLY INTERFERENCE AND LOAD FLUCTUATION EFFECTS, OVERCOMING THE DRAWBACKS TYPICAL OF CLASS-D AMPS. IT EFFORTLESSLY DELIVERS 140W X 10 OF ULTRA-PURE POWER FOR THE FINEST LISTENING EXPERIENCE.



FREQUENCY CHARACTERISTICS COMPARISON

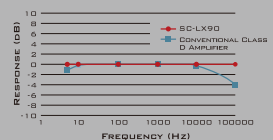

MULTIPLE-FEEDBACK DIRECT ENERGY HD AMPLIFIER BASIC CONCEPT

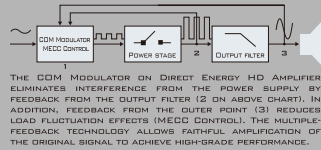

NEW POWER AMP MODULE

IN ORDER TO MAKE THE MOST OF THE DIRECT ENERGY HD AMPLIFIER, PIONEER DEVELOPED AN INNOVATIVE POWER AMP MODULE. IT PUTS THE POWER SUPPLY, POWER DEVICE AND SPEAKER TERMINALS INSIDE A COMPACT UNIT THAT IS ONE-TENTH THE SIZE OF PREVIOUS CONFIGURATIONS. AN OPTIMISED CIRCUIT LAYOUT AND HIGHEST QUALITY PARTS ENSURE MAXIMUM POWER PERFORMANCE.

ULTRA RIGID SEPARATE CONSTRUCTION

BECAUSE THE POWER AMP MODULE IS SO COMPACT, IT ALLOWS AN INNOVATIVE TWO-LAYER CONSTRUCTION. THE POWER AMP AND PREAMP SECTIONS ARE SEPARATED BY A METAL PLATE, SO THEY PERFORM LIKE TWO DISTINCT AMPLIFIERS. TA00 CARBON DUST INSULATORS EFFECTIVELY DAMPEN ANY VIBRATIONS.



INSULATED DUAL CHASSIS

BOTH THE MAIN AND AMPLIFIER CHASSIS ARE PARTIALLY INSULATED, PROVIDING THE MOST STABLE EARTH FOR EACH SECTION. TOGETHER WITH THE SEPARATE CONSTRUCTION, THIS ENSURES HIGH SOUND QUALITY EQUIVALENT TO THAT OF TWO SEPARATE COMPONENTS.



ADVANCED 3-D SPACE FRAME CONSTRUCTION

THIS INTERNAL CONSTRUCTION METHOD USES 1.6MM THICK STEEL PLATES TO ISOLATE THE POWER SUPPLY, POWER AMP, ANALOGUE/DIGITAL CIRCUITRY AND VIDEO CIRCUITRY. BECAUSE THERE CAN BE NO INTERFERENCE AMONG THESE ELEMENTS, EACH CAN PERFORM TO ITS OPTIMUM ABILITY.



POWER AMP ASSIGN SELECTOR

THE POWER AMP ASSIGN SELECTOR GIVES YOU EXTREME FLEXIBILITY FOR CONFIGURING YOUR HOME THEATRE SYSTEM. YOU CAN ASSIGN THE 10 POWER AMP CHANNELS IN A VARIETY OF WAYS, INCLUDING 9.2-CH FULL SURROUND, 7.2-CH PLUS MULTI-ZONE, 7.2-CH FRONT BI-AMP, 7.2-CH SPEAKER B, AND 5.2-CH ALL BI-AMP.

PRECISION DISTANCE

A MULTI-SPEAKER SYSTEM PROMISES GREAT SOUND, BUT WHERE EXACTLY DO YOU PUT THE SPEAKERS? PRECISION DISTANCE TELLS YOU. THIS UNIQUE FEATURE ANALYSES SPEAKER POSITIONS AND GIVES YOU AN ON-SCREEN DISPLAY OF HOW TO ADJUST THEM. YOU CAN GET THE SAME OPTIMUM SPEAKER CONFIGURATION THAT A SKILLED INSTALLER WOULD GIVE YOU.

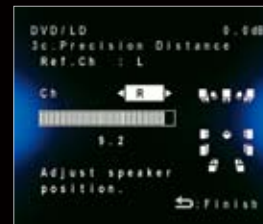

ISOLATED POWER SUPPLY DESIGN

THE SC-LX90 HAS AN EXTREMELY SOPHISTICATED POWER SUPPLY SYSTEM, WITH SEPARATE TRANSFORMERS FOR THE ANALOGUE AND DIGITAL CIRCUITRY. THE DIGITAL CIRCUITS USE HIGH CAPACITY DC/DC CAPACITORS, WHILE THE ANALOGUE CIRCUITS USE LOW-NOISE SERIES PASS REGULATORS. THE DIRECT ENERGY HD AMPLIFIER HAS ITS OWN SWITCHING MODE POWER SUPPLY. THIS OPTIMISES THE PERFORMANCE OF EVERY CIRCUIT, FOR SUPERIOR SOUND QUALITY.

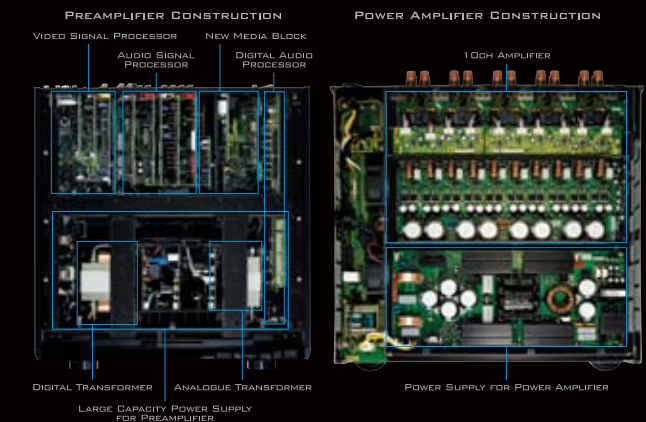
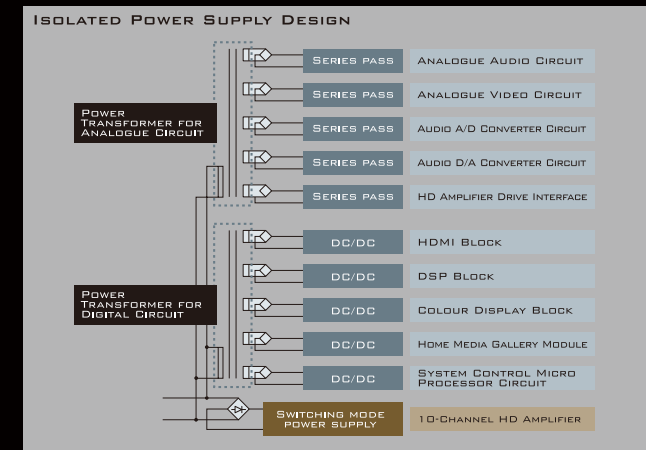



A/V MULTI-CHANNEL RECEIVER
SC-LX81



A/V MULTI-CHANNEL RECEIVER
SC-LX71



A/V MULTI-CHANNEL RECEIVER
VSX-LX70



A/V MULTI-CHANNEL RECEIVER
VSX-LX51



ULTRA LOW JITTER CLOCK SYSTEM WITH SAMPLING RATE CONVERTER (SC-LX90/LX81)

ALL OF THE PIONEER RECEIVERS USE HIGH-QUALITY D/A CONVERTERS, BUT TO FURTHER ENSURE SIGNAL ACCURACY, THEY ALSO FEATURE A NEW CLOCK SYSTEM. AFTER PASSING THROUGH THE LOW JITTER PLL AND CRYSTAL OSCILLATOR CIRCUITS, THE SIGNAL IS UPSAMPLED TO 192KHZ BY A SAMPLING RATE CONVERTER. CONTROLLED BY THE ULTRA LOW JITTER CLOCK, IT UNDERGOES D/A CONVERSION IN THE BEST POSSIBLE CONDITION.

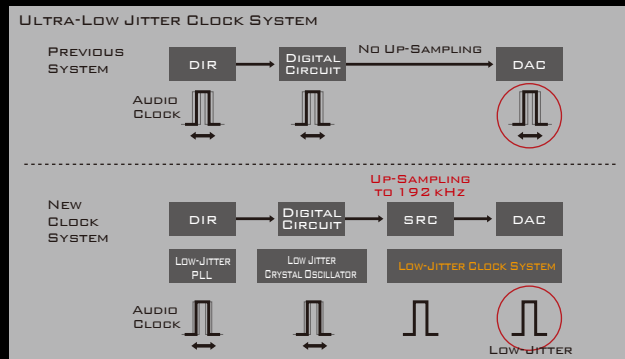

FULL BAND PHASE CONTROL

FULL BAND PHASE CONTROL IS PIONEER'S INNOVATIVE SOLUTION FOR THE PHASE SHIFTS THAT OCCUR IN MULTI-CHANNEL SPEAKER SETUPS. USING ADVANCED SIGNAL PROCESSING TECHNIQUES, IT CORRECTS THE PHASE IRREGULARITIES THAT CAUSE RESPONSE DEVIATIONS BETWEEN THE TWEETER, MIDRANGE AND WOOFER UNITS, AND ALSO ADJUSTS FOR THE DELAYS BETWEEN SPEAKERS. THIS MAKES A BIG CONTRIBUTION TO ACHIEVING THE IDEAL SURROUND SOUND IN YOUR HOME THEATRE.

COMPENSATION BY FULL BAND PHASE CONTROL

BEFORE COMPENSATION

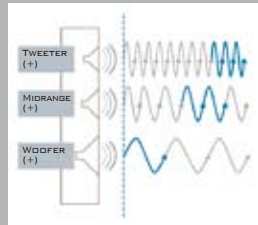

AFTER COMPENSATION

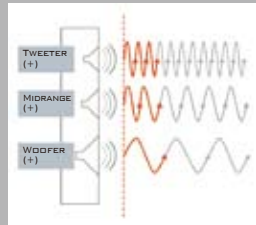

HARMONISATION OF GROUP DELAY BETWEEN UNITS

FULLY COMPATIBLE WITH HIGH QUALITY SURROUND SOUND FORMATS

YOU WILL ENJOY MAXIMUM PERFORMANCE FROM YOUR BLU-RAY DISCS AND DVDS THANKS TO FULL SUPPORT FOR THE DOLBY TRUEHD AND DTS-HD MASTER AUDIO LOSSLESS SURROUND SOUND FORMATS. THE SOUND OF MOVIES AND MUSIC IS COMPLETELY FAITHFUL TO THE ORIGINAL MASTER RECORDING. THE RECEIVERS ARE ALSO COMPATIBLE WITH DTS-HD HIGH RESOLUTION AUDIO AND DOLBY DIGITAL PLUS.



ADVANCED MCACC (MULTI-CHANNEL ACOUSTIC CALIBRATION)

DESIGNED TO CREATE A SOUND FIELD IDEAL FOR SURROUND SOUND REPRODUCTION, ADVANCED MCACC WAS ACHIEVED BY ADDING TIME AXIS ANALYSIS, STANDING WAVE CONTROL AND NEW LR SYMMETRICAL ACOUSTIC EQUALISER TO THE ORIGINAL MCACC SYSTEM. IT COMPENSATES FOR THE DISTANCE, SOUND PRESSURE LEVEL AND FREQUENCY RESPONSE DIFFERENCES OF EACH SPEAKER, AND MAKES NUMEROUS OTHER ADJUSTMENTS AS WELL. TIME AXIS ANALYSIS ALLOWS THE SYSTEM TO DISTINGUISH BETWEEN DIRECT SOUND AND ROOM REVERBERATION, FOR MORE PRECISE ADJUSTMENT, WHILE STANDING WAVE CONTROL ELIMINATES THE BOOMINESS THAT THESE SOUND WAVES CAN CAUSE. THE NEW LR SYMMETRICAL ACOUSTIC EQUALISER ENHANCES STEREO ACCURACY. ALL THIS IS DONE AUTOMATICALLY AT THE TOUCH OF A BUTTON.



SUPERIOR ASPECTS OF ADVANCED MCACC

EXPANDS THE ACOUSTIC MEASUREMENT RANGE TO TWICE THAT OF THE FORMER RANGE - 0 TO 160 MSEC, INCLUDING THE DIRECT SOUND AREA.

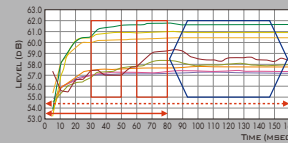

MEASUREMENT OF REVERBERATION SOUND BY ADVANCED MCACC

MEASURES REVERBERATION SOUND TO PERFORM MORE DETAILED SOUND COLOUR COMPENSATION ACCORDING TO THE ROOM ENVIRONMENT.

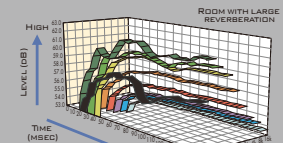

- CONVENTIONAL MCACC MEASUREMENT AND COMPENSATION RANGE: 80 TO 160MSEC
- ADVANCED MCACC MEASUREMENT RANGE: 0 TO 160MSEC
- AUTOMATIC COMPENSATION: AUTOMATICALLY SELECTS 30 TO 50MSEC OR 60 TO 80MSEC.
- MANUAL COMPENSATION: OPTIONALLY SELECTION IN 20MSEC UNITS BETWEEN 0 AND 80MSEC.

DIGITAL VIDEO CONVERTER, VIDEO SCALER AND I/P CONVERSION

A HIGH PERFORMANCE DIGITAL VIDEO CONVERTER ENABLES ALL ANALOGUE INPUT VIDEO SIGNALS (COMPOSITE, S-VIDEO AND COMPONENT) TO BE OUTPUT VIA THE HDMI TERMINAL. THE VIDEO SCALER FUNCTION PERFORMS UPSCALING OF ANALOGUE VIDEO SIGNALS FROM 480I/P TO A MAXIMUM OF 1080P. THE RECEIVERS ALSO PERFORM I/P CONVERSION THAT MORE NATURALLY AND SMOOTHLY REPRESENTS THE CURVED PARTS OF IMAGES OR LETTERS THAT WOULD OTHERWISE HAVE JAGGED EDGES. THE RESULT IS THAT THE RECEIVER TRANSMITS EXTREMELY HIGH QUALITY VIDEO SIGNALS, FROM BOTH ANALOGUE AND DIGITAL INPUTS, TO YOUR HDTV.

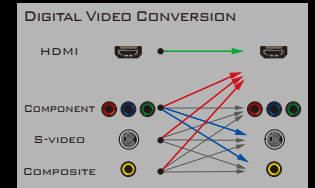

HOME MEDIA GALLERY WITH DLNA SUPPORT

YOU CAN ENJOY HIGH-QUALITY REPRODUCTION OF MOVING PICTURES, MUSIC OR IMAGE FILES STORED ON YOUR PC SIMPLY BY CONNECTING YOUR RECEIVER TO IT OR A LAN NETWORK. YOU ALSO GET THE ABILITY TO ACCESS CONTENT QUICKLY WITH VARIOUS SEARCH OPTIONS LIKE GENRE AND TITLE. HOME MEDIA GALLERY IS DESIGNED TO DLNA (DIGITAL LIVING NETWORK ALLIANCE) GUIDELINES, SO THE RECEIVERS CAN ALSO PLAY LAN-NETWORKED MUSIC FILES FROM OTHER DLNA 1.0-COMPLIANT DEVICES, REGARDLESS OF THE BRAND.



* THE SC-LX90 IS COMPATIBLE WITH ALL MOVING PICTURE, MUSIC AND IMAGE FILES. THE SC-LX81/LX71 ARE COMPATIBLE WITH MUSIC AND JPEG IMAGE FILES, AND THE VSX-LX70 WITH MUSIC FILES ONLY.

JITTER-FREE HDMI TRANSMISSION

ALL LX RECEIVERS AND AMPLIFIER ARE EQUIPPED WITH HDMI INPUT/OUTPUT TERMINALS THAT PROVIDE DIGITAL TRANSMISSION OF THE HIGHEST QUALITY VIDEO AND AUDIO SIGNALS FROM BLU-RAY DISCS. HDMI OFFERS THE ADVANTAGES OF DEEP COLOUR AND X.V. COLOUR, FOR EXTREMELY NATURAL, BEAUTIFUL IMAGES BASED ON 30/36-BIT COLOUR INFORMATION. IT ALSO HAS A JITTER REDUCTION CIRCUIT THAT USES A HIGH PRECISION PLL TO REDUCE THE CLOCK JITTER THAT CAN OCCUR DURING HDMI TRANSMISSION, ENSURING MAXIMUM CLARITY.



COMMAND PERFORMANCES

THE ART OF FILMMAKING HAS SUCH A RICH HISTORY, IT IS NOW STUDIED ALONGSIDE THE CLASSICAL FORMS. TO TRULY APPRECIATE THESE GREAT WORKS, YOU NEED TO BE ABLE TO WATCH THEM IN THEIR PUREST FORM. OUR DVD PLAYERS MAKE THAT POSSIBLE. THEY RECREATE THE MAGIC IN EACH AND EVERY FILM WITH A DAZZLING CLARITY. EVERY FRAME IS RENDERED JUST AS IT WAS CREATED. EVERY SCENE HAS THE RICHNESS, DEPTH AND TEXTURE THAT DEFINE ITS UNIQUE BEAUTY. IN EVERY FORMAT, FOR EVERY FILM EVER MADE, PIONEER DVD PLAYERS WERE DESIGNED FROM THE GROUND UP TO BRING THESE WORKS OF ART TO LIFE.



DVD PLAYER
DV-LX50



THE ULTIMATE MEDIA CENTRE

LIFE'S TOO SHORT TO MISS A THING, AND NOW YOU DON'T HAVE TO. WHETHER YOU WANT TO EXPERIENCE MOVIES AND MUSIC, OR CAPTURE SPECIAL MOMENTS FOREVER, YOU CAN DO IT ALL. WITH OUR DVD RECORDERS, WE CREATED AN EASY-TO-USE, EXTREMELY POWERFUL WAY IN WHICH EVERYTHING CAN BE COLLECTED, ORGANISED, ACCESSED AND ENJOYED. THERE'S NO NEED FOR COMPROMISE; YOU SEE AND HEAR EVERYTHING IN PRISTINE, HIGH-RESOLUTION DIGITAL QUALITY. AND IT'S ALL AVAILABLE AT THE TOUCH OF A BUTTON. THE MEDIA REVOLUTION HAS ARRIVED. YOU'RE IN CHARGE, AND THE POSSIBILITIES ARE ENDLESS.



HDD/DVD RECORDER
DVR-LX70



* AVAILABLE IN ASEAN AND NEW ZEALAND ONLY.



HDD/DVD RECORDER
DVR-LX61



* AVAILABLE IN MIDDLE EAST AND AFRICA ONLY.

DVD PLAYER

HIGH PERFORMANCE 216MHz/12-bit VIDEO D/A CONVERTER

WHEN VIDEO SIGNALS ARE OUTPUT VIA COMPONENT TERMINALS, THE DVD PLAYER USES AN EXTREMELY FAST AND ACCURATE 216MHz/12-bit VIDEO D/A CONVERTER. COMBINING 8x OVERSAMPLING WITH 12-bit PRECISION, THIS PREMIUM DEVICE ENSURES SUPERIOR LINEARITY BY PREVENTING PHASE FLUCTUATIONS.



BURR-BROWN 192kHz/24-bit AUDIO DAC

PIONEER CHOSE A HIGH PERFORMANCE 192kHz/24-bit Audio D/A Converter (BURR-BROWN PCM1796) FOR EACH OF THE SIX CHANNELS, ENSURING TOP QUALITY MULTI-CHANNEL SOUND. THIS DAC USES AN INDEPENDENT POWER SUPPLY TO PREVENT INTERFERENCE FROM OTHER CIRCUITS.



SOLID AUDIO CIRCUIT BLOCK FOR SUPERIOR SOUND

ALL DECODING FUNCTIONS FOR DVD-VIDEO, DVD-AUDIO, SACD AND DTS 96/24 ARE INTEGRATED INTO A SINGLE AV DECODER CHIP, ALLOWING A SIMPLE AND STRAIGHT SIGNAL PATH. THE ISOLATED AUDIO BOARD PREVENTS NOISE INTERFERENCE, WHILE CLEAN POWER IS SUPPLIED BY THE USE OF LOW-IMPEDANCE CAPACITORS FOR CLEAREST SOUND.



SEAMLESS CHASSIS CONSTRUCTION

HIGH QUALITY EXTENDS TO THE BODY CONSTRUCTION, WITH THE BASE PLATE AND BACK PANEL SEAMLESSLY COMBINED INTO A SINGLE CHASSIS UNIT. THIS HELPS STABILISE EARTHING FOR ENHANCED SOUND QUALITY.

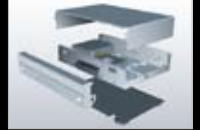

ANTI-VIBRATION DESIGN

TO ENSURE THAT VIBRATIONS CANNOT AFFECT THE SOUND QUALITY, PIONEER DEVELOPED A REINFORCED CHASSIS WITH DUAL LAYER CONSTRUCTION. THE PLAYER ALSO EMPLOYS A DIRECT MOUNT DRIVE MECHANISM, WHICH MINIMISES VIBRATIONS FROM THE DRIVE. ITS LOW CENTRE OF GRAVITY DESIGN ADDS STABILITY TO THE CHASSIS. ADDITIONAL FEATURES INCLUDE AN ACOUSTIC DAMPER TRAY THAT SUPPRESSES TRANSPORT NOISE WHILE INSULATING THE PICKUP FROM VIBRATIONS AND A LOW-LEAKAGE POWER SHIELD CASE.

- HDMI WITH 1080P UPSCALING
- SACD DSD SIGNAL AND DVD-AUDIO HDMI DIGITAL SIGNAL TRANSMISSION
- KURO LINK

HDD/DVD RECORDER

108MHz/14-bit VIDEO DAC (DVR-LX70)

THE DVR-LX70 USES A HIGH PERFORMANCE 108MHz/14-bit VIDEO D/A CONVERTER THAT CONTRIBUTES TO EXCELLENT PICTURE QUALITY BY BOOSTING THE RESOLUTION TO CLOSE TO THAT OF THE ORIGINAL DVD SOURCE.

SUPER HIGH QUALITY XP+ RECORDING MODE

BOTH HDD/DVD RECORDERS FEATURE THE XP+ RECORDING MODE, WHICH LETS YOU MAKE EXTRA HIGH QUALITY RECORDINGS TO THE HDD BY USING A TRANSFER RATE OF AROUND 15 MBPS. IT ALSO LETS YOU STORE PROGRAMMES FROM EXTERNAL COMPONENTS AT THE SAME HIGH QUALITY.

EXTENSIVE DISC COMPATIBILITY

NO WORRIES ABOUT DISC COMPATIBILITY WITH THESE TWO UNITS. IN ADDITION TO DVD, CD AND CD-R/RW DISCS, YOU CAN ENJOY A WIDE SELECTION OF OTHER DISC TYPES: DVD-RAM*, DVD-R/RW, DUAL LAYER DVD-R, DVD+R/RW, AND DOUBLE LAYER DVD+R.



* FOR DVD-RAM PLAYBACK, REMOVE THE DISC FROM THE CARTRIDGE BEFORE USE.

USB CONNECTIONS

USB PORTS ON THE FRONT PANEL GIVE YOU VARIOUS INPUT AND OUTPUT OPTIONS. YOU CAN VIEW DIGITAL PHOTOS SAVED ON A MEMORY STICK OR A DIGITAL CAMERA, AND ALSO PRINT THE PICTURES DIRECTLY USING A PICTBRIDGE COMPATIBLE PRINTER. BY CONNECTING A USB KEYBOARD, YOU CAN EDIT DISC TITLES AND OTHER TEXT.

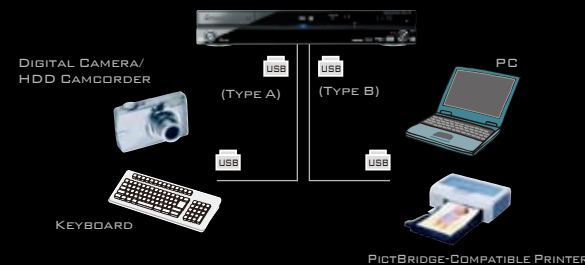

TRANSFER FILES FROM A PC

CONNECT YOUR PC TO THE DVR-LX61 VIA A USB OR ETHERNET CABLE AND COPY WMA, MP3 AND MPEG-4 AAC MUSIC FILES, JPEG IMAGE FILES AND DIVX VIDEO FILES FROM THE PC TO THE HDD. NOW YOU CAN ENJOY ALL YOUR MUSIC, IMAGE AND VIDEO FILES IN YOUR LIVING ROOM ON A LARGER SCREEN AND WITH BETTER SOUND. THE DVR-LX70 CAN COPY MP3 AND WMA MUSIC FILES, GIVING YOU A HIGH QUALITY DIGITAL JUKEBOX.

HOME MEDIA GALLERY (DVR-LX61)

THE HOME MEDIA GALLERY FUNCTION MAKES IT EASY TO PLAY FILES STORED ON THE HDD. THREE DIRECT KEYS ARE AVAILABLE FOR THE HOME MEDIA GALLERY, PROVIDING QUICK ACCESS TO THE MOST RECENTLY RECODED DIVX, JPEG AND LINEAR PCM/MP3/WMA FILES.

KEY FILE	FORMATS
PC	VIDEO DIVX
MUSIC	LINEAR PCM/MP3/WMA AND JPEG
PHOTO	JPEG AND LINEAR PCM/MP3/WMA

GRACENOTE AUTO TITLE (DVR-LX61)

A NICE "EXTRA" FEATURE OFFERED ON THE DVR-LX61 IS THE ABILITY TO AUTOMATICALLY DISPLAY INFORMATION ABOUT EACH MUSIC TRACK. THE SECRET: THE GRACENOTE DATABASE OF TITLES AND ARTISTS IS PREINSTALLED IN THE SYSTEM. AND IF YOU CONNECT TO THE INTERNET, YOU CAN DOWNLOAD UPDATES FROM THE ONLINE GRACENOTE DATABASE.

DOUBLE LAYER CHASSIS (DVR-LX70)

THE HEAVY DOUBLE LAYER CHASSIS ENSURES THAT VIBRATIONS WILL NOT AFFECT SOUND QUALITY.

- DEEP COLOUR (DVR-LX70)
- KURO LINK

MAGIC BY DESIGN

IMAGINE A PLACE WHERE YOU GO TO BE MAGICALLY TRANSPORTED. TO THE MEDITERRANEAN SEA. OR THE NORTH POLE.
OR THE MIDDLE AGES. ANYWHERE, ANYTIME, ANY WORLD. IT'S A PLACE WHERE THE ONLY LIMIT IS IMAGINATION. WHERE THERE ARE NO BOUNDARIES. ONLY POSSIBILITIES.

YOU'VE JUST IMAGINED A PIONEER HOME THEATRE SYSTEM, WHERE THE LATEST TECHNOLOGIES COME TOGETHER AS NEVER BEFORE.

A PLACE WHERE YOU FEEL THE FROZEN AIR AS YOU SCALE A HIMALAYAN PEAK. WHERE THE HOWLING WINDS OF A HURRICANE THREATEN TO LIFT YOUR HOUSE
FROM ITS FOUNDATION. A PLACE WHERE YOU ARE PARTY TO ASTONISHING EXPERIENCES OF SIGHT AND SOUND. IT'S ALSO A VERY ELEGANT PLACE.

AS POWERFUL AS OUR HOME THEATRE SYSTEMS ARE ON THE INSIDE, THEY ARE MINIMALIST ON THE OUTSIDE.

THEY ALWAYS ADD HANDSOMELY TO THE STYLE OF ANY ROOM, BUT NEVER DETRACT FROM THE REAL PURPOSE: PURE MAGIC.



HOME THEATRE SYSTEM
HTP-LX70



HOME THEATRE SYSTEM
HTZ-LX61



SPEAKERS THAT PROJECT A 3D SOUND FIELD TO ENHANCE PRESENCE AND GIVE A FEELING OF EXPANSIVE SPACE

5.1-CHANNEL SURROUND SOUND CAN ENHANCE THE FEELING OF PRESENCE IF IT CAN PROJECT SOUND NOT ONLY IN TWO PLANES BUT THREE DIMENSIONALLY. TO ACHIEVE THIS, THE HTP-LX70 USES POLYHEDRON SPEAKERS BASED ON DODECAHEDRON TECHNOLOGY, WHILE THE HTZ-LX61 FRONT AND SURROUND SPEAKERS HAVE A UNIT FACING UPWARD ON THE TOP OF THE SPEAKER. AS A RESULT, THE SOUND SPREADS OUT NOT ONLY HORIZONTALLY, BUT VERTICALLY AS WELL, CREATING A THREE-DIMENSIONAL SOUND SPACE THROUGHOUT THE ROOM. AS THE SOUND EXPANDS, IT CAN EXPRESS NOT ONLY A FEELING OF MOTION FROM SIDE TO SIDE, BUT A TRULY REALISTIC PERSPECTIVE, OFFERING GREATER ENJOYMENT OF MOVIES AND MUSIC.



ADVANCED DESIGN FEATURES ENABLE THE SYSTEM TO BLEND INTO YOUR INTERIOR

THE HTP-LX70 AND HTZ-LX61 NOT ONLY HAVE A BEAUTIFUL APPEARANCE, THEY WERE DEVELOPED WITH A VIEW TO ENSURING THAT THE AREA AROUND THE TV IS NEAT AND ATTRACTIVE. BY EMPLOYING PIONEER'S DUAL CENTRE METHOD, THE CENTRE SPEAKER DOES NOT HAVE TO BE PLACED ABOVE OR BELOW THE TV, SO SPEAKER LOCATION CAN BE MORE CONVENIENT. IN ADDITION, FRONT STAGE SURROUND ADVANCE LETS YOU ENJOY SURROUND SOUND WITH THE REAR SPEAKERS LOCATED IN THE FRONT. THANKS TO THESE TWO ADVANCED TECHNOLOGIES, YOU CAN ACHIEVE A NEATLY POSITIONED SYSTEM THAT BLENDS IN NICELY WITH YOUR INTERIOR.



THE DUAL CENTRE METHOD ENSURES NATURAL SOUND REPRODUCTION. FURTHERMORE, WITH DIALOGUE ENHANCEMENT, LYRICS AND DIALOGUE ARE ALWAYS CLEARLY HEARD.



RECEIVER SUBWOOFER FOR HD AUDIO (HTP-LX70)

THE RECEIVER SUBWOOFER IS COMPATIBLE WITH THE LOSSLESS SOUND OF DOLBY TRUEHD AND DTS-HD MASTER AUDIO, AND WITH OTHER HIGH QUALITY FORMATS SUCH AS DOLBY DIGITAL PLUS, DTS-HD HIGH RESOLUTION AND DTS EXPRESS. BY CONNECTING A BLU-RAY DISC PLAYER, YOU CAN ENJOY THE HIGHEST QUALITY SURROUND SOUND, JUST AS IT WAS ON THE STUDIO MASTER RECORDING.



HDMI INPUT FOR BLU-RAY DISC PLAYERS

THE HTP-LX70 AND HTZ-LX61 HAVE HDMI INPUT AND OUTPUT TERMINALS THAT CAN TRANSMIT HIGH QUALITY DIGITAL VIDEO AND AUDIO SIGNALS VIA A SINGLE CABLE (HTP-LX70: 3 INPUTS AND 1 OUTPUT; HTZ-LX61: 2 INPUTS AND 1 OUTPUT). BY CONNECTING A BLU-RAY DISC PLAYER, YOU CAN ENJOY THE LOSSLESS SOUND OF HD AUDIO* FROM YOUR PIONEER HOME THEATRE SYSTEM.



*FOR LOSSLESS HD AUDIO WITH THE HTZ-LX61, A BLU-RAY DISC PLAYER COMPATIBLE WITH HD AUDIO DECODING IS NECESSARY.

DOUBLE SUBWOOFERS FOR EXTRA-POWERFUL BASS (HTP-LX70)

THE RECEIVER SUBWOOFER HAS DOUBLE SUBWOOFER DRIVERS BUILT IN, EACH DRIVEN BY ITS OWN DEDICATED AMPLIFIER. WITH LARGE 18CM CONES, THE SUBWOOFERS HAVE A DOWN-FIRING DESIGN THAT EFFICIENTLY RADIATES SOUND. THEIR OUTSTANDING BASS REPRODUCTION CAPABILITY MAKES EXCITING MOVIE SCENES BECOME MORE ALIVE.



IPOD® DIGITAL INPUT FOR HIGH MUSIC QUALITY (HTZ-LX61)

WITH THE HTZ-LX61, YOU CAN ENJOY HIGHER QUALITY SOUND FROM IPOD® AND OTHER AUDIO PLAYERS. THE RECEIVER HAS A USB JACK, ALLOWING IT TO ACCEPT THE DIGITAL SIGNAL FROM THE PLAYER DIRECTLY FOR BEST SOUND PURITY. FURTHERMORE, THE HIGH QUALITY AMPLIFIER AND SPEAKERS OF THE HTZ-LX61 ENSURE THAT YOU CAN ENJOY EVEN RICHER AND HIGHER QUALITY SOUND. ANOTHER ADVANTAGE IS THAT YOU CAN OPERATE YOUR IPOD® USING THE HOME THEATRE CONTROLLER.

*COMPATIBLE WITH FIFTH GENERATION AND LATER IPOD®, AND IPOD® NANO.

SOUND RETRIEVER PLAYS COMPRESSED MUSIC FILES WITH CD-LIKE SOUND QUALITY (HTP-LX70, HTZ-LX61)

WITH THE COMPRESSED SOUND FORMATS USED FOR PC OR IPOD® MUSIC FILES, SOME OF THE SOUND DATA IS CUT DURING THE COMPRESSION PROCESS. THESE MUSIC FILES BENEFIT FROM THE SOUND RETRIEVER FUNCTION THAT SUPPLEMENTS FOR LOST SOUNDS, LETTING YOU ENJOY MUSIC WITH QUALITY THAT RIVALS THAT OF CD. THE HTZ-LX61 IS ALSO COMPATIBLE WITH THE ADVANCED SOUND RETRIEVER THAT PLAYS HIGH QUALITY SOUND WITH EVEN GREATER DEPTH.

MOTION SENSOR AND TOUCH SENSORS ENHANCE LESS ELEMENT DESIGN (HTZ-LX61)

THERE IS A MOTION SENSOR ON THE FRONT PANEL OF THE RECEIVER. WHEN YOU APPROACH THE RECEIVER TO OPERATE IT OR INSERT A DISC, THE SENSOR DETECTS YOU AND AUTOMATICALLY TURNS ON THE DISPLAY. WHEN YOU MOVE AWAY FROM THE RECEIVER DURING PLAY, THE DISPLAY SHUTS OFF, SAVING ENERGY. INSTEAD OF THE USUAL BUTTONS, THERE ARE FLAT TOUCH SENSORS ON THE TOP OF THE RECEIVER.



PURE SOUND. PURE EMOTION.

SOUND IS PURE EMOTION. A HURRIED KNOCK ON THE DOOR. THE CRASH OF A WAVE. SOUND CUTS THROUGH ALL THE LAYERS AND GETS US RIGHT WHERE WE LIVE.

BEFORE WE CAN THINK, BEFORE WE CAN JUDGE, WE FEEL. WHEN WE HEAR AN INFANT CRY, OUR BODIES MOVE TOWARD IT.

WHEN WE HEAR A LOVER'S VOICE, OUR PUPILS DILATE. A SONG FROM LONG AGO TRANSPORTS US INSTANTLY TO ANOTHER TIME AND PLACE.

PIONEER EX SPEAKERS DON'T SIMPLY REPRODUCE SOUND. DESIGNED AROUND OUR CST TECHNOLOGY, WHICH DELIVERS BOTH MIDRANGE AND HIGH FREQUENCIES FROM A SINGLE ORIGIN, THEY DELIVER SOUNDSCAPES WITH ASTONISHING COHERENCY. THE RESULT IS A CLARITY AND RICH, FULL REALISM THAT LETS YOU HEAR IN WAYS YOU HAVE NEVER HEARD BEFORE.

EX SERIES SPEAKER SYSTEMS



FLOORSTANDER
S-1EX



COMPACT MONITOR
S-2EX



CENTRE CHANNEL
S-7EX



POWERED SUBWOOFER
S-W1EX



FLOORSTANDER
S-3EX



COMPACT MONITOR
S-4EX



CENTRE CHANNEL
S-8EX



THE CST (COHERENT SOURCE TRANSDUCER)

OUR ENTIRE RANGE OF EX SERIES SPEAKERS EMPLOY TAD'S INGENUOUS AND EXCLUSIVE CST DRIVER TECHNOLOGY. THE TWEETER IS MOUNTED AT THE CENTER POINT OF THE MIDRANGE DRIVER, ALLOWING SOUND TO BE PRECISELY CONTROLLED AT ALL FREQUENCIES.



PASSION THROUGH UNITY

THE UNIQUE ONE-PIECE CONE AND CENTER CAP CONSTRUCTION OF THE EX SERIES BASS DRIVERS ADDS RIGIDITY AND MECHANICAL INTEGRITY. THIS ELIMINATES UNWANTED CONE RESONANCES, IMPROVES ACCURACY AND DELIVERS BASS THAT CAN BE FELT DOWN TO YOUR CORE.



PROVEN, UNLIKE ANY OTHER

THE EX SERIES WAS RIGOROUSLY TESTED AT THE WORLD-RENOWNED AIR STUDIOS IN LONDON. FOUNDED BY LEGENDARY PRODUCER SIR GEORGE MARTIN, THE STUDIO'S AURAL EXPERTISE IS SECOND TO NONE. WE COULDN'T ASK FOR A BETTER TESTAMENT OF OUR ABILITY.



ANDREW JONES AND TEAM

AS BOTH THE DIRECTOR OF ENGINEERING AND SENIOR PRODUCT DESIGNER, HIS TEAM CREATED THE EX LINE OF HOME SPEAKERS, WHICH WAS INSPIRED BY THEIR LEGENDARY TECHNICAL AUDIO DEVICES TAD REFERENCE ONE FLAGSHIP SPEAKER.

ANDREW JONES AND THE TAD REFERENCE ONE.

- PHASE CONTROL DESIGN
- BERYLLIUM TWEETER/MAGNESIUM MIDRANGE (S-1EX/2EX/7EX)
- CERAMIC GRAPHITE TWEETER/MAGNESIUM MIDRANGE (S-3EX/4EX/8EX)

*SHOWN WITH OPTIONAL SPEAKER STAND. *SPEAKERS ARE SOLD INDIVIDUALLY.

SERIES 8 SPEAKER SYSTEMS



FLOORSTANDER
S-81-K/QL



COMPACT MONITOR
S-81B-LR-K/QL/W



CENTRE CHANNEL
S-81C-K/QL



POWERED SUBWOOFER
S-LX70W

NEW DESIGN: PIONEER'S EXCLUSIVE 13CM CONCENTRIC DRIVER

INHERITING THE CST CONCEPT CREATED THROUGH AN INTENSIVE FOCUS ON POINT SOUND SOURCES, THIS DRIVER FEATURES A TITANIUM DOME TWEETER INSTALLED IN THE CENTRE OF AN ARAMID DIAPHRAGM UNIT. BY RADIATING SOUND OVER A BROAD BAND FROM A SINGLE POINT, IT REPRODUCES SOUND THAT IS FAITHFUL TO THE ORIGINAL SOURCE.

NEW 13CM WOOFER

THIS WOOFER OFFERS ENHANCED LINEARITY WITH A HIGH STRENGTH TITANIUM BOBBIN, AN ARAMID CARBON COMPOUND DIAPHRAGM, AND A CORRUGATED EDGE, ALL CREATED BY SPECIAL MANUFACTURING METHODS.

NEW RIFFEL SUPER TWEETER

THIS TWEETER UNIT WAS DEVELOPED BY PIONEER TO HANDLE THE HD FREQUENCY RANGE BY ACHIEVING THE ULTRA-HIGH 100KHZ REPRODUCTION OF DVD-A AND SACD.

LDMC MAGNETIC CIRCUIT

PIONEER'S PROPRIETARY SPECIAL-STRUCTURE LDMC (LINEAR DRIVE MAGNETIC CIRCUIT) ACHIEVES HIGH LINEARITY WITH LOW DEFORMATION.

- 13CM WOOFER HAS CORRUGATED EDGE AND ARAMID CARBON COMPOUND DIAPHRAGM
- THREE POINT SUPPORT STRUCTURE WITH HIGH STABILITY
- ABD & AFAST TECHNOLOGY
- MINIMAL DESIGN IN TUNE WITH THE LATEST EUROPEAN TREND
- ROUND FORM ENCLOSURE
- PHASE CONTROL DESIGN



SPEAKER SYSTEMS
S-LX70-LR/S-LX70C/S-LX70W

LX70 SERIES SPEAKER SYSTEMS

S-LX70-LR/S-LX70C LUXURY QUALITY THIN SPEAKERS WITH NEW SOUND AND DESIGN SUITED FOR PLASMA MONITORS.

THIS THIN SPEAKER SYSTEM FEATURES SOUND AND DESIGN IDEALLY MATCHED TO PLASMA MONITORS. IT INCLUDES A NEW EXTRUDED ALUMINIUM MATERIAL CABINET, A THIN, HIGH PERFORMANCE WOOFER AND OTHER SUPERIOR FEATURES. THE ELEGANT DESIGN FEATURES A SIMPLE GLOSSY BLACK FINISH, WHICH HARMONISES BEAUTIFULLY NOT ONLY WITH YOUR TV, BUT WITH YOUR INTERIOR.

NEW THIN, HIGH PERFORMANCE 13CM WOOFER WITH EX QUALITY (S-LX70-LR/S-LX70C)

THE THIN, HIGH PERFORMANCE 13CM WOOFER WAS CREATED BASED ON TECHNOLOGIES USED IN THE LUXURY EX SERIES SPEAKERS. IT INCORPORATES A NEW DIAPHRAGM AND A CORRUGATED EDGE MADE OF FOAMED POLYCARBONATE URETHANE MATERIAL, HIGH SOUND QUALITY TECHNOLOGIES DIRECTLY INHERITED FROM THE EX SERIES, AS WELL AS A LARGE 48MM DIAMETER VOICE COIL. IT REPRODUCES BASS WITH POWER THAT FAR EXCEEDS THAT OF ORDINARY THIN SPEAKERS.

- S-LX70-LR/S-LX70C: WEB GUIDE TWEETER THAT CONTROLS THE FLOW OF SOUND.
- S-LX70W: NEW 500W (PEAK) SUBWOOFER FOR DEEP BASS.
- PHASE CONTROL DESIGN ACHIEVES A DRAMATIC IMPROVEMENT IN MULTI-CHANNEL SOUND QUALITY.

KURO FLAT PANEL DISPLAY/KURO FLAT SCREEN TV SPECIFICATIONS

	KRP-600M	KRP-500M	KRP-500A
PICTURE			KRP-500P (PANEL)
SCREEN SIZE	60"	50"	50"
ASPECT RATIO	16:9	16:9	16:9
NUMBER OF PIXELS	1,920 x 1080	1,920 x 1080	1,920 x 1080
VIDEO SIGNALS	PAL/SECAM/NTSC3.58/NTSC4.43/PAL-M/PAL-N/HD	PAL/SECAM/NTSC3.58/NTSC4.43/PAL-M/PAL-N/HD	PAL/SECAM/NTSC3.58/NTSC4.43/PAL-M/PAL-N/HD
NEW DIRECT COLOUR FILTER	•	•	•
AUDIO OUTPUT POWER	9 W + 9 W (6 OHMS)	9 W + 9 W (6 OHMS)	18 W + 18 W (6 OHMS)
			KRP-MD1 (MEDIA RECEIVER)
PC SIGNALS	•	•	•
DUAL SCREEN MODE (PAP)	•	•	•
PICTURE-IN-PICTURE MODE (PIP)	•	•	•
AV SELECTION	• (PURE)	• (PURE)	•
OPTIMUM MODE	• (NEW)	• (NEW)	• (NEW)
INTELLIGENT MODE (DRE, COLOUR)	•	•	•
NEW INTELLIGENT MODE (DRE, COLOUR)	•	•	•
FIELD NOISE REDUCTION	•	•	•
BLOCK NOISE REDUCTION	•	•	•
MOSQUITO NOISE REDUCTION	•	•	•
PAL 3D Y/C SEPARATION	•	•	•
SOUND			
TONE CONTROL (BASS, TREBLE, BALANCE)	•	•	•
SRS WOW HD	-	-	•
SRS (SURROUND)	-	-	•
SRS FOCUS (AUDIO ORIENTATION)	-	-	•
SRS TRUBASS (BASS BOOST)	-	-	•
SRS DEFINITION	-	-	•
AUTO VOLUME CONTROL	-	-	•
ANALOGUE TUNER			
AUTO CHANNEL PRESET	-	-	•
RECEPTION SYSTEM	-	-	PAL B/G, I, D/K, M/N, SECAM B/G, D/K, NTSC M/N
AUDIO SYSTEM	-	-	NICAM B/G, I, D/K, CDR A2 B/G, D/K, MTS
NUMBER OF PRESET PROGRAMMES	-	-	GENERAL: 99, US AIR: 68, US CABLE: 125
TELETEXT (DEEFAX/FLOF/TOF)	-	-	•
PICTURE AND TEXT (DUAL SCREEN)	-	-	•
CONTROL			
NUMBER OF LANGUAGES	15 (ENG/FRE/GER/ESP/ITA/JPN/DUTCH/SWEDISH/PORTUGUESE/GREEK/FINNISH/RUSSIAN/TURKISH/NORWEGIAN/DANISH)	15 (ENG/FRE/GER/ESP/ITA/JPN/DUTCH/SWEDISH/PORTUGUESE/GREEK/FINNISH/RUSSIAN/TURKISH/NORWEGIAN/DANISH)	5 (ENGLISH/SPANISH/PORTUGUESE/TRADITIONAL CHINESE/SIMPLIFIED CHINESE)
REMOTE CONTROLLER	PRESET (TV/VCR/STB/DVD/DVR/BD)	PRESET (TV/VCR/STB/DVD/DVR/BD)	PRESET (TV/VCR/STB/DVD/DVR/BD)
KURO LINK*	•	•	•
USB2.0 (FOR HOME GALLERY)	-	-	•
ROOM LIGHT SENSOR	•	•	•
IP CONTROL (WEB SERVER, E-MAIL)	•	•	-
CONNECTION TERMINALS			
HDMI	2	2	3
COMPONENT VIDEO IN	1	1	2
S-VIDEO IN	-	-	3
RCA AV IN	1	1	3 (REAR) 1 (FRONT)
PC INPUT	1	1	1 (FRONT)
DVI IN	1	1	-
RCA AV OUT	-	-	1
ANTENNA TERMINAL ANALOGUE TUNER	-	-	1
HEADPHONE OUT	-	-	1 (FRONT)
SUB WOOFER OUT	-	-	1
PIONEER SYSTEM REMOTE OUTPUT	-	-	1 (SR)
LAN PORT	1	1	-
IR REPEATER OUT	1	1	-
RS-232C	1	1	-
GENERAL			
DIMENSIONS	1465 MM (W) x 876 MM (H) x 64 MM (D)	1233 MM (W) x 723 MM (H) x 64 MM (D)	KRP-500P: 1233 MM (W) x 723 MM (H) x 64 MM (D) KRP-MD1: 420 MM (W) x 80 MM (H) x 278 MM (D)
WEIGHT	49.9 KG	31.4 KG	KRP-500P: 31.4 KG, KRP-MD1: 4.3 KG
POWER CONSUMPTION	486 W	386 W	KRP-500P: 386 W, KRP-MD1: 26 W
POWER REQUIREMENTS	AC 100-240 V, 50/60 HZ	AC 100-240 V, 50/60 HZ	AC 110-240 V, 50/60 HZ

OPTIONAL ACCESSORIES

	KRP-600M	KRP-500M	KRP-500A
TABLE TOP STAND	KRP-TS01	KRP-SWD1, KRP-TS02	KRP-SWD1, KRP-TS02
SIDE SPEAKER	KRP-S02	KRP-S04	KRP-S03
WALL MOUNT UNIT	KRP-WM01, PDK-WM03	KRP-WM02, PDK-WM05, PDK-WM02	KRP-WM02, PDK-WM05, PDK-WM02
COLOUR SENSOR	-	-	KRP-SES1
10M SYSTEM CABLE (PANEL TO MEDIA RECEIVER)	-	-	KRP-CA01
DIMENSIONS: PDP W/ STAND	1465MM (W) x 953 MM (H) x 430 MM (D)	1233MM (W) x 804 MM (H) x 410 MM (D) w/KRP-SWD1 1233MM (W) x 788 MM (H) x 350 MM (D) w/KRP-TS02	1233MM (W) x 804 MM (H) x 410 MM (D) w/KRP-SWD1 1233MM (W) x 788 MM (H) x 350 MM (D) w/KRP-TS02
DIMENSIONS: PDP W/ SIDE SPEAKERS AND STAND	1677MM (W) x 953 MM (H) x 430 MM (D)	1399MM (W) x 804 MM (H) x 410 MM (D) w/KRP-SWD1 1399MM (W) x 788 MM (H) x 350 MM (D) w/KRP-TS02	1399MM (W) x 804 MM (H) x 410 MM (D) w/KRP-SWD1 1399MM (W) x 788 MM (H) x 350 MM (D) w/KRP-TS02

*THE TERM KURO LINK IS EXPRESSED AS HDMI CONTROL ON PRODUCTS AND OPERATING INSTRUCTIONS.

DIMENSIONS

UNIT: MM

KRP-600M WITH KRP-TS01

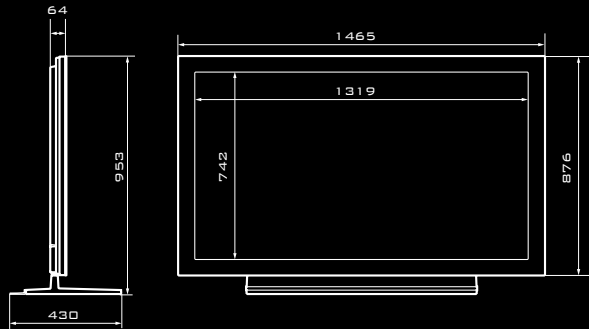

KRP-500M WITH KRP-TS02

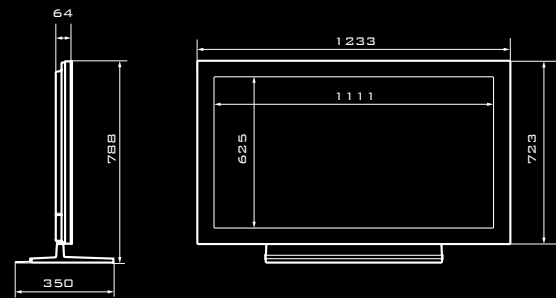

KRP-500P WITH KRP-TS02

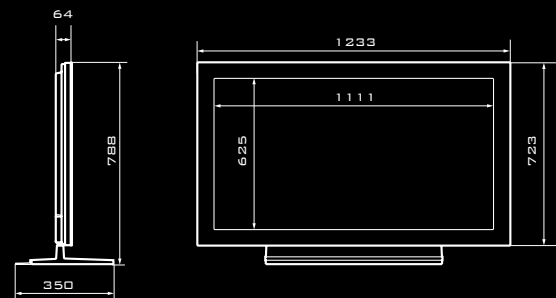

BLU-RAY DISC PLAYERS SPECIFICATIONS

	BDP-LX91	BDP-LX71
PLAYBACK DISCS		
BD-ROM (BDMV)	•	•
BD-R/RE (BDMV/BD-RE)	•	•
DVD-VIDEO	•	•
DVD-R (VIDEO MODE, VR MODE, BDMV, PC-FILES ^{*1})	•	•
DVD-R DL (VIDEO MODE, VR MODE, BDMV, PC-FILES ^{*1})	•	•
DVD-RW (VIDEO MODE, VR MODE, BDMV, PC-FILES ^{*1})	•	•
AVCHD (DVD-R, DVD-R DL, DVD-RW)	•	•
CD (CD-DA, DTS-CD, PC-FILES ^{*1})	•	•
PC-FILES		
DIVX	•	*2
JPEG	•	*5
MP3	•	•
WMA (WINDOWS MEDIA AUDIO)	•	•
VIDEO		
VIDEO D/A CONVERTER	297 MHz/14-bit (HD), 216 MHz/14-bit (SD)	297 MHz/12-bit (HD), 216 MHz/12-bit (SD)
SUPER FINE FOCUS DIGITAL FILTER	•	•
PIXEL SCALER	•	•
DUAL SYSTEM (PAL/NTSC)	•	•
PURECINEMA PROGRESSIVE SCAN	•	•
DVD UP-CONVERSION TO 1080P	•	•
1080/24P OUTPUT	• (BD/DVD) ^{*3}	• (BD)
DEEP COLOUR	• (48-bit) ^{*4}	• (36-bit)
X.V.COLOUR	•	-
COMPONENT FRAME DNR	•	•
MOSQUITO & BLOCK NR	•	•
VIDEO ADJUST	•	•
ANAMORPHIC ZOOM	•	-
AUDIO		
192 KHZ/24-bit D/A CONVERTER	•	•
PART NO. FOR D/A CONVERTER (7.1 CH)	Wolfson WM8740 x 8	Wolfson WM8740 x 4
POWER TRANSFORMER FOR AUDIO	TOROIDAL	-
DTS-HD MASTER AUDIO	• ^{*5}	• ^{*5}
DTS-HD HIGH RESOLUTION AUDIO	•	•
DTS DIGITAL SURROUND	•	•
DOLBY TRUEHD	•	•
DOLBY DIGITAL PLUS	•	•
DOLBY DIGITAL	•	•
MPEG-2 AAC	•	•
DIGITAL AUDIO OUTPUT (DOLBY DIGITAL, DTS, LINEAR PCM, MPEG-2 AAC)	•	•
PQ/Ls WITH HDMI	•	•
PURE AUDIO	•	-
DYNAMIC RANGE CONTROL	•	•
OTHERS		
PROFILE	BD-LIVE READY ^{*5} /BONUSVIEW	BONUSVIEW
KURO LINK ^{*6}	•	•
AUTO LIP SYNCHRONOUS FUNCTION	•	-
10-KEY DIRECT SEARCH & PLAY (CHAPTER/TRACK)	•	•
RESUME FUNCTION (STOP KEY)	•	•
REPEAT MODE (DISC, TITLE/CHAPTER, A-B)	•	•
RANDOM PLAY (CD/TRACK, WMA & MP3 & JPEG FILE)	•	•
TITLE/TRACK/TIME SEARCH	•	•
PROGRAMME PLAY (CD/TRACK, WMA & MP3 FILE)	•	•
SPEAKER SETTING	•	•
ADVANCED GUI (GRAPHICAL USER INTERFACE)	•	•
SET-UP NAVIGATOR	•	•
ON-SCREEN INFORMATION	•	•
ON-SCREEN BIT RATE METER	•	•
FL DIMMER	•	•
SCREEN SAVER	•	•
AUTO POWER OFF	•	•
TERMINALS		
HDMI	2 (GOLD PLATED)	1
COMPONENT VIDEO OUTPUT (Y, PB, PR)	1 (BNC, GOLD PLATED)	1 (GOLD PLATED)
S-VIDEO OUTPUT	1 (GOLD PLATED)	1 (GOLD PLATED)
VIDEO OUTPUT	1 (GOLD PLATED)	1 (GOLD PLATED)
COAXIAL DIGITAL AUDIO OUTPUT	1 (GOLD PLATED)	1 (GOLD PLATED)
OPTICAL DIGITAL AUDIO OUTPUT	1	1
7.1 CH ANALOGUE AUDIO OUTPUT	1 (GOLD PLATED)	1 (GOLD PLATED)
2CH ANALOGUE AUDIO OUTPUT	-	1 (GOLD PLATED)
ETHERNET	1	-
RS-232C	1	-
SR INPUT	1	1
GENERAL		
DIMENSIONS (W x H x D)	420 x 143 x 365 MM	420 x 124 x 360 MM
WEIGHT	13.8 KG	5.7 KG
POWER CONSUMPTION	59 W / 0.3 W	37 W / 0.5 W
POWER REQUIREMENTS	AC 220-240 V, 50/60 Hz	AC 220-240 V, 50/60 Hz, AC 110-240 V, 50/60 Hz

*1 ISO 9660 FILE SYSTEM ONLY *2 EXTERNAL SUBTITLE FILES SUPPORT WITH FIRMWARE UPDATE *3 DVD IS NTSC ONLY *4 EXCEPT 1080P/50 AND 1080P/60 OUTPUT *5 WITH FIRMWARE UPDATE

*6 THE TERM "KURO LINK" IS EXPRESSED AS "HDMI CONTROL" ON PRODUCTS AND OPERATING INSTRUCTIONS.

A/V MULTI-CHANNEL PRE-MAIN AMPLIFIER/A/V MULTI-CHANNEL RECEIVERS SPECIFICATIONS

	SC-LX9D	SC-LX81	SC-LX71	VSX-LX7D	VSX-LX51
AMPLIFIER DESIGN					
CHANNELS	10	7	7	7	7
AMPLIFICATION TYPE	DIRECT ENERGY HD	DIRECT ENERGY HD	DIRECT ENERGY HD	DISCRETE (A.D. ENERGY)	DISCRETE (A.D. ENERGY)
IMPEDANCE GUARANTEE	FRONT : 4 OHMS / OTHERS : 6 OHMS	6 OHMS	6 OHMS	6 OHMS	6 OHMS
CONSTRUCTION DESIGN					
ULTRA RIGID SEPARATED CONSTRUCTION	•	-	-	-	-
ADVANCED DIRECT CONSTRUCTION	•	•	•	•	•
3-D SPACE FLAME CONSTRUCTION	•	•	•	•	-
TRANS. STABILIZER	•	•	•	•	•
INSULATED DUAL CHASSIS	•	•	•	•	•
INSULATOR	TAOC	NORMAL	NORMAL	NORMAL	NORMAL
DIGITAL AUDIO DESIGN					
DIGITAL CORE ENGINE	THE 3RD-GENERATION SHARC PROCESSOR X 2 + FREESCALE DSP	FREESCALE DUAL CORE AND DSP ENGINES	FREESCALE DUAL CORE AND DSP ENGINES	THE 3RD-GENERATION SHARC PROCESSOR + FREESCALE DSP	FREESCALE DUAL CORE
DAC	192 KHz/24-BIT	192 KHz/24-BIT	192 KHz/24-BIT	192 KHz/24-BIT	192 KHz/24-BIT
ADC	192 KHz/24-BIT	192 KHz/24-BIT	192 KHz/24-BIT	192 KHz/24-BIT	96 KHz/24-BIT
DIGITAL VIDEO DESIGN					
VIDEO CONVERTER	UP TO HDMI	UP TO HDMI	UP TO HDMI	UP TO HDMI	UP TO HDMI
VIDEO SCALER (ANALOGUE TO HDMI)	UP TO 1080P	UP TO 1080P	UP TO 1080P	UP TO 1080P	UP TO 1080P
VIDEO SCALER (ANALOGUE TO ANALOGUE)	UP TO 1080I	-	-	-	-
SOUND FIELD CALIBRATION FEATURES					
PHASE CONTROL	•	•	•	•	•
FULL BAND PHASE CONTROL	•	•	•	•	-
ADVANCED MCACC	•	•	•	•	•
PRECISION DISTANCE	•	-	-	-	-
SYMMETRIC EQ	•	•	•	•	•
STEP OF SPEAKER DISTANCE ADJUSTMENT	1 CM	1 CM	1 CM	1 CM	1 CM
STANDING WAVE CONTROL	•	•	•	•	•
EQ BAND	9-BAND	9-BAND	9-BAND	9-BAND	9-BAND
MEMORY TYPE	6	6	6	6	6
PC DISPLAY	•	•	•	•	•
X-CURVE	•	•	•	•	•
LICENSE / FORMAT FEATURE					
AIR STUDIOS	MONITOR REFERENCE	MONITOR	MONITOR	MONITOR	-
THX	THX ULTRA2 PLUS	THX ULTRA2 PLUS	THX SELECT2 PLUS	THX SELECT2	THX SELECT2 PLUS
DOLBY DIGITAL	•	•	•	•	•
DOLBY TRUEHD	•	•	•	•	•
DOLBY DIGITAL PLUS	•	•	•	•	•
DOLBY DIGITAL EX / DOLBY PRO LOGIC IIX	•	•	•	•	•
DTS	•	•	•	•	•
DTS-HD MASTER AUDIO	•	•	•	•	•
DTS-HD HIGH RESOLUTION AUDIO	•	•	•	•	•
DTS-EXPRESS / DTS-ES	•	•	•	•	•
DTS 96/24 / DTS Neo:6	•	•	•	•	•
WMA9 PRO	•	•	•	•	•
NEURAL-THX SURROUND	•	•	•	•	•
LISTENING MODES					
AUTO SURROUND	•	•	•	•	•
STREAM DIRECT	NORMAL & PURE	NORMAL & PURE	NORMAL & PURE	NORMAL & PURE	NORMAL & PURE
ADVANCED SURROUND MODES	13+1 MODES *1	13+1 MODES *1	13+1 MODES *1	13+1 MODES *1	13+1 MODES *1
FRONT STAGE SURROUND	• (FOCUS, WIDE)	• (FOCUS, WIDE)	• (FOCUS, WIDE)	• (FOCUS, WIDE)	• (FOCUS, WIDE)
HEADPHONE SURROUND	•	•	•	•	•
VIRTUAL SURROUND BACK	•	•	•	•	•
AUDIO FEATURES					
SAMPLING RATE CONVERTER	• (UP TO 192 KHz)	• (UP TO 192 KHz)	-	-	-
DSD DIRECT	•	-	-	-	-
DSD TO PCM CONVERTER	•	•	•	•	•
DIALOGUE ENHANCEMENT	•	•	•	•	•
ADVANCED SOUND RETRIEVER	•	•	•	SOUND RETRIEVER	•
DIGITAL NOISE REDUCTION	•	•	•	•	•
MIDNIGHT LISTENING MODE	•	•	•	•	•
SOUND DELAY (LIP-SYND)	•	•	•	•	•
SPEAKER A/B	VERSATILE SPEAKER CONFIGURATION	VERSATILE SPEAKER CONFIGURATION	VERSATILE SPEAKER CONFIGURATION	VERSATILE SPEAKER CONFIGURATION	VERSATILE SPEAKER CONFIGURATION
BI-AMPLIFIER	• (ALL : 5 CH / FRONT CH)	• (FRONT CH)	• (FRONT CH)	• (FRONT CH)	• (FRONT CH)
SPEAKER TERMINAL	HIGH & QUALITY LARGE BANANA & Y	LARGE	LARGE	LARGE	LARGE
AUTO LEVEL CONTROL	-	•	•	•	•
PQLS	• (I. LINK)	• (HDMI)	• (HDMI)	-	-
HDMI					
KURO LINK *2	•	•	•	•	•
DEEP COLOUR	•	•	•	•	•
X.V. COLOUR	•	•	•	•	•
1080P TRANSFERRING	• (1080P@24/50/60 Hz)	• (1080P@24/50/60 Hz)	• (1080P@24/50/60 Hz)	• (1080P@60 Hz)	• (1080P@24/50/60 Hz)
IPDD*					
INTERFACE	WITH SUPPLIED DEDICATED CABLE	USB	USB	WITH SUPPLIED DEDICATED CABLE	USB
SUPPORT MODELS	4TH GEN. ABOVE/MINI/NANO/CLASSIC/TOUCH	5TH GEN./NANO/CLASSIC/TOUCH	5TH GEN./NANO/CLASSIC/TOUCH	3RD GEN. ABOVE/MINI/NANO/CLASSIC/TOUCH	5TH GEN./NANO/CLASSIC/TOUCH
IPDD DIGITAL AUDIO	•	•	•	-	-
IPDD VIDEO	•	-	-	-	-

A/V MULTI-CHANNEL PRE-MAIN AMPLIFIER/A/V MULTI-CHANNEL RECEIVERS SPECIFICATIONS

	SC-LX90	SC-LX81	SC-LX71	VSX-LX70	VSX-LX51
USB					
TERMINAL TYPE	A-TYPE (VER. 2.0 HI-SPEED)	A-TYPE (VER. 2.0 FULL-SPEED)	A-TYPE (VER. 2.0 FULL-SPEED)	A-TYPE (VER. 2.0 FULL-SPEED)	A-TYPE (VER. 2.0 FULL-SPEED)
MEMORY AUDIO SUPPORT	•	•	•	•	•
NETWORK FEATURE					
HOME MEDIA GALLERY SUPPORT	• (AUDIO, MOVIE + IMAGE)	• (AUDIO + JPEG)	• (AUDIO + JPEG)	• (AUDIO)	-
PLAYSFORSURE CERTIFIED	•	•	•	•	-
DLNA CERTIFIED	•	•	•	•	-
INTERNET RADIOS	-	•	•	•	-
V-TUNER	-	•	•	•	-
NEURAL MUSIC DIRECT	-	•	•	•	-
COPYRIGHT PROTECTION CONTENTS	•	•	•	•	-
TUNER					
FM/AM TUNER	-	•	•	•	•
RADIO RANDOM PRESET SELECT	-	30	30	30	30
FM/AM 3-SPEED ACCELERATED TUNING	-	•	•	•	•
REMOTE CONTROL					
TYPE	LCD LEARNING W BACK LIGHT	LCD LEARNING W BACK LIGHT	LCD LEARNING W BACK LIGHT	LCD LEARNING	PRESET
MULTI-OPERATION	•	•	•	•	-
TERMINALS (MAIN ROOM)					
HDMI INPUT/OUTPUT	• (6IN/2OUT)	• (4IN/2OUT)	• (4IN/1 OUT)	• (4IN/1 OUT)	• (3IN/1 OUT)
i.LINK	• (2)	-	-	-	-
USB INPUT	•	•	•	•	•
ETHERNET INPUT	•	•	•	•	-
IPOD® FOR ANALOGUE DEDICATED CABLE	•	-	-	-	-
DIGITAL COAXIAL INPUT/OUTPUT	• (4IN/1 OUT)	• (3IN)	• (2IN)	• (2IN)	• (2IN)
DIGITAL OPTICAL INPUT/OUTPUT	• (7IN/2OUT)	• (5IN/2OUT)	• (5IN/2OUT)	• (5IN/2OUT)	• (4IN/1 OUT)
ANALOGUE MULTI-CH INPUT	• (7.1 CH)	• (7.1 CH)	• (7.1 CH)	• (7.1 CH)	• (7.1 CH)
PREAMP OUTPUT	• (1.0, 2CH)	• (7.1 CH)	• (7.1 CH)	• (7.1 CH)	• (7.1 CH)
PHONO INPUT	• (MM)	• (MM)	• (MM)	• (MM)	-
AUDIO IN / REC. OUT	• (5IN/1 OUT)	• (3IN/1 OUT)	• (3IN/1 OUT)	• (3IN/1 OUT)	• (2IN/1 OUT)
AV (COMPOSITE) IN / REC. OUT	• (8IN/2OUT)	• (7IN/2OUT)	• (7IN/2OUT)	• (7IN/2OUT)	• (5IN/2OUT)
S-VIDEO IN / REC. OUT	• (4IN/2OUT) (ASSIGNABLE)	• (7IN/2OUT)	• (7IN/2OUT)	• (5IN/2OUT) (ASSIGNABLE)	• (5IN/2OUT)
COMPONENT VIDEO IN	• (5IN) (ASSIGNABLE)	• (3IN) (ASSIGNABLE)	• (3IN) (ASSIGNABLE)	• (3IN) (ASSIGNABLE)	• (3IN) (ASSIGNABLE)
MONITOR VIDEO OUT (TO TV)					
COMPONENT/S-VIDEO/COMPOSITE	1/1/1	1/1/1	1/1/1	1/1/1	1/1/1
POWER OUTPUT					
SIMULTANEOUS	1 400 W (200 W x 7 CH) 1400 W (140 W x 10 CH) (20 HZ-20KHZ, 0.05% THD, 8 OHMS)	700 W (100 W x 7 CH) (1 KHZ, 1% THD, 8 OHMS)	630 W (90 W x 7 CH) (1 KHZ, 1% THD, 8 OHMS)	-	-
CONTINUOUS POWER OUTPUT STEREO (1 KHZ, 1.0 % THD, 6 OHMS)	-	190 W + 190 W	180 W + 180 W	180 W + 180 W	150 W + 150 W
RATED POWER	200 W + 200 W (20 HZ-20KHZ, 0.05% THD, 8 OHMS)	140 W + 140 W	140 W + 140 W	140 W + 140 W	120 W + 120 W
OUTPUT MULTI-CH					
(20 HZ-20 KHZ, 0.09 % THD, 8 OHMS)					
FRONT	200 W (20 HZ-20KHZ, 0.05% THD, 8 OHMS)	140 W	140 W	140 W	120 W
CENTRE	200 W (20 HZ-20KHZ, 0.05% THD, 8 OHMS)	140 W + 140 W	140 W + 140 W	140 W + 140 W	120 W + 120 W
SURROUND	200 W + 200 W (20 HZ-20KHZ, 0.05% THD, 8 OHMS)	140 W + 140 W	140 W + 140 W	140 W + 140 W	120 W + 120 W
SURROUND BACK	200 W + 200 W (20 HZ-20KHZ, 0.05% THD, 8 OHMS)	140 W + 140 W	140 W + 140 W	140 W + 140 W	120 W + 120 W
MAXIMUM POWER OUTPUT (1 KHZ, 1.0 % THD, 6 OHMS)	-	270 W / CH	270 W / CH	270 W / CH	200 W / CH
MISCELLANEOUS					
DIMENSIONS (W X H X D)	440 x 247 x 479 MM	420 x 200 x 459.5 MM	420 x 200 x 459.5 MM	420 x 187 x 459 MM	420 x 173 x 433 MM
WEIGHT	35.5 KG	18.5 KG	18.5 KG	17.0 KG	13.7 KG
POWER REQUIREMENTS	AC220-240V, 50/60HZ	AC220/230-240V, 50/60HZ	AC220/230-240V, 50/60 Hz	AC220/230-240 V, 50/60 Hz	AC 110 / 120-127/220/230-240 V, 50/60 Hz
POWER CONSUMPTION	550 W	330 W	330 W	460 W	410 W
POWER CONSUMPTION (STBY)	0.55 W (STBY-KURO LINK OFF)	0.5 W (STBY-KURO LINK OFF)	0.5 W (STBY-KURO LINK OFF)	0.65 W (STBY-KURO LINK OFF)	0.75 W (STBY-KURO LINK OFF)

*1 ACTION, DRAMA, SCI-FI, MONO FILM, ENTERTAINMENT SHOW, EXPANDED THEATER, TV SURROUND, ADVANCED GAME, SPORTS, CLASSICAL, ROCK/POP, UNPLUGGED, EXTENDED STEREO + PHONES SURROUND

*2 THE TERM "KURO LINK" IS EXPRESSED AS HDMI CONTROL ON PRODUCTS AND OPERATING INSTRUCTIONS.

HDMI, the HDMI logo and High-Definition Multimedia Interface are trademarks or registered trademarks of HDMI Licensing LLC. WOW HD, SRS, and the  symbol are trademarks of SRS Labs, Inc. "BD-LIVE™", "BONUSVIEW™" and the BONUSVIEW logo, and the Blu-ray Disc logo are trademarks of Blu-ray Disc Association. BD-LIVE only available on compatible discs and playable features depend on the disc contents. BONUSVIEW only available on compatible discs. "AVCHD" and the "AVCHD" logo are trademarks of Matsushita Electric Industrial Co., Ltd. and Sony Corporation. Java and all Java-based trademarks and logos are trademarks or registered trademarks of Sun Microsystems, Inc. in the U.S. and other countries. Dolby and the double-D symbol are registered trademarks of Dolby Laboratories. DTS is a registered trademark & the DTS logo and Symbol are trademarks of DTS, Inc. x.v.Colour and the "x.v.Colour" logo are trademarks of Sony Corporation. x.v.Colour only available for playback of discs recorded with AVCHD devices. TV Guide and other related marks are registered marks of Gemstar-TV Guide International, Inc and/or one of its affiliates. DivX, DivX Ultra Certified, and associated logos are trademarks of DivX, Inc. and are used under license. Fujicolor and the Fujicolor CD Logo are trademarks of FUJI FILM Corporation. THX and the THX logo are trademarks of THX Ltd. Which may be registered in some jurisdictions. All rights reserved. Windows Media and the Windows logo are trademarks, or registered trademarks of Microsoft Corporation in the United States and/or other countries. iPod is a trademark of Apple Inc, registered in the U.S. and other countries. AIR STUDIOS and the AIR STUDIOS logo are registered trademarks of Air Studios, Inc. Neural Surround is a trademark owned by Neural Audio Corporation. Sharc is a registered trademark of Analog Devices, Inc. Faroudja and DCDI are registered trademarks of Genesis Microchip Inc. DLNA and DLNA CERTIFIED are trademarks and/or service marks of Digital Living Network Alliance. ICEpower and the ICEpower logo are registered trademarks of Bang & Olufsen a/s. i.LINK and the "i.LINK" Logo are trademarks. Specifications and design subject to modification without notice. All explanatory images are simulated.

DVD PLAYER SPECIFICATIONS

		DV-LX50
PLAYBACK DISCS		DVD/VIDEO/CD/CD, DVD-AUDIO/SACD CD-R/RW, DVD-R/R DL/RW (VIDEO MODE, VR MODE W/CPRM), DVD+R/+R DL/+RW (VIDEO MODE)
TWIN-WAVE LASER PICKUP		•
LAYERED CHASSIS		DOUBLE
COMPRESSED VIDEO AND MUSIC PLAYBACK		
WMV		•
DIVX		• (ULTRA)
HD JPEG		•
MPEG4 AAC		•
WMA		•
MP3		•
PHOTO+MUSIC MIX		•
VIDEO FEATURES		
ANALOG HD OUTPUT		•
216MHZ/12-BIT D/A CONVERTER		• (COMPONENT)
108MHZ/12-BIT D/A CONVERTER		• (CVBS, S)
DUAL PURECINEMA PROGRESSIVE SCAN(PAL/NTSC)		•
I/P SIMULTANEOUS OUTPUT		•
BNR BLOCK NR		•
VIDEO ADJUST		•
AUDIO FEATURES		
192KHZ/24-BIT D/A CONVERTER		•
SACD MULTI COMPATIBILITY		•
DVD AUDIO COMPATIBILITY		•
5.1CH DTS 96/24 DECODER		•
2CH DTS DOWNMIX OUTPUT		•
5.1CH DOLBY DIGITAL DECODER		•
VIRTUAL SURROUND		•
DIGITAL OUTPUT		•
DIALOGUE		•
DYNAMIC RANGE CONTROL(DVD)		•
DIGITAL OUT ON/OFF		•
PURE AUDIO MODE		•
SACD SET-UP BUTTON		•
CONVENIENCES		
KURO LINK*		•
STARTUP NAVIGATOR		•
FL DIMMER		•
LAST MEMBRY(DVD)		DVD:5, VCD:1
RESUME FUNCTION (STOP KEY)		•
ZOOM FUNCTION		•
10-KEY DIRECT SEARCH AND PLAY (CHAPTER/TRACK)		•
SCREEN SAVER		•
AUTO POWER OFF		•
TERMINALS		
HDMI TERMINAL		1 (TO 1080P, DSD)
COMPONENT VIDEO OUTPUT		1 (GOLD PLATED)
S-VIDEO OUTPUT		1 (GOLD PLATED)
SCART (RGB)	MIDDLE EAST AND AFRICA MODELS	1
	OTHERS	-
VIDEO OUTPUT		1 (GOLD PLATED)
5.1-CHANNEL AUDIO OUTPUT		1 (GOLD PLATED)
AUDIO OUTPUT		1 (GOLD PLATED)
COAXIAL DIGITAL OUTPUT		1 (GOLD PLATED)
OPTICAL DIGITAL OUTPUT		1
SR IN		1
SPECIFICATIONS		
POWER	MIDDLE EAST AND AFRICA MODELS	220-240 V, 50/60 Hz
REQUIREMENTS	OTHERS	110-240 V, 50/60 Hz
POWER CONSUMPTION		15W
POWER CONSUMPTION DURING STANDBY MODE		0.8W
DIMENSIONS (W X H X D)		420x102x314 MM
WEIGHT		5.3 KG

*THE TERM "KURO LINK" IS EXPRESSED AS "HDMI CONTROL" ON PRODUCTS AND OPERATING INSTRUCTIONS.

HDD/DVD RECORDERS SPECIFICATIONS

		DVR-LX70 (500 GB HDD CAPACITY)	DVR-LX61 (250 GB HDD CAPACITY)		
RECORDING TIME					
HDD	RECORDING MODE: MAX. RECORDING TIME	72H (XP+) 106H (XP) - 1064H (SEP), MN: 72-1422H (34STEPS), AUTO		36H (XP+) 53H (XP) - 532H (SEP), MN: 36-711H (34STEPS), AUTO	
DVD	RECORDING MODE: MAX. RECORDING TIME	1.8H - 24H (MAX ON DVD-R DL), 1.0H - 8H (MIN ON DVD+R/RW), DEPEND ON DISC AND RECORDING MODE		1.8H - 24H (MAX ON DVD-R DL), 1.0H - 8H (MIN ON DVD+R/RW), DEPEND ON DISC AND RECORDING MODE	
	PLAYBACK MEDIA	DVD-VIDEO/DVD-R DL/DVD-R RW/DVD-RAM/DVD+R DL/DVD+R RW/CD/VCD/SUPER VCD/CD-R/RW		DVD-VIDEO/DVD-R DL/DVD-R RW/DVD-RAM/DVD+R DL/DVD+R RW/CD/VCD/SUPER VCD/CD-R/RW	
FEATURES AND SPECIFICATIONS					
HDD/DVD		HDD		DVD	
HDD FUNCTION	ONE-TOUCH COPY	• (HDD TO DVD, DVD TO HDD)	-	• (HDD TO DVD, DVD TO HDD)	
	HIGH-SPEED COPY	• (HDD TO DVD, DVD TO HDD)	-	• (HDD TO DVD, DVD TO HDD)	
	RATE CONVERSION COPY	• (HDD TO DVD, DVD TO HDD)	-	• (HDD TO DVD, DVD TO HDD)	
	OPTIMIZED COPY	• (HDD TO DVD)	-	• (HDD TO DVD)	
	DISC BACK-UP	•	-	•	
	RESUME (BY TITLE)	•	-	•	
PLAYBACK	ADVANCED DISC NAVIGATOR	•	•	• (BEFORE FINALISATION)	
	QUICK PREVIEW	•	-	•	
	SEAMLESS PLAYBACK	•	-	•	
	CM SKIP/BACK (COMMERCIAL SKIP/BACK)	•	-	•	
	SIMULTANEOUS PLAYBACK AND RECORDING/CHASE PLAY	•	-	•	
	1.5X QUICK VIEW (SCAN 1)	•	-	•	
RECORDING	PAL / NTSC	•	•	•	
	VARIABLE BIT RATE RECORDING	•	-	•	
	EASY TIMER	•	-	•	
	G-CODE SYSTEM/GUIDE PLUS+/SHOWVIEW	•	• (G-CODE SYSTEM)	• (GUIDE PLUS+/SHOWVIEW)	
	ONE TOUCH RECORDING	•	-	•	
	NUMBER OF EVENTS	32 (UP TO 1 MONTH AHEAD)	32 (UP TO 1 MONTH AHEAD)	32 (UP TO 1 MONTH AHEAD)	
EDITING	LINEAR PCM RECORDING (AUDIO)	•	• (LPCM)	• (LPCM)	
	DISC NAME / TITLE NAME INPUT	•	•	•	
	ERASE TITLE	•	-	•	
	CHAPTER EDIT	FRAME/VIDEO MODE	FRAME	TITLE	FRAME/VIDEO MODE
	ACCURACY	•	•	•	
	COPY LIST	•	•	•	
PICTURE QUALITY	PROGRESSIVE SCAN	PAL/NTSC		PAL/NTSC	
	3-D NOISE REDUCTION	•PRO		•	
	VIDEO DAC	• (108MHZ / 14BIT)		• (108MHZ / 12BIT)	
	3D Y/C SEPARATION CIRCUIT (NTSC/PAL)	•		•	
	DIGITAL TBC	•		•	
	PICTURE CREATION	•		•	
AUDIO QUALITY	AUDIO DAC 192KHZ/24BIT	• (WOLFSON HIGH QUALITY DAC)		•	
HDMI	1080P UPSCALING	•		•	
	DEEP COLOUR	•		•	
	JITTER REDUCTION CIRCUIT	•		•	
COMPRESSED VIDEO AND MUSIC	DIVX PC VIDEO	-	PLAYBACK	PLAYBACK	
	JPEG PHOTO VIEWER	FILE COPY AND PLAYBACK	PLAYBACK	PLAYBACK	
	MP3	FILE COPY AND PLAYBACK	PLAYBACK	PLAYBACK	
	WMA	FILE COPY AND PLAYBACK	PLAYBACK	PLAYBACK	
	MPEG-4 AAC	-	-	-	
CONVENIENCE	DIGITAL JUKEBOX	•	-	•	
	CREATE PHOTOMOVIE	-	-	•	
	AUTO SCAN CHANNEL PRESET	•	-	•	
	HELP FUNCTION	•	-	•	
	OSD LANGUAGES	5(EN/IT/ES/PO/CH)	5(VIA USB)	12(EN/FR/DE/ES/IT/NE/SW/RU/GR/CZ/PO/NO)	
	CONNECT PC	• (VIA USB)	• (VIA USB / ETHERNET)	• (LOCAL/VIA ETHERNET)	
ANALOGUE TUNER	BRANDNOTE AUTO TITLE	-	-	•	
	HOME MEDIA GALLERY (3 KEYS)	•	-	•	
	KURO LINK*	•	-	•	
	SYSTEM	NTSC M/N <- TF&TL MODEL, PAL(B/G, D/K, I, L/L') <- ONLY TL MODEL	NTSC M/N <- TF&TL MODEL, PAL(B/G, D/K, I, L/L') <- ONLY TL MODEL	PAL-B/G, I, D/K / SECAM-B/G, D/K, L	
	VHF/UHF/CATV	•/•/•	•/•/•	•/•/•	
TERMINALS	SCART RGB	-	-	1 IN / 1 OUT	
	AV (AUDIO/VIDEO)	3 (FRONT: 1) IN / 2 OUT	3 (FRONT: 1) IN / 2 OUT	2 (FRONT: 1) IN / 1 OUT	
	S-VIDEO	3 (FRONT: 1) IN / 2 OUT	3 (FRONT: 1) IN / 2 OUT	2 (FRONT: 1) IN / 1 OUT	
	COMPONENT VIDEO	1 OUT	1 OUT	1 OUT	
	DIGITAL AUDIO	1 COAXIAL OUT	1 COAXIAL OUT	1 COAXIAL OUT	
	HDMI	1 (TO 1080P/60 HZ) OUT	1 (TO 1080P/60 HZ) OUT	1 (TO 1080P/60 HZ) OUT	
	I. LINK (IEEE 1394) (DV TERMINAL)	1 IN	1 IN	1 IN	
	USB	2 (TYPE A FRONT/TYPE B FRONT) IN	2 (TYPE A FRONT/TYPE B FRONT) IN	2 (TYPE A FRONT/TYPE B FRONT) IN	
	ETHERNET	-	-	1 OUT	
	PIONEER SYSTEM REMOTE CONTROL	SR CONTROL IN	SR CONTROL IN	SR CONTROL IN	
	DIMENSIONS (W X H X D)	420 x 77 x 355 MM	420 x 77 x 355 MM	420 x 75 x 288 MM	
WEIGHT	6.6 KG	6.6 KG	4.5 KG		
POWER REQUIREMENTS	110-240 V, 50/60 Hz	110-240 V, 50/60 Hz	220-240 V, 50/60 Hz		
POWER CONSUMPTION	50 W	50 W	48 W		
POWER CONSUMPTION DURING STANDBY MODE	0.38 W	0.38 W	0.67 W (DISPLAY OFF)		
REMOTE CONTROL	• (WITH TV PRESET)	• (WITH TV PRESET)	• (WITH TV PRESET)		
AVAILABLE AREA	ASEAN AND NEW ZEALAND	ASEAN AND NEW ZEALAND	MIDDLE EAST AND AFRICA		

HOME THEATRE SYSTEMS SPECIFICATIONS

	HTP-LX70	HTZ-LX61
AMPLIFIER		
TOTAL POWER (RMS)	400 W	500 W
FRONT (1 kHz, 10% T.H.D.)	50 W / ch (8 OHMS)	100 W / ch (4 OHMS)
DUAL CENTRE (1 kHz, 10% T.H.D.)	100 W (50 W + 50 W) (8 OHMS)	100 W (4 OHMS)
SURROUND (1 kHz, 10% T.H.D.)	50 W / ch (8 OHMS)	50 W / ch (8 OHMS)
SUBWOOFER (100 Hz, 10% T.H.D.)	100 W (50 W + 50 W) (8 OHMS)	100 W (4 OHMS)
SOUND FIELD CALIBRATION FEATURES		
AUTO MCACC	ADVANCED	ADVANCED
EQ BAND	7-BAND	3-BAND
LICENSE/FORMAT FEATURE		
DTS-HD MASTER AUDIO	•	•
DTS-HD HIGH RESOLUTION	•	•
DTS-EXPRESS/DTS-ES	•	•
DTS 96/24/DTS Neo:6	•	•
DTS	•	•
DOLBY TRUEHD	•	•
DOLBY DIGITAL PLUS	•	•
DOLBY PRO LOGIC II	•	•
DOLBY DIGITAL	•	•
LISTENING MODES		
AUTO SURROUND	•	•
ADVANCE SURROUND MODES	•	•
FRONT STAGE SURROUND	•	•
AUDIO FEATURES		
SOUND RETRIEVER	•	ADVANCED
MID-NIGHT LISTENING MODE	•	•
LOUDNESS	•	-
tone CONTROL	•	•
SOUND DELAY (LIP-SYNC)	•	•
VIDEO FEATURES		
SACD/DVD-AUDIO COMPATIBLE	•	•
DVD-R/DL-R/VIDEO-R/R-DL/RW COMPATIBLE	•	•
SVCD/VIDEO CD/CD-R/RW COMPATIBLE	•	•
DivX/MV/JPEG FILE COMPATIBLE	•	•
MP3/MMA/MPEG-4 AAC FILE COMPATIBLE	•	•
VIDEO DAC	•	108 MHz / 12-BIT
DUAL Pure Cinema Progressive Scan (PAL/NTSC)	•	•
HDMI	•	•
DEEP COLOUR	•	•
1080P TRANSFERRING	•	•
KURO LINK *	•	•
TUNER	•	•
FM/AM TUNER	•	•
RADIO PRESET	•	•
FM/AM 3-SPEED ACCELERATED TUNING	•	•
CONVENIENCE FEATURES		
REMOTE CONTROL UNIT WITH LCD TOUCH PANEL	•	•
TOUCH SENSOR KEY BUTTON AND ILLUMINATION LED	•	•
IR SENSOR FOR AUTOMATICALLY DISPLAY ON/OFF	•	•
TERMINALS (RECEIVER SUBWOOFER)		(RECEIVER UNIT)
HDMI INPUT/OUTPUT	3/1	2/1
DIGITAL AUDIO INPUT	2 (OPTICAL)	2 (OPTICAL) / 1 (COAXIAL)
iPod® INTERFACE	1 (DEDICATED TERMINAL, AUDIO)	1 (USB, DIGITAL AUDIO)
AUDIO INPUT	1	-
3.5MM AUDIO JACK	1 (ON SEPARATE DISPLAY)	-
MONITOR OUTPUT (COMPONENT S-VIDEO/VIDEO)	-	1 / 1 / 1
SR INPUT/OUTPUT	- / 2	1 / 1
DIMENSIONS		
RECEIVER UNIT (W x H x D), WEIGHT	-	420 x 80 x 364 mm, 5.2 kg
SUBWOOFER (W x H x D), WEIGHT	245 x 409 x 600 mm, 17.8 kg	211 x 320 x 358 mm, 6.50 kg
SEPARATE DISPLAY (W x H x D), WEIGHT	168.2 x 73.4 x 87.9 mm, 0.35 kg	-
FRONT SPEAKER (W x H x D), WEIGHT	122.5 x 89.5 x 104 mm, 0.5 kg	80 x 196.8 x 82 mm, 1.02 kg
CENTRE SPEAKER (W x H x D), WEIGHT	INCLUDED IN FRONT SPEAKER	80 x 80 x 82 mm, 0.48 kg
SURROUND SPEAKER (W x H x D), WEIGHT	122.5 x 89.5 x 104 mm, 0.44 kg	80 x 115.8 x 82 mm, 0.60 kg
MISCELLANEOUS		
POWER REQUIREMENTS	110-240 V, 50/60 Hz	220-240V, 50/60Hz
POWER CONSUMPTION	69 W	60 W
POWER CONSUMPTION	0.29W (STBY+HDMI CTRL OFF)	0.4W (STBY+HDMI CTRL OFF)
DURING STANDBY MODE	0.39W (STBY+HDMI CTRL ON)	0.7W (STBY+HDMI CTRL ON)

* THE TERM "KURO LINK" IS EXPRESSED AS "HDMI CONTROL" ON PRODUCTS AND OPERATING INSTRUCTIONS.

EX SERIES SPEAKER SYSTEMS SPECIFICATIONS

		S-1 EX	S-2 EX	S-3 EX	S-4 EX	S-7 EX	S-8 EX	S-W1 EX
ENCLOSURE		3-WAY VENTED BOX SYSTEM FRONT-VENTED BASS REFLEX FLOOR-STANDING TYPE	3-WAY VENTED BOX SYSTEM FRONT-VENTED BASS REFLEX BOOKSHELF TYPE	3-WAY VENTED BOX SYSTEM FRONT-VENTED BASS REFLEX FLOOR-STANDING TYPE	3-WAY VENTED BOX SYSTEM FRONT-VENTED BASS REFLEX BOOKSHELF TYPE	3-WAY VENTED BOX SYSTEM FRONT-VENTED BASS REFLEX CENTER SPEAKER TYPE	3-WAY VENTED BOX SYSTEM FRONT-VENTED BASS REFLEX CENTER SPEAKER TYPE	POWERED SUBWOOFER PASSIVE RADIATOR FLOOR-STANDING TYPE
SPEAKERS	WOOFER	18 CM ARAMID/ CARBON COMPOSITE CONE (X2)	18 CM ARAMID/ CARBON COMPOSITE CONE	16 CM ARAMID/ CARBON COMPOSITE CONE (X2)	16 CM ARAMID/ CARBON COMPOSITE CONE	18 CM ARAMID/ CARBON COMPOSITE CONE (X2)	16 CM ARAMID/ CARBON COMPOSITE CONE (X2)	30 CM PULP CONE PASSIVE RADIATOR
	MIDRANGE	CONCENTRIC UNIT: 14 CM MAGNESIUM CONE	CONCENTRIC UNIT: 14 CM MAGNESIUM CONE	CONCENTRIC UNIT: 14 CM MAGNESIUM CONE	CONCENTRIC UNIT: 14 CM MAGNESIUM CONE	CONCENTRIC UNIT: 14 CM MAGNESIUM CONE	CONCENTRIC UNIT: 14 CM MAGNESIUM CONE	-
	TWEETER	CONCENTRIC UNIT: 3.5 CM BERYLLIUM HSDOM	CONCENTRIC UNIT: 3.5 CM BERYLLIUM HSDOM	3 CM CERAMIC GRAPHITE HSDOM	3 CM CERAMIC GRAPHITE HSDOM	3.5 CM BERYLLIUM HSDOM	3 CM CERAMIC GRAPHITE HSDOM	CONCENTRIC UNIT: CONCENTRIC UNIT:
FREQUENCY RANGE	28-100,000 HZ	34-100,000 HZ	30-100,000 HZ	34-100,000 HZ	34-100,000 HZ	34-100,000 HZ	34-100,000 HZ	20-6,000 HZ
SENSITIVITY (2.83 V/1 M)	89.5 dB SPL	86.5 dB SPL	88.5 dB SPL	85.5 dB SPL	89.5 dB SPL	88.5 dB SPL	88.5 dB SPL	-
NOMINAL IMPEDENCE	6 OHMS	6 OHMS	6 OHMS	6 OHMS	6 OHMS	6 OHMS	6 OHMS	-
MAXIMUM POWER	200 W	200 W	160 W	160 W	200 W	200 W	160 W	-
DYNAMIC POWER	-	-	-	-	-	-	-	500 W (PEAK)
OUTPUT POWER	-	-	-	-	-	-	-	250 W (4 OHMS)
CROSS-OVER FREQUENCIES	400 HZ, 2 KHZ	400 HZ, 2 KHZ	400 HZ, 2 KHZ	400 HZ, 2 KHZ	400 HZ, 2 KHZ	400 HZ, 2 KHZ	400 HZ, 2 KHZ	50-150 HZ (CONTINUOUSLY VARIABLE)
DIMENSIONS (W x H x D)	422 x 1 283 x 609 MM	291 x 565 x 425 MM	305 x 1 224 x 541 MM	263 x 490 x 387 MM	820 x 291 x 425 MM	723 x 263 x 387 MM	723 x 263 x 387 MM	430 x 480 x 430 MM
WEIGHT	66 kg	28 kg	48 kg	20 kg	39 kg	28 kg	28 kg	34.5 kg
FINISHES	CABINET: REAL WOOD VENEERS DARK TEAK WOOD (SATIN FINISH) GRILLE: BLACK CLOTH	CABINET: REAL WOOD VENEERS DARK TEAK WOOD (SATIN FINISH) GRILLE: BLACK CLOTH	CABINET: REAL WOOD VENEERS DARK TEAK WOOD (SATIN FINISH) GRILLE: BLACK CLOTH	CABINET: REAL WOOD VENEERS DARK TEAK WOOD (SATIN FINISH) GRILLE: BLACK CLOTH	CABINET: REAL WOOD VENEERS DARK TEAK WOOD (SATIN FINISH) GRILLE: BLACK CLOTH	CABINET: REAL WOOD VENEERS DARK TEAK WOOD (SATIN FINISH) GRILLE: BLACK CLOTH	CABINET: REAL WOOD VENEERS DARK TEAK WOOD (SATIN FINISH) GRILLE: BLACK CLOTH	CABINET: REAL WOOD VENEERS DARK TEAK WOOD (SATIN FINISH) GRILLE: BLACK CLOTH

SERIES 8 SPEAKER SYSTEMS SPECIFICATIONS

		S-81-K/QL	S-81B-LR-K/QL/W	S-81C-K/QL
ENCLOSURE		4-WAY VENTED BOX SYSTEM FRONT-VENTED BASS REFLEX FLOOR-STANDING TYPE	2-WAY VENTED BOX SYSTEM FRONT-VENTED BASS REFLEX BOOKSHELF TYPE	3-WAY VENTED BOX SYSTEM FRONT-VENTED BASS REFLEX CENTER SPEAKER TYPE
SPEAKERS	BASS	13 CM ARAMID/CARBON COMPOSITE CONE (X2)	CONCENTRIC DRIVER: 13 CM ARAMID/CARBON COMPOSITE CONE	13 CM ARAMID/CARBON COMPOSITE CONE (X2)
	MIDRANGE	CONCENTRIC DRIVER: 13 CM ARAMID CONE	-	CONCENTRIC DRIVER: 13 CM ARAMID CONE
	TWEETER	CONCENTRIC DRIVER: 2.5 CM TITAN DOME	CONCENTRIC DRIVER: 2.5 CM TITAN DOME	CONCENTRIC DRIVER: 2.5 CM TITAN DOME
	SUPER TWEETER	RIFTEL-TYPE	-	-
FREQUENCY RANGE	30-100,000 HZ	40-50,000 HZ	40-50,000 HZ	
SENSITIVITY (2.83 V/1 M)	85.5 dB SPL	84.5 dB SPL	85.5 dB SPL	
NOMINAL IMPEDENCE	6 OHMS	6 OHMS	6 OHMS	
MAXIMUM POWER	130 W	130 W	130 W	
DIMENSIONS (W x H x D)	267 x 1 190 x 280 MM	190 x 350 x 280 MM	560 x 212 x 295 MM (WITH BASE) 560 x 190 x 280 MM (WITHOUT BASE)	
WEIGHT	25.8 kg	7.9 kg	14.5 kg	
FINISHES	K: HIGH-GLOSS BLACK QL: REAL WHITEWASHED ASH VENEER	K: HIGH-GLOSS BLACK QL: REAL WHITEWASHED ASH VENEER W: REAL WALNUT VENEER	K: HIGH-GLOSS BLACK QL: REAL WHITEWASHED ASH VENEER	

LX70 SERIES SPEAKER SYSTEMS SPECIFICATIONS

		S-LX70-LR	S-LX70C	S-LX70W
ENCLOSURE		2-WAY VENTED BOX SYSTEM FRONT-VENTED BASS REFLEX FLOOR-STANDING TYPE	2-WAY VENTED BOX SYSTEM FRONT-VENTED BASS REFLEX BOOKSHELF TYPE	POWERED SUBWOOFER PASSIVE RADIATOR FLOOR-STANDING TYPE
SPEAKERS	WOOFER	13 CM CONE (X2)	13 CM CONE (X2)	30 CM CONE
	TWEETER	2.5 CM DOME	2.5 CM DOME	-
FREQUENCY RANGE	40-50,000 HZ	40-50,000 HZ	25-4,000 HZ	
SENSITIVITY (2.83 V/1 M)	82 dB SPL	82 dB SPL	-	
NOMINAL IMPEDENCE	6 OHMS	6 OHMS	6 OHMS	
MAXIMUM POWER	130 W	130 W	-	
DYNAMIC POWER	-	-	500 W (PEAK)	
OUTPUT POWER	-	-	300W (4 OHMS)	
CROSS-OVER FREQUENCIES	1.7 KHZ	1.7 KHZ	50, 60, 70, 80, 100, 120, 160, 200 HZ	
DIMENSIONS (W x H x D)	175 x 722 x 70 MM	722 x 175 x 70 MM	362 x 365 x 362 MM	
WEIGHT	5.2 kg	5.2 kg	18.2 kg	
FINISHES	CABINET: BLACK SATIN FINISH, GRILLE: BLACK CLOTH	CABINET: BLACK SATIN FINISH, GRILLE: BLACK CLOTH	CABINET: BLACK SATIN FINISH, GRILLE: BLACK CLOTH	

SPEAKER STANDS SPECIFICATIONS

	CP-2EX (FOR S-2EX)	CP-4EX (FOR S-4EX)	CP-7EX (FOR S-7EX/S-8EX)	CP-81B-K (FOR S-81B-LR)	CP-LX70 (FLOORSTANDS FOR S-LX70-LR)	CP-LX70TS (TABLESTANDS FOR S-LX70-LR)
DIMENSIONS (W x H x D)	400 x 604 x 513 MM	360 x 570 x 486 MM	498 x 310 x 412 MM	310 x 604 x 404 MM	271 x 1 067 x 271 MM	225 x 686 x 225 MM
WEIGHT	17.8 kg	14.1 kg	14.0 kg	6.5 kg	8.9 kg	5.9 kg
HIGHT WHEN ATTACHED	1 169 MM	1 066 MM	601 / 573 MM	954 MM	1 158 - 1 328 MM	778 - 948 MM
UNIT	PAIR	SINGLE	SINGLE	PAIR	PAIR	PAIR

PIONEER CORPORATION
4-1, MEGURO 1-CHOME, MEGURO-KU,
TOKYO 153-8654, JAPAN
WWW.PIONEER.JP

PIONEER ELECTRONICS ASIACENTRE PTE. LTD.
(CO. REG. NO.): 199203130M)
253 ALEXANDRA ROAD, #04-01 LOBBY 2,
SINGAPORE 159936
SERVICE HOTLINE: (65)-6472-7555
WWW.PIONEER.COM.SG

PIONEER TECHNOLOGY (MALAYSIA) SDN. BHD.
16TH FLOOR, MENARA UNI, ASIA 1008
JALAN SULTAN ISMAIL 50250 KUALA LUMPUR, MALAYSIA
PLASMA PRIORITY SERVICE HOTLINE: 1-300-882-859
SERVICE HOTLINE: (60)-3-2697-2920
WWW.PIONEERMALAYSIA.COM.MY

PIONEER (HK) LIMITED
SUITES 901-906, 9/F, WORLD COMMERCE CENTRE, HARBOUR CITY,
11 CANTON ROAD, TSIM SHA TSUI, KOWLOON, HONG KONG
TEL.: (852)-2848-6488 FAX: (852)-2530-4896
WWW.PIONEERHONGKONG.COM.HK

MONACO CORPORATION
10 ROTHWELL AVENUE, ALBANY,
AUCKLAND, NEW ZEALAND
WWW.PIONEERNZ.CO.NZ

PIONEER GULF FZE
LOB 11-017, JEBEL ALI FREE ZONE,
P.O. BOX 61226 JEBEL ALI, DUBAI, U.A.E.
TEL.: (971)-4-8815756 FAX: (971)-4-8816414
WWW.PIONEER-UAE.COM

Pioneer

Free Manuals Download Website

<http://myh66.com>

<http://usermanuals.us>

<http://www.somanuals.com>

<http://www.4manuals.cc>

<http://www.manual-lib.com>

<http://www.404manual.com>

<http://www.luxmanual.com>

<http://aubethermostatmanual.com>

Golf course search by state

<http://golfingnear.com>

Email search by domain

<http://emailbydomain.com>

Auto manuals search

<http://auto.somanuals.com>

TV manuals search

<http://tv.somanuals.com>