

Pioneer *sound.vision.soul*

**PLASMA DISPLAY SYSTEM
SYSTEME D'ÉCRAN PLASMA
SISTEMA DE PANTALLA DE PLASMA**

PDP-5030HD

PDP-4330HD

Operating Instructions
Mode d'emploi
Manual de instrucciones

IMPORTANT



The lightning flash with arrowhead symbol, within an equilateral triangle, is intended to alert the user to the presence of uninsulated "dangerous voltage" within the product's enclosure that may be of sufficient magnitude to constitute a risk of electric shock to persons.

CAUTION
RISK OF ELECTRIC SHOCK
DO NOT OPEN



The exclamation point within an equilateral triangle is intended to alert the user to the presence of important operating and maintenance (servicing) instructions in the literature accompanying the appliance.

IMPORTANT SAFETY INSTRUCTIONS

READ INSTRUCTIONS — All the safety and operating instructions should be read before the product is operated.

RETAIN INSTRUCTIONS — The safety and operating instructions should be retained for future reference.

HEED WARNINGS — All warnings on the product and in the operating instructions should be adhered to.

FOLLOW INSTRUCTIONS — All operating and use instructions should be followed.

CLEANING — Unplug this product from the wall outlet before cleaning. The product should be cleaned only with a polishing cloth or a soft dry cloth. Never clean with furniture wax, benzine, insecticides or other volatile liquids since they may corrode the cabinet.

ATTACHMENTS — Do not use attachments not recommended by the product manufacturer as they may cause hazards.

WATER AND MOISTURE — Do not use this product near water — for example, near a bathtub, wash bowl, kitchen sink, or laundry tub; in a wet basement; or near a swimming pool; and the like.

ACCESSORIES — Do not place this product on an unstable cart, stand, tripod, bracket, or table. The product may fall, causing serious injury to a child or adult, and serious damage to the product. Use only with a cart, stand, tripod, bracket, or table recommended by the manufacturer, or sold with the product. Any mounting of the product should follow the manufacturer's instructions, and should use a mounting accessory recommended by the manufacturer.

CART — A product and cart combination should be moved with care. Quick stops, excessive force, and uneven surfaces may cause the product and cart combination to overturn.



VENTILATION — Slots and openings in the cabinet are provided for ventilation and to ensure reliable operation of the product and to protect it from overheating, and these openings must not be blocked or covered. The openings should never be blocked by placing the product on a bed, sofa, rug, or other similar surface. This product should not be placed in a built-in installation such as a bookcase or rack unless proper ventilation is provided or the manufacturer's instructions have been adhered to.

POWER SOURCES — This product should be operated only from the type of power source indicated on the marking label. If you are not sure of the type of power supply to your home, consult your product dealer or local power company.

LOCATION — The appliance should be installed in a stable location.

NONUSE PERIODS — The power cord of the appliance should be unplugged from the outlet when left unused for a long period of time.

GROUNDING OR POLARIZATION

- If this product is equipped with a polarized alternating current line plug (a plug having one blade wider than the other), it will fit into the outlet only one way. This is a safety feature. If you are unable to insert the plug fully into the outlet, try reversing the plug. If the plug should still fail to fit, contact your electrician to replace your obsolete outlet. Do not defeat the safety purpose of the polarized plug.

- If this product is equipped with a three-wire grounding type plug, a plug having a third (grounding) pin, it will only fit into a grounding type power outlet. This is a safety feature. If you are unable to insert the plug into the outlet, contact your electrician to replace your obsolete outlet. Do not defeat the safety purpose of the grounding type plug.

POWER-CORD PROTECTION — Power-supply cords should be routed so that they are not likely to be walked on or pinched by items placed upon or against them, paying particular attention to cords at plugs, convenience receptacles, and the point where they exit from the product.

OUTDOOR ANTENNA GROUNDING — If an outside antenna or cable system is connected to the product, be sure the antenna or cable system is grounded so as to provide some protection against voltage surges and built-up static charges. Article 810 of the National Electrical Code, ANSI/NFPA 70, provides information with regard to proper grounding of the mast and supporting structure, grounding of the lead-in wire to an antenna discharge unit, size of grounding conductors, location of antenna-discharge unit, connection to grounding electrodes, and requirements for the grounding electrode. See Figure A.

LIGHTNING — For added protection for this product during a lightning storm, or when it is left unattended and unused for long periods of time, unplug it from the wall outlet and disconnect the antenna or cable system. This will prevent damage to the product due to lightning and power-line surges.

POWER LINES — An outside antenna system should not be located in the vicinity of overhead power lines or other electric light or power circuits, or where it can fall into such power lines or circuits. When installing an outside antenna system, extreme care should be taken to keep from touching such power lines or circuits as contact with them might be fatal.

OVERLOADING — Do not overload wall outlets, extension cords, or integral convenience receptacles as this can result in a risk of fire or electric shock.

OBJECT AND LIQUID ENTRY — Never push objects of any kind into this product through openings as they may touch dangerous voltage points or short-out parts that could result in a fire or electric shock. Never spill liquid of any kind on the product.

SERVICING — Do not attempt to service this product yourself as opening or removing covers may expose you to dangerous voltage or other hazards. Refer all servicing to qualified service personnel.

DAMAGE REQUIRING SERVICE — Unplug this product from the wall outlet and refer servicing to qualified service personnel under the following conditions:

- When the power-supply cord or plug is damaged.
- If liquid has been spilled, or objects have fallen into the product.
- If the product has been exposed to rain or water.
- If the product does not operate normally by following the operating instructions. Adjust only those controls that are covered by the operating instructions as an improper adjustment of other controls may result in damage and will often require extensive work by a qualified technician to restore the product to its normal operation.
- If the product has been dropped or damaged in any way.
- When the product exhibits a distinct change in performance — this indicates a need for service.

REPLACEMENT PARTS — When replacement parts are required, be sure the service technician has used replacement parts specified by the manufacturer or have the same characteristics as the original part. Unauthorized substitutions may result in fire, electric shock, or other hazards.

SAFETY CHECK — Upon completion of any service or repairs to this product, ask the service technician to perform safety checks to determine that the product is in proper operating condition.

WALL OR CEILING MOUNTING — The product should not be mounted to a wall or ceiling.

HEAT — The product should be situated away from heat sources such as radiators, heat registers, stoves, or other products (including amplifiers) that produce heat.

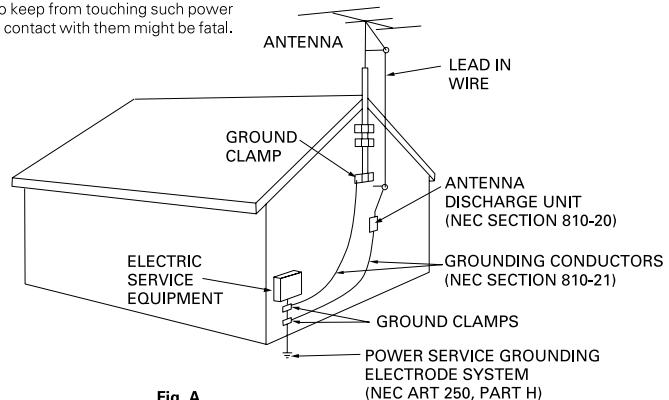

Fig. A

NEC — NATIONAL ELECTRICAL CODE

Note to CATV system installer.

This reminder is provided to call the CATV system installer's attention to Article 820-40 of the NEC that provides guidelines for proper grounding and, in particular, specifies that the cable ground shall be connected to the grounding system of the building, as close to the point of cable entry as practical.

WARNING: THE APPARATUS IS NOT WATERPROOFS, TO PREVENT FIRE OR SHOCK HAZARD, DO NOT EXPOSE THIS APPLIANCE TO RAIN OR MOISTURE AND DO NOT PUT ANY WATER SOURCE NEAR THIS APPARATUS, SUCH AS VASE, FLOWER POT, COSMETICS CONTAINER AND MEDICINE BOTTLE ETC.

NOTE: This equipment has been tested and found to comply with the limits for a class B digital device, pursuant to Part 15 of the FCC Rules. These limits are designed to provide reasonable protection against harmful interference in a residential installation. This equipment generates, uses, and can radiate radio frequency energy and, if not installed and used in accordance with the instructions, may cause harmful interference to radio communications. However, there is no guarantee that interference will not occur in a particular installation. If this equipment does cause harmful interference to radio or television reception, which can be determined by turning the equipment off and on, the user is encouraged to try to correct the interference by one or more of the following measures:

- Reorient or relocate the receiving antenna.
- Increase the separation between the equipment and receiver.
- Connect the equipment into an outlet on a circuit different from that to which the receiver is connected.
- Consult the dealer or an experienced radio/TV technician for help.

Information to User

Alteration or modifications carried out without appropriate authorization may invalidate the user's right to operate the equipment.

[For Canadian model]

This Class B digital apparatus complies with Canadian ICES-003.

CAUTION:

This product satisfies FCC regulations when shielded cables and connectors are used to connect the unit to other equipment. To prevent electromagnetic interference with electric appliances such as radios and televisions, use shielded cables and connectors for connections.

FEDERAL COMMUNICATIONS COMMISSION DECLARATION OF CONFORMITY

This device complies with part 15 of the FCC Rules. Operation is subject to the following two conditions: (1) This device may not cause harmful interference, and (2) this device must accept any interference received, including interference that may cause undesired operation.

Product Name: Plasma Display System
(Plasma Display)
(Media Receiver)

Model Number: PDP-5030HD / PDP-4330HD
(PDP-503PU) / (PDP-433PU)
(PDP-R03U) / (PDP-R03U)

Product Category: Class B Personal Computers & Peripherals

Responsible Party Name: PIONEER ELECTRONICS (USA), INC., Customer Support Div.

Address: P.O. BOX 1760, LONG BEACH, CA., 90801-1760 U.S.A.

Phone: (800) 421-1625

For Business Customer URL <http://www.PioneerUSA.com>

IMPORTANT NOTICE: The serial number for this equipment is located on the rear panel. Please write this serial number on your enclosed warranty card and keep it in a secure area. This is for your security.

Dear customer

Thank you for your purchase of the PIONEER product. To ensure safety and many years of trouble-free operation of your product, please read the IMPORTANT SAFETY INSTRUCTIONS carefully before using this product.

Contents

Dear customer	1	Using external equipment	34
Contents	1	Watching a DVD image	35
Important User Guidance Information	2	Connecting a DVD player	35
Features	3	Displaying a DVD image	35
Supplied accessories	4	Watching a VCR image	36
Plasma Display	4	Connecting a VCR	36
Media Receiver	4	Displaying a VCR image	36
Preparation	5	Watching broadcasts via a Digital tuner	37
Installing the Plasma Display	5	Connecting a Digital tuner	37
Setting the system	6	Displaying broadcasts via a Digital tuner	37
How to route cables	7	Enjoying a game console or viewing camcorder images	38
Using the remote control unit	8	Connecting a game console or camcorder	38
Cautions regarding remote control unit	8	Displaying an image of the game console or camcorder images	38
Inserting the batteries	8	Viewing an image from a computer	39
Cautions regarding batteries	8	Connecting a computer	39
Part names	9	Displaying an image from a computer	39
Plasma Display	9	Control cord connection	40
Media Receiver	10	Useful adjustment settings	41
Remote control unit	11	Image position (AV mode only)	41
Watching TV	12	Auto Sync. adjustment (PC mode only)	42
Basic connection	12	Fine Sync. adjustment (PC mode only)	42
Turning on the power	14	Input signal source	43
Turning off the power	14	AV SELECTION	44
Initial auto installation	15	Wide Mode	45
Simple button operations for changing channels	16	Audio out	46
Simple button operations for changing volume/sound	17	Sleep timer	46
Using FRONT SURR(SURROUND) on the remote control unit	18	Closed caption	47
Setting MTS/SAP stereo mode	19	Parental control (setting V-CHIP level)	48
Basic adjustment settings	20	Secret number setting for parental control (AV mode only)	52
AV mode menu items	20	How to temporarily release the V-CHIP BLOCK	54
PC mode menu items	21	Reactivating the temporarily released V-CHIP BLOCK	54
Moving the picture on the screen	22	Useful features	55
Auto installation	23	Multiscreen functions	55
Channel setup	24	Learning remote control function	56
Language setting	26	Using the TV remote control unit to control other device	58
Picture adjustments	27	Appendix	64
Color temperature	28	Troubleshooting	64
Black	28	Computer compatibility chart	65
3D-Y/C	29	Specifications	66
Black & White	29		
PureCinema	30		
Sound adjustment	31		
Power control	32		
Power control for AV source	32		
Power control for PC source	33		

Important User Guidance Information

In order to obtain maximum enjoyment from this Pioneer PureVision PDP-5030HD/PDP-4330HD Plasma Display System, please first read this information carefully.

With the Pioneer PureVision PDP-5030HD/PDP-4330HD, you can be assured of a high quality Plasma Display System with long-life and high reliability. To achieve images of exceptional quality, this Pioneer Plasma Display System incorporates state-of-the-art design and construction, as well as very precise and highly advanced technology. On a total of nearly 3 million light cells, more than 99.999 percent of the cells remain active.

Over the course of its lifetime, the luminosity of the Pioneer PDP-5030HD/PDP-4330HD Plasma Display System will diminish very slowly, such as with all phosphor-based screens (for example, a traditional tube-type television). To enjoy beautiful and bright images on your Pioneer Plasma Display System for many years to come, please carefully read and follow the usage guidelines below.

Usage guidelines

All phosphor-based screens (including conventional tube-type televisions) can be affected by displaying static images for a prolonged period. Plasma Display Systems are no exception to this rule. After-image and permanent effects on the screen can be avoided by taking some basic precautions. By following the recommendations listed below, you can ensure longer and satisfactory results from your plasma:

- Whenever possible, avoid frequently displaying the same image or virtually still moving pictures (e.g. closed-captioned images or video game images which have static portions).
- Avoid viewing the On Screen Display for extended periods, from a Digital tuner, DVD player, VCR and all other components.
- Do not leave the same picture freeze-framed or paused continuously over a long period of time, when using the still picture mode from a TV, VCR, DVD player or any other component.
- Images which have both very bright areas and very dark areas side by side should not be displayed for a prolonged period of time.
- When playing a game, the "GAME" mode setting within "AV SELECTION" is strongly recommended. However, please limit its use to less than 2 hours at a time.
- After playing a game, or displaying a PC image or any still image, it is best to view a normal moving picture in the "WIDE" or "FULL" screen setting for over 3 times longer than the previous still/moving image.
- After using the Plasma Display System, always switch the display to "STAND BY" mode.

Installation guidelines

The Pioneer PureVision PDP-5030HD/PDP-4330HD Plasma Display System incorporates a very thin design. To ensure safety, please take the proper measures to mount or install the Plasma Display, in order to prevent the unit from tipping over in the event of vibration or accidental movement.

This product should be installed by using only parts and accessories designed by PIONEER. Use of accessories other than the PIONEER stand or installation bracket may result in instability, and could cause injury. For custom installation, please consult the dealer where the unit was purchased. To ensure correct installation, experienced and qualified experts must install the unit. PIONEER will not be held responsible for accident or damage caused by the use of parts and accessories manufactured by other companies.

To avoid malfunction and overheating when installing, make sure that the vents on the main unit are not blocked. To ensure proper heat emission:

- Distance the unit slightly from other equipment, walls, etc. more than 10 cm(3 ¹⁵/₁₆ inch)
- Do not fit the unit inside narrow spaces where ventilation is poor.
- Do not cover with a cloth, etc.
- Clean the vents on the sides and rear of the unit to remove dust build-up by using a vacuum cleaner set to its lowest suction setting.

Using the unit without proper ventilation may cause the internal temperature to rise, and could result in possible malfunction. When the surrounding or internal temperature exceeds a certain degree, the display will automatically power off in order to cool the internal electronics and prevent a hazardous occurrence.

Malfunction can be caused by many factors: inappropriate installation site, improper assembly/installation/mounting, improper operation of or modifications made to this product. However, PIONEER cannot be held responsible for accidents or malfunction caused by the above.

NOTE

Typical effects and characteristics of a phosphor-based matrix display such as permanent residual images upon the phosphors of the panel and the existence of a minute number of inactive light cells in the screen are not covered by local warranties.

About the Plasma Panel's protection function

The brightness of this display will deteriorate slightly when an image with little movement such as a photograph or computer image is continuously displayed. This is caused by the Plasma Panel's protection function which detects images with slight movement and automatically adjusts brightness to protect the display, and is not a malfunction.

This function begins operating when the display detects no or little screen movement for a period of about three minutes.

CAUTION

Panel sticking and after-image lag

- Displaying the same images such as still images for a long time may cause after-image lagging. This may occur in the following two cases.

1. After-image lagging due to remaining electrical load

When image patterns with very high peak luminance are displayed for more than 1 minute, after-image lagging may occur due to the remaining electric load. The after-images remaining on the screen will disappear when moving images are displayed. The time for the after-images to disappear depends on the luminance of the still images and the time they had been displayed.

2. After-image (lag image) due to burning

Avoid displaying the same image on the Plasma Display continuously over a long period of time. If the same image is displayed continuously for several hours, or for shorter periods of time over several days, a permanent after-image may remain on the screen due to burning of the fluorescent materials. Such images may become less noticeable if moving images are later displayed, but they will not disappear completely.

- The Energy save function can be set to help prevent damage from screen burning (See page 32-33).

Features

- **New WIDE XGA Plasma Panel**
(H:1280 × V:768 pixels, PDP-5030HD)
(H:1024 × V:768 pixels, PDP-4330HD)
- **Wide Viewing Angle**
- **SRS and FOCUS Sound System*1**
- **Dual TV Tuner**
- **Picture and Picture, Still Image Function**
- **3-Language On Screen Display**
- **4 Video Input and PC (XGA) Input**
- **Component Video Input and RGB Video Input**
- **Parental Control System (V-CHIP)**
- **Power-Saving Design**

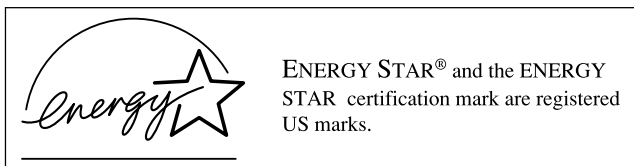

Supplied accessories

Plasma Display

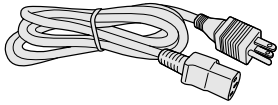

Power cord

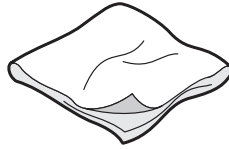

Cleaning cloth

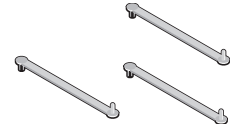

Three speed clamps

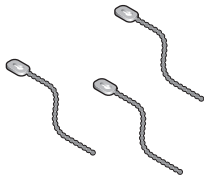

Three bead bands

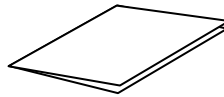

Warranty card

NOTE

- Always use the power cord supplied with the Plasma Display and the one supplied with the Media Receiver for each respective unit.

Media Receiver

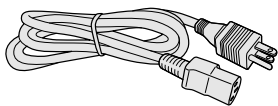

Power cord

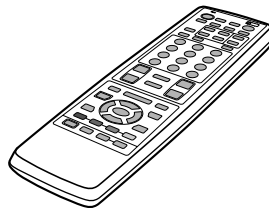

Remote control unit

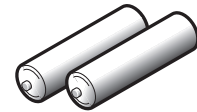

Two AA size batteries
(Alkaline battery)

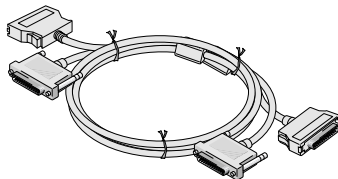

System cable

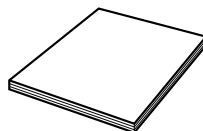

Operating instruction

Preparation

Installing the Plasma Display

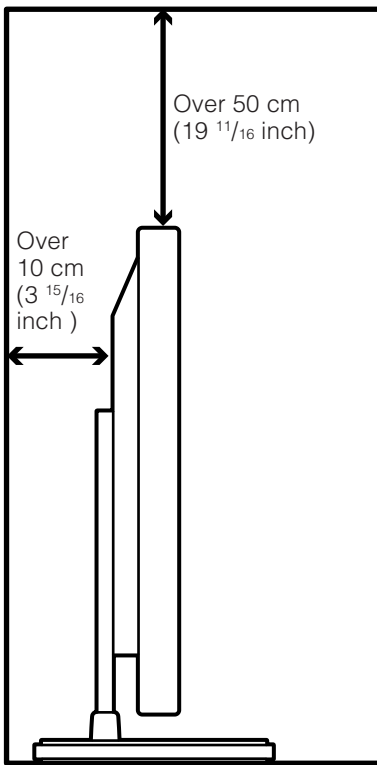

Locating

- Avoid the direct sunlight. Keep enough ventilation.
- The length of the system cable used to connect the Plasma Display and the Media Receiver is about 3 m (118 inch).
- Because the Plasma Display is heavy, be sure to move it by more than two persons.

CAUTION

- If you place anything on top of the Media Receiver it will not receive enough ventilation and not operate properly.

NOTE

- Keep enough space around the upper and back parts when installing in order to ensure ventilation around the backside.

Using the optional PIONEER stand

- For details on installation refer to the instruction manual provided with the stand.

CAUTION

- This product may be used only with model PDK-TS01 stand, use with other stands may result in instability causing possible injury.

Using the optional PIONEER speakers

- For details on installation refer to the instruction manual provided with the speaker.

CAUTION

Operating Environment

Operating environment temperature and humidity: +0°C to +40°C (+32F to +104F); less than 20% to 80% RH (cooling vents not blocked)

Avoid installing in the following locations:

- Under direct exposure to sunlight,
- Under strong artificial light,
- In high humidity,
- Poorly ventilated.

Preparation

Setting the system

1. Connecting the system cable and the power cord to the Plasma Display

Plasma Display (rear view)

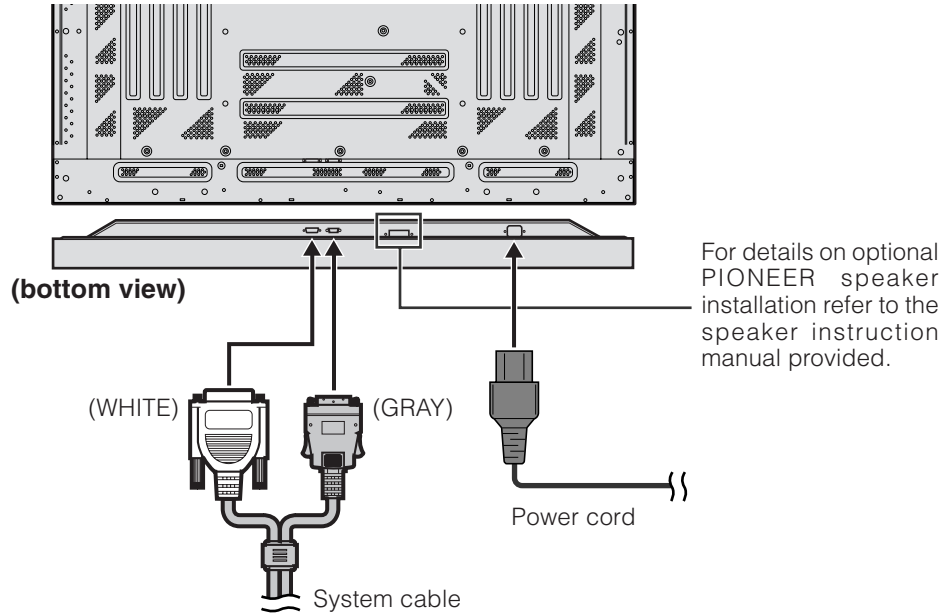

CAUTION

- THESE SPEAKER TERMINALS CAN BE UNDER HAZARDOUS VOLTAGE WHEN YOU CONNECT OR DISCONNECT THE SPEAKER CABLES. TO PREVENT THE RISK OF ELECTRIC SHOCK, DO NOT TOUCH UNINSULATED PARTS BEFORE DISCONNECTING THE POWER CORD.

2. Connecting the system cable and the power cord to the Media Receiver

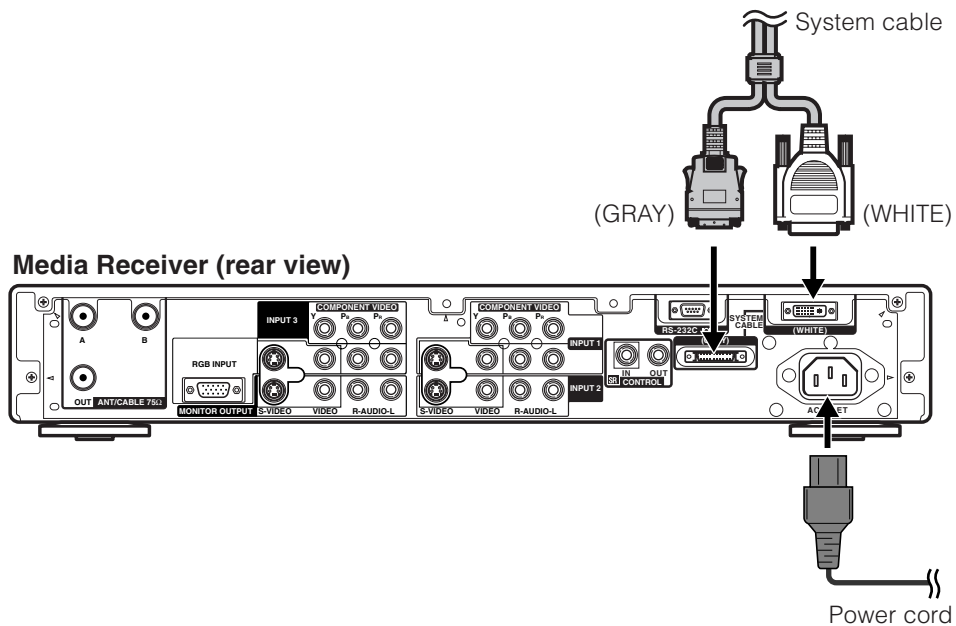

Preparation

How to route cables

Speed clamps and bead bands are included with this System for bunching cables. Once properly bunched, follow the steps below to route the cables.

To the left

As viewed from the rear of the display.

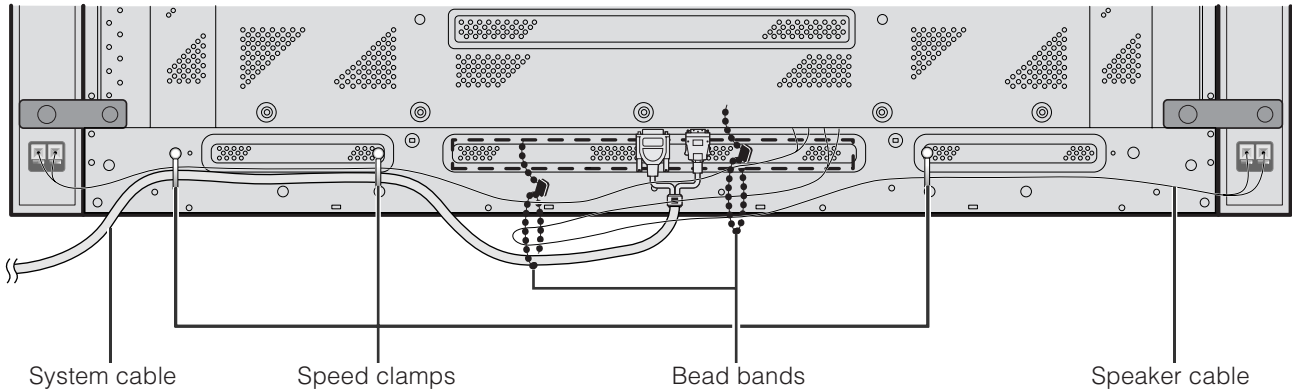

To the right

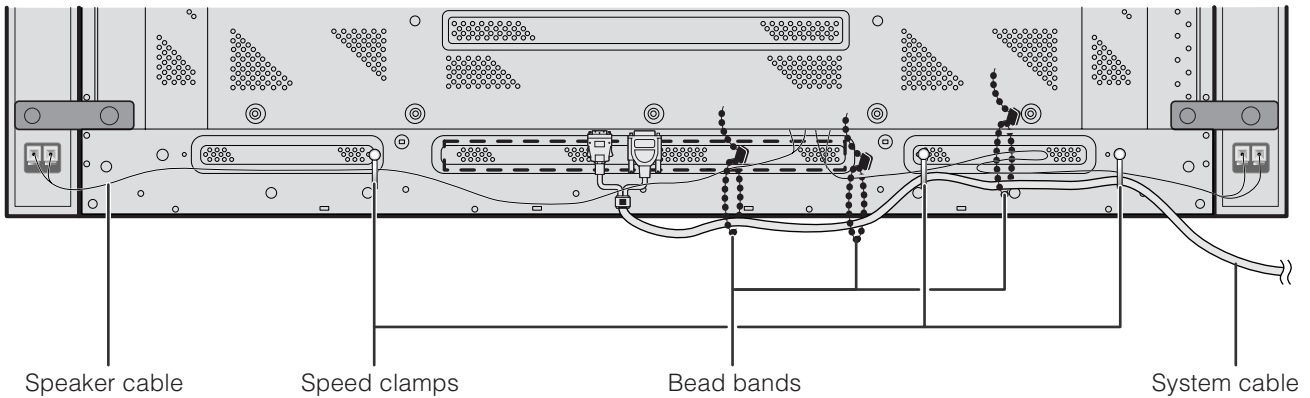

Bunch cables using provided speed clamps

Attaching speed clamps to the main unit

Connect the speed clamps using the 4 holes marked with • below, depending on your routing system.

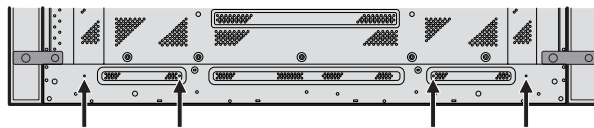

Attaching and removing speed clamps

Insert ① into an appropriate hole on the rear of the Plasma Display and snap ② into the back of ① to fix the clamp.

Speed clamps are designed to be difficult to undo once in place. Please attach carefully.

Use pliers to twist the clamp 90°, pulling outward. The clamp may deteriorate over time and become damaged if removed.



Gather cables into a bunch, secure with provided bead bands

NOTE

- Cables can be routed to the right or left.

Preparation

Using the remote control unit

Use the remote control unit by pointing it towards the remote sensor window. Objects between the remote control unit and sensor window may prevent proper operation.

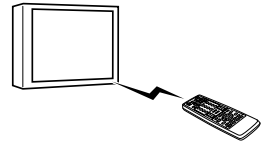

Cautions regarding remote control unit

- Do not expose the remote control unit to shock. In addition, do not expose the remote control unit to liquids, and do not place in an area with high humidity.
- Do not install or place the remote control unit under direct sunlight. The heat may cause deformation of the unit.
- The remote control unit may not work properly if the remote sensor window of the Plasma Display is under direct sunlight or strong lighting. In such case, change the angle of the lighting or Plasma Display set, or operate the remote control unit closer to the remote sensor window.

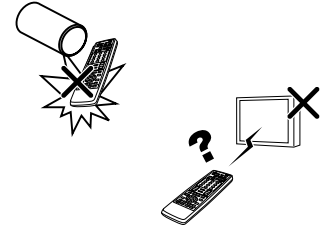

Inserting the batteries

If the remote control unit fails to operate Plasma Display System functions, replace the batteries in the remote control unit.

1 Open the battery cover.

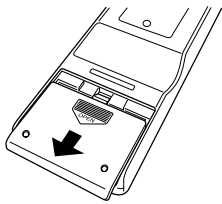

2 Insert batteries (two AA size batteries supplied with product). **3** Close the battery cover.

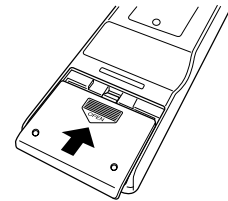
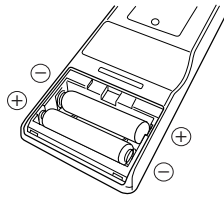

- Place batteries with their terminals corresponding to the (+) and (-) indicators in the battery compartment.

Cautions regarding batteries

Improper use of batteries can result in chemical leakage or explosion. Be sure to follow the instructions below.

- Do not use manganese batteries. When you replace the batteries, use alkaline ones.
- Place the batteries with their terminals corresponding to the (+) and (-) indicators.
- Do not mix batteries of different types. Different types of batteries have different characteristics.
- Do not mix old and new batteries. Mixing old and new batteries can shorten the life of new batteries or cause chemical leakage in old batteries.
- Remove batteries as soon as they have worn out. Chemicals that leak from batteries can cause a rash. If you find any chemical leakage, wipe thoroughly with a cloth.
- The batteries supplied with this product may have a shorter life expectancy due to storage conditions.
- If you do not plan to use the remote control unit for an extended period of time, remove the batteries from it.

CAUTION

- **WHEN DISPOSING OF USED BATTERIES, BE SURE TO COMPLY WITH GOVERNMENT REGULATIONS AND ENVIRONMENTAL PROTECTION GUIDELINES THAT APPLY IN YOUR COUNTRY OR AREA.**

Part names

Plasma Display

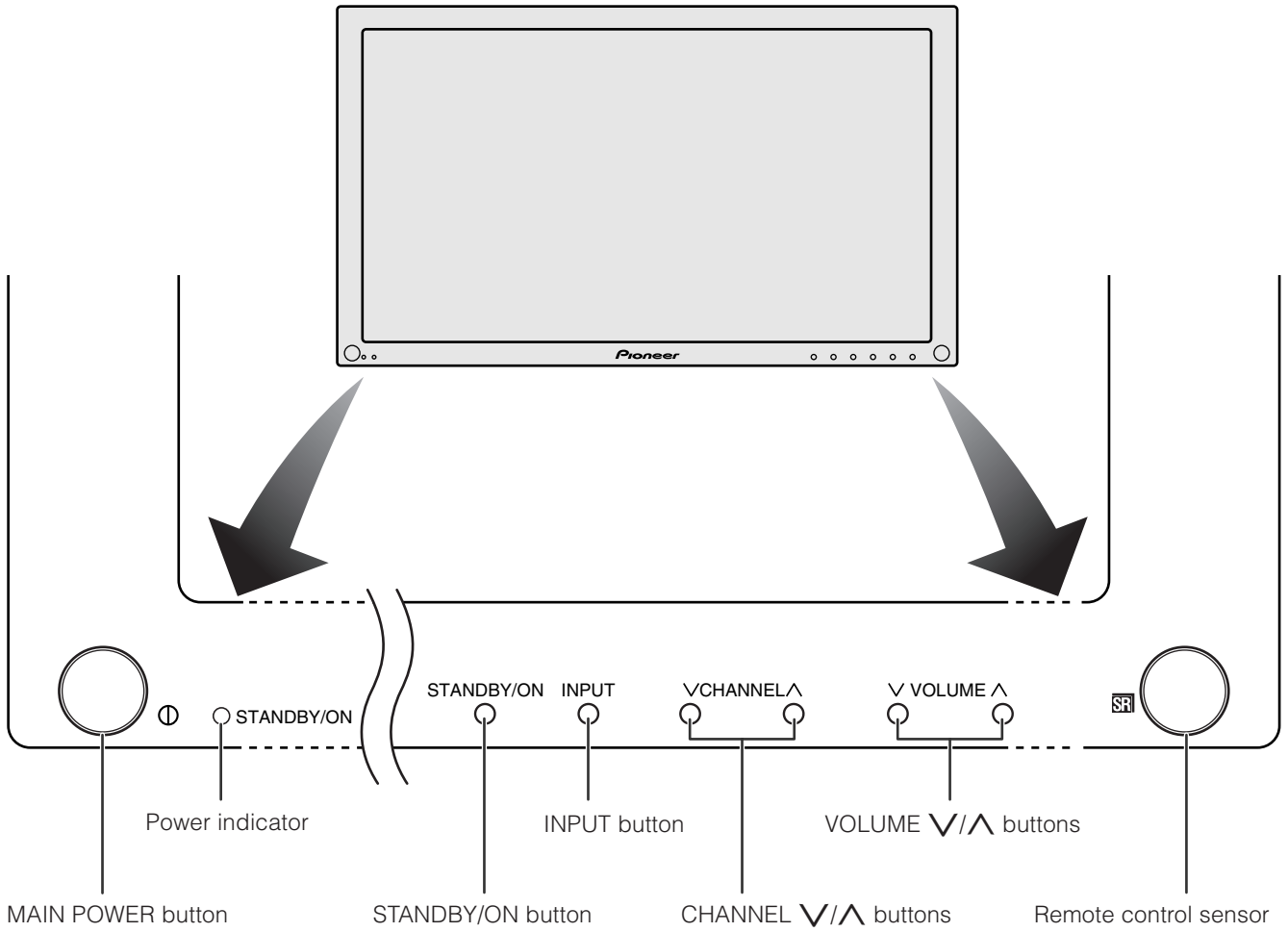

Part names

Remote control unit

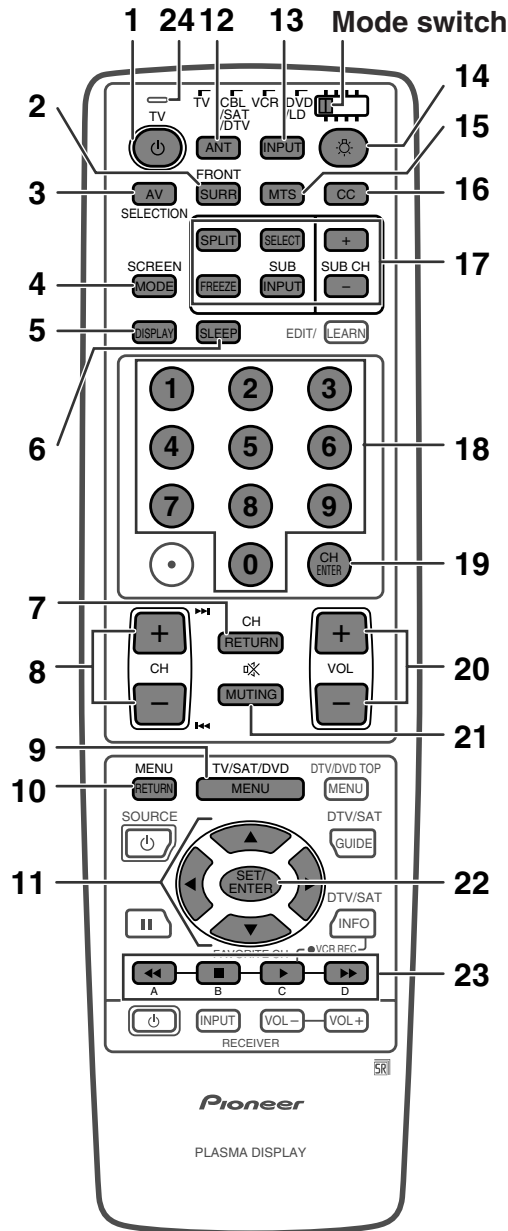

Set the mode switch to TV.

- 1 **TV** : Switch the Plasma Display power on or off.
- 2 **FRONT SURR**: Set SRS and FOCUS Sound System.
- 3 **AV SELECTION**: Select an audio or video setting.
(AV mode: STANDARD, DYNAMIC, MOVIE, GAME, USER.)
(PC mode: STANDARD, USER.)
- 4 **SCREEN MODE**: Select the screen size.
- 5 **DISPLAY**: Display the channel information.
- 6 **SLEEP**: Set the SLEEP timer.
- 7 **CH RETURN**: Return to the previous channel.
- 8 **CH +/-**: Select the channel.
- 9 **MENU**: Display the menu screen.
- 10 **MENU RETURN**: Return to the previous menu screen.
- 11 **▲/▼/◀/▶**: Select a desired item on the setting screen.
- 12 **ANT**: Select the antenna. (A, B) (See page 12 for details)
- 13 **INPUT**: Select an input source of the Plasma Display.
(TV, INPUT 1, INPUT 2, INPUT 3, INPUT 4, PC)
- 14 : When pressed all buttons on the remote control unit will light. The lighting will turn off if no operations are performed within about 5 seconds. This button is used for performing operations in dark places.
- 15 **MTS**: Select the MTS/SAP.
- 16 **CC**: Display captions during closed-caption source.
- 17 **Dual picture mode select buttons**
SPLIT: Set the dual picture mode. Press again to return to normal screen.
FREEZE: Set the still image. Press again to return to normal screen.
SELECT: Select the active screen.
SUB INPUT: Select an input source of sub screen.
SUB CH +/-: Select the channel of sub screen.
- 18 **0 - 9**: Set the channel.
- 19 **CH ENTER**: Execute a channel number.
- 20 **VOL +/-**: Set the volume.
- 21 **MUTING**: Mute the sound.
- 22 **SET/ENTER**: Execute a command.
- 23 **FAVORITE CH**
A, B, C, D: Select any of four preset channels. (See page 25 for details to set the FAVORITE CH.) While watching you can toggle the set channels by pressing A, B, C and D.
- 24 **LED for transmission confirmation**

NOTE

- When using the remote control unit, point it at the Plasma Display.
- See pages 56 to 63 for operating buttons not listed on this page.

Watching TV

Simple operations for watching a TV program

Basic connection

To enjoy a clearer picture, use an outdoor antenna. The following is a brief explanation of the types of connections that are used for a coaxial cable. If your outdoor antenna uses a 75-ohm coaxial cable with an F-type connector, plug it into the antenna terminal at the rear of the Media Receiver.

NOTE

- The Antenna and CABLE Converter cannot be connected at the same time.

Connecting VHF/UHF antenna

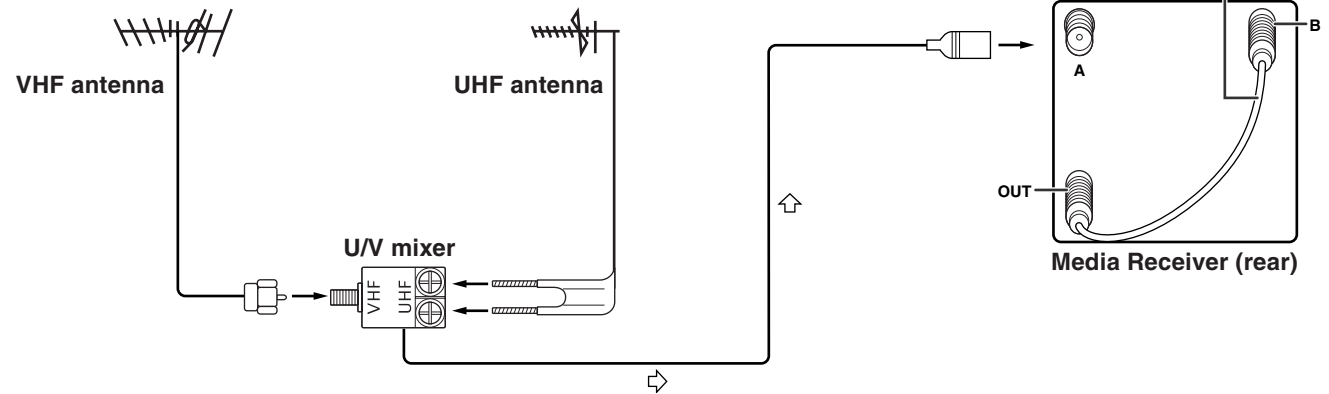

Connecting the CABLE Converter

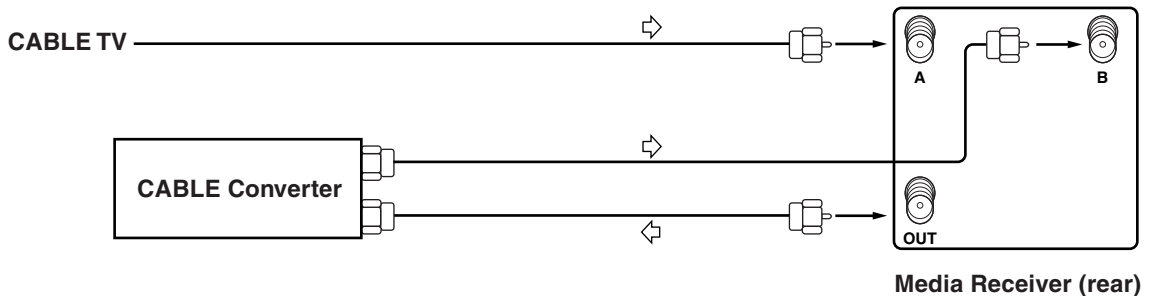

NOTE

- Be sure connect the Antenna or the CABLE Converter as explained above. Signal reception may fail if not properly connected.
- Be sure that the CABLE Converter output signal is assigned to the ANT-B input on the Media Receiver.
- How to change channels when the CABLE Converter output signal is connected to the ANT-B input on the Media Receiver.
 - Press **ANT** on the remote control unit to switch to ANT-B.
 - You can view an image right after selecting the output channel on the CABLE Converter.

Switching between Tuner A and Tuner B

To watch broadcasts via the two tuners, you can select it by pressing **ANT** on the remote control unit.

- While watching a broadcast press ANT to view the image received from the other tuner.
- Pressing ANT while viewing in Dual Screen mode (TV image and video image) with TV selected will display the TV image of the other tuner.
- Pressing ANT while viewing Dual Screen with video selected will not change the image displayed.
- Pressing ANT while viewing Dual Screen with two TV images displayed will not have any effect.
- Pressing ANT while viewing Dual Screen with two video images displayed will switch the selected screen to a TV image.

Watching TV

Connecting the power cord

Connect the power cord after all component connections have been completed.

Plasma Display (bottom view)

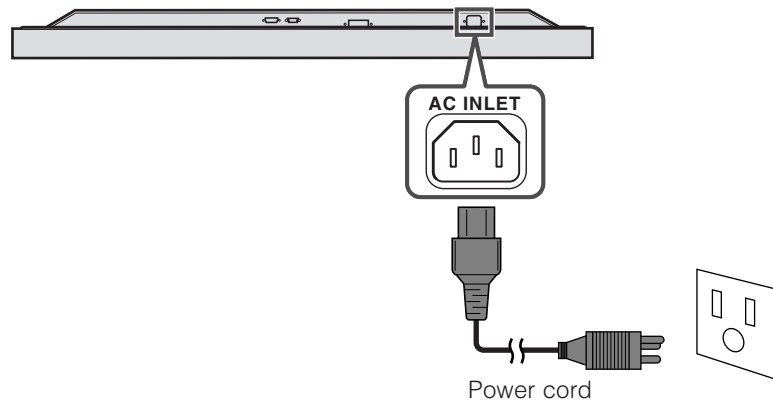

Media Receiver (rear view)

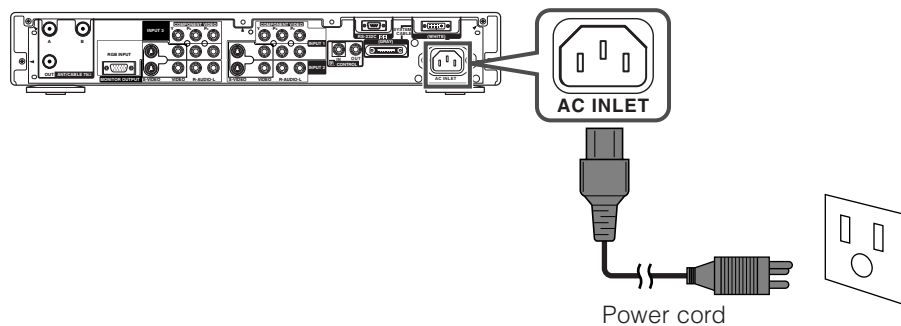

CAUTION

- Use only the power cord provided.
- Do not use a power supply voltage other than that indicated (AC 120 V, 60 Hz) as this may cause fire or electric shock.
- For the Plasma Display System, a three-core power cord with a ground terminal is used for efficiency protection. Always be sure to connect the power cord to a three-pronged outlet and make sure that the cord is properly grounded. If you use a power source converter plug, use an outlet with a ground terminal and screw down the ground line.

NOTE

- Always turn off the main power of Plasma Display and Media Receiver when connecting the power cords.
- Disconnect the power cord from the power outlet when the Plasma Display System is not going to be used for a long period of time.

Watching TV

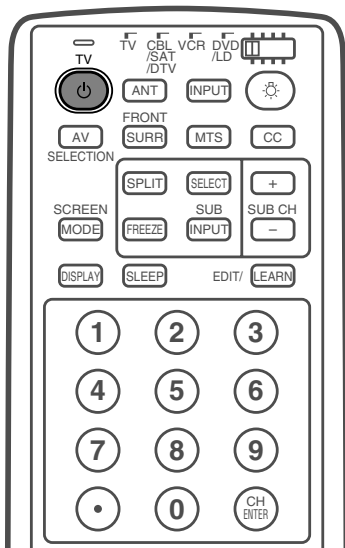
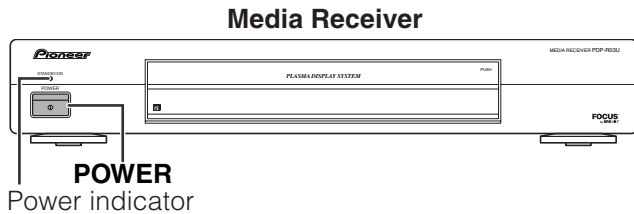
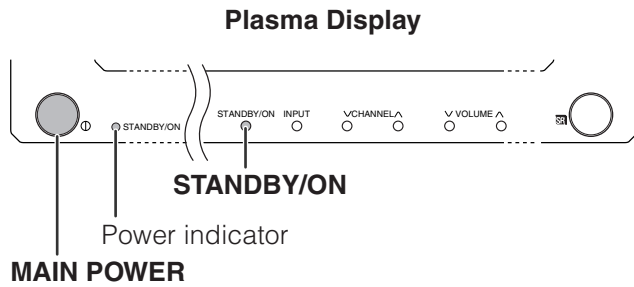

Turning on the power

- 1 Press **MAIN POWER** on the Plasma Display.
 - The power indicator on the Plasma Display flashes red.
- 2 Press **POWER** on the Media Receiver.
 - The System turns the power on.
 - The power indicators on the Plasma Display and Media Receiver lights up green.
 - If the power indicators still light up red, press **TV** on the remote control unit or **STANDBY/ON** on the Plasma Display to turn the System on.

First time turning on Media Receiver

- 1 Press **POWER** on the Media Receiver.
 - The power indicator on the Media Receiver lights up red.
- 2 Press **MAIN POWER** on the Plasma Display.
 - The System turns the power on.
 - The power indicators on the Plasma Display and Media Receiver lights up green.
 - If the power indicators still light up red, press **TV** on the remote control unit or **STANDBY/ON** on the Plasma Display to turn the System on.

NOTE

- In this manual, "System" mean the Plasma Display Panel and Media Receiver.

Turning off the power

- 1 Press **TV** on the remote control unit or **STANDBY/ON** on the Plasma Display.
 - The System enters standby mode and the image on the screen disappears.
 - Both power indicators change from green to red.
- 2 Press **POWER** on the Media Receiver.
 - The power indicator on the Media Receiver turns off and the one on the Plasma Display flashes red.
- 3 Press **MAIN POWER** on the Plasma Display.
 - The power indicator on the Plasma Display turns off after approximately 5 seconds.

NOTE

- If you are not going to use this System for a long time, be sure to remove the Power cord from the power outlet.

Plasma Display status indicators

Off	Power off
Flashing red	Media Receiver does not turn on or its power cord is disconnected.
Red	The Plasma Display System is in standby mode.
Green	The Plasma Display System turns the power on.

Media Receiver status indicators

Off	Power off
Red	Only the Media Receiver is in standby mode or the Plasma Display System is in standby mode.
Green	The Plasma Display System turns the power on.

Watching TV

Initial auto installation

When you turn on the Plasma Display System for the first time, it will automatically memorize the broadcasting channels where you live. Perform the following steps before you press **TV** .

1. Insert the batteries into the remote control unit. (See page 8.)
2. Connect the antenna cable to the Media Receiver. (See page 12.)
3. Plug in the power cord to the wall outlet. (See page 13.)

Language menu

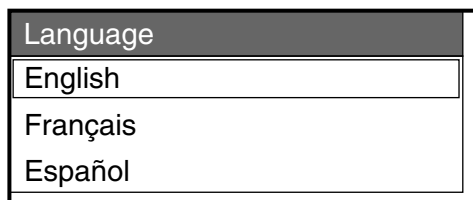

Antenna menu

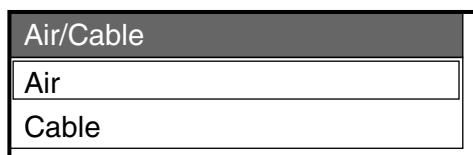

Searching TV channels

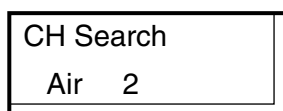

1. Setting a language

- ① Press **▲/▼** to select the desired language listed on the screen.
- ② Press **SET/ENTER** to enter the setting.

2. Setting the antenna mode

- ① Press **▲/▼** to select “Air” or “Cable” on the screen.
- ② Press **SET/ENTER** to enter the setting.

3. Automatic channel searching

Channel auto search makes the Plasma Display System look for all channels viewable in the set area.

NOTE

- If no channel is found, “No program found. Is antenna connected properly?” displays. And the auto channel search finishes.
- If you want to try auto installation again, see page 23.
- Channel search function is available for ANT-A only.
- ANT-B cannot perform channel search.
- You may need to manually add the CABLE Converter output channel setting (fixed), when connecting the CABLE Converter output signal to the B terminal (ANT/CABLE 75Ω) on the Media Receiver (Rear).(See page 25.)

Watching TV

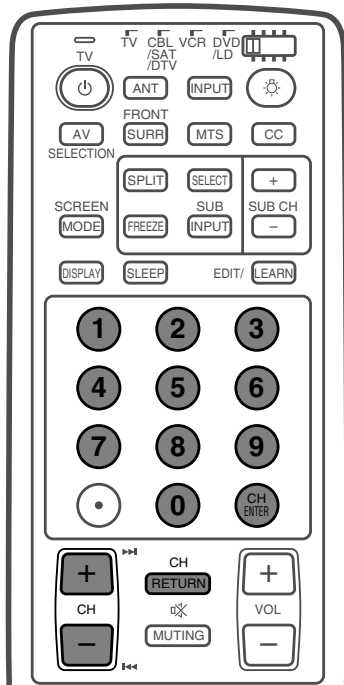
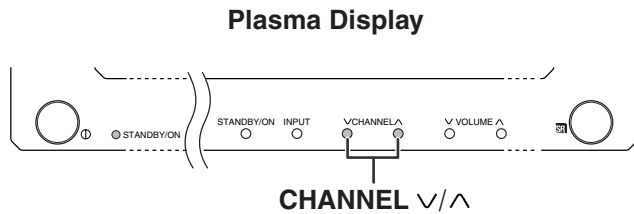

Channel display

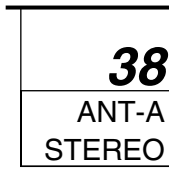

Simple button operations for changing channels

Using CH +/- on the remote control unit

- Press **CH +** to increase channel number.
- Press **CH -** to decrease channel number.

NOTE

- **CHANNEL v/∧** on the Plasma Display operates the same as **CH -/+**.

Using CH RETURN on the remote control unit

Press **CH RETURN** to switch the currently tuned channel to the previously tuned channel.

Press **CH RETURN** again to switch back to the currently tuned channel.

Using 0 – 9 on the remote control unit

Select the channels directly by pressing buttons **0** to **9**.

EXAMPLE

- To select channel 8, a 1-digit channel, press **8**.
- To select channel 38, a 2-digit channel, press **3**, followed by **8**.
- To select channel 138, a 3-digit channel, press **1**, then **3**, followed by **8**.
- You can tune in channels more quickly if you press **CH ENTER** after pressing **0** to **9**.

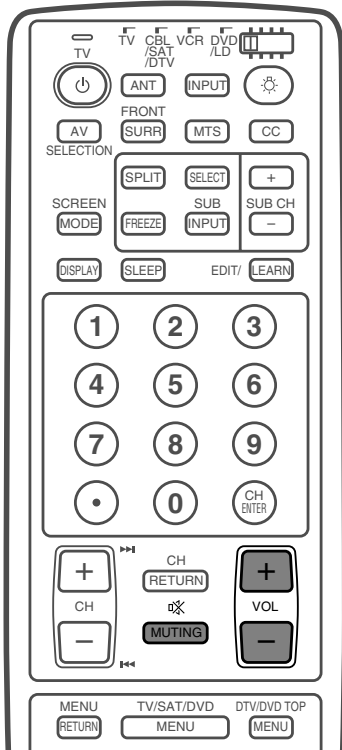
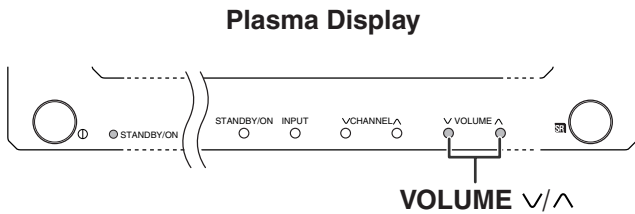

Simple button operations for changing volume/sound

Using VOL +/- on the remote control unit

- To increase the volume, press **VOL +**.
- To decrease the volume, press **VOL -**.

NOTE

- **VOLUME v/∧** on the Plasma Display operates the same as **VOL -/+**.

Audio status

Output device	Audio out	
	Fixed	Variable
Speaker	Variable sound	Mute
MONITOR OUT	Constant as specified	Variable sound

- * When "Audio Out" is set to "Variable", the indicator on the screen changes as shown below.

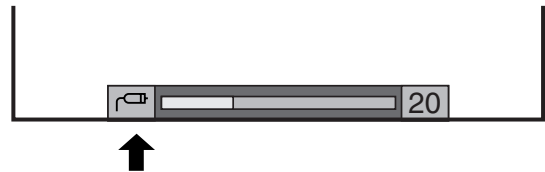

NOTE

- See page 46 for details on the audio out function.

Volume adjustment

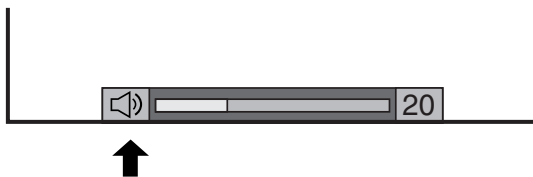

Mute



Using MUTING on the remote control unit

MUTING mutes the current sound output.

1 Press MUTING.

- "M" displays on the screen for 8 minutes, muting the sound.
- When mute mode finishes, the volume level is set to 0, preventing the system from suddenly outputting a loud sound.

2 Press MUTING again to cancel the mute.

- Pressing **VOL +/-** and **MTS** (TV mode only) can also cancel the mute.

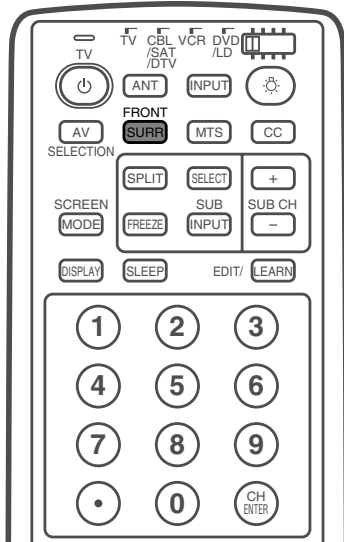

Using FRONT SURR (SURROUND) on the remote control unit

(●) produces SRS and FOCUS effect from the speakers. Each time you press **FRONT SURR (SURROUND)**, the mode changes among SRS, FOCUS, FOCUS + SRS and Off.

SRS sound options

- SRS (Sound Retrieval System): Creates a more natural sound, retrieving the spatial information from any stereo recording and restoring the original three-dimensional sound field.
- FOCUS: Repositions a sound image from two speakers to a more optimal listening position or height without moving them.
- FOCUS + SRS: Produces both SRS and FOCUS effects.
- Off: Outputs the normal sound.

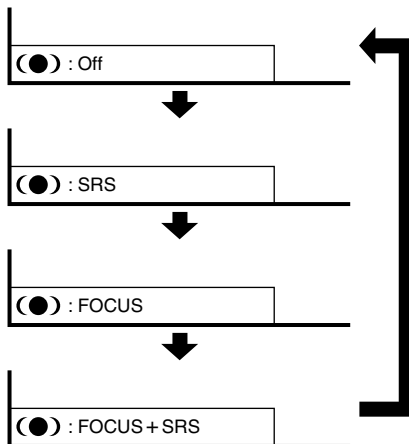

Watching TV

Setting MTS/SAP stereo mode

The Plasma Display System has a feature that allows reception of sound other than the main audio for the program. This feature is called Multi-channel Television Sound (MTS). The Plasma Display System with MTS can receive mono sound, stereo sound and Secondary Audio Programs (SAP). The SAP feature allows a TV station to broadcast other information, which could be audio in another language or something completely different like weather information.

You can enjoy Hi-Fi stereo sound or SAP broadcasts where available.

- **Stereo broadcasts**

View programs like live sporting events, shows and concerts in dynamic stereo sound.

- **SAP broadcasts**

Receive TV broadcasts in either MAIN or SAP sound.

MAIN sound: The normal program soundtrack (either in mono or stereo).

SAP sound: Listen to second language, supplementary commentary and other information. (SAP is mono sound.)

If stereo sound is difficult to hear.

- Obtain a clearer sound by manually switching to fixed mono-sound mode.

NOTE

- Once "MONO" mode is selected, the Plasma Display System sound remains mono even if the System receives a stereo broadcast. You must switch the mode back to "STEREO" if you want to hear stereo sound again.
- Selecting MTS while in the input mode does not change the type of sound. In this case, sound is determined by the video source.

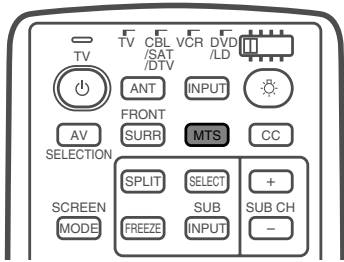

Each time you press **MTS**, MTS toggles as shown below.

STEREO mode

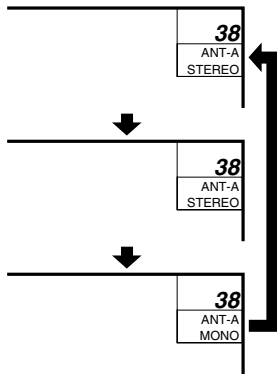

MAIN + SAP mode

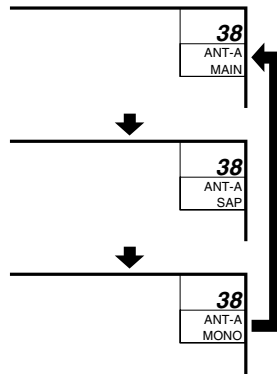

STEREO + SAP mode

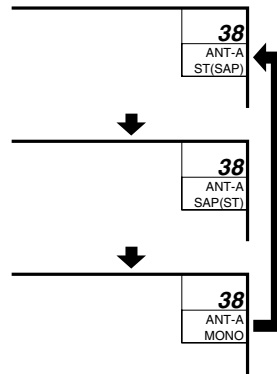

MONO mode

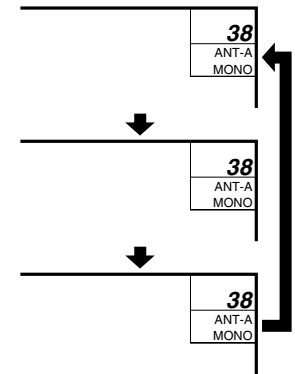

Basic adjustment settings

AV mode menu items

List of AV menu items to help you with operations.

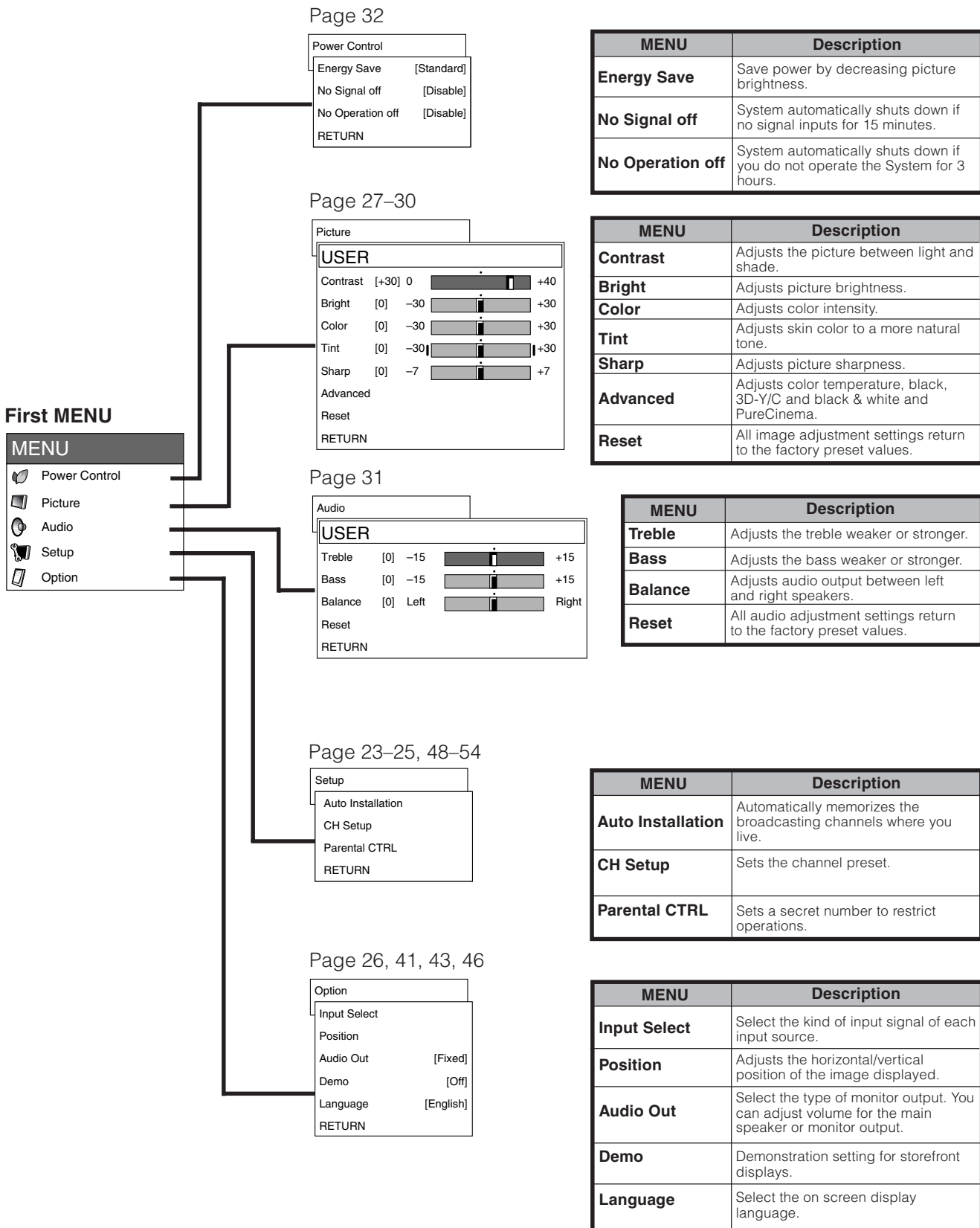

MENU	Description
Energy Save	Save power by decreasing picture brightness.
No Signal off	System automatically shuts down if no signal inputs for 15 minutes.
No Operation off	System automatically shuts down if you do not operate the System for 3 hours.

MENU	Description
Contrast	Adjusts the picture between light and shade.
Bright	Adjusts picture brightness.
Color	Adjusts color intensity.
Tint	Adjusts skin color to a more natural tone.
Sharp	Adjusts picture sharpness.
Advanced	Adjusts color temperature, black, 3D-Y/C and black & white and PureCinema.
Reset	All image adjustment settings return to the factory preset values.

MENU	Description
Treble	Adjusts the treble weaker or stronger.
Bass	Adjusts the bass weaker or stronger.
Balance	Adjusts audio output between left and right speakers.
Reset	All audio adjustment settings return to the factory preset values.

MENU	Description
Auto Installation	Automatically memorizes the broadcasting channels where you live.
CH Setup	Sets the channel preset.
Parental CTRL	Sets a secret number to restrict operations.

MENU	Description
Input Select	Select the kind of input signal of each input source.
Position	Adjusts the horizontal/vertical position of the image displayed.
Audio Out	Select the type of monitor output. You can adjust volume for the main speaker or monitor output.
Demo	Demonstration setting for storefront displays.
Language	Select the on screen display language.

Basic adjustment settings

PC mode menu items

List of PC menu items to help you with operations.

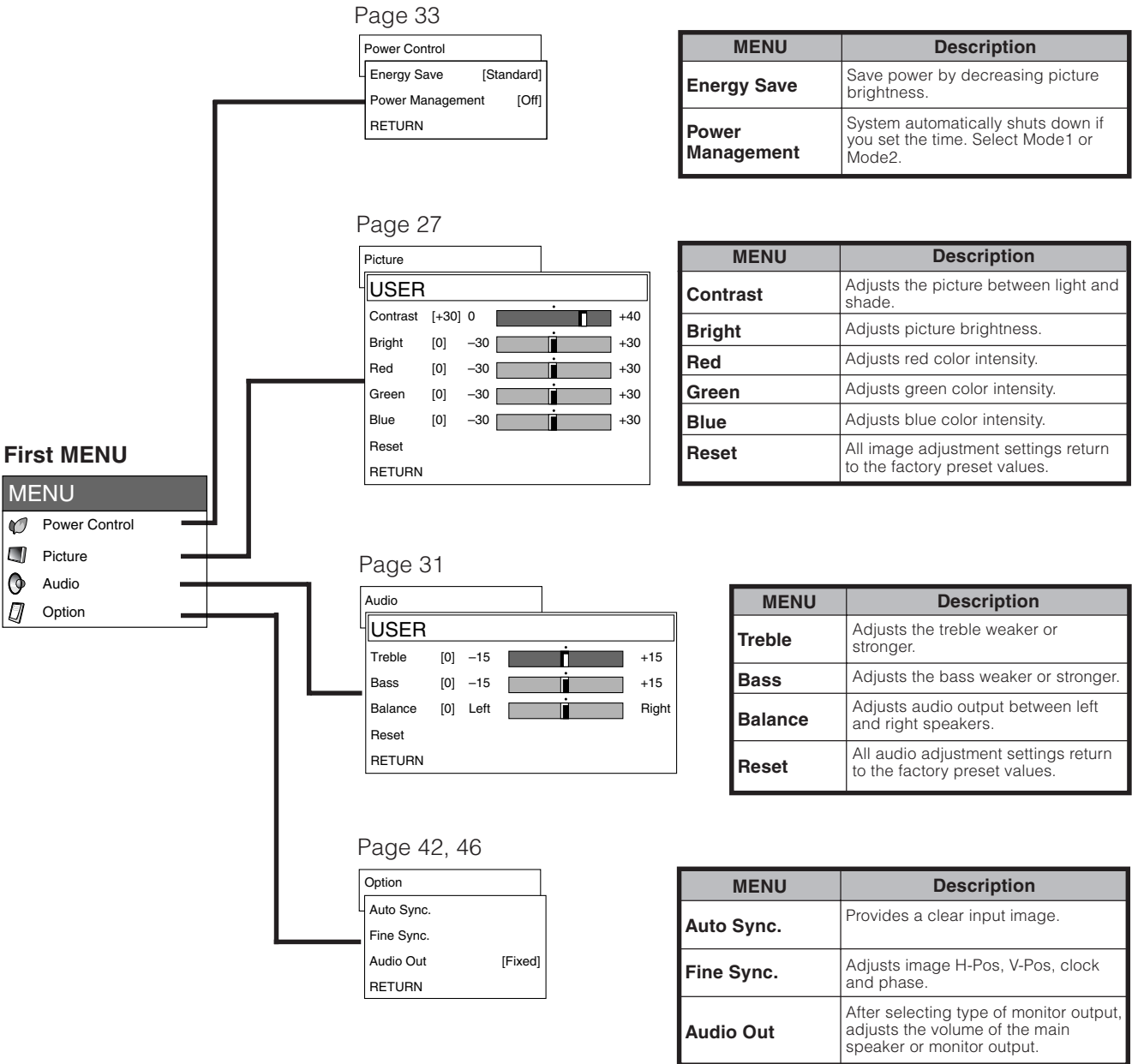

Basic adjustment settings

Moving the picture on the screen

You can move the picture around on the screen.

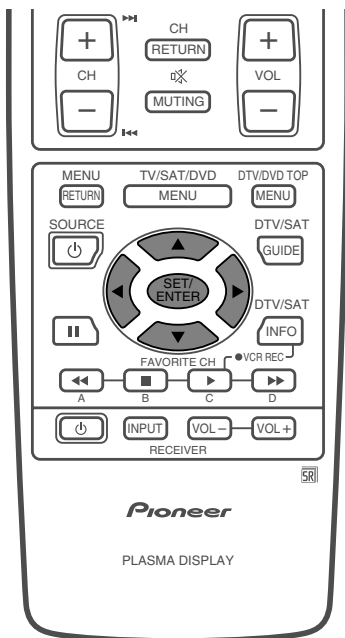

Press **▲/▼/◀/▶** to move an image on the screen to the desired position.

NOTE

- While pressing **▲/▼/◀/▶**, an on-screen image, "Adjusting Position" displays to the desired position.
- This setting cannot be stored. Once the System shuts down or enters standby mode, the setting is erased. To move the picture around the screen again, you must perform the above procedure again.
- An on-screen image from a PC source cannot be moved around.
- Initialize the image position by pressing **SET/ENTER**.

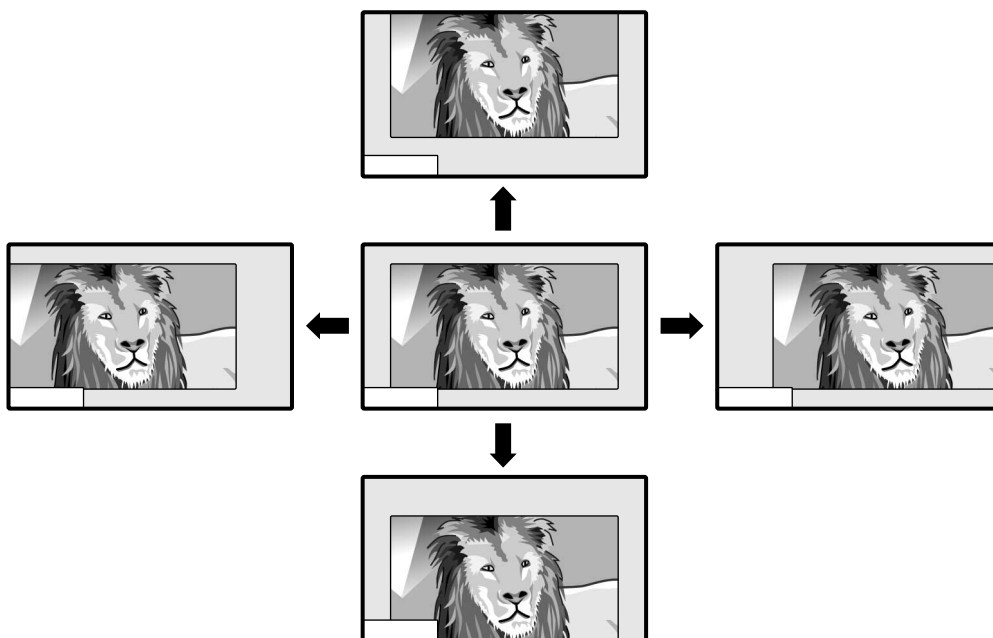

Basic adjustment settings

Auto installation

You can run auto installation again, even after setting up the preset channels.

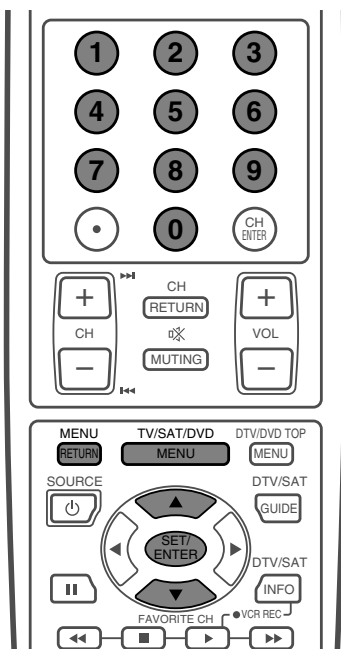

Secret number setting menu

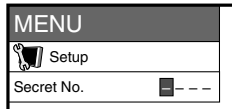

Setup menu

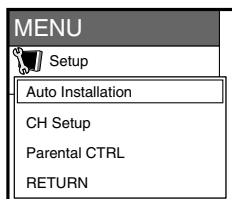

Language setting

Select from among 3 languages: English, French and Spanish.

- 1 Press **MENU**.
- 2 Press **▲/▼** to select "Setup", and then press **SET/ENTER**.
 - Secret number setting menu displays only when "Secret No." is set. (See page 52.)
 - Setup menu displays when the "Secret No." is not set. Skip step 3.
- 3 Enter your 4-digit secret number with **0–9** to cancel the "Secret No." when you set it.
- 4 Press **▲/▼** to select "Auto Installation", and then press **SET/ENTER**.
 - Language menu displays.
- 5 Press **▲/▼** to select the desired language listed on the screen, and then press **SET/ENTER**.
 - Antenna menu displays.

NOTE

- Return to the previous menu by pressing **MENU RETURN**.

Language menu

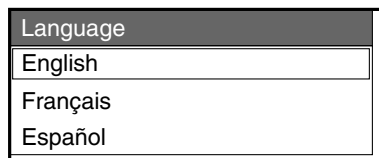

Antenna menu

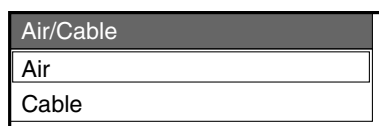

Antenna setting

After setting the language, perform settings for the Antenna connected.

Press **▲/▼** to select the desired item, and then press **SET/ENTER**.

- After setting the Antenna, channel search starts.

NOTE

- Return to the previous menu by pressing **MENU RETURN**.

Searching TV channels

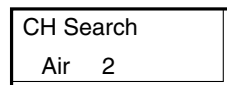

Channel search

After performing language and Antenna settings, the Plasma Display System's channel auto search automatically looks for all viewable channels in the set area.

Basic adjustment settings

Channel setup

If initial auto installation does not memorize all the channels in your region, follow the instructions below to manually memorize the channels.

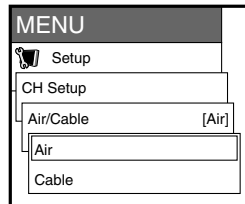
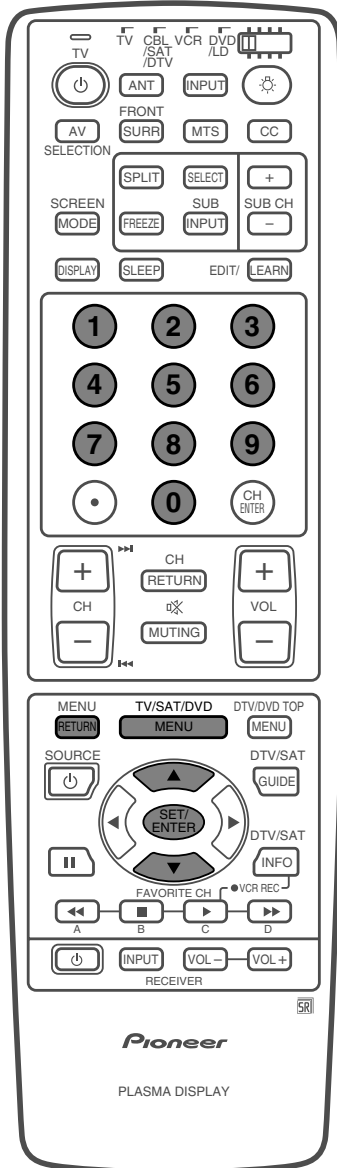

Setting the Air/Cable

- 1 Press **MENU**.
- 2 Press **▲/▼** to select "Setup", and then press **SET/ENTER**.
 - Secret number setting menu displays only when "Secret No." is set. (See page 52.)
 - Setup menu displays when the "Secret No." is not set. Skip step 3.
- 3 Enter your 4-digit secret number with **0–9** to cancel the "Secret No." when you set it.
- 4 Press **▲/▼** to select "CH Setup", and then press **SET/ENTER**.
- 5 Press **▲/▼** to select "Air/Cable", and then press **SET/ENTER**.
- 6 Press **▲/▼** to select the desired item, and then press **SET/ENTER**.
- 7 Press **MENU** to exit the menu.

NOTE

- Return to the previous menu by pressing **MENU RETURN**.

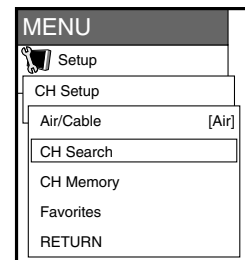

Automatic channel searching

Channel auto search makes the Plasma Display System look for all channels viewable in the set area.

- 1 Press **MENU**.
- 2 Press **▲/▼** to select "Setup", and then press **SET/ENTER**.
 - Secret number setting menu displays only when "Secret No." is set. (See page 52.)
 - Setup menu displays when the "Secret No." is not set. Skip step 3.
- 3 Enter your 4-digit secret number with **0–9** to cancel the "Secret No." when you set it.
- 4 Press **▲/▼** to select "CH Setup", and then press **SET/ENTER**.
- 5 Press **▲/▼** to select "CH Search", and then press **SET/ENTER**.
 - Channel search automatically starts.
- 6 Press **MENU** to exit the menu.

NOTE

- Return to the previous menu by pressing **MENU RETURN**.
- Channel search function is available for ANT-A only.
- ANT-B cannot perform channel search.
- You may need to manually add the Cable Converter output channel setting (fixed), when the Cable Converter using. (See page 25.)

Basic adjustment settings

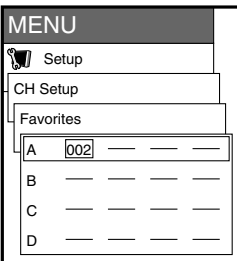
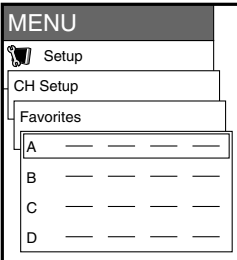
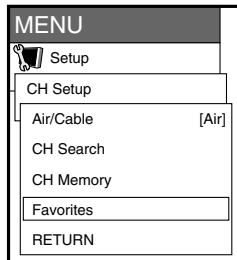
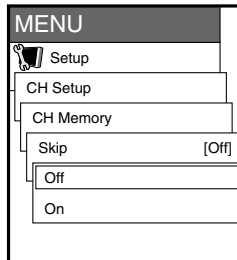
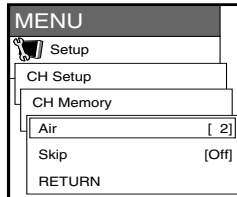
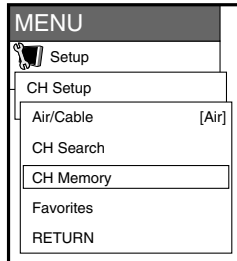
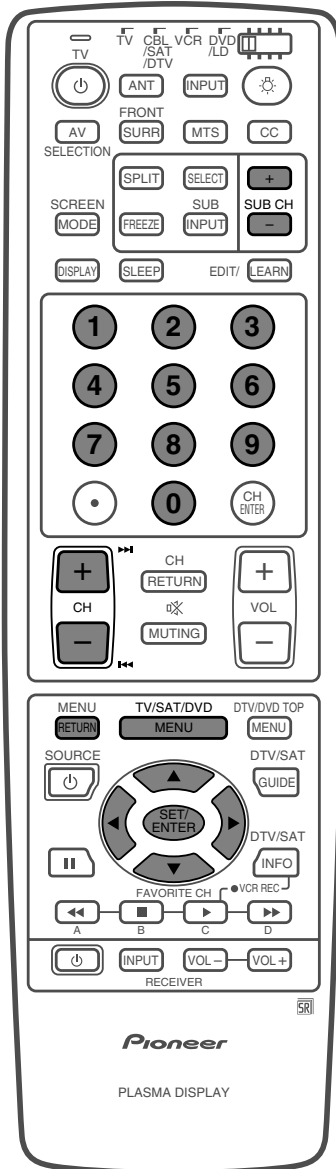

Saving broadcast TV channels to memory

- 1 Press **MENU**.
- 2 Press **▲/▼** to select "Setup", and then press **SET/ENTER**.
 - Secret number setting menu displays only when "Secret No." is set. (See page 52.)
 - Setup menu displays when the "Secret No." is not set. Skip step 3.
- 3 Enter your 4-digit secret number with **0–9** to cancel the "Secret No." when you set it.
- 4 Press **▲/▼** to select "CH Setup", and press **SET/ENTER**.
- 5 Press **▲/▼** to select "CH Memory", and press **SET/ENTER**.
- 6 Press **▲/▼** to select "Air[2]".
- 7 Press **◀/▶** to select the channel you want to skip or not.
- 8 Press **▲/▼** to select "Skip", and press **SET/ENTER**.
- 9 Press **▲/▼** to select "On" or "Off", and press **SET/ENTER**. Repeat the same steps for other channels.
 - On: Skips channels. (Channel selection disabled using **CH +/-** and **SUB CH +/-**.)
 - Off: Does not skip channels. (Channel selection enabled using **CH +/-** and **SUB CH +/-**.)

NOTE

- Return to the previous menu by pressing **MENU RETURN**.
- Channel memory function is available for ANT-A only.
- ANT-B cannot perform channel search.
- You may need to manually add the CABLE Converter output channel setting (fixed), when the CABLE Converter using. (See page 25.)

Setting the favorite channels

This function allows you to program 4 favorite channels, in 4 different categories. (A total of 16 channels.) By setting the favorite channels in advance, you can select your favorite channels easily.

- 1 Press **MENU**.
- 2 Press **▲/▼** to select "Setup", and then press **SET/ENTER**.
 - Secret number setting menu displays only when "Secret No." is set. (See page 52.)
 - Setup menu displays when the "Secret No." is not set. Skip step 3.
- 3 Enter your 4-digit secret number with **0–9** to cancel the "Secret No." when you set it.
- 4 Press **▲/▼** to select "CH Setup", and press **SET/ENTER**.
- 5 Press **▲/▼** to select "Favorites", and press **SET/ENTER**.
- 6 Press **▲/▼** to select the desired memory area(A to D), and press **SET/ENTER**.
- 7 Press **◀/▶** to select the position in the area, and then press **▲/▼** to select the desired channel and press **SET/ENTER** to fix the channels. Repeat the same steps to set for other area.
- 8 Press **MENU** to exit the menu.

NOTE

- Return to the previous menu by pressing **MENU RETURN**.

Basic adjustment settings

Language setting

You can also select a language from the option menu. Select from among 3 languages: English, French and Spanish.

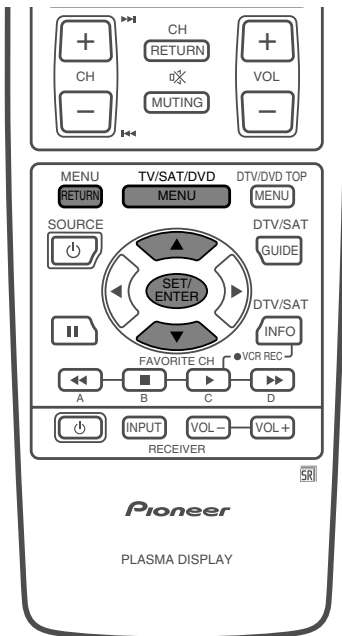

- 1 Press **MENU**.
- 2 Press **▲/▼** to select “Option”, and then press **SET/ENTER**.
 - Option menu displays.
- 3 Press **▲/▼** to select “Language”, and then press **SET/ENTER**.
 - Language menu displays.
- 4 Press **▲/▼** to select the desired language listed on the screen, and then press **SET/ENTER**.
- 5 Press **MENU** to exit the menu.

NOTE

- Return to the previous menu by pressing **MENU RETURN**.

Basic adjustment settings

Picture adjustments

Adjust the picture to your preference with the following picture settings.

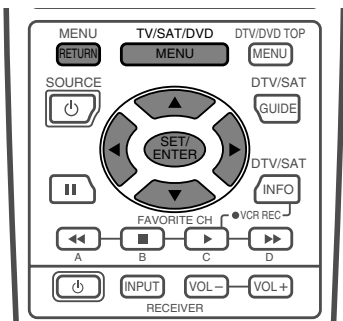
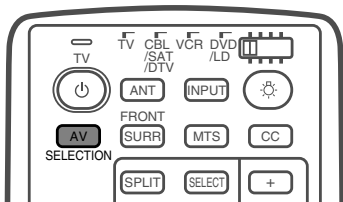

- 1 Press **MENU**.
- 2 Press **▲/▼** to select "Picture", and then press **SET/ENTER**.
 - Picture menu displays.
- 3 Press **▲/▼** to select a specific adjustment item.
- 4 Press **◀/▶** to adjust the item to your desired position.
- 5 Press **MENU** to exit the menu.

NOTE

- When all adjustments are set to factory preset values,
 - ① Press **▲/▼** to select "Reset", and then press **SET/ENTER**.
 - ② Press **▲/▼** to select "Yes", and then press **SET/ENTER**.
- Return to the previous menu by pressing **MENU RETURN**.
- **If you select "STANDARD" with AV SELECTION on the remote control unit, these items will display in gray and not be selectable. See page 44.**

Adjustments items for AV source

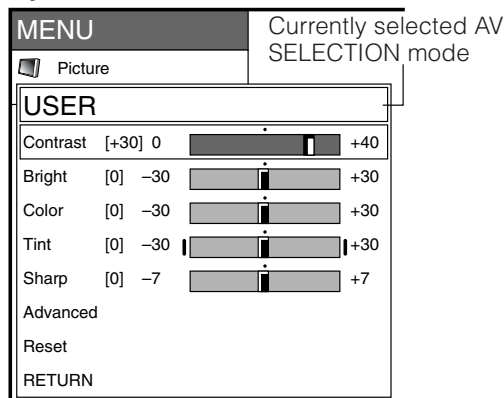

Adjustments items for PC source

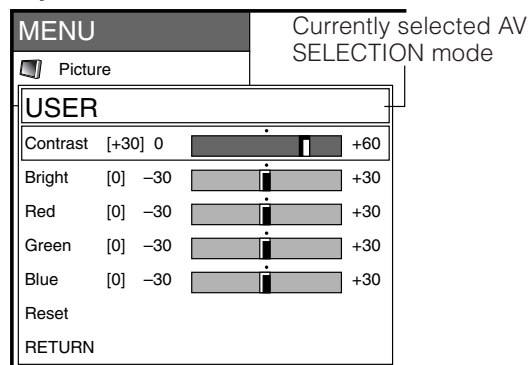

Selected item	◀ button	▶ button
Contrast	For less contrast	For more contrast
Bright	For less brightness	For more brightness
Color	For less color intensity	For more color intensity
Tint	Skin tones become purplish	Skin tones become greenish
Sharp	For less sharpness	For more sharpness

Selected item	◀ button	▶ button
Contrast	For less contrast	For more contrast
Bright	For less brightness	For more brightness
Red	For weaker red	For stronger red
Green	For weaker green	For stronger green
Blue	For weaker blue	For stronger blue

NOTE

- Select "Advanced" and then press **SET/ENTER** to set "Color Temp", "Black", "3D-Y/C", "Black & White" or "PureCinema" settings. See pages 28, 29 and 30.

Basic adjustment settings

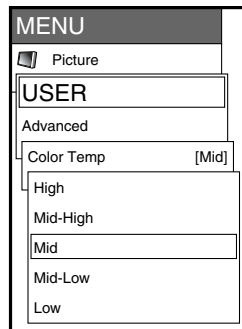
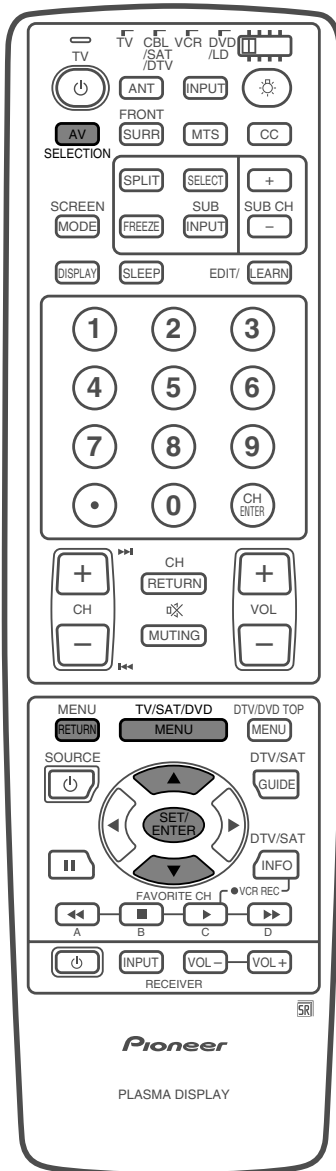

Color temperature

Adjust the color temperature to give a better white balance.

- 1 Press **MENU**.
- 2 Press **▲/▼** to select "Picture", and then press **SET/ENTER**.
- 3 Press **▲/▼** to select "Advanced", and then press **SET/ENTER**.
- 4 Press **▲/▼** to select "Color Temp", and then press **SET/ENTER**.
- 5 Press **▲/▼** to select the desired level, and then press **SET/ENTER**.
- 6 Press **MENU** to exit the menu.

NOTE

- Return to the previous menu by pressing **MENU RETURN**.
- If you select "STANDARD" with **AV SELECTION** on the remote control unit, this item will display in gray and not be selectable. See page 44.

Selected item	Description
High	White with Bluish tone ↑↓ White with Reddish tone
Mid-High	
Mid	
Mid-Low	
Low	

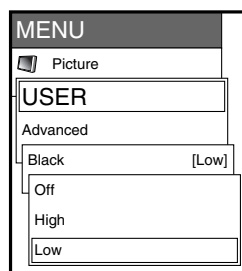

Black

Select a level for automatically adjusting blackish tone to suit viewing conditions.

- 1 Press **MENU**.
- 2 Press **▲/▼** to select "Picture", and then press **SET/ENTER**.
- 3 Press **▲/▼** to select "Advanced", and then press **SET/ENTER**.
- 4 Press **▲/▼** to select "Black", and then press **SET/ENTER**.
- 5 Press **▲/▼** to select the desired level, and then press **SET/ENTER**.
- 6 Press **MENU** to exit the menu.

NOTE

- Return to the previous menu by pressing **MENU RETURN**.
- If you select "STANDARD" with **AV SELECTION** on the remote control unit, this item will display in gray and not be selectable. See page 44.

Selected item	Description
Off	No adjustment
High	For high detail in black portions
Low	For low detail in black portions

Basic adjustment settings

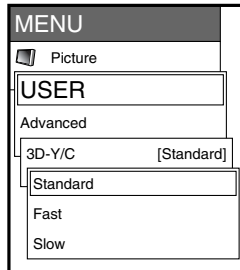
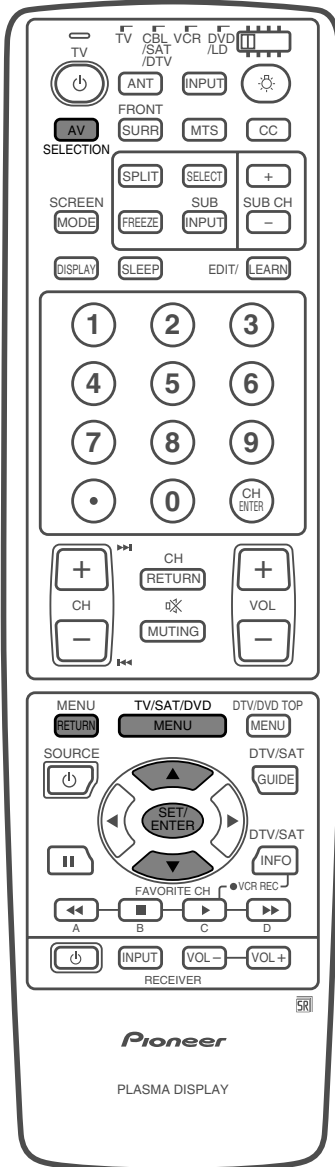

3D-Y/C

Provides high quality images with minimal dot crawl and cross color noise.

- 1 Press **MENU**.
- 2 Press **▲/▼** to select "Picture", and then press **SET/ENTER**.
- 3 Press **▲/▼** to select "Advanced", and then press **SET/ENTER**.
- 4 Press **▲/▼** to select "3D-Y/C", and then press **SET/ENTER**.
- 5 Press **▲/▼** to select the desired item, and then press **SET/ENTER**.
- 6 Press **MENU** to exit the menu.

NOTE

- Return to the previous menu by pressing **MENU RETURN**.
- If you select "STANDARD" with **AV SELECTION** on the remote control unit, this item will display in gray and not be selectable. See page 44.

Selected item	Description
Standard	Normal adjustment
Fast	For moving image
Slow	For still image

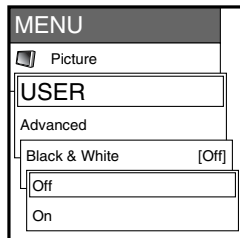

Black & White

For viewing a video in monochrome.

- 1 Press **MENU**.
- 2 Press **▲/▼** to select "Picture", and then press **SET/ENTER**.
- 3 Press **▲/▼** to select "Advanced", and then press **SET/ENTER**.
- 4 Press **▲/▼** to select "Black & White", and then press **SET/ENTER**.
- 5 Press **▲/▼** to select "On", and then press **SET/ENTER**.
- 6 Press **MENU** to exit the menu.

NOTE

- Return to the previous menu by pressing **MENU RETURN**.
- If you select "STANDARD" with **AV SELECTION** on the remote control unit, this item will display in gray and not be selectable. See page 44.

Selected item	Description
Off	Normal color
On	For viewing in monochrome

Basic adjustment settings

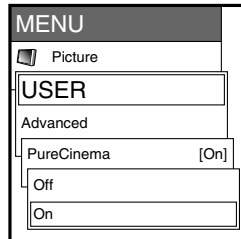
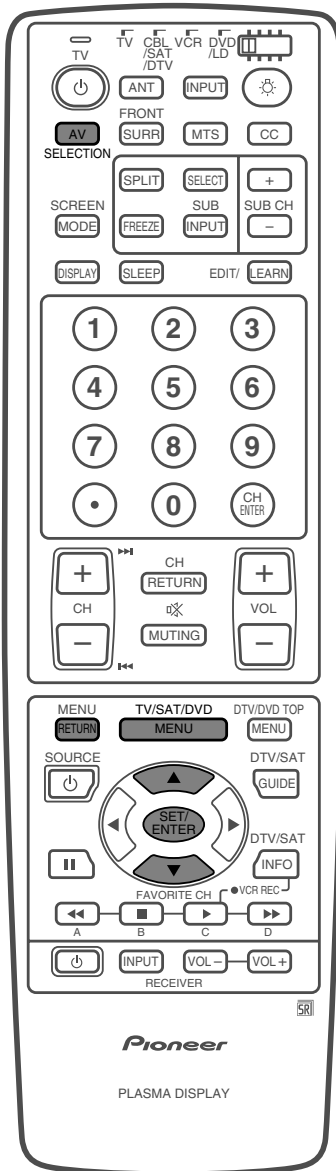

PureCinema

Automatically detects a film-based source (originally encoded at 24 frames/second), analyzes it then recreates each still film frame for high-definition picture quality.

- 1 Press **MENU**.
- 2 Press **▲/▼** to select "Picture", and then press **SET/ENTER**.
- 3 Press **▲/▼** to select "Advanced", and then press **SET/ENTER**.
- 4 Press **▲/▼** to select "PureCinema", and then press **SET/ENTER**.
- 5 Press **▲/▼** to select "On", and then press **SET/ENTER**.
- 6 Press **MENU** to exit the menu.

NOTE

- Return to the previous menu by pressing **MENU RETURN**.
- If you select "STANDARD" with **AV SELECTION** on the remote control unit, or input sources with 1080i, 720P or 480P component signals, this item will display in gray and not be selectable. See page 44.

Selected item	Description
Off	Normal viewing mode
On	Detects, analyzes, converts film source

Basic adjustment settings

Sound adjustment

You can adjust the sound quality to your preference with the following settings.

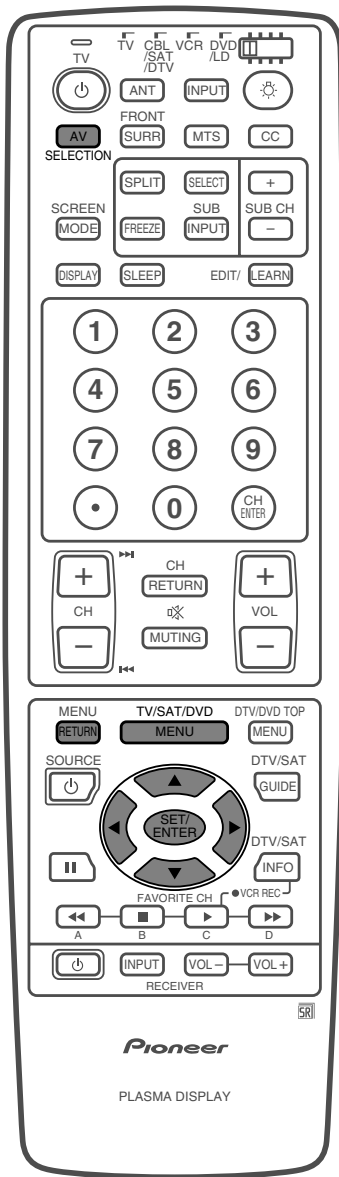

- 1 Press **MENU**.
- 2 Press **▲/▼** to select “Audio”, and then press **SET/ENTER**.
 - Audio menu displays.
- 3 Press **▲/▼** to select a specific adjustment item.
- 4 Press **◀/▶** to adjust the item to your desired position.
- 5 Press **MENU** to exit the menu.

NOTE

- When all adjustments are set to factory preset values,
 - ① Press **▲/▼** to select “Reset”, and then press **SET/ENTER**.
 - ② Press **▲/▼** to select “Yes”, and then press **SET/ENTER**.
- Return to the previous menu by pressing **MENU RETURN**.
- **If you select “STANDARD” with AV SELECTION on the remote control unit, these items will display in gray and not be selectable. See page 44.**

Selected item	◀ button	▶ button
Treble	For weaker treble	For stronger treble
Bass	For weaker bass	For stronger bass
Balance	Decrease audio from the right speaker	Decrease audio from the left speaker

Adjustment items for AV source

MENU			
Audio			
USER			
Treble	[0] -15		+15
Bass	[0] -15		+15
Balance	[0] Left		Right
Reset			
RETURN			

Basic adjustment settings

Power Control

Power Control setting allows you to reduce the display brightness to save energy.

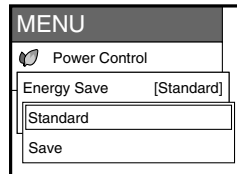
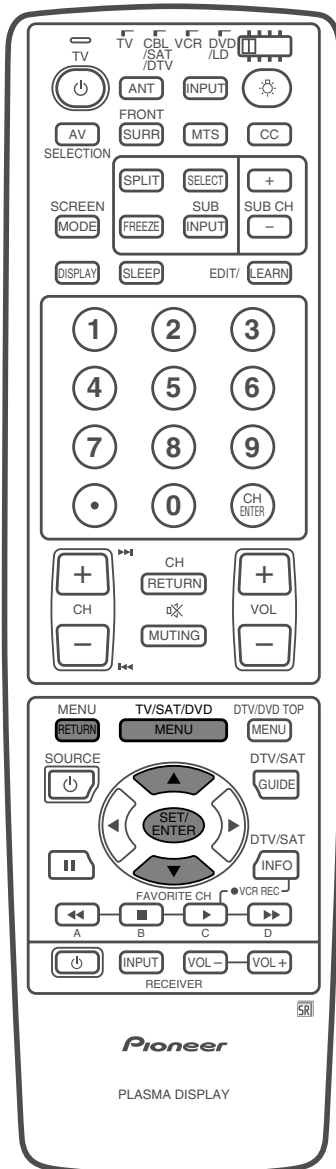

Power Control for AV source

Energy Save

When set to "Save", the power consumption is saved by decreasing picture brightness.

- 1 Press **MENU**.
- 2 Press **▲/▼** to select "Power Control", and then press **SET/ENTER**.
- 3 Press **▲/▼** to select "Energy Save", and then press **SET/ENTER**.
- 4 Press **▲/▼** to select "Save", and then press **SET/ENTER**.
- 5 Press **MENU** to exit the menu.

NOTE

- "Standard" is factory preset value.
- Return to the previous menu by pressing **MENU RETURN**.

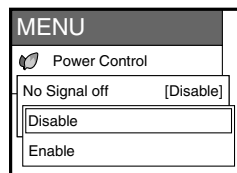

No Signal off

When set to "Enable", the power will automatically shut down if no signal inputs for 15 minutes.

- 1 Press **MENU**.
- 2 Press **▲/▼** to select "Power Control", and then press **SET/ENTER**.
- 3 Press **▲/▼** to select "No Signal off", and then press **SET/ENTER**.
- 4 Press **▲/▼** to select "Enable", and then press **SET/ENTER**.
- 5 Press **MENU** to exit the menu.
 - Five minutes before the power shuts down, a hazard warning displays every minute.

NOTE

- "Disable" is factory preset value.
- Return to the previous menu by pressing **MENU RETURN**.
- When a TV program finishes, and the Media Receiver should receives a signal input, but this may not occur.

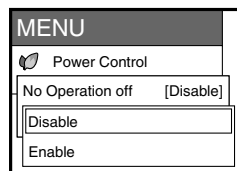

No Operation off

When set to "Enable", the power will automatically shut down if no operation for 3 hours.

- 1 Press **MENU**.
- 2 Press **▲/▼** to select "Power Control", and then press **SET/ENTER**.
- 3 Press **▲/▼** to select "No Operation off", and then press **SET/ENTER**.
- 4 Press **▲/▼** to select "Enable", and then press **SET/ENTER**.
- 5 Press **MENU** to exit the menu.
 - Five minutes before the power shuts down, hazard warning displays every minute.

NOTE

- "Disable" is factory preset value.
- Return to the previous menu by pressing **MENU RETURN**.

Basic adjustment settings

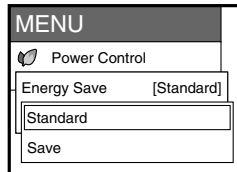
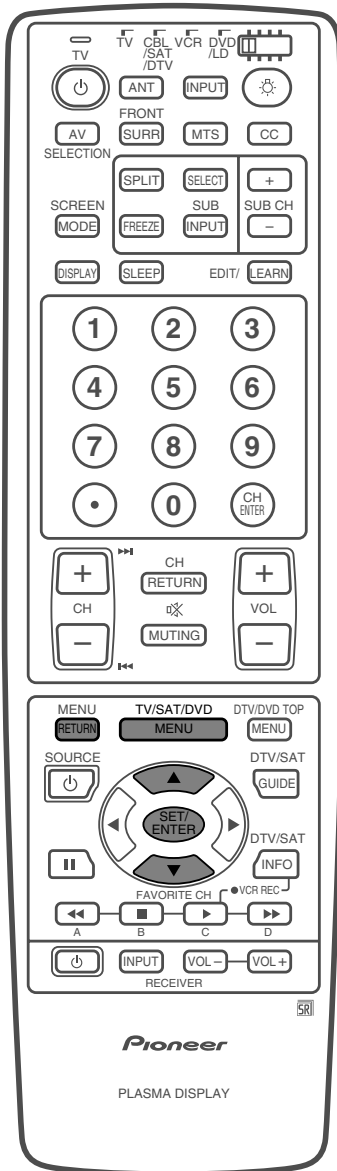

Power Control for PC source

Power control allows you to reduce display brightness and save energy.

Energy Save

- 1 Press **MENU**.
- 2 Press **▲/▼** to select "Power Control", and then press **SET/ENTER**.
- 3 Press **▲/▼** to select "Energy Save", and then press **SET/ENTER**.
- 4 Press **▲/▼** to select "Save", and then press **SET/ENTER**.
- 5 Press **MENU** to exit the menu.

NOTE

- "Standard" is factory preset value.
- Return to the previous menu by pressing **MENU RETURN**.

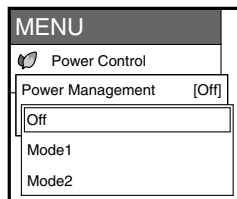

Power Management

When set, the power will automatically shut down.

- 1 Press **MENU**.
- 2 Press **▲/▼** to select "Power Control", and then press **SET/ENTER**.
- 3 Press **▲/▼** to select "Power Management", and then press **SET/ENTER**.
- 4 Press **▲/▼** to select "Mode1" or "Mode2", and then press **SET/ENTER**.
- 5 Press **MENU** to exit the menu.

NOTE

- Return to the previous menu by pressing **MENU RETURN**.

Selected item	Description
Off	<ul style="list-style-type: none"> • No power management • Factory preset value.
Mode1	<ul style="list-style-type: none"> • If no signal inputs for 8 minutes, the power shuts down. • Even if you start using the computer and the signal inputs again, the System stays off. • The System turns on again by pressing STANDBY/ON on the Plasma Display or TV on the remote control unit.
Mode2	<ul style="list-style-type: none"> • If no signal inputs for 8 seconds, the power shuts down. • When you start using the computer and the signal inputs again, the System turns on.

Using external equipment

You can connect many types of external equipment to your Plasma Display System, like a DVD player, VCR, Digital tuner, computer, game console and camcorder. To view external source images, select the input source from **INPUT** on the remote control unit or on the Plasma Display.

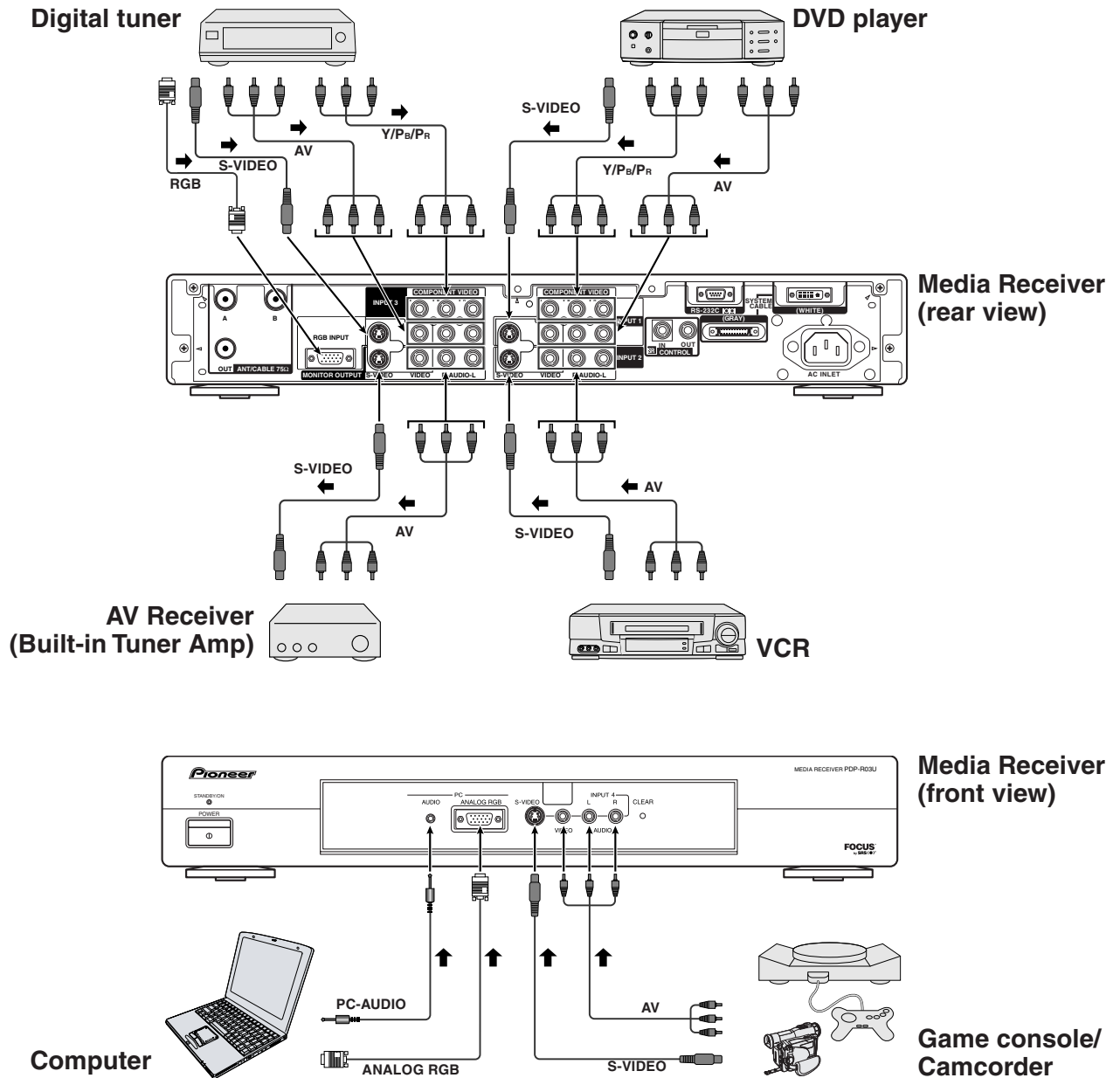

CAUTION

- To protect all equipment, always turn off the Media Receiver before connecting to a DVD player, VCR, Digital tuner, computer, game console, camcorder or other external equipment.

NOTE

- Please refer to the relevant operation manual (DVD player, computer, etc.) carefully before making connections.

Using external equipment

Watching a DVD image

Connecting a DVD player

You can use the INPUT 1 terminal when connecting to a DVD player and other audiovisual equipment.

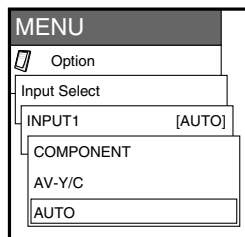
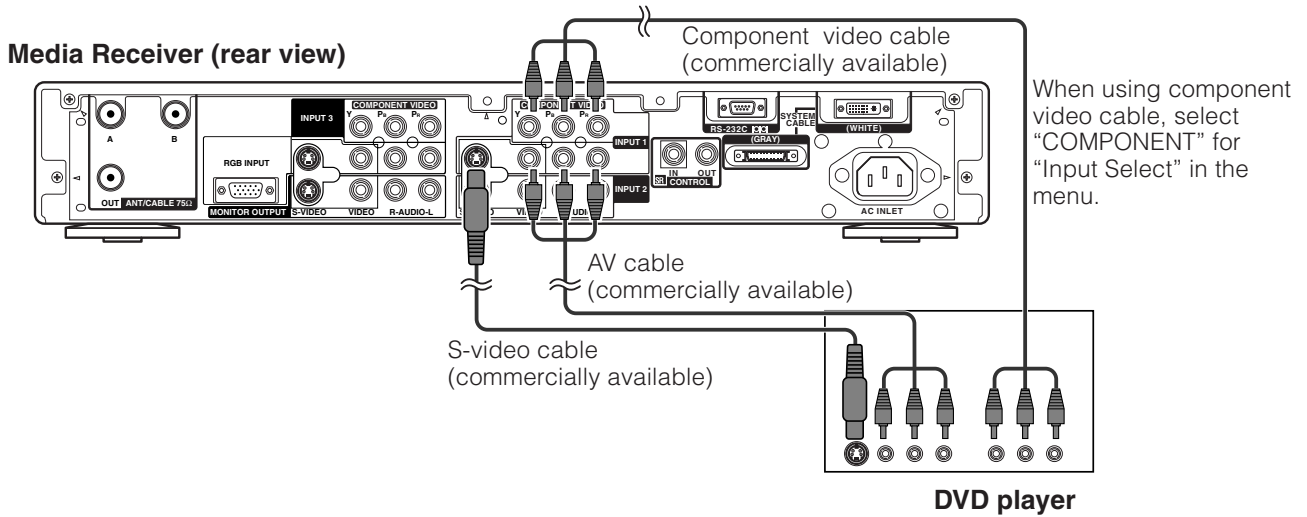

Displaying a DVD image

When connecting to the INPUT 1 terminal, select "INPUT1" and set the correct input signal type on "Input Select" in the menu. (See page 43.)

The setting is stored and can be selected on the "INPUT SOURCE" menu.

To watch a DVD image, select "INPUT1" from "INPUT SOURCE" menu using **INPUT** on the remote control unit or on the Plasma Display. (See page 43.)

NOTE

- Each time **INPUT** is pressed, the input source toggles.
- If the DVD image does not come in clearly, you may need to change the input signal type setting on the "Input Select" menu.
- Refer to your DVD player operation manual for the signal type.

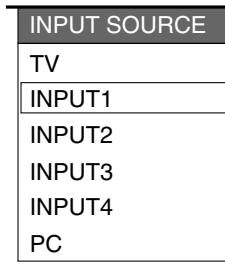
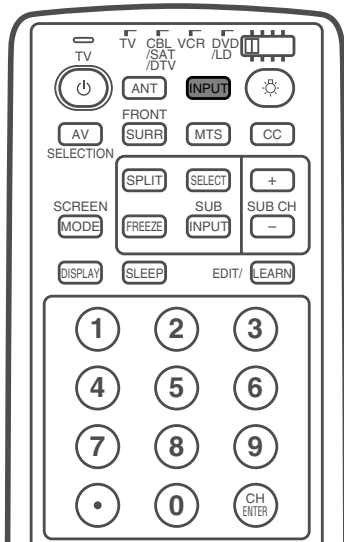

Using external equipment

Watching a VCR image

Connecting a VCR

You can use the INPUT 2 terminal when connecting a VCR and other audiovisual equipment.

Media Receiver (rear view)

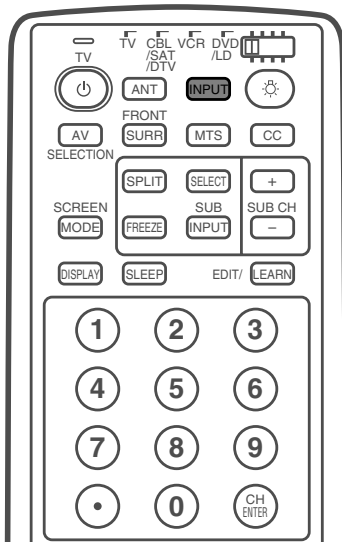
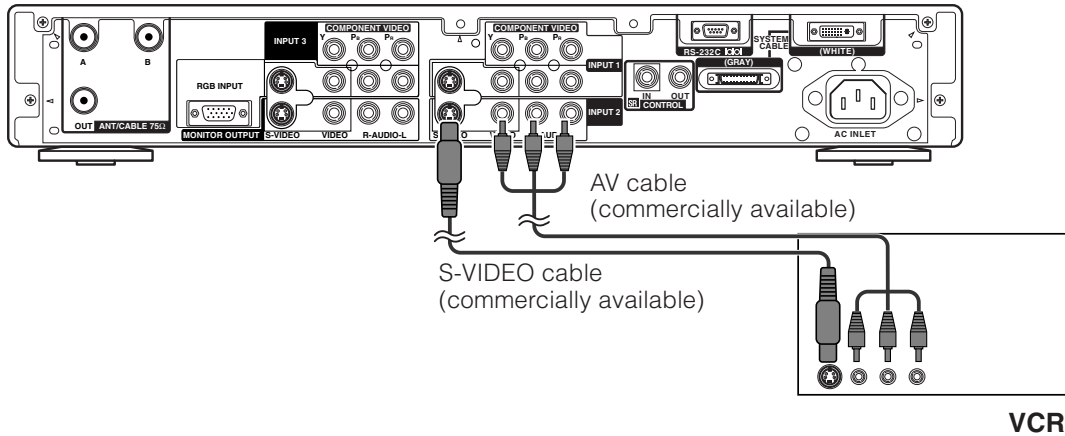

INPUT SOURCE
TV
INPUT1
INPUT2
INPUT3
INPUT4
PC

Displaying a VCR image

When connecting to the INPUT 2 terminals, select "INPUT2".

You only need to select the input source on the "INPUT SOURCE" menu.

To watch a VCR image, select "INPUT2" from the "INPUT SOURCE" menu using **INPUT** on the remote control unit or on the Plasma Display. (See page 43.)

NOTE

- Each time **INPUT** is pressed, the input source toggles.
- Refer to your VCR operation manual for the signal type.

Using external equipment

Watching broadcasts via a Digital tuner

Connecting a Digital tuner

You can use the INPUT 3 terminal when connecting a Digital tuner and other audiovisual equipment.

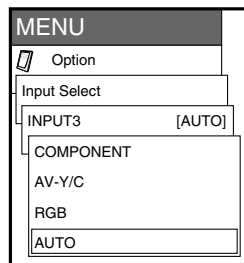
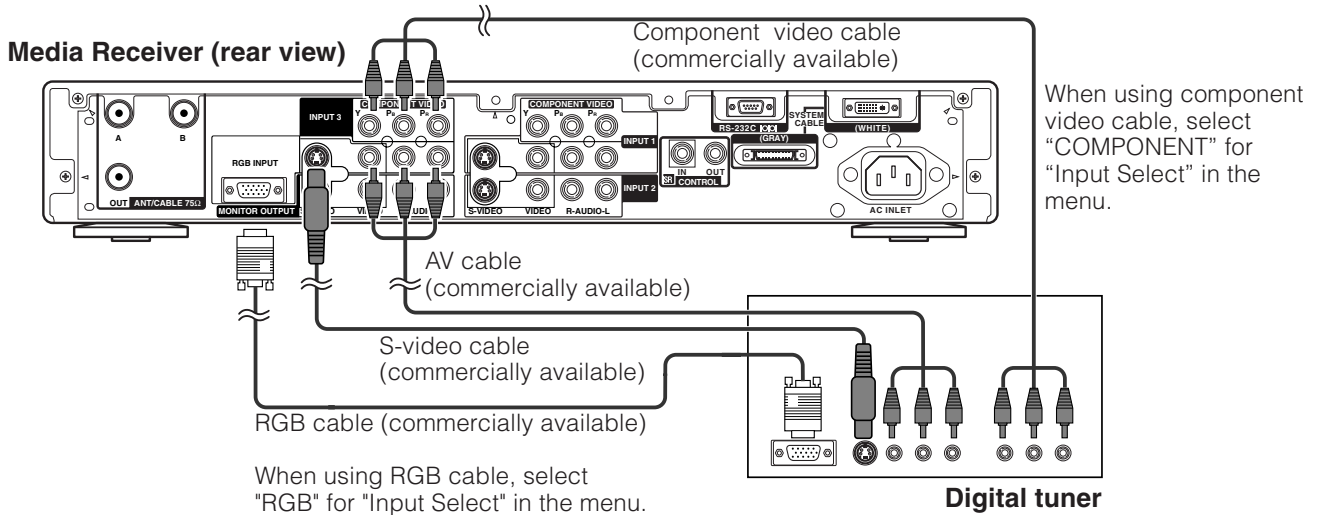

Displaying broadcasts via a Digital tuner

When connecting to the INPUT 3 terminal, select "INPUT3" and set the correct input signal type on "Input Select" in the menu. (See page 43.)

The setting is stored and can be selected on the "INPUT SOURCE" menu.

To watch a Digital tuner image, select "INPUT3" from the "INPUT SOURCE" menu using **INPUT** on the remote control unit or on the Plasma Display. (See page 43.)

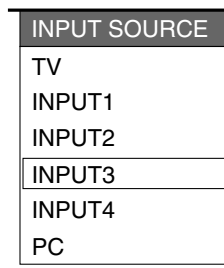
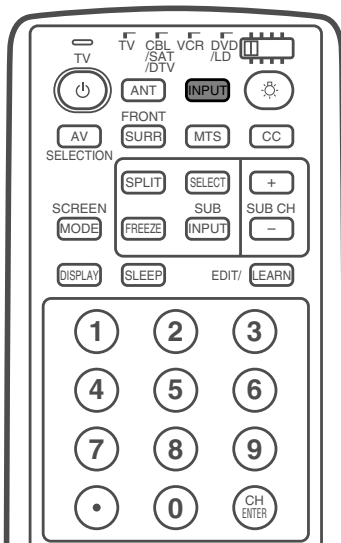

NOTE

- Each time **INPUT** is pressed, the input source toggles.
- If the Digital tuner image does not come in clearly, you may need to change the input signal type setting on the "Input Select" menu.
- Refer to your Digital tuner operation manual for the signal type.
- RGB INPUT cannot connect to a PC. (Input resolution is compatible with 1080I and 540P.)
- Use the PC INPUT terminals on the front of the Media Receiver when connecting a computer. (See page 39.)

Using external equipment

Enjoying a game console or viewing camcorder images

Connecting a game console or camcorder

A game console, camcorder and some other audiovisual equipment are conveniently connected using the INPUT 4 terminals.

NOTE

- The S-video terminal has priority over the video terminals.

Media Receiver (front view)

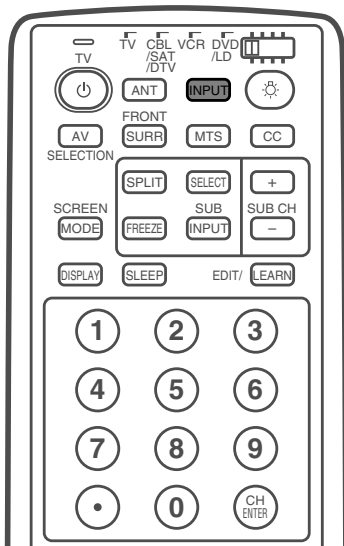
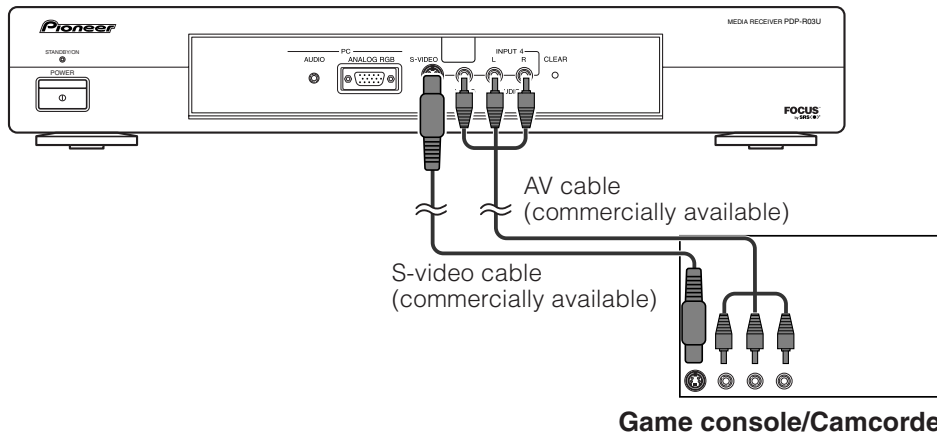

INPUT SOURCE
TV
INPUT1
INPUT2
INPUT3
INPUT4
PC

Displaying an image of the game console or camcorder

When connecting to the INPUT 4 terminals, select "INPUT4".

You only need to select the input source on the "INPUT SOURCE" menu.

To connect a game console or view a camcorder, select "INPUT4" from the "INPUT SOURCE" menu using **INPUT** on the remote control unit or on the Plasma Display. (See page 43.)

NOTE

- Each time **INPUT** is pressed, the input source toggles.

Using external equipment

Viewing an image from a computer

Connecting a computer

Use the PC terminals to connect a computer.

NOTE

- The PC input terminals are DDC1/2B-compatible.
- Refer to page 65 for a list of computer signals compatible with the Plasma Display System.

Media Receiver (front view)

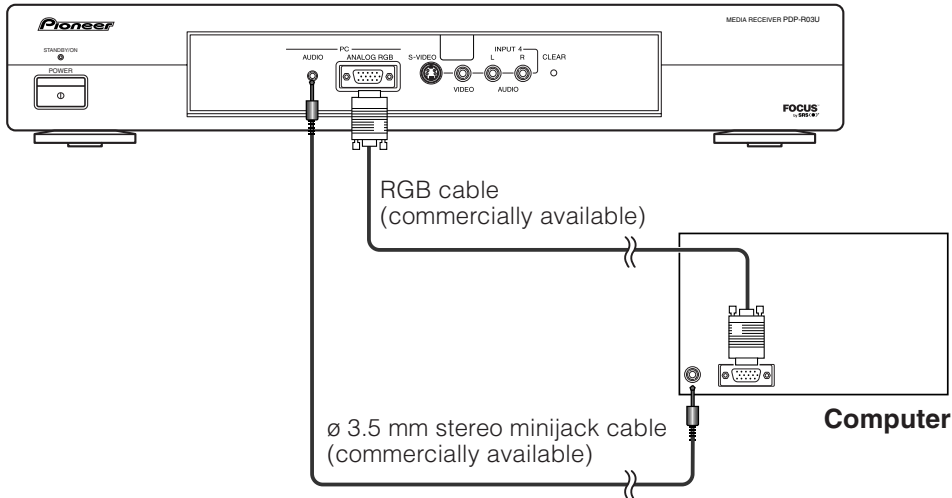

Signal names for 15-pin mini D-sub connector

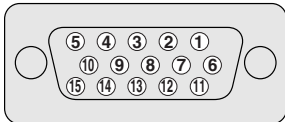

Pin No.	Signal name	Pin No.	Signal name	Pin No.	Signal name
①	R	⑥	GND (Ground)	⑪	Not connected
②	G	⑦	GND (Ground)	⑫	SDA
③	B	⑧	GND (Ground)	⑬	HD
④	Not connected	⑨	+ 5V	⑭	VD
⑤	CSYNC	⑩	GND (Ground)	⑮	SCL

NOTE

- Macintosh adaptor may be required for use for some Macintosh computers.

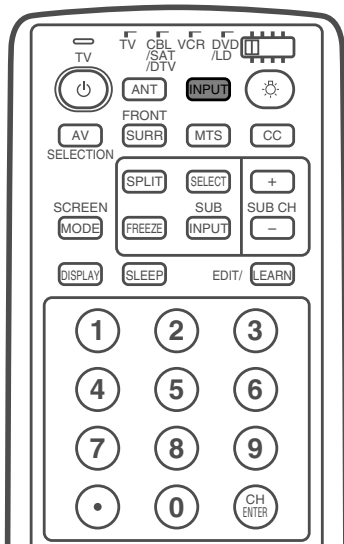

Displaying an image from a computer

When connecting to a computer, the correct input signal type is automatically detected. If the computer image does not come in clearly, you may need to set the Auto Sync. adjustment on the "Auto Sync." in the menu. (See page 42.)

You only need to select the input source on the "INPUT SOURCE" menu.

To view an image from a computer, select "PC" from the "INPUT SOURCE" menu using **INPUT** on the remote control unit or on the Plasma Display. (See page 43.)

NOTE

- Each time **INPUT** is pressed, the input source toggles.
- PC INPUT terminals cannot be used for audiovisual equipment. Use the INPUT 3 (RGB) terminal on the rear of the Media Receiver when connecting audiovisual equipment with an RGB signal. (See page 37.)

Using external equipment

Control cord connection

When connecting control cords to the Media Receiver from other remote controlled PIONEER components bearing the **SR** logo, remote control operations are performed through the sensor on the System side. After connecting to a CONTROL IN jack on another component, its sensor will no longer receive signals. To operate a component remotely, point the remote control unit of the connected component at the remote control sensor on the System.

NOTE

- Make sure the power is turned off when making connections.
- Please complete all component connections before making control cord connections.

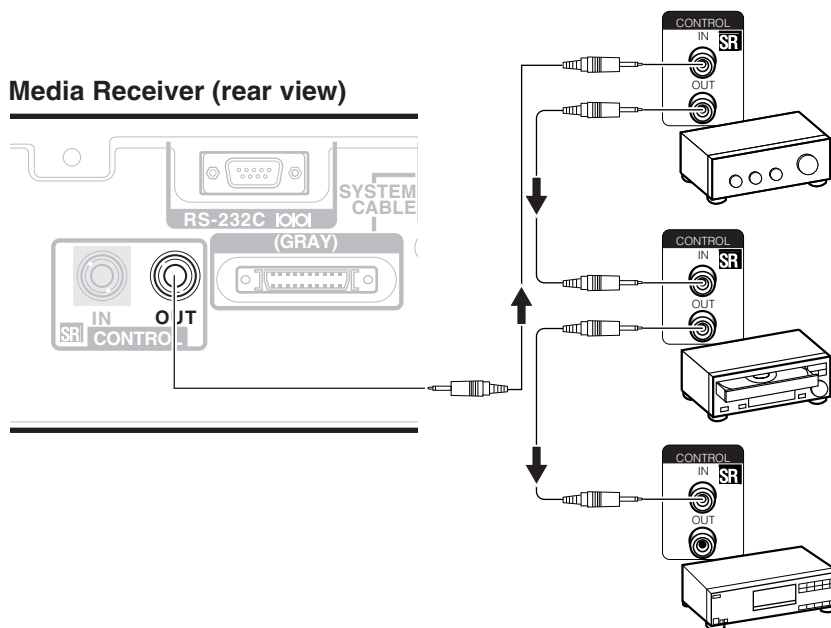

The control cables (not supplied) are mono sound cables with mini plugs (no resistance).

Useful adjustment settings

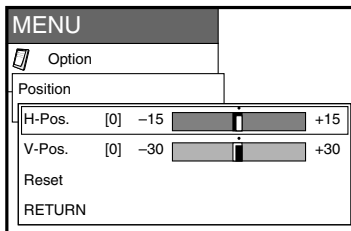
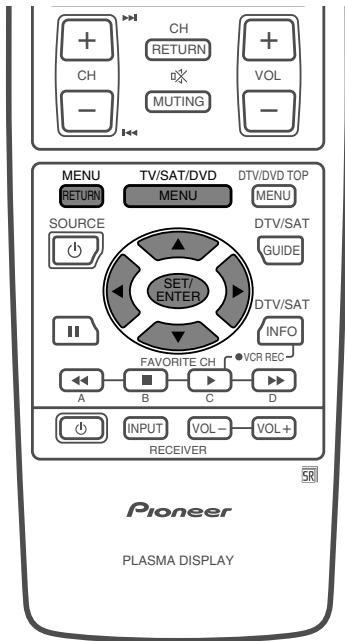

Image position (AV mode only)

For adjusting a picture's horizontal and vertical position.

- 1 Press **MENU**.
- 2 Press **▲/▼** to select "Option", and then press **SET/ENTER**.
- 3 Press **▲/▼** to select "Position", and then press **SET/ENTER**.
- 4 Press **▲/▼** to select "H-Pos." or "V-Pos."
- 5 Press **◀/▶** to adjust the item to your desired position.
- 6 Press **MENU** to exit the menu.

NOTE

- For resetting all adjustment items set to the factory preset values,
 - ① Press **▲/▼** to select "Reset", and then press **SET/ENTER**.
 - ② Press **▲/▼** to select "Yes", and then press **SET/ENTER**.
- Return to the previous menu by pressing **MENU RETURN**.
- **Adjustments are stored separately according to input source.**
- You can easily move the image position as shown on page 22, but when the power is switched off the image will return to the previously memorised position.

Selected item	Description
H-Pos.	Centers the image by moving it to the left or right.
V-Pos.	Centers the image by moving it up or down.

Useful adjustment settings

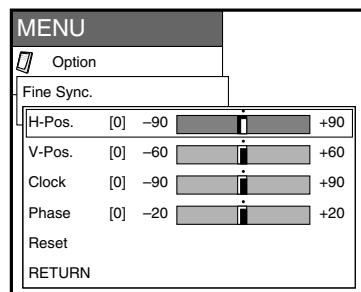
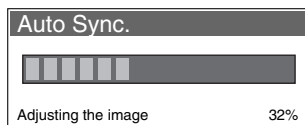
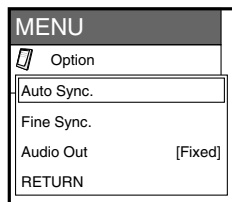
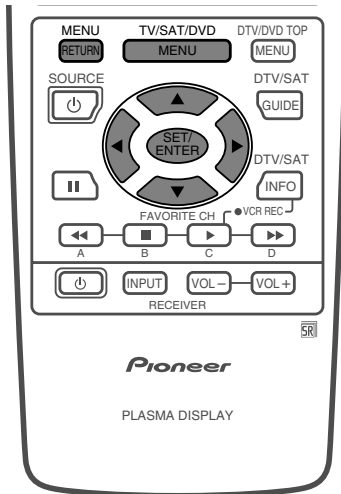

Auto Sync. adjustment (PC mode only)

For automatically adjusting the computer image.

- 1 Press **MENU**.
- 2 Press **▲/▼** to select "Option", and then press **SET/ENTER**.
- 3 Press **▲/▼** to select "Auto Sync.", and then press **SET/ENTER**.
 - Auto Sync. starts and "Adjusting the image." displays.

NOTE

- Return to the previous menu by pressing **MENU RETURN**.
- When Auto Sync. is successful, "Auto Sync completed successfully" displays. If not, Auto Sync. failed.
- Auto Sync. may fail even if "Auto Sync completed successfully" displays.
- Auto Sync. may fail with a PC image composed of similar patterns or monochrome. If not successful, change the PC image and try again.
- Be sure to connect the computer to the Media Receiver and switch it on before starting Auto Sync.

Fine Sync. adjustment (PC mode only)

Ordinarily you can easily adjust the picture as necessary to change image position using Auto Sync. In some cases, however, manual adjustment is needed to optimize the image.

- 1 Press **MENU**.
- 2 Press **▲/▼** to select "Option", and then press **SET/ENTER**.
- 3 Press **▲/▼** to select "Fine Sync.", and then press **SET/ENTER**.
- 4 Press **▲/▼** to select the specific adjustment item.
- 5 Press **◀/▶** to adjust the item to your desired position.
- 6 Press **MENU** to exit the menu.

NOTE

- When all adjustments are set to factory preset values,
 - ① Press **▲/▼** to select "Reset", and then press **SET/ENTER**.
 - ② Press **▲/▼** to select "Yes", and then press **SET/ENTER**.
- Return to the previous menu by pressing **MENU RETURN**.

Selected item	Description
H-Pos.	Centers the image by moving it to the left or right.
V-Pos.	Centers the image by moving it up or down.
Clock	Adjusts the clock frequency.
Phase	Adjusts the clock phase.

Useful adjustment settings

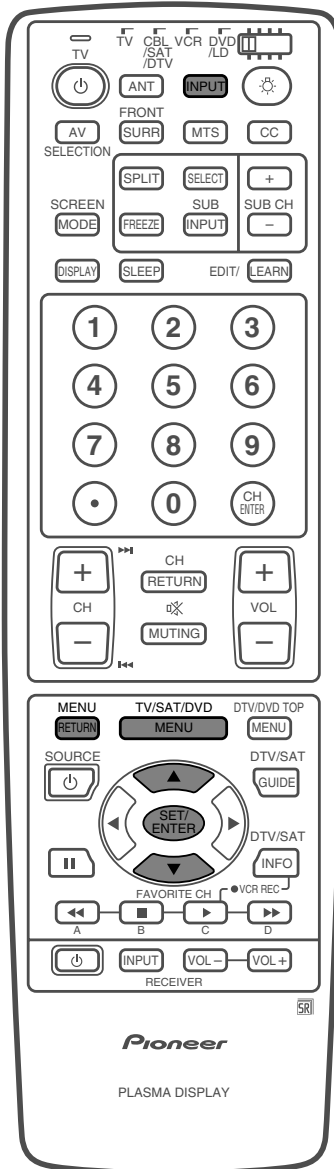

INPUT 1 signal menu

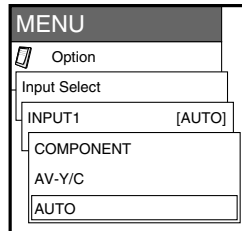

INPUT 3 signal menu

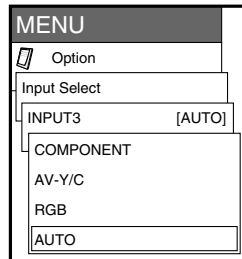

Input signal source

Input signal setting

For setting the signal type of external equipment.

- 1 Press **MENU**.
- 2 Press **▲/▼** to select "Option", and then press **SET/ENTER**.
- 3 Press **▲/▼** to select "Input Select", and then press **SET/ENTER**.
- 4 Press **▲/▼** to select an input source you want to set, and then press **SET/ENTER**.
- 5 Press **▲/▼** to select a signal type, and then press **SET/ENTER**.
 - If the selected signal type is incorrect, an image does not display or no color image displays.
- 6 Press **MENU** to exit the menu.

NOTE

- Return to the previous menu by pressing **MENU RETURN**.
- The System automatically sets input signals from "INPUT2", "INPUT4" and "PC".
- **If no image displays, try to change the signal type.**
- Check the operation manual of the external equipment for the signal type.
- Setting INPUT 1 and INPUT 3 signal selection to "AUTO" when other equipment is connected will result in the following connectivity priority.

INPUT 1	INPUT 3
1. COMPONENT VIDEO	1. COMPONENT VIDEO
2. S-VIDEO	2. S-VIDEO
3. VIDEO	3. VIDEO
	4. RGB INPUT

INPUT SOURCE

TV
 INPUT1
 INPUT2
 INPUT3
 INPUT4
 PC

Input selection

Can use for selecting the input source.

- 1 Press **INPUT** on the remote control unit or on the Plasma Display.
 - INPUT SOURCE menu displays.
- 2 Hold down **INPUT** on the remote control unit or on the Plasma Display to select the input source.
 - An image from the selected source automatically displays.
 - You can also select the input source by pressing **▲/▼**.

NOTE

- Items grayed out are not selectable.

Useful adjustment settings

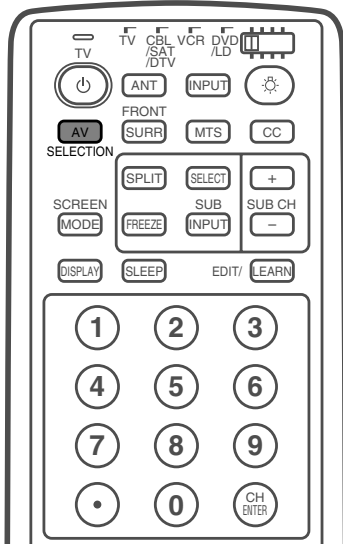

AV SELECTION

AV SELECTION gives you five viewing options to choose from to best match the Plasma Display System environment, which can vary due to factors like room brightness, type of program watched or the type of image input from external equipment.

- 1 Press **AV SELECTION**.
 - Present AV SELECTION mode displays.
- 2 Press **AV SELECTION** again before the mode displayed on the screen disappears.
 - The mode changes as shown left.

Selected item	Description
STANDARD	For a highly defined image in a normally bright room
DYNAMIC	For a clear-cut image emphasizing high contrast for sports viewing.
MOVIE	For a movie
GAME	Lowers image brightness for easier viewing
USER	Allows the user to customize settings as desired. You can set the mode for each input source.

Mode selection for INPUT 1 to 4 terminals

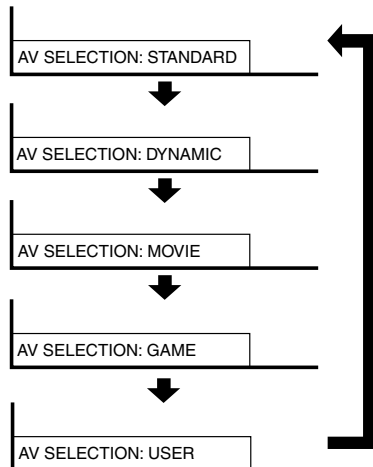

Mode selection for the PC terminal

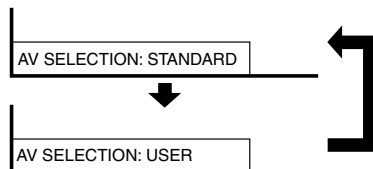

Useful adjustment settings

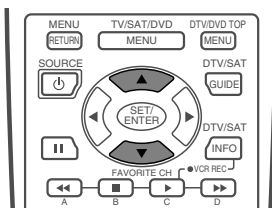
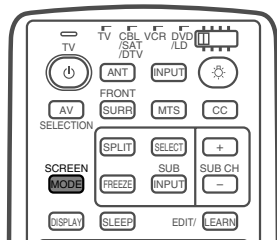

Wide Mode

1 Press **SCREEN MODE**.

- The Wide Mode menu displays.
- The menu lists the Wide Mode options selectable for the type of video signal currently received.

2 Press **SCREEN MODE** or ▲/▼ while the Wide Mode menu is still on the screen.

- You can sequentially select a Wide Mode that has its own aspect ratio.

AV mode

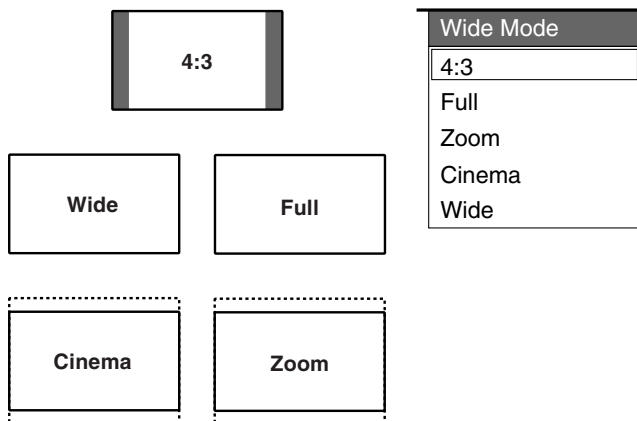

AV mode

Selected item	Description
4:3	For 4:3 "standard" pictures. A side bar appears on each side.
Full	For 16:9 squeeze pictures.
Zoom	For 16:9 letterbox pictures. Bars may appear on the top and bottom with some programs.
Cinema	For 14:9 letterbox pictures. Bars may appear on the top and bottom on some programs.
Wide	In this mode the picture is progressively stretched toward each side of the screen.

PC mode except for XGA signal

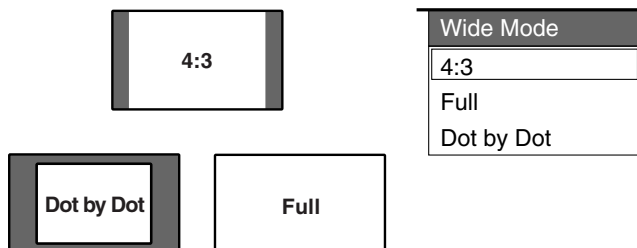

PC mode except for XGA signal

Selected item	Description
4:3	Fills the screen without altering the input signal aspect ratio.
Full	Full 16:9 screen display.
Dot by Dot	Matches input signal with same number of screen pixels.

PC mode for XGA signal

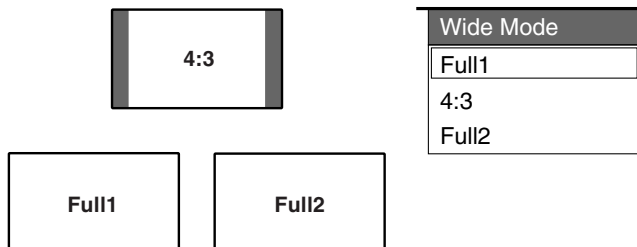

PC mode for XGA signal (Ex. 1024 × 768 input at PDP-5030HD)

Selected item	Description
Full1	Full 16:9 screen display. Optimized for 1024 × 768 display.
4:3	Matches input signal with same number of screen pixels. Optimized for 1024 × 768 display.
Full2	For wide signal display. Use when displaying 1280 × 768 signal resolution.

NOTE

- The PC mode above is for the PDP-5030HD. For the PDP-4330HD the number of panel pixels is different, so signal processing and actual viewing conditions will vary slightly.

Useful adjustment settings

Closed caption

- Your Plasma Display System is equipped with an internal closed caption decoder. Closed caption is a system which allows you to view conversations, narration, and sound effects in TV programs and home videos as subtitles on your Plasma Display screen.
- Not all programs and videos offer closed caption. Please look for the “**CC**” symbol to ensure that captions will be shown.
- “CC1” or “CC2” displays subtitles of TV dramas and news programs while allowing a full view of the picture.
- “T1” or “T2” superimposes on the picture other information (e.g. TV guide, weather) that is independent of the TV in progress.

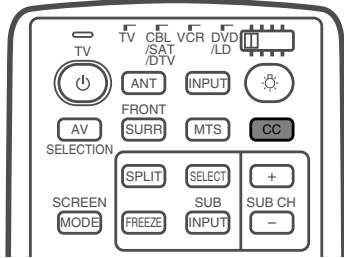

Each time you press **CC**, the closed caption toggles as shown below.

NOTE

- When using Dual Screen (See page 55.) and Still Image (See page 55.) functions, the right screen cannot display Closed Caption data.

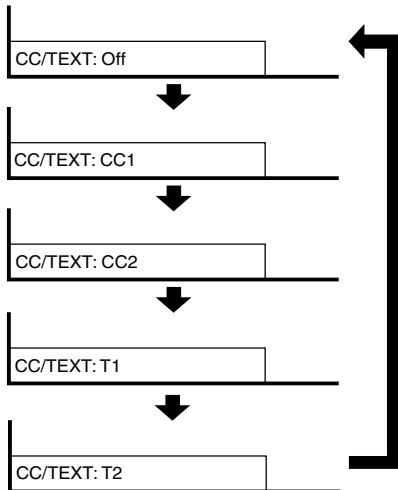

Useful adjustment settings

Parental control (setting V-CHIP level)

V-CHIP is an electronic filtering device built into your System. This tool gives parents a great degree of control over broadcasts accessed by their children. It allows parents to select programs judged suitable for child viewing while blocking ones judged not suitable. It does so automatically once you activate the V-CHIP feature in your Plasma Display.

V-CHIP and Status will not be selectable from the menu if you do not first configure your secret number. (See page 52 for Secret number setting for parental control.)

- The U.S. has two rating systems for viewing content: TV Parental Guidelines and movie ratings.
- The TV Parental Guidelines work in conjunction with the V-CHIP to help parents screen out inappropriate television shows from their children.
- Movie ratings are used for original movies rated by the Motion Picture Association of America (MPAA) as watched on cable TV and not edited for television. The V-CHIP can also be set to block MPAA-rated movies

Voluntary movie rating system (MPAA)

Rating		Description
Age	G	General audiences. All ages admitted.
	PG	Parental guidance suggested. Some material may not be suitable for children.
	PG-13	Parents strongly cautioned. Some material may be inappropriate for children under 13.
	R	Restricted. Under 17 requires accompanying parent or adult guardian (age varies in some jurisdictions).
	NC-17	No one 17 and under admitted.
	X	A rating that has now been superseded by NC-17.

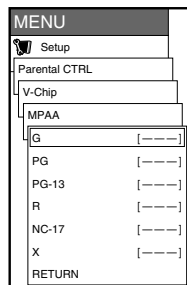

EXAMPLE

- If you select "PG-13", this will automatically block the higher ratings "R", "NC-17" and "X".

NOTE

- Voluntary movie rating system only uses an age-based rating.

TV Parental Guidelines

Rating		Content				
		FV (Fantasy violence)	V (Violence)	S (Sexual situation)	L (Adult language)	D (Sexually suggestive dialog)
Suggested age	TV-Y (All children)					
	TV-Y7 (Directed to older children)	X				
	TV-G (General audience)					
	TV-PG (Parental guidance suggested)		X	X	X	X
	TV-14 (Parents strongly cautioned)		X	X	X	X
	TV-MA (Mature audience only)		X	X	X	

X: Content rating can be set.

Useful adjustment settings

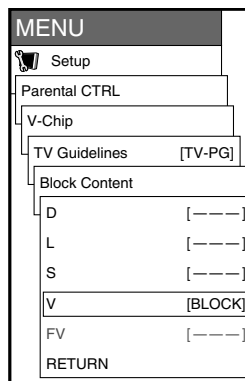
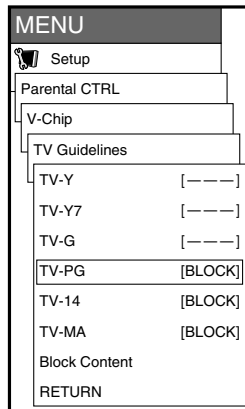
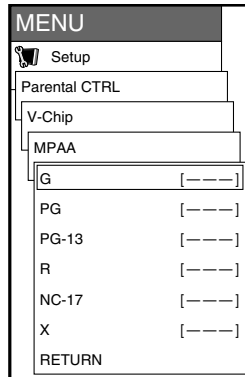
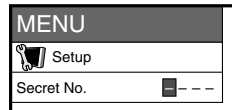
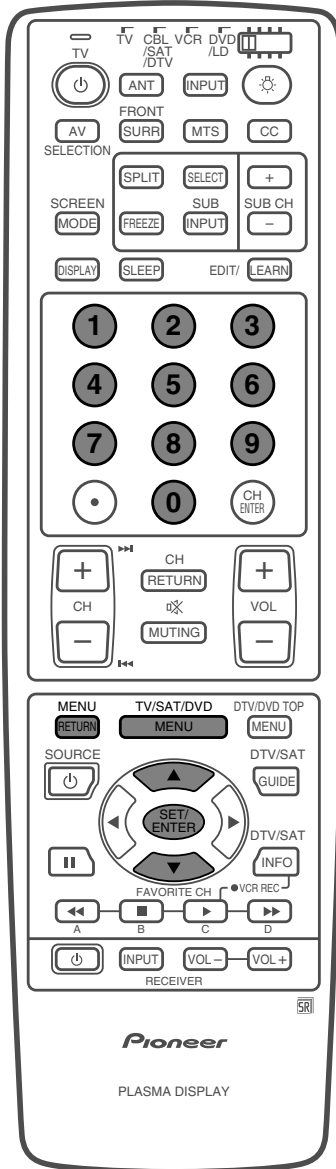

Voluntary movie rating system (MPAA)

- 1 Press **MENU**.
- 2 Press **▲/▼** to select "Setup", and then press **SET/ENTER**.
 - Secret number setting menu displays only when "Secret No." is set. (See page 52.)
 - V-CHIP and Status will not be selectable from the menu if you do not first configure your secret number. (See page 52.)
- 3 Enter your 4-digit secret number with **0–9** to cancel the "Secret No." when you set it.
- 4 Press **▲/▼** to select "Parental CTRL", and then press **SET/ENTER**.
- 5 Press **▲/▼** to select "V-Chip", and then press **SET/ENTER**.
- 6 Press **▲/▼** to select "MPAA", and then press **SET/ENTER**.
- 7 Press **▲/▼** to select the desired item, and then press **SET/ENTER** to select "BLOCK".
 - The setting automatically enters "BLOCK" for any ratings below your selection.
 - If Status is not set to "On" the configuration settings will not work. (See page 53.)
- 8 Press **MENU** to exit the menu.

NOTE

- Return to the previous menu by pressing **MENU RETURN**.

TV Parental Guidelines (TV Guidelines)

- 1 Press **MENU**.
- 2 Press **▲/▼** to select "Setup", and then press **SET/ENTER**.
 - Secret number setting menu displays only when "Secret No." is set. (See page 52.)
 - V-CHIP and Status will not be selectable from the menu if you do not first configure your secret number. (See page 52.)
- 3 Enter your 4-digit secret number with **0–9** to cancel the "Secret No." when you set it.
- 4 Press **▲/▼** to select "Parental CTRL", and then press **SET/ENTER**.
- 5 Press **▲/▼** to select "V-Chip", and then press **SET/ENTER**.
- 6 Press **▲/▼** to select "TV Guidelines", and then press **SET/ENTER**.
- 7 Press **▲/▼** to select the desired item, and then press **SET/ENTER** to select "BLOCK".
 - The setting automatically enters "BLOCK" for any ratings below your selection.
 - When "Block Content" is selected, its menu displays as shown left.
 - If Status is not set to "On" the configuration settings will not work. (See page 53.)
- 8 Press **MENU** to exit the menu.

NOTE

- Return to the previous menu by pressing **MENU RETURN**.

Useful adjustment settings

Canadian Rating Systems

- The TV rating systems in Canada are based on the Canadian Radio-Television and Telecommunications Commission (CRTC) policy on violence in television programming.
- While violence is the most important content element to be rated, the structure developed takes into consideration other program content like language, nudity, sexuality and mature themes.
- When setting the V-CHIP on the Canadian system you can chose either the Canadian English ratings or the Canadian French ratings.

Canadian English ratings

Rating		Description
Age	E	Exempt: Includes news, sports, documentaries and other information programming; talk shows, music videos, and variety programming.
	C	Children: Intended for younger children under the age of 8 years. Pays careful attention to themes that could threaten their sense of security and well-being.
	C8+	Children over 8 years old: Contains no portrayal of violence as the preferred, acceptable, or only way to resolve conflict; nor encourage children to imitate dangerous acts which they may see on the screen.
	G	General: Considered acceptable for all age groups. Appropriate viewing for the entire family, contains very little violence, physical, verbal or emotional.
	PG	Parental Guidance: Intended for a general audience, but may not be suitable for younger children (under the age of 8) because it could contain controversial themes or issues.
	14+	Over 14 Years: Could contain themes where violence is one of the dominant elements of the storyline, but it must be integral to the development of plot or character. Language usage could be profane and nudity present within the context of the theme.
	18+	Adults: Intended for viewers 18 years and older and might contain depictions of violence, which while related to the development of plot, character or themes, are intended for adult viewing. Could contain graphic language and portrayals of sex and nudity.

Canadian French ratings

Rating		Description
Age	E	Exempt programming.
	G	General: All ages and children, contains minimal direct violence, but may be integrated into the plot in a humorous or unrealistic manner.
	8ans +	General but inadvisable for young children: May be viewed by a wide public audience, but could contain scenes disturbing to children under eight who cannot distinguish between imaginary and real situations. Recommended for viewing with parent.
	13ans +	Over 13 years: Could contain scenes of frequent violent scenes and therefore recommended for viewing with parent.
	16ans +	Over 16 years: Could contain frequent violent scenes and intense violence.
	18ans +	Over 18 years: Only for adult viewing. Could contain frequent violent scenes and extreme violence.

Useful adjustment settings

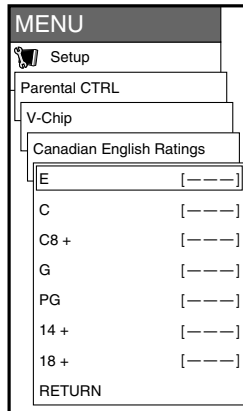
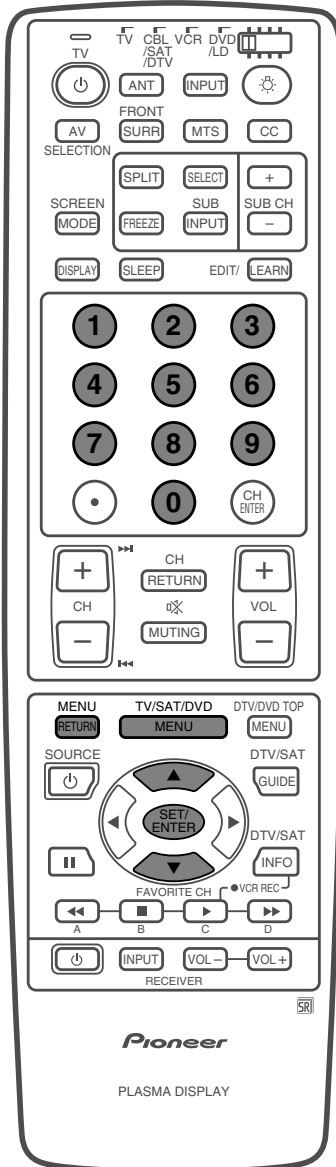

Canadian English ratings

- 1 Press **MENU**.
- 2 Press **▲/▼** to select "Setup", and then press **SET/ENTER**.
 - Secret number setting menu displays only when "Secret No." is set. (See page 52.)
 - V-CHIP and Status will not be selectable from the menu if you do not first configure your secret number. (See page 52.)
- 3 Enter your 4-digit secret number with **0–9** to cancel the "Secret No." when you set it.
- 4 Press **▲/▼** to select "Parental CTRL", and then press **SET/ENTER**.
- 5 Press **▲/▼** to select "V-Chip", and then press **SET/ENTER**.
- 6 Press **▲/▼** to select "Canadian English Ratings", and then press **SET/ENTER**.
- 7 Press **▲/▼** to select the desired item, and then press **SET/ENTER** to select "BLOCK".
 - The setting automatically enters "BLOCK" for any ratings below your selection.
 - If Status is not set to "On" the configuration settings will not work. (See page 53.)
- 8 Press **MENU** to exit the menu.

NOTE

- Return to the previous menu by pressing **MENU RETURN**.

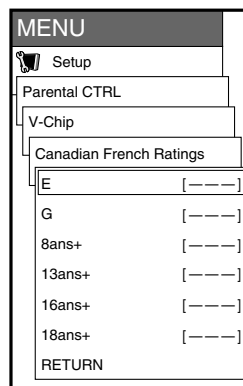

Canadian French ratings

- 1 Press **MENU**.
- 2 Press **▲/▼** to select "Setup", and then press **SET/ENTER**.
 - Secret number setting menu displays only when "Secret No." is set. (See page 52.)
 - V-Chip and Status will not be selectable from the menu if you do not first configure your secret number. (See page 52.)
- 3 Enter your 4-digit secret number with **0–9** to cancel the "Secret No." when you set it.
- 4 Press **▲/▼** to select "Parental CTRL", and then press **SET/ENTER**.
- 5 Press **▲/▼** to select "V-Chip", and then press **SET/ENTER**.
- 6 Press **▲/▼** to select "Canadian French Ratings", and then press **SET/ENTER**.
- 7 Press **▲/▼** to select the desired item, and then press **SET/ENTER** to select "BLOCK".
 - The setting automatically enters "BLOCK" for any ratings below your selection.
 - If Status is not set to "On" the configuration settings will not work. (See page 53.)
- 8 Press **MENU** to exit the menu.

NOTE

- Return to the previous menu by pressing **MENU RETURN**.

Useful adjustment settings

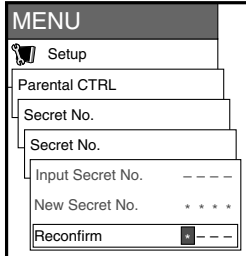
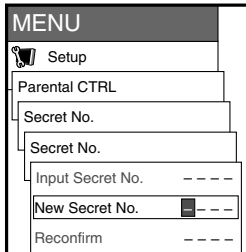
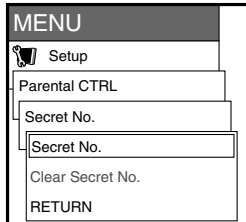
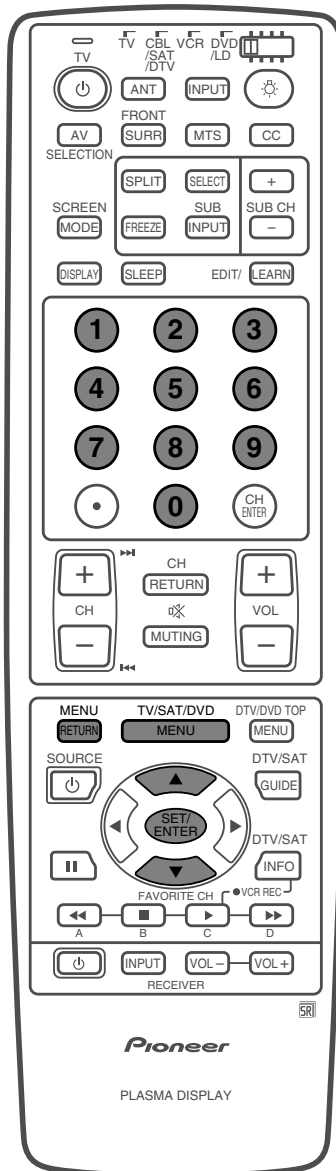

Secret number setting menu

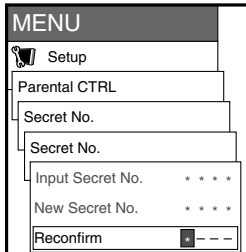
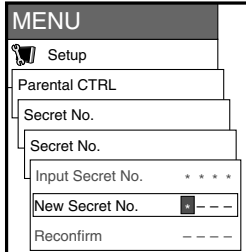
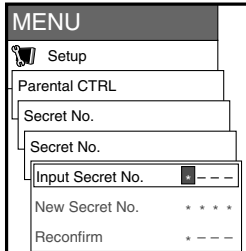
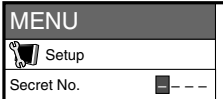

Secret number setting for parental control (AV mode only)

Allows you to use a secret number to protect certain settings from being accidentally changed.

Setting a secret number

- 1 Press **MENU**.
- 2 Press **▲/▼** to select "Setup", and then press **SET/ENTER**.
- 3 Press **▲/▼** to select "Parental CTRL", and then press **SET/ENTER**.
- 4 Press **▲/▼** to select "Secret No.", and then press **SET/ENTER**.
- 5 Repeat step 4 again.
- 6 Enter the 4-digit number as a secret number using **0–9**.
- 7 And enter the same 4-digit number on the "Reconfirm" screen as in step 6 to confirm.
 - "New Secret No. is registered." displays.
- 8 Press **MENU** to exit the menu.

NOTE

- Return to the previous menu by pressing **MENU RETURN**.

Changing the secret number

Allows you to change your current secret number.

- 1 Press **MENU**.
- 2 Press **▲/▼** to select "Setup", and then press **SET/ENTER**.
 - Secret number setting menu displays.
- 3 Enter your 4-digit secret number with **0–9** to cancel the "Secret No." when you set it.
- 4 Press **▲/▼** to select "Parental CTRL", and then press **SET/ENTER**.
- 5 Press **▲/▼** to select "Secret No.", and then press **SET/ENTER**.
- 6 Repeat step 5 again.
- 7 Enter the Old 4-digit number you have set using **0–9**.
- 8 Enter the New 4-digit number you have set using **0–9**.
- 9 And enter the same 4-digit number on the "Reconfirm" screen as in step 8 to confirm.
 - "New Secret No. is registered." displays.
- 10 Press **MENU** to exit the menu.

NOTE

- Return to the previous menu by pressing **MENU RETURN**.

Useful adjustment settings

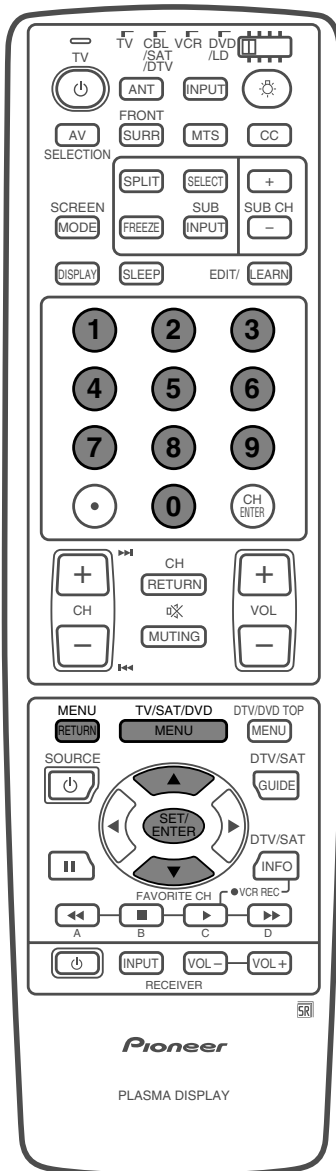

Secret number setting menu

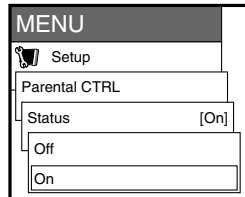
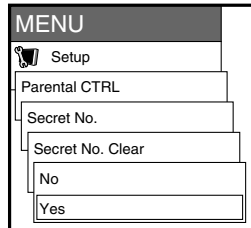
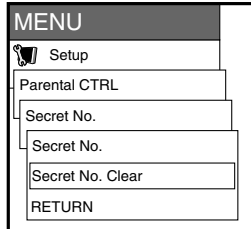
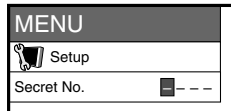

Clearing the secret number

Allows you to clear your secret number.

- 1 Press **MENU**.
- 2 Press **▲/▼** to select "Setup", and then press **SET/ENTER**.
 - Secret number setting menu displays.
- 3 Enter your 4-digit secret number with **0–9** to cancel the "Secret No." when you set it.
 - Setup menu displays.
- 4 Press **▲/▼** to select "Parental CTRL", and then press **SET/ENTER**.
- 5 Press **▲/▼** to select "Secret No.", and then press **SET/ENTER**.
- 6 Press **▲/▼** to select "Secret No. Clear", and then press **SET/ENTER**.
- 7 Press **▲/▼** to select "Yes", and then press **SET/ENTER**.
 - Your secret number is cleared.
- 8 Press **MENU** to exit the menu.

NOTE

- See page 52 for re-registering with a new secret number, after being cleared.
- Return to the previous menu by pressing **MENU RETURN**.
- **As a precautionary measure, make a note of your secret number and keep it in a familiar place. If you lose or forget your secret number, initialize the Plasma Display System to return all settings except for the TV channel settings to factory preset values. (See page 67.)**

Setting parental control status

Used to enable or disable the parental control function.

- 1 Press **MENU**.
- 2 Press **▲/▼** to select "Setup", and then press **SET/ENTER**.
 - Secret number setting menu displays only when "Secret No." is set. (See page 52.)
 - V-CHIP and Status will not be selectable from the menu if you do not first configure your secret number. (See page 52.)
- 3 Enter your 4-digit secret number with **0–9** to cancel the "Secret No." when you set it.
- 4 Press **▲/▼** to select "Parental CTRL", and then press **SET/ENTER**.
- 5 Press **▲/▼** to select "Status", and then press **SET/ENTER**.
- 6 Press **▲/▼** to select "On" or "Off", and then press **SET/ENTER**.
 - Select "On" to enable and "Off" to disable Parental CTRL.
- 7 Press **MENU** to exit the menu.

NOTE

- If the secret number is cleared the Status setting automatically sets to "Off". V-CHIP and Status will not be selectable from the menu.
- Return to the previous menu by pressing **MENU RETURN**.

Useful adjustment settings

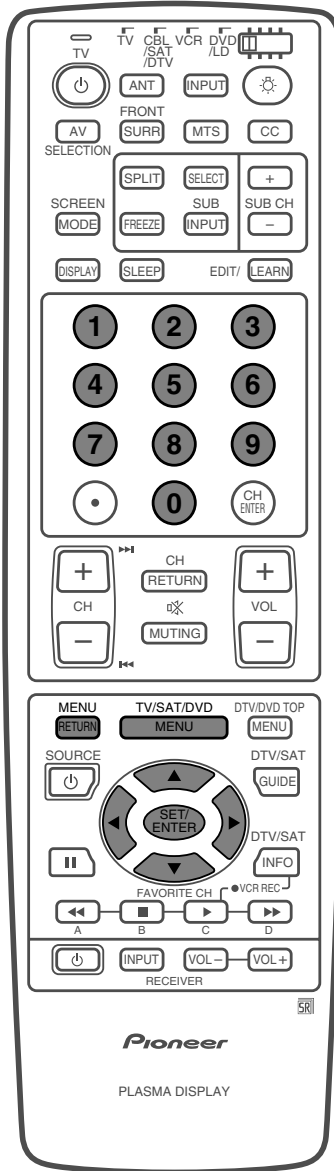

How to temporarily release the V-CHIP BLOCK

- The V-CHIP BLOCK is working and censors a broadcast, “V-CHIP HAS BEEN ACTIVATED.” displays.

- 1 Press **SET/ENTER** while the V-CHIP is working and then the secret number. setting menu displays.
- 2 Enter your 4-digit secret number with **0 – 9** and then press **SET/ENTER**. At this time V-CHIP BLOCK temporarily releases.

Reactivating the temporarily released V-CHIP BLOCK

- You can reactivate the temporarily released V-CHIP BLOCK as shown below.

Method 1:

Select Status setting (“On” or “Off”) from the Parental CTRL menu to reactivate BLOCK.

Method 2:

Select V-CHIP setting (“MPAA”, “TV Guidelines”, “Canadian English Ratings” or “Canadian French Ratings”) from the Parental CTRL to reactivate BLOCK.

Method 3:

Switch off the Media Receiver power.

NOTE

- Performing any of the three above will activate the V-CHIP BLOCK.

Useful features

Multiscreen functions

Allows you to display two pictures on the screen at one time.

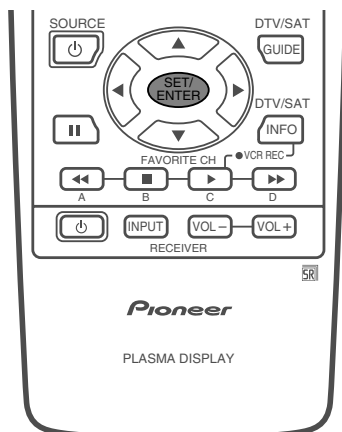
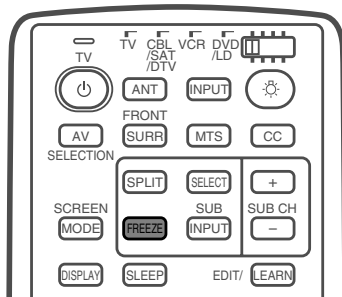
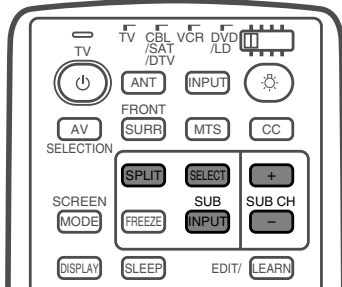

Dual screen

You can display two same-sized pictures except when inputting from a PC INPUT terminal.

1 Press **SPLIT**.

- Dual screen displays and a selected input source image displays.

2 Press **SELECT** to set either screen to be active.

- “♪” displays on the active screen, which has sound output.

3 Press **SUB CH +/-** to select another channel on the inactive screen.

4 Press **SUB INPUT** to select another input source on the inactive screen.

- A selected image displays.

5 Press **SPLIT** to exit dual screen.

NOTE

- This function does not work under the following input conditions:
 - ① PC INPUT mode,
 - ② Two pictures from the same source (e.g. INPUT 1 and INPUT 1),
 - ③ Images from a high frequency signal source.
- When this function is not available, “No dual screen display available” will display.

Picture and still image

You can display two same-sized pictures when inputting from a AV source.

1 Press **FREEZE**.

- A moving image displays on the left screen and a still image displays on the right screen. The still image is one frame captured from a moving image at the moment you press **FREEZE**.

2 Update the still image by pressing **SET/ENTER**.

- Each time you press **SET/ENTER**, the image on the right screen updates.

3 Press **FREEZE** to exit still image.

NOTE

- This function does not work under the following input conditions:
 - ① PC INPUT mode,
 - ② Images from a high frequency signal source.
- When this function is not available, “No still image display available.” will display.

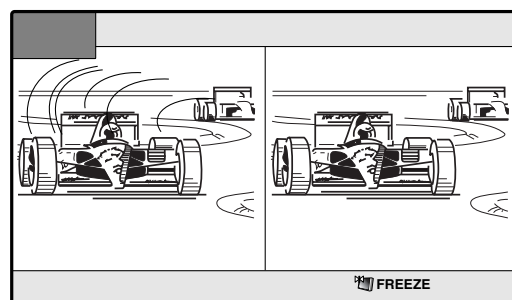

Useful features

Learning remote control function

You can operate the connected AV products (AV Receiver, Cable Box, SAT tuner, DTV, VCR, DVD, LD) using the learning function for your remote control unit. This remote control unit has a function that can memorize each remote control code.

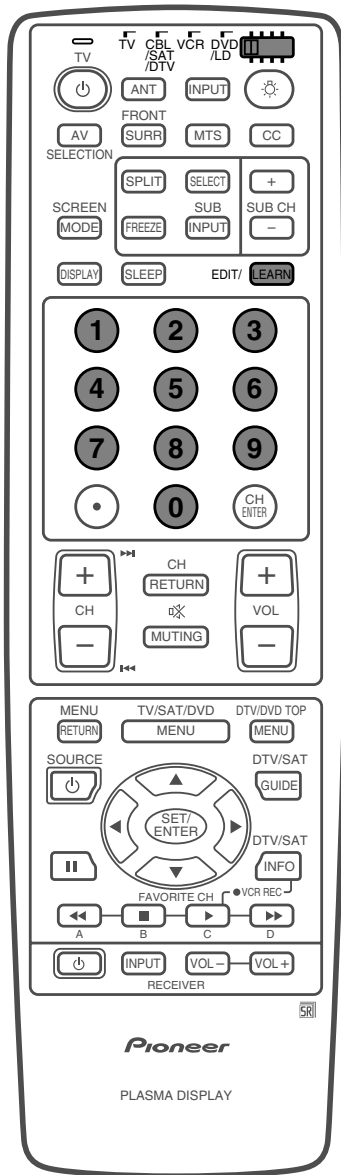

2 to 5 cm (0.8 to 2.0 inch)

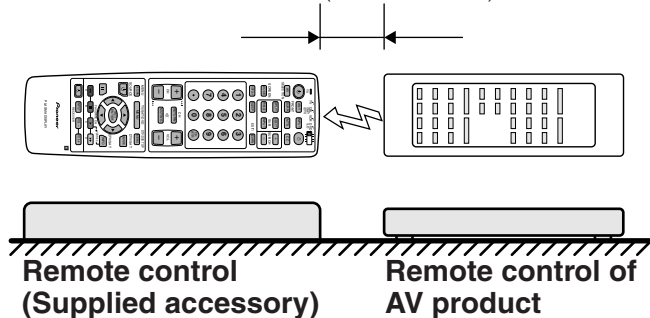

Presetting manufacture codes

- 1** Slide the **Mode switch** to match the device to which you want to preset the remote control signal.
- 2** Press **EDIT/LEARN** and **1** at the same time.
 - LED flashes continuously.
- 3** Press **0 – 9** to enter the manufacture code. (See page 57.)
 - Preset mode is finished once the LED no longer lights up.

NOTE

- To stop the EDIT mode in the middle, press **EDIT/LEARN** once more.
- If **Mode switch** is switched while in EDIT mode, EDIT mode will be canceled.
- If there is no operation for over 1 minute running, exit this mode.
- When you enter a code that is not listed, LED flashes quickly.
- If the table on page 57 does not include your desired manufacturer or the remote control does not work, you can make the memory learn its signal by the learn mode.
- The initial mode is "00" (PIONEER).

Learning the remote control

- 1** Be sure to slide the **Mode switch** to match the device whose remote control signal you want to be learned.
- 2** Press **EDIT/LEARN** and **2** at the same time.
 - LED flashes continuously.
- 3** Press a button for you want to learn.
 - Refer to the assigning buttons to functions on each page.(See page 58 to 63.)
 - The LED changes from lit up to flashing state.
 - When the learn mode is finished, LED lights up once and returns to the learn mode (LED flashes continuously).
- 4** To exit learn mode, press **EDIT/LEARN**.

NOTE

- To stop the EDIT mode in the middle, press **EDIT/LEARN** once more.
- If **Mode switch** is switched while in EDIT mode, EDIT mode will be canceled.
- If there is no operation for over 1 minute running, exit this mode.
- If **TV** is pressed over 2 seconds running (LED flashes continuously, step 2 above), the learning codes of the current **Mode switch** position clear, changing back to preset manufacturer codes. In this case, the LED turns off after 2 seconds exiting learning mode.

Useful features

Manufacture codes

	CABLE/SAT/ DTV	VCR	DVD/LD
00	PIONEER1 (CABLE)	PIONEER	PIONEER (DVD)
01	PIONEER2 (CABLE)	FISHER	Panasonic (DVD)
02	JERROLD1 (CABLE)	FISHER	SAMSUNG (DVD)
03	JERROLD2 (CABLE)	FISHER	SONY (DVD)
04	JERROLD3 (CABLE)	GOLDSTAR	TOSHIBA (DVD)
05	JERROLD4 (CABLE)	HITACHI	JVC (DVD)
06	JERROLD5 (CABLE)	HITACHI2	
07	JERROLD6 (CABLE)	HITACHI3	
08	JERROLD7 (CABLE)	MAGNAVOX2	
09	JERROLD8 (CABLE)	MITSUBISHI	
10	JERROLD9 (CABLE)	MITSUBISHI2	
11	JERROLD10 (CABLE)	MITSUBISHI3	
12	S. A. 1 (CABLE)	MITSUBISHI4	
13	S. A. 2 (CABLE)	MITSUBISHI5	
14	S. A. 3 (CABLE)	MITSUBISHI6	
15	S. A. 4 (CABLE)	Panasonic	
16	ZENITH1 (CABLE)	Panasonic2	
17	ZENITH2 (CABLE)	Panasonic3	
18	ZENITH3 (CABLE)	RCA	
19		RCA2	
20	PIONEER (SAT)	RCA3	PIONEER (LD)
21	RCA1 (SAT)	SANYO	KENWOOD (LD)
22	RCA2 (SAT)	SANYO2	PANASONIC1 (LD)
23	SONY (SAT)	SANYO3	PANASONIC2 (LD)

	CABLE/SAT/ DTV	VCR	DVD/LD
24		SHARP	PHILIPS (LD)
25		SHARP2	RCA (LD)
26		SHARP3	SONY (MDP)
27		SONY (BETA)	SONY (LD)
28		SONY (VHS)	
29		SONY (8 mm)	
30	PIONEER (DTV)	TOSHIBA	
31	SHARP (DTV)	JVC	
32		JVC2	
33		JVC3	
34		JVC4	
35		JVC5	
36		ZENITH	

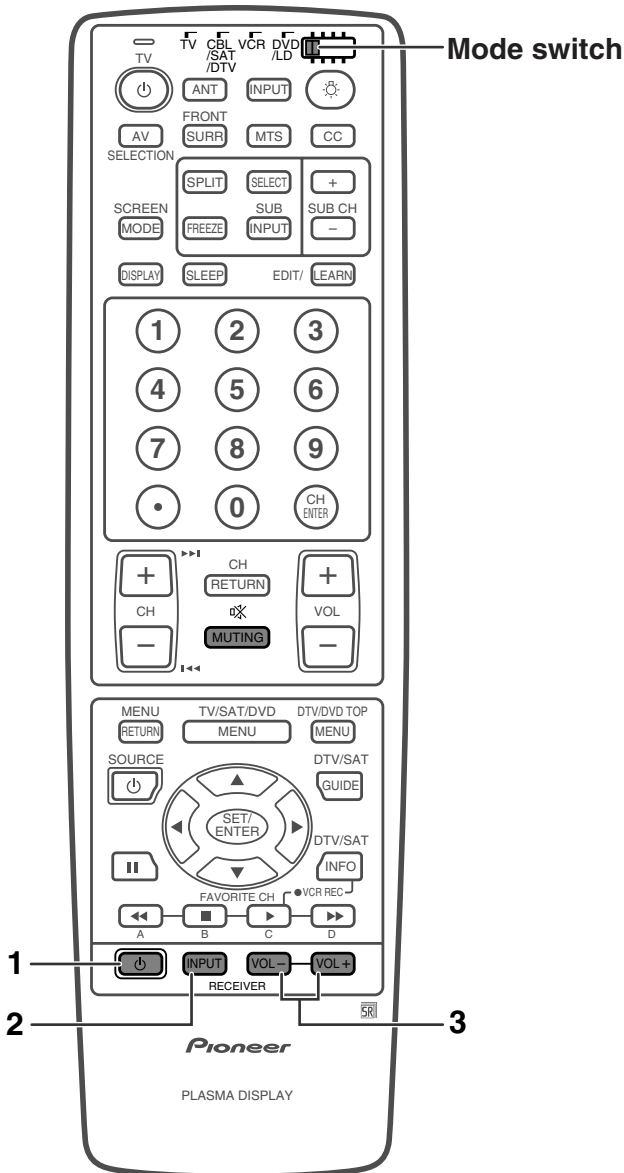

Using the TV remote control unit to control other device

Receiver control buttons

When a Pioneer receiver is connected to the display, the receiver can operate using buttons **1** to **3**.

When another non-Pioneer receiver is connected to the display, the signals for **1** to **3** must first be learned before operating. (See page 56.)

- 1 RECEIVER** (STANDBY/ON)
Turns receiver power on and off.
- 2 RECEIVER INPUT**
Selects the input source connected to the receiver.
- 3 RECEIVER VOL +/-**
Adjusts receiver volume level. Press **VOL +** to increase the volume and **VOL -** to decrease it.

NOTE

- **(RECEIVER) MUTING**
Allows remote unit to learn receiver's mute signal. Use this button when the mode switch is set to something other than TV.
- The color-highlighted buttons on the remote control can learn the control signal from another device's remote control.

Useful features

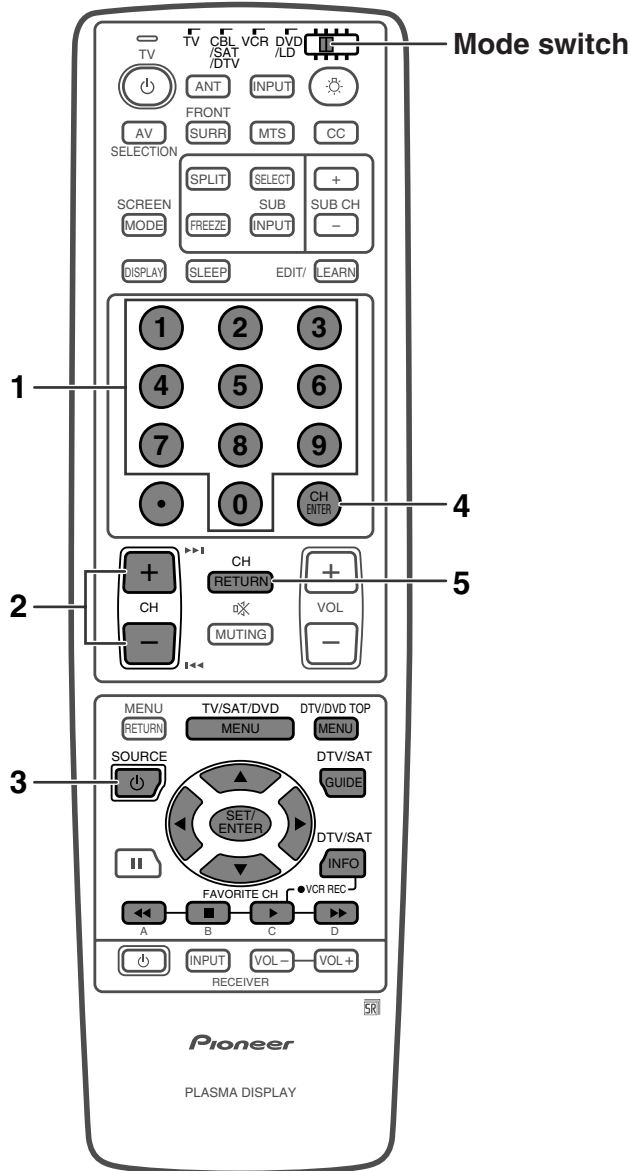

Cable control buttons

When the **Mode switch** is set to CBL/SAT/DTV the cable converter connected to the display can operate using **1 to 5**.

Cable converters made by other manufacturers and not preset can also operate using the remote control unit if **1 to 5** have learned the functions. (See page 56.)

1 0 - 9

Press a button (or buttons) that corresponds to the channel that you want to watch.

2 CH +/-

Press **CH +** or **CH -** to tune in a higher or lower channel.

3 SOURCE

Turns the cable converter power on and off.

4 CH ENTER *

Fix the selected channel with the direct channel selection buttons.

5 CH RETURN *

Press to switch between the current channel and the channel you were watching immediately before.

* Some manufacturers do not preset **CH ENTER** and **CH RETURN**. Use these buttons to learn if necessary.

NOTE

- CABLE, SAT and DTV cannot be selected at the same time.
- The color-highlighted buttons on the remote control can learn the control signal from another device's remote control.

Useful features

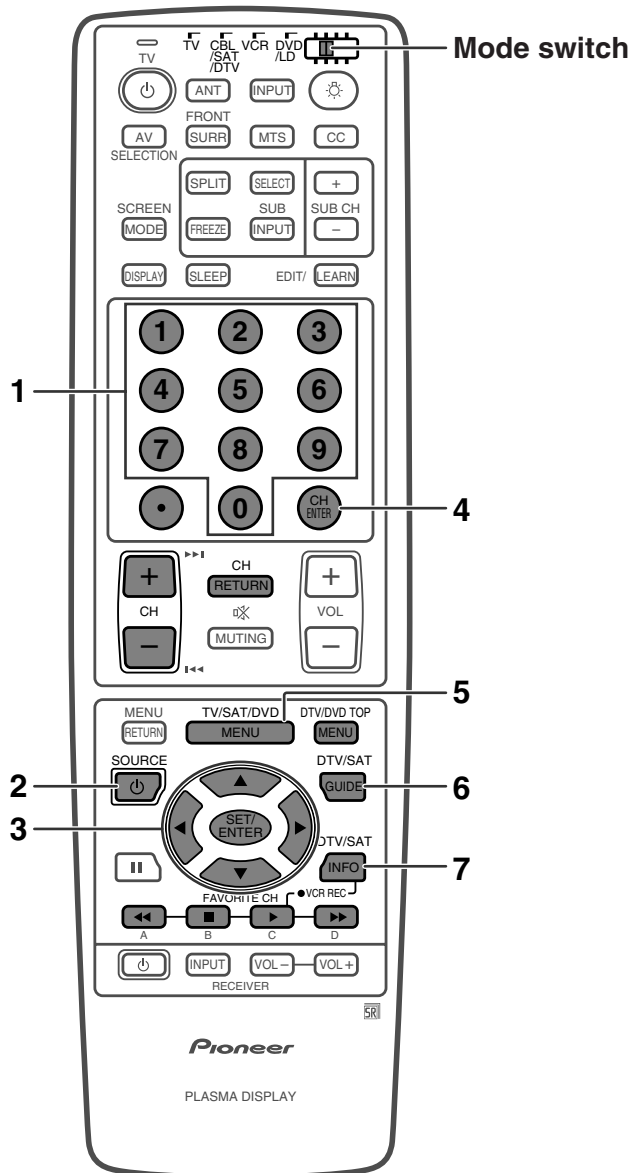

SAT control buttons

When the SAT is preset by the learning remote control function, the remote control unit buttons will function as shown below.

- When the **Mode switch** is set to CBL/SAT/DTV, satellite broadcast tuners made by other manufacturers and not preset can also operate with the remote control unit if **1** to **7** have learned the functions. (See page 56.)
- 0 - 9**
Press a button (or buttons) that corresponds to the channel that you wish to watch.
 - SOURCE**
Turns the Satellite broadcast tuner power on and off.
 - SET/ENTER, ▲/▼/◀/▶**
SET/ENTER: Press to activate the selected function.
▲/▼/◀/▶: Press the button to select items on the SAT GUIDE screen or SAT MENU screen.
 - CH ENTER**
Fix the selected channel with the direct channel selection buttons.
 - Use this button to learn if necessary.
 - SAT MENU**
When this button is pressed, the satellite broadcasting menu screen will display.
 - SAT GUIDE**
When this button is pressed, the satellite broadcasting guide screen will display.
 - SAT INFO**
When this button is pressed, information on satellite broadcasting will display.
 - Use this button to learn if necessary.

NOTE

- CABLE, SAT and DTV cannot be selected at the same time.
- The color-highlighted buttons shown in the figure at left can learn the control signal from another device's remote control.

Useful features

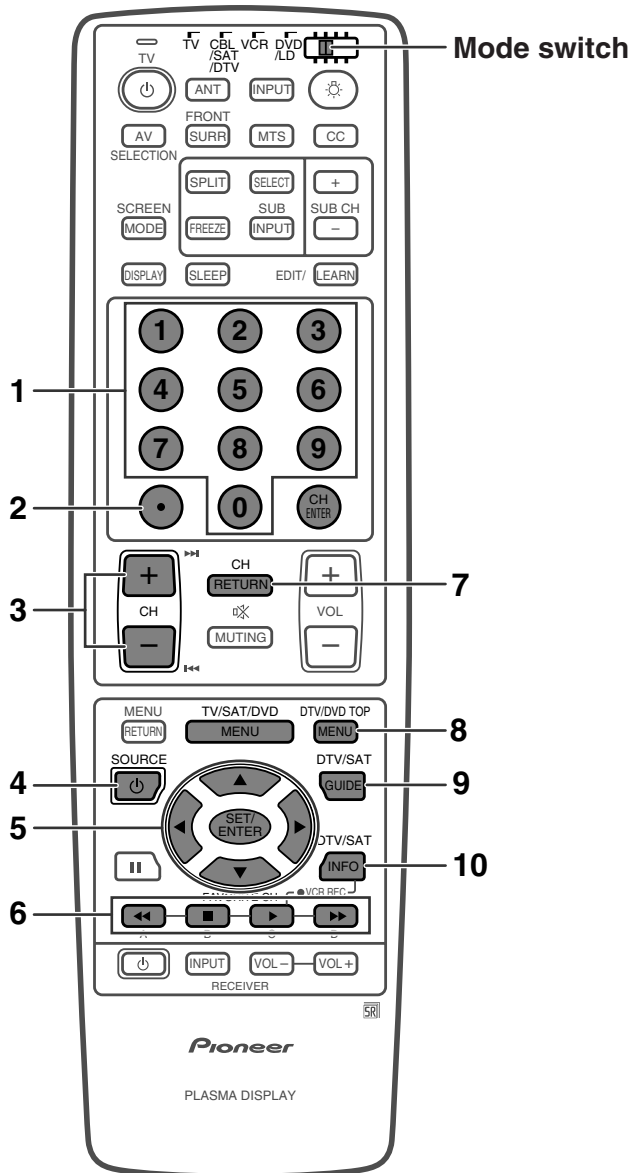

DTV control buttons

For viewing DTV broadcasts, a digital tuner (commercially available) is necessary.

When the **Mode switch** is set to CBL/SAT/DTV, the remote control unit buttons will function as shown below.

- Operate the tuner using **1 to 10**.

1 0 – 9

Press a button (or buttons) that corresponds to the channel that you want to watch.

2 • (DOT)

Used for channel selection.

3 CH +/-

Press **CH +** or **CH –** to tune in a higher or lower channel.

4 SOURCE

Turns the digital tuner on and off.

5 SET/ENTER, ▲/▼/◀/▶

SET/ENTER: Press to activate the selected function.

▲/▼/◀/▶: Press the button to select items on the DTV MENU screen.

6 FAVORITE CH/Colored (blue/green/red/yellow)

FAVORITE CH: Used for making FAVORITE CH settings with the digital tuner.

Blue/green/red/yellow: Used to make selections from the digital tuner menu.

7 CH RETURN

Press to switch between the current channel and the channel you were watching immediately before.

8 DTV MENU

When this button is pressed, the DTV menu screen will display.

9 DTV GUIDE

When this button is pressed, the DTV guide screen will display.

10 DTV INFO

When this button is pressed, information on DTV will display.

NOTE

- CABLE, SAT and DTV cannot be selected at the same time.
- The color-highlighted buttons on the remote control can learn the control signal from another device's remote control.

Useful features

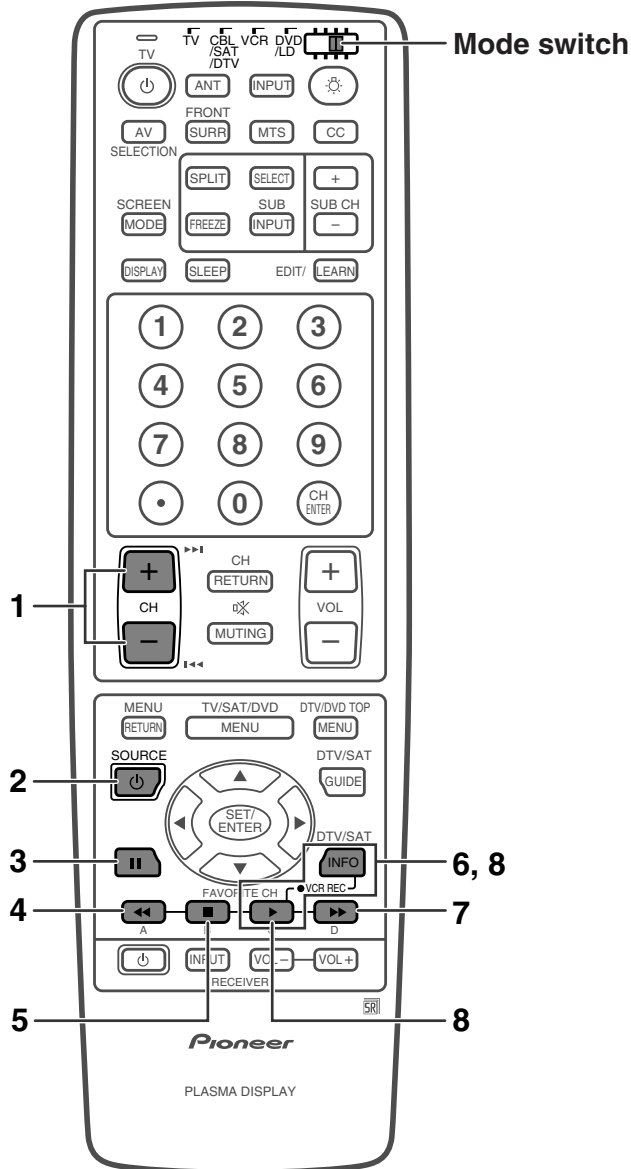

VCR control buttons

When the VCR is preset by the learning remote control function, the remote control unit button will function as follows when the **Mode switch** of the remote control unit is set to VCR.

- When the input selector button having the same number as the input terminal connecting the VCR is pressed, the VCR can operate using **1** to **8**.
- VCR made by other manufacturers and not preset can also operate using the remote control unit if **1** to **8** have learned the functions. (See page 56.)

- 1 CH +/-**
Press to select the channel of the TV tuner on the VCR.
- 2 SOURCE**
Turns the power of the VCR on and off.
- 3**
Set pauses and still pictures.
- 4**
Rewinds the tape and allows picture search.
- 5**
Stop the tape transport.
- 6, 8 VCR REC**
Press both buttons at the same time to start recording.
- 7**
Rapidly advances the tape and allows picture search.
- 8**
Selects playback.

NOTE

- The color-highlighted buttons on the remote control can learn the control signal from another device's remote control.

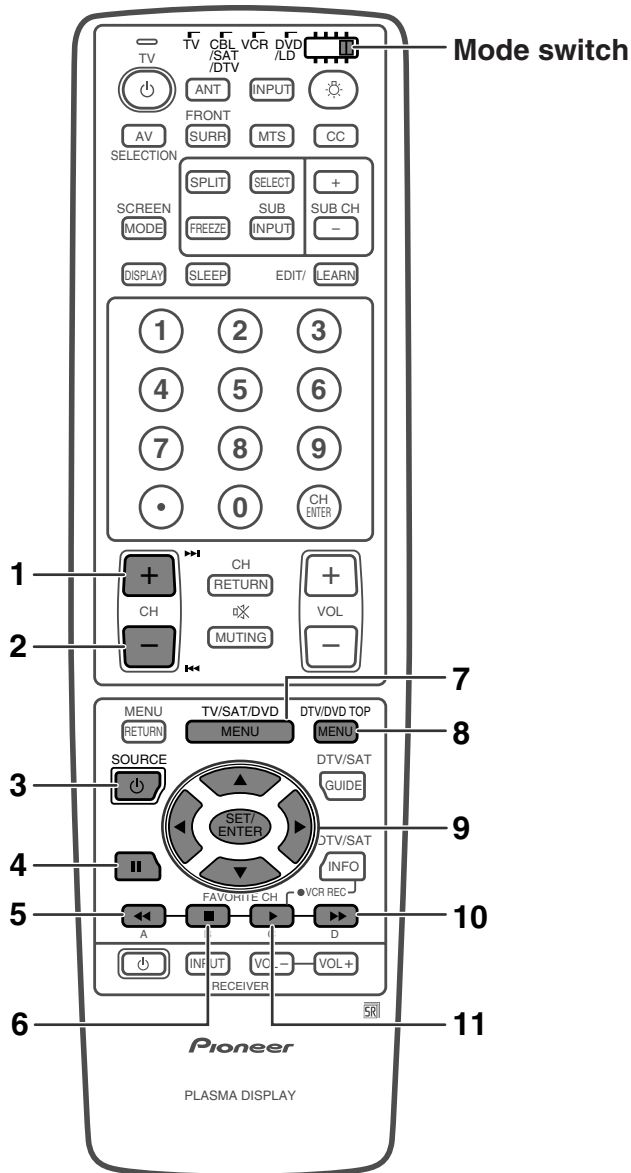

DVD/LD control buttons

When the DVD/LD is preset by the learning remote control function, the remote control unit button will function as follows when the **Mode switch** of the remote control unit is set to DVD/LD.

- When the input selector button having the same number as the input terminal connecting a DVD player or LD player is pressed, these players can operate using **1** to **11**. (**7** to **9** are for DVD players only.)
- DVD/LD players made by other manufacturers and not preset can also operate using the remote control unit if **1** to **11** have learned the functions. (See page 56.)



- 1** Pressing quickly once takes you to the start of the next chapter. Each time you press it, you move ahead to the start of the next chapter.
- 2** Pressing quickly once takes you to the start of the chapter currently playing. Each time you press it, you move back to the start of the previous chapter.
- 3** **SOURCE** Turns the power of the DVD/LD player on and off.
- 4** Set pauses and still pictures.
- 5** Continue pressing to go backward.
- 6** Playback stops when pressing once. With some DVD/LD players, pressing the button twice may open the disc tray.
- 7** **DVD MENU (DVD only)** When this button is pressed, the DVD menu will display.
- 8** **DVD TOP MENU (DVD only)** When this button is pressed, the DVD top menu will display.
- 9** **SET/ENTER, ▲/▼/◀/▶ (DVD only)**
 SET/ENTER: Press to activate the selected function.
 ▲/▼/◀/▶: Press the button to select items on the DVD MENU screen.
- 10** Continue pressing for fast forward.
- 11** Selects playback.

NOTE

- DVD and LD cannot be selected at the same time.
- The color-highlighted buttons on the remote control can learn the control signal from another device's remote control.

Appendix

Troubleshooting

Problem	Possible Solution
<ul style="list-style-type: none"> No power. 	<ul style="list-style-type: none"> Make sure the Plasma Display and the Media Receiver are connected correctly. (See page 6.) Check if you pressed TV  on the remote control unit. (See page 14.) If the indicator on the Plasma Display lights up red, press TV . Is the power cord disconnected? (See page 13.) Has the main power been turned on? (See page 14.)
<ul style="list-style-type: none"> Unit cannot be operated. 	<ul style="list-style-type: none"> External influences such as lightning, static electricity, may cause improper operation. In this case, operate the unit after first turning on the power of the Plasma Display and the Media Receiver, or unplugging the power cord and replugging it in after 1 or 2 minutes.
<ul style="list-style-type: none"> Remote control unit does not operate. 	<ul style="list-style-type: none"> Is the Mode switch set correctly? Slide it to the TV setting position. Are batteries inserted with polarity (+, -) aligned? (See page 8.) Are batteries worn out? (Replace with new batteries.) Are you using it under strong or fluorescent lighting? Is a fluorescent light illuminated near the remote control sensor?
<ul style="list-style-type: none"> Picture is cut off/with sidebar screen. 	<ul style="list-style-type: none"> Is the image position correct? (See pages 22 and 41.) Are screen mode adjustments such as picture size made correctly? (See page 45.)
<ul style="list-style-type: none"> Strange color, light color, dark or color misalignment. 	<ul style="list-style-type: none"> Adjust the picture tone. (See pages 27 to 30.) Is the room too bright? The picture may look dark in a room that is too bright. Check the input signal setting. (See page 43.)
<ul style="list-style-type: none"> Power is suddenly turned off. 	<ul style="list-style-type: none"> Is the sleep timer set? (See page 46.) Check the power control setting. (See pages 32 and 33.) The unit's internal temperature has increased. Remove any objects blocking vent or clean. (See page 5.)
<ul style="list-style-type: none"> No picture. 	<ul style="list-style-type: none"> Is connection to other components correct? (See pages 34 to 39.) Has setup been done correctly after connection? (See page 43.) Is the correct input selected? (See page 43.) Is a non-compatible signal being input? (See page 65.) Is picture adjustment correct? (See pages 27 to 30.)

Warning	Problem with Plasma Display System	Possible Solution
E01	<ul style="list-style-type: none"> System cable connection 	<ul style="list-style-type: none"> System cables are not properly connected. Check that all system cables are connected properly. (See page 6.)
E04	<ul style="list-style-type: none"> Abnormal internal temperature 	<ul style="list-style-type: none"> The internal temperature of the Plasma Display is abnormally high. Check the location the System is installed. (See page 5.)
E06	<ul style="list-style-type: none"> Abnormal internal signaling or circuit operation of the Plasma Display 	<ul style="list-style-type: none"> Turn off the power once and turn it on again. (See page 14.)

Please check to see if a warning is displayed on the screen. If the problem still cannot be solved please consult the dealer where this unit was purchased.

Appendix

Computer compatibility chart

Resolution	Frequency	Remarks
640 × 400	85 Hz	
720 × 400	70 Hz	
	85 Hz	
640 × 480	60 Hz	
	65 Hz	Macintosh 13" (67 Hz)
	72 Hz	
	75 Hz	
	85 Hz	
800 × 600	56 Hz	
	60 Hz	
	72 Hz	
	75 Hz	
	85 Hz	
832 × 624	74.5 Hz	Macintosh 16"
1024 × 768	60 Hz	
	70 Hz	
	75 Hz	Macintosh 19"
	85 Hz	
1280 × 768	60 Hz	

Apple and Macintosh are registered trademarks of Apple Computer, Inc.
Microsoft is a registered trademark of Microsoft Corporation.
DDC is a registered trademark of Video Electronics Standards Association.
Power Management is a registered trademark of Sun Microsystems, Inc.
VGA and XGA are registered trademarks of International Business Machines Co., Inc.

Appendix

Specifications

Item	50" Plasma Display, Model: PDP-503PU	43" Plasma Display, Model: PDP-433PU
Number of Pixels	1280 × 768 pixels	1024 × 768 pixels
Audio Amplifier	12 W + 12 W (1 kHz, 10 %, 8 Ω)	12 W + 12 W (1 kHz, 10 %, 8 Ω)
Surround System	SRS/FOCUS/SRS + FOCUS	SRS/FOCUS/SRS + FOCUS
Power Requirement	120 V AC, 60 Hz, 370 W (0.6 W Standby)	120 V AC, 60 Hz, 318 W (0.6 W Standby)
Dimensions	1218 (W) × 714 (H) × 98 (D) mm (47 ³¹ / ₃₂ (W) × 28 ¹ / ₈ (H) × 3 ⁷ / ₈ (D) inch)	1070 (W) × 630 (H) × 98 (D) mm (42 ¹ / ₈ (W) × 24 ¹³ / ₁₆ (H) × 3 ⁷ / ₈ (D) inch)
Weight	38.9 kg (85.8 lbs.)	31.5 kg (69.4 lbs.)
Accessories	Power cord, Cleaning cloth, Three speed clamps, Three bead bands, Warranty card	Power cord, Cleaning cloth, Three speed clamps, Three bead bands, Warranty card

Item		Media Receiver, Model: PDP-R03U	
Reception System		American TV standard NTSC system	
TV Function	Circuit type		Video signal detection PLL full synchronous detection, PLL digital synthesizer system
	Tuner	VHF/UHF	VHF 2–13ch, UHF 14–69ch
		CATV	1–125ch
Audio multiplex		BTSC system	
Terminals	Rear	INPUT 1	S-VIDEO in, AV in, COMPONENT in
		INPUT 2	S-VIDEO in, AV in
		INPUT 3	S-VIDEO in, AV in, COMPONENT in, RGB in
		Antenna	75 Ω UNBAL, F Type for VHF/UHF/CATV in
	Front	INPUT 4	S-VIDEO, AV in
		PC	15 Pin mini D-Sub, Audio in
Monitor Out Terminal	Rear	S-VIDEO out, AV out, Audio (Variable, Fixed)	
OSD Language		English/French/Spanish	
Other Features		Picture & Picture, Still image, Dual Tuner System	
Power Requirement		120 V AC, 60 Hz, 40 W (0.2 W Standby)	
Dimensions		420 (W) × 70 (H) × 330 (D) mm (16 ⁹ / ₁₆ (W) × 2 ²⁵ / ₃₂ (H) × 13 (D) inch)	
Weight		4.4 kg (9.7 lbs.)	
Accessories		Power cord, Remote control unit, Two AA size batteries, System cable, Operating instruction	

- Design and specifications are subject to change without notice.

HOW TO SET THE FACTORY PRESETTINGS

Press and hold down **CLEAR** on the Media Receiver while it is in standby mode. Then press **STANDBY/ON** on the Plasma Display or **TV**  on the remote control unit to turn the Plasma Display System on. All setting items (except TV channel) return to the factory presetting.

NOTE

- Running the factory presetting operation also clears the secret number.

You can run the Auto Installation again by using the following steps.

- 1** Turn on the power of the Plasma Display and the Media Receiver.
- 2** Press **MENU**. (Make sure the menu screen displays.)
- 3** Press **▲/▼** to select "Setup".
- 4** Press **SET/ENTER**.

NOTE

- If the secret number setting screen displays, you need to enter your secret number.
- If you forget your secret number, refer to HOW TO SET THE FACTORY PRESETTINGS above.

- 5** Press **▲/▼** to select "Auto Installation".
- 6** Press **SET/ENTER**.

"Auto Installation completed" displays. After that, the screen changes to the TV mode.

The secret number is

--	--	--	--

NOTE

- As a precautionary measure, make a note of your secret number above, scissor it from this manual, and keep it in a familiar place.



*1 **SRS and the (●)[®] symbol are trademarks of SRS Labs, Inc.**
SRS technology is incorporated under license from SRS Labs, Inc.

*1 **FOCUS and the (●)[®] symbol are trademarks of SRS Labs, Inc.**
FOCUS technology is incorporated under license from SRS Labs, Inc.

NOTE

- Products above are a trademark or registered trademark of corporation.

Should this product require service in the U.S.A. and you wish to locate the nearest Pioneer Authorized Independent Service Company, or if you wish to purchase replacement parts, operating instructions, service manuals, or accessories, please call the number shown below.

8 0 0 - 4 2 1 - 1 4 0 4

Please do not ship your product to Pioneer without first calling the Customer Support Division at the above listed number for assistance.

Pioneer Electronics (USA) Inc.
Customer Support Division
P.O. BOX 1760, Long Beach,
CA 90801-1760, U.S.A.

For warranty information please see the Limited Warranty sheet included with your product.

Should this product require service in Canada, please contact a Pioneer Canadian Authorized Dealer to locate the nearest Pioneer Authorized Service Company in Canada.

Alternatively, please contact the Customer Satisfaction Department at the following address:

Pioneer Electronics of Canada, Inc.
Customer Satisfaction Department
300 Allstate Parkway, Markham, Ontario L3R OP2
(905)479-4411
1(877)283-5901

For warranty information please see the Limited Warranty sheet included with your product.

Si ce produit doit être réparé au Canada, veuillez vous adresser à un distributeur autorisé Pioneer du Canada pour obtenir le nom du Centre de Service Autorisé Pioneer le plus près de chez-vous. Vous pouvez aussi contacter le Service à la clientèle de Pioneer:

Pioneer Électroniques du Canada, Inc.
Service à la clientèle
300, Allstate Parkway, Markham, Ontario L3R OP2
(905)479-4411
1(877)283-5901

Pour obtenir des renseignements sur la garantie, veuillez vous reporter au feuillet sur la garantie restreinte qui accompagne le produit.

PIONEER CORPORATION

4-1, Meguro 1-Chome, Meguro-ku, Tokyo 153-8654, Japan

PIONEER ELECTRONICS [USA] INC.

P.O. BOX 1540, Long Beach, California 90801-1540, U.S.A.

PIONEER ELECTRONICS OF CANADA, INC.

300 Allstate Parkway, Markham, Ontario L3R OP2, Canada

PIONEER EUROPE NV

Haven 1087, Keetberglaan 1, B-9120 Melsele, Belgium TEL: 03/570.05.11

PIONEER ELECTRONICS AUSTRALIA PTY. LTD.

178-184 Boundary Road, Braeside, Victoria 3195, Australia, TEL: [03] 9586-6300

PIONEER ELECTRONICS DE MEXICO S.A. DE C.V.

San Lorenzo 1009 3er Piso Desp. 302 Col. Del Valle Mexico D.F. C.P. 03100 TEL: 5-688-52-90

Printed in Japan/Imprimé au Japon/Impreso en Japón

TINS-7552CEZZ

Free Manuals Download Website

<http://myh66.com>

<http://usermanuals.us>

<http://www.somanuals.com>

<http://www.4manuals.cc>

<http://www.manual-lib.com>

<http://www.404manual.com>

<http://www.luxmanual.com>

<http://aubethermostatmanual.com>

Golf course search by state

<http://golfingnear.com>

Email search by domain

<http://emailbydomain.com>

Auto manuals search

<http://auto.somanuals.com>

TV manuals search

<http://tv.somanuals.com>