

Operating Instructions



PLASMA TELEVISION

PDP-508XDA

PDP-428XDA

To use your plasma television for a long period of time

Cautions regarding screen burning

After-image lagging and screen burning

After-image lagging:

When characters, images or images of fixed patterns with very high luminance are displayed on a plasma television screen, even if displayed for a relatively short period of time, the image may remain on the screen due to the residual electric load of the panel. However, this is not a malfunction. This after-image lagging can be eliminated gradually by displaying moving images in full screen.

Burning:

When images like those described above are displayed continuously for a long period of time or repeatedly, a difference occurs between the luminance of the continuously displayed image and that of other portions of the screen, resulting in the image remaining on the screen due to burning. Please note that if this burning occurs, it may be difficult to completely restore the screen to the state prior to burning. **It should also be noted that this phenomenon tends to occur more easily soon after the product is purchased.**

Display examples susceptible to burning

- If programmes such as terrestrial digital broadcasts having a screen size of 4:3 are viewed repeatedly, the normal display area other than the black bands on the left and right sides of the screen becomes susceptible to burning.
- If cinema-size images are repeatedly viewed in their original size, the normal display area other than the black bands at the top and bottom of the screen becomes susceptible to burning.
- If programmes containing a time display or station name displayed on the screen are viewed for a long period of time (or viewed repeatedly), the displayed characters may be easily burned onto the screen.
- If images of fixed patterns such as those of personal computer displays or game software are displayed for a long period of time, the patterns may be easily burned onto the screen.



Preventing burning

It is recommended to use your plasma television while paying attention to the matters described below, particularly when using the product soon after it has been purchased, to prevent screen burning.

- Avoid using the product while displaying images susceptible to burning as described above whenever possible.
- Use the product with the Orbiter function set to "On" (⇒ see *Useful adjustment settings: "Orbiter"*).
- When **viewing programmes broadcast** in a 4:3 or cinema screen size, switch the screen size with the remote control unit to display the image in full screen. (Change the screen size to "WIDE", for example, with the screen size button on the remote control unit (⇒ see *Part names: "Remote control unit"*)).
- Set the Side Mask detection function to "On" (⇒ see *Useful adjustment settings: "Detecting side masks"*).
- Set the brightness of the **side masks** that appear on the left and right sides of the screen when viewing at a 4:3 screen size to "Auto" in "Brightness Sync." (⇒ see *Useful adjustment settings: "Changing the brightness at both sides of the screen (Side Mask)"*).
- It is recommended to lower the brightness when viewing by setting the **Energy Save** function to "Mode1" (⇒ see *Setting up: "Power Control"*).

IMPORTANT



The lightning flash with arrowhead symbol, within an equilateral triangle, is intended to alert the user to the presence of uninsulated "dangerous voltage" within the product's enclosure that may be of sufficient magnitude to constitute a risk of electric shock to persons.

CAUTION

RISK OF ELECTRIC SHOCK
DO NOT OPEN

CAUTION:

TO PREVENT THE RISK OF ELECTRIC SHOCK, DO NOT REMOVE COVER (OR BACK). NO USER-SERVICEABLE PARTS INSIDE. REFER SERVICING TO QUALIFIED SERVICE PERSONNEL.



The exclamation point within an equilateral triangle is intended to alert the user to the presence of important operating and maintenance (servicing) instructions in the literature accompanying the appliance.

D3-4-2-1-1_En-A

CAUTION

The  switch on this unit will not completely shut off all power from the AC outlet. Since the power cord serves as the main disconnect device for the unit, you will need to unplug it from the AC outlet to shut down all power. Therefore, make sure the unit has been installed so that the power cord can be easily unplugged from the AC outlet in case of an accident. To avoid fire hazard, the power cord should also be unplugged from the AC outlet when left unused for a long period of time (for example, when on vacation).

D3-4-2-2a_A_En

WARNING

This equipment is not waterproof. To prevent a fire or shock hazard, do not place any container filled with liquid near this equipment (such as a vase or flower pot) or expose it to dripping, splashing, rain or moisture.

D3-4-2-1-3_B_En

WARNING

Before plugging in for the first time, read the following section carefully.

The voltage of the available power supply differs according to country or region. Be sure that the power supply voltage of the area where this unit will be used meets the required voltage (e.g., 230 V or 120 V) written on the rear panel.

D3-4-2-1-4_A_En

WARNING

This product equipped with a three-wire grounding (earthed) plug - a plug that has a third (grounding) pin. This plug only fits a grounding-type power outlet. If you are unable to insert the plug into an outlet, contact a licensed electrician to replace the outlet with a properly grounded one. Do not defeat the safety purpose of the grounding plug.

D3-4-2-1-6_A_En

Operating Environment

Operating environment temperature and humidity:
+0 °C to +40 °C (+32 °F to +104 °F); less than 85 %RH
(cooling vents not blocked)

Do not install this unit in a poorly ventilated area, or in locations exposed to high humidity or direct sunlight (or strong artificial light)

D3-4-2-1-7c_A_En

The following symbols are found on labels attached to the product. They alert the operators and service personnel of this equipment to any potentially dangerous conditions.



WARNING

This symbol refers to a hazard or unsafe practice which can result in personal injury or property damage.



CAUTION

This symbol refers to a hazard or unsafe practice which can result in severe personal injury or death.

WARNING

To prevent a fire hazard, do not place any naked flame sources (such as a lighted candle) on the equipment.

D3-4-2-1-7a_A_En

VENTILATION CAUTION

When installing this unit, make sure to leave space around the unit for ventilation to improve heat radiation. For the minimum space required, see page 15.

WARNING

Slots and openings in the cabinet are provided for ventilation to ensure reliable operation of the product, and to protect it from overheating. To prevent fire hazard, the openings should never be blocked or covered with items (such as newspapers, table-cloths, curtains) or by operating the equipment on thick carpet or a bed.

STANDBY/ON Button

STANDBY: When placed into the standby mode, the main power flow is cut and the unit is no longer fully operational.

STANDBY/ON Indicator: The indicator is lit red when the unit is in the standby mode and is lit blue when it is in the power-on mode.

Thank you for buying this Pioneer product.

Please read through these operating instructions so you will know how to operate your model properly. After you have finished reading the instructions, put them away in a safe place for future reference.

In some countries or regions, the shape of the power plug and power outlet may sometimes differ from that shown in the explanatory drawings. However the method of connecting and operating the unit are the same.

Illustrations shown in this manual are for the PDP-508XDA unless otherwise specified.

Contents

To use your plasma television for a long period of time	2	Sorting preset TV channels	29
01 Important user information	6	Language setting	29
02 Safety precautions	9	AV Selection	30
Installation precautions	10	Basic picture adjustments	30
03 Supplied accessories	11	Advanced picture adjustments	31
04 Part names	12	Comparing picture adjustments on the screen	34
Plasma television	12	Sound adjustments	35
Remote control unit	14	Listening to audio from the sub screen using headphones	35
05 Preparation	15	Power Control	36
Installing the plasma television	15	09 Enjoying DTV broadcasts	38
Moving the plasma television	15	Watching DTV programmes	38
Preventing the plasma television from falling over	16	Changing channels	38
Basic connections	17	Viewing a channel banner (i-PLATE)	38
Preparing the remote control unit	18	Viewing subtitles	39
Operating range of the remote control unit	19	Customizing channel related settings	39
06 Watching TV	20	Registering channels in the Favourite List	39
Turning the power on	20	Activating the Favourites function	40
Placing the system into standby	20	Parental Control	40
Changing channels	21	Reconfiguring the DTV channel settings	40
Changing the volume and sound	21	Quick Scan (designating the scanning city/region)	41
Switching the broadcast audio channel	22	Auto Scan (No scanning city/region designated)	41
Using the multiscreen functions	23	Manual Scan	42
Freezing images	24	Clear All Data	42
07 The HOME MENU	25	Time Zone Setup	43
HOME MENU overview	25	Selecting a digital audio format	43
Using the HOME MENU	26	Selecting an audio language	44
08 Setting up	27	Displaying technical information	44
Setting up TV channels automatically	27	Screen Saver	44
Setting up analogue TV channels manually	27	10 Useful adjustment settings	45
Reducing video noise	28	Switching the vertical drive mode (AV source only)	45
Setting Child Lock	28	Adjusting image positions (AV source only)	45
Suppressing audio distortion	28	Adjusting image positions and clock automatically (PC source only)	45
Labeling TV channels	29	Adjusting image positions and clock manually (PC source only)	46
		Colour system setting	46
		Selecting a game mode	46
		Selecting a screen size manually	46
		Selecting a screen size automatically	47
		Detecting side masks	47
		Changing the brightness at both sides of the screen (Side Mask)	48
		Room Light Sensor	48
		Blue LED Dimmer	48
		Orbiter	49

Video Pattern 49
 Sleep Timer 49
 Using a password 49

11 Using with other equipment 51

Connecting a set top box 51
 Connecting a DVD player 51
 Connecting a VCR 52
 Connecting a game console or camcorder 52
 Connecting a personal computer 53
 Connecting an amplifier/AV receiver 53
 Avoiding unwanted feedback 54
 Using the HDMI Inputs 54
 Using control cords 56
 Enjoying through USB interface (Home Gallery function) 57
 Controlling other equipment using the supplied
 remote control unit 60

12 Using the HDMI Control 65

Using the HDMI Control functions 65
 Making the HDMI Control connections 66
 Setting the HDMI Control 68
 Using the HDMI Control menus 69

13 Using Teletext 70

Using the Teletext functions 70
 Operating the Teletext basics for analogue TV or external input
 sources 70
 Operating the Teletext basics for DTV 71

14 Additional information 72

Troubleshooting 72
 Signal assignments for 15-pin D-sub connector 74
 Specifications 75

Chapter 1

Important user information

In order to obtain maximum enjoyment from this Pioneer PDP-508XDA/PDP-428XDA plasma television, please first read this information carefully.

With the Pioneer PDP-508XDA/PDP-428XDA, you can be assured of a high quality plasma television with long-life and high reliability. To achieve images of exceptional quality, this Pioneer plasma television incorporates state-of-the-art design and construction, as well as very precise and highly advanced technology.

The Pioneer PDP-508XDA/PDP-428XDA incorporates the latest in colour filter technology: Direct colour Filter. This improves the colour/picture reproduction of these models as compared to previous models. It also eliminates the need for a physical glass panel to be placed in front of the plasma panel, which furthers Pioneer's continued goal of reducing environmental waste in consumer electronics, now during the manufacturing process and in the future during the recycling process.

Over the course of its lifetime, the luminosity of the Pioneer PDP-508XDA/PDP-428XDA plasma television will diminish very slowly, such as with all phosphor-based screens (for example, a traditional tube-type television). To enjoy beautiful and bright images on your Pioneer plasma television for a long time, please carefully read and follow the usage guidelines below:

Usage guidelines

All phosphor-based screens (including conventional tube-type televisions) can be affected by displaying static images for a prolonged period. Plasma televisions are no exception to this rule. After-image and permanent effects on the screen can be avoided by taking some basic precautions. By following the recommendations listed below, you can ensure longer and satisfactory results from your plasma:

- Whenever possible, avoid frequently displaying the same image or virtually still moving pictures (e.g. video game images which have static portions).
- Do not display Teletext for a prolonged period of time.
- Avoid viewing the On Screen Display for extended periods, from a set top box, DVD player, VCR and all other components.
- Do not leave the same picture freeze-framed or paused continuously over a long period of time, when using the still picture mode from a TV, VCR, DVD player or any other component.
- Images which have both very bright areas and very dark areas side by side should not be displayed for a prolonged period of time.
- When playing a game, the "GAME" mode setting within "AV Selection" is strongly recommended. However, please do not use this mode for long periods of time.
- After playing a game, displaying a PC image, or any other still image, it is best to view a normal moving picture in the "WIDE" or "FULL" screen setting for more than three times the length of the previous still/moving image.
- After using the plasma television, always switch the television to "STANDBY" mode.

Installation guidelines

The Pioneer PDP-508XDA/PDP-428XDA plasma television incorporates a very thin design. To ensure safety, please take the proper measures to mount or install the plasma television, in order to prevent the unit from tipping over in the event of vibration or accidental movement.

This product should be installed by using only parts and accessories designed by Pioneer. Use of accessories other than the Pioneer stand or installation bracket may result in instability, and could cause injury. For custom installation, please consult the dealer where the unit was purchased. To ensure correct installation, experienced and qualified experts must install the unit.

Pioneer will not be responsible for accident or damage caused by the use of parts and accessories manufactured by other companies, inadequate installation or stabilization, erroneous operation, remodeling or natural disasters.

To avoid malfunction and overheating, make sure that the vents on the main unit are not blocked when installing to ensure proper heat emission:

- Distance the unit slightly from other equipment, walls, etc. For the minimum space required around the unit, see page 15.
- Do not fit the unit inside narrow spaces where ventilation is poor.
- Do not cover with a cloth, etc.
- Clean the vents on the sides and rear of the unit to remove dust build-up, by using a vacuum cleaner set to its lowest suction setting.
- Do not place the product on a carpet or blanket.
- Do not leave the product tilted over.
- Do not turn the product upside down.

Using the unit without proper ventilation may cause the internal temperature to rise, and could result in possible malfunction. When the surrounding or internal temperature exceeds a certain degree, the television will automatically power off in order to cool the internal electronics and prevent hazardous occurrences.

Any malfunction may occur due to: an inappropriate installation site, improper assembly, installation, mounting, or operation of this product, modifications made to the product. However, Pioneer cannot be held responsible for such accidents or malfunction.

Note

The following are typical effects and characteristics of a phosphor-based matrix display and as such, are not covered by the manufacturer's limited warranties:

- Permanent residual images upon the phosphors of the panel.
- The existence of a minute number of inactive light cells.
- Panel generated sounds, examples: Fan motor noise, and electrical circuit humming/glass panel buzzing

Caution

Pioneer bears no responsibility for any damage arising from incorrect use of the product by you or other people, malfunctions when in use, other product related problems, and use of the product except in cases where the company must be liable.

Plasma television protection function

When still images (such as photos and computer images) stay on the screen for an extended period of time, the screen will be slightly dimmed. This is because the protection function of the plasma television automatically adjusts the brightness to protect the screen when detecting still images; so this does not designate malfunction. The screen is dimmed when a still image is detected for about three minutes.

Information of pixel defect

Plasma television displays information using pixels. Pioneer plasma television panels contain a very large number of pixels. (Depending on the panel size: over 2.3 million cells in case of a 42 inch display; over 3.1 million cells in case of a 50 inch display). All Pioneer display panels are manufactured using a very high level of ultra-precision technology and undergo individual quality control. In rare cases, some pixels can be permanently switched off, or on, resulting in either a black or coloured pixel permanently fixed on the screen.

This effect is common to all plasma televisions because it is a consequence of the technology.

If the defective pixels are visible at a normal viewing distance of between 2.5 metres and 3.5 metres whilst viewing a normal broadcast (i.e. not a test card, still image or single colour display) please contact the supplying dealer.

If, however, they can only be seen close up or during single colour displays then this is considered normal for this technology.

Infrared rays

The plasma television releases infrared rays because of its characteristics. Depending on how the plasma television is in use, the remote controls of nearby equipment may be adversely affected or wireless headphones using infrared rays are interfered by noise. If this is the case, place that equipment at a location where its remote control sensor is not affected.

Radio interference

While this product meets the required specifications, it emits a small amount of noise. If you place such equipment as an AM radio, personal computer, and VCR close to this product, that equipment may be interfered. If this happens, place that equipment far enough from this product.

Plasma television driving sound

The screen of the plasma television is composed of extremely fine pixels and these pixels emit light according to received video signals. This principle may cause you to hear a buzz or electrical hum coming from the plasma television.

Fan motor noise

The rotation speed of the cooling fan motor increases when the ambient temperature of the plasma television becomes high. You may hear the sound of the fan motor at that time.

Do not attach such items as labels and tape to the product

This may result in the discolouration or scratch of the cabinet.

When not using the product for a long period of time

If you do not use the product for a long period of time, the functions of the product may be adversely affected. Switch on and run the product occasionally.

Condensation

Condensation may take place on the surface or inside of the product when the product is rapidly moved from a cold place to a warm place or just after a heater is switched on in winter morning, for example. When condensation takes place, do not switch on the product and wait until condensation disappears. Using the product with condensation may result in malfunction.

Cleaning the surface of the screen

When cleaning the screen surface, gently wipe it with the supplied dry cleaning cloth.

 **Caution**

Rubbing hard on the screen can scratch the special film coating the surface. If cleaning gently with the dry cloth is not enough to remove grime, unplug the power cord from the outlet and follow the procedure below.

1. Soak a piece of soft, untreated cloth in distilled water. *A "treated" cloth contains polish or other chemicals, such as in a commercially available eyeglass cleaning towelette.*
2. Wring out the cloth so that it is slightly damp, not wet. *Make sure to wring out the cloth completely. Cleaning the surface with a wet cloth can allow water to seep into the unit, causing damage.*
3. Gently wipe the surface of the screen with the damp cloth.
4. Wipe the surface again using the dry cloth included with your panel to remove any remaining dampness and to prevent streaks.

Cleaning the glossy surface of the front cabinet

When cleaning the glossy surface of the front cabinet, gently wipe it with a dry soft cloth; the supplied cleaning cloth or other similar cloths (e.g., cotton and flannel). If you use a dusty or hard cloth, the surface of the product will be scratched.

Cleaning the cabinet

When cleaning the cabinet of this product, gently wipe it with a clean soft cloth (e.g., cotton and flannel). If you use a dusty or hard cloth or if you rub the cabinet hard, the surface of the cabinet will be scratched.

The cabinet of this product is mostly composed of plastic. Do not use chemicals such as benzene or thinner to clean the cabinet. Using these chemicals may result in quality deterioration or coating removal.

Do not expose the product to volatile gas or fluid such as pesticide. Do not make the product contact with rubber or vinyl products for a long period of time. The effect of plasticiser in the plastic may result in quality deterioration or coating removal.

If you clean the surface of the cabinet with a wet cloth, water droplets on the surface may enter into the product, resulting in malfunction.

Handles at the rear of the plasma television

Do not remove the handles from the rear of the plasma television.

When moving the plasma television, ask another person for help and use the handles attached to the rear of the plasma television. Do not move the plasma television by holding only a single handle.

Do not use the handles to hang the product when installing or carrying the product, for example. Do not use the handles for the purpose of preventing the product from tilting over.

To use this product for a long period of time

The Energy Save function can maintain efficiency of the screen for a long period of time. Setting the Energy Save function to "Mode1" is recommended in order to maintain the efficiency of the screen for a long period of time.

 **Caution****Panel sticking and after-image lag**

Displaying the same images such as still images for a long time may cause after-image lagging. This may occur in the following two cases.

After-image lagging due to remaining electrical load

When image patterns with very high peak luminance are displayed for more than 1 minute, after-image lagging may occur due to the remaining electric load. The after-images remaining on the screen will disappear when moving images are displayed. The time for the after-images to disappear depends on the luminance of the still images and the time they had been displayed.

After-image (lag image) due to burning

Avoid displaying the same image on the plasma television continuously over a long period of time.

If the same image is displayed continuously for long periods or for shorter periods of time over several days, a permanent after-image may remain on the screen due to burning of the fluorescent materials. Such images may become less noticeable if moving images are later displayed, but they will not disappear completely.

 **Note**

- To prevent damage from screen burning, after a display time of 5 to 10 minutes this plasma television will automatically turn off any still images generated by the panel itself. This includes the Graphical User Interface and the Home Gallery function.
- To prevent screen burning, the display position is automatically changed imperceptibly when watching plasma television (see *Orbiter* on page 49).

Preventing damage from screen burning

- We recommend that you enjoy watching images displayed in full screen, except when doing so may result in copyright infringement (see page 46).
- Set the Side Mask detection function to "On", the High Definition 16:9 aspect ratio images containing side masks will be detected and the side masks will be added automatically or the image displayed in full screen, leading to more effective countermeasures taken for the screen burning (see *Detecting side masks* on page 47).

Chapter 2

Safety precautions

Electricity is used to perform many useful functions, but it can also cause personal injuries and property damage if improperly handled. This product has been engineered and manufactured with the highest priority on safety. However, improper use can result in electric shock and/or fire. In order to prevent potential danger, please observe the following instructions when installing, operating and cleaning the product. To ensure your safety and prolong the service life of your product, please read the following precautions carefully before using the product.

1. Read instructions - All operating instructions must be read and understood before the product is operated.
 2. Keep this manual in a safe place - These safety and operating instructions must be kept in a safe place for future reference.
 3. Observe warnings - All warnings on the product and in the instructions must be observed closely.
 4. Follow instructions - All operating instructions must be followed.
 5. Cleaning - Unplug the power cord from the AC outlet before cleaning the product. To clean the product, use the supplied cleaning cloth or other soft clothes (e.g., cotton, flannel). Do not use liquid cleaners or aerosol cleaners.
 6. Attachments - Do not use attachments not recommended by the manufacturer. Use of inadequate attachments can result in accidents.
 7. Water and moisture - Do not use the product near water, such as bathtub, washbasin, kitchen sink and laundry tub, swimming pool and in a wet basement.
 8. Stand - Do not place the product on an unstable cart, stand, tripod or table. Placing the product on an unstable base can cause the product to fall, resulting in serious personal injuries as well as damage to the product. Use only a cart, stand, tripod, bracket or table recommended by the manufacturer or sold with the product. When mounting the product on a wall, be sure to follow the manufacturer's instructions. Use only the mounting hardware recommended by the manufacturer.
 9. When relocating the product placed on a cart, it must be moved with utmost care. Sudden stops, excessive force and uneven floor surface can cause the product to fall from the cart.
- 
10. Ventilation - The vents and other openings in the cabinet are designed for ventilation. Do not cover or block these vents and openings since insufficient ventilation can cause overheating and/or shorten the life of the product. Do not place the product on a bed, sofa, rug or other similar surface, since they can block ventilation openings. This product is not designed for built-in installation; do not place the product in an enclosed place such as a bookcase or rack, unless proper ventilation is provided or the manufacturer's instructions are followed.
 11. Power source - This product must operate on a power source specified on the specification label. If you are not sure of the type of power supply used in your home, consult your dealer or local power company.
 12. Power cord protection - The power cords must be routed properly to prevent people from stepping on them or objects from resting on them. Check the cords at the plugs and product.
 13. The plasma television used in this product is made of glass. Therefore, it can break when the product is dropped or applied with impact. Be careful not to be injured by broken glass pieces in case the plasma television breaks.
 14. Overloading - Do not overload AC outlets or extension cords. Overloading can cause fire or electric shock.
 15. Entering of objects and liquids - Never insert an object into the product through vents or openings. High voltage flows in the product, and inserting an object can cause electric shock and/or short internal parts. For the same reason, do not spill water or liquid on the product.
 16. Servicing - Do not attempt to service the product yourself. Removing covers can expose you to high voltage and other dangerous conditions. Request a qualified service person to perform servicing.
 17. Repair - If any of the following conditions occurs, unplug the power cord from the AC outlet, and request a qualified service person to perform repairs.
 - a. When the power cord or plug is damaged.
 - b. When a liquid was spilt on the product or when objects have fallen into the product.
 - c. When the product has been exposed to rain or water.
 - d. When the product does not operate properly as described in the operating instructions.

Do not touch the controls other than those described in the operating instructions. Improper adjustment of controls not described in the instructions can cause damage, which often requires extensive adjustment work by a qualified technician.
 - e. When the product has been dropped or damaged.
 - f. When the product displays an abnormal condition. Any noticeable abnormality in the product indicates that the product needs servicing.
 18. Replacement parts - In case the product needs replacement parts, make sure that the service person uses replacement parts specified by the manufacturer, or those with the same characteristics and performance as the original parts. Use of unauthorised parts can result in fire, electric shock and/or other danger.
 19. Safety checks - Upon completion of service or repair work, request the service technician to perform safety checks to ensure that the product is in proper operating condition.
 20. Wall or ceiling mounting - When mounting the product on a wall or ceiling, be sure to install the product according to the method recommended by the manufacturer.
 21. Heat sources - Keep the product away from heat sources such as radiators, heaters, stoves and other heat-generating products (including amplifiers).
 22. Unplug the power cord from the AC outlet before installing the speakers (for PDP-508XDA only).
 23. Never expose the screen of the plasma television to a strong impact, for example, by hitting it. The screen may be broken, resulting in fire or personal injury.
 24. Do not expose the plasma television to direct sunlight for a long period of time. The optical characteristics of the front protection panel changes, resulting in discolouration or warp.
 25. The plasma television weighs about 35.2 kg (77.6 lbs.) for the PDP-508XDA and about 30.2 kg (66.6 lbs.) for the PDP-428XDA. Because it has small depth and is unstable, unpack, carry, and install the product with one more person at least and use the handles.

Installation precautions

Observe the following precautions when installing with any items such as the optional stand.

When using the optional stand, brackets, or equivalent items

Ask your dealer to perform the installation.

Be sure to use the supplied bolts.

For details, see the instruction manual that comes with the optional stand (or equivalent items).

When using other items

Consult your dealer.

The following six mounting holes can be used for the installation:

Rear (PDP-508XDA)

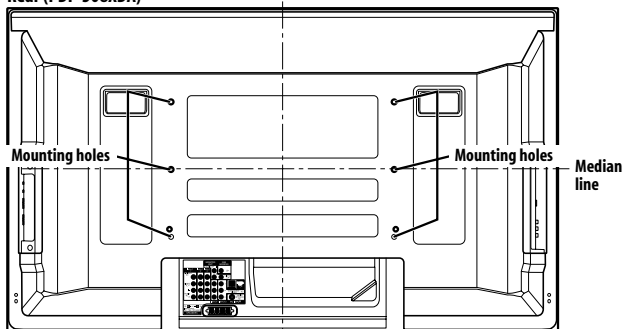

Median line

Rear (PDP-428XDA)

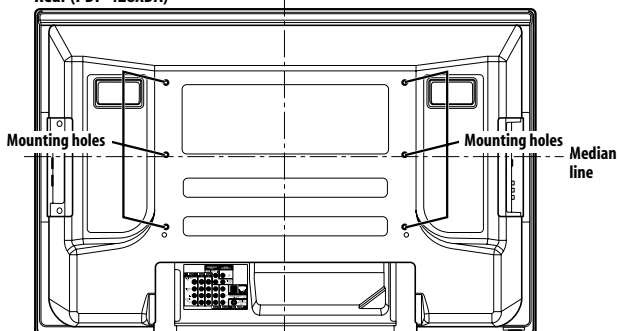

Median line

Side view

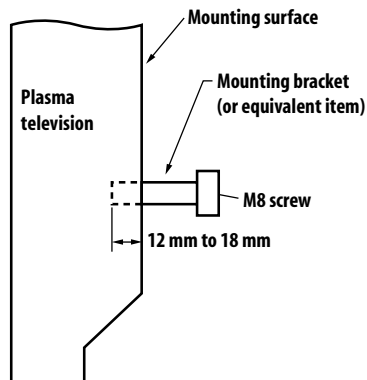

Caution

- Be sure to use four or more mounting holes symmetrical to the vertical and horizontal median lines.
- Use M8 screws, which go 12 mm to 18 mm in depth from the mounting surface of the plasma television. See the side view above.
- Be careful not to block the ventilation opening at the rear of the plasma television.
- Be sure to install the plasma television on a flat surface because it contains glass.
- The screw holes other than the illustrations on the left are to be used only for the specified products. Never use them for mounting non-specified products.
- Do not mount or remove the plasma television to or from the stand, with speakers attached (for PDP-508XDA only).

Note

- It is strongly recommended to use the optional Pioneer mounting products.
- Pioneer shall not be liable for any personal injury or product damage that results from the use of mounting items other than the optional Pioneer products.

Chapter 3 Supplied accessories

Check that all of the following accessories are supplied in the box.

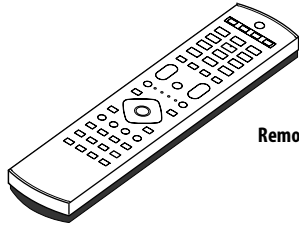

Remote control unit

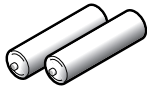

AA size battery x 2

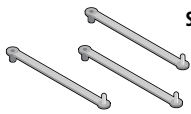

Speed clamp x 3

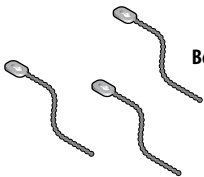

Bead band x 3

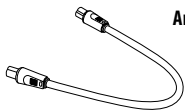

Antenna cable

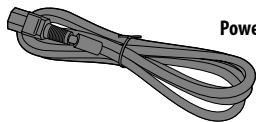

Power cord

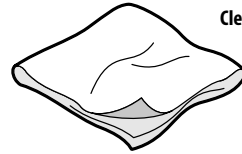

Cleaning cloth

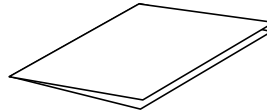

Warranty card

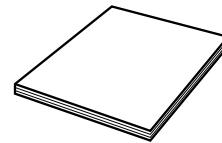

Operating instructions

Chapter 4

Part names

Plasma television

(Front)

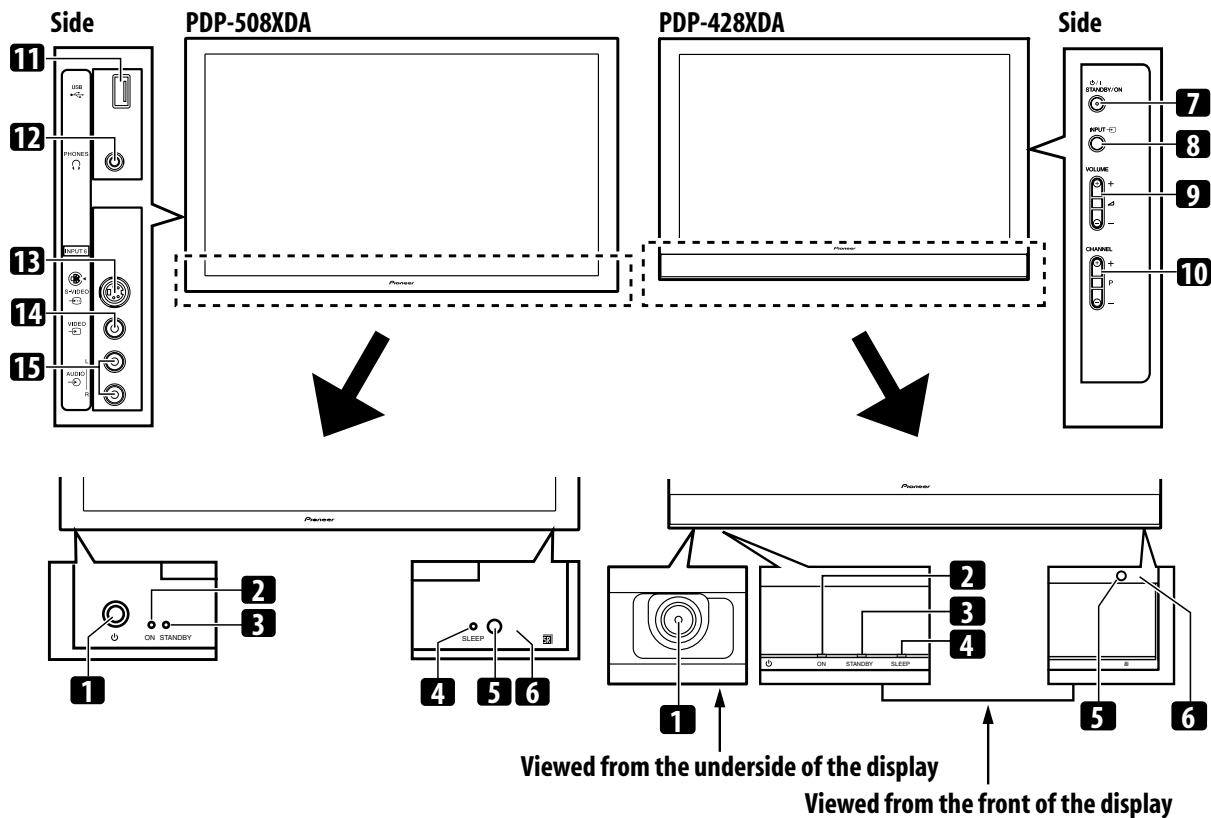

Viewed from the underside of the display
Viewed from the front of the display

The terminals on side panels are common to the PDP-508XDA and PDP-428XDA.

- 1 button (If the button is off, the power will not turn on even when 0 to 9 on the remote control unit or **STANDBY/ON** on the plasma television is pressed.)
- 2 POWER ON indicator
- 3 STANDBY indicator
- 4 SLEEP indicator
- 5 Room Light Sensor
- 6 Remote control sensor
- 7 **STANDBY/ON** button
- 8 **INPUT** button

- 9 **VOLUME +/-** buttons
- 10 **CHANNEL +/-** buttons
- 11 USB port
- 12 PHONES output terminal
- 13 INPUT 6 terminal (S-VIDEO)
- 14 INPUT 6 terminal (VIDEO)
- 15 INPUT 6 terminals (AUDIO)

Plasma television

(Rear)

PDP-508XDA

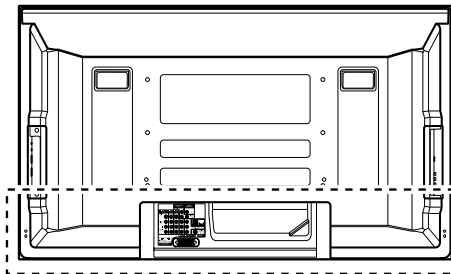

PDP-428XDA

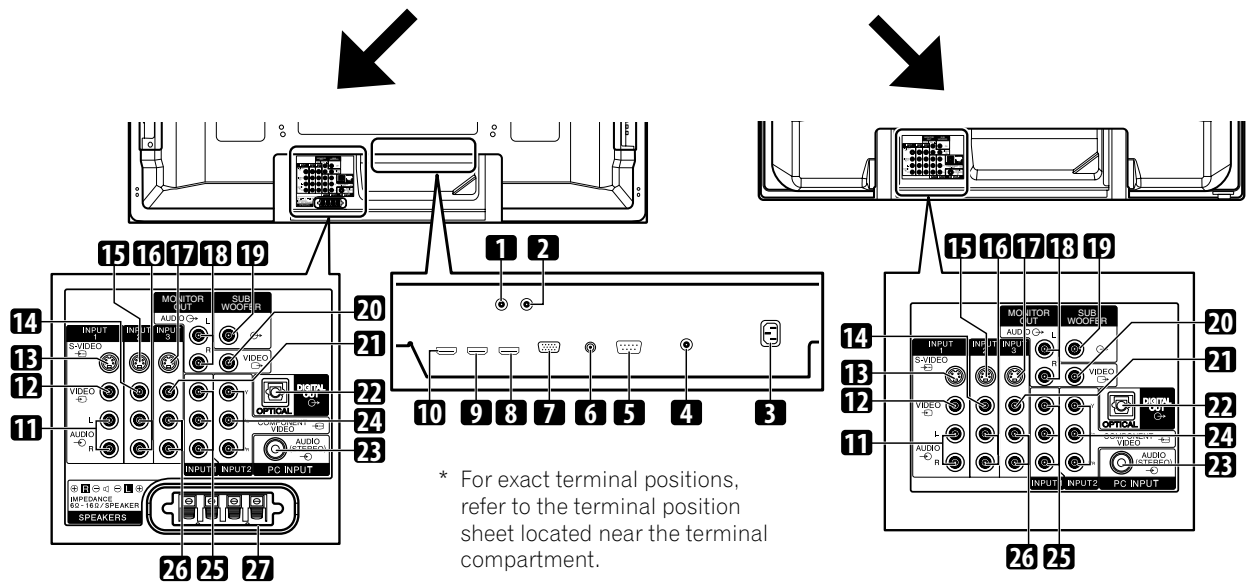
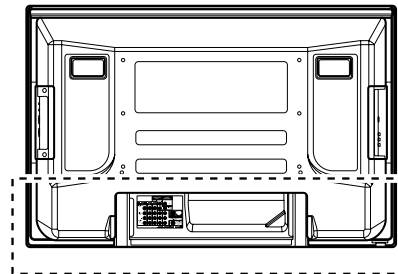

The terminals from 1 to 10 are the same as the PDP-508XDA.

- 1 Antenna IN terminal (antenna in for DTV)
- 2 Antenna OUT terminal (antenna through out)
- 3 AC IN terminal
- 4 ANT (antenna) input terminal (for analogue TV)
- 5 RS-232C terminal (used for factory setup)
- 6 CONTROL OUT terminal (supports SR+)
- 7 PC INPUT terminal (analogue RGB)
- 8 INPUT 5 terminal (HDMI)
- 9 INPUT 4 terminal (HDMI)
- 10 INPUT 3 terminal (HDMI)
- 11 INPUT 1 terminals (AUDIO L, R)
- 12 INPUT 1 terminal (VIDEO)
- 13 INPUT 1 terminal (S-VIDEO)
- 14 INPUT 2 terminal (VIDEO)
- 15 INPUT 2 terminal (S-VIDEO)
- 16 INPUT 2 terminals (AUDIO L, R)
- 17 INPUT 3 terminal (S-VIDEO)
- 18 MONITOR OUT terminals (AUDIO L, R)
- 19 SUBWOOFER output terminal
- 20 MONITOR OUT terminal (VIDEO)
- 21 INPUT 3 terminal (VIDEO)
- 22 DIGITAL OUT terminal (OPTICAL)
- 23 PC INPUT terminal (AUDIO (STEREO))
- 24 INPUT 2 terminals (COMPONENT VIDEO: Y, P_B, P_R)
- 25 INPUT 1 terminals (COMPONENT VIDEO: Y, P_B, P_R)
- 26 INPUT 3 terminals (AUDIO L, R)
- 27 SPEAKERS L, R terminals (PDP-508XDA only)

Remote control unit

This section describes the functions of the buttons available when the TV mode has been selected by using the **SELECT** button. For the buttons controlling other equipment, see *Controlling other equipment using the supplied remote control unit* on page 60.

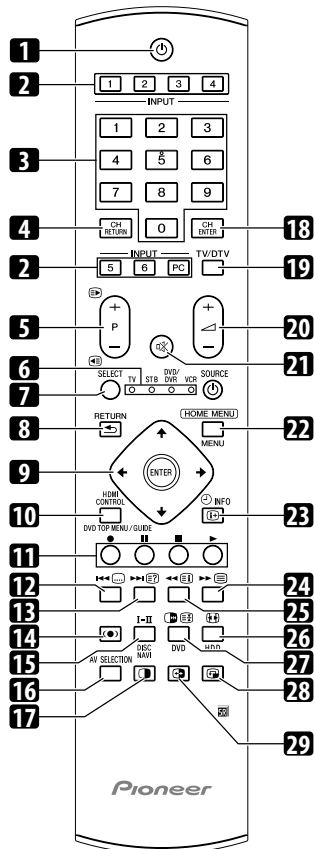

- 1 Turns on the power to the plasma television or places it into the standby mode.
- 2 **INPUT**
Selects an input source ("INPUT 1", "INPUT 2", "INPUT 3", "INPUT 4", "INPUT 5", "INPUT 6" or "PC")
- 3 **0 to 9**
Switches on the power to the plasma television.
TV/External input mode: Selects a channel.
Teletext mode: Selects a page.
- 4 **CH RETURN**
Returns to the previously selected channel.
- 5 **P+/P-**
TV/External input mode: Selects a channel.
 Teletext mode: Selects a page.
- 6 **TV, STB, DVD/DVR, VCR**
These indicators show the current selection and status when you control other connected equipment, using the supplied remote control unit.
- 7 **SELECT**
Switches the selection among TV, STB, DVD/DVR, and VCR, so that you can control other connected equipment, using the supplied remote control unit.
- 8 **RETURN**
Restores the previous menu screen.
- 9 Selects a desired item on the setting screen.
- 10 **ENTER**
Executes a command.
DTV input mode: Executes a command or displays the Programme List.
- 11 **HDMI CONTROL**
Displays the HDMI Control menu.
- 12 **Colour (RED/GREEN/YELLOW/BLUE)**
Teletext mode: Selects a page.
- 13 Jumps to the Teletext subtitle page.
Turns subtitle on and off in DTV input mode depending on the broadcast.
- 14 Displays hidden characters.
- 15 Use to select a sound effect mode.
- 16 **I-II**
Sets the sound multiplex mode.
DTV input mode: Selects the Audio channel (Mpeg/Dolby Digital).
- 17 **AV SELECTION**
Selects audio and video settings.
(AV source: OPTIMUM, STANDARD, DYNAMIC, MOVIE, SPORT, GAME, USER. PC source: STANDARD, USER.)
- 18 Press to select 2-screen, picture-in-picture or single screen mode.
- 19 **CH ENTER**
Executes a channel selection by the number buttons.
- 20 **TV/DTV**
Switches between the analogue TV and DTV input modes.
- 21 Sets the volume.
- 22 Mutes the sound.
- 23 **HOME MENU**
Displays the HOME MENU screen.
- 24 **INFO**
TV/External input mode: Displays the channel information.
DTV input mode: Displays the banner information (i-PLATE).
- 25 Selects the Teletext mode (all TV image, all TEXT image, TV/TEXT image).
DTV input mode: Displays the Teletext mode (all DTV image, TEXT image on DTV image).
- 26 Teletext mode: Displays an Index page for the CEEFAX/FLOF format.
DTV Teletext mode: Displays an Index page.
- 27 Selects the screen size.
- 28 TV/External input mode: Freezes a frame from a moving image. Press again to cancel the function.
 Teletext mode: Stops updating Teletext pages. Press again to release the hold mode.
- 29 Moves the position of the sub screen when in picture-in-picture mode.
- 30 Swaps the main and sub screens when in picture-in-picture or 2-screen mode.

Note

- When using the remote control unit, point it at the plasma television.

Chapter 5 Preparation

Installing the plasma television

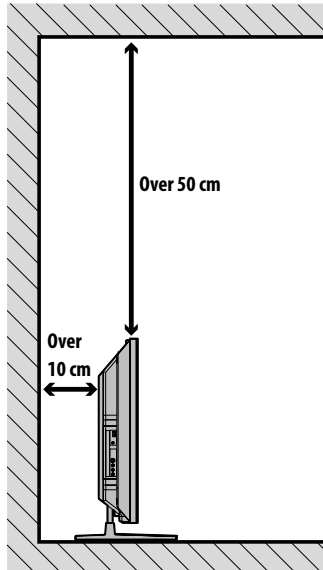

Location

- Avoid direct sunlight. Maintain adequate ventilation.



Caution

- If you do not leave sufficient space above the plasma television, it will not receive enough ventilation and will not operate properly.
- Pioneer will not be responsible for accident or damage caused by inadequate installation or stabilization, erroneous operation, remodeling or natural disasters.



Note

- Allow enough space around the upper and back parts when installing to ensure adequate ventilation of the rear of the unit.
- Be sure to install the plasma television in a flat, stable location.

Using the optional Pioneer stand

For details on installation, refer to the instruction manual supplied with the stand.

Using the optional Pioneer speakers (for PDP-508XDA)

For details on installation, refer to the instruction manual supplied with the speaker.

Moving the plasma television

When installing on a rack, etc, hold the plasma television as shown on the right. Because the plasma television is heavy, be sure to have someone help you when moving it.

(for PDP-508XDA) Under speaker

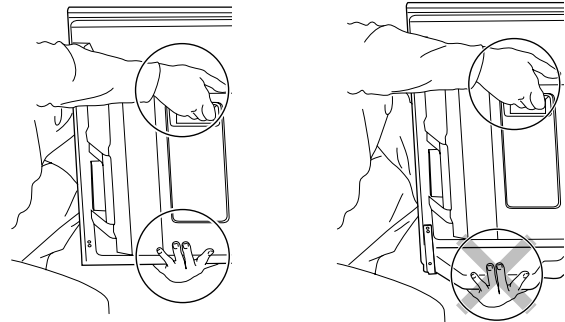

Side speaker

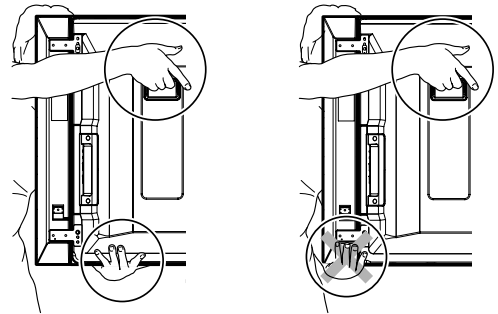

(for PDP-428XDA)

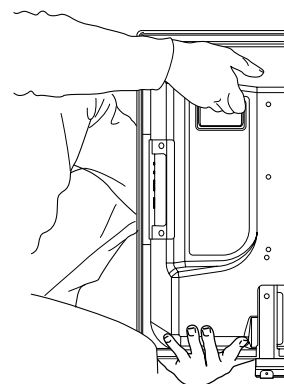

Note

- Do not use the speaker to support the weight of the plasma television.
- When the plasma television has under-mounted speakers, always remove the speakers before moving the plasma television. Do not hold the plasma television by the speaker mounting fittings.

Preventing the plasma television from falling over

After installing the stand, be sure to take special care to ensure that the plasma television will not fall over and is stabilized to both the wall and rack.

Stabilizing on a table or rack

Stabilize the plasma television as shown in the diagram using the plastic bands and screws provided with the optional stand.

Note

- To stabilize the plasma television on a table or rack, also use commercially available wood screws that have a nominal diameter of 4 mm and that are at least 20 mm long.

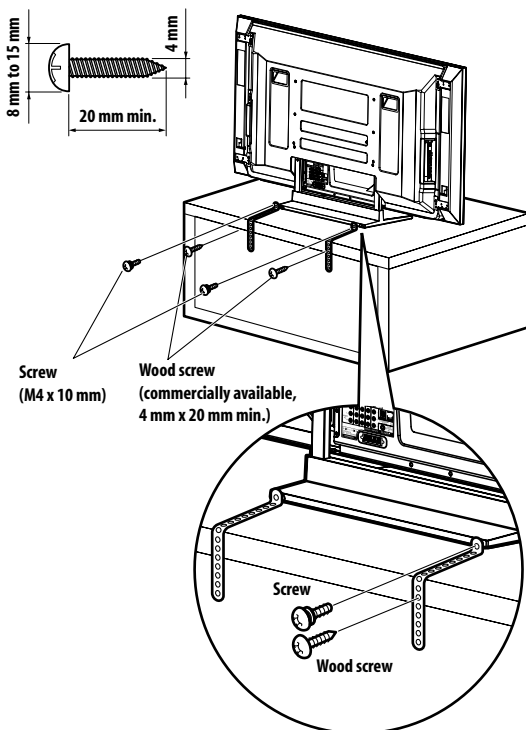

Drill a hole in the middle at the rear of the tabletop panel before using a wood screw. Perform this work the same way on the left and right sides.

Using a wall for stabilization

- Attach falling prevention bolts (hooks) to the plasma television.
- Use strong cords to stabilize it appropriately and firmly to a wall, pillar, or other sturdy element.

Perform this work in the same way on the left and right sides.

Use hooks, cords, and fittings that are available on the market. Recommended hook: Nominal diameter 8 mm, length 12 mm to 18 mm.

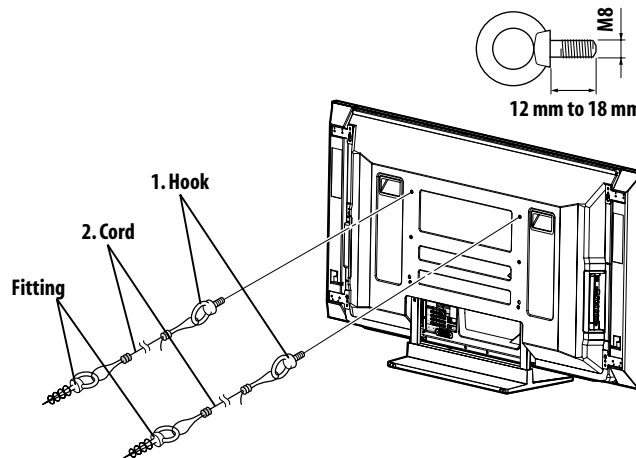

Caution

- A table or rack with adequate strength should always be used to support the plasma television. Failure to do so could result in personal injury and physical damage.
- When installing the plasma television, please take the necessary safety measures to prevent it from falling or overturning in case of emergencies, such as earthquakes, or of accidents.
- If you do not take these precautions, the plasma television could fall down and cause injury.
- The screws, hooks, cords, and other fittings that you use to secure the plasma television to prevent it from overturning will vary according to the composition and thickness of the surface to which it will be attached.
- Select the appropriate screws, hooks, cords, and other fittings after first inspecting the surface carefully to determine its thickness and composition and after consulting a professional installer if necessary.

Basic connections

Connecting the antenna

To enjoy a clearer picture, use an outdoor antenna. The following is a brief explanation of the types of connections that are used for a coaxial cable.

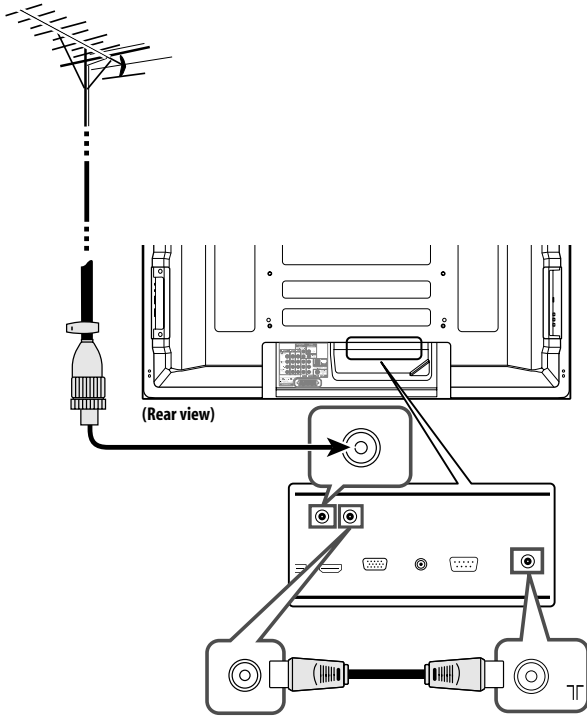

- For viewing both analogue and digital broadcasts, connect the antenna cable to the ANT OUT terminal (antenna through out) and ANT (analogue input) terminal.
- Be sure to use the provided antenna cable.

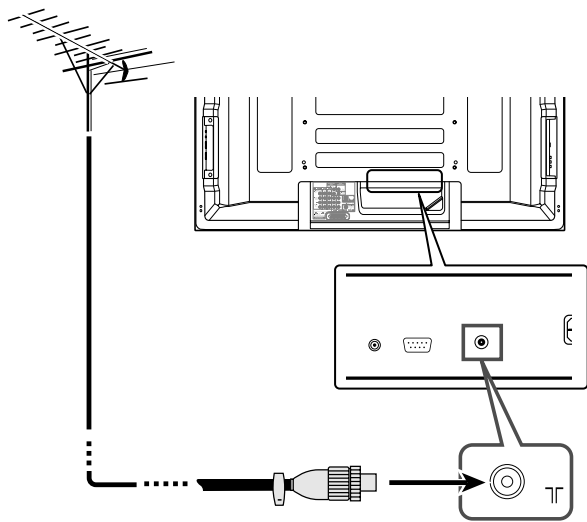

- For viewing analogue broadcasts only, connect the 75-ohm coaxial cable (commercially available) to ANT (analogue input) terminal.

Antenna cable (commercially available)



If your outdoor antenna uses a 75-ohm coaxial cable with a standard DIN45325 plug (IEC169-2), plug it into the antenna terminal at the rear of the plasma television.

Note

- If the antenna is not connected correctly, the quality of reception may be impaired. If images are not displaying correctly, check whether the antenna connection is correct or not.
- To view both analogue and digital broadcasts with a single connecting cable, use the provided "loop" antenna cable. For optimum picture quality, connect an antenna cable directly to a single (either digital or analogue) antenna terminal.

Routing cables

Use the speed clamps as necessary to route the connecting cables. The diagrams below show the location of the holes on the rear of the display.

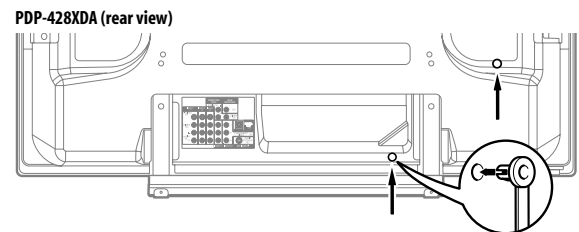
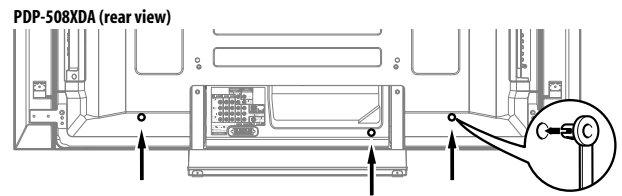

Attaching and removing speed clamps

Insert **[1]** into an appropriate hole on the rear of the plasma television and snap **[2]** into the back of **[1]** to lock the clamp.

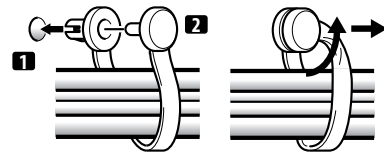

- Speed clamps are designed to be difficult to undo once in place. Please attach them carefully.
- Use pliers to twist the clamp 90°, pulling outward. The clamp may deteriorate over time and become damaged if removed.
- Be careful not to subject any connecting cables to strain.

Note

- Use the speed clamps as necessary.

Tidying the speaker cables (PDP-508XDA only)

Use the supplied bead bands as necessary to tidy the speaker cables.

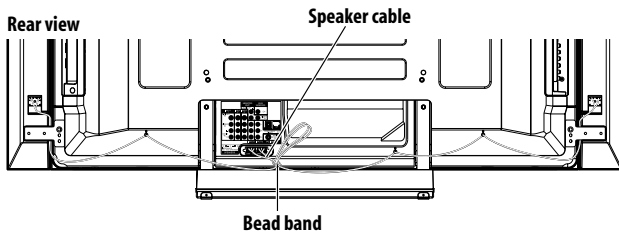

Note

- When tidying up your speaker cables, make sure to bundle them so that they are not subjected to any pressure.
- Disconnect the power cord from the power outlet when the plasma television is not going to be used for a long period of time.

Connecting the power cord

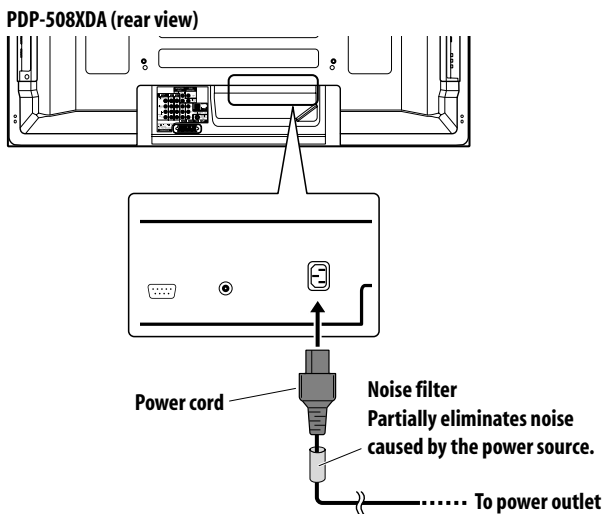

Note

- Disconnect the power cord from the power outlet when the plasma television is not going to be used for a long period of time.
- After all other components are connected, connect the power plug to the AC outlet.

Preparing the remote control unit

Inserting batteries

- 1 Open the battery cover.

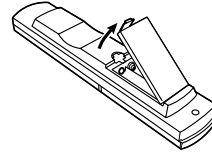

- 2 Load the supplied two AA size batteries while inserting their respective negative polarity (-) ends first.

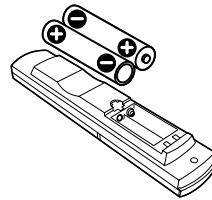

Place batteries with their terminals corresponding to the (+) and (-) indicators in the battery compartment.

- 3 Close the battery cover.

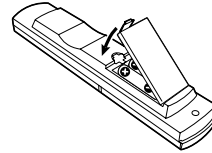

Caution

Improper use of batteries can result in chemical leakage or an explosion. Be sure to follow the instructions below.

- When you replace the batteries, use manganese or alkaline ones.
- Place the batteries with their terminals corresponding to the (+) and (-) indicators.
- Do not mix batteries of different types. Different types of batteries have different characteristics.
- Do not mix old and new batteries. Mixing old and new batteries can shorten the life of new batteries or cause chemical leakage in old batteries.
- Remove batteries as soon as they have worn out. Chemicals that leak from batteries can cause a rash. If you find any chemical leakage, wipe thoroughly with a cloth.
- The batteries supplied with this product may have a shorter life expectancy due to storage conditions.
- If you will not use the remote control unit for an extended period of time, remove the batteries from it.
- **WHEN DISPOSING OF USED BATTERIES, PLEASE COMPLY WITH GOVERNMENTAL REGULATIONS OR ENVIRONMENTAL PUBLIC INSTITUTION'S RULES THAT APPLY IN YOUR COUNTRY/AREA.**

Operating range of the remote control unit

Operate the remote control unit while pointing it toward the remote control sensor located at the bottom right of the front panel of the plasma television. The distance from the remote control sensor must be within 7 m and the angle relative to the sensor must be within 30 degrees in the right, left, upward, or downward direction.

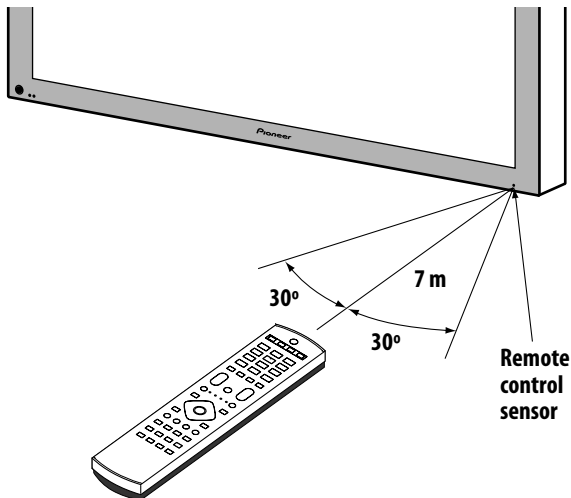

Note

- For the remote control sensor located on the PDP-428XDA, see *Part names* on page 12.

Caution

- Do not expose the remote control unit to shock. In addition, do not expose the remote control unit to liquids, and do not place in an area with high humidity.
- Do not install or place the remote control unit under direct sunlight. The heat may cause deformation of the unit.
- The remote control unit may not work properly if the remote control sensor of the plasma television is under direct sunlight or strong lighting. In such case, change the angle of the lighting or plasma television, or operate the remote control unit closer to the remote control sensor.
- When any obstacle exists between the remote control unit and the remote control sensor, the remote control unit may not function.
- As the batteries become empty, the remote control unit can function within a shorter distance from the remote control sensor. Replace the batteries with new ones early enough.
- The plasma television emits very weak infrared rays from its screen. If you place such equipment operated through infrared remote control as a VCR nearby, that equipment may not receive commands from its remote control unit properly or entirely. If this is the case, place that equipment at a location far enough from the plasma television.
- Depending on the installation environment, infrared rays from the plasma television may not allow this system to properly receive commands from the remote control unit or may shorten allowable distances between the remote control unit and the remote control sensor. The strength of infrared rays emitted from the screen differs, depending on images displayed on the screen.

Chapter 6

Watching TV

Important

- Before watching broadcast channels, the built-in TV tuner must be set up. See *Setting up TV channels automatically* on page 27 for how to do this.

Turning the power on

- Press **⏻** on the plasma television when the **POWER ON** and **STANDBY** indicators are off.
 - The system is on.
 - The POWER ON indicator lights up blue.
- Press **⏻** or **0** to **9** on the remote control unit or **STANDBY/ON** on the plasma television if the **STANDBY** indicator lights up red.
 - The POWER ON indicator lights up blue.
 - If you press **0** on the remote control unit, images from "INPUT 1" will be displayed.
 - If you press **1** to **9**, TV images will be displayed.

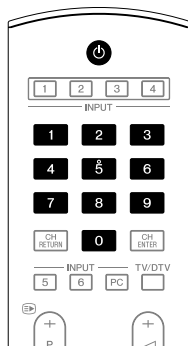
**Placing the system into standby**

- Press **⏻** on the remote control unit or **STANDBY/ON** on the plasma television.
 - The STANDBY indicator lights up red.
 - The system enters the standby mode and the image on the screen disappears.

Note

- When **⏻** on the plasma television is off, you cannot turn the power on by pressing **⏻** or **0** to **9** on the remote control unit or **STANDBY/ON** on the plasma television.
- If you are not going to use the plasma television for a long period of time, be sure to remove the power cord from the power outlet.

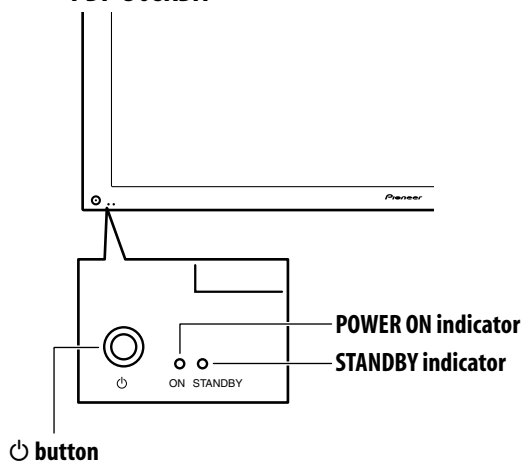
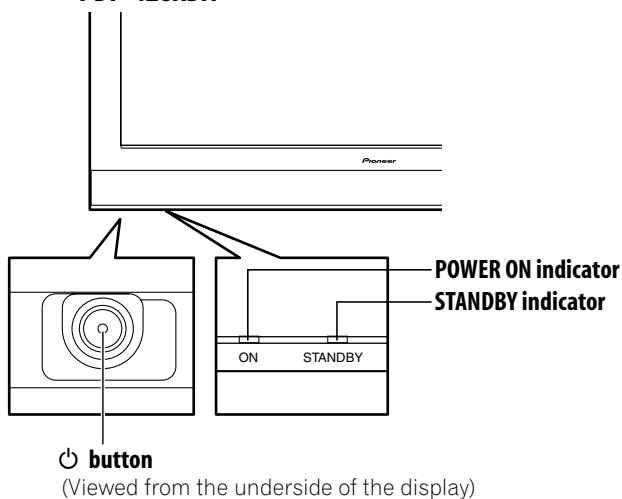
PDP-508XDA**PDP-428XDA****Plasma television status indicators**

The table below shows the operational status of the plasma television. You can check the current status of the system with the indicators on the plasma television.

Indicator status		System status
POWER ON	STANDBY	
●	●	The power cord of the plasma television has been disconnected. Or, the power cord of the plasma television has been connected but the ⏻ button of the plasma television is off.
☀	●	Power to the system is on
●	☀	The system is in the standby mode

For other than the above, see *Troubleshooting* on page 72.

Note

- You can select "Auto", "High", "Mid" or "Low" for the brightness of the POWER ON indicator. When "Auto" is selected, the brightness of the indicator changes to "High", "Mid" or "Low" to match the brightness level of the viewing area. For details, see *Blue LED Dimmer* on page 48.

Changing channels

Use the remote control or the control panel on the right-hand side of the plasma television to change channels.

- Before operating with the remote control unit, make sure to select the TV mode using its **SELECT** button. See *Controlling other equipment using the supplied remote control unit* on page 60.

Switching between the TV and DTV modes

- Press **INPUT** on the plasma television or **TV/DTV** on the remote control unit to select the DTV or TV input mode.

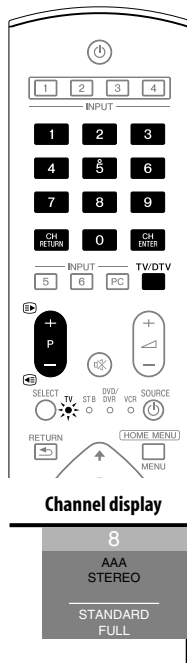

Using P+/P- on the remote control unit

- Press **P+** to increase the channel number.
- Press **P-** to decrease the channel number.

Note

- Press **CH RETURN** to switch back to the previous channel. Press **CH RETURN** again to return to the current channel.
- CHANNEL+/-** on the plasma television operates the same as **P+/P-**.
- P+/P-** cannot pick up analogue channels that are set to skip. For analogue channel skip, see steps 13 and 14 under *Setting up analogue TV channels manually* (page 27).
- While in DTV mode, **P+/P-** cannot pick up digital channels that are not registered as favourites, with the Channel Change function set to "Favourites List". See *Customizing channel related settings* on page 39.

Using 0 to 9 on the remote control unit

- Select channels directly by pressing buttons **0** to **9**.

For example:

Press **2** to select channel 2 (one-digit channel).

Press **1** then **2** to select channel 12 (two-digit channel).

While in DTV mode, press **1**, **2** then **3** to select channel 123 (three-digit channel).

Note

- Press **CH RETURN** to switch back to the previous channel. Press **CH RETURN** again to return to the current channel.
- After entering a channel number you can press **CH ENTER** to tune in the channel more quickly.
- In standby, when you press **0**, the power turns on and images come from the "INPUT 1" source. Or, when you press any button from **1** to **9**, TV images are displayed.

Changing the volume and sound

Use the remote control or the control panel on the right-hand side of the plasma television to adjust the volume.

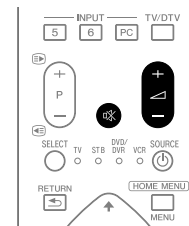

Using + / - on the remote control unit

- Press **+** to increase the volume.
- Press **-** to decrease the volume.

Volume adjustment



- VOLUME +/-** on the plasma television operates the same as **+ / -**.

Using Mute on the remote control unit

- Press **Mute** to mute the sound. **Mute** appears on the screen.

Muting



- Press **Mute** again or **+** to restore the sound.

Switching the broadcast audio channel

Depending on the broadcast, you can switch the audio channel.

- Before operating with the remote control unit, make sure to select the TV mode using its **SELECT** button. See *Controlling other equipment using the supplied remote control unit* on page 60.

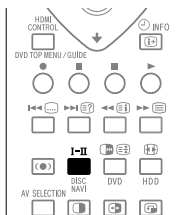

- While watching an analogue TV channel, press I-II to change the audio channel.

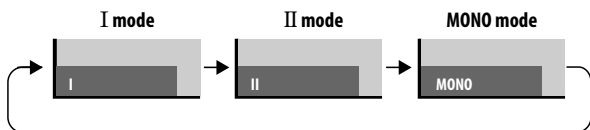

The table below shows the available audio channels by analogue broadcast audio type.

		Setting		
		I	II	MONO
NICAM Broadcasts	Stereo	1 AAA NICAM STEREO	1 AAA NICAM STEREO	1 AAA MONO
	Bilingual	2 BBB NICAM I	2 BBB NICAM II	2 BBB MONO
	Monaural	3 CCC NICAM MONO	3 CCC NICAM MONO	3 CCC MONO
A2 Broadcasts	Stereo	4 DDD STEREO	4 DDD STEREO	4 DDD MONO
	Bilingual	5 EEE DUAL I	5 EEE DUAL II	5 EEE MONO
	Monaural	6 FFF MONO	6 FFF MONO	6 FFF MONO
BTSC Broadcasts	Stereo	4 GGG STEREO	4 GGG STEREO	4 GGG MONO
	MAIN + SAP	5 HHH MONO (SAP)	5 HHH SAP (MAIN)	5 HHH MONO
	Stereo + SAP	5 JJJ (STEREO + SAP)	5 JJJ SAP (STEREO)	5 JJJ MONO
	Monaural	6 KKK MONO	6 KKK MAIN	6 KKK MONO

- While watching a digital TV channel, press I-II to change the audio channel.

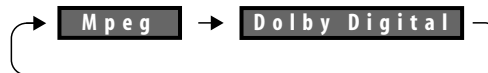

The table below shows the available channel number displayed when receiving digital TV broadcasts.

	Setting	
	Mpeg	Dolby Digital
Digital Broadcasts	D 001 GGG	D 001 GGG

Note

- Selecting a sound multiplex mode while the input source is "INPUT 1" to "INPUT 6" or "PC" does not change the type of sound. In this case, sound is determined by the video source.

In analogue TV mode:

- In each of the sound multiplex mode selected using the I-II button, the display changes depending on broadcasting signals being received.
- Once the MONO mode is selected, the plasma television sound remains mono even if the system receives a stereo broadcast. You must switch the mode back to I or II mode if you want to hear stereo sound again.

- While watching an analogue TV channel with any High Deviation setting (page 28), you cannot change the sound multiplex mode.

In digital TV mode:

- "Mpeg" or "Dolby Digital" may only be selected depending on the received broadcasting signals.
- As the broadcasting channel being received is switched to that containing Mpeg stream only, the audio channel is automatically switched to "Mpeg" even while "Dolby Digital" is selected.

Using the multiscreen functions

Before operating with the remote control unit, make sure to select the TV mode using its **SELECT** button. See *Controlling other equipment using the supplied remote control unit* on page 60.

Splitting the screen

Use the following procedure to select the 2-screen or picture-in-picture mode.

 **Note**

- Displaying a split screen for a long period of time, or for shorter periods of time everyday, may result in image retention.

2-Screen

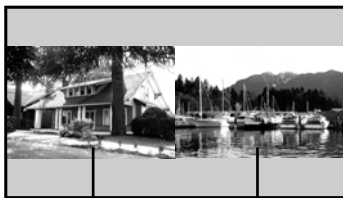

Main screen Sub screen

Picture-in-picture



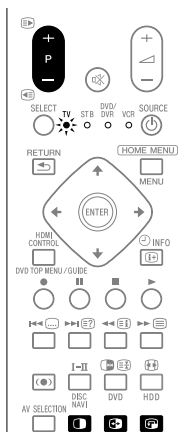

Main screen Sub screen





1 Press  to select the display mode.

Each time you press , the display mode is switched among 2-screen, picture-in-picture, and single-screen modes.

- In 2-screen or picture-in-picture mode, press  to switch the position of the two screens shown.

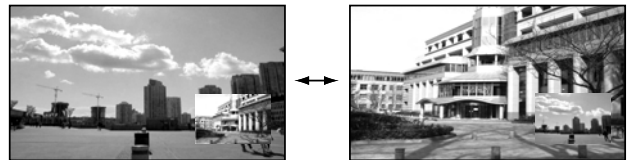
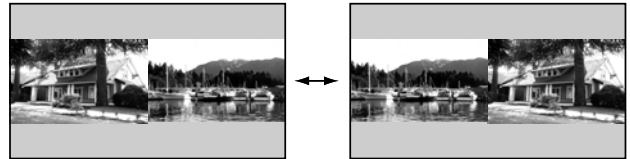
- The left screen (in the 2-screen mode) or the larger screen (in the picture-in-picture mode) is the active screen, indicated by a  icon. You can use any of the normal functions to change the picture and sound.



- In picture-in-picture mode, press  to move the position of the small screen anti-clockwise.

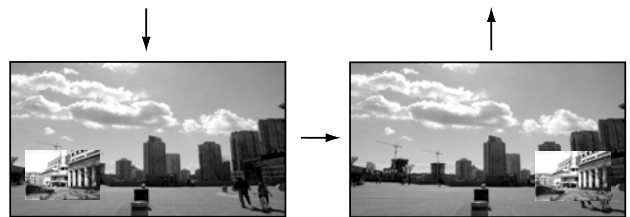
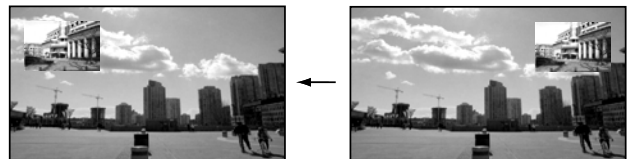

2 To select the desired input source, press the appropriate input source button.

- If watching TV programmes, press **P+/P-** to change the channel.

 **Note**

- The multiscreen function cannot display images from the same input source at the same time. If you make such an attempt, a warning message appears.
- The multiscreen function cannot display images from combinations of two external input sources ("INPUT 1" to "INPUT 6", "PC"). It can display images from the following combination of input sources:
 - Analogue TV and digital TV
 - Analogue TV (or digital TV) and external source ("INPUT 1" to "INPUT 6", "PC")
- When you press **HOME MENU**, the single-screen mode is restored and the corresponding menu is displayed.
- When in the 2-screen mode, images displayed on the right screen may look less fine, depending on images.
- With headphones connected, you can listen to audio coming from the sub screen when in the 2-screen or picture-in-picture mode. For more information, see page 35.

Freezing images

Use the following procedure to capture and freeze one frame from a moving image that you are watching.

- Before operating with the remote control unit, make sure to select the TV mode using its **SELECT** button. See *Controlling other equipment using the supplied remote control unit* on page 60.

Important

- Displaying a static image for a long period of time, or for shorter periods of time everyday, may result in image retention.

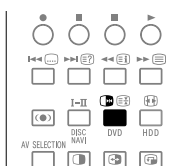

- Press .

A still image appears on the right screen while a moving image is shown on the left screen.



- Press  again to cancel the function.

Note

- You cannot freeze the picture when using the 2-screen or picture-in-picture mode.
- When this function is not available, a warning message appears.

Chapter 7

The HOME MENU

HOME MENU overview

For AV source

HOME MENU	Item	Page	
Picture	AV Selection	30	
	Contrast	31	
	Brightness	31	
	Colour	31	
	Tint	31	
	Sharpness	31	
	Pro Adjust	31	
	Reset	31	
Sound	Treble	35	
	Bass	35	
	Balance	35	
	Reset	35	
	Sound Effect	35	
	Headphone Output	35	
	Sub Volume	35	
Power Control	Energy Save	36	
	No Signal off	36	
	No Operation off	36	
Sleep Timer	-	49	
Option	Position	45	
	Auto Size	47	
	Side Mask	47	
	HDMI Input	54	
	HDMI Control Setting	68	
	Blue LED Dimmer	48	
	Orbiter	49	
	Video Pattern	49	
	Drive Mode	45	
	Colour System	46	
	Monitor Out	54	
	Game Control Pref	46	
	Room Light Sensor	48	
	Setup	Auto Installation	27
		Analogue TV Setup	27
DTV Setup		38	
Password		49	
Language		29	
Home Gallery	-	57	
HDMI Control	-	65	

For PC source

HOME MENU	Item	Page
Picture	AV Selection	30
	Contrast	31
	Brightness	31
	Red	31
	Green	31
	Blue	31
	Reset	31
	Sound	Same as the AV source
Power Control	Energy Save	36
	Power Management	37
Sleep Timer	-	49
Option	Auto Setup	45
	Manual Setup	46
	HDMI Input	54
	HDMI Control Setting	68
Home Gallery	-	57
HDMI Control	-	65

Using the HOME MENU

The following describes the typical procedure for setting up the menus. For the actual procedures, see the appropriate pages that describe individual functions.

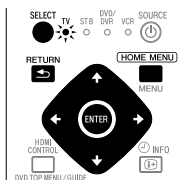

- 1 Press **HOME MENU**.
- 2 Press **↑/↓** to select a menu item, and then press **ENTER**.
- 3 Repeat step 2 until you access the desired submenu item.
The number of menu layers differs depending on the menu items.
- 4 Press **←/→** to select an option (or parameter), and then press **ENTER**.
For some menu items, press **↑/↓** instead of **←/→**.
- 5 Press **HOME MENU** to exit the menu.

Note

- You can return to the upper menu levels by pressing **RETURN**.
- Before operating with the remote control unit, make sure to select the TV mode using its **SELECT** button. See *Controlling other equipment using the supplied remote control unit* on page 60.

Chapter 8

Setting up

Setting up TV channels automatically

This section describes how to automatically search for and set up TV channels.

Using Auto Installation

When the plasma television is switched on for the first time after purchase, the initial auto installation is initiated. You can set tuner type and region in successive operations.



- 1 Select **"Tuner Type"** (↑/↓).
- 2 Select the desired tuner type (←/→).
 - You can select from "All", "Digital" or "Analogue".
 - When you select "All", set up DTV channels then analogue channels in successive operations. When you select "Digital", only DTV channels are scanned. Likewise, when you select "Analogue", only analogue TV channels are scanned.
- 3 Select **"Region"** (↑/↓).
- 4 Select your region (←/→).
 - Select the city or region in which you live. If it is not listed, select "Auto Detection" for automatic setup.
- 5 Select **"Start"** (↑/↓ then ENTER).
 - Auto Installation automatically starts.
 - To quit Auto Installation in progress, press RETURN.

Note

- You can start Auto Installation from the HOME MENU after moving to another city, for example. Perform the following steps before starting Auto Installation: Press **HOME MENU**, select **"Setup"** (↑/↓ then ENTER), then **"Auto Installation"** (↑/↓ then ENTER). The password entry screen appears. Enter your four-digit password using buttons **0** to **9**. For the password, see *Using a password* on page 49.
- If no channels are found, check the antenna connections, and then retry Auto Installation.

Setting up analogue TV channels manually

Use the Manual Adjust function to set up analogue TV channels manually.

- 1 Press **HOME MENU**.
- 2 Select **"Setup"** (↑/↓ then ENTER).
- 3 Select **"Analogue TV Setup"** (↑/↓ then ENTER).
 - The password entry screen appears. Enter your four-digit password using buttons **0** to **9**. For the password, see *Using a password* on page 49.
- 4 Select **"Manual Adjust"** (↑/↓ then ENTER).
- 5 Select **"Programme Entry"** (↑/↓).
- 6 Select a programme number (←/→).
 - You can select 1 through 99.

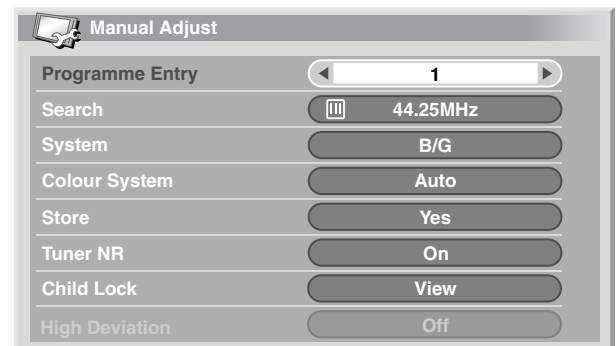

- 7 Select **"Search"** (↑/↓).
- 8 Enter a frequency using buttons **0** to **9**, then ENTER.
 - You can also press ←/→ to enter a frequency.
- 9 Select **"System"** (↑/↓).
- 10 Select a sound system (←/→).
 - You can select from among "B/G", "D/K", "I", "M/N".
- 11 Select **"Colour System"** (↑/↓).
- 12 Select a colour system (←/→).
 - You can select from "Auto", "PAL", "NTSC", "SECAM", "PAL-M", "PAL-N", and "4.43NTSC".
- 13 Select **"Store"** (↑/↓).
- 14 Select **"Yes"** (←/→).
 - With "Yes" selected, you can select the channel using **P+/P-**. With "No" selected, you cannot select the channel using **P+/P-**.
- 15 Press **HOME MENU** to exit the menu.
 - Alternatively, to set up for another channel, repeat steps 5 to 14.

Note

- Manual Adjust also allows you to make selections for "Tuner NR", "Child Lock", and "High Deviation". See *Reducing video noise*, *Setting Child Lock*, and *Suppressing audio distortion* respectively.
- This plasma television is equipped with the auto frequency tuning function that automatically adjusts tuning frequencies according to received signals. For this reason, the Manual Adjust menu may show slightly different frequencies from your entry when you access the menu next time. You cannot deactivate the Auto Frequency Tuning function.

Reducing video noise

For the individual channels, you can specify whether the plasma television should reduce video noise depending on the levels of broadcasting signals.

- 1 Press **HOME MENU**.
- 2 Select **"Setup"** (↑/↓ then ENTER).
- 3 Select **"Analogue TV Setup"** (↑/↓ then ENTER).
The password entry screen appears. Enter your four-digit password using buttons **0** to **9**. For the password, see *Using a password* on page 49.
- 4 Select **"Manual Adjust"** (↑/↓ then ENTER).
- 5 Select **"Programme Entry"** (↑/↓).
- 6 Select a programme number (←/→).
You can select 1 through 99.
- 7 Select **"Tuner NR"** (↑/↓).
- 8 Select **"On"** (←/→).

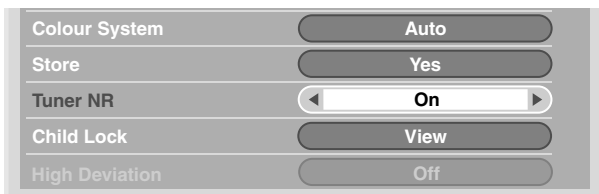

- 9 Press **HOME MENU** to exit the menu.

Note

- This function may not achieve a satisfactory result, depending on the conditions of broadcasting signals.
- The factory default is "On".

Setting Child Lock

Child Lock inhibits selected TV channels from being tuned and watched.

- 1 Repeat steps 1 to 6 provided for *Reducing video noise*. After selecting a programme number (using Programme Entry), perform the following steps:
- 2 Select **"Child Lock"** (↑/↓).
- 3 Select **"Block"** (←/→).
 - The selection is switched between "View" (factory default) and "Block".
- 4 Press **HOME MENU** to exit the menu.

Suppressing audio distortion

You can suppress audio distortion that may be induced when too strong audio signals are received in the selected channel.

Note

- High Deviation is selectable only when you have selected "D/K" for "System" under *Setting up analogue TV channels manually* on page 27.
- 1 Repeat steps 1 to 6 provided for *Reducing video noise*. After selecting a programme number (using Programme Entry), perform the following steps:
 - 2 Select **"High Deviation"** (↑/↓).
 - 3 Select **"High", "Mid" or "Low"** (←/→).

Item	Description
Off	Deactivates the function
High	Suppresses audio distortion slightly; however, the audio volume is slightly lowered than when Off is selected
Mid	Suppresses audio distortion moderately
Low	Suppresses audio distortion further; however, the audio volume is further lowered

- 4 Press **HOME MENU** to exit the menu.

Note

- While watching a TV channel with any High Deviation setting, you cannot change the sound multiplex mode.

Labeling TV channels

You can name TV channels that you have set up, using up to five characters. This may help you easily identify the channels during selections.

- 1 Press **HOME MENU**.
- 2 Select **"Setup"** (↑/↓ then **ENTER**).
- 3 Select **"Analogue TV Setup"** (↑/↓ then **ENTER**).
Enter your four-digit password using buttons **0** to **9** when prompted.
- 4 Select **"Label"** (↑/↓ then **ENTER**).
- 5 Select **"Programme Entry"** (↑/↓).
- 6 Select a **programme number** (←/→).
You can select 1 through 99.



- 7 Select **"Label"** (↑/↓ then **ENTER**).
The name entry screen appears.
- 8 Select the **first character** (↑/↓/←/→ then **ENTER**).

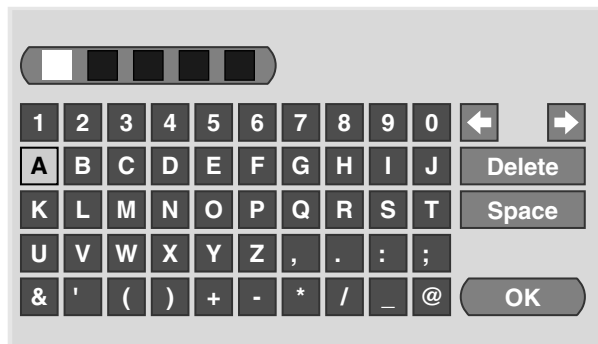

- The cursor moves to the second character.

- 9 Repeat **step 8** to enter up to five characters.
 - To correct entered characters, select [←] or [→] on the screen, and then press **ENTER**. The cursor moves to the preceding or subsequent character.
 - To delete the current character, select [**Delete**] on the screen, and then press **ENTER**.
 - To put a space for the current character, select [**Space**] on the screen, and then press **ENTER**.
- 10 To complete the name entry, press ↑/↓ or ←/→ to select [**OK**] on the screen, and then press **ENTER**.
- 11 Press **HOME MENU** to exit the menu.

Sorting preset TV channels

Use the following procedure to change the sequence of the preset TV programmes.

- 1 Press **HOME MENU**.
- 2 Select **"Setup"** (↑/↓ then **ENTER**).
- 3 Select **"Analogue TV Setup"** (↑/↓ then **ENTER**).
Enter your four-digit password using buttons **0** to **9** when prompted.
- 4 Select **"Sort"** (↑/↓ then **ENTER**).
The sort screen appears.

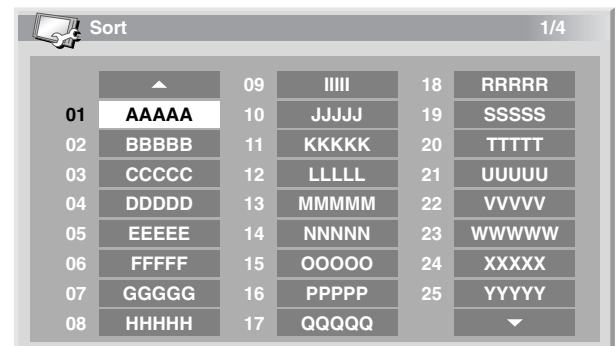

- 5 Select a channel to be shifted (↑/↓/←/→ then **ENTER**).
- 6 Select a new location (↑/↓/←/→ then **ENTER**).
Sorting is executed.
- 7 Press **HOME MENU** to exit the menu.

Note

- To change a page on the Sort screen in step 6, select ▲/▼ on the screen with ↑/↓ to select a page, and then press **ENTER**.

Language setting

For the language to be used in the Teletext mode while watching an analogue TV channel, you can select from among West Europe, East Europe, Greece/Turkey, Russia, and Arabia.

- 1 Press **HOME MENU**.
- 2 Select **"Setup"** (↑/↓ then **ENTER**).
- 3 Select **"Language"** (↑/↓ then **ENTER**).
- 4 Select a language (←/→).



- 5 Press **HOME MENU** to exit the menu.

Note

- Teletext language supported by DTV is only English.

AV Selection

Select from the seven viewing options depending on the current environment (e.g., room brightness), the type of the current TV programme, or the type of images input from external equipment.

- 1 Press **HOME MENU**.
- 2 Select **"Picture"** (↑/↓ then **ENTER**).
- 3 Select **"AV Selection"** (↑/↓ then **ENTER**).
- 4 Select the desired option (↑/↓ then **ENTER**).

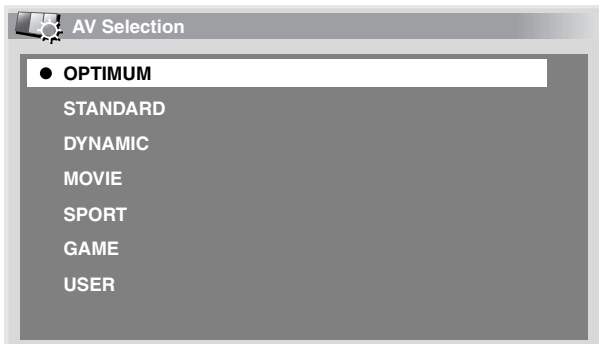

For AV source

Item	Description
OPTIMUM	Automatically adjusts the brightness of the image to the optimum level in accordance with the brightness level of the viewing area. The setting is shared by the external inputs and TV input sources.
STANDARD	For a highly defined image in a normally bright room. This setting is shared by the external inputs and TV input sources.
DYNAMIC	Sharp imaging with the maximum contrast. Note that this mode does not allow manual image quality adjustment. This setting is shared by the external inputs and TV input sources.
MOVIE	Optimized for movies. This setting is shared by the external inputs and TV input sources.
SPORT	Optimized for sports programmes. This setting is shared by the external inputs and TV input sources.
GAME	Lowers image brightness for easier viewing. This setting is shared by the external inputs and TV input sources.
USER	Allows the user to customize settings as desired. You can set the mode for each input source.

For PC source

Item	Description
STANDARD	For a highly defined image in a normally bright room
USER	Allows the user to customize settings as desired. You can set the mode for each input source.

- 5 Press **HOME MENU** to exit the menu.

Note

- You can also press **AV SELECTION** on the remote control to change the viewing option.
- If you have selected "DYNAMIC", you cannot select "Contrast", "Brightness", "Colour", "Tint", "Sharpness", "Pro Adjust", and "Reset"; these menu items are dimmed.
- If you have selected "OPTIMUM", you cannot select "Pro Adjust"; menu items in "Pro Adjust" are dimmed.
- As "OPTIMUM" automatically optimizes image quality, the process in which image settings such as brightness and tint gradually change may be seen on the screen. This is not a malfunction.
- When "OPTIMUM" is selected, images are reproduced based on the information collected at the Room Light Sensor as well, regardless of its setting ("On" or "Off") for the "Option" menu.

Basic picture adjustments

Adjust the picture to your preference for the chosen AV Selection option (except DYNAMIC).

- 1 Press **HOME MENU**.
- 2 Select **"Picture"** (↑/↓ then **ENTER**).
- 3 Select an item to be adjusted (↑/↓ then **ENTER**).

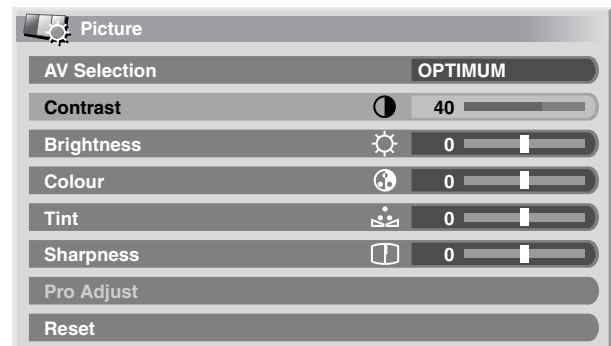

For PC source or when the Home Gallery function is on, the following screen appears.

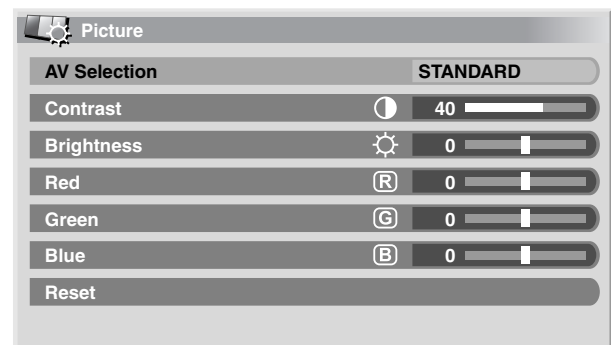

- 4 Select the desired level (←/→).

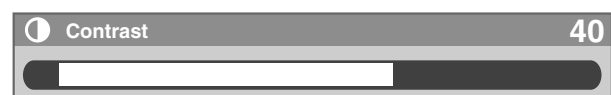

When the bar is in display, you can also change the item to be adjusted, by pressing **↑/↓**.

5 Press HOME MENU to exit the menu.

For AV source

Item	← button	→ button
Contrast	For less contrast	For more contrast
Brightness	For less brightness	For more brightness
Colour	For less colour intensity	For more colour intensity
Tint	Skin tones become purplish	Skin tones become greenish
Sharpness	For less sharpness	For more sharpness

For PC source

Item	← button	→ button
Contrast	For less contrast	For more contrast
Brightness	For less brightness	For more brightness
Red	For weaker red	For stronger red
Green	For weaker green	For stronger green
Blue	For weaker blue	For stronger blue

Note

- To perform advanced picture adjustments, select "Pro Adjust" in step 3 and then press **ENTER**. For the subsequent procedures see *Advanced picture adjustments*.
- To restore the factory defaults for all items, press **↑/↓** to select "Reset" in step 3, and then press **ENTER**. A confirmation screen appears. Press **←/→** to select "Yes", and then press **ENTER**.
- You may experience a sudden change in the image position and screen brightness when you open the "Picture" menu.

Advanced picture adjustments

The plasma television provides various advanced functions for optimizing the picture quality. For details on these functions, see the tables.

Using PureCinema

- Press **HOME MENU**.
- Select "Picture" (**↑/↓** then **ENTER**).
- Select "Pro Adjust" (**↑/↓** then **ENTER**).
- Select "PureCinema" (**↑/↓** then **ENTER**).
- Select "Film Mode" or "Text Optimisation" (**↑/↓** then **ENTER**).
- Select the desired parameter (**↑/↓** then **ENTER**).
For the selectable parameters, see the table.

PureCinema

Automatically detects a film-based source (originally encoded at 24 frames/second), analyses it, then recreates each still film frame for high-definition picture quality

Film Mode	Off	Deactivates PureCinema
Standard		Produces smooth and vivid moving images (film specific) by automatically detecting recorded image information when displaying DVD or high-definition images (e.g., movies) having 24 frames per second
Smooth		Produces smoother and more vivid moving images
Advance		Produces smooth and quality moving images (as shown on theatre screens) by converting to 72 Hz when displaying DVD images (e.g., movies) having 24 frames per second
Text Optimisation	Off	Deactivates Text Optimisation
	On	Activates Text Optimisation

7 Press HOME MENU to exit the menu.

Note

- "Standard" is not selectable for the following input signals: 480p, 576p, 720p@50 Hz, 720p@60 Hz, 1080p@50 Hz, 1080p@60 Hz.
- "Advance" is not selectable for the following input signals: PAL, SECAM, 576i, 576p, 720p@50 Hz, 1080i@50 Hz, 1080p@50 Hz/60 Hz.
- "Smooth" is not selectable for the following input signals: 1080p@50 Hz, 1080p@60 Hz.
- When you select "On" for "Game Control Pref" on the "Option" menu, the "PureCinema" setting is disabled.

Using Intelligent Mode

- Press **HOME MENU**.
- Select "Picture" (**↑/↓** then **ENTER**).
- Select "Pro Adjust" (**↑/↓** then **ENTER**).
- Select "Intelligent Mode" (**↑/↓** then **ENTER**).
- Select the desired parameter (**↑/↓** then **ENTER**).

Intelligent Mode

Performs such compensation that results in the optimum colour tones and brightness for images

Selections	Off	Deactivates Intelligent Mode
	On	Activates Intelligent Mode

6 Press HOME MENU to exit the menu.

Note

- As this function automatically optimizes image quality, the process in which image settings such as brightness and tint gradually change may be seen on the screen. This is not a malfunction.

Using the Picture Detail

- 1 Press **HOME MENU**.
- 2 Select "Picture" (↑/↓ then **ENTER**).
- 3 Select "Pro Adjust" (↑/↓ then **ENTER**).
- 4 Select "Picture Detail" (↑/↓ then **ENTER**).
- 5 Select an item to be adjusted (↑/↓ then **ENTER**).
 - You can select "DRE Picture", "Black Level", "ACL", "Enhancer Mode" or "Gamma".
- 6 Select the desired parameter (↑/↓ then **ENTER**).

DRE Picture

Emphasizes the contrast on images so that the difference between brightness and darkness becomes more distinct

Selections	Off	Deactivates DRE Picture
	High	Enhanced DRE Picture
	Mid	Standard DRE Picture
	Low	Moderate DRE Picture

Black Level

Emphasizes dark portion on images so that the difference between brightness and darkness becomes more distinct

Selections	Off	Deactivates Black Level
	On	Activates Black Level

ACL

Performs such compensation that results in the optimum contrast characteristics for images

Selections	Off	Deactivates ACL
	On	Activates ACL

Enhancer Mode

Selects processing of the image's high frequency (detailed) areas

Selections	1	Selects Hard (SHARPNESS) image
	2	Selects Natural (SHARPNESS) image
	3	Selects Soft (SHARPNESS) image

Gamma

Adjusts the gamma characteristics (image gradation characteristics)

Selections	1	Selects gamma characteristics 1
	2	Selects gamma characteristics 2
	3	Selects gamma characteristics 3

- 7 Press **HOME MENU** to exit the menu.

Using Colour Temp

- 1 Press **HOME MENU**.
- 2 Select "Picture" (↑/↓ then **ENTER**).
- 3 Select "Pro Adjust" (↑/↓ then **ENTER**).
- 4 Select "Colour Detail" (↑/↓ then **ENTER**).
- 5 Select "Colour Temp" (↑/↓ then **ENTER**).
- 6 Select the desired parameter (↑/↓ then **ENTER**).

Colour Temp

Adjusts the colour temperature, resulting in a better white balance

Selections	High	White with bluish tone
	Mid-High	Intermediate tone between High and Mid
	Mid	Natural tone
	Mid-Low	Intermediate tone between Mid and Low
	Low	White with reddish tone
	Manual	Colour temperature adjusted to your preference

- You may rather want to perform fine adjustment. To do this, select "Manual" first and then press and hold **ENTER** for more than three seconds. The manual adjustment screen appears. Then go to step 7.

- 7 Select an item to be adjusted (↑/↓ then **ENTER**).
- 8 Select the desired level (←/→).

Item		← button	→ button
R High	Fine adjustment for bright portions	For weaker red	For stronger red
G High		For weaker green	For stronger green
B High		For weaker blue	For stronger blue
R Low	Fine adjustment for dark portions	For weaker red	For stronger red
G Low		For weaker green	For stronger green
B Low		For weaker blue	For stronger blue

- To perform adjustment for another item, press **RETURN**, and then repeat steps 7 and 8.
- You may press ↑/↓ to immediately change an item to be adjusted.

- 9 Press **HOME MENU** to exit the menu.

Using CTI and Colour Space

- 1 Press HOME MENU.
- 2 Select "Picture" (↑/↓ then ENTER).
- 3 Select "Pro Adjust" (↑/↓ then ENTER).
- 4 Select "Colour Detail" (↑/↓ then ENTER).
- 5 Select "CTI" or "Colour Space" (↑/↓ then ENTER).
- 6 Select the desired parameter (↑/↓ then ENTER).

CTI		
Provides images with clearer colour contours. The CTI stands for Colour Transient Improvement.		
Selections	Off	Deactivates CTI
	On	Activates CTI

Colour Space		
Changes the colour reproduction space		
Selections	1	Optimized for vivid, vibrant colour reproduction
	2	Standard colour reproduction

- 7 Press HOME MENU to exit the menu.

Using Colour Management

- 1 Press HOME MENU.
- 2 Select "Picture" (↑/↓ then ENTER).
- 3 Select "Pro Adjust" (↑/↓ then ENTER).
- 4 Select "Colour Detail" (↑/↓ then ENTER).
- 5 Select "Colour Management" (↑/↓ then ENTER).
- 6 Select an item to be adjusted (↑/↓ then ENTER).

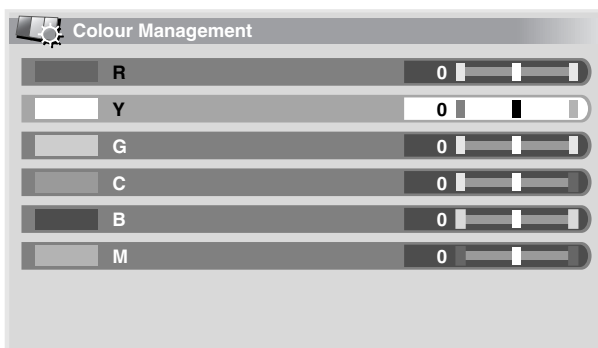

- 7 Select the desired level (←/→).

Item	← button	→ button
R	Closer to magenta	Closer to yellow
Y	Closer to red	Closer to green
G	Closer to yellow	Closer to cyan
C	Closer to green	Closer to blue
B	Closer to cyan	Closer to magenta
M	Closer to blue	Closer to red

- To perform adjustment for another item, press **RETURN**, and then repeat steps 6 and 7.
- You may press ↑/↓ to immediately change an item to be adjusted.

- 8 Press HOME MENU to exit the menu.

Eliminating noise from images

- 1 Press HOME MENU.
- 2 Select "Picture" (↑/↓ then ENTER).
- 3 Select "Pro Adjust" (↑/↓ then ENTER).
- 4 Select "Noise Reduction" (↑/↓ then ENTER).
- 5 Select an item to be adjusted (↑/↓ then ENTER). You can select "3DNR", "Field NR", "Block NR" or "Mosquito NR".
- 6 Select the desired parameter (↑/↓ then ENTER).

3DNR		
Eliminates video noise for clean crisp images. 3DNR stands for 3-dimensional Noise Reduction.		
Selections	Off	Deactivates 3DNR
	High	Enhanced 3DNR
	Mid	Standard 3DNR
	Low	Moderate 3DNR

Field NR		
Removes glimmer for more natural images		
Selections	Off	Deactivates Field NR
	High	Enhanced Field NR
	Mid	Standard Field NR
	Low	Moderate Field NR

Block NR		
Helps reduce noise appearing in high-definition images		
Selections	Off	Deactivates Block NR
	On	Activates Block NR

Mosquito NR

Reduces mosquito noise in DVD and high-definition images, resulting in noise-free images

Selections	Off	Deactivates Mosquito NR
	On	Activates Mosquito NR

7 Press HOME MENU to exit the menu.

Using the 3DYC and I-P Mode

- 1 Press HOME MENU.
- 2 Select "Picture" (↑/↓ then ENTER).
- 3 Select "Pro Adjust" (↑/↓ then ENTER).
- 4 Select "Others" (↑/↓ then ENTER).
- 5 Select "3DYC" or "I-P Mode" (↑/↓ then ENTER).
- 6 Select the desired parameter (↑/↓ then ENTER).

3DYC

Optimizes characteristics for separating brightness signals and colour signals. This works for both video and still images.

Selections	Off	Deactivates 3DYC
	High	Enhanced 3DYC
	Mid	Standard 3DYC
	Low	Moderate 3DYC

I-P Mode

Performs optimum conversion from interlace signals to progressive signals. This works for both video and still images.

Selections	1	Optimum for video images
	2	Standard setting
	3	Optimum for still images

7 Press HOME MENU to exit the menu.

Note

- The 3DYC setting is ineffective when SECAM, PAL-M, PAL-N or 4.43 NTSC signals are input.
- For the I-P Mode, the individual parameters are not selectable for the following input signals: 480p, 576p, 720p, 1080p.
- The I-P Mode setting is disabled if you use an external input source and select "On" for "Game Control Pref" on the "Option" menu.
- For the 3DYC, the individual parameters are selectable only when you have selected the analogue tuner, or you have selected "INPUT 1", "INPUT 2", "INPUT 3" or "INPUT 6" as the input source and there is a video signal present.

Comparing picture adjustments on the screen

During picture adjustments, you can quickly refer to the image previously set in the same parameter, allowing you to easily compare and select the preferred image quality.

- 1 Press HOME MENU.
- 2 Select "Picture" (↑/↓ then ENTER).
- 3 Select an item to be adjusted (↑/↓ then ENTER).
- 4 While performing adjustment, press BLUE on the remote control unit.
"Before" displays and the image adjusted last time appears for comparison.
- 5 Press the button again to return to the newly adjusted image.
Each press of the button toggles between "Before" and "After".
- 6 Repeat steps 1 and 5 for other parameters.
- 7 Press HOME MENU to exit the menu.

**Caution**

- If you exit the menu by pressing HOME MENU or no operation is performed for 60 seconds, all the parameter settings displayed last are stored in memory.
- If you want to exit the menu without performing the adjustments (or leaving the settings disabled) on the "After" screen, switch to "Before" and then exit.

**Note**

- You cannot adjust any item while on the "Before" screen. A warning message appears.
- When you switch to another parameter, make sure to change the display from "Before" to "After" first, otherwise you cannot select "Before". A warning message appears if you don't.
- If you exit the selection from the "Before" screen, the previous entry is stored in the memory and the button no longer works.
- If you exit the selection from the "After" screen, the new entry is stored in the memory and the button no longer works.
- If you move and change the "AV Selection" parameter, the new entry in the current parameter is stored in the memory and the button continues to work.
- You cannot compare images between different parameters on the "AV Selection" menu ("STANDARD" and "MOVIE", for example).
- When you select this function, "Intelligent Mode" for "Pro Adjust" on the "Picture" menu, "OPTIMUM" on the "AV Selection" menu, and "Room Light Sensor" on the "Option" menu are all set to off and image quality returns to default settings.
- This function is not selectable:
 - when you select "AV Selection",
 - when you select "Yes" or "No" on the confirmation screen for "Reset" from the "Picture" menu or
 - when you select a menu from the PC source

Sound adjustments

You can adjust the sound quality to your preference with the following settings.

Adjust the sound to your preference for the chosen AV Selection option. See page 30.

- 1 Press **HOME MENU**.
- 2 Select **"Sound"** (↑/↓ then **ENTER**).
- 3 Select an item to be adjusted (↑/↓).
- 4 Select the desired level (←/→).

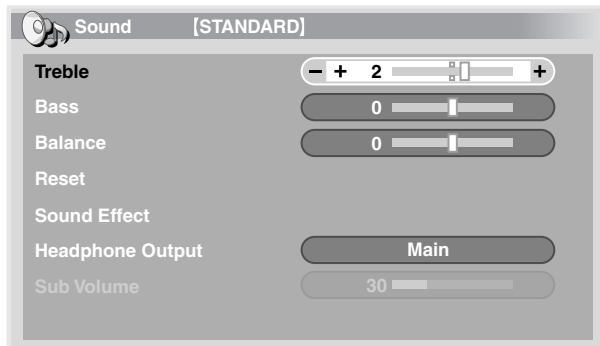

Item	← button	→ button
Treble	For weaker treble	For stronger treble
Bass	For weaker bass	For stronger bass
Balance	Shifts the audio balance to the left	Shifts the audio balance to the right

- 5 Press **HOME MENU** to exit the menu.

Note

- You cannot adjust the sound for listening with headphones.
- If you perform sound adjustments with headphones connected, the new settings will become effective as soon as you disconnect the headphones.
- To restore the factory defaults for all items, press ↑/↓ to select "Reset" in step 3, and then press **ENTER**. A confirmation screen appears. Press ←/→ to select "Yes", and then press **ENTER**.

Sound Effect

You can select from SRS FOCUS, SRS or SRS TruBass.

- 1 Press **HOME MENU**.
- 2 Select **"Sound"** (↑/↓ then **ENTER**).
- 3 Select **"Sound Effect"** (↑/↓ then **ENTER**).
- 4 Select **"SRS FOCUS", "SRS" or "SRS TruBass"** (↑/↓).
- 5 Select the desired parameter (←/→).

SRS FOCUS

Selections	Off	Deactivates SRS FOCUS®
	On	Activates SRS FOCUS® Shifts the apparent direction of the sound upward for more clearly defined sound

SRS

Selections	Off	Deactivates SRS®
	On	Activates SRS® Reproduces highly effective three-dimensional sound

SRS TruBass

Selections	Off	Deactivates SRS TruBass®
	On	Activates SRS TruBass® Provides deep, rich bass using a new technology

- 6 Press **HOME MENU** to exit the menu.

Note

- **SRS WOW** (WOW) denotes a status where SRS FOCUS®, SRS® and SRS TruBass® are on.
- You can also press (●) (Sound Effect) on the remote to change the selection.
- You cannot adjust the sound effect for listening with headphones.
- If you change the sound effect with headphones connected, the new setting will become effective as soon as you disconnect the headphones.
- The effect of this function differs depending on signals.

Listening to audio from the sub screen using headphones

With headphones connected, you can listen to audio coming from the sub screen when in the 2-screen or picture-in-picture mode; audio coming from the main screen is output from the speakers.

- 1 Press **HOME MENU**.
- 2 Select **"Sound"** (↑/↓ then **ENTER**).
- 3 Select **"Headphone Output"** (↑/↓).
- 4 Select the desired parameter (←/→).

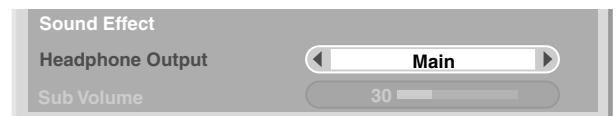

Headphone Output

Selections	Main (default)	Audio coming from the main screen is output from the PHONES output terminal
	Sub	When in the 2-screen or picture-in-picture mode, audio coming from the sub screen is output from the PHONES output terminal

- Select "Sub Volume" (↑/↓).
- Select the desired volume level (←/→).



- Press HOME MENU to exit the menu.

Note

- To adjust the volume for headphones after selecting "Sub", always use "Sub Volume" from the menu, whether the screen is in single, 2-screen or picture-in-picture mode. When the screen is in single mode with "Sub" selected, audio coming from the screen is output from the speakers even with headphones connected.

Power Control

Power Control provides convenient functions for power saving.

Energy Save

You may use one of the three Energy Save modes to save power consumption.

- Press HOME MENU.
- Select "Power Control" (↑/↓ then ENTER).
- Select "Energy Save" (↑/↓ then ENTER).
- Select "Mode1", "Mode2", or "Picture Off" (↑/↓ then ENTER).

Energy Save

Selections	Off	Provides normally bright pictures
	Mode1	Consumes less power than "Off" mode
	Mode2	Consumes less power than "Mode1"
	Picture Off	Deactivates the screen to save power. To restore the screen display, press any button other than + / - (Sound Effect) or . This setting is not memorized by the system.

- Press HOME MENU to exit the menu.

Note

- When you change the Energy Save mode, you may notice a change in the panel sound. This is normal.
- The Energy Save function can maintain efficiency of the screen for a long period of time. Setting the Energy Save function to "Mode1" is recommended in order to maintain efficiency of the screen for a long period of time.

No Signal off (AV source only)

The system will be automatically placed into the standby mode if no signal is received for 15 minutes.

- Press HOME MENU.
- Select "Power Control" (↑/↓ then ENTER).
- Select "No Signal off" (↑/↓ then ENTER).
- Select "Enable" (↑/↓ then ENTER).

No Signal off

Selections	Disable (default)	Does not place the system into the standby mode
	Enable	Places the system into the standby mode if no signal is received for 15 minutes

- Press HOME MENU to exit the menu.

Note

- Five minutes before the system is placed into the standby mode, a message appears every minute.
- The system may not be placed into the standby mode when noise signals are present at the plasma television after a TV programme finishes.

No Operation off (AV source only)

The system will be automatically placed into the standby mode when no operation is performed for three hours.

- Press HOME MENU.
- Select "Power Control" (↑/↓ then ENTER).
- Select "No Operation off" (↑/↓ then ENTER).
- Select "Enable" (↑/↓ then ENTER).

No Operation off

Selections	Disable (default)	Does not place the system into the standby mode
	Enable	Places the system into the standby mode if no operation is performed for three hours

- Press HOME MENU to exit the menu.

Note



- Five minutes before the system is placed into the standby mode, a message appears every minute.

Power Management (PC source only)

The system will be automatically placed into the standby mode when no signal is received from the PC.

- 1 Press **HOME MENU**.
- 2 Select **"Power Control"** (↑/↓ then **ENTER**).
- 3 Select **"Power Management"** (↑/↓ then **ENTER**).
- 4 Select **"Mode1"** or **"Mode2"** (↑/↓ then **ENTER**).

Power Management

Selections	Off (default)	No power management
Mode1		<ul style="list-style-type: none"> • Places the system into the standby mode when no signal is received from the personal computer for eight minutes. • Even when you start using the computer and a signal is received again, the system stays off. • The system is switched on again by pressing STANDBY/ON on the plasma television or  on the remote control unit.
Mode2		<ul style="list-style-type: none"> • Places the system into the standby mode when no signal is received from the personal computer for eight seconds. • When you start using the computer and a signal is input again, the system is switched on. • The system is switched on again by pressing STANDBY/ON on the plasma television or  on the remote control unit.

- 5 Press **HOME MENU** to exit the menu.



Note

- This function is not selectable when the PC is connected to the HDMI terminal.

Chapter 9

Enjoying DTV broadcasts

Watching DTV programmes

Digital TV (DTV) opens up a new world of free-to-air terrestrial programming. It provides more channels, clearer picture quality, and various types of useful information. You can enjoy high-quality digital programmes, simply by selecting the channel number from available digital stations on the menu.

 **Note**

- When executing Auto Installation (page 27), make sure to select "Digital" or "All" as the tuner type.
- While in the DTV mode, press  to display the Teletext screen.

Changing channels

- 1 Press TV/DTV to select the DTV mode.
- 2 Press ENTER to call up the Programme List screen.

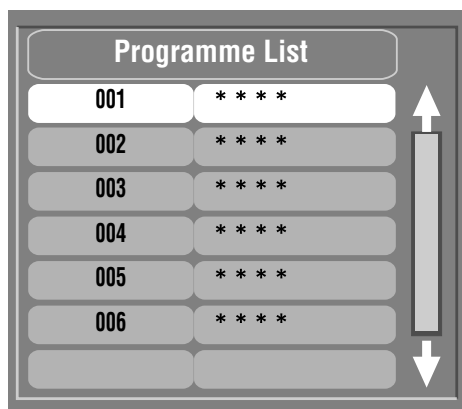

- 3 Select a channel (/ then ENTER).
 - You can also select channels by pressing buttons 0 to 9 or P+/P- on the remote control unit.

 **Note**

- While in DTV mode, press 001 to access channel 1 (one-digit channel) quickly. You can, however, select channel 1 by pressing only 01 or 1 but there is a slight delay after pressing the last digit. The same applies for two-digit channels.
- After entering a channel number, you may press CH ENTER to tune in the channel more quickly.
- If the channel is locked, you must enter the correct password each time (see page 49).
- While receiving DTV radio channels, the screen saver automatically starts.

Viewing a channel banner (i-PLATE)

A channel banner (i-PLATE) shows the following information: programme name, start/end time of the programme, current channel number, network name, audio channel (Mpeg or Dolby Digital), Teletext, current local time, and date and month. In addition, Parental Control information is also displayed.

- 1 Press TV/DTV to select the DTV mode.
- 2 Press .
 - A channel banner (i-PLATE) appears.
 - To quit banner display, press RETURN.

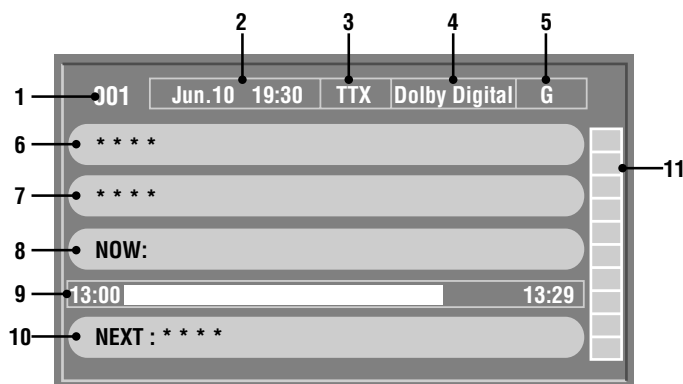

- 1 Channel Number
The broadcasting channel number currently received (in three digits from 1 to 999) is displayed. For example, "001" is displayed when channel 1 is received and "010" when channel 10 is received.
- 2 Date and Time
Month, date and time (24-hour indication) are displayed in that order.
- 3 Teletext Information
When Teletext information is available, "TTX" appears in this box.
- 4 Audio Channel
The audio channel information of the current programme is displayed. "Mpeg" is displayed when normal MPEG audio stream is received and "Dolby Digital" when Dolby Digital audio is received.
- 5 Parental Guide Information
The parental guide information of the current programme is displayed.
- 6 Network Information
The broadcast network name of the current programme is displayed.
- 7 Channel Number, Broadcaster Name
The channel number and TV station name of the current programme are displayed.
- 8 Present Programme Information
Information on the current programme is displayed.

- 9 Programme Status
A bar graph displays the elapsed time of the current programme.
- 10 Next Programme Information
Information on the next programme is displayed.
- 11 Signal Strength Level
Signal strength level of the current broadcast is displayed.
The stronger the signal, the higher the bar in the graph.

3 To view more detailed programme information, press **(i+)** again.

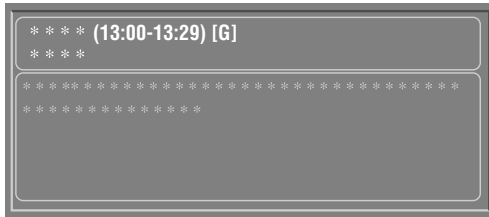

- To quit display of detailed information, press **RETURN**.
- If the banner contains further information, press **↑/↓** to view the subsequent information.

4 To view more detailed information of Next programme, press **(i+)** again.

- To quit display of detailed information, press **RETURN**.

5 Press **(i+)** again to exit a channel banner.

Note

- Some programmes may not include detailed programme information.
- Due to inaccurate information provided by the broadcasters, detailed information may not be displayed properly.

Viewing subtitles

When in the DTV mode, press **(S)** to turn subtitles on and off.



Customizing channel related settings

This section describes how to customize various channel related settings. These settings include favourite channel registration and Parental Lock setting.

Registering channels in the Favourite List

This function allows you to quickly tune in the desired channel by registering favourite channels and/or frequently viewed channels previously selected from the channel list in the Favourite List.

- 1 Press **HOME MENU**.
- 2 Select **"Setup" (↑/↓ then ENTER)**.
- 3 Select **"DTV Setup" (↑/↓ then ENTER)**.
- 4 Select **"Channel Setup" (↑/↓ then ENTER)**.
 - The password entry screen appears. Enter your four-digit password using buttons **0** to **9**.
- 5 Select **"Favourites" (↑/↓ then ENTER)**.



6 Select the desired channel(s) that you want to register in the Favourite List (**↑/↓ then ENTER**).

- Each time you press **ENTER**, a mark appears on the selected channel indicating that it has been registered in the Favourite List.
- To cancel a registration, press **ENTER** again on the registration mark. The mark disappears and the registration is canceled.

7 Press **HOME MENU** to exit the menu.

Note

- You can select "DTV Setup" only while viewing DTV channels.

Activating the Favourites function

After having registered your favourite channels, make sure to activate this function to select them. Use the following procedure.

- 1 Press **HOME MENU**.
- 2 Select **"Setup"** (↑/↓ then **ENTER**).
- 3 Select **"DTV Setup"** (↑/↓ then **ENTER**).
- 4 Select **"Channel Setup"** (↑/↓ then **ENTER**).
 - The password entry screen appears. Enter your four-digit password using buttons **0** to **9**.
- 5 Select **"Channel Change"** (↑/↓ then **ENTER**).
- 6 Select **"Favourites List"** (↑/↓).
- 7 Press **HOME MENU** to exit the menu.

Note

- With favourites channels registered, you can select them by pressing **P+/P-** on the remote control unit or **CHANNEL +/-** on the plasma television.
- To display all available DTV channels for reception, select "Programme List" in step 6 then press **P+/P-** on the remote control unit or **CHANNEL +/-** on the plasma television for channel selection.

Parental Control

With the Parental Control, adults can prevent children from watching inappropriate TV programmes. When an attempt is made to watch a blocked programme, the plasma television shows nothing but a message. Parental Control functions for digital TV channels.

- 1 Press **HOME MENU**.
- 2 Select **"Setup"** (↑/↓ then **ENTER**).
- 3 Select **"DTV Setup"** (↑/↓ then **ENTER**).
- 4 Select **"Channel Setup"** (↑/↓ then **ENTER**).
 - The password entry screen appears. Enter your four-digit password using buttons **0** to **9**.
- 5 Select **"Parental Control"** (↑/↓ then **ENTER**).

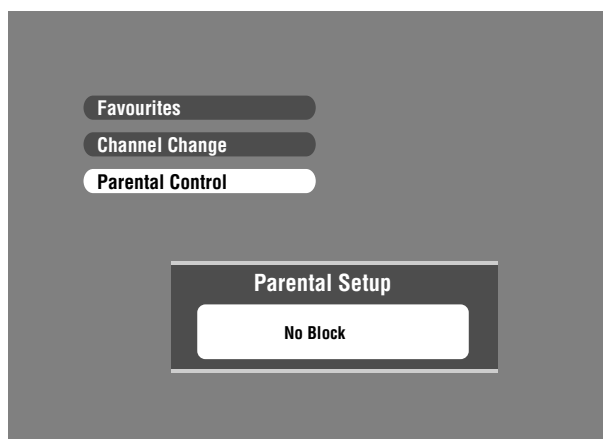

- 6 Select the desired rating and change the setting (←/→).
- 7 Press **HOME MENU** to exit the menu.

Parental Rating options

You can choose from the following options to block TV programmes:

No Block

- All programmes can be watched without any age limitation.

Block All

- All programmes are blocked.

General and above

- For general audiences. Not specifically designed for children but all ages are allowed.

Parental Guidance and above

- Some material may not be suitable for children. Parental guidance suggested.

Mature and above

- Mature audience 15+. Programmes are blocked for children under 15.

Mature Adult and above

- Specifically designed for adults. Some material may be inappropriate for children under 15.

Adult Violence and above

- Programmes are blocked for children under 15 as these programmes contain strong violent content.

Restricted and above

- Programmes contain inappropriate content for children under 18.

Note

- You can select "DTV Setup" only while viewing DTV channels.
- The Parental Control setup becomes effective when you first tune in a TV channel after entering the settings.
- When you select the Parental Rating option other than "No Block", the password entry screen appears depending on the programme received. Enter your four-digit password using buttons **0** to **9** (see page 49).
- When you select "No Block", Parental Control does not function in any way.

Reconfiguring the DTV channel settings

This section describes how to reconfigure the DTV channel settings after setting up DTV channels using Auto Installation (page 27). You can select "DTV Setup" only while viewing DTV channels.

Note

- You can select "DTV Setup" only while viewing DTV channels.

Quick Scan

If you live in one of the cities or regions listed in the “Quick Scan” menu, select your city or region and start scanning all available digital channel signals.

- 1 Press **HOME MENU**.
- 2 Select “Setup” (↑/↓ then **ENTER**).
- 3 Select “DTV Setup” (↑/↓ then **ENTER**).
- 4 Select “Installation” (↑/↓ then **ENTER**).
 - The password entry screen appears. Enter your four-digit password using buttons **0** to **9**.
- 5 Select “Quick Scan” (↑/↓ then **ENTER**).
 - Select your city or region from Adelaide, Brisbane, Melbourne, Perth, Sydney, Batchelor, Canberra, Darwin, Newcastle, Wollongong, Hobart or HobartNE.

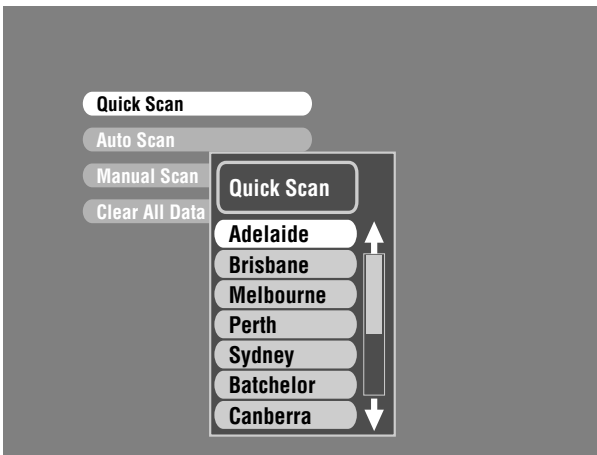

- 6 Select the city or region (↑/↓ then **ENTER**).
 - Channel search automatically starts. If any new channel is found, it is automatically registered on the plasma television.



- To quit a channel scan in progress, press **RETURN**. If you quit scanning halfway, all channels may not be registered properly. Make sure to repeat scanning again until it is completed.

Note

- You can select “DTV Setup” only while viewing DTV channels.
- If the city or region where you live in is not on the list, select “Auto Scan”.
- The channel frequencies in each city/region are preset in the tuner’s database. If the frequency is changed by the local TV station or a new channel commences broadcasting, you will have to find these channels using *Manual Scan* (see page 42) or *Auto Scan*.

Auto Scan

Auto Scan searches for digital programmes on receivable channels through the VHF and UHF bands without designating the city or region you live in.

- 1 Press **HOME MENU**.
- 2 Select “Setup” (↑/↓ then **ENTER**).
- 3 Select “DTV Setup” (↑/↓ then **ENTER**).
- 4 Select “Installation” (↑/↓ then **ENTER**).
 - The password entry screen appears. Enter your four-digit password using buttons **0** to **9**.
- 5 Select “Auto Scan” (↑/↓ then **ENTER**).
 - A confirmation screen appears.

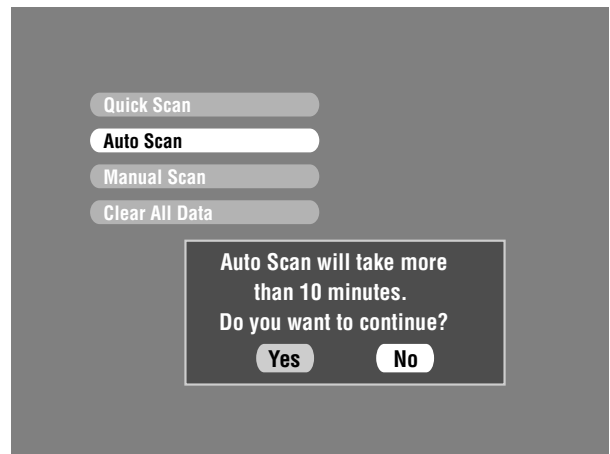

- 6 Select “Yes” to start “Auto Scan” (←/→ then **ENTER**).
 - The tuner starts scanning from channel 6 to channel 69. The percentage bar shows the progress.

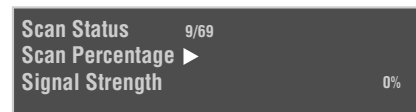

- If any new channel is found, it is automatically registered on the plasma television.

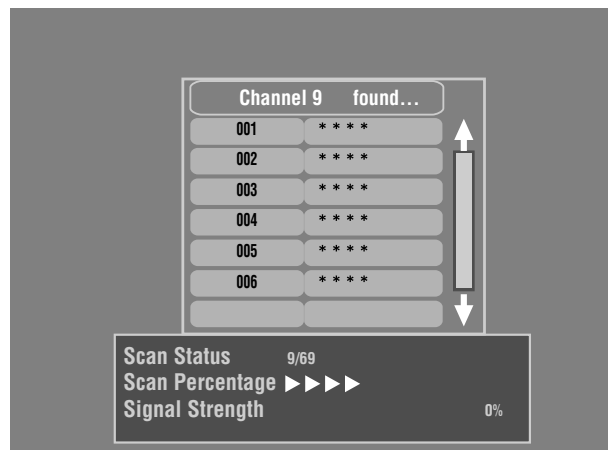

- To quit a channel scan in progress, press **RETURN**. If you quit scanning halfway, all channels may not be registered properly. Make sure to repeat scanning again until it is completed.

Note

- You can select "DTV Setup" only while viewing DTV channels.
- Once the digital TV signal is scanned, the channel number and programme name will be shown on the Programme List above the percentage bar.

Manual Scan

This function is used to add channels to the preset channel list when a new channel is added to the city or region you live in. Manual Scan searches for the channel based on the frequency and bandwidth you request.

- Press **HOME MENU**.
- Select **"Setup"** (**↑/↓** then **ENTER**).
- Select **"DTV Setup"** (**↑/↓** then **ENTER**).
- Select **"Installation"** (**↑/↓** then **ENTER**).
 - The password entry screen appears. Enter your four-digit password using buttons **0** to **9**.
- Select **"Manual Scan"** (**↑/↓** then **ENTER**).
 - A scanning data entry screen appears.

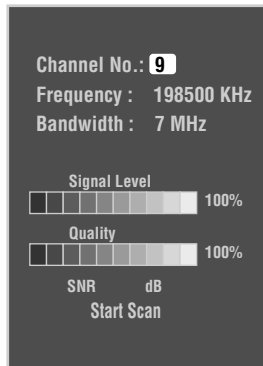

- Select **"Channel No."** (**↑/↓**).
- Select the **RF Channel No. you want to scan** (**←/→**).
 - If you enter the correct RF Channel No., the correct frequency displays. If the correct frequency is not displayed, check the RF Channel No. you have entered.

8 After entering the correct RF Channel No., select **"Start Scan"** (**↑/↓** then **ENTER**).

- Scanning starts for the designated RF channel.

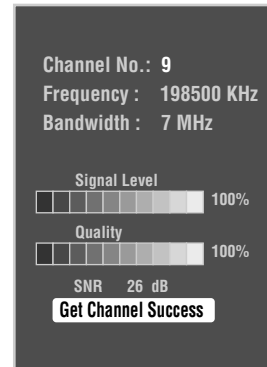

- When scanning is completed, the image on the scanned channel is displayed.
- If scanning fails and no screen appears, you can try to scan the signal again, or refer to the Signal Level and Quality indicators to align the antenna to improve your signal reception.
- To quit a channel scan in progress, press **RETURN**.

Note

- You can select "DTV Setup" only while viewing DTV channels.

Clear All Data

This function resets all DTV-related settings and preset channels to factory default.

- Press **HOME MENU**.
- Select **"Setup"** (**↑/↓** then **ENTER**).
- Select **"DTV Setup"** (**↑/↓** then **ENTER**).
- Select **"Installation"** (**↑/↓** then **ENTER**).
 - The password entry screen appears. Enter your four-digit password using buttons **0** to **9**.
- Select **"Clear All Data"** (**↑/↓** then **ENTER**).
 - A confirmation screen appears.
 - Selecting "Yes" moves to the next screen while selecting "No" cancels "Clear All Data" option.

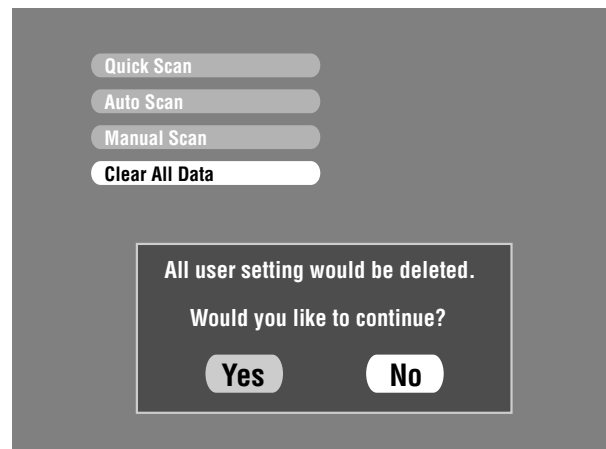

- 6 Select "Yes" and start initializing all the DTV settings (←/→ then ENTER).
 - Once the initialization starts, you cannot stop it halfway.
 - To perform the initialization properly, do not turn the power off while the initialization is in progress.

Note

- You can select "DTV Setup" only while viewing DTV channels.
- Do not choose this option unless you understand the functioning of the tuner. No viewing channels will remain afterwards. Setup procedures and scanning will have to be performed again after taking this step.

Time Zone Setup

Use this function to display the correct time when the banner (i-PLATE) appears on the screen. Designate the correct city or region you live in, otherwise incorrect time displays.

- 1 Press HOME MENU.
- 2 Select "Setup" (↑/↓ then ENTER).
- 3 Select "DTV Setup" (↑/↓ then ENTER).
- 4 Select "Setup" (↑/↓ then ENTER).
- 5 Select "Time Zone" (↑/↓ then ENTER).



- 6 Select the region you live in from the list below (←/→).
 - NSW/ACT (New South Wales/Australian Capital Territory)
 - VIC (Victoria)
 - QLD (Queensland)
 - SA (South Australia)
 - WA (Western Australia)
 - TAS (Tasmania)
 - NT (Northern Territory)
- 7 Press HOME MENU to exit the menu.

Note

- You can select "DTV Setup" only while viewing DTV channels.

Selecting a digital audio format

Use the following procedure to switch between the PCM and Dolby Digital audio format.

- 1 Press HOME MENU.
- 2 Select "Setup" (↑/↓ then ENTER).
- 3 Select "DTV Setup" (↑/↓ then ENTER).
- 4 Select "Setup" (↑/↓ then ENTER).
- 5 Select "Audio Setup" (↑/↓ then ENTER).
- 6 Select "Digital Audio" (↑/↓ then ENTER).

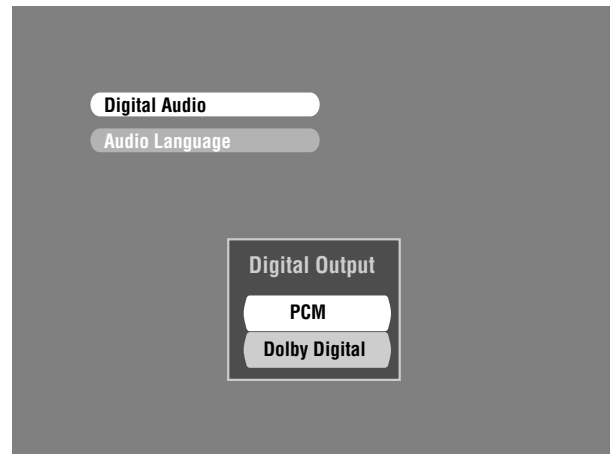

- 7 Select "PCM" or "Dolby Digital" (↑/↓).
- 8 Press HOME MENU to exit the menu.

Note

- You can select "DTV Setup" only while viewing DTV channels.
- Even if "Dolby Digital" is selected, the sound is output in the PCM format when no Dolby Digital encoded audio signals are contained in the current programme.

Selecting an audio language

Use the following procedure to switch the audio language for the programme being watched.

- 1 Press HOME MENU.
- 2 Select "Setup" (↑/↓ then ENTER).
- 3 Select "DTV Setup" (↑/↓ then ENTER).
- 4 Select "Setup" (↑/↓ then ENTER).
- 5 Select "Audio Setup" (↑/↓ then ENTER).
- 6 Select "Audio Language" (↑/↓ then ENTER).

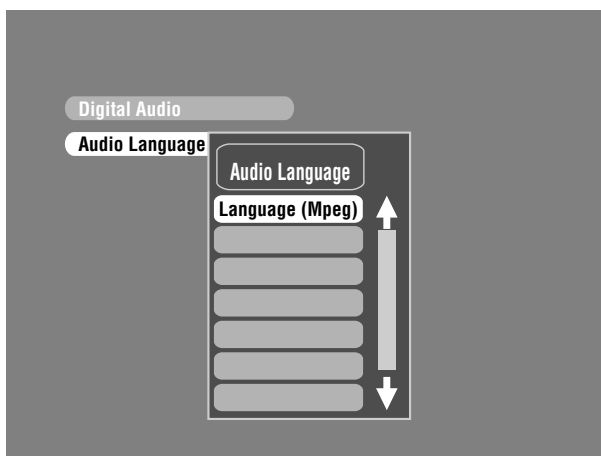

- 7 Select the desired audio language (↑/↓ then ENTER).
 - You may not be able to select from two or more languages depending on the current programme.
- 8 Press HOME MENU to exit the menu.

Note

- You can select "DTV Setup" only while viewing DTV channels.
- The audio language you select will only work when the broadcasting signal carries that language sound track.
- While viewing DTV channels, you can change the audio language by pressing I-II

Displaying technical information

Use this function to check the hardware/software version number.

- 1 Press HOME MENU.
- 2 Select "Setup" (↑/↓ then ENTER).
- 3 Select "DTV Setup" (↑/↓ then ENTER).
- 4 Select "Setup" (↑/↓ then ENTER).
- 5 Select "Software" (↑/↓ then ENTER).
- 6 Select "Current Version" and press ENTER.

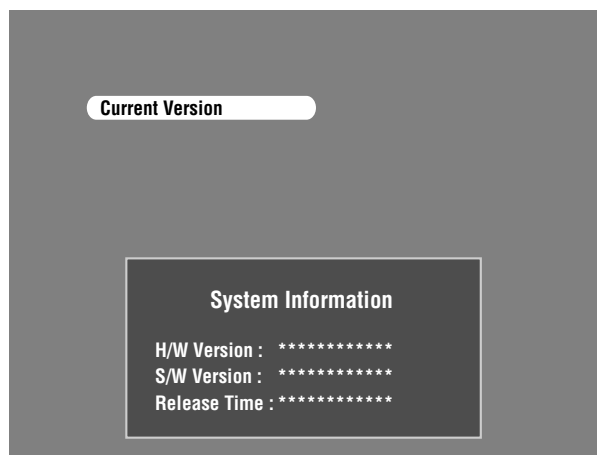

- 7 Press HOME MENU to exit the menu.

Note

- You can select "DTV Setup" only while viewing DTV channels.

Screen Saver

The screen saver automatically starts when DTV radio channels are received.

Note

- Even when the screen saver is active, you can perform any operation.

Chapter 10

Useful adjustment settings

About "Option" menus

The "Option" menu consists of two screens. To select the desired menu, press repeatedly **↑/↓** to switch between Screen 1 and Screen 2. The current screen number appears at the top right corner on the screen.

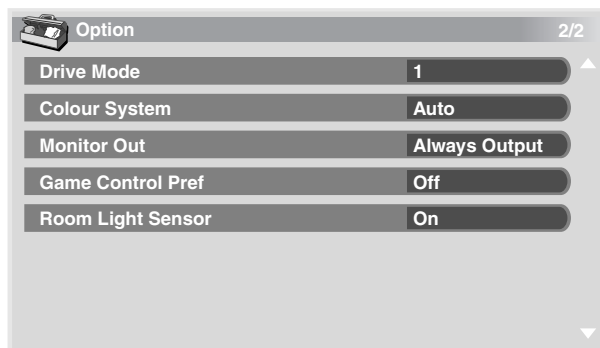
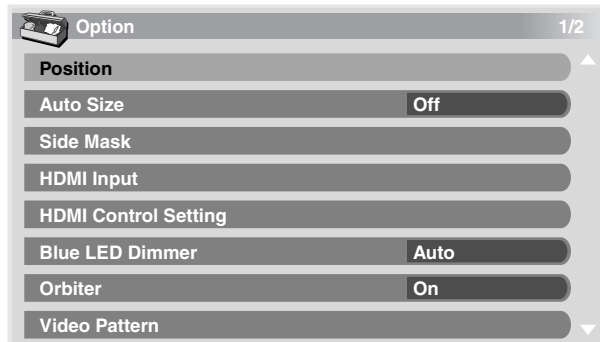

(For AV source)

Switching the vertical drive mode (AV source only)

You can select the desired drive mode according to the programme you watch.

- 1 Press HOME MENU.
- 2 Select "Option" (**↑/↓** then ENTER).
- 3 Select "Drive Mode" (**↑/↓** then ENTER).
- 4 Select "1", "2" or "3" (**↑/↓** then ENTER).
- 5 Press HOME MENU to exit the menu.

Note

- This setting can be made for each input source separately.
- Selections are effective only for the following input signals: PAL/SECAM, 576i, 576p, 1080i@50 Hz, 720p@50 Hz.
- This setting cannot be made when 480i, 480p, 1080i@60 Hz, 720p@60 Hz, 1080p@24 Hz, or 1080p@60 Hz signals are input.
- The Drive Mode does not operate when "On" is selected in "Game Control Pref".

Adjusting image positions (AV source only)

Adjust the horizontal and vertical positions of images on the plasma television.

- 1 Press HOME MENU.
- 2 Select "Option" (**↑/↓** then ENTER).
- 3 Select "Position" (**↑/↓** then ENTER).
- 4 Select "H/V Position Adjust" (**↑/↓** then ENTER).
- 5 Adjust the vertical position (**↑/↓**) or the horizontal position (**←/→**).
- 6 Press HOME MENU to exit the menu.

**Note**

- To restore the factory defaults for all items, press **↑/↓** to select "Reset" in step 4, and then press ENTER. A confirmation screen appears. Press **←/→** to select "Yes", and then press ENTER.
- Adjustments are stored separately according to input source.
- Depending on the displayed video, the image position may not change even after adjustment.

Adjusting image positions and clock automatically (PC source only)

Use Auto Setup to automatically adjust the positions and clock of images coming from a personal computer.

- 1 Press HOME MENU.
- 2 Select "Option" (**↑/↓** then ENTER).
- 3 Select "Auto Setup" (**↑/↓** then ENTER).
 - A message screen appears and Auto Setup starts.
- 4 Press HOME MENU to exit the menu.

**Note**

- When Auto Setup is finished, "Auto Setup completed." appears.
- Even when "Auto Setup completed." appears, Auto Setup may have failed, depending on conditions.
- Auto Setup may fail with a PC image composed of similar patterns or monochrome. If not successful, change the PC image and try again.
- Be sure to connect the computer to the plasma television and switch it on before starting Auto Setup.
- This function is not selectable when the PC is connected to the HDMI terminal.
- Depending on the displayed video, the image position may not change even after adjustment.

Adjusting image positions and clock manually (PC source only)

Usually you can easily adjust the positions and clock of images using Auto Setup. Use Manual Setup to optimize the positions and clock of images when necessary.

- 1 Press **HOME MENU**.
- 2 Select **"Option"** (↑/↓ then **ENTER**).
- 3 Select **"Manual Setup"** (↑/↓ then **ENTER**).
- 4 Select the item to be adjusted (↑/↓ then **ENTER**).
- 5 Perform adjustment (↑/↓/←/→).
 - With "Clock" or "Phase" selected, you can change the parameter using ←/→.
- 6 Press **HOME MENU** to exit the menu.

Note

- To restore the factory defaults for all items, press ↑/↓ to select "Reset" in step 4, and then press **ENTER**. A confirmation screen appears. Press ←/→ to select "Yes", and then press **ENTER**.
- This function is not selectable when the PC is connected to the HDMI terminal.
- Depending on the displayed video, the image position may not change even after adjustment.

Colour system setting

If an image does not appear clearly, select another colour system (e.g., PAL, NTSC).

- 1 Press **HOME MENU**.
- 2 Select **"Option"** (↑/↓ then **ENTER**).
- 3 Select **"Colour System"** (↑/↓ then **ENTER**).
- 4 Select a video signal system (↑/↓ then **ENTER**).
 - You can select "Auto", "PAL", "SECAM", "NTSC", "4.43NTSC", "PAL-M" or "PAL-N".
 - With "Auto" selected, input signals are automatically identified.
- 5 Press **HOME MENU** to exit the menu.

Note

- The factory default is "Auto".
- You do not need to enter any setting if "HDMI Input" has been selected.
- You need to perform colour system setting for each of "INPUT 1", "INPUT 2", "INPUT 3" and "INPUT 6".
- For the colour system setting, see steps 11 and 12 under *Setting up analogue TV channels manually* (page 27).

Selecting a game mode

When playing a game, you can use this function to establish a preference for image quality or operability.

- 1 Press **HOME MENU**.
- 2 Select **"Option"** (↑/↓ then **ENTER**).
- 3 Select **"Game Control Pref"** (↑/↓ then **ENTER**).
- 4 Select **"On"** or **"Off"** (↑/↓ then **ENTER**).

Item	Description
On	Establishes a preference for operability
Off	Establishes a preference for image quality

- 5 Press **HOME MENU** to exit the menu.

Note

- The "Game Control Pref" is only available when using an external input (except a PC source) and "GAME" is selected in "AV Selection".
- The "Game Control Pref" options are not effective when PC signals are received (when a PC source menu is displayed on the screen).
- The "On" setting is not effective when freezing images or in the multiscreen mode.

Selecting a screen size manually

Press **AS** to switch among the screen size options selectable for the type of video signals currently received.

Each time you press **AS**, the selection is switched.

The selectable screen sizes differ depending on the types of input signals.

Important

- If images with black bands on both sides or top and bottom of the screen - when using the "4:3", "FULL 14:9" or "CINEMA 14:9" modes, for example - are displayed continuously for long periods or for shorter periods of time over several days, image retention may result. It is recommended that you enjoy watching images displayed in full screen, except when doing so may result in copyright infringement.

AV source

Item	Description
4:3	For 4:3 "standard" pictures. A side mask appears on each side.
FULL 14:9	For 14:9 squeezed pictures. A thin side mask appears on each side.
CINEMA 14:9	For 14:9 letterbox pictures. A thin side mask appears on each side, and you may also see bars on the top and bottom on some programmes.
WIDE	In this mode the picture is progressively stretched toward each side of the screen
FULL	For 16:9 squeezed pictures
ZOOM	For 16:9 letterbox pictures. Bars may appear on the top and bottom on some programmes.
CINEMA	For 14:9 letterbox pictures. Bars may appear on the top and bottom on some programmes.

PC source

Item	Description
4:3	Fills the screen without altering the input signal aspect ratio
FULL	Full 16:9 screen display

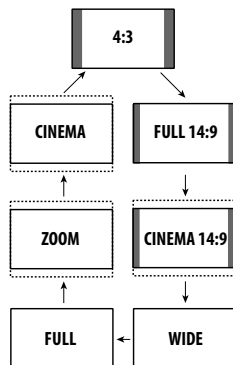
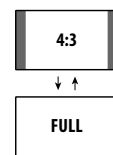
AV source**PC source****Note**

- The specifications given for the PC source are for the PDP-508XDA. For the PDP-428XDA, the number of panel pixels is different, and thus signal processing and actual viewing conditions will vary slightly.
- While receiving High Definition video signals, pressing  switches among FULL, WIDE, 4:3, and ZOOM.
- Some HD broadcasts may display 4:3 content with side masks, which may cause uneven wear. After viewing it is recommended to view full-screen motion video (see *Detecting side masks*).

Selecting a screen size automatically

The plasma television automatically selects an appropriate screen size when the received video signals contain WSS (wide screen signaling) information, when the broadcasting signals (DTV only) contain information other than WSS, or when video signals are received from connected HDMI equipment (see page 55). To activate this function, use the following procedure.

- 1 Press **HOME MENU**.
- 2 Select **"Option"** (↑/↓ then **ENTER**).
- 3 Select **"Auto Size"** (↑/↓ then **ENTER**).
- 4 Select **"Natural"** or **"Wide-Zoom"** (↑/↓ then **ENTER**).

Item	Description
Off	Deactivates the Auto Size function
Natural	Naturally adjusts the image to the screen
Wide-Zoom	Enlarges and displays only the 4:3 aspect ratio portion in full and wide screen

- 5 Press **HOME MENU** to exit the menu.

**Note**

- Manually select an appropriate screen size if an image does not automatically switch to a correct screen format.
- When the video signal contains no aspect ratio information, the function will not work even with "Natural" or "Wide-Zoom" selected.

Detecting side masks

Some HD broadcasts may display 4:3 content with side masks. The plasma television automatically detects these side masks to provide grey side masks when "Natural" has been selected for "Auto Size", or display the image full screen with the side masks removed when "Wide-Zoom" has been selected. This function does not operate when "Off" is selected for "Auto Size".

- 1 Press **HOME MENU**.
- 2 Select **"Option"** (↑/↓ then **ENTER**).
- 3 Select **"Side Mask"** (↑/↓ then **ENTER**).
- 4 Select **"Detection"** (↑/↓).
- 5 Select **"On"** (←/→).

Item	Description
Off	Deactivates the Side Mask detection
On	Activates the Side Mask detection

- 6 Press **HOME MENU** to exit the menu.

**Important**

- The "On" setting prevents uneven wear on 4:3 content and side masks and can reduce the possibility of image retention.

 **Note**

- You cannot set the Side Mask detection to "On" or "Off" when "Off" is selected in "Auto Size".
- The Side Mask detection does not operate on 4:3 content displayed in SD signals.
- The Side Mask detection is canceled when you switch the screen size. To restore the Side Mask detection, select another input source or place the plasma television into standby, then turn the power on again.
- "Auto" will appear on the channel display when this function is on.
- Set the Side Mask detection function to "On", the High Definition 16:9 aspect ratio images containing side masks will be detected and the side masks will be added automatically or the image displayed in full screen, leading to more effective countermeasures taken for the screen burning.
- Detection errors may occur depending on the HD contents. In case a detection error occurs, manually change the screen size to the desired size.

Changing the brightness at both sides of the screen (Side Mask)

With the 4:3, FULL 14:9, or CINEMA 14:9 screen size selected, you can change the brightness of the grey side masks that appear at both sides of the screen.

- 1 Press HOME MENU.
- 2 Select "Option" (↑/↓ then ENTER).
- 3 Select "Side Mask" (↑/↓ then ENTER).
- 4 Select "Brightness Sync." (↑/↓).
- 5 Select the desired parameter (←/→ then ENTER).

Item	Description
Fixed (default)	Always sets the same brightness for the grey side masks
Auto	Adjusts the brightness of the grey side masks according to the brightness of images

 **Important**

The "Auto" setting adjusts the brightness of the side masks according to the brightness of the screen and can reduce the possibility of image retention.

- 6 Press HOME MENU to exit the menu.

Room Light Sensor

This function automatically adjusts the brightness of the display panel in accordance with the brightness level of the viewing area. For details, use the following procedure.

- 1 Press HOME MENU.
- 2 Select "Option" (↑/↓ then ENTER).
- 3 Select "Room Light Sensor" (↑/↓ then ENTER).
- 4 Select "On" or "Off" (↑/↓ then ENTER).

Item	Description
On	Activates the Room Light Sensor function
Off	Deactivates the Room Light Sensor function

- 5 Press HOME MENU to exit the menu.

 **Note**

- When you have selected "OPTIMUM" on the "AV Selection" menu, the Room Light Sensor function will stay "On" even if you select "Off" in step 4.
- This function is not available when PC signals are received.
- As this function automatically optimizes image quality, the process in which image settings such as brightness and tint gradually change may be seen on the screen. This is not a malfunction.

Blue LED Dimmer

You can adjust the brightness of the POWER ON indicator depending on the brightness level of the viewing area. When "Auto" is selected, the brightness of the indicator changes to "High", "Mid" or "Low" to match the brightness level of the viewing area.

- 1 Press HOME MENU.
- 2 Select "Option" (↑/↓ then ENTER).
- 3 Select "Blue LED Dimmer" (↑/↓ then ENTER).
- 4 Select "Auto", "High", "Mid" or "Low" (↑/↓ then ENTER).
- 5 Press HOME MENU to exit the menu.

Orbiter

This function automatically shifts the image little by little to reduce the occurrence of the burning.

- 1 Press **HOME MENU**.
 - 2 Select **"Option"** (↑/↓ then **ENTER**).
 - 3 Select **"Orbiter"** (↑/↓ then **ENTER**).
 - 4 Select **"On"** (↑/↓ then **ENTER**).
 - 5 Press **HOME MENU** to exit the menu.
- To cancel this function, select "Off" in step 4.

Note





- When the Orbiter function is set to "On", the image may appear to drop slightly on the screen.
- This function does not operate when PC signals are received.

Video Pattern

You can display the Video Pattern screen that also helps eliminate after-image when it occurs.

- 1 Press **HOME MENU**.
 - 2 Select **"Option"** (↑/↓ then **ENTER**).
 - 3 Select **"Video Pattern"** (↑/↓ then **ENTER**).
- A confirmation screen appears.
- 4 Select **"Start"** (**ENTER**).
- The Video Pattern screen displays.

Note

- The system is automatically placed into standby one hour after the Video Pattern screen has started.
- While the Video Pattern screen is on, no buttons operate except  on the remote control unit, **STANDBY/ON** and  on the plasma television.
- To cancel the Video Pattern screen, press  on the remote control unit, **STANDBY/ON** or  on the plasma television.
- The Video Pattern timer has priority over the sleep timer. When the Video Pattern timer is on, the sleep timer becomes ineffective.

Sleep Timer

When the selected time elapses, the Sleep Timer automatically places the system into the standby mode.

- 1 Press **HOME MENU**.
- 2 Select **"Sleep Timer"** (↑/↓ then **ENTER**).
- 3 Select the desired time (↑/↓ then **ENTER**).
Select "Off" (cancel), "30 min.", "60 min.", "90 min." or "120 min."
- 4 Press **HOME MENU** to exit the menu.

Note

- Five minutes before the selected time elapses, the remaining time appears every minute.
- To check the remaining time, perform steps 1 and 2. After checking the time, press **HOME MENU** to restore the previous display.
- The SLEEP indicator on the front of the plasma television lights up in orange when the Sleep Timer is set.

Using a password

The plasma television provides the Child lock and Parental lock functions for preventing children from watching inappropriate programmes. You need to enter a password when watching programmes with "Block" specified. Before the system is shipped, "1234" is preset as the factory-default password. You can however, change the password as you want.

You will need to enter the password before using the "Auto Installation", "Analogue TV Setup", or "Password" functions from the HOME MENU to prevent unauthorized changes to the settings.

Entering a password

In a case where you select a channel blocked with Child lock or Parental lock function or if password entry is requested when attempting to open the menu, enter a password correctly.

- Enter a correct four-digit password using buttons 0 to 9.

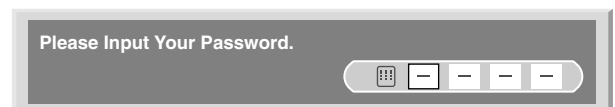

- While using a Parental Lock menu in DTV mode or in DTV Setup, the following password entry screen appears.



Note

- If you fail password entry three times, "Invalid password." appears, and the menu is closed. In order to display the password entry screen again to unlock the password, select the blocked channel or open the menu again.
- If the password entry screen disappears before entry, you may recall it by pressing **ENTER**.

Changing the password

Use the following procedure to change the password.

- 1 Press HOME MENU.
- 2 Select "Setup" (↑/↓ then ENTER).
- 3 Select "Password" (↑/↓ then ENTER).
The password entry screen appears. Enter the current four-digit password using buttons 0 to 9.
- 4 Select "Change Password" (↑/↓ then ENTER).
- 5 Enter a four-digit password to be newly set, using buttons 0 to 9.

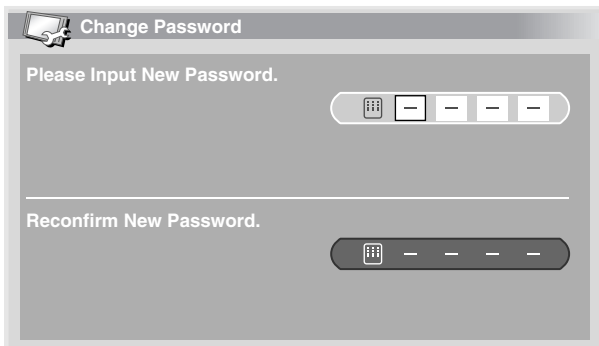

- 6 Enter the same password that you have entered in step 5.
 - If a different password is entered, the operation goes back to step 5 for reentry from the beginning.
 - You can try up to three times to reconfirm the new password before the Change Password screen is automatically exited.
- 7 Press HOME MENU to exit the menu.

Note

- Take a note of the newly set password and keep it handy.

Resetting the password function

- 1 Press HOME MENU.
- 2 Select "Setup" (↑/↓ then ENTER).
- 3 Select "Password" (↑/↓ then ENTER).
The password entry screen appears. Enter your four-digit password using buttons 0 to 9.
- 4 Select "Reset" (↑/↓ then ENTER).
- 5 Select "Yes" (←/→ then ENTER).
- 6 Press HOME MENU to exit the menu.

Note

- The above procedure will reset the password to the factory default (1 2 3 4).

We suggest you write down your password so you don't forget it.

PDP-508XDA / PDP-428XDA
Your password No.:

If you forget the password

When the message "Please Input Your Password" is displayed, press the **ENTER** button on the remote control unit and hold it down for three seconds or longer. The password reverts to "1234".

Note that it is not possible to reset the password from the DTV Setup screen.

Chapter 11

Using with other equipment

You can connect many types of external equipment to your plasma television, like a set top box, VCR, DVD player, personal computer, game console, and camcorder.

To view images coming from external equipment, select the input source using **INPUT 1** to **INPUT 6** or **PC** on the remote control unit (page 14) or **INPUT** on the plasma television.

⚠ Caution

- To protect all equipment, always unplug the plasma television from the power outlet before connecting to a set top box, VCR, DVD player, personal computer, game console, camcorder, or other external equipment.

✍ Note

- Unless stated otherwise, the connecting cables shown in the illustrations are readily available commercially, but are not supplied with this product.
- Refer to the relevant operation manual (DVD player, personal computer, etc.) carefully before making connections.

Connecting a set top box

You can use the INPUT 1 terminal when connecting a set top box and other audiovisual equipment.

Use either a component, S-Video or standard video cable for the video signal. Use a stereo audio cable for the audio. (If you're using the standard video input, you can use a red/white/yellow audio/video cable.)

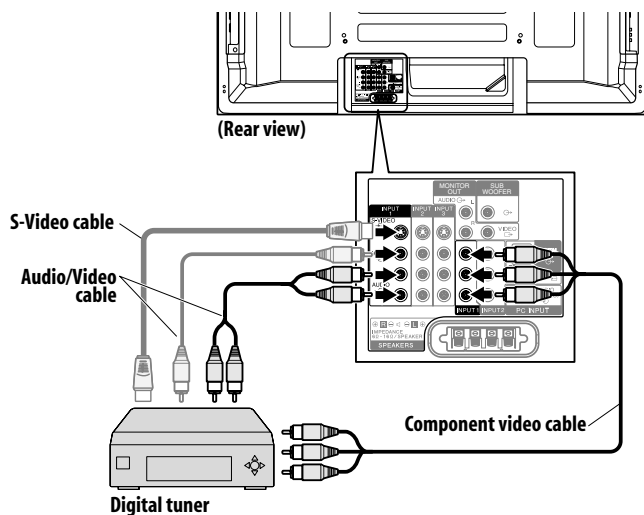

Displaying broadcasts via a set top box

To watch a set top box image, press **INPUT 1** on the remote control unit or **INPUT** on the plasma television to select "INPUT 1".

✍ Note

- Signal priority for the INPUT 1 terminals is (1) Component video, (2) S-Video, (3) Video.
- Connect only the type of video cable that will actually be used.
- Refer to your set top box operation manual for the signal types available.

Connecting a DVD player

Use the INPUT 2 terminal when connecting to a DVD player and other audiovisual equipment.

Use either a component, S-Video or standard video cable for the video signal. Use a stereo audio cable for the audio. (If you're using the standard video input, you can use a red/white/yellow audio/video cable.)

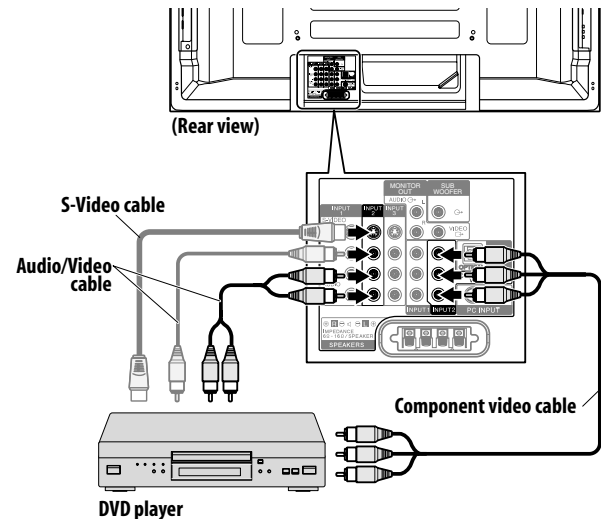

DVD playback

To watch a DVD, press **INPUT 2** on the remote control unit or press **INPUT** on the plasma television to select "INPUT 2".

✍ Note

- Signal priority for the INPUT 2 terminals is (1) Component video, (2) S-Video, (3) Video.
- Connect only the type of video cable that will actually be used.
- Refer to your DVD player operation manual for the signal types available.

Connecting a VCR

Use the INPUT 3 terminals when connecting a VCR and other audiovisual equipment.

Use either an S-Video or standard video cable for the video signal. Use a stereo audio cable for the audio. (If you're using the standard video input, you can use a red/white/yellow audio/video cable.)

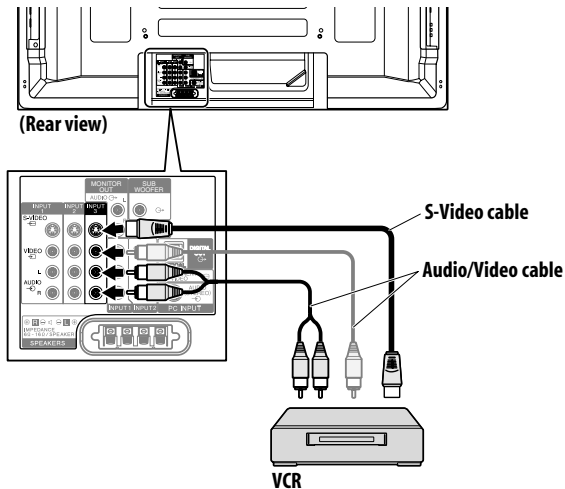

VCR playback

To watch a VCR image, press **INPUT 3** on the remote control unit or press **INPUT** on the plasma television to select "INPUT 3".

Note

- Signal priority for the INPUT 3 terminals is (1) S-Video, (2) Video.
- Connect only the type of video cable that will actually be used.
- Refer to your VCR operation manual for the signal types available.

Connecting a game console or camcorder

Use the INPUT 6 terminals to connect a game console, camcorder and other audiovisual equipment.

Use either an S-Video or standard video cable for the video signal. Use a stereo audio cable for the audio. (If you're using the standard video input, you can use a red/white/yellow audio/video cable.)

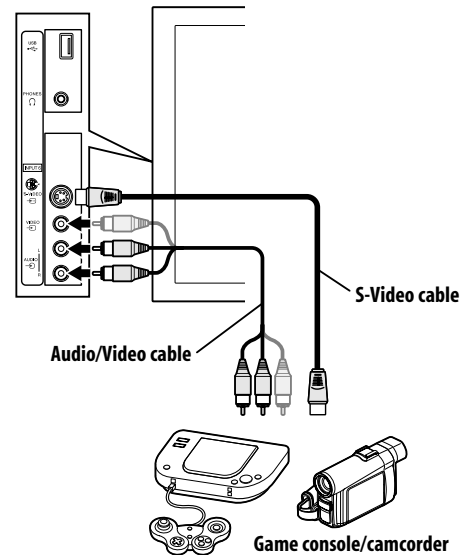

Displaying an image from the game console or camcorder

To watch an image coming from the game console or camcorder, press **INPUT 6** on the remote control unit or press **INPUT** on the plasma television to select "INPUT 6".

Note

- Signal priority for the INPUT 6 terminals is (1) S-Video, (2) Video.
- Connect only the type of video cable that will actually be used.

Connecting a personal computer

Use the PC terminals to connect a personal computer.

- The PC input terminal is DDC1/2B-compatible.

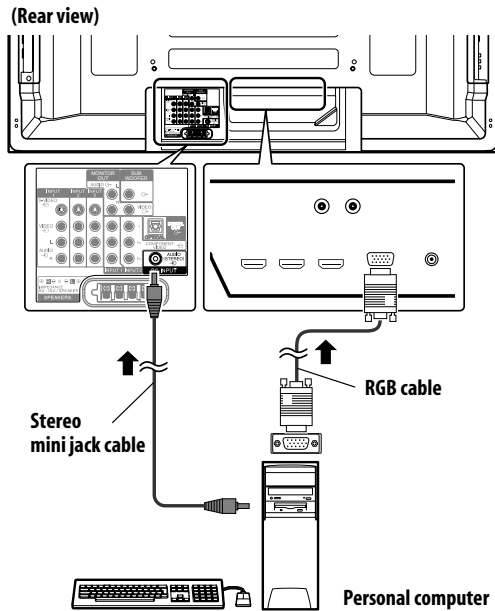

Displaying an image from a personal computer

To watch an image coming from the personal computer, press **PC** on the remote control unit or press **INPUT** on the plasma television to select "PC".

When connecting to a personal computer, the correct input signal type is automatically detected. If the personal computer image does not come in clearly, you may need to use Auto Setup menu. See page 45.

Note

- The PC terminals cannot be used for audiovisual equipment.

Computer compatibility chart

Resolution	Frequency
720 x 400	70 Hz
640 x 480 (VGA)	60 Hz
800 x 600 (SVGA)	60 Hz
1280 x 720	60 Hz
1024 x 768 (XGA)	60 Hz
1360 x 768 (Wide-XGA)	60 Hz
1280 x 1024 (SXGA)	60 Hz

Connecting an amplifier/AV receiver

You can enjoy more powerful sound by connecting an amplifier/AV receiver and subwoofer to the plasma television.

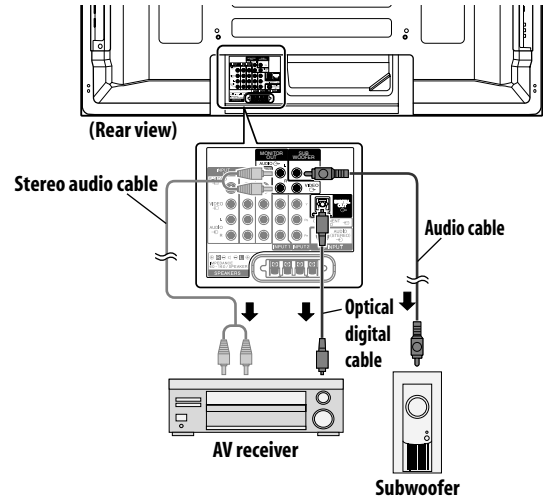

Note

- For details, refer to the operation manual for the audio equipment to be connected.
- If your amplifier/AV receiver has subwoofer output, it is not necessary to connect the subwoofer output on the plasma television.
- Audio signals corresponding to the currently displayed images are always output to the MONITOR OUT and SUBWOOFER terminals.
- When signals are input from the HDMI terminals, no signals are output from the DIGITAL OUT terminal.

Avoiding unwanted feedback

You can prevent unwanted feedback from adversely affecting the quality of images. Specify the output terminal whose output is to be inhibited.

- 1 Press **HOME MENU**.
- 2 Select **"Option"** (↑/↓ then **ENTER**).
- 3 Select **"Monitor Out"** (↑/↓ then **ENTER**).
- 4 Select the desired parameter (↑/↓ then **ENTER**).

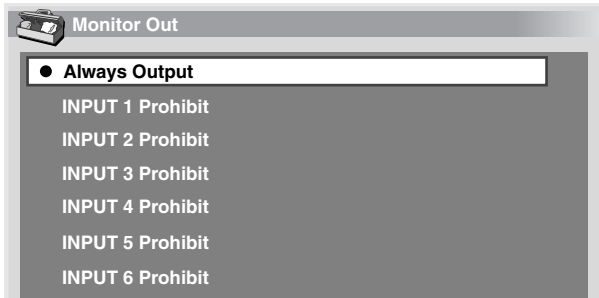

Item	Description
Always Output	Outputs composite video and audio signals no matter which input source is selected
INPUT 1 Prohibit	Does not output composite video and audio signals when "INPUT 1" is selected
INPUT 2 Prohibit	Does not output composite video and audio signals when "INPUT 2" is selected
INPUT 3 Prohibit	Does not output composite video and audio signals when "INPUT 3" is selected
INPUT 4 Prohibit	Does not output composite video and audio signals when "INPUT 4" is selected
INPUT 5 Prohibit	Does not output composite video and audio signals when "INPUT 5" is selected
INPUT 6 Prohibit	Does not output composite video and audio signals when "INPUT 6" is selected

- 5 Press **HOME MENU** to exit the menu.

Note

- If you operate the DTV setup menu or display a Teletext screen while watching DTV broadcasting, the corresponding GUI is also output from MONITOR OUT. Be careful when recording a DTV broadcasting programme.
- The INPUT 4 and INPUT 5 video signal is not output from the MONITOR OUT jack regardless of this setting.

Using the HDMI Inputs

The INPUT 3, INPUT 4 and INPUT 5 terminals are HDMI terminals to which digital video and audio signals can be input. To use the HDMI terminals, activate the terminal and specify the types of video and audio signals to be received from the connected equipment. For the types of these signals, see the operation manual that came with the connected equipment.

Before starting the menu, press **INPUT 3**, **INPUT 4** or **INPUT 5** on the remote control unit or press **INPUT** on the plasma television to select "INPUT 3", "INPUT 4" or "INPUT 5".

Video signals supported

720 (1440) x 576i@50 Hz
720 x 576p@50 Hz
1280 x 720p@50 Hz
1920 x 1080i@50 Hz
720 (1440) x 480i@59.94 Hz/60 Hz
720 x 480p@59.94 Hz/60 Hz
1280 x 720p@59.94 Hz/60 Hz
1920 x 1080i@59.94 Hz/60 Hz
1920 x 1080p@24 Hz
1920 x 1080p@50 Hz
1920 x 1080p@60 Hz

PC signals supported

640 x 480 (VGA) 60 Hz
800 x 600 (SVGA) 60 Hz
1024 x 768 (XGA) 60 Hz
1360 x 768 (Wide - XGA) 60 Hz
1280 x 1024 (SXGA) 60 Hz

For audio, the system supports the following:

- Linear PCM (STEREO 2 ch)
- Sampling frequency: 32 kHz, 44.1 kHz, 48 kHz

HDMI Control supported

The plasma television supports the HDMI Control functions. By connecting devices that support the HDMI Control functions to the plasma television, you can control the connected device(s) from the plasma television or remote control unit of the plasma television. See *Using the HDMI Control* on Chapter 12.

Deep Colour supported

Deep Colour means the colour depth that describes the number of bits used to represent the colour of a single pixel in a bitmapped image. Besides the conventional RGB/YCbCr16 bit/20 bit/24 bit signals, the plasma television also supports RGB/YCbCr30 bit/36 bit signals. This enables finer, minute colour reproduction when a device that supports Deep Colour signals is connected to the plasma television. When Deep Colour signals are received, the colour depth appears on the channel display.

Note

- It may take a short while until the image is displayed, depending on the equipment connected.
- Make sure to use an HDMI compliant cable.
- When inputting 1080p signals, we recommend you use an HDMI cable that supports HDMI Category 2.
- When connecting a PC to the HDMI terminal, use the HDMI compliant PC or video card.
- When connecting a PC to the HDMI terminal using a DVI output terminal, the plasma television may not display properly. If that is the case, consult with your PC manufacturer.
- PC picture and/or sound may not be displayed or heard properly depending on the PC used.

Connecting HDMI equipment

For INPUT 3, connect an HDMI cable for the video and (if necessary) a stereo audio cable for analogue audio. You can select the audio and video format according to the device you have connected - see below for more.

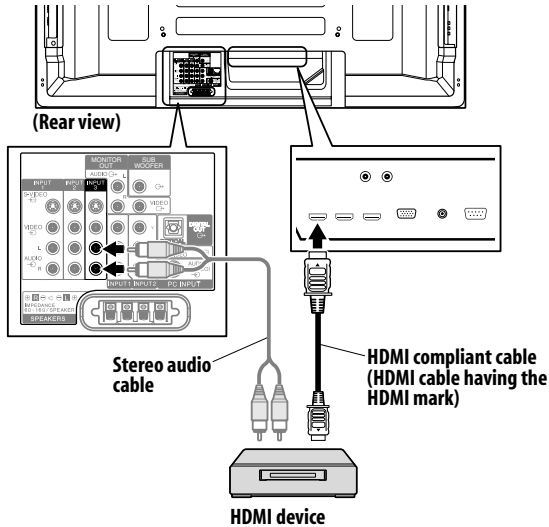

For INPUT 4 and INPUT 5, connect just an HDMI cable - this carries both the audio and video signals.

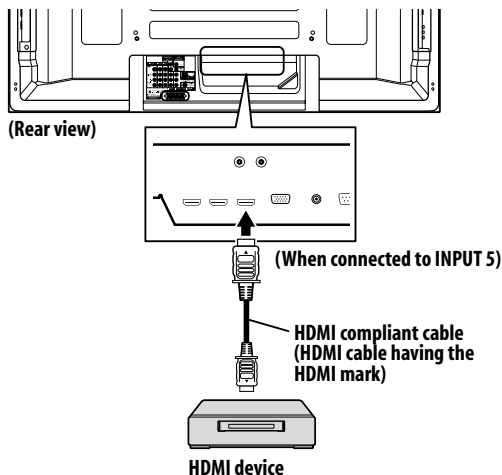

Activating the INPUT 3 HDMI terminal

- 1 Press HOME MENU.
- 2 Select "Option" (↑/↓ then ENTER).
- 3 Select "HDMI Input" (↑/↓ then ENTER).
- 4 Select "Setting" (↑/↓ then ENTER).
- 5 Select "Enable" (↑/↓ then ENTER).

Item	Description
Disable (default)	Deactivates the INPUT 3 HDMI terminal
Enable	Activates the INPUT 3 HDMI terminal

- 6 Press HOME MENU to exit the menu.

Note

- You need not activate the INPUT 4 and INPUT 5 HDMI terminals.

Specifying the type of input signals

- 1 Repeat steps 1 to 3 provided for *Activating the INPUT 3 HDMI terminal*.
- 2 Select "Signal Type" (↑/↓ then ENTER).
- 3 Select "Video" or "PC" (↑/↓ then ENTER).

Item	Description
Video (default)	Select this option except when a PC is connected
PC	Select this option when a PC is connected to the HDMI input terminal

- 4 Press HOME MENU to exit the menu.

Caution

- Make sure to select "PC" when a PC is connected to the HDMI input terminal.

Note

- In the "Video" mode, the image is "over-scanned" (enlarged), and the mode is automatically switched to "PC" when PC signals are received.
- In the "PC" mode, the image is displayed in full size for optimum image quality.

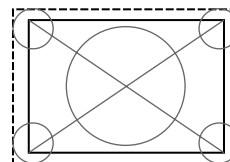

when "Video" is selected ("overscan" size screen)

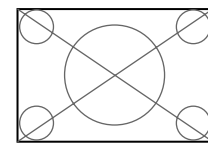

when "PC" is selected ("underscan" size screen)

Specifying the type of digital video signals

- 1 Press **HOME MENU**.
- 2 Select **"Option"** (↑/↓ then **ENTER**).
- 3 Select **"HDMI Input"** (↑/↓ then **ENTER**).
- 4 Select **"Video"** (↑/↓ then **ENTER**).
- 5 Select the type of digital video signals (↑/↓ then **ENTER**).
 - If you select "Auto", an attempt will be made to identify the type of digital video signals when digital video signals are received.

Item	Description
Auto (default)	Automatically identifies input digital video signals
Colour-1	Digital Component Video signals (4:2:2) locked
Colour-2	Digital Component Video signals (4:4:4) locked
Colour-3	Digital RGB signals (16 to 235) locked
Colour-4	Digital RGB signals (0 to 255) locked

- 6 Press **HOME MENU** to exit the menu.

Note

- If you select a parameter other than "Auto", make such a setting that results in natural colour.
- If no image appears or images appear in inappropriate colours, specify another digital video signal type.
- For the digital video signal types to be specified, check the operation manual that came with the connected equipment.

Specifying the type of audio signals

When using the INPUT 3 HDMI terminal, you need to specify the type of audio signals.

- 1 Repeat steps 1 to 3 provided for *Specifying the type of digital video signals*.
- 2 Select **"Audio"** (↑/↓ then **ENTER**).
- 3 Select the type of audio signals (↑/↓ then **ENTER**).
 - If you select "Auto", an attempt will be made to identify the type of audio signals when audio signals are received.

Item	Description
Auto (default)	Automatically identifies the input signals
Digital	Accepts digital audio signals
Analogue	Accepts analogue audio signals

- 4 Press **HOME MENU** to exit the menu.

Note

- The INPUT 4 and INPUT 5 HDMI terminals accept only digital audio signals.
- If no sound is output, specify another audio signal type.
- For the audio signal types to be specified, check the operation manual that came with the connected equipment.
- Depending on the equipment to be connected, you also need to connect analogue audio cables.

Using control cords

Connect control cords between the plasma television and other Pioneer equipment having the **SR** logo to be able to operate the connected equipment via the remote control sensor on the plasma television.

After the CONTROL IN terminals have been connected, the remote control sensors on the connected equipment do not accept commands from the remote control units. Face the remote control units to the remote control sensor on the plasma television when operating the connected equipment.

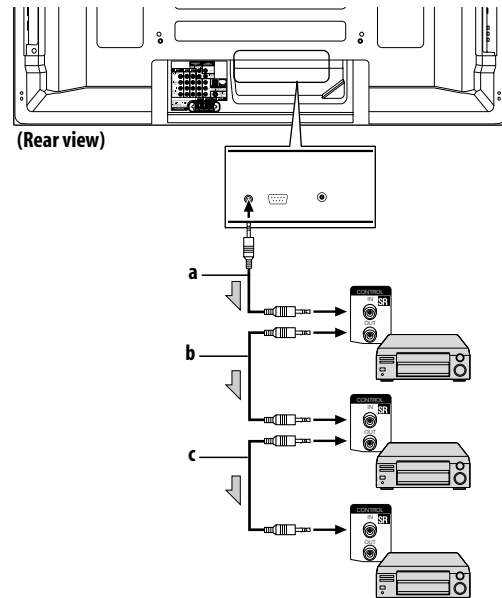

When **SR+** is not used (**a**, **b** and **c**):

The control cables (commercially available) are mono sound cables with mini plugs (no resistance).

When **SR+** is used (**a**):

Use the **SR+** cable (available as option).

Note

- Make sure that the power cord is removed from the power outlet when making connections.
- Complete all component connections before making control cord connections.

About SR+

The CONTROL OUT terminal supports **SR+** to allow linked operations with a Pioneer AV receiver. **SR+** features functions such as automatic input switching and DSP surround mode display.

For more information, see the user's manual for the Pioneer AV receiver supporting **SR+**.

Note

- Use special **SR+** cables available from Pioneer for the connection.
- When using **SR+**, connect the plasma television directly to the receiver with the **SR+** cable.
- When connected with **SR+**, the volume of the plasma television is temporarily muted.

Enjoying through USB interface (Home Gallery function)

On this system, you can watch JPEG images that have been captured and stored in memory cards using a digital still camera. You can also connect your digital camera directly to the plasma television using a USB connector cable.

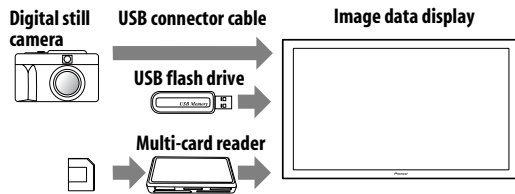

Note

- A single USB device can only be connected at a time. No USB hub can be connected.
- Such devices as a printer or keyboard cannot be connected and used.

Readable memory cards

This system can read memory cards whose formats are FAT16, FAT32, or VFAT.

Readable data files

This system can read only JPEG files that meet the following conditions:

- Extensions are JPG or JPEG.
- JPEG 4:2:2 and 4:2:0 format
- The image resolution must be less than 3264 pixels in the horizontal direction and 2448 pixels in the vertical direction.
- The image resolution must be higher than 160 pixels in the horizontal direction and 120 pixels in the vertical direction.

Note

- This system may not be able to display images, depending on the type of your memory card, or camera.
- This system may not be able to display images modified or edited using a personal computer or other equipment.
- This system complies with the USB Mass Storage Class, SIC (Still Image Capture) Class + PTP and Multiple LUN (Logical Unit Number) Class.

Connecting a USB device

Hold the USB device's connector with its top side facing the front panel, and then insert it into the USB port on the side of the plasma television.

- Insert the USB device's connector as far as it goes.
- When using the USB connector of your device, connect it directly to the USB port.

Side of the plasma television

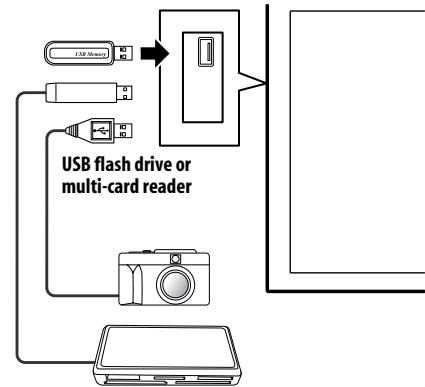

Removing a USB device

To remove a USB device's connector, quit the Home Gallery screen and then remove it.

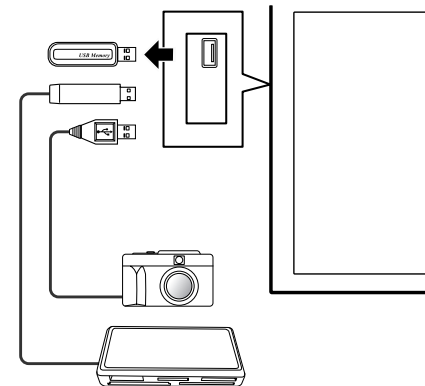

Note

- Be sure to quit the Home Gallery screen before removing the USB device. If you remove the USB device while the Home Gallery screen is displayed, data inside the memory may be damaged.
- Do not insert or remove the USB device immediately after the system is switched on or off. This may cause data inside the memory to be damaged.
- Do not turn the digital camera off while the Home Gallery screen is displayed.

Starting the initial Home Gallery screen

When you connect a USB device while the system is on, the initial screen appears automatically. If the screen does not appear, use the steps 1 and 2.



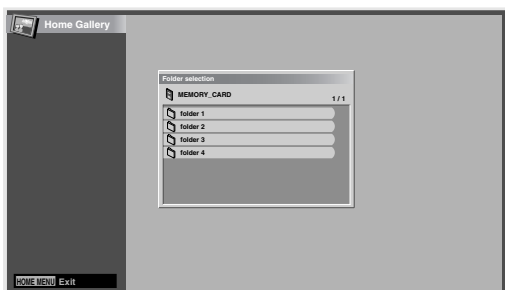

- 1 Press **HOME MENU**.
- 2 Select "Home Gallery" (**↑/↓** then **ENTER**).



- 3 Select a folder (**↑/↓** then **ENTER**).

Selecting a folder

The initial Home Gallery screen shows folders saved in the memory card. Different types of icons appear depending on the contents of folders.

-  — Indicates a folder that contains another folder.
-  — Indicates a folder that contains no image file.
-  — Indicates a folder that contains one or more image files.
-  — Indicates one or more image files saved under the root directory.

To select a desired folder, press **↑/↓** and then **ENTER**. Images in the selected folder are displayed in thumbnail format.

Starting a thumbnail screen

When a folder is selected on the initial Home Gallery screen, images in the folder are displayed in thumbnail format.

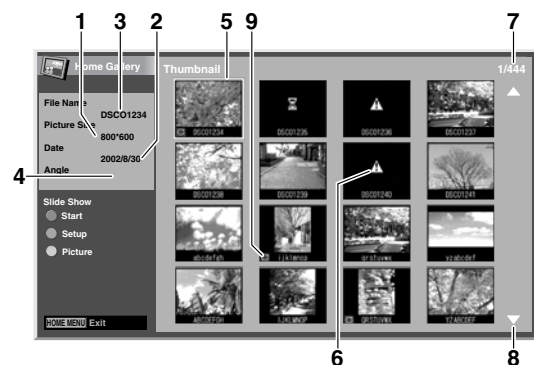

- ① Picture size
- ② Saved date

- ③ File name
- ④ Rotation angle
- ⑤ Image selection cursor
- ⑥ Appears for unreadable images and images that could not be displayed on a single screen.
- ⑦ Number of the selected file/total number of images in the folder
- ⑧ Appears when the folder contains more than 16 images.
- ⑨ Indicates that the picture has been rotated.

Press **↑/↓** to scroll the screen.

To highlight a desired image, press **↑/↓** and **←/→** to move the cursor. Information about the highlighted image appears at the top left of the screen.

Press **HOME MENU** to quit the Home Gallery function.

Starting a standard single-image screen

When the thumbnail screen is displayed, press **↑/↓** and **←/→** to highlight a desired image, and then press **ENTER**. The thumbnail screen disappears and only the selected image is displayed.



With the above screen displayed, you can use the following buttons to perform various operations:

P-:
Displays the previous image in the normal or full screen.

P+:
Displays the next image in the normal or full screen.

RED:
Displays the image using the full screen. To quit the full-screen display, press **RETURN**.

GREEN:
Rotates the displayed image clockwise. Each press rotates the image in the sequence: 90°, 180°, and then 270°.

HOME MENU:
Quits the Home Gallery function.

Note

- Be careful not to display the same image for an extended period of time. This may cause screen burning/image retention.
- Images smaller than 1024 x 768 pixels are displayed with blank surrounding.

Starting the Slide Show Setup screen

When the thumbnail screen is displayed, press **GREEN** to start the screen for setting up for Slide Show that sequentially changes images.

- 1 Select "Display Mode" (↑/↓).
- 2 Select "Normal" or "Full" (←/→).
 - With "Full" selected, images are displayed using the full screen.
- 3 Select "Playback Order" (↑/↓).
- 4 Select "Name Order" or "Random" (←/→).
- 5 Select "Repeat Mode" (↑/↓).
- 6 Select "Single Time" or "Loop" (←/→).
 - With "Loop" selected, Slide Show is repeated until **RETURN** is pressed.
- 7 Select "Playback Mode" (↑/↓).
- 8 Select "Auto" or "Manual" (←/→).
 - With "Auto" selected, images automatically change at the specified intervals.
 - With "Manual" selected, images change each time you press **P+/P-**.



- 9 If you have selected "Auto" in step 8, press ↑/↓ to select "Interval (sec.)", and then press ←/→ to select the desired display duration for individual images.

- You can select from among 3 seconds, 5 seconds, 10 seconds, 20 seconds, 30 seconds, 60 seconds, and 90 seconds.

- 10 To start the Slide Show screen, press **RETURN** to display the thumbnail screen and then press **RED**.

- To quit the Home Gallery function, press **HOME MENU**.

Starting the Slide Show screen

After setting up for Slide Show, you can start Slide Show to sequentially change images.

- 1 To start the Slide Show screen, press **RED** when a thumbnail screen is displayed.
 - With "Auto" selected for "Playback Mode", images automatically change at the specified intervals.
 - With "Manual" selected for "Playback Mode", press **P+/P-** to change images.
 - While images are automatically changing, you can stop and hold automatic image change for approximately 90 seconds by pressing **RED**. To resume, press **RED** again.
- 2 When quitting the Slide Show screen, press **RETURN** to restore the thumbnail screen or **HOME MENU** to quit the Home Gallery function.

Note

- When paused during a slideshow is played, the screen is automatically changed to the next image in five minutes.
- If no operation is continued for five minutes, the Home Gallery function automatically finishes except when the slideshow is played with "Loop" selected for the "Repeat Mode".

Adjusting the picture quality

When a thumbnail screen is displayed, press **YELLOW**. The same picture adjustment screen as the PC source is displayed. For the subsequent procedure, see page 30.

Controlling other equipment using the supplied remote control unit

Using the supplied remote control unit, you can control other equipment in connection: a set-top box (STB), DVD player, DVD/HDD recorder (DVR), BD player or VCR.

Before using this function, you need to preset the supplied remote control unit with the manufacture code of the equipment to be controlled. When you then want to control the equipment, press **SELECT** on the remote control unit to select an appropriate mode depending on the equipment; the selection is switched among TV, STB, DVD/DVR, and VCR. The corresponding mode indicators on the remote control unit show the currently selected mode.

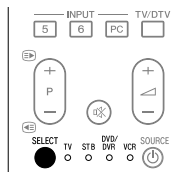

- When you control a BD player, select the DVD/DVR mode.

Presetting manufacture codes

- 1 Press **SELECT** on the remote control unit to select the **STB**, **DVD/DVR**, or **VCR** mode depending on the equipment.
- 2 After confirming that the indicator of the previously selected mode goes off, press and hold **SELECT**, and then press **1** on the remote control unit.
 - The corresponding mode indicator flashes.
- 3 Press **0** to **9** to enter a three-digit manufacture code.
 - See the manufacture code list to identify an appropriate code.
 - The mode indicator lights up for approximately one second and then goes off; presetting the manufacture code is completed.

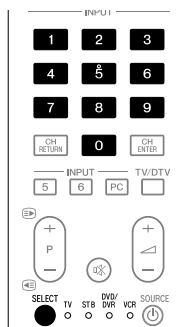

Note

- If you perform no operation for approximately one minute while a mode indicator is flashing, the code presetting procedure is quitted.
- If you enter a code not listed in the table, a mode indicator flashes quickly for approximately one second and then flashes as before.
- To quit the code presetting procedure halfway while a mode indicator is flashing, you may press **SELECT** on the remote control unit.
- The factory default manufacture codes for the STB, DVD/DVR, and VCR modes are "000", "100", and "500" respectively.

Manufacture codes

- Some equipment listed in the table may not allow you to control with the supplied remote control unit partially or entirely.

STB	
000	PIONEER 1 (factory default)
001	PIONEER 2
002	AONVISION
003	ZINWELL
004	CANAL SATELLITE
005	HUMAX
006	PACE 1
007	PACE 2
008	QUALI-TV
009	SKY DIGITAL

DVD	
100	PIONEER 1 (factory default)
101	PIONEER 2
102	AKAI
103	DENON
104	HITACHI
105	JVC
106	KENWOOD 1
107	KENWOOD 2
108	PANASONIC 1
109	PANASONIC 2
110	PHILIPS 1
111	PHILIPS 2
112	SAMSUNG
113	SHARP
114	SONY 1
115	SONY 2
116	SONY 3
117	THOMSON
118	TOSHIBA
119	YAMAHA

DVR

200	PIONEER 1
201	PIONEER 2
202	PIONEER 3
203	PANASONIC
204	PHILIPS 1
205	PHILIPS 2
206	SHARP
207	SONY
208	TOSHIBA

BD

300	PIONEER
-----	---------

VCR

500	PIONEER 1 (factory default)
501	PIONEER 2
502	AIWA 1
503	AIWA 2
504	AKAI 1
505	AKAI 2
506	AKAI 3
507	DAEWOO
508	GRUNDIG 1
509	GRUNDIG 2
510	GRUNDIG 3
511	GRUNDIG 4
512	HITACHI 1
513	HITACHI 2
514	HITACHI 3
515	JVC 1
516	JVC 2
517	JVC 3
518	JVC 4
519	JVC 5
520	LOEWE 1
521	LOEWE 2
522	MATSUI
523	ORION
524	PANASONIC 1
525	PANASONIC 2
526	PHILIPS 1

VCR

527	PHILIPS 2
528	PHILIPS 3
529	SANYO
530	SAMSUNG 1
531	SAMSUNG 2
532	SAMSUNG 3
533	SAMSUNG 4
534	SHARP
535	SONY 1
536	SONY 2
537	SONY 3
538	SONY 4
539	SONY 5
540	SONY 6
541	SONY 7
542	THOMSON
543	TOSHIBA

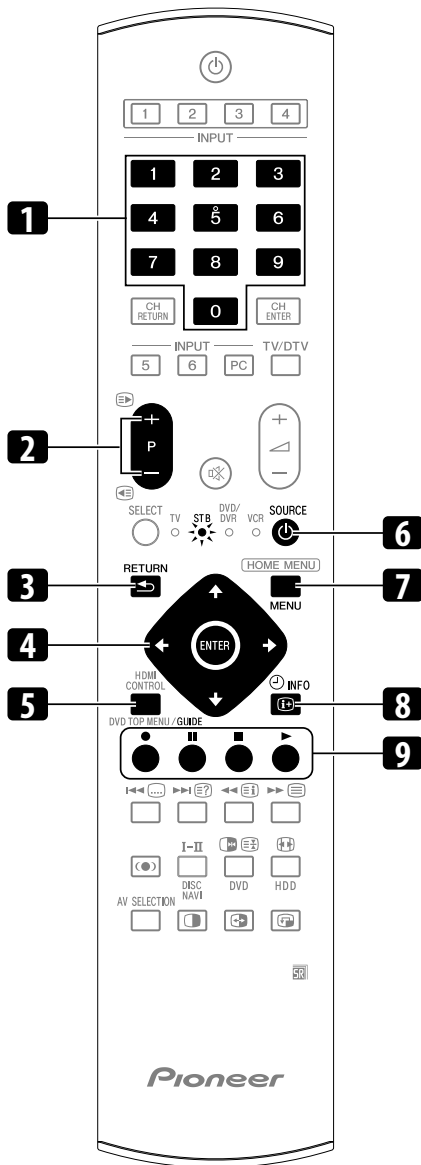

STB (set - top box) control buttons

When in the STB mode, the buttons on the remote control unit function as below.

- 1 0 to 9**
Function as the numeric buttons.
- 2 P+/P-**
Press to tune in a higher or lower channel.
- 3 RETURN**
When the broadcasting menu screen is in display, press to restore the immediately previous screen.
- 4 ENTER**
Press to activate the selected function.
↑/↓/←/→
Press to select items on the broadcasting menu screen or the broadcasting guide screen.
- 5 GUIDE**
Press to display the broadcasting guide screen.
- 6 SOURCE** 
Turns the set-top box on and off.
- 7 MENU**
Press to display the broadcasting menu screen.
- 8 INFO**
Press to display information on the current broadcasting.
- 9 Colour (RED/GREEN/YELLOW/BLUE)**
This operation is available for only AonVision and Zinwell products.

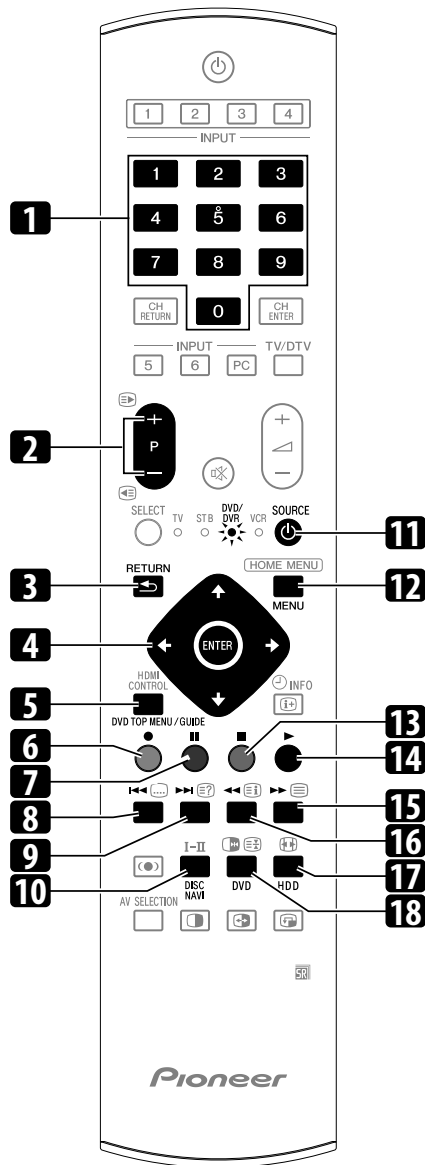

DVD/DVR control buttons

When in the DVD/DVR mode, the buttons on the remote control unit function as below.

- 1 **0 to 9**
Function as the numeric buttons.
- 2 **P+/P-** (DVD/HDD recorder (DVR) only)
Press to change the channel of the tuner built in the DVD/HDD recorder (DVR).
- 3 **RETURN**
When the DVD menu is in display, press to restore the immediately previous screen.
- 4 **ENTER**
Press to activate the selected function.
↑/↓/←/→
Press to select items on the DVD MENU screen.
- 5 **DVD TOP MENU**
When this button is pressed, the DVD top menu will appear.
- 6 **● (REC)** (DVD/HDD recorder (DVR) only)
Starts recording.
- 7 **|| (PAUSE/STILL)**
Sets pauses and still pictures.
- 8 **◀◀ (CHAPTER SEARCH)**
Each time you press, you move back to the start of the previous chapter.
- 9 **▶▶ (CHAPTER SEARCH)**
Each time you press, you move ahead to the start of the next chapter.
- 10 **DISC NAVI** (DVD/HDD recorder (DVR) only)
Press to display the Disc Navigator screen for browsing the contents of a disc.
- 11 **SOURCE** ⏻
Turns on and off the power of the DVD player or DVD/HDD recorder (DVR).
- 12 **MENU**
Press to display the DVD menu.
- 13 **■ (STOP)**
Press to stop playback or recording. With some DVD players or DVD/HDD recorders (DVRs), pressing the button twice may open the disc tray.
- 14 **▶ (PLAY)**
Starts playback.
- 15 **▶▶ (SCAN)**
Press for fast forward.
- 16 **◀◀ (SCAN)**
Press to go backward.
- 17 **HDD** (DVD/HDD recorder (DVR) only)
Press to select the hard disk (HDD) for playback or recording.
- 18 **DVD** (DVD/HDD recorder (DVR) only)
Press to select the DVD for playback or recording.
- 7, 13 **REC STOP** (DVD/HDD recorder (DVR) only)
Press ● and ■ at the same time to stop recording. This operation is available for only Pioneer and Sony DVD/HDD recorders (DVRs).



Note

- You can control a BD player in the DVD/DVR mode.
- The DVD player, DVD/HDD recorder (DVR) or BD player cannot be selected at the same time.

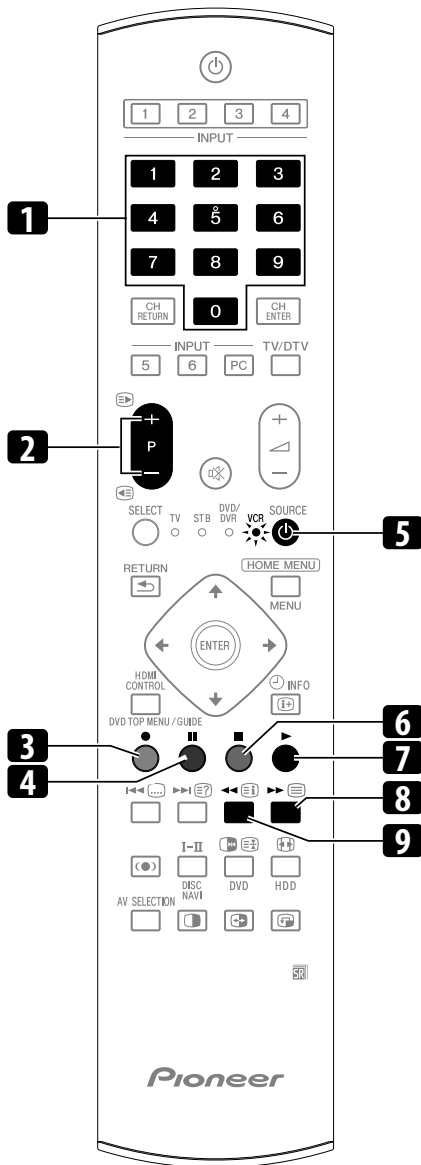

VCR control buttons

When in the VCR mode, the buttons on the remote control unit function as below.

- 1 **0 to 9**
Function as the numeric buttons.
- 2 **P+/P-**
Press to select channels of the TV tuner on the VCR.
- 3 **● (REC)**
Starts recording.
- 4 **|| (PAUSE/STILL)**
Sets pauses and still pictures.
- 5 **SOURCE**
Turns the power of the VCR on and off.
- 6 **■ (STOP)**
Stops playback.
- 7 **▶ (PLAY)**
Starts playback.
- 8 **▶▶ (FF)**
Fast-forward the tape and allows picture search.
- 9 **◀◀ (REW)**
Rewinds the tape and allows picture search.

Chapter 12

Using the HDMI Control

Using the HDMI Control functions

You can operate such Pioneer devices as a recorder, player or AV system that support the HDMI Control functions using the remote control of the plasma television.

The HDMI Control functions include playback of content using on-screen control panel on the plasma television, recording of a TV programme while watching, timer recording using a programme list on the connected recorder, and confirmation of timer recording registered in the recorder. For details, see the table below.

Note

- Maximum number of devices that can be connected and controlled using the remote control unit of the plasma television is as follows: recorder x 2, player x 2, AV system x 1.
- Not all device operations may be available for HDMI Control functions.

HDMI Control functions

Function	Description	Usable devices
Playback of content	The proper input source is automatically selected and the content is played back on the plasma television as you press PLAY on the connected device	Recorder/ player
On-screen control	Recorder/player operation can be controlled on-screen or with the remote control unit of the plasma television (play, stop, fast forward/reverse, etc.)	Recorder/ player
Recording of TV programme	The programme now watching can be recorded using the remote control unit of the plasma television	Recorder
Timer recording	Timer recording using a programme list on the recorder connected	Recorder
Confirmation of recording schedule	Recording schedule registered in the recorder can be displayed and confirmed on the screen using the remote control unit of the plasma television	Recorder
Display Language Setup	Information on the display menu language is transferred to the recorder or player connected to the plasma television. For details, see the operation manual that came with the recorder or player.	Recorder/ player
AV system control	Receiver/amplifier operation can also be controlled with the remote control unit of the plasma television (volume, surround mode and input selection of the HDMI terminal)	AV system
Power On	The connected recorder can be turned On when the plasma television is turned On. The plasma television can be turned On when the connected recorder(s) or player(s) is turned On and images are input to the plasma television.	Recorder/ player
Power Off	The connected device(s) can be turned Off when the plasma television is turned Off	Recorder/ player/AV system

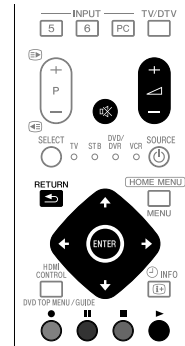

- Press \triangle + / - or \times to adjust volume for the AV system.
- Press \uparrow , \downarrow , \leftarrow , \rightarrow , ENTER, RETURN (\rightarrow) or colour (BLUE, RED, YELLOW, GREEN) buttons to use such functions as the disc navigator and electronic programme guide (EPG) on the connected recorder or player.

Note

- When using the HDMI Control functions, operate the remote control unit while pointing it toward the remote control sensor (SR) located at the bottom right of the front panel of the plasma television.
- You cannot use two or more HDMI terminals at the rear of the plasma television at the same time except "Power Off" and "Display Language Setup" functions.

On-screen control panel

For an AV system

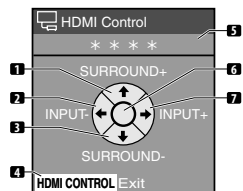

- 1 Switches the surround mode in order
- 2 Switches the input source in reverse order
- 3 Switches the surround mode in reverse order
- 4 Closes the control panel to return to the HDMI Control menu
- 5 Displays the model number of the connected device
- 6 Void
- 7 Switches the input source in order

Press **↑** or **↓** on the remote control unit of the plasma television to switch the surround mode in order or in reverse order, **←** or **→** to switch the input source in order or in reverse order. Pressing **HDMI CONTROL** closes the control panel to return to the HDMI Control menu.

Note

- You cannot operate the recorder/player when you press **←** or **→** to switch the input source during operation. To resume the operation, return to the HDMI Control menu and select the desired function again.

For a recorder

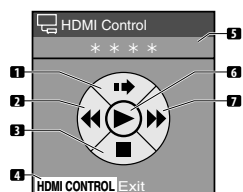

- 1 Skips commercials
- 2 Fast reverse
- 3 Stops playback
- 4 Closes the control panel to return to the HDMI Control menu
- 5 Displays the model number of the connected device
- 6 Starts playback
- 7 Fast forward

Press **←** or **→** on the remote control unit of the plasma television to select fast reverse or fast forward mode, **↑** to skip commercials or **↓** to stop playback. Pressing **ENTER** starts playback and **HDMI CONTROL** closes the control panel to return to the HDMI Control menu.

For a player

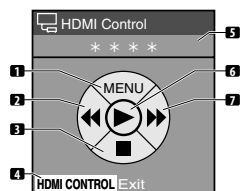

- 1 Displays the DVD disc menu or Blu-ray disc's pop-up menu on the player
- 2 Fast reverse
- 3 Stops playback
- 4 Closes the control panel to return to the HDMI Control menu
- 5 Displays the model number of the connected device
- 6 Starts playback
- 7 Fast forward

Press **←** or **→** on the remote control unit of the plasma television to select fast reverse or fast forward mode, **↑** to display the DVD disc menu or Blu-ray disc's pop-up menu on the player or **↓** to stop playback. Pressing **ENTER** starts playback and **HDMI CONTROL** closes the control panel to return to the HDMI Control menu.

Making the HDMI Control connections

When you make changes in connections between the plasma television and the device(s) that supports the HDMI Control functions or settings for the "HDMI Control Setting", perform the following procedure:

- 1 Turn on the plasma television and all the connected devices.
- 2 Confirm that the setting in "Input Setting" for "HDMI Control Setting" is properly entered according to the connected devices. Also confirm the HDMI Control related settings in the connected devices.
- 3 Switch to the HDMI input terminals to which the devices are connected to check if audio and video images are properly output and displayed.
- 4 Try turning off the plasma television, then turn the power back on to the plasma television.

Connecting an AV amp/DVD recorder/BD player

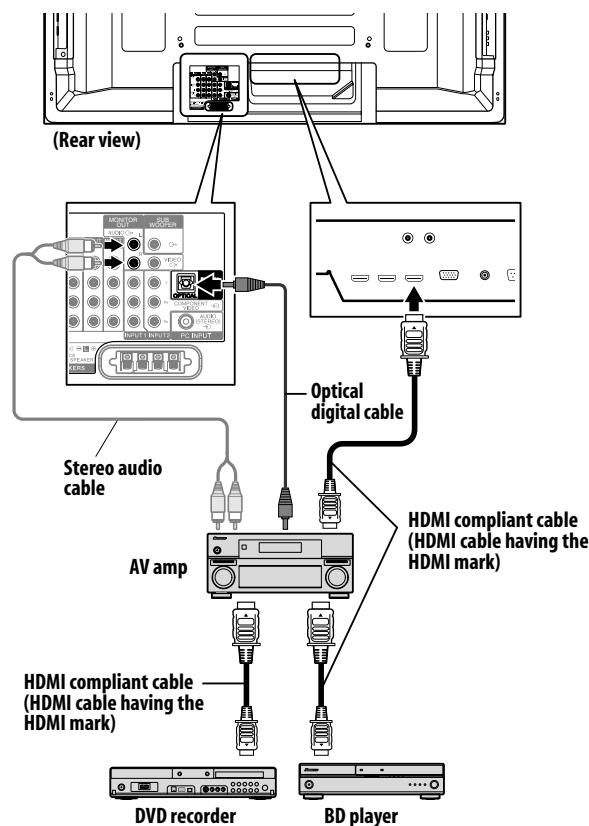

Connecting a DVD recorder

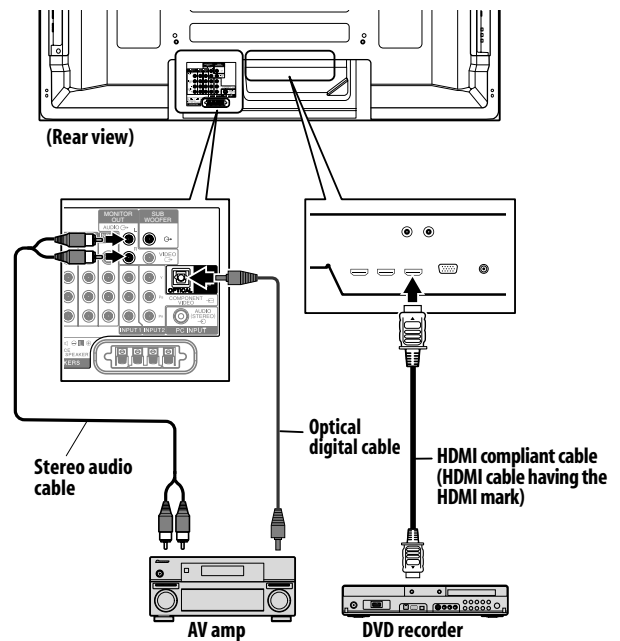
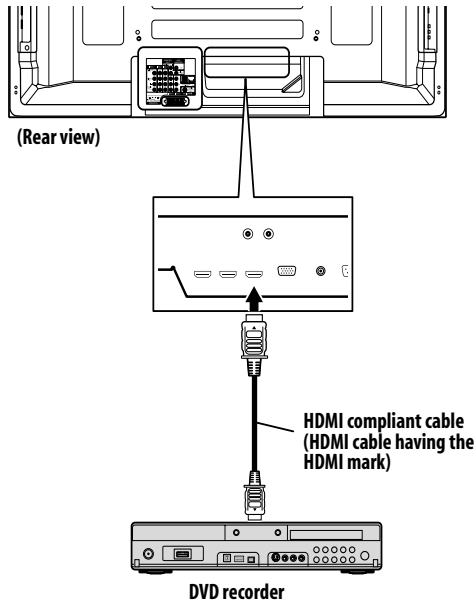
 **Note**

- Maximum number of devices that can be connected and controlled using the remote control unit of the plasma television is as follows: recorder x 2, player x 2, AV system x 1.
- When connecting an AV system, be sure to place and connect it between the plasma television and recorder or player.
- Do not connect an AV system that does not support the HDMI Control functions between the plasma television and a recorder/player, otherwise the HDMI Control functions may not operate properly.
- When connecting an AV system that does not support the HDMI Control functions and a player/recorder that supports the HDMI Control functions to the plasma television, connect the AV system to the DIGITAL OUT terminal and the MONITOR OUT terminal on the plasma television using an optical digital cable and a stereo audio cable, and the recorder/player to the HDMI terminal using an HDMI compliant cable (see the illustration on the right).
Please note that signals input from the HDMI terminals will not be output from the DIGITAL OUT terminal.
- HDMI Control may not operate properly if you do not use an HDMI cable that supports the HDMI 1.3 Specification.

- After making connections, enter the setting in "Input Setting" for "HDMI Control Setting". Be sure that the setting is entered in each HDMI input terminal to which the device is connected.
- Settings in the connected device(s) are also required to use the HDMI Control functions. For details, see the operation manual that came with the connected device(s).
- When a recorder is connected, its power is automatically switched on as the plasma television is turned On to help make the recording smoother.
- When the image from a BD/DVD player or DVD recorder connected through an HDMI Control supported AV system is switched to display on sub screen in the 2-screen or picture-in-picture mode, the sub screen turns black without displaying any image.
- For more information on the devices that support the HDMI Control functions, check the Pioneer Web site (see back cover).

Setting the HDMI Control

Selecting the input terminal

Select the HDMI terminal to which the external device is connected in order to use the HDMI Control functions.

- 1 Press HOME MENU.
- 2 Select "Option" (↑/↓ then ENTER).
- 3 Select "HDMI Control Setting" (↑/↓ then ENTER).

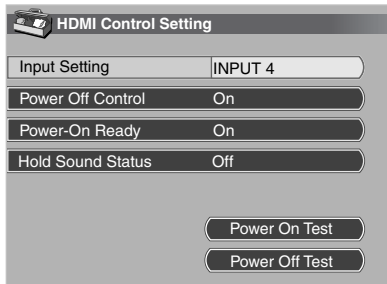

- 4 Select "Input Setting" (↑/↓ then ENTER).
- 5 Select "INPUT 3", "INPUT 4" or "INPUT 5" (↑/↓ then ENTER).

Only the device that supports the HDMI Control and is connected through the selected INPUT terminal is available for the HDMI Control functions.

- 6 Press HOME MENU to exit the menu.

Note

- "INPUT 3" can only be selected when "Enable" has been selected for the "HDMI Input" menu (see *Activating the INPUT 3 HDMI terminal* on page 55).
- If you have selected "Off" in step 5, a message "Operations cannot be carried out. Confirm the HDMI control settings." appears when **HDMI CONTROL** is pressed on the remote control unit.
- If you operate an HDMI supported device(s) using an HDMI terminal other than the terminal selected in "Input Setting", a malfunction may occur. When connecting to any HDMI terminals other than the terminal selected in "Input Setting", make sure to enter the settings of the external device(s) so that the HDMI Control function does not operate.

Selecting the Power Off Control

You can select whether or not the connected device is turned Off when the plasma television is turned Off. (factory default is "On")

- 1 Repeat steps 1 to 3 in *Selecting the input terminal*.
- 2 Select "Power Off Control" (↑/↓ then ENTER).
- 3 Select "On" (↑/↓ then ENTER).
- 4 Press HOME MENU to exit the menu.

Note

- The "Power Off Control" function is valid for the devices connected to any of HDMI terminals at the rear of the plasma television.

Selecting the Power-On Ready

You can select whether or not the plasma television is turned On when the connected Pioneer recorder or player is turned On and images are input to the plasma television. (factory default is "On")

- 1 Repeat steps 1 to 3 in *Selecting the input terminal*.
- 2 Select "Power-On Ready" (↑/↓ then ENTER).
- 3 Select "On" (↑/↓ then ENTER).
- 4 Press HOME MENU to exit the menu.

Selecting the Hold Sound Status

You can select whether or not audio continues to come from the connected Pioneer AV system even if the system is placed into standby during HDMI Control operations. (factory default is "Off")

- 1 Repeat steps 1 to 3 in *Selecting the input terminal*.
- 2 Select "Hold Sound Status" (↑/↓ then ENTER).
- 3 Select "On" (↑/↓ then ENTER).
- 4 Press HOME MENU to exit the menu.

Power On/Off Test

You can confirm if the Power On/Off control function is effective between the plasma television and the connected device.

- 1 Repeat steps 1 to 3 in *Selecting the input terminal*.
- 2 Select "Power On Test" or "Power Off Test" (↑/↓ then ENTER).
A list containing devices appears when multiple HDMI devices are connected to the HDMI terminals.
- 3 Select the desired device (↑/↓ then ENTER).
- 4 Press HOME MENU to exit the menu.

Note

- Devices that can be checked for Power On/Off Test are those connected to HDMI terminals as set in "Input Setting".
- If the Power On/Off Test fails, check for the connection and setting.

Using the HDMI Control menus

You can enjoy various functions with the connected Pioneer recorder, player or AV system that supports the HDMI Control functions by selecting and using the corresponding HDMI Control menus.

1 Press HOME MENU.

2 Select "HDMI Control" (↑/↓ then ENTER).

The HDMI Control menu is displayed.

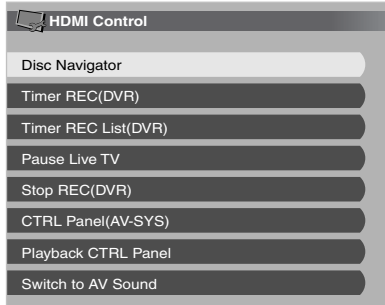

HDMI Control menu

Item	Description
Disc Navigator	Displays a title list of the connected recorder or player
Timer REC (DVR)	Displays an electronic programme guide (EPG) of the connected recorder
Timer REC List (DVR)	Displays a timer recording list of the connected recorder
Pause Live TV	Starts recording of the current TV channel when a recorder is connected, but with playback paused, effectively pausing the broadcast
Stop REC (DVR)	Stops recording for the connected recorder
CTRL Panel (AV-SYS)	Displays the control panel for the connected AV system on the plasma television
Playback CTRL Panel	Displays the control panel for the connected recorder or player on the plasma television
Switch to AV Sound (Switch to PDP Sound)	Switches between the plasma television and the connected AV system to which sound is output

Note

- To use the HDMI Control functions, a Pioneer recorder, player or AV system that supports the HDMI Control functions is required.
- Not all operations may be controlled for the connected devices.
- The HDMI Control menu is not selectable when "Off" is selected in "Input Setting" for the "HDMI Control Setting" menu.
- While watching a DTV programme, the Pause Live TV menu may not work properly immediately after the plasma television is turned on or the channel is selected.
- Even when the programme being recorded is over, recording is not automatically stopped on the Pause Live TV menu.
- The CTRL Panel (AV-SYS) menu is only available when the sound is output from the AV system.
- The Playback CTRL Panel menu is selectable when the connected recorder or player is ready to operate.
- You can also display the HDMI Control menu by pressing **HDMI CONTROL** on the remote control unit of the plasma television.

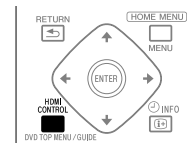

Chapter 13 Using Teletext

Using the Teletext functions

What is Teletext?

Teletext broadcasts pages of information and entertainment to specially equipped television sets. Your plasma television receives Teletext signals broadcast by TV networks, and decodes them into graphical format for viewing. News, weather and sports information, stock exchange prices and programme previews are among many services available.

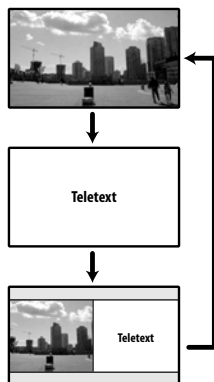
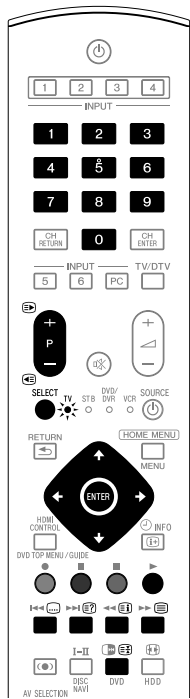

Important

- Displaying Teletext pages for a long period of time, or for shorter periods of time everyday, may result in image retention.



Operating the Teletext basics for analogue TV or external input sources

Turning on and off Teletext

- 1 Select a TV channel or external input source providing a Teletext programme.
- 2 Press  to display the Teletext (full screen).
- 3 Press  again to display the Teletext on the right screen and normal image on the left screen.
 - Each time you press , the screen switches as shown to the left.
 - If you select a programme with no Teletext signal, "Cannot display Teletext." appears.

Selecting and operating Teletext pages

Use the following remote control buttons to select and operate Teletext pages.

Colour (RED / GREEN / YELLOW / BLUE):

You can select a group or block of pages displayed in the coloured brackets at the bottom of the screen by pressing the corresponding colour (RED / GREEN / YELLOW / BLUE) on the remote control unit.

0 to 9:

Directly select any page from 100 to 899 by using 0 to 9.

/

Press  to increase the page number.

Press  to decrease the page number.

To display hidden information such as an answer to a quiz, press .

Press  again to hide the information.

To stop updating Teletext pages, press .

Press  again to release the hold mode.

Displays an Index page for the CEEFAX/FLOF format. Displays a TOP Over View page for the TOP format.

Note

- Before displaying the Teletext, return the screen to the single-screen mode.

Displaying subpages

You can display several subpages as they are transmitted.

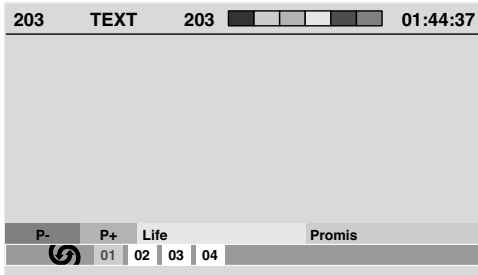

- 1 Press **[Teletext]** to display Teletext.
 - If you open a page containing subpages, the subpages are automatically displayed in sequence.
- 2 To quit automatic subpage change, press **[Left/Right]**.
 - You can then manually change subpages by pressing **[Left/Right]**.

Note

- Pressing **[Teletext]** / **[Teletext]** causes the page to be changed and the subpage screen to disappear.
- Pressing **[Teletext]** stops automatic subpage change and performs its respective button function.

Displaying TOP Over View

When receiving TOP Teletext, you can read a TOP text overview.

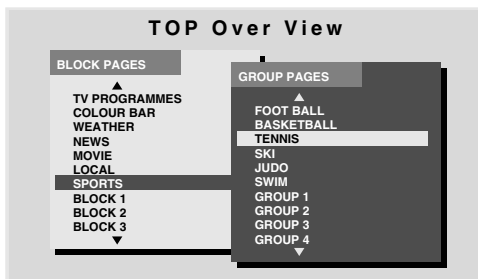

- 1 Press **[Teletext]** to display Teletext.
- 2 While receiving TOP Teletext, press **[TOP]** to display TOP Over View.
- 3 Press **[Up/Down]** and **[Left/Right]** to select the desired block or group pages, and then press **ENTER**.

Displaying subtitle pages

You can display several subtitles as they are transmitted.

- 1 Press **[Subtitle]** to display the subtitle.
 - Subtitle is updated by the information sent by the broadcasting station.
- 2 Press **[Subtitle]** again to access next available subtitle screen.

Operating the Teletext basics for DTV

Note

- When the current DTV programme contains Teletext information, you can display it on the screen by pressing **[Teletext]**. In this case, the "TTX" is displayed in the banner (i-PLATE).

Turning Teletext on and off

- 1 Select a digital TV channel providing a Teletext programme.
- 2 Press **[Teletext]** to display the Teletext.
- 3 Press **[Teletext]** again to turn the display off.

Selecting and operating Teletext pages

Use the following remote control buttons to select and operate Teletext pages.

Colour (RED/GREEN/YELLOW/BLUE):

You can select a group or block of pages displayed in the coloured brackets at the bottom of the screen by pressing the corresponding colour (RED/GREEN/YELLOW/BLUE) on the remote control unit.

0 to 9:

Directly select any page from 100 to 899 using buttons **0** to **9**.

[Teletext]/[Teletext]:

Press **[Teletext]** to increase the page number.

Press **[Teletext]** to decrease the page number.

[Teletext]:

To display hidden information such as an answer to a quiz, press

[Teletext]:

- Press **[Teletext]** again to hide the information.

[Teletext]:

To stop updating Teletext pages, press **[Teletext]**.

Press **[Teletext]** again to release the hold mode.

[Teletext]:

Returns to the index page.







Note

- Before displaying the Teletext, return to the single-screen mode.

Chapter 14



Additional information

Troubleshooting

Problem	Possible solution
GENERAL	
<ul style="list-style-type: none"> • No power. • System cannot be switched on. 	<ul style="list-style-type: none"> • Is the power cord disconnected? (See page 18.) • Has  switch been turned on? (See page 20.) • Check if you pressed buttons 0 to 9 or  on the remote control unit. (See page 20.) • If the indicator on the system lights up red, press 0 to 9 or  on the remote control unit or STANDBY/ON on the plasma television.
<ul style="list-style-type: none"> • Power is suddenly turned off. 	<ul style="list-style-type: none"> • The system's internal temperature has increased. Remove any objects blocking vent or clean. (See page 15.) • Check the power control setting. (See page 36.) • Check the sleep timer setting. (See page 49.)
<ul style="list-style-type: none"> • The system cannot be operated. 	<ul style="list-style-type: none"> • External influences such as voltage malfunction, static electricity, etc., may cause improper operation. In this case, operate the system after unplugging the power cord and re-plugging it in after one or two minutes.
<ul style="list-style-type: none"> • Remote control unit does not operate. 	<ul style="list-style-type: none"> • Is the TV indicator on the remote control unit lighted? Press SELECT on the remote control unit to select the TV mode. • Are batteries inserted with polarity (+, -) aligned? (See page 18.) • Are batteries worn out? Replace with new batteries. (See page 18.) • Operate the remote control unit while pointing it toward the remote control sensor on the plasma television. (See page 19.) • Are you using it under strong or fluorescent lighting? • Is a fluorescent light illuminated to remote control sensor? • Check if any obstacles exist between the remote control unit and the remote control sensor.
<ul style="list-style-type: none"> • Panel sounds /noises. 	<ul style="list-style-type: none"> • Panel generated sounds—for example, fan motor noise, electrical circuit humming, glass panel buzzing—are normal operation of a phosphor-based matrix display. • When you change the Energy Save mode, you may notice a change in the panel sound. This is normal.
PICTURE/SOUND	
<ul style="list-style-type: none"> • Screen appears dark. 	<ul style="list-style-type: none"> • Check if any obstacles exist in front of the Room Light Sensor. (See pages 12 and 48.)
<ul style="list-style-type: none"> • No image and audio is presented. 	<ul style="list-style-type: none"> • Have you finished initial scanning for digital TV channels? (See page 27.) • Check if the input source for video or PC has been unintentionally selected although you want to watch a TV channel. (See page 21.) • Check if you have selected a channel blocked with Child Lock. (See page 28.) • Enter a password to temporarily cancel Child Lock. (See page 49.) • Check the cable connection with the antenna. (See page 17.) • Check the cable connection with the other equipment. (See pages 51 to 56.)
<ul style="list-style-type: none"> • No picture. 	<ul style="list-style-type: none"> • Is connection to other components correct? (See pages 51 to 56.) • Is a non-compatible PC signal being input? (See page 53.)
<ul style="list-style-type: none"> • Audio is output but no image is presented. 	<ul style="list-style-type: none"> • Check if you have selected "Picture Off" for Energy Save. With this option selected, the screen is deactivated: only sound is output. To restore the screen display, press any button other than  (Sound Effect),  +/  - or  (See page 36).
<ul style="list-style-type: none"> • Images are presented but no audio is output. 	<ul style="list-style-type: none"> • Check if you have selected the minimum volume. (See page 21.) • Check that no headphones are connected. • Check that the sound is not muted. (See page 21.) • Check that the audio input is also connected. (See pages 51 to 53.) • Check the sound system selected for a TV channel where problems have occurred (see page 22). Reselect the correct sound system. • Check that the appropriate DIGITAL OUT (PCM or Dolby Digital) is selected.
<ul style="list-style-type: none"> • Sound is reversed between the right and left speakers. • Sound is output from only a single speaker. 	<ul style="list-style-type: none"> • Check if the speaker cable connections have been reversed between the right and left or if the speaker cable from either speaker has been disconnected (for PDP-508XDA only). (See page 13.) • Has the balance been correctly adjusted? (See page 35.)
<ul style="list-style-type: none"> • Picture is cut off. 	<ul style="list-style-type: none"> • Is the image position correct? (See page 45.) • Has the correct screen size been selected? (See page 46.)
<ul style="list-style-type: none"> • Strange colour, light colour, dark or colour misalignment. 	<ul style="list-style-type: none"> • Adjust the picture tone. (See pages 30 to 33.) • Is the room too bright? The picture may look dark in a room that is too bright. • Check the colour system setting. (See page 46.)

Problem	Possible solution
<ul style="list-style-type: none"> • After-image lag. 	<ul style="list-style-type: none"> • After displaying a still image or a very bright image for a certain period of time, if the screen is then switched to a darker scene, the previous image may appear as an after-image. • This can be rectified by playing a rather bright moving image for several minutes. However, displaying a still image for excessively long periods of time may cause permanent display deterioration. • To help eliminate after-image when it occurs, display the "Video Pattern" screen. (See page 49.)
<ul style="list-style-type: none"> • Brightness and colour tone on both sides differ from those in the center in 4:3 mode. 	<ul style="list-style-type: none"> • If images in 4:3 mode or letterbox images are displayed for long periods or for shorter periods over several days, an after-image may remain due to burning. This is a characteristic of plasma televisions. • We recommend that you enjoy watching images in a full screen mode as much as possible. (See page 46.) • When watching images in 4:3 mode, we recommend you select "Auto" for the Side Mask setting. This adjusts the brightness of the grey side masks according to the brightness of the main image. (See page 48.)

HDMI Control	
<ul style="list-style-type: none"> • HDMI Control functions do not operate. 	<ul style="list-style-type: none"> • Check if the connections are properly made between the plasma television and the device that supports the HDMI Control functions. (See page 66.) • HDMI Control may not operate properly if you do not use an HDMI cable that supports the HDMI 1.3 Specification. • Check if you have entered the settings properly for "HDMI Control Setting". (See page 68.) • Check if the settings for the HDMI Control functions are effective on the connected device(s). For details, refer to the operation manual that came with the device.
<ul style="list-style-type: none"> • No image and audio is presented. 	<ul style="list-style-type: none"> • Check if the connections are properly made between the plasma television and the device that supports the HDMI Control functions. (See page 66.) • Check if you have entered the settings properly for the HDMI Control Setting. (See page 68.)
<ul style="list-style-type: none"> • No picture. 	<ul style="list-style-type: none"> • Check if the connections are properly made between the plasma television and the device that supports the HDMI Control functions. (See page 66.) • Check if you have entered the settings properly for "HDMI Control Setting". (See page 68.) • When the image from a BD/DVD player or DVD recorder connected through an HDMI Control supported AV system is switched to display on sub screen in the 2-screen or picture-in-picture mode, the sub screen turns black without displaying any image.
<ul style="list-style-type: none"> • No sound. 	<ul style="list-style-type: none"> • Check if the connections are properly made between the plasma television and the device that supports the HDMI Control functions. (See page 66.) • Check if you have entered the settings properly for "HDMI Control Setting". (See page 68.) • Check if you have an HDMI controlled AV system connected to one HDMI terminal and the recorder or player connected to another HDMI terminal on the plasma television. When connected this way, audio out from the recorder/player does not go through the plasma television SPDIF terminal resulting in no sound to the AV system. When using an AV system and recorder or player, be sure to connect the recorder or player to the AV system input terminal.
<ul style="list-style-type: none"> • An error message "The device cannot be operated. Please check the connection." appears. 	<ul style="list-style-type: none"> • Check if the connections are properly made between the plasma television and the device that supports the HDMI Control functions. (See page 66.) • Check if you have entered the settings properly for "HDMI Control Setting". (See page 68.)

OTHER	
<ul style="list-style-type: none"> • POWER ON indicator or STANDBY indicator is quickly flashing. 	<ul style="list-style-type: none"> • Internal protective circuits may have been activated. First turn off  on the plasma television, and then turn the power on by pressing  again after waiting one minute or more. If the indicator is still flashing, unplug the plasma television's power cord from the power outlet. Wait one to two minutes then plug in the plasma television again. If this does not solve the problem, contact a Pioneer Service Center or Pioneer Authorized Independent Service company. These are listed on your warranty card for each country or region.
<ul style="list-style-type: none"> • An external device connected to the USB terminal does not operate. 	<ul style="list-style-type: none"> • Check if the device is connectable to the display. (See page 57.) • Re-insert the USB cable. (See page 57.) • For connection, use a USB cable shorter than 5 m. (See page 57.) • Check if the USB cable is properly connected. (See page 57.) • First turn off  on the plasma television and then turn it on again in order to check if the external device works correctly. • Check if the external device works correctly after the USB device was restarted. • Check if the digital still camera is in the viewing mode. • Refer to the instruction manual for the digital still camera.
<ul style="list-style-type: none"> • Photo data stored in digital still cameras cannot be read through the USB interface. 	<ul style="list-style-type: none"> • Check if the device is connectable to the display. (See page 57.) • Check if the digital still camera turns on.

If the following error codes appear on the screen, check the corresponding items in the table.

Code	Message	Check
SD04 and SD11	Powering off. Internal temperature too high. Check temperature around PDP.	Check if the ambient temperature of the plasma television is high.
SD05	(PDP-508XDA) Internal protection circuit turns power off. Is there a short in the speaker cable? (PDP-428XDA) Internal protection circuit turns power off.	Check the speaker cable connections between the plasma television and the speakers. Contact a Pioneer Service Center or Pioneer Authorized Independent Service company. These are listed on your warranty card for each country or region.

Signal assignments for 15-pin D-sub connector

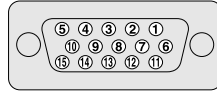

Pin No.	Signal assignment	Pin No.	Signal assignment
1	R	9	+5 V
2	G	10	GND (ground)
3	B	11	Not connected
4	Not connected	12	SDA
5	Not connected	13	HD
6	GND (ground)	14	VD
7	GND (ground)	15	SCL
8	GND (ground)		

Specifications

Item	50" plasma television, model: PDP-508XDA		42" plasma television, model: PDP-428XDA	
Number of pixels	1365 x 768 pixels		1024 x 768 pixels	
Audio amplifier	17 W + 17 W (1 kHz, 10 %, 6 Ω)			
Speakers	-		Woofer: 4.8 cm x 13 cm cone type Tweeter: 2.5 cm semidome type	
Sound Effect	SRS FOCUS/SRS/SRS TruBass			
Power Requirements	240 V AC, 50 Hz, 369 W (0.4 W Standby)		240 V AC, 50 Hz, 299 W (0.4 W Standby)	
Dimensions	1224 mm (W) x 717 mm (H) x 115 mm (D)		1040 mm (W) x 679 mm (H) x 115 mm (D)	
Weight	35.2 kg (77.6 lbs.)		30.2 kg (66.6 lbs.)	
Colour System	Analogue	PAL/SECAM/NTSC/4.43 NTSC/PAL-M/PAL-N		
	Digital	PAL		
TV Function (Analogue)	Receiving System	PAL: B/G, D/K, I SECAM: B/G, D/K NTSC: M/N		
	Tuner	VHF/UHF	44.25 MHz to 863.25 MHz	
		CATV	Hyper-band, S1 ch to S41 ch	
	Auto Channel Preset	99 ch, Auto Preset		
	Audio multiplex	NICAM/A2/BTSC System		
TV Function (Digital)	Receiving System	DVB-T (2K/8K COFDM)		
	Tuner	VHF/UHF	VHF Band (104.5 MHz to 226.5 MHz) and UHF Band (526.5 MHz to 816.5 MHz)	
		Auto Channel Preset	999 ch, Auto Preset, Auto Label	
	STEREO	MPEG layer I/II, Dolby Digital		
Terminals	Rear	INPUT 1	COMPONENT VIDEO in, S-VIDEO in, AV in	
		INPUT 2	COMPONENT VIDEO in, S-VIDEO in, AV in	
		INPUT 3	S-VIDEO in, AV in, HDMI in*1	
		INPUT 4	HDMI in*1	
		INPUT 5	HDMI in*1	
		PC INPUT	Analogue RGB in, Audio in	
		CONTROL OUT	1	
		MONITOR OUT	AV out	
		SUBWOOFER	Variable	
		DIGITAL OUT	Digital audio output (Optical)	
	SPEAKERS	6 Ω to 16 Ω	-	
	Antenna	75 Ω Din Type for VHF/UHF in (Analogue) 75 Ω Din Type for VHF/UHF in (Digital)		
	Side	INPUT 6	S-VIDEO, AV in	
		USB	USB in*2	
		PHONES OUTPUT	16 Ω to 32 Ω recommended	

*1 This conforms to HDMI1.3 and HDCP1.1. HDMI (High-Definition Multimedia Interface) is a digital interface that handles both video and audio using a single cable. HDCP (High-bandwidth Digital Content Protection) is a technology used to protect copyrighted digital contents that use the Digital Visual Interface (DVI).

*2 This conforms to USB 1.1 and 2.0 specifications.

Design and specifications are subject to change without notice.

Trademarks

-  is a trademark of SRS Labs, Inc.
- WOW technology is incorporated under license from SRS Labs, Inc.
- This product includes FontAvenue® fonts licensed by NEC Corporation. FontAvenue is a registered trademark of NEC Corporation.
- DDC is a registered trademark of Video Electronics Standards Association.
- HDMI, the HDMI logo and High-Definition Multimedia Interface are trademarks or registered trademarks of HDMI Licensing LLC.
- Manufactured under license from Dolby Laboratories. "Dolby" and the double-D symbol are trademarks of Dolby Laboratories.
- The names of companies or institutions are trademarks or registered trademarks of the respective companies or institutions.



AFTER-SALES SERVICE FOR PIONEER PRODUCTS
PIONEER ELECTRONICS AUSTRALIA PTY. LTD
PIONEER SERVICE AND PARTS CENTER
2211 PRINCES HIGHWAY MULGRAVE, VICTORIA 3170
PHONE: 1800-988-268

<http://www.pioneer.com.au>

PIONEER CORPORATION

4-1, Meguro 1-Chome, Meguro-ku, Tokyo 153-8654, Japan

PIONEER ELECTRONICS (USA) INC.

P.O. BOX 1540, Long Beach, California 90801-1540, U.S.A. TEL: (800) 421-1404

PIONEER ELECTRONICS OF CANADA, INC.

300 Allstate Parkway, Markham, Ontario L3R 0P2, Canada TEL: 1-877-283-5901, 905-479-4411

PIONEER EUROPE NV

Haven 1087, Keetberglaan 1, B-9120 Melsele, Belgium TEL: 03/570.05.11

PIONEER ELECTRONICS ASIACENTRE PTE. LTD.

253 Alexandra Road, #04-01, Singapore 159936 TEL: 65-6472-7555

PIONEER ELECTRONICS AUSTRALIA PTY. LTD.

178-184 Boundary Road, Braeside, Victoria 3195, Australia, TEL: (03) 9586-6300

PIONEER ELECTRONICS DE MEXICO S.A. DE C.V.

Blvd.Manuel Avila Camacho 138 10 piso Col.Lomas de Chapultepec, Mexico,D.F. 11000 TEL: 55-9178-4270

K002_B_En

Published by Pioneer Corporation.
Copyright © 2007 Pioneer Corporation.
All rights reserved.

Printed on recycled paper.

Free Manuals Download Website

<http://myh66.com>

<http://usermanuals.us>

<http://www.somanuals.com>

<http://www.4manuals.cc>

<http://www.manual-lib.com>

<http://www.404manual.com>

<http://www.luxmanual.com>

<http://aubethermostatmanual.com>

Golf course search by state

<http://golfingnear.com>

Email search by domain

<http://emailbydomain.com>

Auto manuals search

<http://auto.somanuals.com>

TV manuals search

<http://tv.somanuals.com>