

Pioneer

seeing and hearing like never before

OPERATING INSTRUCTIONS

PRO-141FD

PRO-101FD

KURO
FLAT PANEL DISPLAY

ELITE

FLAT PANEL DISPLAY

IMPORTANT



The lightning flash with arrowhead symbol, within an equilateral triangle, is intended to alert the user to the presence of uninsulated "dangerous voltage" within the product's enclosure that may be of sufficient magnitude to constitute a risk of electric shock to persons.

CAUTION

RISK OF ELECTRIC SHOCK
DO NOT OPEN

CAUTION:

TO PREVENT THE RISK OF ELECTRIC SHOCK, DO NOT REMOVE COVER (OR BACK). NO USER-SERVICEABLE PARTS INSIDE. REFER SERVICING TO QUALIFIED SERVICE PERSONNEL.



The exclamation point within an equilateral triangle is intended to alert the user to the presence of important operating and maintenance (servicing) instructions in the literature accompanying the appliance.

D3-4-2-1-1_En-A

IMPORTANT SAFETY INSTRUCTIONS

- 1) Read these instructions.
 - 2) Keep these instructions.
 - 3) Heed all warnings.
 - 4) Follow all instructions.
 - 5) Do not use this apparatus near water.
 - 6) Clean only with dry cloth.
 - 7) Do not block any ventilation openings. Install in accordance with the manufacturer's instructions.
 - 8) Do not install near any heat sources such as radiators, heat registers, stoves, or other apparatus (including amplifiers) that produce heat.
 - 9) Do not defeat the safety purpose of the polarized or grounding-type plug. A polarized plug has two blades with one wider than the other. A grounding type plug has two blades and a third grounding prong. The wide blade or the third prong are provided for your safety. If the provided plug does not fit into your outlet, consult an electrician for replacement of the obsolete outlet.
 - 10) Protect the power cord from being walked on or pinched particularly at plugs, convenience receptacles, and the point where they exit from the apparatus.
 - 11) Only use attachments/accessories specified by the manufacturer.
 - 12) Use only with the cart, stand, tripod, bracket, or table specified by the manufacturer, or sold with the apparatus. When a cart is used, use caution when moving the cart/apparatus combination to avoid injury from tip-over.
- 
- 13) Unplug this apparatus during lightning storms or when unused for long periods of time.
 - 14) Refer all servicing to qualified service personnel. Servicing is required when the apparatus has been damaged in any way, such as power-supply cord or plug is damaged, liquid has been spilled or objects have fallen into the apparatus, the apparatus has been exposed to rain or moisture, does not operate normally, or has been dropped.

P1-4-2-2_En

IMPORTANT NOTICE –

THE SERIAL NUMBER FOR THIS EQUIPMENT IS LOCATED IN THE REAR. PLEASE WRITE THIS SERIAL NUMBER ON YOUR ENCLOSED WARRANTY CARD AND KEEP IN A SECURE AREA. THIS IS FOR YOUR SECURITY.

D1-4-2-6-1_En

WARNING: Handling the cord on this product or cords associated with accessories sold with the product will expose you to chemicals listed on proposition 65 known to the State of California and other governmental entities to cause cancer and birth defect or other reproductive harm.

Wash hands after handling

D36-P4-A_En

TABLE OF CONTENTS

Congratulations on purchasing a Pioneer Elite KURO monitor.

At Pioneer, everything we do is designed to alter perceptions, to shatter expectations, to change the way people feel about sight and sound.

This exclusive series of Elite KURO monitors does just that. The result of a special limited run created for the entertainment purist, this monitor was designed to excel under the most demanding situations, to be fully customizable to the most particular tastes and to transcend the ordinary.

We are proud to incorporate this philosophy of exceptional quality, state-of-the-art design and meticulous engineering to make the Elite KURO monitor one of the finest in the world and immerse you into one of the best entertainment experiences possible.

Please spend some time reading through this owner's guide and manual to learn about the many features and benefits that make this Elite KURO monitor unique. We hope you enjoy the experience of owning an Elite KURO and invite you to enter a new world of seeing and hearing like never before.

TABLE OF CONTENTS

1 Introduction to the Flat Panel Displays.....	6
1.1 Flat Panel Display Shipment Checklist.....	6
1.2 Control Options: Get to Know Your Flat Panel Display.....	7
1.2.1 Control Buttons and More on the Flat Panel Display.....	7
1.2.2 Operating the Remote Control.....	8
1.2.3 Buttons on the Remote Control.....	10
2 Install Your Flat Panel Display.....	12
2.1 Use the Optional Table Top Stand (Stand) or Equivalent Items.....	12
2.2 Use the Optional Brackets or Equivalent Items.....	13
2.2.1 Check the Location for Suitability.....	14
2.2.2 Lift and/or Move Your Panel (the How To's).....	14
2.2.3 Mount the Flat Panel Display.....	15
2.3 Connect to Other Devices (DVR, Receiver, BDR, etc.).....	17
2.4 Connect the Power Cord to the Panel.....	19
2.5 Route then Bundle the Power Cord and Cables.....	19
3 Basic Operations.....	21
3.1 Turn the Flat Panel Display ON / OFF.....	21
3.2 Program Your Flat Panel Display.....	22
3.2.1 Choose an Input Source.....	22
3.2.2 Explore the Home Menu.....	22
3.2.3 Use the Simplified User Menu.....	23
3.2.4 Assign a Language.....	24
4 Basic Picture Adjustment.....	25
4.1 Adjust the Picture Quality.....	25
4.1.1 Adjust the Picture for Your Room Lighting.....	25
4.1.2 General Picture (Video) Adjustment.....	25
4.1.3 Compare Images When Adjusting the Picture.....	27
4.2 Smart Starts for New Owners.....	28
4.2.1 Extend Your Panel Life.....	28
4.2.2 Adjust the Power Indicator Brightness.....	28
4.2.3 Set Input Priority.....	28
4.2.4 Turn On the Image Orbiter.....	29
4.2.5 Trigger the Screen-Saving Video Pattern Periodically.....	29
4.2.6 Activate Energy Save to Reduce Power Usage.....	29
4.2.7 Turn On the Sleep Timer.....	30

5	Additional Picture Adjustment Options.....	31
5.1	Choose an AV Option (Video, Game, etc.).....	31
5.1.1	AV Source through the Remote Control.....	31
5.1.2	Choose an AV Source through the Home Menu.....	32
5.1.3	Choose a PC Source.....	32
5.1.4	Set the Panel to Recognize a Game Console.....	32
5.2	Adjust Specific Picture Elements.....	33
5.2.1	Choose a Screen Size (Automatically or Manually).....	33
5.2.2	Correct the Picture for an AV or PC Source.....	35
5.3	Assign Advanced Picture Functions.....	36
5.3.1	Adjust for Screen Masking (black bars on sides).....	36
5.3.2	Select a Color Temperature Level.....	37
5.3.3	Adjust the Image Gradation Characteristics (Gamma).....	38
5.3.4	Select a PureCinema Level for High Quality Image.....	38
5.3.5	Select an Intelligent Mode Option.....	39
5.3.6	Select the Picture Detail Options.....	40
5.3.7	Use CTI and Color Space.....	40
5.3.8	Use the Color Management.....	41
5.3.9	Reduce Noise from the Image.....	41
5.3.10	Adjust Color Signals.....	42
5.4	View in Multi-Screen.....	43
5.4.1	Split / Swap / Shift the Screen.....	43
5.4.2	Turn the Small Screen On/Off.....	44
5.5	Freeze the Picture.....	44
5.6	Manage the Power.....	45
6	Use Other Equipment With Your Flat Panel Display.....	46
6.1	Program the Remote Control to Operate Other Equipment.....	46
6.1.1	Use the Learning Function.....	46
6.1.2	Assign a Manufacturing Code to the Remote Control.....	47
6.1.3	Issue a Library Search for a Manufacturer Code.....	47
6.1.4	Clear Added Manufacturer Codes from the Remote Control.....	48
6.1.5	Control a Pioneer Receiver.....	48
6.1.6	Control a Cable (CBL) or Satellite (SAT) System.....	49
6.1.7	Control a Video Cassette Recorder (VCR).....	50
6.1.8	Control a DVD Player/DVR Recorder/BD Player.....	51
6.2	Apply Settings for Other Equipment.....	52
6.2.1	Apply Settings for an AV System.....	52
6.2.2	Apply Settings for a PC.....	53
6.3	Use HDMI Inputs.....	54
6.3.1	Enter an HDMI Input Name.....	54
6.3.2	Specify the HDMI Input Type.....	55
6.3.3	Specify a Digital HDMI Signal Type.....	55
6.4	Control Equipment with the Panel's Remote Through HDMI.....	56
6.4.1	Control an AV System.....	58
6.4.2	Control a Recorder.....	59
6.4.3	Control a Player.....	59
6.4.4	Add an AV Amp or a BD Player.....	60
6.5	Specific KURO LINK Commands.....	61
6.5.1	Play Source Sound Using an HDMI Command.....	61
6.5.2	Turn OFF the Power With an HDMI Command.....	61
6.5.3	Turn ON the Power With an HDMI Command.....	61
6.5.4	Test the Power Control (On/Off).....	62
6.6	Connect a Game Console or Camcorder.....	62
6.7	Use the IR REPEATER OUT.....	62
6.8	Connect to a Network.....	63
6.8.1	IP Control Setting.....	64
6.8.2	Use the Web Control System.....	65

TABLE OF CONTENTS

6.9 Assign a Serial Number	69
6.9.1 Assign an ID Number	69
6.9.2 Assign a Baud Rate.....	70
6.10 Select the Integrator Mode	70
6.10.1 Explore the Integrator Mode Menus	71
7 Helpful Information	75
7.1 Frequently Asked Questions (FAQs)	75
7.2 Cleaning Methods.....	76
7.3 Troubleshooting & Service Information.....	77
8 Cautions and Warnings.....	80
8.1 Installation Details	80
8.2 Physical Location & Temperature Considerations	80
8.3 Usage Guidelines	80
8.4 Signal Interference or Noise	81
8.5 Phosphor Properties.....	81
8.6 Image Information Including Retention & After-Image Lag	81
8.7 Prevent Burning	82
8.8 Safety Precautions.....	83
8.9 Legal Notices.....	83
8.9.1 Safety.....	83
8.9.2 Radio Interference.....	84
9 Appendix	85
9.1 Manufacturer Codes to Program into the Remote Control.....	85
9.1.1 Cable.....	85
9.1.2 Satellite.....	86
9.1.3 VCR.....	88
9.1.4 BDP (Blu-ray).....	91
9.1.5 DVD-R.....	92
9.1.6 DVD.....	93
9.1.7 LD.....	95
9.2 Video/PC Signals (HDMI/DVI/Component/min D-Sub/Composite)	96
9.2.1 INPUT 1 (Video Signals).....	96
9.2.2 INPUT 2 (Component)/INPUT 3 (D-Sub) - Video Signals (Analog).....	96
9.2.3 INPUT 4 (DVI)/INPUT 5 through 8 (HDMI) - Video Signals (Digital).....	97
9.2.4 INPUT 3 (D-Sub) - PC Signals (Analog).....	98
9.2.5 INPUT 4 (DVI)/INPUT 5 through 8 (HDMI) - PC Signals (Digital).....	99
9.3 Specifications.....	101
9.4 Trademarks.....	101
9.5 Glossary	102
9.6 Index.....	104

1 Introduction to the Flat Panel Displays





The Pioneer Flat Panel Display models include the 60-inch **PRO-141FD** and the 50-inch **PRO-101FD** (screen sizes measured diagonally). Below is a list of all accessories shipped with your panel. If an item is missing, please contact your dealer or our Service organization immediately. Service contact information is listed on the back of this manual.

1.1 Flat Panel Display Shipment Checklist

In addition to the flat panel display, there are several accessories included to make installation quick and easy. Please check contents before discarding or allowing your installer to discard any packing material.

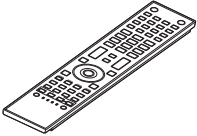
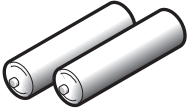
Identify the accessories from the appropriate list below.

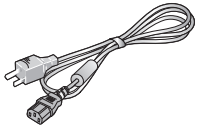
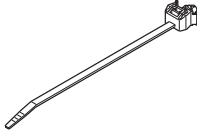
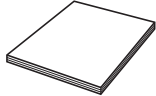
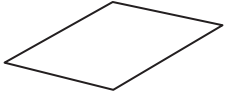
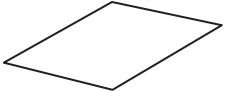
You will need a Philips screwdriver if removing or attaching the stand.

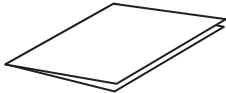
Shipped with both models		
<input type="checkbox"/> Remote Control	<input type="checkbox"/> Batteries for Remote (2)	<input type="checkbox"/> Cleaning Cloth
		
<input type="checkbox"/> Power Cord (2 m/6.6 feet)	<input type="checkbox"/> Cable Clamps (4)	<input type="checkbox"/> Operating Instructions
		
<input type="checkbox"/> Certificate of Authenticity	<input type="checkbox"/> Certificate Glossary	<input type="checkbox"/> Warranty Card
		
<input type="checkbox"/> Specifications Sheet		
		

1.2 Control Options: Get to Know Your Flat Panel Display

You can operate your flat panel display from the panel buttons or with the remote control. The following sections provide button locations/operations for the panel and the remote control.

1.2.1 Control Buttons and More on the Flat Panel Display

Your flat panel display has buttons, indicators, and sensors on the lower front bezel with more buttons on the rear panel. Refer to the drawings below for specific locations and functions. Or, to identify back ports and terminals only, check the terminal position sheet located near the panel's terminal compartment.

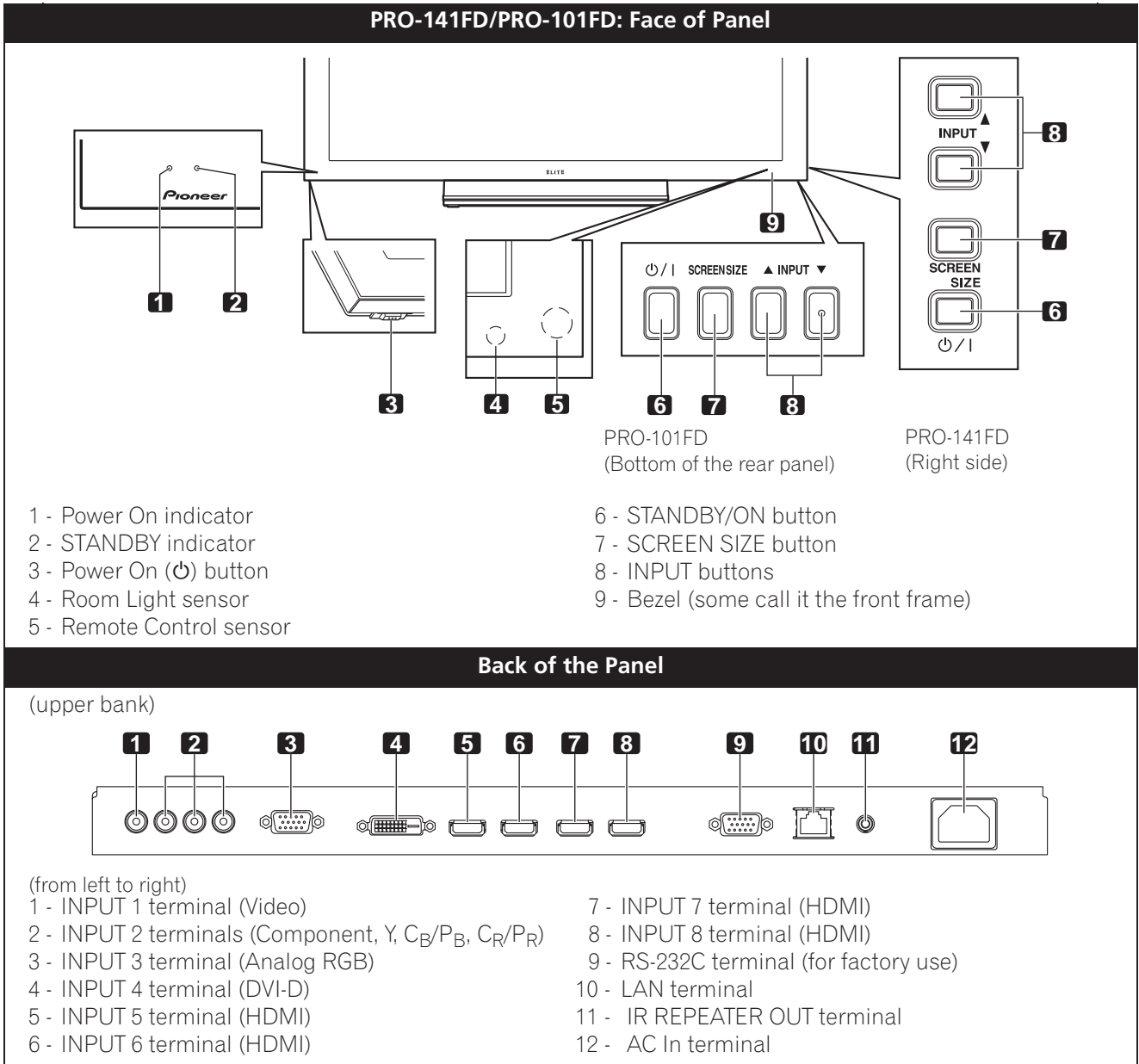

Terminals on the rear panel are common to both models.

1.2.2 Operating the Remote Control

The remote control for the flat panel display is a powerful tool. This section provides a brief introduction to your remote control while later sections explore more advanced operations.

Insert the Batteries into the Remote Control

To open, push and slide the battery cover in the direction of the arrows. Load the supplied two AA size batteries by the negative polarity (–) ends first.

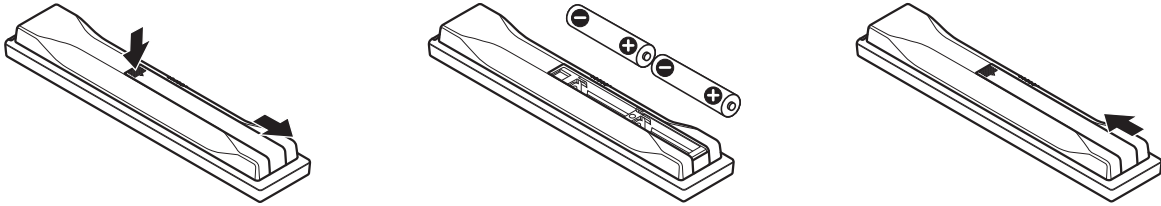

The batteries supplied with this product may have a shorter life expectancy due to storage conditions. If the remote control seems to be failing or is weak, replace the provided batteries with new alkaline batteries. Never mix old and new batteries. Mixing old and new batteries can shorten the life of new batteries or cause chemical leaks in old batteries. Also, mixing different types or brands of batteries can cause issues as batteries brands have slightly different characteristics.

Note: If the flat panel display's remote control is not needed for an extended length of time, remove the batteries.

When disposing of used batteries, please comply with governmental regulations or environmental public institution's rules that apply in your country/area.

Remote Control Issues

There are a small number of issues that can affect your remote control but the most common is weak batteries. Weak batteries in the remote control can cause communication to fail or only operate sporadically. In this situation, try moving closer to the panel and attempt to control the panel with the remote. If the panel responds, change the batteries. If moving closer has no effect on the panel, check the surroundings for objects that might be blocking the signal. Also consider other equipment with remote controls that are in the area around the panel. Objects and other IR signals can disrupt the remote. For more help with your remote control, refer to "7.1 Frequently Asked Questions (FAQs)".

Operating Range for the Remote Control

To control the flat panel display, point the remote towards the sensor on the panel's bottom right corner. For easy operation, keep the distance between the remote control and the sensor less than 7 m (23 feet) and at an angle of less than 30 degrees.

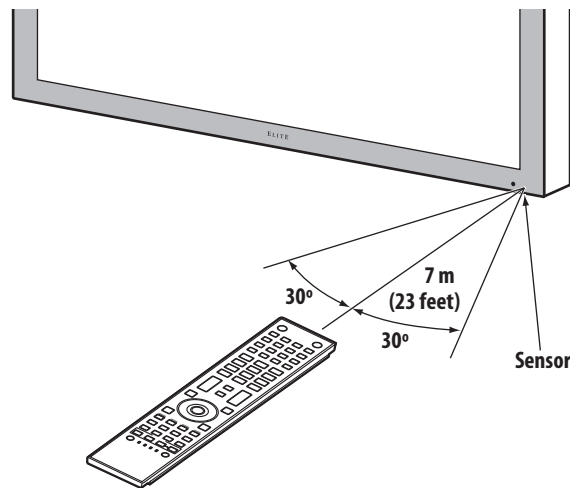

The remote control may not work properly if the sensor is in direct sunlight or very bright lighting. If your viewing room is naturally bright, change the position of the panel or physically use the remote control closer to the panel's sensor.

Note: If the remote control is left sitting in direct sunlight or under a very strong light, the case could warp or deform.

1.2.3 Buttons on the Remote Control

Except for a few options, commands available through the buttons on the flat panel display are duplicated on the remote control. The remote control can be programmed to control other equipment such as a DVD Player, Surround Sound system, etc. A later section entitled "6. Use Other Equipment With Your Flat Panel Display" explains how to use the remote to control other equipment.

This section identifies and describes the buttons on the remote control.

Remote: Left side buttons (top to bottom, left to right)

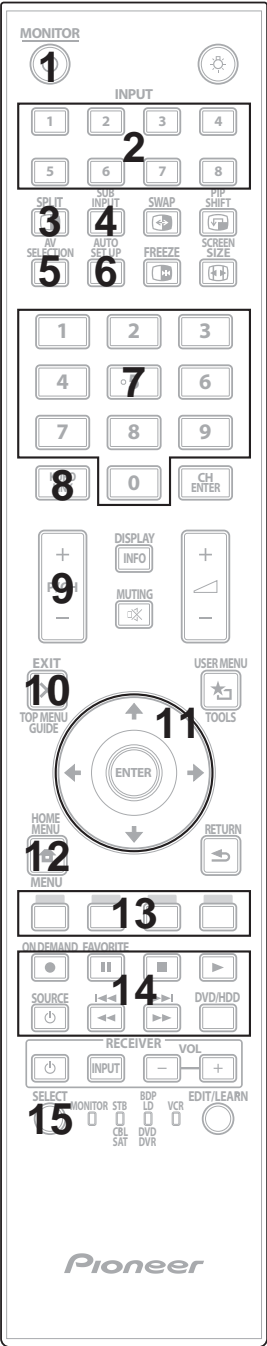
<p>MONITOR : 1 Turn On or place panel in Standby</p> <p>INPUT: 2 Select a source (INPUT 1 thru INPUT 8)</p> <p>SPLIT: 3 Cycle view thru single-screen, 2-screen, picture-in-picture</p> <p>SUB INPUT: 4 Switch inputs for sub screens when viewing in multi-screen</p> <p>AV SELECTION: 5 Select audio/video settings AV Source: OPTIMUM, STANDARD, DYNAMIC, MOVIE, PURE, SPORT, GAME, USER PC Source: STANDARD, USER</p> <p>AUTO SET UP: 6 Optimize the PC screen</p> <p>Number buttons 0 thru 9: 7 Enter a number when applying IP Control Setting</p> <p>KURO LINK: 8 Select the KURO LINK functions</p> <p>P/CH: 9 Use the button for control of connected equipment</p> <p>EXIT: 10 Exit the menu to return to the normal screen</p> <p>Arrow buttons: 11 Navigate the menu screens</p> <p>HOME MENU/MENU: 12 Display the HOME MENU</p> <p>Color buttons (Red, Green, Blue, Yellow): 13 Control a BD player for KURO LINK functions only</p> <p>Player/Recorder Control: 14 Use buttons for control of connected equipment</p> <p>SELECT: 15 Select for MONITOR, STB, CBL/SAT, BDP/LD, DVD/DVR, VCR</p>	
--	--

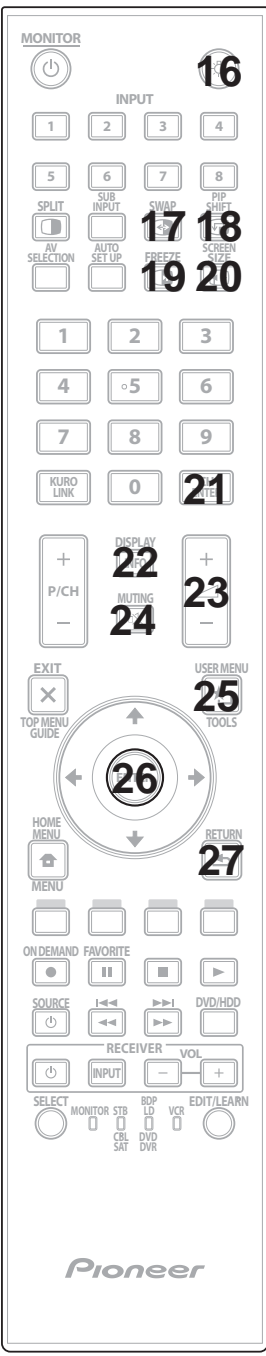
Remote: Right side buttons (top to bottom, left to right)

The diagram shows a Pioneer remote control with 27 numbered callouts pointing to the following buttons:

- 16: Power button (circle with a dot)
- 17: SPLIT button
- 18: PIP button
- 19: AV SELECTION button
- 20: SCREEN SIZE button
- 21: KURO LINK button
- 22: DISPLAY button (with + and - signs)
- 23: MUTING button (with + and - signs)
- 24: EXIT button (with X)
- 25: USER MENU TOOLS button
- 26: ENTER button (center of the directional pad)
- 27: RETURN button

16 : Lights all buttons (except arrow buttons and the **ENTER** button)
Lights turn off if no operations are performed within five seconds. Use this button for remote control use in dimly lit locations.

17 **SWAP:**
 Switch between the two screens when viewing as 2-screen or picture-in-picture

18 **PIP SHIFT:**
 Move the location of the small screen when viewing as picture-in-picture

19 **FREEZE:**
 Freeze a frame from a moving image then press again to cancel the freeze function

20 **SCREEN SIZE:**
 Select the screen size

21 **CH ENTER:**
 Use the button for control of connected equipment

22 **DISPLAY/INFO:**
 Display the current monitor status

23  +/-:
 Invalid

24 **MUTING:**
 Invalid

25 **USER MENU/TOOLS:**
 Display the User Menu

26 **ENTER:**
 Execute a command

27 **RETURN:**
 Return to the previous menu screen

Note: If you set the preset code to MONITOR, buttons 9, 13, 14 and 21 do not operate.

2 Install Your Flat Panel Display

There are several installation options for your flat panel display. This chapter walks you through how to choose an installation site, the best mounting methods, and how to install your panel.

2.1 Use the Optional Table Top Stand (Stand) or Equivalent Items

- Ask your dealer to perform the installation
- Use the supplied bolts
- For details, refer to the instruction manual that came with the optional stand (or equivalent items)

Rear view (PRO-141FD)

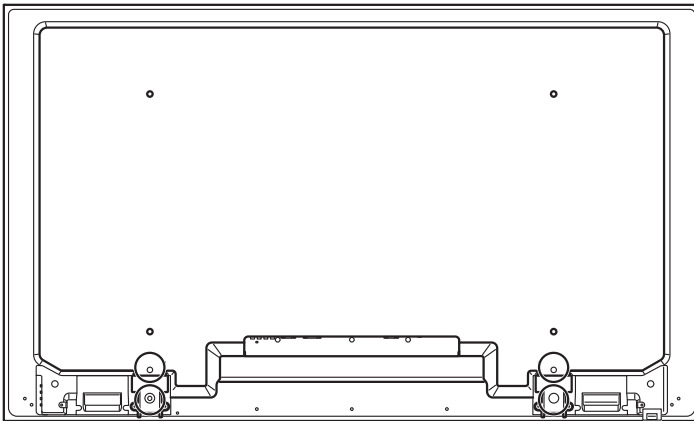

Rear view (PRO-101FD)

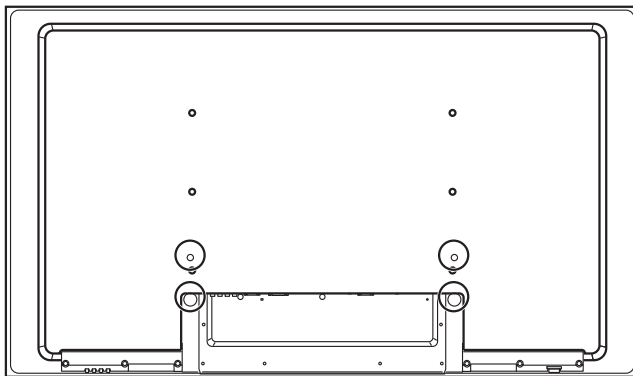

Use the supplied bolts when attaching the stand's supports at the holes indicated by a circle.

2.2 Use the Optional Brackets or Equivalent Items

- Consult your dealer
- Use the following mounting holes for installation

Rear view (PRO-141FD)

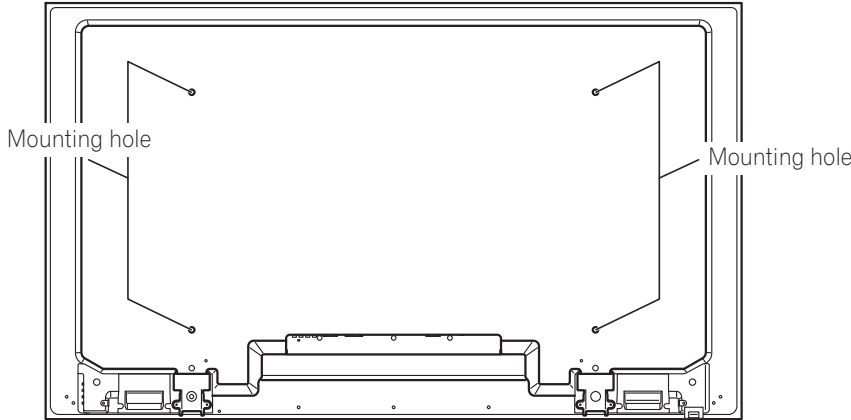

Side view

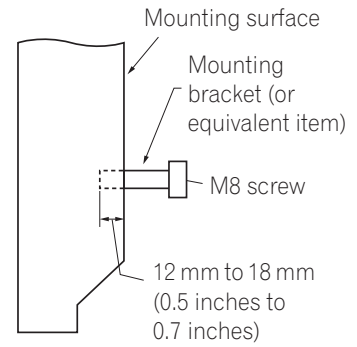

Rear view (PRO-101FD)

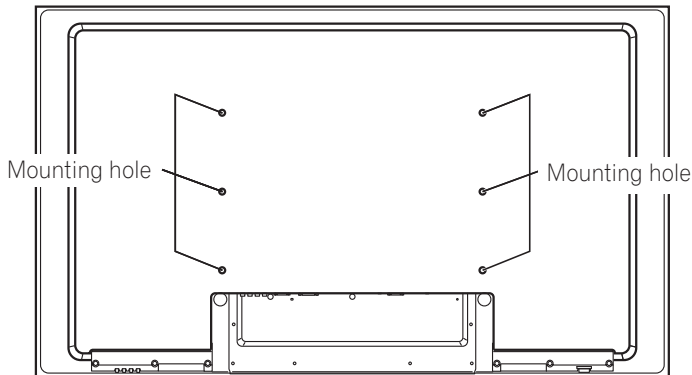

Note: Some installation options require a different type of bolt. Check with your installer or dealer to purchase the appropriate bolt(s).

2.2.1 Check the Location for Suitability

When choosing the location for your panel, there are several factors to keep in mind. The installation site should be out of direct sunlight and have sufficient ventilation around the flat panel display to allow cooling. The diagram below is an example of a stand-mounted panel with proper ventilation.

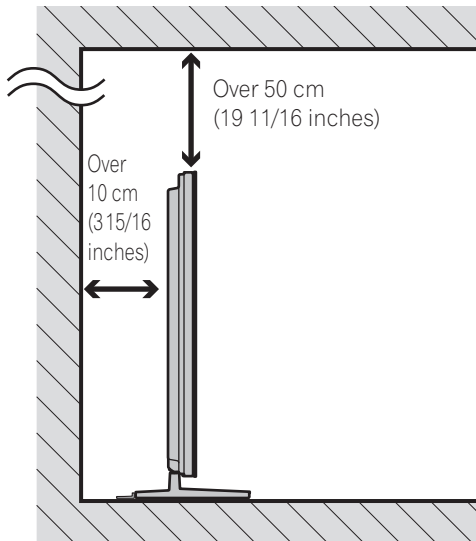

The distance behind and above the panel changes depending on your choice of mount. Consult with your dealer or professional installer for proper ventilation.

Use the checklist below to judge possible installation sites.

- | | |
|---|--|
| <input type="checkbox"/> Sufficient ventilation | <input type="checkbox"/> No danger of power overloads |
| <input type="checkbox"/> Safe from excessive vibrations | <input type="checkbox"/> Separate from other IR equipment |
| <input type="checkbox"/> Away from air conditioners | <input type="checkbox"/> Protected from hits or shocks |
| <input type="checkbox"/> Free of moisture or dampness | <input type="checkbox"/> Distance from heat sources |
| <input type="checkbox"/> No danger of splashing water | <input type="checkbox"/> Out of direct sunlight |
| <input type="checkbox"/> Route cords and cables safely | <input type="checkbox"/> Away from strong lighting sources |

For specific cautions and safety information, refer to “8.2 Physical Location & Temperature Considerations” and “8.8 Safety Precautions.”

2.2.2 Lift and/or Move Your Panel (the How To's)

This flat panel display is built for endurance but because of the technology, the panel must be handled with care. Use the handles attached to the rear of the flat panel display to lift the unit. To avoid flexing or twisting the unit, you need at least two people to lift and move the panel. Do not move the flat panel display by holding only a single handle or by dragging the panel by its handles.

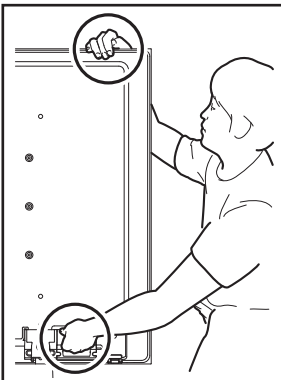

(PRO-141FD)

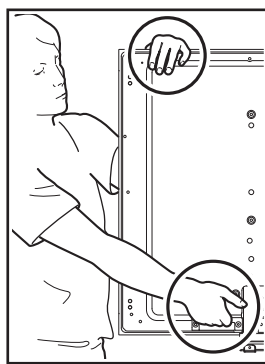

(PRO-101FD)

Note: Do not use the handles to hang the flat panel display or as anchors to prevent the panel from slipping or tipping after it is mounted.

2.2.3 Mount the Flat Panel Display

Because your flat panel display is slim but heavy, have at least two people mount and/or position the panel. The following sections provide instructions for the different mounting and anchoring options.

Anchor the Panel When Using a Stand

When using a stand, stabilize the panel to keep it from tipping over. Please use the metal fittings and screws supplied with the optional stand to anchor the panel to a wall or other solid support structure.

Another option is to purchase hooks, cords, and fittings through your installer or from your local hardware store. The hardware size and strength depends on the composition and thickness of the anchoring surface.

Recommended hook: Nominal diameter 8 mm (3/8 inch), length 12 mm to 18 mm (0.5 inches to 0.7 inches)

To anchor the panel when using the optional stand, follow the steps below.

- 1) Attach the hooks to the mounting holes on the back of the panel.
- 2) Sink the fittings into the wall or support structure.
- 3) Run cords between the hooks and the fittings.
- 4) Tighten the cords until the panel is anchored but not pulled off balance.

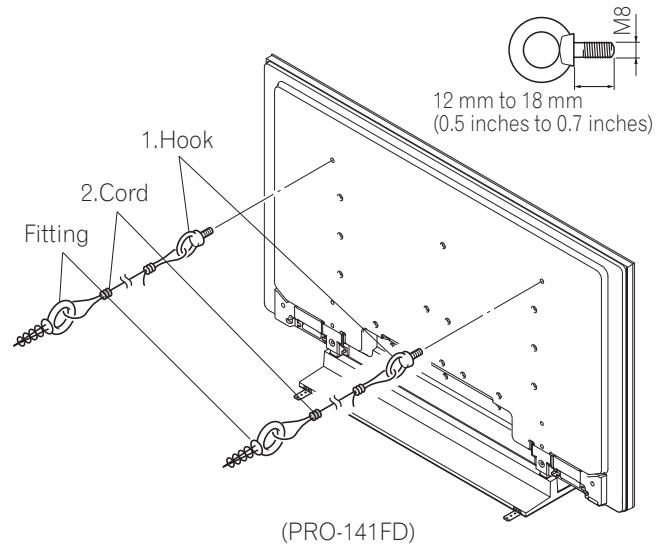

To stabilize the flat panel display on a table or platform, use the metal fittings and screws supplied with the optional stand as well as commercially available wood screws. The wood screws are to anchor the metal fittings when mounting on a wooden surface. These screws should have a nominal diameter of 4 mm (5/32 inch) and are at least 20 mm (13/16 inch) long.

Notes: Avoid moving the table after the panel is attached.

Do not use bare wires for the cord. If any part of the wire is introduced into the ventilation port on the back of the display panel, fire or electrical shock could result.

Follow the steps below to secure your flat panel display.

- 1) Mark locations for metal fittings and screws on the back edge of the table using the panel stand to determine placement.

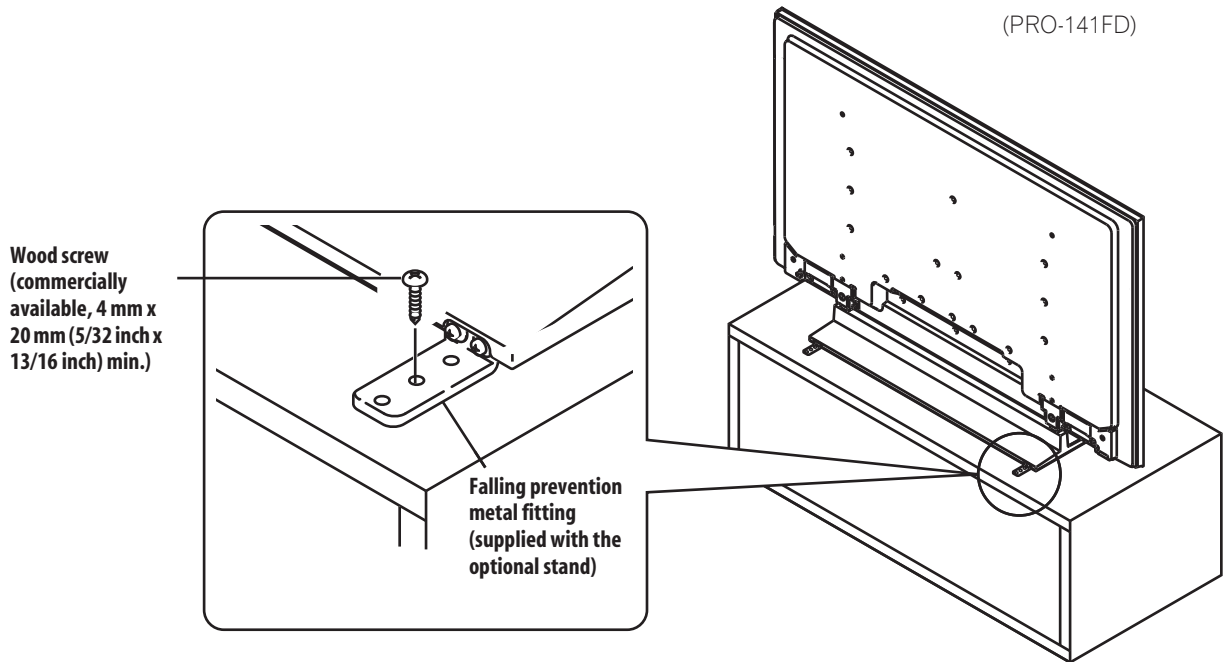

- 2) Drill holes in the table or platform edge at the marked locations.
- 3) Lift panel into place with the assistance with at least one other person.
- 4) Use wood screws (not included) to secure the metal fittings to the table.

2.3 Connect to Other Devices (DVR, Receiver, BDR, etc.)

The type of equipment attached to your flat panel display determines which panel ports are used. The following sections explain how to connect equipment such as a DVD player, video recorder, etc. to the panel. If your equipment is not listed, please refer to the operating instructions that came with the device(s) for connection assistance.

Connect a DVD player:

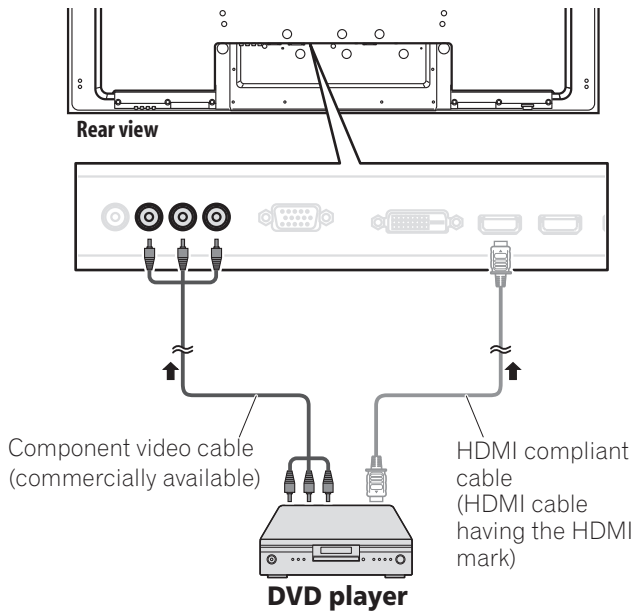

Use INPUT 2 terminals when connecting a DVD player or other audio/visual equipment. If your DVD player has an HDMI terminal, use this connection instead of making video connections. For details, refer to the operation manual that came with the DVD player.

Connect DVI equipment:

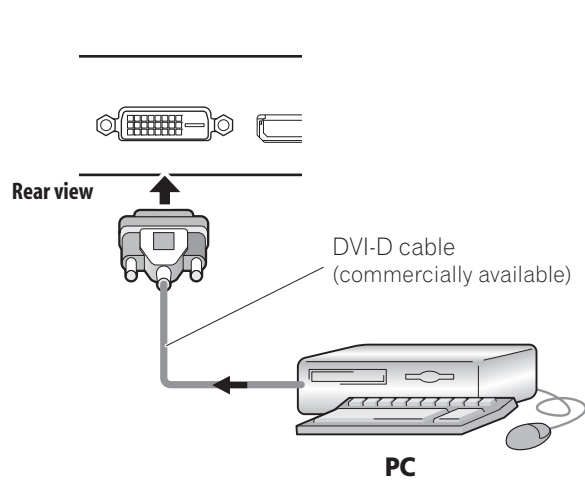

Use a DVI-D 24-pin (digital only) cable to connect a PC equipped with a DVI output terminal (digital RGB signal). After completing connections, follow the on-screen setup directions (page 52). INPUT 4 supports Microsoft "Plug & Play" (VESA DDC 2B) components. See "9.2 Video/PC Signals (HDMI/DVI/Component/min D-Sub/Composite)" for information about signals and display formats supported by INPUT 4.

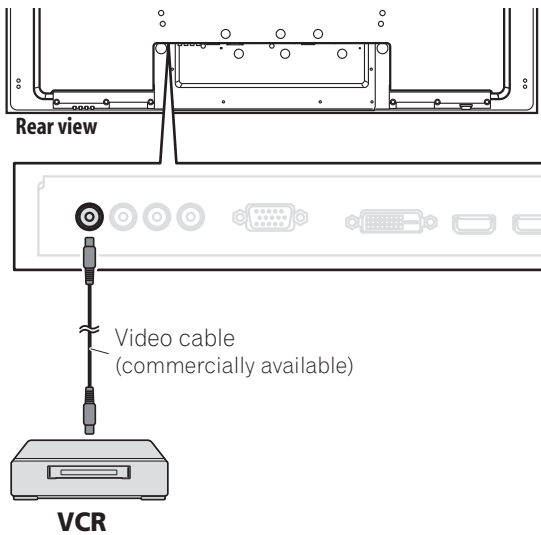
Connect a VCR:

Use INPUT 1 terminal when connecting a VCR or other recording equipment. For details, refer to the operation manual that came with the device.

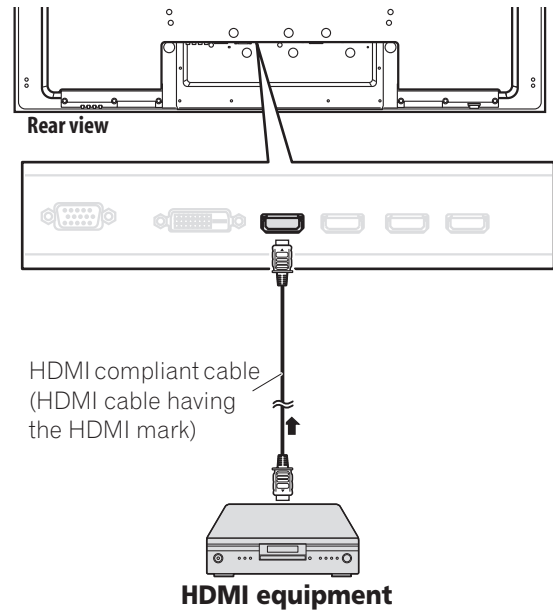
Connect HDMI equipment:

INPUT 5 through INPUT 8 are HDMI terminals. For details, refer to "6.3 Use HDMI Inputs."

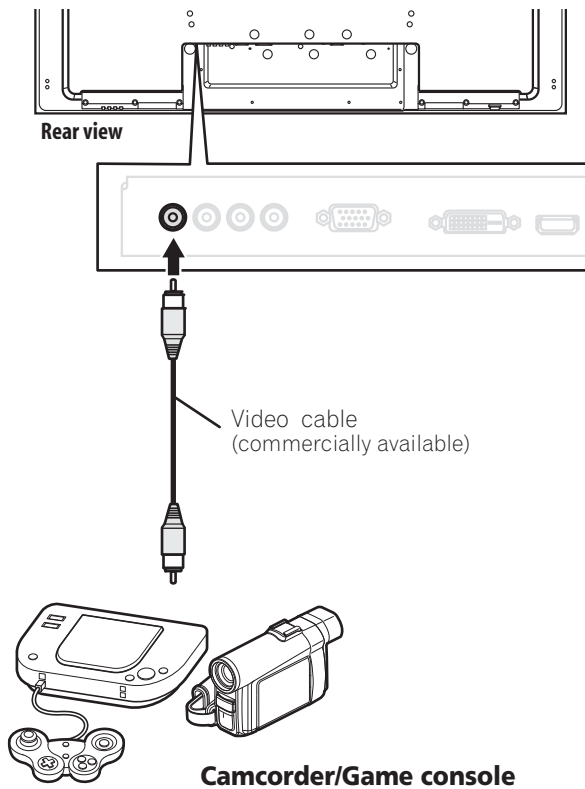
Connect a game console or camcorder:

Use INPUT 1 terminal when connecting a game console, camcorder, or other audio/visual equipment. For details, refer to the operation manual that came with the game console or camcorder.

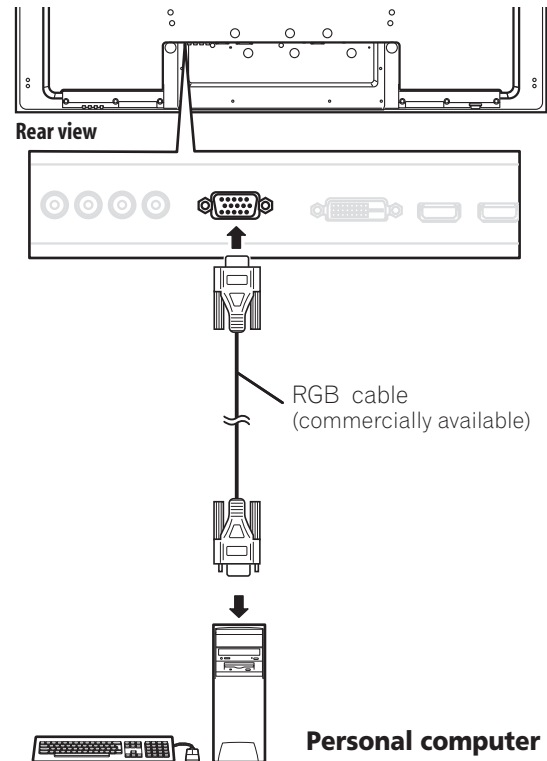
Connect a PC:

Use INPUT 3 terminal (Analog RGB) when connecting a computer (PC). For details, refer to the operation manual that came with the PC.

2.4 Connect the Power Cord to the Panel

The final connection is the power cord. Always connect the panel's power cord to a three-pronged outlet, verifying that the cord is properly grounded. The cord includes a noise filter. Using any other cord may fail to conform to mandatory FCC standards.

As long as the flat panel display is plugged in to an outlet, some power is drawn through the panel. When the flat panel display is not going to be used for a long period, unplug the panel from the power outlet. Unplugging the panel extends the life of the plasma as well as saves energy.

Plug the cord in to the panel but do NOT plug it in to a power outlet yet.

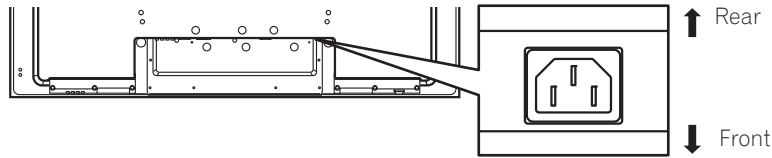

2.5 Route then Bundle the Power Cord and Cables

Once the flat panel display is mounted, place additional equipment in the final position(s). Lay out the power cord, panel cables, and any other device cables in a logical pattern that works for the location. Please consider the following points when routing cables:

- Access to a 3-prong (grounded) power outlet
- Space for the noise filter between the panel and outlet
- Placement of cables under carpets or across walking paths

A reusable cable clamp is designed to lock the bundled cables in place. Your flat panel display has a total of three holes (60 inches: two holes) to attach cable clamps to the back of the panel. Use the cable clamps as necessary.

PRO-141FD

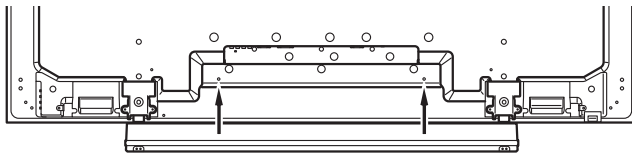

PRO-101FD

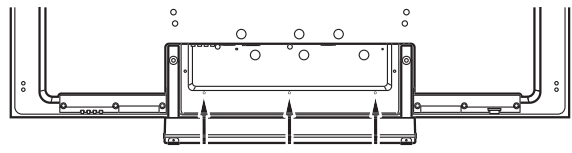

Follow the steps below to attach a cable clamp.

- 1) Thread the clamp band through the holder and bundle the cable(s) in the cable clamp.
- 2) Push and hold the levers then insert the hook into an appropriate hole on the rear of the flat panel display.
- 3) Pull up the clamp band to lock.

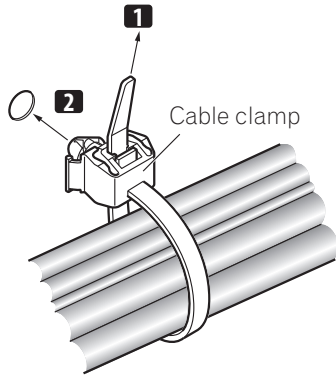

- 4) Confirm that the cable clamp is seated firmly in the panel.

Note: Avoid pinching or creating pressure points when routing or bundling cables.

To remove the clamp band, pull and hold the latch to release.

To remove the cable clamp, push and hold the levers then pull it out from the hole.

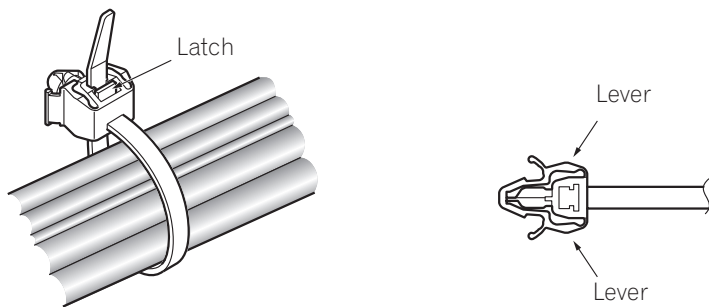

Note: The longer a clamp is in place, the better chance of deterioration. An older clamp is more easily damaged while being removed and may not be reusable.

3 Basic Operations

This chapter explores day-to-day operations such as powering on your flat panel display, using the Home Menu, User Menu, and adjusting the display for the viewing area/room. The final section in this chapter provides hints and suggestions for those new to flat panel display features.

3.1 Turn the Flat Panel Display ON / OFF

Your flat panel display has three activity levels: Power On, Standby, and Power Off. Standby saves energy but allows the remote control to turn on the panel. The following instructions use the remote control. To operate the flat panel display through the side panel buttons, refer to "1.2.1 Control Buttons and More on the Flat Panel Display" for button locations.

Turn ON the Flat Panel Display

To turn on the panel, follow the steps below.

- 1) Plug the flat panel display's power cord in to a properly grounded outlet.
- 2) Press any of the following buttons to turn the flat panel display On.
 - Power On button (⏻) on the panel's back in lower-left section (see page 7)
 - **STANDBY/ON** button on the side (PRO-141FD) or rear (PRO-101FD) of the panel (see page 7)
 - Remote control's **MONITOR** (⏻) button located in the upper left corner (see page 10)
Images appear on the panel screen.
- 3) Confirm that the Power On indicator lights blue.

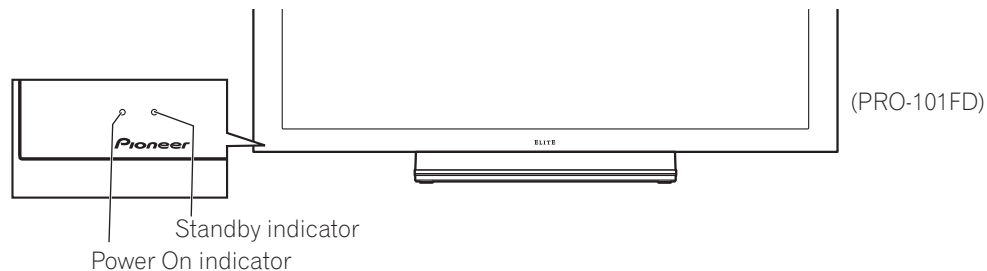

*Note: While in Standby, pressing the remote control's **MONITOR** (⏻) button causes the flat panel display to turn On.*

Turn OFF the Flat Panel Display

Turning off the flat panel display can mean entering Standby so features are still functional or it can mean cutting power to the panel. Unless the flat panel display is to sit idle for long periods, leave the panel in Standby.

Note: While in Standby or when powered off, the display continues to draw some power as long as the panel is plugged in to an outlet.

Follow the steps below to place the panel in Standby.

- 1) Press the remote control's **MONITOR** (⏻) button.
- 2) Confirm that the Standby indicator lights red.

The table to the right provides samples of how the indicators light. Monitor the indicators on the front of the panel to check the power status.

Note: Select from Auto, High, Mid and Low. Selecting Auto toggles the brightness of the indicator between High, Mid and Low to match the brightness level of the viewing area. Refer to "4.2.2 Adjust the Power Indicator Brightness."

Power Indicator	Standby Indicator	Flat Panel Display Status
●	●	Panel's power cord is disconnected or the power cord is connected but the flat panel display's Power On button (⏻) is off
☀	●	Power is on but waiting for activation
●	☀	Panel is in Standby

3.2 Program Your Flat Panel Display

To take advantage of some built-in features, choose the input source, select a language and set the picture quality. The sections below include how to use the Home Menu and simplified User Menu for each programming option.

3.2.1 Choose an Input Source

To choose an input source, note that the external equipment is properly connected to the input terminals on the back of the flat panel display. Follow the directions below to choose an input source.

Press **INPUT** (buttons **1** through **8**) on the remote control.

The corresponding terminal/port number is selected as an input source.

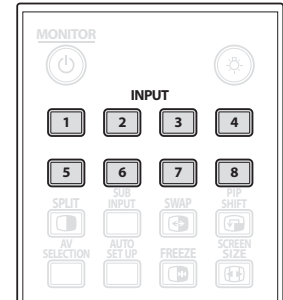

3.2.2 Explore the Home Menu

The Home Menu is the main menu for the flat panel display. Most commands and settings are programmed through this menu. The following section describes a typical method for working with the panel's menus. For actual procedures, see the appropriate page(s) that describe individual functions.

- 1) Press **HOME MENU** on the remote to access the main menu.
- 2) Use the Up/Down arrows (↑/↓) to highlight a menu item.
- 3) Use the Left/Right arrows (←/→) to scroll through options for that menu item.
- 4) Highlight the selected menu option.
- 5) Press **ENTER** to lock in the change.

Remote control

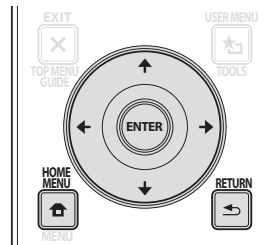

Home Menu screen

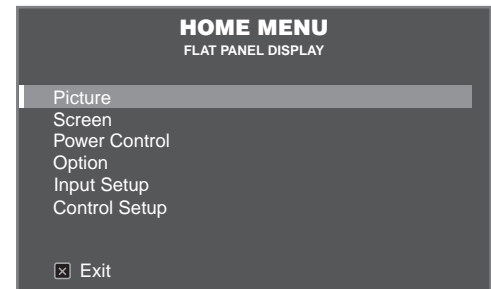

- 6) Press **RETURN** to move back to a previous menu/submenu page when changing more than a single option.
- 7) Press **HOME MENU** again to exit the menu screen.

This chart provides a breakdown of the Home Menu.

Home Menu	Pg	Option
Picture	31	AV Selection
	35	Contrast
	35	Brightness
	35	Color
	35	Tint
	35	Sharpness
	37	Color Temp
	35	Red
	35	Green
	35	Blue
	38	Gamma
	38	Pro Adjust
	27	Reset
Screen	53	Auto Setup
	26	H. Position
	26	V. Position
	53	Clock
	53	Phase
	33	Auto Size
	36	Side Mask
	37	Reset

Home Menu	Pg	Option
Power Control	29	Energy Save
	45	Power Management
	45	No Signal Off
	45	No Operation Off
Option	24	Language
	28	Input Priority
	28	Blue LED Dimmer
	29	Orbiter
	29	Video Pattern
	28	Long Life Settings
	25	Room Light Sensor
	44	PIP Detect
Input Setup	52	Input Setup 1/2
	52	Input Setup 2/2
Control Setup	64	IP Control Setting
	58	KURO LINK Setting
	69	Serial Setting

3.2.3 Use the Simplified User Menu

For simplified menu selections, the User Menu provides quick access to frequently used menus/submenus. Press **USER MENU** on the remote control. For actual procedures, refer to “3.2.2 Explore the Home Menu”. The following table shows the available menus.

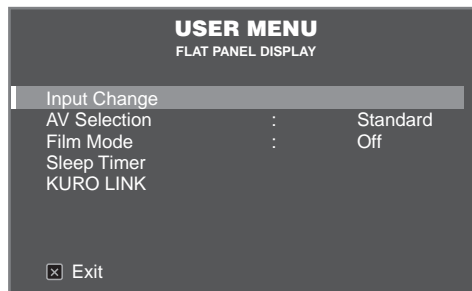

User Menu screen

User Menu	Function
Input Change	switches external input sources
AV Selection	selects from eight viewing modes depending on the picture (see page 31)
Film Mode	reproduces theatre-quality images for film-based sources (see page 38)
Sleep Timer	places the panel into Standby when the set time elapses (see page 30)
KURO LINK	controls the connected equipment with the panel's remote through HDMI (see page 56)

3.2.4 Assign a Language

The default menu language is English. To assign a different language for menus and on-screen information, follow the steps below.

- 1) Access *Language* through the *Option* menu.

Language	:	English
Input Priority	:	Off
Blue LED Dimmer	:	Low
Orbiter	:	Off
Video Pattern	:	Off
Long Life Settings	:	No
Room Light Sensor	:	Off
PIP Detect	:	Auto

- 2) Select a language from the submenu.
- 3) Press **HOME MENU** to exit the menu.

4 Basic Picture Adjustment

This chapter explores basic picture adjustment options for your flat panel display.

4.1 Adjust the Picture Quality

Your flat panel display has many adjustment options for the picture to make it just right for you. This section provides basic adjustments but for detailed video modifications, refer to “5 Additional Picture Adjustment Options.”

4.1.1 Adjust the Picture for Your Room Lighting

The flat panel display senses the amount of light in your room and automatically adjusts the screen brightness for the best picture. Bright rooms require stronger coloring so images appear crisp while dimly lit rooms allow the picture to use more subtle coloring.

The panel ships with the Room Light Sensor turned Off. The sections below provide directions to turn the room lighting sensor On/Off.

Room Lighting Sensor

To deactivate/reactivate the room lighting sensor, follow the steps below.

- 1) Access *Room Light Sensor* through the *Option* menu.

Language	:	English
Input Priority	:	Off
Blue LED Dimmer	:	Low
Orbiter	:	Off
Video Pattern	:	Off
Long Life Settings	:	No
Room Light Sensor	:	Off
PIP Detect	:	Auto

- 2) Select *On* (or *Off*) from the submenu.

- 3) Press **HOME MENU** to exit the menu.

4.1.2 General Picture (Video) Adjustment

The directions below apply to all AV Selection options except OPTIMUM and DYNAMIC. If the viewing option is OPTIMUM, your flat panel display automatically adjusts the picture to the best possible level. If the preferred viewing option is DYNAMIC, please refer to “5.1 Choose an AV Option (Video, Game, etc.).”

For standard picture adjustments, follow the steps below.

- 1) Press **HOME MENU**.
- 2) Select *Picture* from the main menu.
Use the arrow buttons to highlight an option then press ENTER.
- 3) Select an item to be adjusted.
Contrast is used in the example below.

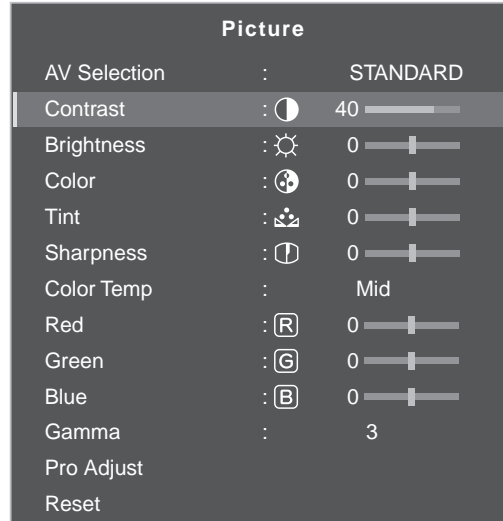

- 4) Use the arrow buttons (←/→) to adjust to the desired level.



- 5) Press **HOME MENU** again to exit the menu.

Picture Image Position

Each input source stores the picture adjustment settings for that view. Although repositioning is available in most screen views, when the screen is set to Dot by Dot, the Position menu is unavailable. Also, depending on the displayed video, the image position may not change after an adjustment.

To adjust the picture's horizontal and vertical position, follow the steps below.

- 1) Access *H.Position* or *V.Position* through the *Screen* menu.

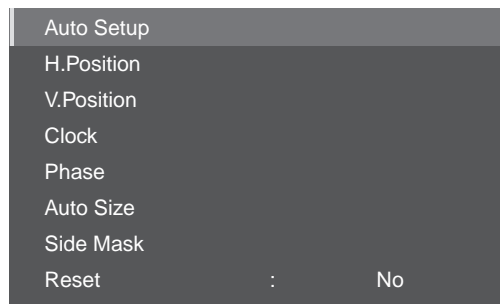

- 2) Adjust the vertical and/or horizontal positioning using the arrow buttons.
- 3) Press **HOME MENU** to exit the menu.

Restore Default Picture

After making multiple adjustments, it may be difficult to reverse improper settings. To restore the factory default Picture settings, follow the directions below.

- 1) Access *Reset* from the *Picture* menu.
- 2) Press **ENTER** to continue with the picture reset.
- 3) Use the arrow buttons to highlight *Yes*.
- 4) Press **ENTER**.
All Picture settings return to the original default values.

4.1.3 Compare Images When Adjusting the Picture

When adjusting the picture, look for an overall improvement by adjusting each parameter or option one at a time. Many small adjustments lead to the best picture for your viewing area. As each option changes, refer back to the previously set image for comparison. This section includes adjustment notes and steps to adjust the picture.

Each parameter/option must be adjusted separately. For example, if two options under AV Selection, STANDARD and MOVIE need adjustment, change/compare one option then save the preferred setting before moving on to the other option. Below are other guidelines for picture adjustment.

- Adjustments are available while on the *After* screen. Trying to make adjustments while on the *Before* causes a warning message to appear.
- Switch to another parameter/option only from the *After* screen. If viewing the *Before* screen when selecting another option, the *Before* data is lost.
- Exiting an option from the *Before* screen stores that previous entry in memory and deactivates the button.
- Exiting an option from the *After* screen stores the new entry in memory and deactivates the button.
- Moving/changing the AV Selection parameter/option stores the option setting in memory (the button continues to work).

Follow the steps below to adjust options for the preferred picture quality.

- 1) Press **HOME MENU**.
- 2) Select *Picture* from the main menu.
Use the arrow buttons to highlight an option then press ENTER.
- 3) Select an option.
- 4) Press **USER MENU** while the adjustment menu is on screen.
The word "Before" appears on screen with the unadjusted picture showing in Step 2.
- 5) Press **USER MENU** again.
*The adjusted picture appears and the word "Before" disappears.
Pressing USER MENU toggles the picture between Before and After.*
- 6) Repeat Steps 3 through 5 to adjust other picture options.
- 7) Press **HOME MENU** again to exit the menu.

Notes: If no selections are made within 60 seconds, the menu closes automatically and the current settings are saved to memory.

"Before" is canceled if:

- *The STANDBY/ON button, INPUT, SWAP or AV SELECTION is pressed*
- *input signal changes*

To exit the menu without saving the changes, switch to the *Before* screen then press **HOME MENU**.

4.2 Smart Starts for New Owners

Many of the flat panel display features make it easier to use but also environmentally friendlier. This section explains how to extend the life of your panel through being energy efficient. We suggest applying all of the following functions below for the simplest usage, best quality, and longest life span.

4.2.1 Extend Your Panel Life

This function provides short-cuts to your panel's longer service life. Your flat panel display includes a Long Life Settings option. Activating this option causes the panel to automatically select several different features that can prolong the life of your panel and help alleviate after-image ghosts or burn-in. To set this option, follow the steps below.

- 1) Access *Long Life Settings* through the *Option* menu.
A confirmation screen appears.
- 2) Select *Yes* from the submenu.
The following settings are automatically entered:
 - *Auto Size: Wide Zoom*
 - *Side Mask - Detection: Mode 1*
 - *Orbiter (AV source): Mode 1*
 - *Orbiter (PC source): Mode 1*
 - *Energy Save: Save 1*
 - *AV Selection: OPTIMUM (only when it was set to DYNAMIC previously)*
- 3) Press **HOME MENU** to exit the menu.

4.2.2 Adjust the Power Indicator Brightness

Adjust the brightness of the Power On indicator depending on the brightness level of the viewing area. Setting to Auto toggles the brightness of the indicator between High, Mid and Low to match the brightness level of the viewing area. To set the indicator, follow the directions below.

- 1) Access *Blue LED Dimmer* through the *Option* menu.
- 2) Select *Auto, High, Mid* or *Low* from the submenu.
- 3) Press **HOME MENU** to exit the menu.

4.2.3 Set Input Priority

With a priority input assigned, the flat panel display automatically switches to that input when signals are present. To set the priority input, follow the directions below.

- 1) Access *Input Priority* through the *Option* menu.
- 2) Select *Auto* from the submenu.
- 3) Select the desired input.
Detecting another signal at a different input causes the selected input to automatically change to the new input.
After input changes, the previous input is not restored even when the signal disappears at the input.
- 4) Press **HOME MENU** to exit the menu.

4.2.4 Turn On the Image Orbiter

A built-in feature to protect against burn-in is the Orbiter function. Orbiter slightly changes the position of the picture while the image is on screen.

To activate Orbiter, follow the steps below.

- 1) Access *Orbiter* through the *Option* menu.
- 2) Select *Mode 1*, *Mode 2* or *Off*.
 - *AV source Mode 1: for any screen mode except Dot by Dot*
 - *AV source Mode 2: for all available screen modes*
 - *PC source Mode 1: to enable Orbiter*
 - *PC source Mode 2: to smooth the text/character appearance*
- 3) Press **HOME MENU** to exit the menu.

Note: The farthest edges of an image may be hidden at times as the picture position shifts. Also, when the Orbiter function is set to Mode 1 or Mode 2, the image may appear to drop slightly on the screen.

4.2.5 Trigger the Screen-Saving Video Pattern Periodically

The Video Pattern function causes the screen to appear white, which helps to alleviate after-image ghosts or burn-in. While the Video Pattern screen is on, only the remote's **MONITOR** (⏻) button and the panel's STANDBY/ON button are available. The panel automatically switches to Standby one hour after running the Video Pattern screen. To cancel the Video Pattern screen, press the remote's **MONITOR** (⏻) or press the panel's STANDBY/ON button.

To activate the Video Pattern screen, follow the steps below.

- 1) Access *Video Pattern* through the *Option* menu.
A confirmation screen appears.
- 2) Select *Start* from the submenu.
The Video Pattern screen appears.
- 3) Leave the panel alone for a minimum of one hour.

Note: The Video Pattern timer has priority over Sleep Timer, No Signal Off, and No Operation Off (Power Management) settings.

4.2.6 Activate Energy Save to Reduce Power Usage

The Energy Save option decreases picture brightness and lowers power consumption. The recommended setting, Save 1, extends the life of your panel while keeping power usage at a minimum.

Follow the steps below to activate an Energy Save option.

- 1) Access *Energy Save* through the *Power Control* menu.
- 2) Select an option from the *Energy Save* submenu.

Option	Description
Standard	No effect
Save 1	consumes less power than Standard
Save 2	consumes less power than Save 1
Picture Off	activates Picture Off when closing the Home Menu with this option selected

- 3) Press **HOME MENU** to exit the menu.

Note: To deactivate the screen, select Picture Off.

4.2.7 Turn On the Sleep Timer

To save energy and to maximize the life of your flat panel display, try using the Sleep Timer for occasions when the panel may be left on by accident. The Sleep Timer places the panel in Standby when the selected time elapses. The Sleep Timer provides time periods of 30, 60, 90, or 120 minutes. When the Timer is down to five minutes, a reminder appears on screen each minute until the time has elapsed.

To set the Sleep Timer, follow the steps below.

- 1) Press **USER MENU**.
- 2) Select *Sleep Timer* from the User Menu.
- 3) Select the desired time period.
Select between 30 minutes and two hours (120 minutes).
- 4) Press **USER MENU** again to exit the menu.

Note: When the sleep timer has been set, "Remain ---min" appears at the top of the menu.

The Video Pattern timer has priority over the sleep timer. When the Video Pattern timer is on, the sleep timer is deactivated. Video Pattern is explained in an earlier section in this manual.

5 Additional Picture Adjustment Options

To take advantage of all that your flat panel display offers, browse this chapter for features and functions that enhance your viewing experience. Most sections deal with adjusting the picture and arranging screen/menu items while the remaining sections provide power management options. Apply as many or as few of these changes as desired.

5.1 Choose an AV Option (Video, Game, etc.)

Similar to the purpose for the room light sensor, the AV Option or Selection depends upon the brightness of the environment and the movie on screen. Images can be from either an AV Source or from a PC. Both sources are discussed below.

Choose from among the seven AV Selections for the best image from an external AV Source. Use either the remote control or the Home Menu to select the AV source. For a PC, skip down to "5.1.3 Choose a PC Source." If the AV source is a Game Control, select GAME and refer to "5.1.4 Set the Panel to Recognize a Game Console" for more information.

5.1.1 AV Source through the Remote Control

Follow the directions below to set the AV Selection for an external AV Source.

- 1) Press **AV SELECTION** on the remote control.
The current AV selection appears.
- 2) Press **AV SELECTION** again before the displayed mode disappears.
Each press cycles the options in the order shown below.

AV Selection	Description
OPTIMUM	automatically adjusts the image quality for the brightness level of the viewing area
STANDARD	for a highly defined image in a normally bright room
DYNAMIC	for a very sharp image with maximum contrast but manual image quality adjustment unavailable
MOVIE	for movies
PURE	reflects input signals as faithfully as possible for checking image materials, for example
SPORT	for sports programs
GAME	lowers image brightness for easier viewing
USER	allows customizing settings as desired (set the mode for each input source)

- 3) Allow the AV Selection screen to disappear.
When the menu screen disappears, the panel locks in the last viewed option.

5.1.2 Choose an AV Source through the Home Menu

Another method for choosing an AV Selection uses the Home Menu.

The AV Selection, OPTIMUM, automatically adjusts to the highest image quality possible for the selected source and viewing environment.

DYNAMIC locks out manual adjustments for specific options. The DYNAMIC setting blocks Contrast, Brightness, Color, Tint, Sharpness, and Reset. Unavailable options are dimmed on the menu.

To choose an AV source through the Home Menu, follow the steps below.

- 1) Access *AV Selection* through the *Picture* menu.
- 2) Select an option from the submenu.

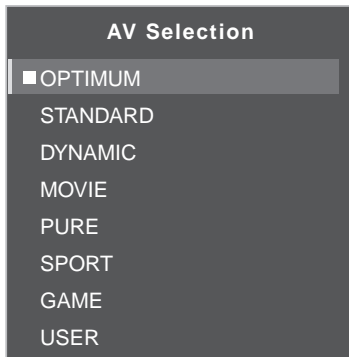

When OPTIMUM is selected, images are reproduced based on the information collected at the Room Light Sensor.

- 3) Press **HOME MENU** to exit the menu.

5.1.3 Choose a PC Source

From a PC, choose between two AV Selections for the best image. The options are as follows:

- STANDARD: for a highly defined image in a normally bright room
- USER: allows customizing the settings for each input source

5.1.4 Set the Panel to Recognize a Game Console

When adding a game console to your flat panel display, use the Game function to establish a preference for image quality or for operability.

To have the panel store your Game preference, follow the steps below.

- 1) Access *Pro Adjust* through the *Picture* menu.
- 2) Select *Other* from the *Pro Adjust* menu.
- 3) Select *Game Control Pref.* from the submenu.
- 4) Select *On* (operability preferred) or *Off* (image quality preferred).
- 5) Press **HOME MENU** to exit the menu.

To activate the *Game Control Pref.* option, set the AV Selection to GAME and use an external input (unless the source is coming from a PC). When a PC source menu is on screen, the *Game Control Pref.* option is ignored. Also, the *Game Control Pref.* option for operability (on) is ignored during multi-screen viewing (refer to "5.4 View in Multi-Screen") and image freezing (refer to "5.5 Freeze the Picture").

5.2 Adjust Specific Picture Elements

Plasma technology delivers one of the best images available today. However, the viewing area/environment and personal preferences affect how the picture appears. This section provides methods to adjust the picture for your best viewing experience.

5.2.1 Choose a Screen Size (Automatically or Manually)

Automatic Screen Sizing

The flat panel display can automatically select an appropriate screen size for a video signal coming from an HDMI device. To allow automatic screen sizing, follow the steps below.

- 1) Access *Auto Size* through the *Screen* menu.
- 2) Select *Natural* or *Wide Zoom* from the submenu.

Option	Description
Off	deactivates the Auto Size function
Natural	adjusts the image to the screen size
Wide Zoom	enlarges and displays only the 4:3 aspect ratio portion in full and wide screen

- 3) Press **HOME MENU** to exit the menu.

Note: When a video signal contains no aspect ratio information, the Automatic Screen Size function is unavailable.

Manual Screen Sizing

Manually select an appropriate screen size if an image fails to appear in the correct format. Browse the menu for the specific video signal's correct screen size.

The selectable screen sizes differ depending on the type of input signal. While watching video content, press **SCREEN SIZE** on the remote control to cycle the picture through Auto, FULL, Dot by Dot, ZOOM, CINEMA, 4:3, WIDE, WIDE 1, WIDE 2, FULL 14:9 and CINEMA 14:9. Freely change the screen size during video from other input sources. Auto is available when receiving HD pictures.

The following chart provides information about how the screen appears for each option.

AV Option	Description
Auto	adds side masks or displays the image in full screen when detecting HD pictures containing side masks (See <i>Detect Masks</i> on page 36)
FULL (FULL 14:9)	squeezes 16:9 (14:9) images
Dot by Dot	matches input signal to the same number of screen pixels (available for 1080i or 1080p signals only)
ZOOM	bars may appear on the top and bottom on some pictures that are 16:9 letterbox
CINEMA CINEMA 14:9	bars may appear on the top and bottom on some pictures that are 14:9 letterbox (available for SD signals only)
4:3	side bars appear on each side
WIDE	pictures progressively stretch toward each side (available for SD signals only)
WIDE 1	pictures progressively stretch toward each side (available for HD signals only)
WIDE 2	pictures evenly stretch toward each side (available for HD signals only)
PC Option	Description
4:3	fills without altering the input signal aspect ratio
FULL	shows 16:9 screen display

With WIDE 1 or WIDE 2 selected, a High Definition (HD) picture image or menu may run off the edge of the screen. If an image or menu appears cut or cropped, change the option to FULL.

Avoid showing signals that fill only part of the screen. Images that fail to fill the screen may cause temporary or permanent image retention depending on the frequency and duration. For example, an HD picture with side masks (4:3 content) causes uneven wear of the plasma cells. If side masks appear around a broadcast, after that movie or program is over, switch to a full screen motion video. This action helps the panel balance wear for the plasma cells and guard against after-image issues. For more information about Masks, refer to "5.3.1 Adjust for Screen Masking (black bars on sides)."

Note: Not all video signals carry alternative screen sizes.

5.2.2 Correct the Picture for an AV or PC Source

Although picture adjustments are to your personal preferences, often the source causes unanticipated image changes. Your flat panel display offers several adjustment options.

AV Source

Option	Left Arrow	Right Arrow
Contrast	less contrast	more contrast
Brightness	dimmer	brighter
Color	weaker intensity	stronger intensity
Tint	purplish skin tones	greenish skin tones
Sharpness	softer definition	crisper definition
Color Temp	adjusts white tone to your preference	
Gamma	adjusts the balance of image's bright and dark portions	

PC Source

Option	Left Arrow	Right Arrow
Contrast	less contrast	more contrast
Brightness	dimmer	brighter
Red	weaker color	stronger color
Green	weaker color	stronger color
Blue	weaker color	stronger color

To correct the picture for an AV or a PC source, follow the steps below.

- 1) Press **HOME MENU**.
- 2) Select *Picture* from the main menu.
Use the arrow buttons to highlight an option then press ENTER.
- 3) Select an option to adjust.

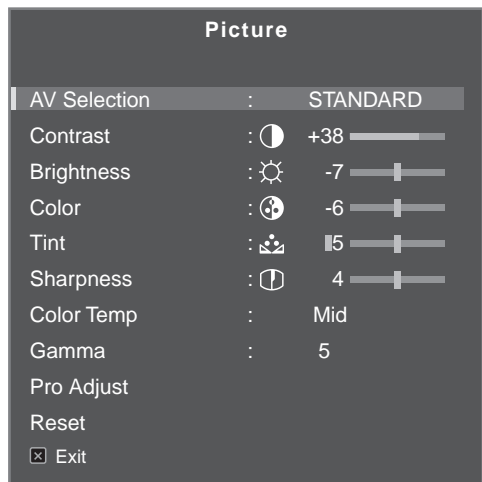

(AV source)

- 4) Select the desired level for that option using the left/right arrows (←/→).



- 5) Repeat the process for any additional adjustments.
- 6) Press **HOME MENU** again to exit the menu after all adjustments are complete.

Note: Reset returns all settings to the factory defaults.

5.3 Assign Advanced Picture Functions

Your flat panel display provides various advanced functions for optimizing the picture quality that go beyond basic adjustments explained earlier in this manual. This section explores the value offered through Pioneer's Pro Adjust support, top quality blacks, better balanced whites, and overall color improvements.

5.3.1 Adjust for Screen Masking (black bars on sides)

Screen Masks fill areas on both sides of a picture. Some content fails to fill the screen so bars appear on each side of the picture. This section explains how to adjust screen masking.

Detect Masks

Some HD video signals have 4:3 content with side masks. Side masks are black bars that appear on the picture's left and right sides. If the flat panel display's Screen Size is set to Natural during the Auto Size process, gray bars replace the black bars. When the panel is set to Wide Zoom, the bars are hidden. These responses reduce after-image concerns.

To allow the panel to detect side masks, follow the steps below.

- 1) Access *Side Mask* through the *Screen* menu.
- 2) Select *Detection* from the submenu.
- 3) Select *Mode 1* or *Mode 2* to activate Side Mask Detection.
Mode 1 detects only black side masks and Mode 2 detects both black and illustrated side masks. Select Off to deactivate this function.
- 4) Press **HOME MENU** to exit the menu.

Video signals can affect the Side Mask Detection function differently. For High Definition pictures when Side Mask Detection is on, the panel automatically detects images containing side masks and shows the picture in full screen.

Cycle the screen size to select Auto for video signals that do not carry aspect ratio information.

Video content also can affect the Side Mask Detection function. If a detection error occurs when trying to watch HD content, manually change the screen size to the proper setting for the content.

HD Wide Mode

The HD Wide Mode allows selecting the display mode (WIDE 1 or WIDE 2) when detecting side masks that appear in a 4:3 image. This option is available when the Auto Size menu is set to Wide Zoom and Side Mask Detection to Mode 1 or Mode 2. To allow the HD Wide Mode, follow the steps below.

- 1) Access *Side Mask* through the *Screen* menu.
- 2) Select *HD Wide Mode* from the submenu.
- 3) Select *Mode 1* or *Mode 2* to activate HD Wide Mode.
 - *Mode 1: screen mode sets to WIDE 1 when detecting side masks.*
 - *Mode 2: screen mode sets to WIDE 2 when detecting side masks.*
- 4) Press **HOME MENU** to exit the menu.

Lighten Side Masks

If content appears with bars (side masks) on each side of a picture when the screen size is 4:3 and Side Mask Detection is active, the bars automatically change from black to gray. However, the gray is fairly dark. To change the bars to a lighter shade of gray, follow the steps below.

- 1) Access *Side Mask* through the *Screen* menu.
- 2) Select *Brightness Sync.* from the submenu.
- 3) Select the desired parameter.

Parameter	Description
Fixed	sets the same brightness for gray side masks
Auto	adjusts the side mask brightness according to the brightness of screen images

- 4) Press **HOME MENU** to exit the menu.

Restore Default Screen

To restore the factory default screen settings, follow the directions below.

- 1) Access *Reset* through the *Screen* menu.
- 2) Press **ENTER** to continue with the screen reset.
- 3) Use the arrow buttons to highlight *Yes*.
- 4) Press **ENTER**.
All screen settings return to the original default values.

5.3.2 Select a Color Temperature Level

Use this option to adjust the color temperature for a better white balance. To adjust the white balance, follow the directions below.

- 1) Access *Color Temp* through the *Picture* menu.
- 2) Select the desired parameter from the submenu.

Parameter	Description
High	white with bluish tone
Mid-High	intermediate tone between High and Mid
Mid	natural tone
Mid-Low	intermediate tone between Mid and Low
Low	white with reddish tone
Manual	adjusts to your preference

To manually adjust the white balance, continue with the following Steps.

- 3) Select *Manual* in Step 2.
- 4) Press **ENTER** to confirm.
- 5) Use the right arrow button to adjust the balance.
The manual adjustment screen appears.
- 6) Select an option to adjust.

7) Select the desired level.

Option		Left Arrow	Right Arrow
R High	fine adjustment for bright portions	weaker red	stronger red
G High		weaker green	stronger green
B High		weaker blue	stronger blue
R Low	fine adjustment for dark portions	weaker red	stronger red
G Low		weaker green	stronger green
B Low		weaker blue	stronger blue

8) Press **RETURN** to repeat Steps 6 and 7 as often as needed for additional adjustments.

9) Press **HOME MENU** to exit the menu.

5.3.3 Adjust the Image Gradation Characteristics (Gamma)

Use this option to adjust the image characteristics (gamma characteristics). For adjustments, follow the directions below.

- 1) Access *Gamma* through the *Picture* menu.
- 2) Select 1 through 5 from the submenu.
- 3) Press **HOME MENU** to exit the menu.

5.3.4 Select a PureCinema Level for High Quality Image

Pioneer's PureCinema automatically detects and analyses a film-based source (originally encoded at 24 frames per second) then recreates each frame for HD picture quality. The function supports both film and text material.

To set the PureCinema level for your HD material, follow the steps below.

- 1) Access *Pro Adjust* through the *Picture* menu.
- 2) Select *PureCinema* from the *Pro Adjust* menu.
- 3) Select *Film Mode* or *Text Optimization*, depending on the material.
- 4) Select the desired parameter.

Mode	Parameter	Description
Film Mode	Off	deactivates PureCinema
	Standard (not available for input signals 480p, 720p@60 Hz, or 1080p@60 Hz)	automatically detects recorded DVD or high-definition images (e.g., movies) having 24 frames per second for smooth and vivid playback
	Smooth (not available for input signals 1080p@60 Hz)	produces smoother and more vivid moving images
	Advance (not available for input signals 1080p@60 Hz)	converts theatre-quality DVD images to 72 Hz (e.g., movies)
Text Optimization	Off	deactivates text optimization
	On	improves subtitle display quality

5) Press **HOME MENU** to exit the menu.

*Notes: Activating the Game Control Pref. setting under the Option menu disables the PureCinema setting.
This setting applies only to input video signals.*

5.3.5 Select an Intelligent Mode Option

Use this function to optimize image color tones and brightness.

To select the Intelligent Mode, follow the steps below.

- 1) Access *Pro Adjust* through the *Picture* menu.
- 2) Select *Intelligent Mode* from the *Pro Adjust* menu.
- 3) Select *Mode 1* or *Mode 2* (or *Off*).
- 4) Select the desired parameter.

Parameter	Description
Off	No effect
Mode 1	compensates for more effective picture settings
Mode 2	compensates for appropriate picture settings

5) Press **HOME MENU** to exit the menu.

*Notes: Although this function gradually optimizes the image quality, tint and brightness changes may be visible.
This is normal and is not a malfunction.
This setting applies only to input video signals.*

5.3.6 Select the Picture Detail Options

The Picture Detail function provides four adjustment options: DRE Picture, Black Level, ACL, and Enhancer Mode for enhanced image contrast and sharpness.

To select the Picture Detail options, follow the steps below.

- 1) Access *Pro Adjust* through the *Picture* menu.
- 2) Select *Picture Detail* from the submenu.
- 3) Select *DRE Picture, Black Level, ACL or Enhancer Mode*.
- 4) Select the desired parameter.

Option	Parameter	Description
DRE Picture (emphasizes image contrast between light and dark)	Off	No effect
	High	enhances DRE picture
	Mid	standard DRE picture
	Low	moderate DRE picture
Black Level (emphasizes dark portion of images for enhanced contrast)	Off	No effect
	On	activates Black Level
ACL (compensates images for optimum contrast)	Off	No effect
	On	activates ACL
Enhancer Mode (processes the image's high frequency (detailed) area)	1 (Hard)	selects Hard (SHARPNESS) image
	2 (Natural)	selects Natural (SHARPNESS) image
	3 (Soft)	selects Soft (SHARPNESS) image

- 5) Press **HOME MENU** to exit the menu.

Note: This setting applies only to input video signals.

5.3.7 Use CTI and Color Space

Use the Color Transient Improvement (CTI) and Color Space options to further picture enhancement.

To set the CTI and Color Space options, follow the steps below.

- 1) Access *Pro Adjust* through the *Picture* menu.
- 2) Select *Color Detail* from the *Pro Adjust* menu.
- 3) Select *CTI or Color Space* from the submenu.
- 4) Select the desired parameter.

Option	Parameter	Description
CTI	Off	No effect
	On	activates CTI
Color Space	1	optimizes for vivid, vibrant color
	2	standard color reproduction

- 5) Press **HOME MENU** to exit the menu.

Note: This setting applies only to input video signals.

5.3.8 Use the Color Management

Use the Color Management option to fine adjust image coloring.

To set the Color Management option, follow the steps below.

- 1) Access *Pro Adjust* through the *Picture* menu.
- 2) Select *Color Detail* from the *Pro Adjust* menu.
- 3) Select *Color Management* from the submenu.
- 4) Select the desired parameter.
- 5) Select the desired level.

Item	Left Arrow	Right Arrow
R	closer to magenta	closer to yellow
Y	closer to red	closer to green
G	closer to yellow	closer to cyan
C	closer to green	closer to blue
B	closer to cyan	closer to magenta
M	closer to blue	closer to red

- 6) Press **RETURN** or use the **←/→** button to repeat Steps 4 and 5 as needed.
- 7) Press **HOME MENU** to exit the menu.

Note: This setting applies only to input video signals.

5.3.9 Reduce Noise from the Image

Use the video noise reduction features for clear and crisp images. Refer to the table below for available video noise reduction.

To select the Noise Reduction options, follow the steps below.

- 1) Access *Pro Adjust* through the *Picture* menu.
- 2) Select *Noise Reduction* from the *Pro Adjust* menu.
- 3) Select *3DNR*, *Field NR*, *Block NR* or *Mosquito NR*.
- 4) Select the desired parameter.

Option	Parameter	Description
3DNR (3-dimensional Noise Reduction)	Off	No effect
	High	enhances DNR
	Mid	standard DNR
	Low	moderate DNR
Field NR (removes glimmer for more natural image)	Off	No effect
	High	enhances Field NR
	Mid	standard Field NR
	Low	moderate Field NR
Block NR (reduces noise in HD images)	Off	No effect
	On	activates Block NR
Mosquito NR (reduces mosquito noise in DVD and HD images)	Off	No effect
	On	activates Mosquito NR

5) Press **HOME MENU** to exit the menu.

Note: This setting applies only to input video signals.

5.3.10 Adjust Color Signals

Your flat panel display features various color signal adjustment options: 3DYC, I-P Mode, Drive Mode, Game Control Pref., and Blue Only Mode. Use these options to adjust color signals for both video and still images.

To select color signal adjustment options, follow the steps below.

- 1) Access *Pro Adjust* through the *Picture* menu.
- 2) Select *Other* from the *Pro Adjust* menu.
- 3) Select *3DYC*, *I-P Mode*, *Drive Mode*, *Game Control Pref.* or *Blue Only Mode*.
- 4) Select the desired parameter.

Option	Parameter	Description
3DYC (optimizes characteristics for separating brightness signals from color signals)	Off	No effect
	High	enhances 3DYC
	Mid	standard 3DYC
	Low	moderate 3DYC
I-P Mode (provides optimum conversion from interlace signals to progressive signals)	1 (Motion)	optimizes video images
	2 (Standard)	standard setting
	3 (Still)	optimizes still images
Drive Mode (switches image display frequency)	1	standard setting
	2	enhances readability for horizontally scrolling text
	3	optimizes movie content
Game Control Pref. (establishes a gaming preference for image quality or operability)	Off	image quality preferred
	On	operability preferred
Blue Only Mode (displays images in blue only)	Off	No effect
	On	activates Blue Only Mode

Drive Mode is unavailable when setting *Game Control Pref.* to *Off*.

To activate the *Game Control Pref.* option, set the AV Selection to *GAME*. This option is unavailable for a PC source. Also, the *Game Control Pref.* option for operability (On) is ignored during multi-screen viewing (page 43) or image freezes (page 44).

5) Press **HOME MENU** to exit the menu.

*Notes: Reset returns all settings to factory defaults.
This setting applies only to input video signals.*

5.4 View in Multi-Screen

The flat panel display can show multiple screens at the same time; two-screen or picture-in-picture. The pictures may be reversed (in 2-screen and P-in-P) or moved to various locations on the screen (P-in-P).

2-Screen

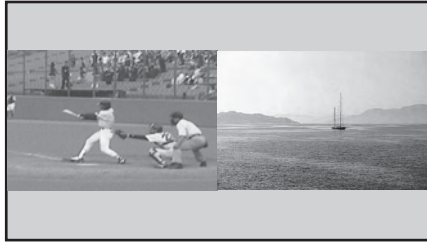

Picture-in-Picture (P-in-P)

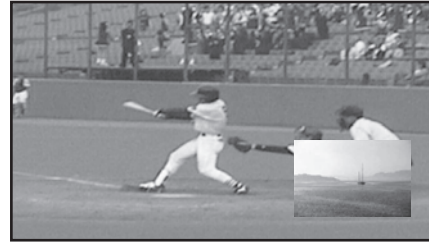

5.4.1 Split / Swap / Shift the Screen

To split the screen so that two input sources appear, press the **SPLIT** button on the remote control. Each press of the button cycles the screen through two-screen, picture-in-picture, and single-screen views.

To switch the image sides/locations, press the **SWAP** button.

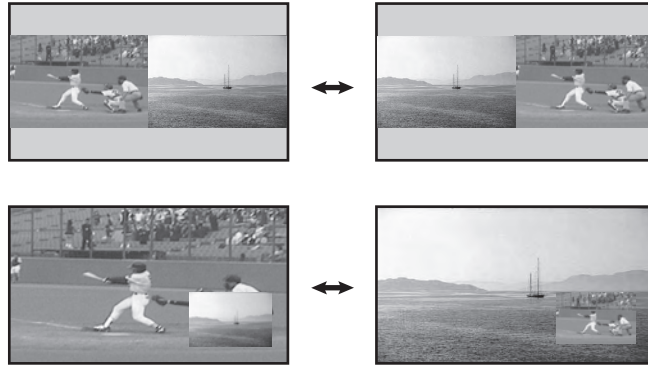

To move the Picture-In-Picture (P-in-P) small image counter-clockwise, press the **SHIFT** button.

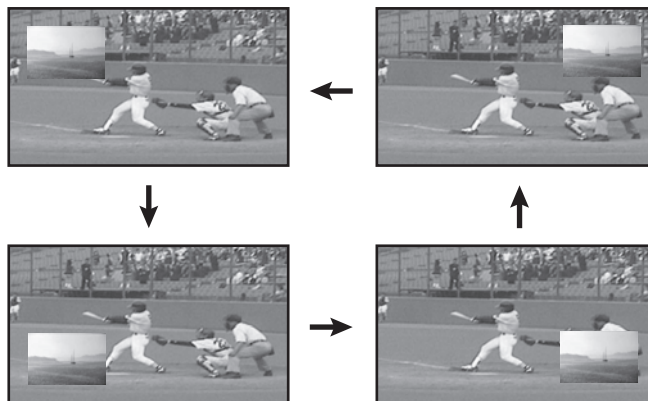

Press **SPLIT** to cycle through the different multi-screen views.
 Press **SWAP** to switch the position of the two screens.
 Press **PIP SHIFT** to move the position of the small screen counter-clockwise during P-in-P.
 Press **SUB INPUT** to switch the input sources between the two screens.

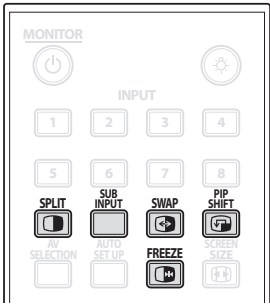

The multi-screen function is unavailable when viewing source from a single input or from two *external* input sources.

Warning: Displaying pictures in multi-screen mode for an extended period may cause an after-image.

To return to a single picture, press **HOME MENU**.

5.4.2 Turn the Small Screen On/Off

Set your flat panel display to automatically hide the small screen window if no input signals appear on the small screen during P-in-P (only a frame remains on screen). To activate this option, follow the directions below.

- 1) Access *PIP Detect* through the *Option* menu.
- 2) Select *Auto* from the *PIP Detect* menu.
The small screen disappears in approximately three seconds if no signal is received. The display restores the image when an input signal is present.
- 3) Press **EXIT** to exit the menu.

Note: PIP Detect is unavailable in two-screen mode.

5.5 Freeze the Picture

During fast-action sequences or detailed pictures, try capturing the image with the **FREEZE** option. **FREEZE** allows you to better understand the action or picture details when desired. To freeze a picture from a TV broadcast or movie, follow the steps below.

- 1) Press **FREEZE** to create a still image picture (copy) of the currently showing image.
The copy appears to the right of the still-moving video sequence thus splitting the screen.
- 2) Press **FREEZE** again to release the image.
The frozen image disappears, returning the picture to a single screen with the video sequence still in progress.
 - With the screen split, an image cannot be frozen.



A warning message appears if you attempt to use this function when there is already a frozen image on screen. If an image is left frozen on the screen, the panel automatically releases the image after five minutes.

Note: Using FREEZE for an extended period may cause an after-image.

5.6 Manage the Power

Your flat panel display is energy efficient but includes functions to save additional power. In an earlier section entitled “4.2 Smart Starts for New Owners”, you were told how to activate the Energy Save feature. This section provides more advanced functions to save power and to extend the panel life.

AV Source - No Signal

To save energy and extend the life of your display, the panel can enter Standby automatically if the AV source signal fails for 15 consecutive minutes. At five minutes before and at every minute after that, a warning message appears on the screen. When the final minute elapses, the panel switches to Standby.

To have the panel switch to Standby when an AV source signal fails, follow the steps below.

- 1) Access *No Signal Off* through the *Power Control* menu.
- 2) Select *Enable* to activate the AV Signal off power function.
- 3) Press **HOME MENU** to exit the menu.

AV Source - Non-Operational

To save energy, the panel can enter Standby automatically if there are no commands from the AV source for three consecutive hours. At five minutes before and at every minute after that, a warning message appears on the screen. When the final minute elapses, the panel switches to Standby.

To have the panel enter Standby automatically when there are no commands from the AV source, follow the steps below.

- 1) Access *No Operation Off* through the *Power Control* menu.
- 2) Select *Enable* from *No Operation Off* menu.
- 3) Press **HOME MENU** to exit the menu.

PC Source -Power Management

When receiving signals from a PC, the panel can enter Standby automatically if the signal fails. Follow the steps below to activate this function.

- 1) Access *Power Management* through the *Power Control* menu.
- 2) Select an option from the submenu.

Option	Description
Off	no power management (default)
Mode 1	panel enters Standby when no signal is received from the PC for <i>eight minutes</i> , using the PC has no effect on the panel
Mode 2	panel enters Standby when no signal is received from the PC for <i>eight seconds</i> , using the PC has no effect on the panel

*Notes: Pressing the remote's **MONITOR** (⏻) button or the panel's STANDBY/ON button reactivates the flat panel display.*

When the panel enters Standby with Mode 1 selected (no signals received), receiving signals again does not cause the flat panel display to turn On.

When the panel enters the Power Management status with Mode 2 selected (no signals received), receiving signals again causes the flat panel display to turn On.

- 3) Press **HOME MENU** to exit the menu.

These power management options are unavailable when a PC is connected to the panel through the HDMI port/terminal.

For video and PC signals applicable to the flat panel display, see “9.2 Video/PC Signals (HDMI/DVI/Component/min D-Sub/Composite).”

6 Use Other Equipment With Your Flat Panel Display

Although earlier sections have mentioned other equipment for playing back video, this section provides control and operation information for specific types of equipment.

6.1 Program the Remote Control to Operate Other Equipment

To operate other equipment or devices through your flat panel display, program the panel's remote control with the equipment's manufacturing code. A manufacturing code is a series of numbers that identify the type of device and the brand. These codes are available in the section entitled "Manufacturer Codes to Program into the Remote Control" in Appendix 9.1 of this manual.

6.1.1 Use the Learning Function

The Learning function allows the panel's remote control to memorize codes to control other devices.

To set the Learning function to On, follow the directions below.

- 1) Press **SELECT** to choose the other device.
- 2) Simultaneously press the **EDIT/LEARN** and **2** buttons to begin.
The selected mode indicator flashes when the remote control is ready to be programmed.
- 3) Use the number buttons to learn a manufacturing code.
The mode indicator lights up.
The Learn session is canceled in 30 seconds and the indicator begins blinking again. When the indicator flashes, the selected device's remote is memorized.
When you press a button that cannot be learned, the indicator continues to blink.
*To exit the Learn mode before it finishes, press **EDIT/LEARN**.*
- 4) Press **EDIT/LEARN** again to exit the Learn mode after the code is confirmed.

Notes: The Learn session cancels if:

- no operation is performed for more than one minute after having pressed **EDIT/LEARN** and **2** (the mode indicator is flashing)
- you press **SELECT**

Code transmission finishes in approximately two seconds. Do not interrupt the process until the transmission is complete.

When using any of the receiver buttons (⏻, INPUT, or VOL +/-), the learned manufacturer code remains the same.

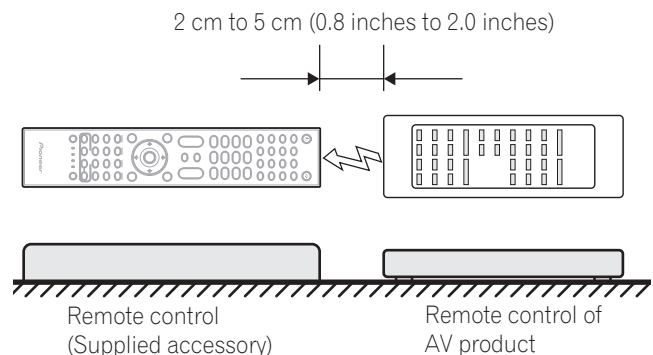
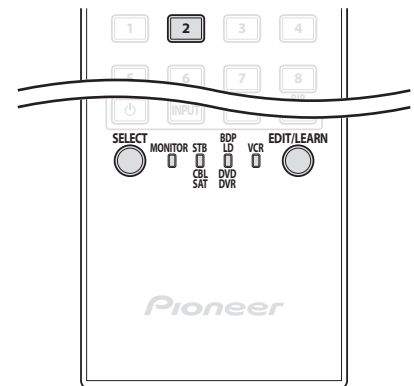

To delete a learned code, overwrite it with a new code on the same button or follow the directions below.

- 1) Simultaneously press the **EDIT/LEARN** and **2** buttons to begin.
The selected mode indicator flashes when the remote control is ready to be programmed.
- 2) Press and hold **MONITOR**  for at least two seconds.
The remote control starts deleting all learned codes for selected modes. When completed, the mode indicator blinks Off and the remote control returns to normal operation.

6.1.2 Assign a Manufacturing Code to the Remote Control

To assign a preset Manufacturing code to the panel's remote control, follow the directions below (Manufacturing codes are listed in section "9.1 Manufacturer Codes to Program into the Remote Control").

- 1) Press **SELECT** to choose the device to program.
- 2) Simultaneously press the **EDIT** and **1** buttons to begin.
The selected mode indicator flashes when the remote control is ready to be programmed.
- 3) Use the number buttons to enter a manufacturer code.
When the indicator turns off, the code has been stored in the remote control.

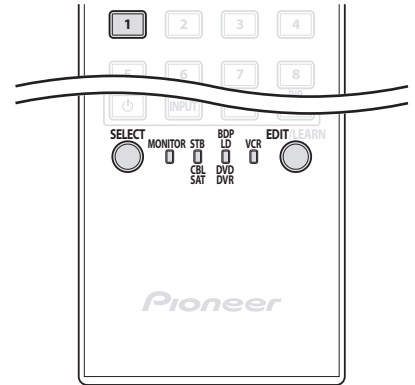

Factory default manufacture codes:
 STB (Set-top Box): Pioneer (0329)
 BDP/LD/DVD/DVR: Pioneer (2052)
 VCR (VTR): Pioneer (0058)



6.1.3 Issue a Library Search for a Manufacturer Code

If the code for a particular device is unknown, cycle through the available codes for a similar unit then sample some functions for that code.

To find a code that can control the unit, follow the steps below using different codes to find the best match.

- 1) Press **SELECT** to choose the device to program.
- 2) Simultaneously press the **EDIT** and **3** buttons to begin.
The selected mode indicator flashes when the remote control is ready to search the code library.
- 3) Sample a code using a SOURCE POWER, PLAY, 1 or CH+ command.
- 4) Use the up/down arrow (/) buttons to advance to the next code if the sampled code fails to control the device.
Another option is to return to the previous code and repeat Step 3.
- 5) Press **ENTER** to lock in the code that properly operates the device.
All the available buttons for the selected mode are added when the mode indicator flashes on for one second. The remote control then returns to normal operation.

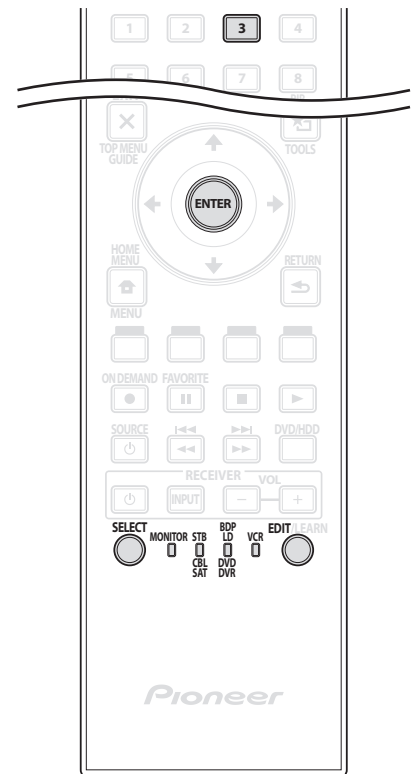

6.1.4 Clear Added Manufacturer Codes from the Remote Control

To return all learned and preset codes to the defaults (PIONEER), follow the steps below.

- 1) Simultaneously press **EDIT** and **MONITOR** (⏻) buttons to begin.
Selection can be in any mode.
- 2) Press the **Yellow** button to clear added codes.
Confirm that the selected mode indicator flashes.
The remote control enters the Manufacturing Reset mode. The reset is complete when the mode indicator flashes once. The remote control then returns to normal operation.

Note: The panel's remote control may not control or have complete control of some equipment listed in the tables.

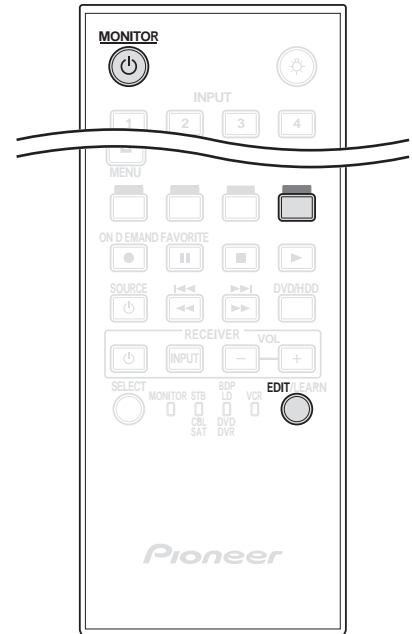

To exit before the reset is complete, press the **EDIT** button again. The reset is cancelled if no action is taken within 60 seconds. Switching the Mode during this procedure also cancels the reset.

6.1.5 Control a Pioneer Receiver

The flat panel display's remote control has a bank of buttons specifically for controlling a Pioneer receiver. The active buttons, left to right, are as follows:

- RECEIVER STANDBY/ON
(turns the Pioneer Receiver On/Off)
- RECEIVER INPUT
(cycles through/selects an input)
- RECEIVER VOL –
(adjusts the volume lower)
- RECEIVER VOL +
(adjusts the volume higher)

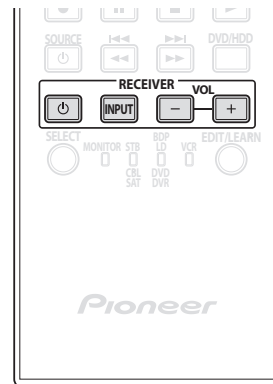

6.1.6 Control a Cable (CBL) or Satellite (SAT) System

When Mode is set to CBL/SAT, a cable converter uses the buttons **1**, **2**, **5**, and **6**. However, the panel only recognizes a single system (cable or satellite) at a time.

- **1** Number buttons
(press to enter a channel number)
- **2** P/CH +/-
(selects a higher or lower channel)
- **3** ENTER
(ENTER activates the selected function)
- **4** SOURCE
(turns the equipment power on and off)
- **5** CH ENTER*
(enters the selected channel with the direct channel selection buttons)
- **6** RETURN
(restores the immediately previous screen)

* Some cable converter manufacturers do not preset CH ENTER.

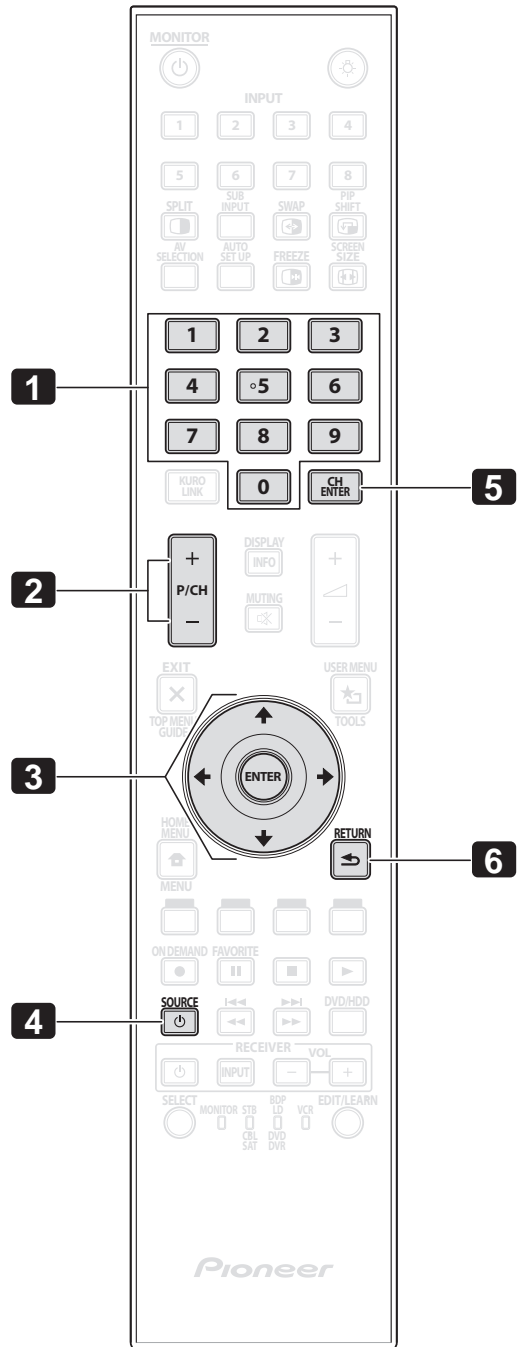

6.1.7 Control a Video Cassette Recorder (VCR)

When Mode is set to VCR, verify that the proper Input is selected (INPUT 1 to INPUT 8) then use the numbers **1** to **8** to control the device.

- **1** P/CH +/-
(selects a higher or lower channel)
- **2** RECOrd
(begins recording)
- **3** PAUSE/STILL
(pauses playback and displays still images)
- **4** SOURCE
(turns the VCR's power on and off)
- **5** REWInd
(rewinds the VCR tape and allows searches)
- **6** STOP
(halts VCR tape transport)
- **7** PLAY
(selects playback)
- **8** FF
(advances the VCR tape and allows searches)

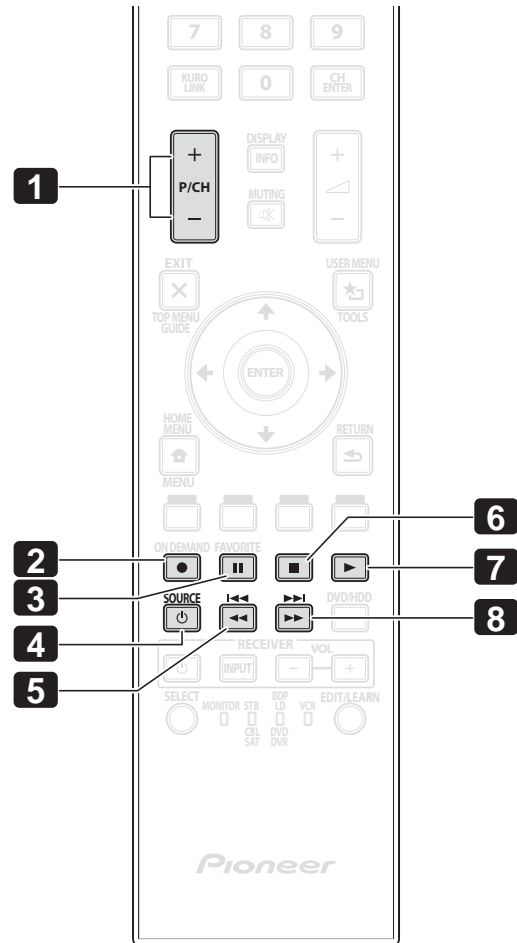

6.1.8 Control a DVD Player/DVR Recorder/BD Player

When Mode is set to DVD/DVR, the remote control can operate a DVD player, DVD recorder or BD player connected to the flat panel display. Verify that the proper Input is selected for the device then use the numbers 1 to 14 to control it.

Note: Equipment from other manufacturers (DVD players, DVD recorders, BD players, and HD-DVD players) can also be operated using the panel's remote control if the remote is programmed for the device(s).

- **1** P/CH +/- (DVD Recorder only)
(selects a higher or lower channel)
- **2** DVD TOP MENU
(displays the top menu on the DVD)
- **3** ENTER
(ENTER activates the selected function)
(arrows to select from MENU screens)
- **4** DVD MENU
(displays the DVD menu)
- **5** Red/Green/Blue/Yellow (BD only)
(controls a BD-J application)
- **6** REcOrd (DVD Recorder only)
(begins recording)
- **7** PAUSE/STILL
(pauses playback and displays still image)
- **8** SOURCE
(turns the equipment power on or off)
- **9** REVERSE SCAN/CHAPTER SEARCH
(press once quickly to go to beginning of current chapter; press again to go back to the beginning of the previous chapter; continue pressing to go backward)
- **10** TOOLS
(assigns the code for a Pioneer BD player)
- **11** RETURN
(restores the immediately previous screen)
- **12** STOP
(halts DVD playback, some DVD players/recorders open the disc tray if this button is pressed twice)
- **13** PLAY
(selects playback)
- **14** FORWARD SCAN/CHAPTER SEARCH
(press once quickly to go to beginning of next chapter; press again to advance to beginning of next chapter; continue pressing for fast forward)

6 & **12** STOP REcOrd (DVD Recorder only)
(press and hold ● then press ■ to stop recording - applies to Pioneer DVD recorders only)

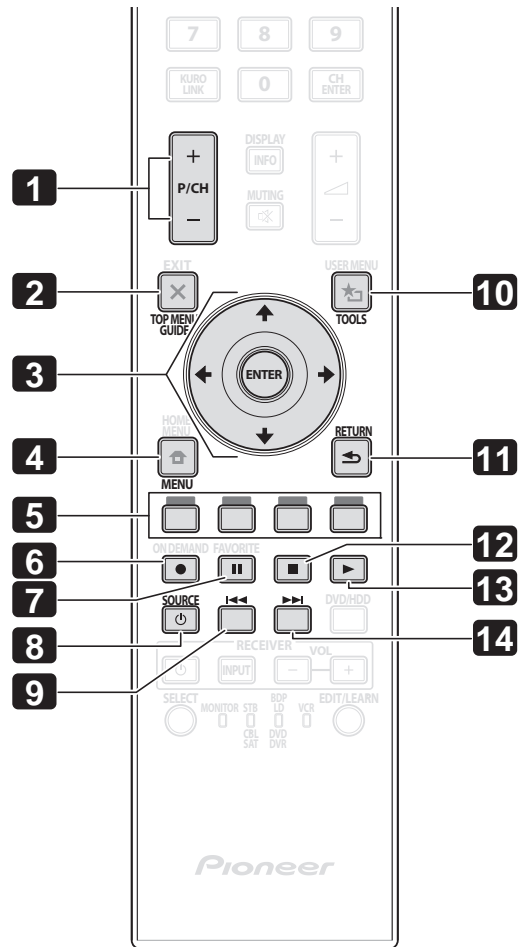

6.2 Apply Settings for Other Equipment

This section provides setting hints for the connected equipment including devices using Composite Video, Component Video, and DVI equipment as well as a PC. For connection details, see page 17.

6.2.1 Apply Settings for an AV System

After connecting other equipment to your flat panel display, you may need to enter an input name, color signal and signal type, depending on the input you select. For details on settings, follow the directions below.

Composite/Component Video System

- 1) Access *INPUT 1(Video)* or *INPUT 2(Component)* through the *Input Setup* menu.

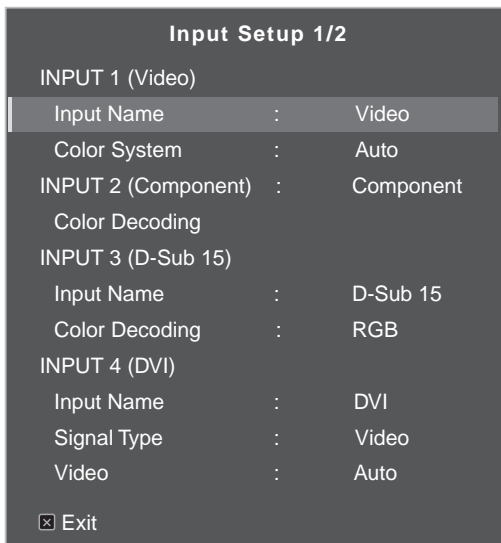

- 2) Select the desired items.

- INPUT 1(Video)
Video, Blu-Ray, DVD, DVR, VCR, Cable, Satellite, GAME or Computer for Input Name;
Auto, PAL, SECAM, NTSC, 4.43NTSC, PAL-M or PAL-N for Color System
- INPUT 2 (Component)
Component, Blu-Ray, DVD, DVR, VCR, Cable, Satellite, GAME or Computer;
Comp.1 (YCbCr) or Comp.2 (YPbPr)

- 3) Press **EXIT** to exit the menu.

*Notes: The factory default setting is Comp. 1 for SD signals and Comp. 2 for HD signals.
Improper setting for Color Decoding causes the image to appear in inappropriate color.*

DVI Equipment

- 1) Access *INPUT 4(DVI)* through the *Input Setup* menu.

- 2) Select the desired item.

DVI, Blu-Ray, DVD, DVR, VCR, Cable, Satellite, GAME or Computer;
Video or PC for Signal Type; Auto, 1 (YUV422), 2 (YUV444), 3 (RGB16-235) or 4 (RGB 0-255) for Video

- 3) Press **EXIT** to exit the menu.

*Notes: After setting DVI, turn on the connected equipment (reboot if a PC is connected). Changing the settings while leaving the connected equipment turned On may cause the signal to fail or become corrupted.
Connecting to a PC's DVI terminal using an HDMI cable can cause improper images to appear. To use an HDMI cable, contact the PC manufacturer.*

6.2.2 Apply Settings for a PC

Connecting a PC to your flat panel display requires specific settings. This section also explores the basic screen adjustments on the flat panel display after applying initial settings for the PC.

- 1) Access *INPUT 3(D-Sub15)* through the *Input Setup* menu.
- 2) Select the desired item.
D-sub15, Blu-Ray, DVD, DVR, VCR, Cable, Satellite, GAME or Computer for Input Name; RGB, Comp.1 (YCbCr) or Comp.2 (YPbPr) for Color Decoding. Auto is only available for Signal Format
- 3) Press **EXIT** to exit the menu.

When connected to a PC, your flat panel display automatically identifies the input signal type. If the panel fails to see the PC or the picture is unclear, use the Screen function to adjust the image.

Automatic Image Position and Clock Adjustments

When connected to a PC, the image position, clock phase and clock frequency can be adjusted. The Auto Setup option automatically adjusts these settings but the image position and clock can be adjusted manually too. This section covers the automatic setup function and the following section explains how to manually adjust positions and clock.

The AV source device must be connected to the flat panel display and turned on for this option to work. To activate Auto Setup, follow the directions below.

- 1) Access *Auto Setup* through the *Screen* menu.
The function begins as soon as the selection is made. However, depending on the image, the position may not change after adjustment.
- 2) Press **HOME MENU** to exit the menu.

Note: This function is unavailable when the PC is connected through the HDMI terminal.

When Auto Setup finishes, the message "Auto Setup Completed" appears on screen. However, if the setup fails to adjust the image, the message still appears if other factors affect the change. Auto Setup may fail with a PC image composed of similar patterns or a monochrome picture. If Auto Setup fails to correct the image positioning and clock, change the PC image and try again.

Manual Image Position and Clock Adjustments

Usually Auto Setup for a PC is the best practice for adjusting the image position, clock phase and clock frequency. However, to personally optimize the screen, follow the directions below.

- 1) Access *H.Position*, *V.Position*, *Clock* or *Phase* through the *Screen* menu.

Option	Description
H.Position	adjusts the horizontal position of an image
V.Position	adjusts the vertical position of an image
Clock	adjusts an image when jitter appears
Phase	adjusts an image when jittered or low-contrast characters, etc. appear

- 2) Use the up/down arrow buttons (↑/↓) to adjust the option.
H.Position, V.Position, Clock and Phase also accept the left/right arrows (←/→) for changes.
- 3) Press **HOME MENU** to exit the menu.

6.3 Use HDMI Inputs

High Definition Multimedia Interface (HDMI) is a communication method commonly used by digital and/or high definition equipment. Your flat panel display's INPUT 5, INPUT 6, INPUT 7, INPUT 8 are HDMI terminals for incoming digital video signals. The flat panel display supports KURO LINK functions so that when a piece of equipment is connected, the panel can control the equipment. To use an HDMI terminal, specify the video signal types being sent from the connected equipment. For signal types, see the operating manual(s) that came with the equipment.

One of the benefits of using your flat panel display to control other equipment is the support of Deep Color. Deep Color is the color depth that describes the number of bits used to represent the color of a single pixel in a bitmapped image. Besides the conventional RGB/YCbCr16bit/20bit/24bit signals, the flat panel display also supports RGB/YCbCr30bit/36bit signals. This feature enables finer color reproduction when connecting a device that supports Deep Color signals (HDMI1.3 Deep Color). The color depth appears on the InfoBanner if a program supports Deep Color. With INPUT 5 through INPUT 8 selected, the color depth also appears on the Display screen.

When connecting a PC to one of the panel's HDMI inputs, use an HDMI-compliant PC or video card. For a PC or AV equipment that has a DVI output terminal, use INPUT 4 on your flat panel display. In this case, use only a DVI-D24 (digital) for connections (see page 17).

6.3.1 Enter an HDMI Input Name

To enter an input name for each piece of equipment connected through HDMI, follow the directions below.

- 1) Select the Input for the connected equipment.
*Press the **INPUT** button (remote control or panel) until the correct input is showing (INPUT 5, INPUT 6, INPUT 7, or INPUT 8).*
- 2) Access *Input Setup 2/2* through the *Input Setup* menu.

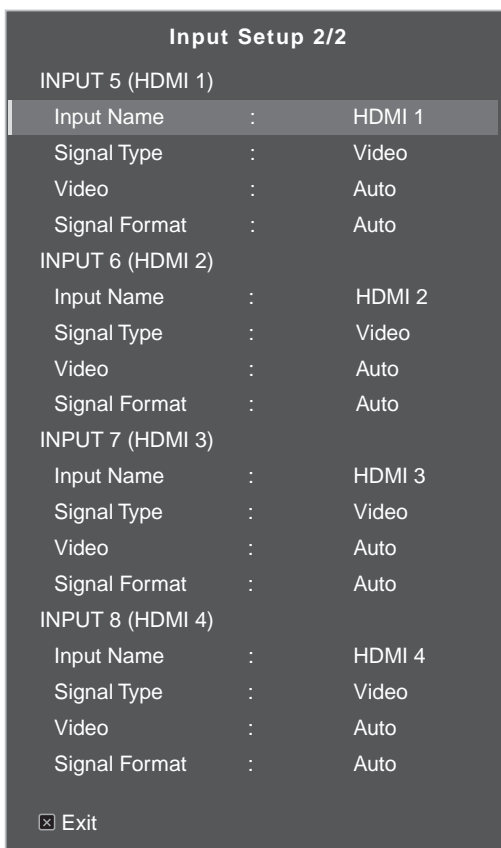

- 3) Select *INPUT 5(HDMI 1)*, *INPUT 6(HDMI 2)*, *INPUT 7(HDMI 3)* or *INPUT 8(HDMI 4)*.
- 4) Select *HDMI 1* through *HDMI 4*, *Blu-Ray*, *DVD*, *DVR*, *VCR*, *Cable*, *Satellite*, *GAME* or *Computer*.
- 5) Press **EXIT** to close the menu.

6.3.2 Specify the HDMI Input Type

To select a signal type, follow the steps below.

- 1) Select the Input for the connected equipment.
*Press the **INPUT** button (remote control or panel) until the correct input is showing (INPUT 5, INPUT 6, INPUT 7, or INPUT 8).*
- 2) Access *Input Setup 2/2* through the *Input Setup* menu.
- 3) Select *INPUT 5(HDMI 1)*, *INPUT 6(HDMI 2)*, *INPUT 7(HDMI 3)* or *INPUT 8(HDMI 4)*.
- 4) Select *Signal Type* from the submenu.
- 5) Select the appropriate option.

Option	Description
Video	use except when a PC is connected (default)
PC	when a PC is connected to HDMI input terminal

- 6) Press **EXIT** to exit the menu.

In Video mode, the image is over-scanned (enlarged) but the panel automatically switches to PC when receiving computer signals. In PC mode, the image displays in full size for optimum image quality.

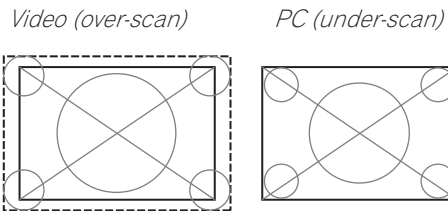

6.3.3 Specify a Digital HDMI Signal Type

For the correct digital video signal type, check the operating manual that came with the other equipment.

To assign the type of digital signal, follow the steps below.

- 1) Access *Input Setup 2/2* through the *Input Setup* menu.
- 2) Select *INPUT 5(HDMI 1)*, *INPUT 6(HDMI 2)*, *INPUT 7(HDMI 3)* or *INPUT 8(HDMI 4)*.
- 3) Select *Video* from the submenu.
- 4) Select the type of digital video signal recommended for the attached device.

Type	Description
Auto	automatically identifies input digital signals
1 (YUV422)	Digital Component Video signals (4:2:2) locked
2 (YUV444)	Digital Component Video signals (4:4:4) locked
3 (RGB16-235)	Digital RGB signals (16 to 235) locked
4 (RGB0-255)	Digital RGB signals (0 to 255) locked

- 5) Press **EXIT** to close the menu.

If an image fails to appear, specify another digital video signal type. Type parameters other than Auto need to be checked for natural colorings.

6.4 Control Equipment with the Panel's Remote Through HDMI

Your flat panel display's remote can control other equipment such as a Pioneer AV system, or BD/DVD player that supports the KURO LINK or HDMI Control functions featured in conventional Pioneer products. The KURO LINK functions include playback of content using an on-screen control panel. However, not all device operations may be available through KURO LINK. For details, see the charts below.

Control Function	Controlled Equipment	Function Description
Playback of content	Recorder Player	Pressing PLAY automatically selects the source and begins playback
On-screen control	Recorder Player	Recorder/player operation controlled on-screen or with the panel's remote (play, stop, fast forward/reverse, etc.)
Display Language Setup	Recorder Player	Information on the display menu language transfers to the recorder or player (for details, see the operation manual that came with the device)
AV system control	AV system	Receiver/amplifier operation also controlled with the panel's remote (input through the HDMI port)
Power ON	Recorder Player	Panel turns On when a connected device is turned On and sends images to the panel
Power OFF	Recorder Player AV system	Connected device(s) turn Off when the panel is turned Off

Note: Except for Power OFF and Display Language Setup functions, only a single HDMI terminal may be active at a time.

The flat panel display's remote can control a maximum of two (2) recorders, two (2) playback devices, and one (1) AV system at a time.

To select and use the various KURO LINK functions for a connected Pioneer AV system, recorder, or player, use the panel's KURO LINK menu.

To access the KURO LINK menu, follow the steps below.

- 1) Press **USER MENU** on the remote.
- 2) Select *KURO LINK* from the main menu.
Use the arrow buttons to highlight an option then press **ENTER**.

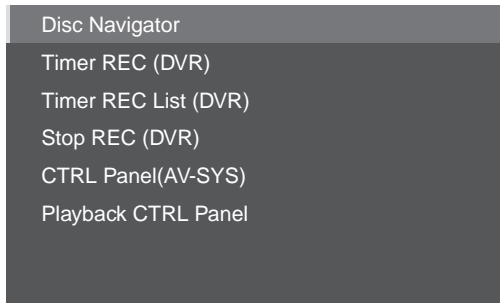

Note: Pressing **KURO LINK** on the remote also causes the *KURO LINK* menu to open.

Option	Description
Disc Navigator	displays the player's or recorder's title list
Timer REC (DVR)	displays the recorder's program guide
Timer REC List (DVR)	displays the recorder's timer recording list
Stop REC (DVR)	stops the recorder from recording
CTRL Panel (AV-SYS)	displays the AV system's control panel
Playback CTRL Panel	displays the player's or recorder's control panel

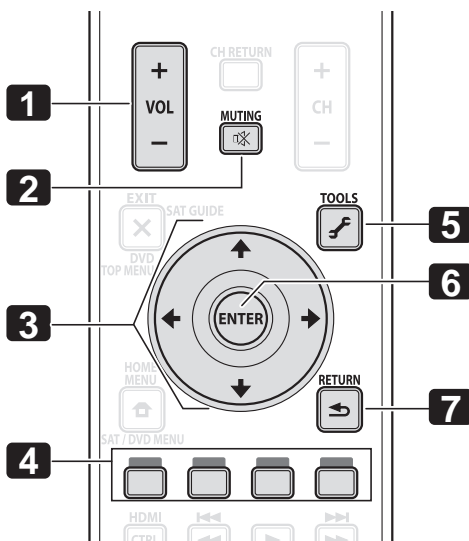

Use the following buttons to control functions such as disc navigation on a recorder or player.

- **1** VOL +/-
(adjusts the volume for an AV system)
- **2** MUTING
(turns off the sound while the video continues to play)
- **3** Arrow buttons
(navigates the menu screen)
- **4** Color buttons (Red, Green, Blue, Yellow)
(controls a BD player)
- **5** TOOLS
(assigns the code for a Pioneer BD player)
- **6** ENTER
(activates the selected function)
- **7** RETURN
(returns to the previous menu screen)

To connect a device for KURO LINK, follow the steps below.

- 1) Turn on the flat panel display and all other equipment.
- 2) Confirm that the panel's Input Setting for KURO LINK Setting options comply with directions in the device(s)' operating instructions.
- 3) Confirm that the other equipment is set for KURO LINK.
- 4) Check that the audio and video are playing back properly from the equipment connected through the HDMI terminal(s).
- 5) Turn Off the flat panel display.
- 6) Pause for a few seconds before turning the panel back on.
- 7) Verify that all equipment is functioning properly.

To select the device to control via KURO LINK, follow the steps below.

- 1) Access *KURO LINK Setting* through the *Control Setup* menu.
- 2) Select *Input Setting* from the submenu.

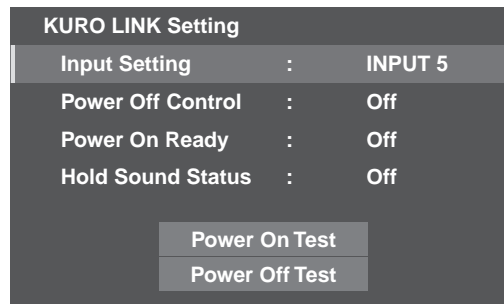

- 3) Select the desired Input (INPUT 5, INPUT 6, INPUT 7, or INPUT 8).
- 4) Press **EXIT** to exit the menu.

If operating an HDMI-supported device using an HDMI port other than the terminal selected in Input Setting, the system malfunctions. When connecting to an HDMI terminal other than that selected in Input Setting, the equipment settings should block KURO LINK functions. The KURO LINK menu is not selectable when the option Input Setting under the KURO LINK Setting menu is set to Off.

The control menu changes to suit the type of HDMI-compatible equipment. When adding, changing, or removing equipment from KURO LINK, refer to the sections below for installation notes and the supported commands.

6.4.1 Control an AV System

When adding an AV System, connect the unit between the panel and any recorders and/or players. To function properly, your Audio/Video system manages the KURO LINK functions between the panel and any other connected equipment.

During playback, use the remote control's up/down arrows (↑/↓) to cycle through the surround sound options. Use the left/right arrows (←/→) to change the input. To resume playback, return to the KURO LINK menu then select the function again.

AV Systems

- 1 Cycles the surround mode in sequence
- 2 Switches the input source in reverse order
- 3 Switches the surround mode in reverse order
- 4 Closes the screen to return to KURO LINK menu
- 5 Lists the connected equipment (model number/up to eight characters)
- 6 Switches the input source in sequence
- 7 Reserved/Void

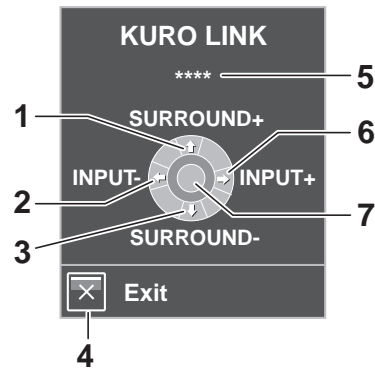

6.4.2 Control a Recorder

Press **ENTER** to start playback or press **KURO LINK** to return to the menu. This process also applies to Players. Refer to the chart below for available commands.

Recorders

- 1 Skips commercials
- 2 Fast reverse
- 3 Stops playback
- 4 Closes the screen to return to KURO LINK menu
- 5 Lists the connected equipment (model number/up to eight characters)
- 6 Fast forward
- 7 Starts playback

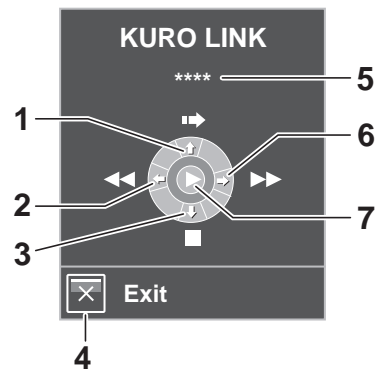

Note: You can also use ► (Play), ■ (Stop), || (Pause), ►► (Fast Forward) and ◀◀ (Fast Reverse) on the remote control to conduct the same operations as the control menu buttons.

6.4.3 Control a Player

Press **ENTER** to start playback or press **KURO LINK** to return to the menu. This process also applies to Recorders. Refer to the chart below for available commands.

Players

- 1 Displays the DVD/Blu-ray disc menu on the player
- 2 Fast reverse
- 3 Stops playback
- 4 Closes the screen to return to KURO LINK menu
- 5 Lists the connected equipment (model number/up to eight characters)
- 6 Fast forward
- 7 Starts playback

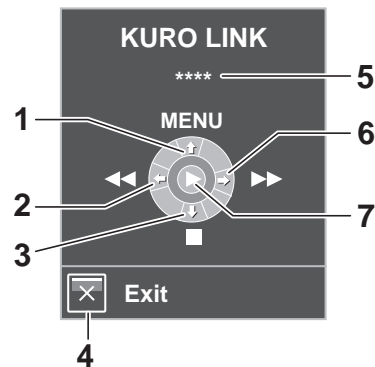

Note: You can also use ► (Play), ■ (Stop), || (Pause), ►► (Fast Forward) and ◀◀ (Fast Reverse) on the remote control to conduct the same operations as the control menu buttons.

6.4.4 Add an AV Amp or a BD Player

To add an AV amp and/or a BD Player, refer to the appropriate cabling diagram below.

AV Amp & BD Player

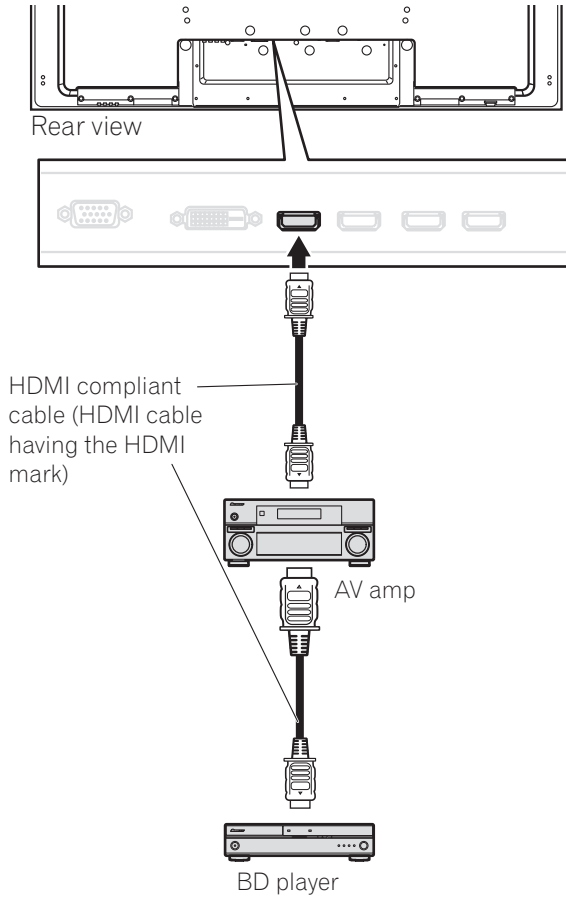

BD Player only

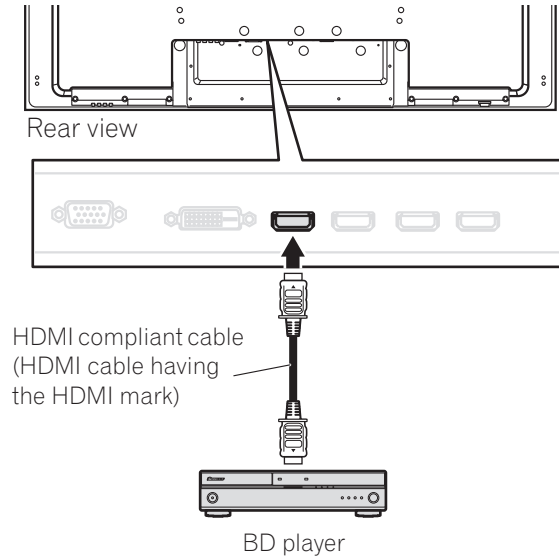

6.5 Specific KURO LINK Commands

When using HDMI equipment with your flat panel display, some options include when to power the panel and ways to turn other devices or features On and Off. This section provides steps for commonly desired changes.

6.5.1 Play Source Sound Using an HDMI Command

When sound is coming from a Pioneer AV System through the flat panel display, placing the panel in Standby causes the sound to stop. To have the sound continue when the flat panel display turns On, follow the steps below.

- 1) Access *KURO LINK Setting* through the *Control Setup* menu.
- 2) Select *Hold Sound Status* from the submenu.
- 3) Select *On* to allow sound from an AV System to play when the panel is in Standby.
- 4) Press **EXIT** to exit the menu.

6.5.2 Turn OFF the Power With an HDMI Command

The "Power Off Control" function is valid for the devices connected to any of the panel's HDMI ports. To power off a connected device when the flat panel display is turned Off, follow the steps below.

- 1) Access *KURO LINK Setting* through the *Control Setup* menu.
- 2) Select *Power Off Control* from the submenu.
- 3) Select *On* to allow the panel to power off the connected equipment.
- 4) Press **EXIT** to exit the menu.

6.5.3 Turn ON the Power With an HDMI Command

The panel ships from the factory with the Power On command activated. If this feature is turned off in error, it can be reactivated. To power on the flat panel display automatically when a connected Pioneer recorder or player is turned On (images are sent), follow the steps below.

- 1) Access *KURO LINK Setting* through the *Control Setup* menu.
- 2) Select *Power On Ready* from the submenu.
- 3) Select *On* to have another device power-on the panel.
- 4) Press **EXIT** to exit the menu.

6.5.4 Test the Power Control (On/Off)

Your flat panel display provides the KURO LINK option to test whether equipment connected to the panel via an HDMI port can power up. Each device must be properly assigned to an Input for this function to perform.

To confirm that the Power On/Off control function is working, follow the steps below.

- 1) Access *KURO LINK Setting* through the *Control Setup* menu.
- 2) Select a test option (*Power On Test* or *Power Off Test*) from the submenu.
A list containing all HDMI connected equipment appears.
- 3) Select a piece of equipment from the list to begin the test.
- 4) Repeat this process to test other equipment from the list.
- 5) Press **EXIT** to exit the menu when all testing is complete.

If the Power On/Off Test fails, check the connection points and the settings.

6.6 Connect a Game Console or Camcorder

Your flat panel display supplies direct connections for a game console, camcorder, or other Audio/Visual (AV) equipment through INPUT 1. To watch an image coming from a game console or camcorder, press **INPUT 1** on the remote control or repeatedly press **INPUT** on the panel to select INPUT 1. For details on game console settings, refer to "2.3 Connect to Other Devices (DVR, Receiver, BDR, etc.)" and to "5.1.4 Set the Panel to Recognize a Game Console."

Use the connection type specified by the equipment. Connect equipment only to terminals that are actually to be used.

6.7 Use the IR REPEATER OUT

Connecting control cables between the flat panel display and other Pioneer equipment allows you to operate the connected equipment via commands from the remote control.

This function is helpful when controlling Pioneer equipment from other Pioneer equipment.

6.8 Connect to a Network

Connecting your flat panel display to a home network or local area network (LAN) causes the panel to function as a server. To run the panel on a network, see the diagram below for connections. After connection to a network, apply initial settings described in the following sections.

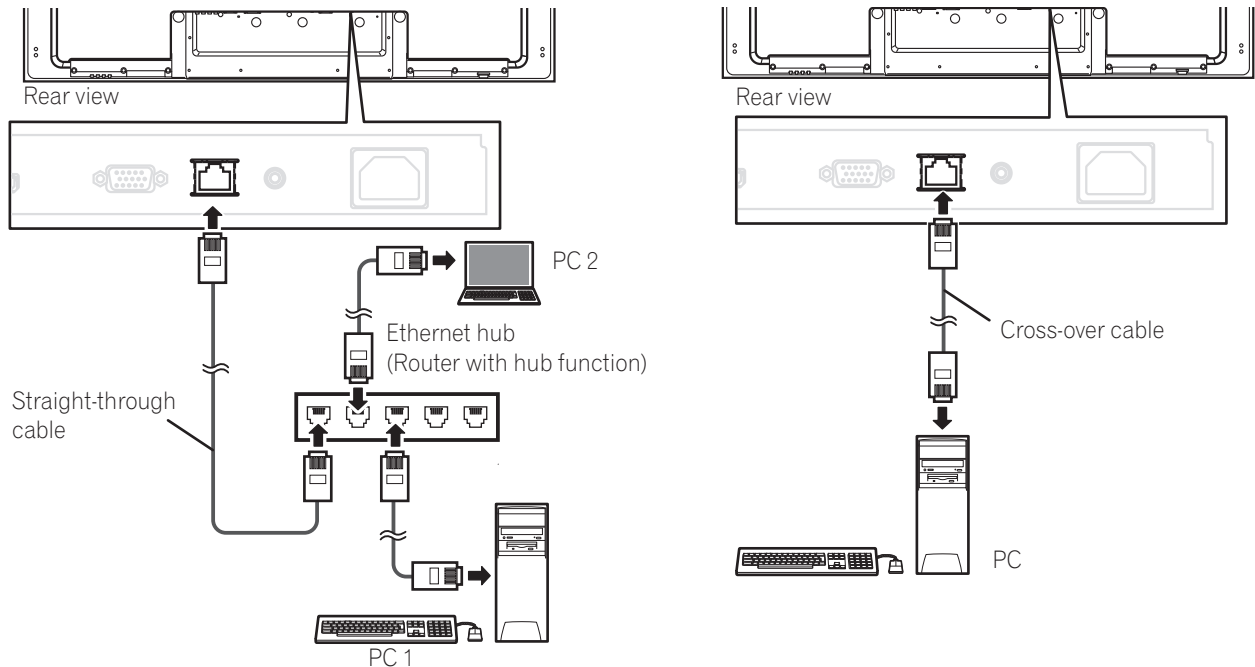

Caution:

- With the flat panel display, browsing Internet websites and sending/receiving E-mails are unavailable.
- Broadcasts and on-line video services via the Internet are unavailable.
- Purchase commercially available connection devices and cables as needed.
- Combining different communication brand tools with some service providers, or different modem and broadband router brands may cause communication failures or require additional services from your service provider.
- Connecting to a network may require additional settings on your PC.
- After connection to a network, enter correct settings.
- Pioneer is not responsible for any damage due to erroneous operations or unsuccessful E-mail transmissions.

Using a LAN

- Use 10BASE-T or 100BASE-TX for a broadband router or hub.
- Do not connect your flat panel display directly to the Internet. Connect the panel through a Firewall, leaving only necessary ports open.
- Do not connect a modular telephone cable to the LAN (10BASE-T/100BASE-TX) terminal. Doing so can cause a malfunction.
- Required equipment and connection methods may differ, depending on the communication and/or service provider.
 - Use devices such as an ADSL modem, broadband router, hub and splitter as specified by the communication and/or service provider. Also refer to the instruction manual that came with the device.
 - Settings are unavailable for a broadband router or an ADSL modem with a broadband router function.
- When communicating through a LAN, data encryption is unavailable through your panel. When accessing the Internet, run the display on a virtual private network (VPN) or other protected communication network environment.
- Do not send a command to both the RS-232C and LAN terminals at the same time. Doing so can cause the display to receive the command erroneously.

About ADSL Modems

- Utilizing bridging for an ADSL modem requires a separate broadband router.
- For details on an ADSL modem, consult your communication and/or service provider.

6.8.1 IP Control Setting

To apply the IP Control Setting, follow the directions below.

- 1) Access *IP Control Setting* through the *Control Setup* menu.

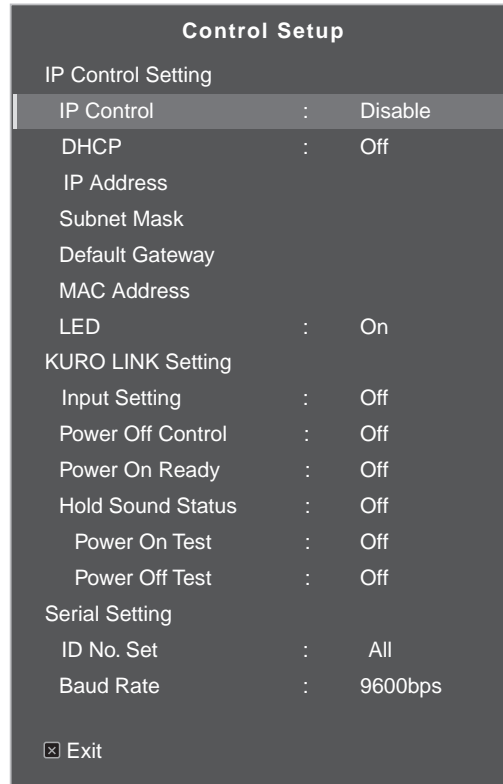

- 2) Select *IP Control* from the *IP Control Setting* menu.
- 3) Select *Enable* from the *IP Control* menu.

Note: The default IP Control menu is Disable.

Confirm the IP Address

Enter DHCP, IP Address, Subnet Mask, Default Gateway and LED.

- 1) Access *IP Control Setting* through the *Control Setup* menu.
- 2) Select *DHCP* from the *IP Control Setting* menu.
- 3) Select *On* or *Off* from the submenu.
If you select On, an IP Address is automatically acquired.

If the panel fails to assign the IP Address or if you want to obtain different addresses, select Off in Step 3 then enter an IP Address and Subnet Mask.

- 4) Press **RETURN** to make your selection.
- 5) Select *LED* from the *IP Control Setting* menu.
- 6) Select *On* or *Off* from the submenu.
Selecting On causes the LAN terminal indicator to light while in use.
- 7) Press **EXIT** to exit the menu.

6.8.2 Use the Web Control System

You can access and control the panel from the PC using a web browser. To use this option, follow the directions below.

- For browsing, use the Internet Explorer. Using any other web browser can cause a distorted image or imperfect contents to appear.
- From the Internet Explorer "Tools" menu, click "Internet Options" to open the General tab. Click "Settings..." in the "Temporary Internet Files" section to select "Every time you start Internet Explorer" under "Check for newer versions of stored pages:".

Display Settings

When switching browser screens, find the needed screen from the list on the left. Do not use browser buttons and menus, such as Previous Page, Next Page, History and Bookmark. Using these buttons and menus to switch the screens causes an imperfect screen to appear. To select a browser, follow the steps below.

- 1) Enter the obtained IP Address in the browser's address box.
- 2) Enter "admin" on the password entry screen.
- 3) Click *Network* to begin entering settings.

- 4) Enter information in the following fields:
 - NAME
 - Location
 - Installation date
 - LED (On/Off)

Note: To change entries other than NAME, Location and Installation date, close the browser then re-open it. To change entries for IP Address, Subnet Mask or Default Gateway, close the browser, change the PC network settings then re-open it.

“Virtual” Remote Control Settings

- 1) Enter your IP Address in the browser’s address box.
- 2) Enter “admin” on the password entry screen.
The Virtual Remote Control appears on screen.
- 3) Click the desired button to execute a command.

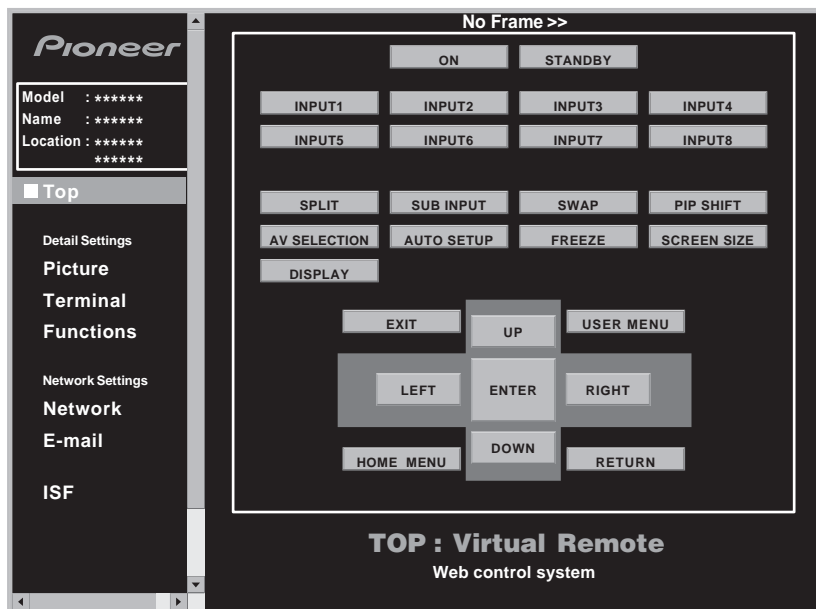
**Picture Adjustments**

Click *Picture* to display the picture adjustment screen.

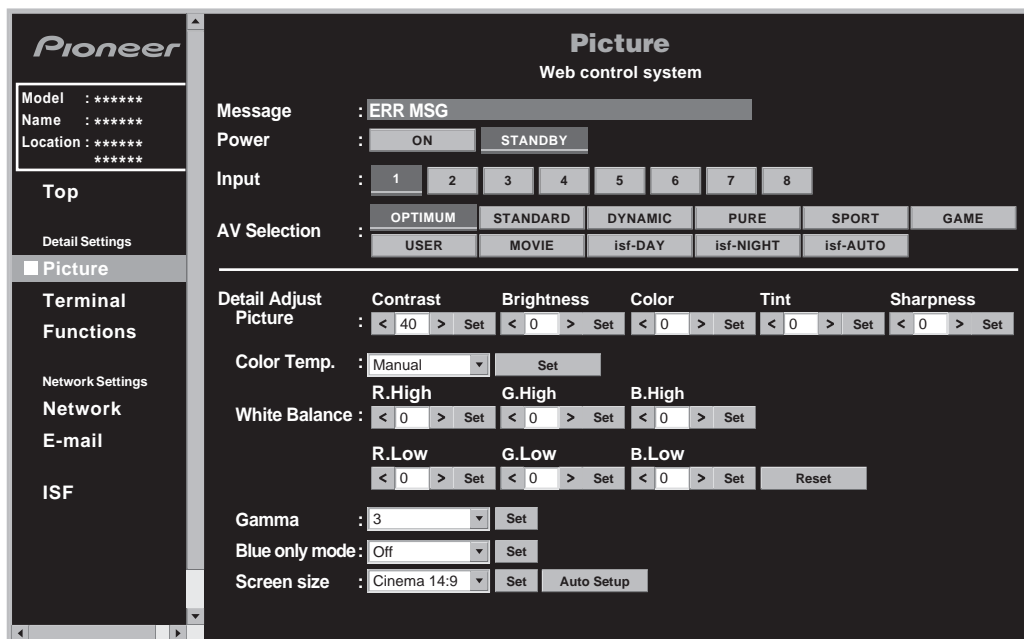

Note: While operating on the web screen, using the remote or buttons on the flat panel display to directly control the panel can cause the operational status on the web screen to differ from the panel status. To find the needed screen on the panel, select the appropriate menu on the left.

Input Setting

Click *Terminal* to display the input setting screen.

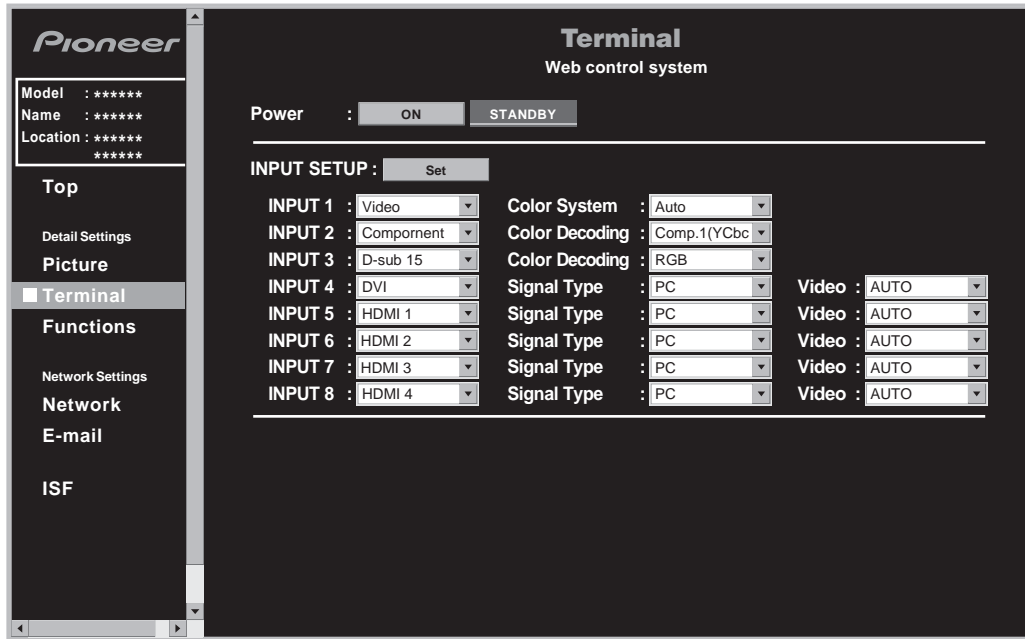

Note: While operating on the web screen, using the remote or buttons on the flat panel display to directly control the panel can cause the operational status on the web screen to differ from the panel status. To find the needed screen on the panel, select the appropriate menu on the left.

Function Setting

Click *Functions* to display the function setting screen.

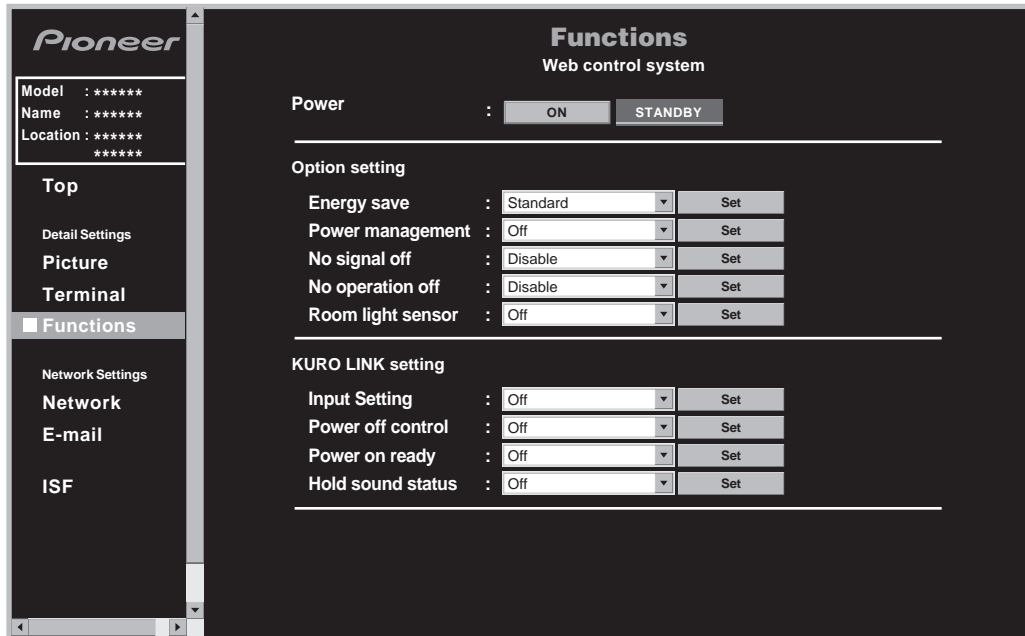

Note: While operating on the web screen, using the remote or buttons on the flat panel display to directly control the panel can cause the operational status on the web screen to differ from the panel status. To find the needed screen on the panel, select the appropriate menu on the left.

Event Notification

Your flat panel display can provide E-mail notification if there is a system error or malfunction.

Option	Description
Sender address	enters the sender's address
Mail server (SMTP)	enters the sender server's IP address
Authentication	sets whether to authenticate when sending an E-mail (Pop before SMTP is set for the authentication method)
ID	enters an authentication ID
Password	enters a password for authentication
Received address (1) - (3)	enters the recipient address
Event option	
Power down	sends an E-mail when the fail-safe function is activated due to a panel error that may cause a malfunction
Shut down	sends an E-mail when the protection function turns the panel off automatically
Usage time	sends an E-mail at a specified interval (every 500 hours if set to "500")
Input change	sends an E-mail when the input mode changes
Loss of input signal	sends an E-mail when no input signal appears
Power toggle	sends an E-mail when the power status changes

Note: Your flat panel display does not have a function that determines the name of network computer within the Internet. Enter your mail server's IP Address in the Mail server (SMTP) box. If the IP Address is now known, use such a search program as the "nslookup" on your PC.

Sample MS-DOS search screen using "nslookup"

```

C:\> nslookup
Server:    xxx.xxx.xxx.com ← Current name server
Address:  yyy.yyy.yyy.yyy
> mailsv.aaa.com
Server:    xxx.xxx.xxx.com ← Current name server
Address:  yyy.yyy.yyy.yyy

Non-authoritative answer:
Name:     mailsv.aaa.com
Address:  zzz.zzz.zzz.zzz ← Server: IP Address for mailsv.aaa.com
    
```

6.9 Assign a Serial Number

6.9.1 Assign an ID Number

This section describes how to enter the required ID number for controlling and adjusting multiple panels through a single PC. To assign the ID Number, follow the directions below.

- 1) Access *Serial Setting* through the *Control Setup* menu.
- 2) Select *ID No. Set* from the *Serial Setting* menu.

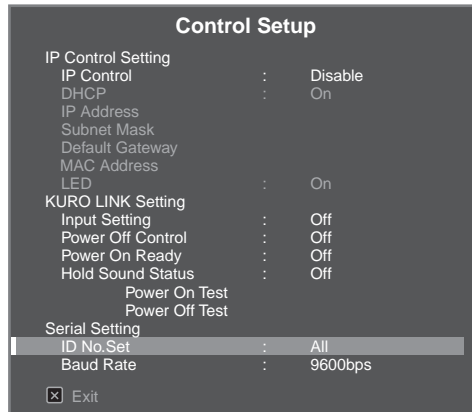

- 3) Select *All* or *00H-FFH* from the submenu.



Parameter	Description
00H-FFH	sets an ID Number
All	does not set an ID Number

Note: This setting applies to all input sources.

6.9.2 Assign a Baud Rate

This section describes how to enter the RS-232C transmission speed (baud rate) when controlling or adjusting the panel using a PC. (Use this option only when making picture adjustments for a specific device(s) connected to the RS-232C terminal.) The baud rate can be set to 1200bps, 2400bps, 4800bps, 9600bps, 19200bps or 38400bps. To enter a rate, follow the directions below.

- 1) Access *Serial Setting* through the *Control Setup* menu.
- 2) Select *Baud Rate* from the *Serial Setting* menu.
- 3) Select the desired rate from the submenu.
The factory default setting is 9600bps.

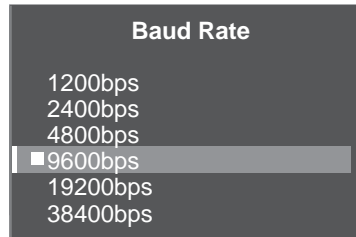

Note: This setting applies to all input sources.

6.10 Select the Integrator Mode

Integrator Mode provides alternative options when using specific functions/settings and picture adjustment menus.

Notes: Integrator Mode is only available in English.

After entering the Integrator Mode, the following options on the Home Menu are reset to the factory defaults:

- *Picture*
- *Screen*

After entering the Integrator Mode, the following options remain unchanged:

- *Power Control*
- *Option*
- *Input Setup*
- *Control Setup*

To switch to the Integrator Mode, follow the directions below.

- 1) Press **INPUT** to select the desired input.
- 2) Press **DISPLAY** to reveal current settings.
Status information on the selected input appears on screen.

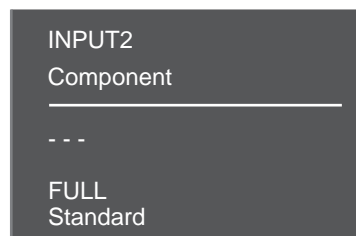

- 3) Press and hold **DISPLAY** for at least three seconds while the screen in Step 2 remains visible.
Only input signals appear.



- 4) Press **HOME MENU** while the screen in Step 3 remains visible but do not hold the button down.
The panel switches to Integrator Mode.

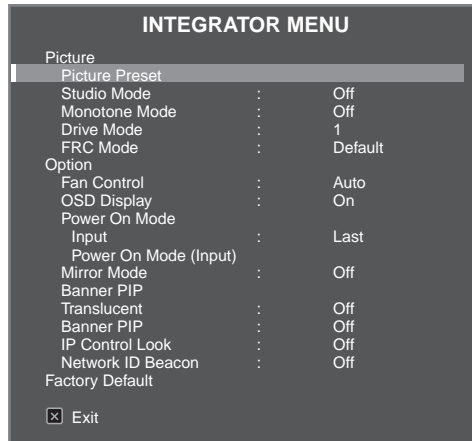

*Note: Pressing and holding or pressing **HOME MENU** long causes the panel to remain in User Mode.*

6.10.1 Explore the Integrator Mode Menus

Picture Preset

Use this option to preset the Picture adjustment values for the Home Menu.

Studio Mode

In addition to normal adjustment values, the panel also provides a separate professional adjustment mode optimum for retake at a TV studio (Studio).

Parameter	Description
On	switches to the Studio Mode
Off*	No effect

*Factory default

Notes: This setting applies to all input sources.

Entering Monotone Mode, AV Selection or Blue Only Mode is unavailable while in Studio Mode.

Monotone Mode

Monotone Mode cuts the video signal's color components so that images appear using only luminance signals.

Parameter	Description
On	switches to the Monotone Mode
Off*	No effect

*Factory default

Notes: This setting applies to all input sources.

Entering Studio Mode, AV Selection or Picture Preset is unavailable while in Monotone Mode.

Drive Mode

This option optimizes the picture quality depending on the content (refer to “5.3.10 Adjust Color Signals” for more information).

Note: Drive Mode is available only for input video signals.

FRC Mode

The FRC option allows switching the frame rate conversion.

Parameter	Description
Default*	does not switch the frame rate conversion
Sync	switches the frame rate conversion

*Factory default

Note: FRC Mode is available only for input PC signals.

Fan Control

This option switches the control method for the rear cooling fan of the flat panel display.

Parameter	Description
Auto*	automatically controls using an internal temperature sensor
Max	for maximum rpm (Auto Control: Off)

*Factory default

The Max setting is effective for special high-temperature installations. However, since the fan noise increases, the effect on the surrounding area should be taken into consideration.

On-screen Display

This option sets the menu display to On or Off.

Parameter	Description
On*	displays the current menu when pressing DISPLAY
Off	does not display the screen when: <ul style="list-style-type: none"> • pressing DISPLAY or AV SELECTION • switching the input source • adjusting the volume (Screen components such as Home Menu, User Menu and messages remain on the screen even when setting the On-screen Display option to Off.)

*Factory default

Note: This setting applies to all input sources.

Power On Mode

This option automatically selects the input when the panel is turned On.

Parameter	Description
INPUT 1 through INPUT 8	displays the selected input
Last*	displays the last input selected

*Factory default

Note: This setting applies to all input sources.

Mirror Mode

This option reverses the image displayed on the screen.

Parameter	Description
On	reverses the image
Off*	does not reverse the image

*Factory default

Note: This setting applies to all input sources.

Banner PIP

Use the Banner PIP option to adjust the translucence rate and display positions of the small window in P-in-P mode.

- Translucent: adjusts the translucent rate of the small screen in P-in-P mode between Off and 80%. If the percentage increases, the translucent rate also increases.
- Banner PIP: adjusts the display positions of the small screen in P-in-P mode
- Banner Input: determines the input signal for the small window in P-in-P mode

Parameter	Description	
Translucent	On	adjusts the translucent rate
	Off*	No effect
Banner PIP	Off*	No effect
	Bottom 1 through 3	adjusts display positions
	Mid Low/High	
	Top 1 through 3	
Banner Input	INPUT 3* through 8	determines the input signal

*Factory default

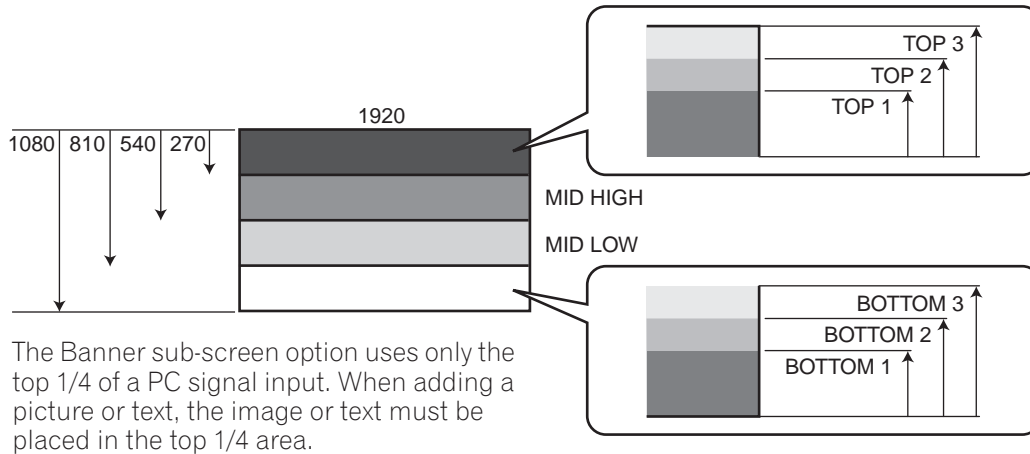

Note: The higher the resolution becomes on the main screen image, the lower the contrast becomes on the small window image.

Signals that support Banner PIP are XGA 60 Hz and WXGA 60 Hz.

IP Control Lock

This locks or unlocks the IP Control settings.

Parameter	Description
On	locks the IP Control settings
Off*	No effect

*Factory default

Note: This setting applies to all input sources.

Network ID Beacon

This option authenticates the connection between the specified equipment and the flat panel display.

Parameter	Description
On	applies the Network ID Beacon
Off*	No effect

*Factory default

7 Helpful Information

This chapter includes answers to some common questions and provides cautions and warnings for both panel installation and usage. If you need further assistance, please contact us and give us the chance to correct any issues you are experiencing. Thank you again for buying Pioneer!

7.1 Frequently Asked Questions (FAQs)

This section answers some of the questions received by our Support staff members. If your question is not here or you would like more information please see the Pioneer website for more FAQs (www.pioneerelectronics.com) about your specific model or our flat panel displays in general.

Why won't the remote control buttons control my flat panel display?

If you select a mode other than MONITOR on the remote control, your flat panel display cannot receive the commands. Press the **SELECT** button to toggle the modes until the MONITOR indicator lights.

Why do I have to move closer to the panel to use the remote control?

Weak batteries in the remote control can cause communication to fail. Try moving closer to the panel and attempt to control the panel with the remote. If the panel responds then change the batteries. If moving closer has no effect on the panel, check the surroundings for objects that might be blocking the signal. Also consider if other equipment that use remote controls have been added to the area around the panel. Objects and other IR signals can disrupt the remote.

How can I protect the remote so it holds up longer?

There are several ways to protect your remote control. Do not leave the remote sitting in direct sunlight as this can warp or deform the case. Avoid spilling liquids on the remote but if this happens, dry it immediately. If necessary, remove the batteries and allow the unit to dry completely before attempting to use it again. Areas with high humidity can also cause damage.

Another issue that can affect the remote control is a leaking battery. The chemicals from a leaky battery can discolor or damage the remote. If there is visible leakage in a battery, remove both batteries immediately and carefully wipe the battery compartment clean. Replace both batteries with fresh ones.

Can the signal from my panel's remote mess up other audio/video equipment?

The flat panel display emits very weak infrared rays from its screen. If there is other equipment close by that also uses a remote control such as a DVR or stereo system, it may not receive commands from its remote control properly. Try moving the equipment farther away from the flat panel display.

Note: The strength of infrared rays emitted from the panel differs as the picture changes on the screen.

Why does the picture seem to dim when I leave a picture on the screen?

When still images (such as photos and computer images) stay on the screen for an extended period of time, the screen slightly dims. This function protects the panel from damage by automatically adjusting the screen brightness. The screen dims when a still image is detected for approximately three minutes.

Why won't my Pioneer flat panel display turn on?

It may be that your remote has failing batteries or has been damaged. Check the power cord connection at the wall and on the back of the panel. Also try pressing  on you panel.

Why does the blue power light on my flat panel display blink?

The panel's internal protection circuit may have been activated for some reason. First turn the panel's  off, wait one (1) or more minutes, then turn it back on. If the light still blinks, unplug the power cord from the outlet. Plug in the panel again after one to two minutes. If this fails to solve the problem, contact your dealer or Pioneer Customer Support (see back cover).

What can I do to prevent image retention or burn-in?

Burn-in or Image Retention is a side effect of plasma technology. After an image remains on the display for an extended time period, when the image changes or the unit is turned off, a faint afterimage or ghost of the original picture may remain. Continuing to play video or leaving the unit turned off for a length of time can clear the afterimage. We recommend the following steps and settings to prevent image retention or burn-in.

- Set Long Life Settings to *On*.
- Do not leave still images on screen.

How do I clean my flat panel display?

To clean the screen surface, gently wipe it with the supplied dry cloth. Rubbing hard on the screen can scratch the special film coating. Use a clean soft cloth (cotton or flannel, for example) for the cabinet. For details on cleaning, refer to "7.2 Cleaning Methods."

7.2 Cleaning Methods

Before cleaning your flat panel display, unplug the power cord from the outlet.

When cleaning the screen or the glossy front bezel, gently wipe with a clean, dry cloth such as the supplied cleaning cloth or a similar type of soft cloth (e.g., cotton, flannel, etc.). Avoid a wet or damp cloth as that can let moisture seep into the panel. A dusty or rough-textured cloth (or if you rub too hard), can scratch surfaces.

Note: Do not use liquid cleaners or aerosol cleaners on the screen.

The chassis or cabinet of the panel is mostly composed of plastic. Do not use chemicals such as benzene or paint thinner to clean the cabinet. These chemicals can mar the finish or cause other deterioration. When cleaning the cabinet, use the same type of cloth and method as described for the front bezel.

Note: Do not affix labels, tapes, etc. to any visible location on the flat panel display. Adhesives can discolor or mar the panel surfaces.

7.3 Troubleshooting & Service Information

General	
Issue	Possible Solutions
No power	<ul style="list-style-type: none"> • Check the connection seating at the wall and panel. • See if the panel's main power switch is turned ON. • Confirm that the remote is set to MONITOR. <i>If the panel indicator lights red, press MONITOR (⏻) on the remote control or the STANDBY/ON button on the flat panel display.</i>
Power suddenly turns off	<ul style="list-style-type: none"> • Check the power control setting. • See if the panel's internal temperature has increased. <i>Clean the vents or remove any blocking objects.</i>
Panel does not operate	<ul style="list-style-type: none"> • External influences such as voltage malfunction, static electricity, etc., may cause improper operation. <i>Unplug the panel from the wall and leave it for two or more minutes. Reconnect and attempt to operate the panel once again.</i>
Remote control does not operate	<ul style="list-style-type: none"> • Check if display power is off. Press the button when the Power On and STANDBY indicators are off. • Confirm that the mode is set to MONITOR. • Examine the remote control sensor on the panel for obstructions that could block the signal. • Check that the remote's batteries are installed properly and hold a change. <i>Replace with new batteries to verify.</i> • Consider changes in lighting such as stronger or new light sources that may wash out the signal.

Picture	
Issue	Possible Solutions
No picture	<ul style="list-style-type: none"> • Check the picture adjustment settings. <i>Reset to default values if necessary.</i> • Confirm that the connected equipment is installed and programmed properly. • If viewing an image from a PC, confirm that the signal is compatible.
Screen appears dark	<ul style="list-style-type: none"> • Check for any obstacles in front of the Room Light Sensor.
Odd coloring and shades or misaligned images	<ul style="list-style-type: none"> • Review the room lighting for recent changes or different natural lighting sources from windows or doorways. • Check the picture tone, adjust as necessary.
Picture is cut off or runs off screen	<ul style="list-style-type: none"> • Check the screen size for the current input source. • Confirm that the position of the picture is centered.
Brightness and color tone on the sides differ from the center	<ul style="list-style-type: none"> • If images in 4:3 mode or letterbox images are displayed for long periods or for shorter periods over several days, an after-image may remain due to burning. <i>Watch images in Full screen as much as possible to avoid this issue.</i> • Change the Brightness Sync. setting to Auto. <i>This function adjusts the brightness of the gray side masks for the brightness of the main image.</i> • Use the Long Life Settings function (see "4.2.1 Extend Your Panel Life")

Picture	
Issue	Possible Solutions
Picture does not appear properly	<ul style="list-style-type: none"> • Check the setting for Color Decoding when using INPUT 2 or INPUT 3 (pages 52 and 53). • Check the setting for Signal Type. • Check the setting for Video when using INPUT 4 through INPUT 8 (page 54). • Check the setting for Signal Format when using INPUT 3 through INPUT 8 (page 54).
After-image lag	<ul style="list-style-type: none"> • If a bright or still image was on screen for a long period before switching to a darker image, the original image may appear as an after-image or ghost. Try playing another bright image, switching the picture quickly many times, or show a very active scene. • Use the Long Life Settings function (see "4.2.1 Extend Your Panel Life") • Display the Video Pattern screen to help reduce after-image lag.

KURO LINK	
Issue	Possible Solutions
KURO LINK does not function	<ul style="list-style-type: none"> • Check the connections between the panel and the HDMI equipment. • Confirm that the settings for the panel are correct. • Confirm that the equipment is HDMI compliant. • Confirm that settings for the equipment are correct. <i>For details, refer to the operating instructions that came with the equipment.</i>
Error message: "The device cannot be operated. Please check connection"	<ul style="list-style-type: none"> • Check the connections between the panel and the HDMI equipment. • Confirm that settings for the equipment are correct. <i>For details, refer to the operating instructions that came with the equipment.</i>
No picture	<ul style="list-style-type: none"> • Check the connections between the panel and the HDMI equipment. • Confirm that settings for the equipment are correct. <i>For details, refer to the operating instructions that came with the equipment.</i>
Panel sounds/noises	<ul style="list-style-type: none"> • Some sounds are appropriate for plasma technology. Examples: fan motor noise, electrical circuit humming, glass panel buzzing, etc.
Brightness on sides of screen are uneven	<ul style="list-style-type: none"> • Display content that completely fills the screen until unevenness is minimized. • Change the AV mode setting.

IP Control	
Issue	Possible Solutions
Web browser screen does not open after entering the correct IP Address	<ul style="list-style-type: none"> • Confirm that the indicator turns on after setting the <i>LED</i> option to On. • Check the cable connection if the indicator does not light. • Confirm that the other end of the cable is properly connected to the PC, hub or router if the indicator does not light.
The indicator lights but the web browser screen does not open	<ul style="list-style-type: none"> • Confirm that the other end of the cable is not connected to any other device than Ethernet (such as a telephone). • When using a DHCP, confirm that the IP Address allocated by the server has not changed (the address may change as a DHCP server reallocates the addresses periodically).
Entering an IP Address fails even after activating the DHCP function	<ul style="list-style-type: none"> • Confirm that the DHCP server is activated within the network.

IP Control	
Issue	Possible Solutions
No list appears on the left of the Web control system screen	<ul style="list-style-type: none"> Restart the browser, enter a URL in the address bar then re-open the initial Web control system screen.

If the information above fails to solve the issue, please contact a Pioneer-authorized service representative. Do not attempt to service the panel yourself. Opening or removing covers exposes you to possible electrical shock and other dangers as well as possibly voiding your warranty. Request a qualified service professional to check your flat panel display.

Some situations that require a service professional are as follows:

- panel dropped or damaged
- power cord or plug damaged
- liquid spilled or an object dropped into the panel
- exposed to rain or water
- noticeable abnormality in panel operation

Occasionally a part within the flat panel display may fail. Verify that your service professional uses only replacement parts specified by Pioneer or by those with the same characteristics and performance as the original parts. Use of unauthorized parts can result in fire, electric shock, or other danger. Upon completion of any service or repair work, request that the service professional perform safety checks to ensure that the product is operating properly.

If you need more assistance or have a Service/Parts-related question, please contact the Pioneer Service organization at (800) 421-1625.

8 Cautions and Warnings

Your flat panel display is designed for a long and productive life. To keep your panel at peak performance, there are a few things that can help. This section provides general information and specific warnings to help you maintain the flat panel display at top quality throughout its lifetime.

Note: If you do not intend to use your flat panel display for an extended period, occasionally power on and run the panel to maintain functionality.

8.1 Installation Details

It is best to use parts and accessories designed by Pioneer. Use of accessories other than the Pioneer stand or installation brackets may result in instability and cause injury. For custom installations, please speak with your dealer or expert installer before attempting to install your high-end flat panel display. These professionals are familiar with proper installation techniques including ventilation.

Using the unit without proper ventilation may cause the internal temperature to rise, resulting in a possible malfunction. When the surrounding environmental or internal temperature exceeds a certain degree, the display automatically powers off in order to cool the internal electronics and prevent a hazardous situation.

A malfunction can be caused by a single issue such as ventilation or by a combination of factors. Pioneer is not responsible for accidents or damage caused by using parts and/or accessories manufactured by other companies, inadequate installation sites, poor stabilization practices, erroneous installation methods, operational mistakes, site remodeling, or natural disasters.

For more installation information, refer to the following bullet points:

- Confirm that panel vents are not partially obstructed or completely blocked.
- Use a vacuum cleaner set to its lowest suction setting to clean dusty vents.
- Distance the panel from the wall, other equipment, etc. (for minimum space requirements, refer to “2.2.1 Check the Location for Suitability”)
- Do not fit the unit inside of narrow spaces where ventilation is poor.
- Do not drape, seat, or enclose the panel in any material such as blankets, loose cloth, or carpeting as this could block the panel vents.
- Use a proper mount or stand rather than leaning the panel against a wall or other support.
- Do not place the product on a rug or blanket.

8.2 Physical Location & Temperature Considerations

Condensation may form on the surface or inside of the display when the panel is moved from a cold place to a warm room or just after a heater or air conditioner is switched on. If condensation forms, do not turn on the flat panel display until all moisture evaporates. Powering on the display when there is condensation may damage the panel or cause a malfunction.

8.3 Usage Guidelines

For maximum enjoyment of your Pioneer flat panel display, read the following information carefully.

Over the course of the flat panel display's lifetime, as with all phosphor-based screens including standard tube-type TVs, the luminosity of the screen diminishes very slowly. Also, static pictures shown over an extended period can adversely affect the screen image. To enjoy bright and beautiful pictures for many years to come, please apply the following guidelines.

- Set the flat panel display to Standby when it is not being used.
- Avoid leaving a still image or frequently showing the same picture on the screen (e.g. closed-captioned images, games with static portions, etc.).
- Hide the On Screen Display (OSD) from a DVD player, VCR, or other device when not in use.
- Do not leave a picture freeze-framed or paused for long periods.
- Avoid showing a picture with very bright and very dark areas on the screen for extended lengths of time.

- Activate the GAME mode on the AV Selection submenu to play a game but try to limit using this mode for more than two hours at a time.
- View full-motion, high-action video in WIDE or FULL screen after playing a game or showing a still/PC image. The recommended duration for showing the action video is three times as long as the game or PC image was on the screen.
- View full-motion video in WIDE or FULL screen after playing content with side, top, or bottom masking (black bars). Extensive viewing of masked content without this recovery process can cause uneven wear on the plasma cells.

8.4 Signal Interference or Noise

Signal interference, also referred to as *video noise* or *white noise*, can be caused by many different situations. The most common are addressed in the following sections.

Infrared rays

The flat panel display releases infrared rays because of the technology's characteristics. Depending on how the flat panel display is used, remote controls for nearby equipment may be adversely affected. Wireless headphones using infrared rays can experience noise interference. If this is the case, move equipment to a location where its remote control sensor is not affected.

Radio Signals

While this flat panel display meets the required specifications, it can affect the signals for surrounding equipment. If your radio, PC, VCR, or other electrical equipment is disrupted by the panel, move the equipment away from the panel.

Flat Panel Display Motor

The screen of the flat panel display is composed of extremely fine pixels that emit light according to received video signals. This principle may cause you to hear a slight buzz or electrical hum coming from the panel. This is a normal sound for the flat panel display and does not indicate a failing unit.

Flat Panel Display Fans

You may hear the sound of a fan motor at times. The slight noise is caused by a cooling fan motor speeding up when the panel's ambient temperature rises. This is a normal function of the panel and is not a malfunction.

8.5 Phosphor Properties

The following are typical effects and characteristics of a phosphor-based matrix display and as such are not covered by the Warranty:

- Permanent residual images upon the phosphors of the panel
- Existence of one or more inactive light cells in small quantity
- Noises generated by fan motors, electrical circuits (hum), panel plates, etc.

8.6 Image Information Including Retention & After-Image Lag

Menu Window Size (after a Video Switch)

Programs may be broadcast in high definition (HD) or standard definition (SD). This flat panel display automatically scales to the appropriate definition type. If the video program's definition type changes while a menu window is on screen (for example: HD to SD or SD to HD) the menu size may temporarily shrink or enlarge until the panel finishes adjusting the picture. Adjusting may happen, for example, when switching between a TV program and playback from a DVR, or when a recorded program switches between different definition types while the menu is showing. The menu returns to its normal size after a couple of seconds. This action is normal and does not indicate a problem with your flat panel display.

Pixel Information

Plasma screens show pictures using pixels. Pioneer flat panel displays contain a very large number of pixels. The size of the panel determines the number of pixels. With the PRO-141FD/PRO-101FD, there are over 6.2 million pixels in the 50"/60" panel. All Pioneer display panels are manufactured using a very high level of ultra-precision technology and undergo individual quality control.

In rare cases, some pixels can be permanently switched off, or on, resulting in either a black or colored pixel permanently fixed on the screen. This effect is common to all plasma displays because it is a consequence of the technology.

8.7 Prevent Burning

After-Image Lag

If an image with very high peak luminance or fixed images such as time of day indicator or channel logs are displayed for more than a minute, after-image lagging may occur due to the remaining electric load. After-Image Lag refers to a ghost of the still image remaining visible after the picture is no longer being shown. This is not a malfunction. The ghost-image remaining on the screen disappears when moving images are shown in full screen.

Image Retention (a.k.a. Burn-In)

If the same image is displayed continuously, or for shorter periods over several days, a permanent after-image may remain on the screen. This after-image is permanent because the fluorescent materials burned. Burned images may fade eventually after playing other video sequences but do not disappear completely. Burn-in tends to occur more easily soon after the product is purchased.

Display Samples Susceptible to Burning

- If 4:3 aspect ratio images are displayed in their original size repeatedly, the screen other than black or gray bars on the left and right, is susceptible to burning.
- If 14:9 or 16:9 letterbox images are displayed in their original size repeatedly, the screen other than black or gray bars at the top and bottom, is susceptible to burning.
- If fixed images such as time of day indicator or channel logos for an extended period or repeatedly, the images are susceptible to burning.
- If static images, such as a fixed image from a PC or a TV game unit, are displayed for longer periods, the images are susceptible to burning.

Avoid Image Retention

To avoid image retention as much as possible, refer to the guidelines below.

- Avoid displaying images susceptible to burning whenever possible.
- Display content in a wide aspect ratio (no black or gray bars on any side of the content). Use the **SCREEN SIZE** button on the remote control to set your flat panel display to a wide-viewing screen mode (WIDE, for example). Refer to "5.2.1 Choose a Screen Size (Automatically or Manually)."
- Select auto screen sizing (page 33) then set the Side Mask detection function to Mode 1 or Mode 2 (page 36).
- Set the Brightness Sync. option to Auto (adjusts the side mask brightness according to the brightness of screen images) when the screen size is 4:3 and Side Mask detection is set to Mode 1 or Mode 2. Refer to "Lighten Side Masks" on page 37. Setting the Energy Save function to Save 1 can further improve the effect (see page 29).
- Leave turning On the Image Orbiter (see page 29).

Long Life Settings

The Long Life Settings option simultaneously optimizes the related settings to guard against image retention. For details, see "4.2.1 Extend Your Panel Life."

Image Orbiter

Another built-in feature to protect against burn-in is the Orbiter function. Orbiter automatically changes the position of the picture imperceptibly while the image is on screen. For more information about the feature, refer to "4.2.4 Turn On the Image Orbiter."

8.8 Safety Precautions

Your flat panel display is engineered and manufactured with one of the highest priorities being safety. However, improper use can result in electric shock and/or fire. To avoid danger please follow the instructions below when installing, operating, and cleaning your flat panel display.

- Read & Retain Instructions - Read all operating and user information provided with your flat panel display.
- Environment - Avoid installing the panel in a location with exposure to large quantities of dust, temperature extremes, high humidity, direct sunlight, or subject to excessive vibrations or impact shock. Also, never pour a liquid or insert an object in to the flat panel display.
- Cleaning - See the section above regarding the proper way to clean your flat panel display.
- Water & Moisture - Avoid operating or positioning your panel close to water or other sources of liquid. Such locations include a bathroom, a kitchen or laundry sink, in a damp basement, by a swimming pool, etc.
- Power - Turn OFF the panel before connecting any other equipment. Operate the panel only from a grounded outlet.

8.9 Legal Notices

8.9.1 Safety

WARNING

This equipment is not waterproof. To prevent a fire or shock hazard, do not place any container filled with liquid near this equipment (such as a vase or flower pot) or expose it to dripping, splashing, rain or moisture.

D3-4-2-1-3_B_En

WARNING: This product equipped with a three-wire grounding (earthed) plug - a plug that has a third (grounding) pin. This plug only fits a grounding-type power outlet. If you are unable to insert the plug into an outlet, contact a licensed electrician to replace the outlet with a properly grounded one. Do not defeat the safety purpose of the grounding plug.

D3-4-2-1-6_A_En

WARNING: To prevent a fire hazard, do not place any naked flame sources (such as a lighted candle) on the equipment.

D3-4-2-1-7a_A_En

VENTILATION CAUTION:

When installing this unit, make sure to leave space around the unit for ventilation to improve heat radiation. For the minimum space required, see page 14.

WARNING: Slots and openings in the cabinet are provided for ventilation to ensure reliable operation of the product, and to protect it from overheating. To prevent fire hazard, the openings should never be blocked or covered with items (such as newspapers, table-cloths, curtains) or by operating the equipment on thick carpet or a bed.

CAUTION: The power switch \odot on this unit will not completely shut off all power from the AC outlet. Since the power cord serves as the main disconnect device for the unit, you will need to unplug it from the AC outlet to shut down all power. Therefore, make sure the unit has been installed so that the power cord can be easily unplugged from the AC outlet in case of an accident. To avoid fire hazard, the power cord should also be unplugged from the AC outlet when left unused for a long period of time (for example, when on vacation).

D3-4-2-2-2a_A_En

Operating Environment

Operating environment temperature and humidity:

+0 °C to +40 °C (+32 °F to +104 °F); less than 85 %RH (cooling vents not blocked)

Do not install this unit in a poorly ventilated area, or in locations exposed to high humidity or direct sunlight (or strong artificial light)

D3-4-2-1-7c_A_En

WARNING:

Do not use or store batteries in direct sunlight or other excessively hot place, such as inside a car or near a heater. This can cause batteries to leak, overheat, explode or catch fire. It can also reduce the life or performance of batteries.

D3-4-2-3-3_En

CAUTION: This PRO-141FD for use only with KRP-TS01 (Pioneer Corporation.) stand. Use with other stands is capable of resulting in instability causing possible injury. This PRO-101FD for use only with KRP-TS02 (Pioneer Corporation.) or KRP-SW01 (Pioneer Corporation.) stand. Use with other stands is capable of resulting in instability causing possible injury.

8.9.2 Radio Interference

Information to User

Alteration or modifications carried out without appropriate authorization may invalidate the user's right to operate the equipment.

D8-10-2_En

[For Canadian model]

This Class B digital apparatus complies with Canadian ICES-003.

D8-10-1-3_En

FEDERAL COMMUNICATIONS COMMISSION DECLARATION OF CONFORMITY

This device complies with part 15 of the FCC Rules. Operation is subject to the following two conditions: (1) This device may not cause harmful interference, and (2) this device must accept any interference received, including interference that may cause undesired operation.

Product Name: Flat Panel Display

Model Number: PRO-141FD/PRO-101FD

Product Category: Class B Personal Computers & Peripherals

Responsible Party Name: PIONEER ELECTRONICS SERVICE, INC.

Address: 1925 E. DOMINGUEZ ST., LONG BEACH, CA 90801-1760, U.S.A.

Phone: 800-421-1625

URL: <http://www.pioneerelectronics.com>

NOTE: This equipment has been tested and found to comply with the limits for a Class B digital device, pursuant to Part 15 of the FCC Rules. These limits are designed to provide reasonable protection against harmful interference in a residential installation. This equipment generates, uses, and can radiate radio frequency energy and, if not installed and used in accordance with the instructions, may cause harmful interference to radio communications. However, there is no guarantee that interference will not occur in a particular installation. If this equipment does cause harmful interference to radio or television reception, which can be determined by turning the equipment off and on, the user is encouraged to try to correct the interference by one or more of the following measures:

- Reorient or relocate the receiving antenna.
- Increase the separation between the equipment and receiver.
- Connect the equipment into an outlet on a circuit different from that to which the receiver is connected.
- Consult the dealer or an experienced radio/TV technician for help.

D8-10-1-2_En

CAUTION: This product satisfies FCC regulations when shielded cables and connectors are used to connect the unit to other equipment. To prevent electromagnetic interference with electric appliances such as radios and televisions, use shielded cables and connectors for connections.

D8-10-3a_En

9 Appendix

9.1 Manufacturer Codes to Program into the Remote Control

9.1.1 Cable

Brand/Code	Brand/Code	Brand/Code	Brand/Code	Brand/Code	Brand/Code
<u>A-Mark</u> 0008, 0144, 0277	<u>Century</u> 0008	<u>Hitachi</u> 0003, 0008	<u>Noos</u> 0817	<u>Prism</u> 0012	<u>Supercable</u> 0276
<u>ABC</u> 0003, 0008, 0237	<u>Daeryung</u> 0008, 0277, 0477, 0877, 1877	<u>Humax</u> 1981	<u>Nova Vision</u> 0008, 0277	<u>Pulsar</u> 0000	<u>Telewest</u> 1068
<u>Accuphase</u> 0003	<u>Digeo</u> 1187	<u>Insight</u> 0476, 0810	<u>Novaplex</u> 0008, 0277	<u>PVP Stereo</u> 0003	<u>Thomson</u> 1981
<u>Acorn</u> 0237	<u>Director</u> 0476	<u>Jerrold</u> 0003, 0012, 0276, 0476, 0810	<u>NSC</u> 0012	<u>Visual Matrix</u> 0000	<u>Time Warner</u> 1877
<u>Action</u> 0237	<u>DX Antenna</u> 1500	<u>Kabel</u> <u>Deutschland</u> 1981	<u>NTL</u> 0003, 0276, 0277, 1060, 1068	<u>Quasar</u> 0000	<u>Tocom</u> 0012
<u>Active</u> 0237	<u>Encon</u> 0008	<u>Kabel</u> <u>Deutschland</u> 1981	<u>Ono</u> 1068	<u>Regal</u> 0276	<u>Torx</u> 0003
<u>ADB</u> 1927	<u>Fosgate</u> 0276	<u>Kabelvision</u> 0003	<u>Optus</u> 0276, 1060	<u>Runco</u> 0000	<u>Toshiba</u> 0000, 1509
<u>Americast</u> 0899	<u>Foxtel</u> 1222	<u>Kloss</u> 0277	<u>Pace</u> 0008, 0237, 0877, 1060, 1068, 1577, 1877	<u>Sagem</u> 0817	<u>Trans PX</u> 0276
<u>Amstrad</u> 1222	<u>France Telecom</u> 0817	<u>KNC</u> 0008	<u>Optus</u> 0008, 0237, 0877, 1060, 1068, 1577, 1877	<u>Salora</u> 0000	<u>TS</u> 0003
<u>Archer</u> 0237	<u>Freebox</u> 1482	<u>LG</u> 0144	<u>Panama</u> 0107	<u>Samsung</u> 0000, 0003, 0144, 1060, 1666	<u>United Cable</u> 0003, 0276
<u>Auna</u> 0277	<u>Fujitsu</u> 1497	<u>Macab</u> 0144	<u>Panasonic</u> 0107	<u>Scientific</u> <u>Atlanta</u> 0000, 0003, 0008, 0012, 0237, 0277, 0477, 0877, 1877	<u>US Electronics</u> 0003, 0008, 0276, 0277
<u>Austar</u> 0012, 0276	<u>Galaxi</u> 0008	<u>Melita</u> 0817	<u>Panasonic</u> 0000, 0008, 0107, 0144, 1488	<u>Atlanta</u> 0000, 0003, 0008, 0012, 0237, 0277, 0477, 0877, 1877	<u>Videoway</u> 0000
<u>BCC</u> 0276	<u>GE</u> 0144, 0237	<u>Memorex</u> 0000	<u>Paragon</u> 0000, 0008, 0525	<u>Scientific</u> <u>Atlanta</u> 0000, 0003, 0008, 0012, 0237, 0277, 0477, 0877, 1877	<u>Visiopass</u> 0817
<u>Bell South</u> 0899	<u>Gehua</u> 0476	<u>Mitsubishi</u> 0003	<u>Penney</u> 0000	<u>Salora</u> 1006, 1460	<u>Zenith</u> 0000, 0008, 0525, 0899
<u>Birmingham</u> <u>Cable</u>	<u>General</u> <u>Instrument</u>	<u>Motorola</u> 0276, 0476, 0810, 1187, 1376	<u>Philips</u> 0317, 0817, 1305	<u>Sprucer</u> 0144	
<u>Communications</u> 0276	<u>Galaxi</u> 0003, 0012, 0276, 0476, 0810	<u>MultiVision</u> 0012	<u>Pioneer</u> 0144, 0533, 0877, 1021, 1500, 1877	<u>Starcom</u> 0003	
<u>British Telecom</u> 0003	<u>Gibraltar</u> 0003	<u>NEC</u> 1496		<u>StarHub</u> 0276, 1927	
<u>Cable &</u> <u>Wireless</u> 1068	<u>GoldStar</u> 0144	<u>NET</u> 0012, 0277		<u>Sumitomo</u> 1500	

9.1.2 Satellite

Brand/Code	Brand/Code	Brand/Code	Brand/Code	Brand/Code	Brand/Code
<u>@sat</u> 1300	<u>Big Sat</u> 1457	<u>Daewoo</u> 1111	<u>Esat</u> 0879	<u>Hauppauge</u> 1672	<u>Kathrein</u> 0173, 0200,
<u>@Sky</u> 1334	<u>Black Diamond</u> 1284	<u>Digifusion</u> 1645	<u>EuroLine</u> 1251	<u>HB</u> 1214	1416, 1561, 1567
<u>ADB</u> 0642, 0887, 1367	<u>Blaupunkt</u> 0173	<u>Digihome</u> 1284	<u>Expressvu</u> 0775, 1775	<u>Hills</u> 1232, 2209	<u>Kenwood</u> 0853
<u>Akai</u> 0200	<u>Boca</u> 1232	<u>DigiLogic</u> 1284	<u>Ferguson</u> 1291	<u>Hirschmann</u> 0173, 1111, 1232, 1412	<u>Kreiling</u> 1626
<u>Alba</u> 1284	<u>Boston</u> 1251	<u>DigiQuest</u> 1300, 1457	<u>FMD</u> 1251, 1413, 1457	<u>Hitachi</u> 0749, 0819, 1250, 1284	<u>Kreiselmeier</u> 0173
<u>Allsat</u> 0200	<u>Brainwave</u> 1672	<u>DigiSat</u> 1232	<u>Foxtel</u> 0879, 1176	<u>Homecast</u> 1214	<u>L&S Electronic</u> 1334
<u>Allvision</u> 1232, 1334, 1412	<u>British Sky</u> <u>Broadcasting</u> 0847, 1175	<u>Digisky</u> 1457	<u>Fuba</u> 0173, 1214, 1251	<u>Hornet</u> 1300	<u>LaSAT</u> 0173
<u>AlphaStar</u> 0772	<u>BskyB</u> 0847, 1175	<u>Digiturk</u> 1076	<u>Funai</u> 1377	<u>Houston</u> 0775	<u>Lemon</u> 1334
<u>Amstrad</u> 0847, 1113, 1175	<u>Bush</u> 1284, 1645, 1672	<u>DiPro</u> 1367	<u>Galaxis</u> 0853, 0879, 1111	<u>HTS</u> 0775, 1775	<u>Lenox</u> 1611
<u>Aonvision</u> 2279	<u>Canal</u> 0853	<u>DirecTV</u> 0099, 0247, 0392, 0566, 0639, 0749, 0819, 1076, 1108, 1142, 1377, 1392, 1414, 1442, 1609, 1639, 1749, 1856	<u>GbSAT</u> 1214	<u>Hughes</u> <u>Network</u> <u>Systems</u> 0749, 1142, 1442, 1749	<u>LG</u> 1414
<u>Apro</u> 1672	<u>Canal Digital</u> 0853	<u>Dish Network</u> <u>System</u> 0775, 1505, 1775	<u>GE</u> 0392, 0566	<u>Humax</u> 1176, 1427, 1675, 1808	<u>Listo</u> 1626
<u>Armstrong</u> 0200	<u>Canal Satellite</u> 0853	<u>Dishpro</u> 0775, 1505, 1775	<u>Gecco</u> 1412	<u>Indovision</u> 0856, 0887	<u>Lodos</u> 1284
<u>Arnion</u> 1300	<u>Canal+</u> 0853	<u>DNT</u> 0200	<u>General</u> <u>Instrument</u> 0869	<u>iCan</u> 1367	<u>Logik</u> 1284
<u>Asat</u> 0200	<u>Centrex</u> 1457	<u>Draco</u> 1375	<u>General Satellite</u> 1176	<u>ID Digital</u> 1176	<u>Magnavox</u> 0722
<u>ASCI</u> 1334	<u>Century</u> 0856	<u>Dream</u> <u>Multimedia</u> 1237	<u>Globo</u> 1251, 1334, 1412, 1429, 1626	<u>Imperial</u> 1334, 1429, 1672	<u>Marantz</u> 0200
<u>AssCom</u> 0853	<u>CGV</u> 1413, 1567	<u>DSE</u> 1375	<u>GOD Digital</u> 0200	<u>Interstar</u> 1214	<u>Maspro</u> 0173
<u>Astro</u> 0173, 1100, 1113	<u>Chaparral</u> 0216	<u>DSTV</u> 0642, 0879, 1433	<u>GOI</u> 0775, 1775	<u>ISkyB</u> 0887	<u>Matsui</u> 0173, 1284
<u>Atsat</u> 1300	<u>Chess</u> 1334, 1626	<u>Durabrand</u> 1284	<u>Gold Box</u> 0853	<u>ITT Nokia</u> 0723	<u>Maximum</u> 1334
<u>AtSky</u> 1334	<u>CityCom</u> 1176, 1232	<u>Echostar</u> 0775, 0853, 1323, 1409, 1505, 1775	<u>GoldMaster</u> 1334	<u>Jadeworld</u> 0642	<u>McIntosh</u> 0869
<u>Audioline</u> 1672	<u>Classic</u> 1672	<u>Elap</u> 1567	<u>Goodmans</u> 1284, 1291	<u>Jaeger</u> 1334	<u>Mediabox</u> 0853
<u>Aurora</u> 0642, 0879, 1433	<u>Clatronic</u> 1413	<u>Elta</u> 0200	<u>Gradiente</u> 0099, 0856, 0887	<u>Jerrold</u> 0869	<u>Mediacom</u> 1206
<u>Austar</u> 0642, 0879, 1176	<u>CNS</u> 1367	<u>Engel</u> 1251	<u>Grandin</u> 1626	<u>JVC</u> 0492, 0775, 1775	<u>MediaSat</u> 0853
<u>Axil</u> 1457	<u>Comag</u> 1232, 1412, 1413		<u>Grundig</u> 0173, 0847, 0853, 0879, 1284, 1291	<u>Kaon</u> 1300	<u>Medion</u> 1232, 1334, 1412, 1626
<u>Axis</u> 1111	<u>Coship</u> 1457		<u>Hanseatic</u> 1100	<u>KaTelco</u> 1111	<u>Mega</u> 0200
<u>B@ytronic</u> 1412	<u>Crown</u> 1284				<u>Metronic</u> 1334, 1375
<u>Bell ExpressVu</u> 0775	<u>Cyfra+</u> 1076				<u>Metz</u> 0173
	<u>Cyrus</u> 0200				<u>Mitsubishi</u> 0749
	<u>D-box</u> 0723, 1114				<u>Morgan's</u> 0200, 1232, 1412

Brand/Code	Brand/Code	Brand/Code	Brand/Code	Brand/Code	Brand/Code
<u>Motorola</u> 0856, 0869	<u>Panasonic</u> 0247, 0701, 0847, 1304, 1404	<u>RFT</u> 0200	<u>Sky Brazil</u> 0856, 0887	<u>Technosat</u> 1206	<u>Twinner</u> 1611
<u>MTEC</u> 1214	<u>Panda</u> 0173	<u>Roadstar</u> 0853	<u>SKY Italia</u> 0853	<u>Technosonic</u> 1672	<u>UFC</u> 0879
<u>Multibroadcast</u> 0642, 0879	<u>peeKTon</u> 1457	<u>Rollmaster</u> 1413	<u>Sky XL</u> 1251, 1412	<u>Technotrend</u> 1429	<u>UltimateTV</u> 1392
<u>Multichoice</u> 0642, 0879, 1433	<u>Philips</u> 0099, 0173, 0200, 0722, 0749, 0775, 0819, 0847, 0853, 0856, 0887, 1076, 1114, 1142, 1442, 1672, 1749	<u>Rownsenic</u> 1567	<u>Sky+</u> 1175	<u>Techwood</u> 1284, 1626	<u>Uniden</u> 0722
<u>Myryad</u> 0200	<u>Pino</u> 1334	<u>SAB</u> 1251	<u>Skymaster</u> 1334, 1409, 1567, 1611	<u>TELE System</u> 1251, 1409, 1611	<u>Unisat</u> 0200
<u>NEOTION</u> 1334	Pioneer 0329, 0853, 1308	<u>Saba</u> 0820	<u>Skymax</u> 0200	<u>TeleClub</u> 1367	<u>United</u> 1251
<u>Netsat</u> 0099, 0887	<u>PMB</u> 1611	<u>Sagem</u> 0820, 1114	<u>Skyplus</u> 1232, 1334, 1412	<u>Telestar</u> 1100, 1251, 1334, 1626, 1672	<u>Universum</u> 0173, 1251
<u>Neuling</u> 1232	<u>Preisner</u> 1113	<u>Samsung</u> 0853, 1108, 1142, 1206, 1276, 1377, 1442, 1458, 1570, 1609	<u>Skyvision</u> 1334	<u>Television</u> 1214, 1300, 1334	<u>Variosat</u> 0173
<u>Next Level</u> 0869	<u>Premier</u> 0723, 0853, 1023, 1223	<u>Sanyo</u> 1219	<u>SL</u> 1672	<u>Televest</u> 1214, 1300, 1334	<u>Ventana</u> 0200
<u>Nikko</u> 0200, 0723	<u>Primacom</u> 1111	<u>Sat Control</u> 1300	<u>SM Electronic</u> 1409	<u>Televisa</u> 0887	<u>Vestel</u> 1251
<u>Nokia</u> 0723, 0853, 1023, 1223	<u>Primestar</u> 0869	<u>SAT+</u> 1409	<u>Smart</u> 1113, 1232, 1404, 1413	<u>Televire</u> 1232	<u>Victor</u> 0492
<u>Nordmende</u> 1611	<u>Proscan</u> 0392, 0566	<u>Satelco</u> 1232	<u>Sony</u> 0639, 0847, 0853, 1558, 1639	<u>Tevion</u> 1409, 1672	<u>ViewSat</u> 1232
<u>OctalTV</u> 1505	<u>QNS</u> 1367, 1404	<u>Satplus</u> 1100	<u>Star</u> 0887	<u>Thomson</u> 0392, 0566, 0820, 0847, 0853, 1046, 1175, 1291	<u>Visiosat</u> 1413, 1457
<u>Omega</u> 0887	<u>Radiola</u> 0200	<u>Schaub Lorenz</u> 1214	<u>Star Choice</u> 0869	<u>Tiny</u> 1672	<u>Viva</u> 0856
<u>Opentel</u> 1232, 1412	<u>RadioShack</u> 0566, 0775, 0869	<u>Schneider</u> 1206, 1251	<u>Star Trak</u> 0772, 0869	<u>Tivoli</u> 1429	<u>Voom</u> 0869
<u>Optex</u> 1611, 1626	<u>Radix</u> 1113	<u>Schwaiger</u> 1111, 1334, 1412, 1457	<u>Starlite</u> 0200	<u>Tivo</u> 1142, 1442	<u>Wavelength</u> 1232, 1413
<u>Optus</u> 0879	<u>RCA</u> 0143, 0392, 0566, 0775, 0855, 1142, 1291, 1392, 1442	<u>Sedeas</u> <u>Electronique</u> 1206, 1626	<u>Strong</u> 0820, 0853, 0879, 1284, 1300, 1409, 1626	<u>Tokai</u> 0200	<u>Wharfedale</u> 1284
<u>Orbis</u> 1232, 1334, 1412	<u>Rebox</u> 1214	<u>SEG</u> 1251, 1626	<u>Star</u> 0887	<u>Tonna</u> 1611	<u>Wisi</u> 0173, 1232
<u>Orbitech</u> 1100	<u>Regal</u> 1251	<u>Septimo</u> 1375	<u>Star Choice</u> 0869	<u>Topfield</u> 1206, 1208	<u>Worldsat</u> 1214, 1251
<u>P/Sat</u> 1232		<u>Serd</u> 1412	<u>Star Choice</u> 0869	<u>Toshiba</u> 0749, 0790, 1284, 1749	<u>Xsat</u> 0847, 1214, 1323
<u>Pace</u> 0200, 0329, 0847, 0853, 0887, 1175, 1323, 1423		<u>Servimat</u> 1611	<u>Starlite</u> 0200	<u>Toshida</u> 0749, 0790, 1284, 1749	<u>Xtreme</u> 1300
<u>Pacific</u> 1284, 1375		<u>ServiSat</u> 1251	<u>Starlite</u> 0200	<u>TPS</u> 0820	<u>Yakumo</u> 1413
<u>Packard Bell</u> 1111		<u>Siemens</u> 0173, 1334, 1429	<u>Strong</u> 0820, 0853, 0879, 1284, 1300, 1409, 1626	<u>Triax</u> 0200, 0853, 1113, 1251, 1291, 1611, 1626	<u>Yes</u> 0887
<u>Palcom</u> 1409		<u>SKY</u> 0099, 0847, 0856, 0887, 1175, 1856	<u>Sunny</u> 1300	<u>TT-micro</u> 1429	<u>Zehnder</u> 1232, 1251, 1334, 1412, 1413
<u>Panasat</u> 0879, 1433			<u>Sunstar</u> 0642		<u>Zenith</u> 0856, 1856
			<u>Supernova</u> 0887		<u>Zeta Technology</u> 0200
			<u>Supratech</u> 1413		<u>Zinwell</u> 2280
			<u>Systec</u> 1334		
			<u>Teac</u> 1251		
			<u>TechniSat</u> 1100, 1195		

9.1.3 VCR

Brand/Code	Brand/Code	Brand/Code	Brand/Code	Brand/Code	Brand/Code
<u>A-Mark</u> 0000, 0037, 0278	<u>Alba</u> 0000, 0081, 0209, 0278, 0315, 0348	<u>ASA</u> 0037, 0081	<u>Bell & Howell</u> 0000, 0035, 0039, 0048	<u>Bush</u> 0000, 0081, 0209, 0278, 0315, 0348, 0642	<u>CCE</u> 0278
<u>ABS</u> 1972	<u>Alienware</u> 1972	<u>Astra</u> 0035	<u>Bestar</u> 0278	<u>Calix</u> 0037	<u>CGE</u> 0000
<u>Accurian</u> 0000	<u>Allegro</u> 0039	<u>Asuka</u> 0000, 0037, 0038, 0081	<u>Black Diamond</u> 0642	<u>Candle</u> 0037, 0038	<u>Changhong</u> 0048, 0081
<u>Admiral</u> 0039, 0047, 0048, 0060, 0121, 0209	<u>Allstar</u> 0081	<u>Audio-Technica</u> 0058	<u>Black Panther</u> 0278	<u>Canon</u> 0035	<u>Cimline</u> 0209
<u>Adventura</u> 0000, 0037	<u>America Action</u> 0278	<u>Audiolab</u> 0081	<u>Blaupunkt</u> 0081, 0162, 0226	<u>Carena</u> 0081, 0209	<u>Cineral</u> 0278
<u>Aiko</u> 0278	<u>American High</u> 0035, 0081	<u>Audiosonic</u> 0278	<u>Blue Sky</u> 0037, 0209, 0278, 0348, 0642	<u>Carrefour</u> 0045	<u>Citizen</u> 0000, 0035, 0037, 0209, 0278
<u>Aim</u> 0278, 0348,	<u>Amstrad</u> 0000, 0278	<u>Audiovox</u> 0037, 0038, 0278	<u>Brandt</u> 0320	<u>Carver</u> 0035, 0081	<u>Classic</u> 0037
<u>0642</u>	<u>Anam</u> 0037, 0162, 0226, 0278	<u>Avis</u> 0000	<u>Brinkmann</u> 0209, 0348	<u>Casio</u> 0000	<u>Clatronic</u> 0000
<u>Aiwa</u> 0000, 0032, 0037, 0209, 0348, 1291	<u>Anam National</u> 0162, 0226, 1162, 1562	<u>AVP</u> 0000	<u>Broksonic</u> 0121, 0184, 0209, 0348	<u>Cathay</u> 0278	<u>Colortyme</u> 0035, 0045, 0060, 0278
<u>Akai</u> 0037, 0315, 0348, 0642	<u>Ansonic</u> 0000	<u>Awa</u> 0037, 0043, 0278, 0642			<u>Colt</u> 0000
	<u>Aristona</u> 0081	<u>Baird</u> 0000, 0278			<u>Condor</u> 0278
		<u>Basic Line</u> 0278			<u>Craig</u> 0037, 0047

Brand/Code	Brand/Code	Brand/Code	Brand/Code	Brand/Code	Brand/Code
<u>Criterion</u> 0000	<u>Durabrand</u> 0038, 0039, 0642	<u>Funai</u> 0000, 0037, 0278	<u>Hanseatic</u> 0037, 0038, 0081, 0209	<u>International</u> 0037, 0278, 0642	<u>Lenco</u> 0278
<u>Crosley</u> 0000, 0035, 0081, 0149	<u>Dynatech</u> 0000	<u>Galaxi</u> 0000	<u>Harley Davidson</u> 0000	<u>Intervision</u> 0000, 0037, 0209, 0278, 0348	<u>LG</u> 0000, 0037, 0038, 0042, 0045, 0209, 0225, 0278
<u>Crown</u> 0037, 0278	<u>Elbe</u> 0038, 0278	<u>Galaxis</u> 0278	<u>Harman/Kardon</u> 0038, 0081	<u>Irradio</u> 0037, 0081	<u>Lifetec</u> 0209, 0348
<u>Curtis Mathes</u> 0000, 0035, 0060, 0162, 0278	<u>Electrohome</u> 0000, 0037, 0043, 0060, 0209	<u>Garrard</u> 0000	<u>Hewlett Packard</u> 1972	<u>ITV</u> 0037, 0278	<u>Linksys</u> 1972
<u>CyberPower</u> 1972	<u>Electroponic</u> 0037	<u>Gateway</u> 1972	<u>Hi-Q</u> 0000, 0035, 0047	<u>JBL</u> 0278	<u>Lloyd's</u> 0000, 0038
<u>Cyrus</u> 0081	<u>Elta</u> 0278	<u>GE</u> 0000, 0035, 0048, 0060, 0149, 0226, 0320	<u>Hinari</u> 0209, 0278	<u>Jensen</u> 0067	<u>Loewe</u> 0037, 0081, 0162, 1062, 1562
<u>Daewoo</u> 0037, 0045, 0209, 0278, 0642	<u>Emerald</u> 0121, 0184	<u>GEC</u> 0081	<u>Hisawa</u> 0209	<u>JMB</u> 0209, 0348	<u>Logik</u> 0000, 0209
<u>Dansai</u> 0278	<u>Emerex</u> 0032	<u>Gemini</u> 0060	<u>Hischito</u> 0045	<u>Joyce</u> 0000	<u>Lumatron</u> 0278
<u>Daytron</u> 0037, 0278	<u>Emerson</u> 0000, 0035, 0037, 0039, 0043, 0045, 0121, 0184, 0209, 0278, 0348	<u>General</u> 0045	<u>Hitachi</u> 0000, 0035, 0037, 0042, 0045, 0081, 0089	<u>JVC</u> 0045, 0058, 0067, 0081, 0184, 1162, 1279	<u>Luxor</u> 0043, 0047, 0048, 0315
<u>De Graaf</u> 0042, 0048, 0081	<u>Emerex</u> 0032	<u>General Technic</u> 0348	<u>Hoehner</u> 0278, 0642	<u>Kambrook</u> 0037	<u>LXI</u> 0000, 0037, 0042, 0067
<u>Decca</u> 0000, 0067, 0081, 0209	<u>ESC</u> 0278	<u>Genexxa</u> 0000, 0037, 0278	<u>Hornyphon</u> 0081	<u>Karcher</u> 0081, 0278, 0642	<u>M Electronic</u> 0000, 0037, 0038
<u>Degraff</u> 0042, 0048, 0081	<u>Ferguson</u> 0000, 0278, 0320, 0348	<u>Go Video</u> 0614	<u>Howard</u> <u>Computers</u> 1972	<u>KEC</u> 0037, 0278	<u>Magnadyne</u> 0081
<u>Deitron</u> 0278	<u>Fidelity</u> 0000	<u>GoldStar</u> 0000, 0035, 0037, 0038, 0039, 0209, 0225, 0226, 0278	<u>HP</u> 1972	<u>Kendo</u> 0037, 0209, 0278, 0315, 0348, 0642	<u>Magnasonic</u> 0000, 0037, 0278
<u>Dell</u> 1972	<u>Finlandia</u> 0000, 0037, 0042, 0043, 0048, 0081, 0226	<u>Goodmans</u> 0000, 0037, 0081, 0209, 0278, 0348, 0642	<u>Hughes</u> <u>Network</u> <u>Systems</u> 0042, 0739	<u>Kenwood</u> 0038, 0067	<u>Magnavox</u> 0000, 0035, 0037, 0039, 0048, 0081, 0149, 0226, 0642
<u>Denon</u> 0042, 0081	<u>Finlux</u> 0000, 0042, 0081	<u>GPX</u> 0037	<u>Humax</u> 0739	<u>KIC</u> 0000	<u>Manesth</u> 0045, 0081, 0209
<u>Diamant</u> 0037	<u>Firstline</u> 0037, 0042, 0043, 0045, 0209, 0278, 0348	<u>Gradiente</u> 0000	<u>Hush</u> 1972	<u>Kimari</u> 0047	<u>Marantz</u> 0035, 0038, 0081, 0209
<u>Diamond</u> 0348	<u>Fisher</u> 0000, 0039, 0047	<u>Granada</u> 0000, 0035, 0037, 0042, 0048, 0081, 0226	<u>Hypson</u> 0000, 0037, 0209, 0278	<u>Kioto</u> 0348	<u>Mark</u> 0000, 0278
<u>Dick Smith</u> <u>Electronics</u> 0642	<u>Flint</u> 0209, 0348	<u>Grundig</u> 0081, 0226, 0320, 0348	<u>Hytek</u> 0000, 0047	<u>Kneissel</u> 0037, 0209, 0278, 0348	<u>Master's</u> 0278
<u>Digiton</u> 0642	<u>Fuji</u> 0033, 0035	<u>Haaz</u> 0348	<u>iBUYPOWER</u> 1972	<u>Kodak</u> 0035, 0037	
<u>DirecTV</u> 0739	<u>Fujiitsu</u> 0000, 0037, 0045		<u>Imperial</u> 0000	<u>Kolin</u> 0043	
<u>Domland</u> 0209	<u>Fujitsu General</u> 0037		<u>Ingersol</u> 0209	<u>Kolster</u> 0209	
<u>DSE</u> 0642			<u>Instant Replay</u> 0035, 0226	<u>KTV</u> 0000	
<u>Dual</u> 0000, 0081, 0278, 0348			<u>Interbuy</u> 0037	<u>Kuba</u> 0047	
<u>Dumont</u> 0000, 0081			<u>Interfunk</u> 0081	<u>Kuba Electronic</u> 0047	
			<u>Internal</u> 0278		

Brand/Code	Brand/Code	Brand/Code	Brand/Code	Brand/Code	Brand/Code
<u>Matsui</u> 0037, 0209, 0278, 0348	<u>Multitech</u> 0000, 0039	<u>Onkyo</u> 0222	<u>Philips</u> 0000, 0035, 0045, 0048, 0081, 0162, 0209, 0226, 0616, 0739	<u>Radiola</u> 0081	<u>Sanyo</u> 0000, 0047, 0048, 0067, 0348
<u>Matsushita</u> 0035, 0081, 0162, 0226, 1162	<u>Murphy</u> 0000	<u>Optimus</u> 0000, 0035, 0037, 0047, 0048, 0058, 0162, 1062, 1162	<u>Phoenix</u> 0278	<u>Radionette</u> 0037	<u>Saville</u> 0278
<u>Media Center</u> <u>PC</u> 1972	<u>Myryad</u> 0081	<u>Orion</u> 0000, 0121, 0184, 0209, 0278, 0348	<u>Phonola</u> 0081	<u>RadioShack</u> 0000, 0035, 0037, 0047, 0048, 0162, 1162	<u>SBR</u> 0081
<u>Mediator</u> 0081	<u>NAD</u> 0058	<u>Orson</u> 0000	<u>Pioneer</u> 0042, 0058, 0067, 0081, 0162, 0168	<u>Radix</u> 0037	<u>Schaub Lorenz</u> 0000, 0315, 0348
<u>Medion</u> 0209, 0348, 0642	<u>Naiko</u> 0348, 0642	<u>Osaki</u> 0000, 0037	<u>Polk Audio</u> 0081	<u>Randex</u> 0037	<u>Schneider</u> 0000, 0037, 0042, 0081, 0278, 0348, 0642
<u>MEI</u> 0035	<u>NAP</u> 0039	<u>Otake</u> 0209	<u>Portland</u> 0278	<u>RCA</u> 0000, 0035, 0042, 0045, 0048, 0058, 0060, 0149, 0226, 0320, 0880	<u>Scott</u> 0043, 0045, 0121, 0184
<u>Memorex</u> 0000, 0035, 0037, 0039, 0047, 0048, 0162, 0209, 0278, 0348, 1162	<u>National</u> 0226	<u>Otto Versand</u> 0081	<u>Precision</u> 0058	<u>Realistic</u> 0000, 0035, 0037, 0047, 0048, 0121, 0162, 0278, 1162	<u>Sears</u> 0000, 0033, 0035, 0037, 0039, 0042, 0043, 0045, 0047, 0048, 0058, 0060, 0067, 0162, 0209
<u>Metronic</u> 0081	<u>Nebula</u> <u>Electronics</u> 0033	<u>Pacific</u> 0000, 0348, 0642	<u>Prinz</u> 0000	<u>Reoc</u> 0348	<u>Seaway</u> 0278
<u>Metz</u> 0037, 0081, 0162, 0226, 1062, 1162, 1562	<u>NEC</u> 0035, 0037, 0038, 0048, 0067, 0278	<u>Packard Bell</u> 1972	<u>Profitronic</u> 0081	<u>ReplayTV</u> 0614, 0616	<u>SEG</u> 0081, 0278, 0642
<u>MGA</u> 0043, 0060	<u>Neckermann</u> 0081	<u>Palladium</u> 0037, 0209, 0348	<u>Proscan</u> 0060	<u>Ricavision</u> 1972	<u>SEI</u> 0081
<u>Micormay</u> 0348	<u>Nesco</u> 0000	<u>Panasonic</u> 0000, 0035, 0162, 0225, 0226, 0614, 0616, 1062, 1162, 1244, 1293, 1562	<u>Proscoc</u> 0278	<u>Roadstar</u> 0037, 0038, 0081, 0278	<u>Sei-Sinudyne</u> 0081
<u>Micromaxx</u> 0209	<u>Neufunk</u> 0209	<u>Panama</u> 0035	<u>Prosonic</u> 0209, 0278	<u>Runco</u> 0039	<u>Seleco</u> 0037
<u>Microsoft</u> 1972	<u>Newave</u> 0037	<u>Panasonic</u> 0000, 0642	<u>Protec</u> 0000	<u>Saba</u> 0278, 0320	<u>Semivox</u> 0045, 0209
<u>Migros</u> 0000	<u>Nikkai</u> 0278	<u>Panasonic</u> 0000, 0035, 0162, 0225, 0226, 0614, 0616, 1062, 1162, 1244, 1293, 1562	<u>Protech</u> 0081	<u>Saisho</u> 0209, 0348	<u>Semp</u> 0045
<u>Mind</u> 1972	<u>Nikko</u> 0037, 0278	<u>Panasonic</u> 0000, 0035, 0162, 0225, 0226, 0614, 0616, 1062, 1162, 1244, 1293, 1562	<u>ProVision</u> 0278	<u>Salora</u> 0043	<u>Sentra</u> 0278
<u>Minolta</u> 0042	<u>Nikkodo</u> 0037, 0278	<u>Panasonic</u> 0000, 0035, 0162, 0225, 0226, 0614, 0616, 1062, 1162, 1244, 1293, 1562	<u>Pulsar</u> 0039, 0278	<u>Sampo</u> 0037, 0048	<u>Sharp</u> 0000, 0032, 0037, 0047, 0048, 0209, 1285
<u>Mitsubishi</u> 0000, 0042, 0043, 0047, 0048, 0060, 0067, 0081, 0642	<u>Niveus Media</u> 1972	<u>Panasonic</u> 0000, 0035, 0162, 0225, 0226, 0614, 0616, 1062, 1162, 1244, 1293, 1562	<u>Pye</u> 0000, 0081	<u>Samsung</u> 0000, 0038, 0045, 0060, 0739	<u>Shinco</u> 0000
<u>Motorola</u> 0035, 0048	<u>Nokia</u> 0042, 0048, 0081, 0278, 0315	<u>Pathe Cinema</u> 0043	<u>Qisheng</u> 0060	<u>Sanky</u> 0039, 0048	<u>Shintom</u> 0000, 0039
<u>MTC</u> 0000	<u>Nordmende</u> 0067, 0320	<u>Penney</u> 0000, 0035, 0037, 0038, 0042, 0047, 0067, 0081, 0162	<u>Quartz</u> 0035, 0047	<u>Sansei</u> 0048	<u>Shivaki</u> 0037
<u>MTX</u> 0000	<u>Northgate</u> 1972	<u>Penney</u> 0000, 0035, 0037, 0038, 0042, 0047, 0067, 0081, 0162	<u>Quasar</u> 0035, 0162, 0226, 0278, 1162	<u>Sansui</u> 0000, 0067, 0209, 0348	<u>Siemens</u> 0037, 0081, 0320
<u>Multitec</u> 0037	<u>Nu-Tec</u> 0209	<u>Penney</u> 0000, 0035, 0037, 0038, 0042, 0047, 0067, 0081, 0162	<u>Quelle</u> 0081		
	<u>Oceanic</u> 0000, 0048, 0081	<u>Pentax</u> 0042	<u>Radialva</u> 0037, 0048, 0081		
	<u>Okano</u> 0209, 0278, 0315, 0348	<u>Perdio</u> 0000, 0209			
	<u>Olympus</u> 0035, 0162, 0226	<u>Philco</u> 0000, 0035, 0038, 0081, 0209, 0226			
	<u>Onimax</u> 0642				

Brand/Code	Brand/Code	Brand/Code	Brand/Code	Brand/Code	Brand/Code
<u>Siera</u> 0081	<u>Stack 9</u> 1972	<u>Tandy</u> 0000	<u>Telestar</u> 0037	<u>Totevision</u> 0037	<u>Voodoo</u> 1972
<u>Signature</u> 0000, 0035, 0037, 0048, 0060, 0149	<u>Standard</u> 0278	<u>Tashiko</u> 0000, 0037, 0048, 0081	<u>Teletech</u> 0000, 0278	<u>Touch</u> 1972	<u>Wards</u> 0000, 0033, 0035, 0037, 0038, 0039, 0042, 0043, 0045, 0047, 0048, 0058, 0060, 0081, 0149
<u>Silva</u> 0037	<u>Stern</u> 0278	<u>Tatung</u> 0000, 0043, 0045, 0048,	<u>Tensai</u> 0000, 0037, 0278	<u>Toyoda</u> 0278	<u>Watson</u> 0081, 0642
<u>Silver</u> 0278	<u>STS</u> 0042	<u>TCM</u> 0037, 0081, 0209, 0348	<u>Tevion</u> 0209, 0348, 0642	<u>Tradex</u> 0081	<u>Weltblick</u> 0037
<u>SilverCrest</u> 0642	<u>Sunkai</u> 0209, 0278, 0348	<u>Teac</u> 0000, 0037, 0067, 0278, 0642	<u>Texet</u> 0278	<u>Triad</u> 0278	<u>Wharfedale</u> 0642
<u>Singer</u> 0037, 0045, 0348	<u>Sunstar</u> 0000	<u>Technics</u> 0000, 0035, 0037, 0081, 0162, 0226, 1162	<u>Thomas</u> 0000	<u>Trix</u> 0037	<u>White</u> 0000, 0209, 0278
<u>Sinudyne</u> 0081, 0209	<u>Suntronic</u> 0000	<u>TechniSat</u> 0348	<u>Thomson</u> 0060, 0067, 0278, 0320	<u>Ultra</u> 0045, 0278	<u>Westinghouse</u> 0000, 0209, 0278
<u>Smaragd</u> 0348	<u>Supra</u> 0037, 0278, 0348	<u>Teco</u> 0035, 0037, 0038, 0048	<u>Thorn</u> 0037, 0320	<u>Ultravox</u> 0278	<u>World</u> 0209, 0348
<u>Sonic Blue</u> 0614, 0616	<u>Susumu</u> 0037	<u>Tedelex</u> 0037, 0209, 0348, 0642	<u>Tisonic</u> 0278	<u>United</u> 0348	<u>XR-1000</u> 0000, 0035
<u>Sonolor</u> 0048	<u>SV2000</u> 0000	<u>Teknika</u> 0000, 0035, 0037	<u>Tivo</u> 0739, 1996	<u>Universum</u> 0000, 0037, 0081, 0209, 0348	<u>Yamaha</u> 0038
<u>Sontec</u> 0037, 0278	<u>SVA</u> 0000	<u>Telefunken</u> 0209, 0278, 0320, 0642	<u>TMK</u> 0000	<u>Vector</u> 0045	<u>Yamishi</u> 0278
<u>Sonwa</u> 0642	<u>Sylvania</u> 0000, 0035, 0043, 0081	<u>Telerent</u> 0226	<u>TNIX</u> 0037	<u>Vector Research</u> 0038, 0184	<u>Yoko</u> 0037
<u>Sony</u> 0000, 0032, 0033, 0035, 0047, 0048, 0067, 0226, 1636, 1972	<u>Symphonic</u> 0000		<u>Tokai</u> 0037	<u>Victor</u> 0067	<u>Zenith</u> 0000, 0033, 0037, 0039, 0209, 0278
<u>Soundmaster</u> 0000	<u>Systemax</u> 1972		<u>Topline</u> 0348	<u>Video Concepts</u> 0045	<u>ZT Group</u> 1972
<u>Soundwave</u> 0037, 0209, 0348	<u>T+A</u> 0162		<u>Toshiba</u> 0000, 0042, 0043, 0045, 0067, 0081, 0209, 1008, 1290, 1972, 1996	<u>Video Technic</u> 0000	<u>ZX</u> 0209, 0348
	<u>Tagar Systems</u> 1972		<u>Tosonic</u> 0278	<u>Videomagic</u> 0037	
	<u>Taisho</u> 0209			<u>Videosonic</u> 0000	
	<u>Tandberg</u> 0278			<u>Viewsonic</u> 1972	
				<u>Villain</u> 0000	

9.1.4 BDP (Blu-ray)

Brand/Code	Brand/Code	Brand/Code	Brand/Code	Brand/Code	Brand/Code
<u>LG</u> 0741	<u>Microsoft</u> 2083	<u>Panasonic</u> 1641	<u>Pioneer</u> 0142, 2052	<u>Samsung</u> 0199	<u>Toshiba</u> 1769
	<u>Onkyo</u> 1769	<u>Philips</u> 2084	<u>RCA</u> 1769	<u>Sony</u> 1516	<u>Xbox</u> 2083

9.1.5 DVD-R

Brand/Code	Brand/Code	Brand/Code	Brand/Code	Brand/Code	Brand/Code
<u>Accurian</u> 0675	<u>Digitrex</u> 1056	<u>Humax</u> 0646	<u>Panasonic</u> 0490	<u>Schneider</u> 0646	<u>Tevion</u> 1227
<u>Apex Digital</u> 1056	<u>Ellion</u> 1421	<u>JVC</u> 1164	<u>Philips</u> 0646, 1340	<u>Sharp</u> 0630, 0675	<u>Thomson</u> 0551
<u>Aristona</u> 0646	<u>Emerson</u> 0675	<u>Kreisen</u> 1421	Pioneer 0571, 0631, 1475, 1476, 2216	<u>Sony</u> 1033, 1070, 1431	<u>Universum</u> 1227
<u>Cat</u> 1421	<u>Funai</u> 0675	<u>LG</u> 0741	<u>Pye</u> 0646	<u>Star Clusters</u> 1227	<u>Yakumo</u> 1056
<u>Centrum</u> 1227	<u>Go Video</u> 0741	<u>Loewe</u> 0741	<u>RCA</u> 0522	<u>Sylvania</u> 0675	<u>Yamada</u> 1056
<u>CyberHome</u> 1129	<u>GPX</u> 0741	<u>Magnavox</u> 0646, 0675	<u>Roadstar</u> 1227	<u>Targa</u> 1227	<u>Yamaha</u> 0646
<u>Denon</u> 0490	<u>H & B</u> 1421	<u>Mitsubishi</u> 1403	<u>Samsung</u> 0490	<u>Teac</u> 1227	<u>Zenith</u> 0741
<u>Denver</u> 1056	<u>Hitachi</u> 1664	<u>Palsonic</u> 1056			

9.1.6 DVD

Brand/Code	Brand/Code	Brand/Code	Brand/Code	Brand/Code	Brand/Code
<u>3D LAB</u>	<u>Auvio</u>	<u>Clairtone</u>	<u>Disney</u>	<u>Global Link</u>	<u>Hyundai</u>
0503, 0539	0843	0571	0675, 1270	1224	0850, 1061,
<u>A-Trend</u>	<u>Basic Line</u>	<u>Clatronic</u>	<u>DSE</u>	<u>Global Sphere</u>	1228
0714	0713	0672, 0675,	1152	1152	<u>Ingelen</u>
<u>Accurian</u>	<u>Baze</u>	0788, 1233	<u>Dual</u>	<u>Go Video</u>	0788
0675	0898	<u>Clayton</u>	0675, 0713,	0573, 0741,	<u>Ingersol</u>
<u>Acoustic</u>	<u>BBK</u>	0713	1023	0744, 0869,	1023
<u>Solutions</u>	1224	<u>Codex</u>	<u>Durabrand</u>	1044, 1075	<u>Inno Hit</u>
0713, 1228	<u>Bel Canto</u>	1233	0713, 1023	<u>GoldStar</u>	0713
<u>ÆG</u>	<u>Design</u>	<u>Conia</u>	<u>DVD2000</u>	0591, 0741,	<u>Integra</u>
0788, 1233	1571	0672	0521	0869	0571, 0612,
<u>AFK</u>	<u>Black Diamond</u>	<u>Contel</u>	<u>E:max</u>	<u>Goodmans</u>	0627
1152	0713	0788	1233	0690, 0713,	<u>Irradio</u>
<u>Aim</u>	<u>Blu:sens</u>	<u>Creative</u>	<u>EagleTec</u>	0723	0869, 1115,
0672	1233	0503, 0539	0714	<u>GPX</u>	1224, 1233
<u>Airis</u>	<u>Blue Parade</u>	<u>Crown</u>	<u>eBench</u>	0741	<u>ISP</u>
0672, 1224	0571	0690, 0713,	1152	<u>Gradiente</u>	0695
<u>Aiwa</u>	<u>Blue Sky</u>	1115	<u>Eclipse</u>	0490	<u>JBL</u>
0533, 0641	0672, 0695,	<u>Crypto</u>	0723	<u>Gran Prix</u>	0702
<u>Akai</u>	0713, 0843	1228	<u>Elfunk</u>	0898	<u>JMB</u>
0690, 0695,	<u>Boman</u>	<u>CyberHome</u>	0713, 0850	<u>Grandin</u>	0695
0788, 0898,	0898	0714, 0816,	<u>Elite</u>	0713, 1233	<u>JNC</u>
1115, 1233	<u>Brainwave</u>	1023, 1129	1152	<u>Grundig</u>	0672
<u>Akura</u>	1115	<u>D-Vision</u>	<u>Ellion</u>	0539, 0551,	<u>JVC</u>
0898, 1233	<u>Brandt</u>	1115	0850, 1421	0695, 0713	0503, 0539,
<u>Alba</u>	0503, 0551	<u>Daewoo</u>	<u>Elta</u>	<u>H & B</u>	0558, 0623,
0539, 0672,	<u>Broksonic</u>	0490, 0714,	0672, 0690,	0713, 0841,	0867, 1164
0695, 0713	0695	0869, 1172	0788, 0850,	0850, 1233,	<u>Kansas</u>
<u>Allegro</u>	<u>Bush</u>	<u>Dansai</u>	1115, 1233	1421	<u>Technologies</u>
0869	0672, 0690,	1115	<u>Eltax</u>	<u>Haaz</u>	1233
<u>Altacom</u>	0713, 0723	<u>Dantax</u>	1233	1152	<u>Kendo</u>
1224	<u>C-Tech</u>	0539, 0713,	<u>Emerson</u>	<u>Haier</u>	0672, 0713
<u>Amitech</u>	1152	0723	0591, 0675,	0843	<u>Kennex</u>
0850	<u>California Audio</u>	<u>Decca</u>	0821	<u>Hanseatic</u>	0713, 0898
<u>Amstrad</u>	<u>Labs</u>	1115	<u>Enterprise</u>	0741	<u>Kenwood</u>
0713	0490	<u>Denon</u>	0591	<u>Harman/Kardon</u>	0490, 0534
<u>Ansonic</u>	<u>Cambridge</u>	0490, 0634,	<u>Entivo</u>	0582, 0702	<u>Kiss</u>
0759	<u>Soundworks</u>	1282, 1406	0503, 0539	<u>HCM</u>	0841
<u>Apex Digital</u>	0690	<u>Denver</u>	<u>Enzer</u>	0788	<u>KLH</u>
0533, 0672,	<u>Cat</u>	0672, 0788,	1228	<u>Henss</u>	0815
1056, 1061	0789, 1421	0898, 1056	<u>ESA</u>	0713	<u>Kloss</u>
<u>Arena</u>	<u>Centrex</u>	<u>Desay</u>	0821	<u>HiMAX</u>	0533
1115	0672	0843	<u>EuroLine</u>	0843	<u>Koss</u>
<u>Aristona</u>	<u>Centrum</u>	<u>Dqtec</u>	0675, 0788,	<u>Hitachi</u>	1061
0539, 0646	0713, 0789,	0672	1115, 1233	0573, 0664,	<u>Kreisen</u>
<u>Arrgo</u>	1227	<u>Dick Smith</u>	<u>Ferguson</u>	0695, 0713,	1421
1023	<u>CGV</u>	<u>Electronics</u>	0695, 0713,	1664	<u>Lasonic</u>
<u>Asono</u>	1115	1152	0898	<u>Hiteker</u>	0627, 0789
1224	<u>Changhong</u>	<u>Digihome</u>	<u>Finlux</u>	0672	<u>Lecson</u>
<u>Atacom</u>	0627, 1061	0713	0591, 0672,	<u>Hoehner</u>	1533
1224	<u>Cinea</u>	<u>DigiLogic</u>	0741	0713, 1224	<u>Lenco</u>
<u>Audiosonic</u>	0841	0713	<u>Firstline</u>	<u>Home Tech</u>	0713
0690	<u>Cinetec</u>	<u>Digitor</u>	0713, 0843,	<u>Industries</u>	<u>Lenoir</u>
<u>Audix</u>	0713	0690	0869	1224	1228
0713	<u>CineVision</u>	<u>Digitrex</u>	<u>Funai</u>	<u>HotMedia</u>	<u>Lennox</u>
<u>Autovox</u>	0869	0672, 1056	0675, 0695	1152	0690
0713	<u>Citizen</u>	<u>Dinamic</u>	<u>GE</u>	<u>Humax</u>	
	0695	0788	0522, 0815	0646	

Brand/Code	Brand/Code	Brand/Code	Brand/Code	Brand/Code	Brand/Code
<u>LG</u>	<u>MiCO</u>	<u>Palsonic</u>	<u>REC</u>	<u>Scott</u>	<u>Strong</u>
0591, 0741, 0869	0723	0672, 1056	0490	0672, 1233	0713
<u>LiteOn</u>	<u>Micromaxx</u>	<u>Panasonic</u>	<u>Redstar</u>	<u>Seeltech</u>	<u>Sunkai</u>
1058	0695	0490, 0503, 0571, 0703, 1282, 1362, 1462, 1641, 1762	0759, 0788, 0898	1224	0850
<u>Lodos</u>	<u>Micromedia</u>		<u>Reoc</u>	<u>SEG</u>	<u>Sunwood</u>
0713	0503, 0539		0752	0713	0788, 0898
<u>Loewe</u>	<u>Micromega</u>		<u>Revoy</u>	<u>Semp</u>	<u>Superscan</u>
0511, 0539, 0741	0539		0841	0503	0821
<u>Logik</u>	<u>Microsoft</u>	<u>Panda</u>	<u>Richmond</u>	<u>Shanghai</u>	<u>Supervision</u>
0713	0522, 2083	0789	1233	0672	1152
<u>Lumatron</u>	<u>Minato</u>	<u>peekTon</u>	<u>Rio</u>	<u>Sharp</u>	<u>SVA</u>
0695, 0713, 0741, 1115	0752	0898, 1224	0869	0630, 0675, 0713, 0752, 1256	0672, 0752
<u>Lunatron</u>	<u>Minax</u>	<u>Philco</u>	<u>Roadstar</u>	<u>Sherwood</u>	<u>Sylvania</u>
0741	0713	0675, 0690, 0788	0672, 0690, 0713, 0898, 1227	0741	0630, 0675, 0821
<u>Luxman</u>	<u>Minoka</u>	<u>Philips</u>	<u>Rocksonic</u>	<u>Shinsonic</u>	<u>Symphonic</u>
0573	1115	0503, 0539, 0585, 0646, 0675, 1340, 1354, 2056, 2084	0789	0533	0675, 0821
<u>Luxor</u>	<u>Mitsubishi</u>		<u>Rotel</u>	<u>Sigmatek</u>	<u>Tandberg</u>
0713	0521, 0713, 1403, 1521		0558, 0623	1224	0713
<u>Magnasonic</u>	<u>MPX</u>	Pioneer	<u>Rowa</u>	<u>Siltex</u>	<u>Targa</u>
0675	0843	0142, 0490,	0759	1224	1227
<u>Magnavox</u>	<u>NAD</u>	0525, 0571,	<u>Rownsonic</u>	<u>Silva</u>	<u>Tchibo</u>
0503, 0539, 0646, 0675, 0713, 0821, 1354	0741	0631, 1475,	0789	0788, 0898	0741
<u>Magnex</u>	<u>NEC</u>	1476, 1571,	<u>Royal</u>	<u>Silva Schneider</u>	0741
0723	0741, 0785, 0869	2052, 2216	0690	0898	<u>Teac</u>
<u>Manhattan</u>	<u>Noriko</u>	<u>Plu2</u>	<u>Saba</u>	<u>SilverCrest</u>	0571, 0675, 0741, 0759, 1227
0713	0752	0850	0551	1152	1227
<u>Marantz</u>	<u>Nowa</u>	<u>Polaroid</u>	<u>Saivod</u>	<u>Singer</u>	<u>Tec</u>
0503, 0539, 0675	0843	1061	0759	0690	0898
<u>Mark</u>	<u>Nu-Tec</u>	<u>Polk Audio</u>	<u>Salora</u>	<u>Sistemas</u>	<u>Technics</u>
0713	1228	0539	0741	0672	0490, 0703
<u>Matsui</u>	<u>Okano</u>	<u>Presidian</u>	<u>Sampo</u>	<u>Skantic</u>	<u>Technika</u>
0672, 0695, 0713	0752	0675	0752	0539, 0713	1115
<u>Maxdorf</u>	<u>Olidata</u>	<u>Prima</u>	<u>Samsung</u>	<u>Skyworth</u>	<u>Technisson</u>
0788	0672	1228	0199, 0490, 0573, 0744, 1044, 1075	0898	1115
<u>Maxim</u>	<u>Omni</u>	<u>Proceed</u>	<u>Sansui</u>	<u>Sliding</u>	<u>Technosonic</u>
0713	0690	0672	0695, 1228	1115	1115
<u>MBO</u>	<u>Onkyo</u>	<u>Proline</u>	<u>Santosh</u>	<u>SM Electronic</u>	<u>Techwood</u>
0690	0503, 0612, 0627, 1769	0672	1115	0690, 1152	0713
<u>McIntosh</u>	<u>Oppo</u>	<u>Proscan</u>	<u>Sanyo</u>	<u>Smart</u>	<u>Tecnimagen</u>
1533	1224	0522	0675, 0695, 0713, 1228	0713	1233
<u>MDS</u>	<u>Optim</u>	<u>Proson</u>	<u>Schaub Lorenz</u>	<u>Sonic Blue</u>	<u>Tedelex</u>
0713	0843	0713	0788, 1115	0573, 0869	0690, 1228
<u>Medion</u>	<u>Optimus</u>	<u>Prosonic</u>	<u>Schneider</u>	<u>Sony</u>	<u>Telefunken</u>
0630, 1270	0525, 0571	0752	0539, 0646, 0713, 0788, 0869	0533, 0573, 0630, 0864, 1033, 1070, 1431, 1516, 1533	0789
<u>Memorex</u>	<u>Orion</u>	<u>Pye</u>	<u>Schoentech</u>	<u>Sound Color</u>	<u>Teletech</u>
0695, 1270	0695, 1233	0539, 0646	0713	1233	0713
<u>Metronic</u>	<u>Ormond</u>	<u>Radionette</u>	<u>Schwaiiger</u>	<u>Standard</u>	<u>Tensai</u>
0690	0713	0741, 0869	0752	0788, 0898	0690
<u>Metz</u>	<u>Pacific</u>	<u>RadioShack</u>		<u>Star Clusters</u>	<u>Tevion</u>
0525, 0571, 0713	0695, 0713, 0759	0571		1152, 1227	0898, 1227
	<u>Palladium</u>	<u>RCA</u>		<u>Starmedia</u>	<u>Theta Digital</u>
	0695, 0713	0522, 0571, 0822, 1132, 1769		1224	0571
		<u>Realistic</u>			<u>Thomson</u>
		0571			0511, 0522, 0551

Brand/Code	Brand/Code	Brand/Code	Brand/Code	Brand/Code	Brand/Code
<u>Tokai</u> 0788, 0898	<u>Tredex</u> 0843	<u>Universum</u> 0591, 0713, 0741, 0869, 1227	<u>Vtrek</u> 1228	<u>Windsor</u> 0713	<u>XMS</u> 0788
<u>Tom-Tec</u> 0789	<u>TSM</u> 1224	<u>Urban Concepts</u> 0503, 0539	<u>Waitec</u> 1224, 1233	<u>Windy Sam</u> 0573	<u>Yakumo</u> 1056
<u>Top Success</u> 1224	<u>Umax</u> 0690	<u>Vestel</u> 0713	<u>Wellington</u> 0713	<u>WIZE</u> 1115	<u>Yamada</u> 1056
<u>Toshiba</u> 0503, 0539, 0573, 0695, 1154, 1769	<u>United</u> 0675, 0695, 0713, 0788, 1115, 1152, 1228, 1233	<u>Viewmaster</u> 1224	<u>Weltstar</u> 0713	<u>Woxter</u> 1224	<u>Yamaha</u> 0490, 0539, 0545, 0646, 1282, 1354
<u>TRANS- continents</u> 1233		<u>Voxson</u> 0690	<u>Wharfedale</u> 0713, 0752	<u>Xbox</u> 0522, 2083	<u>Zenith</u> 0503, 0591, 0741, 0869
			<u>Wilson</u> 1233	<u>XLogic</u> 1152, 1228	

9.1.7 LD

Brand/Code	Brand/Code	Brand/Code	Brand/Code	Brand/Code	Brand/Code
<u>Aiwa</u> 0203	<u>Funai</u> 0203	<u>Magnavox</u> 0194, 0217, 0241	<u>Optimus</u> 0059	<u>Quasar</u> 0204	<u>Telefunken</u> 0059
<u>Carver</u> 0194	<u>GoldStar</u> 0172	<u>Marantz</u> 0194	<u>Panasonic</u> 0204	<u>Realistic</u> 0203	<u>Theta Digital</u> 0194
<u>Denon</u> 0059, 0172, 0241	<u>Grundig</u> 0059	<u>Mitsubishi</u> 0059, 0241	<u>Philips</u> 0194	<u>Sega</u> 0023	<u>Toshiba</u> 0059
<u>Disco Vision</u> 0023	<u>Harman/Kardon</u> 0194	<u>NAD</u> 0059	Pioneer 0023, 0059, 0241, 1274	<u>Sony</u> 0201	<u>Wards</u> 0059
	<u>Hitachi</u> 0023	<u>Nagsmi</u> 0059	<u>Polk Audio</u> 0194	<u>Technics</u> 0204	<u>Yamaha</u> 0217

9.2 Video/PC Signals (HDMI/DVI/Component/min D-Sub/Composite)

9.2.1 INPUT 1 (Video Signals)

	Screen Mode											Remarks
	DOT BY DOT	4:3	FULL (FULL1)	FULL2	ZOOM	CINEMA	WIDE	WIDE 1	WIDE 2	FULL 14:9	CINEMA 14:9	
NTSC	-	Yes	Yes	-	Yes	Yes	Yes	-	-	Yes	Yes	
PAL	-	Yes	Yes	-	Yes	Yes	Yes	-	-	Yes	Yes	
SECAM	-	Yes	Yes	-	Yes	Yes	Yes	-	-	Yes	Yes	
4.43NTSC	-	Yes	Yes	-	Yes	Yes	Yes	-	-	Yes	Yes	
PAL M	-	Yes	Yes	-	Yes	Yes	Yes	-	-	Yes	Yes	
PAL N	-	Yes	Yes	-	Yes	Yes	Yes	-	-	Yes	Yes	

9.2.2 INPUT 2 (Component)/INPUT 3 (D-Sub) - Video Signals (Analog)

When reproducing the analog signals in the table below, set the Color Decoding option to *Comp. 1* or *Comp. 2*.

Resolution	Hf (kHz)	Vf (Hz)	Screen Mode											Remarks
			DOT BY DOT	4:3	FULL (FULL1)	FULL 2	ZOOM	CINEMA	WIDE	WIDE 1	WIDE 2	FULL 14:9	CINEMA 14:9	
480i	15.8	60.0	-	Yes	Yes	-	Yes	Yes	Yes	-	-	Yes	Yes	
480p	31.5	60.0	-	Yes	Yes	-	Yes	Yes	Yes	-	-	Yes	Yes	
576i	15.6	50.0	-	Yes	Yes	-	Yes	Yes	Yes	-	-	Yes	Yes	
576p	31.3	50.0	-	Yes	Yes	-	Yes	Yes	Yes	-	-	Yes	Yes	
720p	37.5	50.0	-	Yes	Yes	-	Yes	-	-	Yes	Yes	-	-	
720p	45.0	60.0	-	Yes	Yes	-	Yes	-	-	Yes	Yes	-	-	
1080i	28.1	50.0	Yes	Yes	Yes	Yes	Yes	-	-	Yes	Yes	-	-	
1080i	33.8	60.0	Yes	Yes	Yes	Yes	Yes	-	-	Yes	Yes	-	-	
1080p	27.0	24.0	Yes	Yes	Yes	Yes	Yes	-	-	Yes	Yes	-	-	
1080p	56.3	50.0	Yes	Yes	Yes	Yes	Yes	-	-	Yes	Yes	-	-	
1080p	67.5	60.0	Yes	Yes	Yes	Yes	Yes	-	-	Yes	Yes	-	-	

9.2.3 INPUT 4 (DVI)/INPUT 5 through 8 (HDMI) - Video Signals (Digital)

When reproducing the digital signals in the table below, set the Signal Type option to *Video*.

Resolution	Hf (kHz)	Vf (Hz)	Screen Mode											Remarks
			DOT BY DOT	4:3	FULL (FULL1)	FULL 2	ZOOM	CINEMA	WIDE	WIDE 1	WIDE 2	FULL 14:9	CINEMA 14:9	
480i	15.8	60.0	-	Yes	Yes	-	Yes	Yes	Yes	-	-	Yes	Yes	
480p	31.5	60.0	-	Yes	Yes	-	Yes	Yes	Yes	-	-	Yes	Yes	
576i	15.6	50.0	-	Yes	Yes	-	Yes	Yes	Yes	-	-	Yes	Yes	
576p	31.3	50.0	-	Yes	Yes	-	Yes	Yes	Yes	-	-	Yes	Yes	
720p	37.5	50.0	-	Yes	Yes	-	Yes	-	-	Yes	Yes	-	-	
720p	45.0	60.0	-	Yes	Yes	-	Yes	-	-	Yes	Yes	-	-	
1080i	28.1	50.0	Yes	Yes	Yes	Yes	Yes	-	-	Yes	Yes	-	-	
1080i	33.8	60.0	Yes	Yes	Yes	Yes	Yes	-	-	Yes	Yes	-	-	
1080p	27.0	24.0	Yes	Yes	Yes	Yes	Yes	-	-	Yes	Yes	-	-	
1080p	56.3	50.0	Yes	Yes	Yes	Yes	Yes	-	-	Yes	Yes	-	-	
1080p	67.5	60.0	Yes	Yes	Yes	Yes	Yes	-	-	Yes	Yes	-	-	

9.2.4 INPUT 3 (D-Sub) - PC Signals (Analog)

When reproducing the analog signals in the table below, set the Color Decoding option to *RGB*. If the picture does not appear properly, change the Signal Format setting to the desired resolution.

Resolution Dot-Line	Hf (kHz)	Vf (Hz)	Screen Mode											Remarks	
			DOT BY DOT	4:3	FULL (FULL1)	FULL2	ZOOM	CINEMA	WIDE	WIDE 1	WIDE 2	FULL 14:9	CINEMA 14:9		
720 × 400	31.5	70.1	-	Yes	Yes	-	-	-	-	-	-	-	-	-	
640 × 480	31.5	59.9	-	Yes	Yes	-	-	-	-	-	-	-	-	-	
640 × 480	35.0	66.7	-	Yes	Yes	-	-	-	-	-	-	-	-	-	Apple Macintosh 13
640 × 480	37.9	72.8	-	Yes	Yes	-	-	-	-	-	-	-	-	-	
640 × 480	37.5	75.0	-	Yes	Yes	-	-	-	-	-	-	-	-	-	
640 × 480	43.3	85.0	-	Yes	Yes	-	-	-	-	-	-	-	-	-	
720 × 480	31.5	60.0	-	Yes	Yes	-	-	-	-	-	-	-	-	-	
720 × 480	27.2	71.9	-	Yes	Yes	-	-	-	-	-	-	-	-	-	
848 × 480	31.0	60.0	-	Yes	Yes	-	-	-	-	-	-	-	-	-	
800 × 600	35.2	56.3	-	Yes	Yes	-	-	-	-	-	-	-	-	-	
800 × 600	37.9	60.3	-	Yes	Yes	-	-	-	-	-	-	-	-	-	
800 × 600	48.1	72.2	-	Yes	Yes	-	-	-	-	-	-	-	-	-	
800 × 600	46.9	75.0	-	Yes	Yes	-	-	-	-	-	-	-	-	-	
800 × 600	53.7	85.1	-	Yes	Yes	-	-	-	-	-	-	-	-	-	
832 × 624	49.7	74.6	-	Yes	Yes	-	-	-	-	-	-	-	-	-	Apple Macintosh 16
1280 × 720	44.8	60.0	-	Yes	Yes	-	-	-	-	-	-	-	-	-	
1280 × 720	18.4	71.9	-	Yes	Yes	-	-	-	-	-	-	-	-	-	
1360 × 768	47.7	60.0	-	Yes	Yes	-	-	-	-	-	-	-	-	-	
1280 × 768	47.8	59.9	-	Yes	Yes	-	-	-	-	-	-	-	-	-	
1024 × 768	48.4	60.0	-	Yes	Yes	-	-	-	-	-	-	-	-	-	
1024 × 768	56.5	70.1	-	Yes	Yes	-	-	-	-	-	-	-	-	-	
1024 × 768	60.0	75.0	-	Yes	Yes	-	-	-	-	-	-	-	-	-	
1024 × 768	68.7	85.0	-	Yes	Yes	-	-	-	-	-	-	-	-	-	
1024 × 768	58.0	71.9	-	Yes	Yes	-	-	-	-	-	-	-	-	-	
1024 × 768	60.2	74.9	-	Yes	Yes	-	-	-	-	-	-	-	-	-	Apple Macintosh 19
1280 × 768	56.0	69.8	-	Yes	Yes	-	-	-	-	-	-	-	-	-	CVT
1280 × 768	57.8	72.1	-	Yes	Yes	-	-	-	-	-	-	-	-	-	
1280 × 800	49.7	60.0	-	Yes	Yes	-	-	-	-	-	-	-	-	-	
1152 × 864	53.7	60.0	-	Yes	Yes	-	-	-	-	-	-	-	-	-	
1152 × 864	67.5	75.0	-	Yes	Yes	-	-	-	-	-	-	-	-	-	

Resolution Dot-Line	Hf (kHz)	Vf (Hz)	Screen Mode											Remarks	
			DOT BY DOT	4:3	FULL (FULL1)	FULL2	ZOOM	CINEMA	WIDE	WIDE 1	WIDE 2	FULL 14:9	CINEMA 14:9		
1152 × 870	68.7	75.1	-	Yes	Yes	-	-	-	-	-	-	-	-	-	Apple Macintosh 21
1280 × 960	60.0	60.0	-	Yes	Yes	-	-	-	-	-	-	-	-	-	
1280 × 960	85.9	85.0	-	Yes	Yes	-	-	-	-	-	-	-	-	-	
1280 × 1024	64.0	60.0	-	Yes	Yes	-	-	-	-	-	-	-	-	-	
1280 × 1024	80.0	75.0	-	Yes	Yes	-	-	-	-	-	-	-	-	-	
1440 × 900	56.0	60.0	-	Yes	Yes	-	-	-	-	-	-	-	-	-	Apple Macintosh 17
1400 × 1050	65.3	60.0	-	Yes	Yes	-	-	-	-	-	-	-	-	-	CVT
1400 × 1050	82.3	74.9	-	Yes	Yes	-	-	-	-	-	-	-	-	-	
1400 × 1050	93.9	85.0	-	Yes	Yes	-	-	-	-	-	-	-	-	-	
1680 × 1050	65.3	60.0	-	Yes	Yes	-	-	-	-	-	-	-	-	-	
1280 × 1024	91.1	85.0	-	Yes	Yes	-	-	-	-	-	-	-	-	-	
1920 × 1080	67.5	60.0	-	Yes	Yes	-	-	-	-	-	-	-	-	-	
1600 × 1200	75.0	60.0	-	Yes	Yes	-	-	-	-	-	-	-	-	-	
1600 × 1200	81.3	65.0	-	Yes	Yes	-	-	-	-	-	-	-	-	-	
1600 × 1200	87.5	70.0	-	Yes	Yes	-	-	-	-	-	-	-	-	-	
1600 × 1200	93.8	75.0	-	Yes	Yes	-	-	-	-	-	-	-	-	-	
1600 × 1200	106.3	85.0	-	Yes	Yes	-	-	-	-	-	-	-	-	-	
1920 × 1200	74.6	60.0	-	Yes	Yes	-	-	-	-	-	-	-	-	-	
1920 × 1200RB	74.0	60.0	-	Yes	Yes	-	-	-	-	-	-	-	-	-	

9.2.5 INPUT 4 (DVI)/INPUT 5 through 8 (HDMI) - PC Signals (Digital)

When reproducing the digital signals in the table below, set the Signal Type option to *PC*. If the picture does not appear properly, change the Signal Format setting to the desired resolution.

Resolution Dot-Line	Hf (kHz)	Vf (Hz)	Screen Mode											Remarks	
			DOT BY DOT	4:3	FULL (FULL1)	FULL2	ZOOM	CINEMA	WIDE	WIDE 1	WIDE 2	FULL 14:9	CINEMA 14:9		
720 × 400	31.5	70.1	-	Yes	Yes	-	-	-	-	-	-	-	-	-	
640 × 480	31.5	59.9	-	Yes	Yes	-	-	-	-	-	-	-	-	-	
640 × 480	37.9	72.8	-	Yes	Yes	-	-	-	-	-	-	-	-	-	
640 × 480	37.5	75.0	-	Yes	Yes	-	-	-	-	-	-	-	-	-	
640 × 480	43.3	85.0	-	Yes	Yes	-	-	-	-	-	-	-	-	-	
848 × 480	31.0	60.0	-	Yes	Yes	-	-	-	-	-	-	-	-	-	
800 × 600	35.2	56.3	-	Yes	Yes	-	-	-	-	-	-	-	-	-	
800 × 600	37.9	60.3	-	Yes	Yes	-	-	-	-	-	-	-	-	-	

Resolution Dot-Line	Hf (kHz)	Vf (Hz)	Screen Mode											Remarks	
			DOT BY DOT	4:3	FULL (FULL1)	FULL2	ZOOM	CINEMA	WIDE	WIDE 1	WIDE 2	FULL 14:9	CINEMA 14:9		
800 × 600	48.1	72.2	-	Yes	Yes	-	-	-	-	-	-	-	-	-	
800 × 600	46.9	75.0	-	Yes	Yes	-	-	-	-	-	-	-	-	-	
800 × 600	53.7	85.1	-	Yes	Yes	-	-	-	-	-	-	-	-	-	
1360 × 768	47.7	60.0	-	Yes	Yes	-	-	-	-	-	-	-	-	-	
1280 × 768	47.8	59.9	-	Yes	Yes	-	-	-	-	-	-	-	-	-	
1024 × 768	48.4	60.0	-	Yes	Yes	-	-	-	-	-	-	-	-	-	
1024 × 768	56.5	70.1	-	Yes	Yes	-	-	-	-	-	-	-	-	-	
1024 × 768	60.0	75.0	-	Yes	Yes	-	-	-	-	-	-	-	-	-	
1024 × 768	68.7	85.0	-	Yes	Yes	-	-	-	-	-	-	-	-	-	
1024 × 768	58.0	71.9	-	Yes	Yes	-	-	-	-	-	-	-	-	-	
1280 × 768	56.0	69.8	-	Yes	Yes	-	-	-	-	-	-	-	-	-	CVT
1280 × 768	57.8	72.1	-	Yes	Yes	-	-	-	-	-	-	-	-	-	
1280 × 800	49.7	60.0	-	Yes	Yes	-	-	-	-	-	-	-	-	-	
1152 × 864	53.7	60.0	-	Yes	Yes	-	-	-	-	-	-	-	-	-	
1152 × 864	67.5	75.0	-	Yes	Yes	-	-	-	-	-	-	-	-	-	
1280 × 960	60.0	60.0	-	Yes	Yes	-	-	-	-	-	-	-	-	-	
1280 × 960	85.9	85.0	-	Yes	Yes	-	-	-	-	-	-	-	-	-	
1280 × 1024	64.0	60.0	-	Yes	Yes	-	-	-	-	-	-	-	-	-	
1280 × 1024	80.0	75.0	-	Yes	Yes	-	-	-	-	-	-	-	-	-	
1440 × 900	56.0	60.0	-	Yes	Yes	-	-	-	-	-	-	-	-	-	Apple Macintosh 17
1400 × 1050	65.3	60.0	-	Yes	Yes	-	-	-	-	-	-	-	-	-	CVT
1400 × 1050	82.3	74.9	-	Yes	Yes	-	-	-	-	-	-	-	-	-	
1680 × 1050	65.3	60.0	-	Yes	Yes	-	-	-	-	-	-	-	-	-	
1280 × 1024	91.1	85.0	-	Yes	Yes	-	-	-	-	-	-	-	-	-	
1600 × 1200	75.0	60.0	-	Yes	Yes	-	-	-	-	-	-	-	-	-	
1920 × 1200RB	74.0	60.0	-	Yes	Yes	-	-	-	-	-	-	-	-	-	

Banner PIP supports 1360 x 768 and 1024 x 768 signals.

9.3 Specifications

For specifications, see the separate Specifications Sheet.

9.4 Trademarks

Trademarks

- HDMI, the HDMI logo and High-Definition Multimedia Interface are trademarks or registered trademarks of HDMI Licensing LLC.



- Apple and Macintosh are registered trademarks of Apple Inc.
- Microsoft is a registered trademark of Microsoft Corporation.
- VESA and DDC are registered trademarks of Video Electronics Standards Association.
- Power Management and Sun Microsystems are registered trademarks of Sun Microsystems, Inc.
- VGA and XGA are registered trademarks of International Business Machines Co., Inc.

9.5 Glossary

VGA (Video Graphics Array)

VGA is used for a resolution of 640 x 480.

Wide-VGA (Wide Video Graphics Array)

Wide-VGA is used for a resolution of 848 x 480.

SVGA (Super Video Graphics Array)

SVGA is used for a resolution of 800 x 600.

XGA (eXtended Graphics Array)

XGA is used for a resolution of 1024 x 768.

Wide-XGA (Wide eXtended Graphics Array)

Wide-XGA is used for a resolution of 1280 x 768.

SXGA (Super eXtended Graphics Array)

SXGA is used for a resolution of 1280 x 1024.

SXGA+ (Super eXtended Graphics Array+)

SXGA+ is used for a resolution of 1400 x 1050.

Wide-SXGA (Wide Super eXtended Graphics Array)

Wide-SXGA is used for a resolution of 1680 x 1050.

UXGA (Ultra eXtended Graphics Array)

UXGA is used for a resolution of 1600 x 1200.

Wide-UXGA (Wide Ultra eXtended Graphics Array)

Wide-UXGA is used for a resolution of 1920 x 1200.

DVI

The Digital Visual Interface (DVI) is a video interface standard developed by an industry consortium, the Digital Display Working Group (DDWG). DVI is designed to maximize the visual quality of digital display devices such as a flat panel display.

HDMI

The High-Definition Multimedia Interface (HDMI) is a digital data transmission standard for consumer electronics/home appliances. HDMI connects digital audio/video sources to a compatible digital audio and/or video device, such as a flat panel display. HDMI also allows digitally transmitted audio and control signals on a single cable for multi-channel digital audio sources.

Component video signal

General term for video signal format composed of the Y.CBCr, Y.PbPr and Y.B-Y.R-Y luminance signal + color signal. The component video signal is sometimes simply called the "color difference signal."

DHCP

The Dynamic Host Configuration Protocol (DHCP) provides a mechanism to automatically allocate network settings such as IP Address, Default Gateway and Subnet mask. A DHCP server must be activated on a network to use the DHCP function.

DNS

The Domain Name Service (DNS) server functions to exchange IP Address to the hostname, hostname to the IP Address.

POP before SMTP

POP before SMTP is a method of authorization using POP (Post Office Protocol) before sending an E-mail via SMTP (Simple Mail Transfer Protocol).

SMTP

The Simple Mail Transfer Protocol (SMTP) is a text-based protocol in which a message is transferred between a client and server or between servers.

9.6 Index

Numerics

2-screen10, 11, 43

A

Auto Size28, 33, 36

AV Selection31, 32

B

Blue35

Brightness35

Brightness Sync37, 77

C

CBL10, 49

Color25, 32, 35

Contrast25, 31, 32, 35

E

Energy Save28, 29, 45

F

Film Mode38

Freeze44, 80

G

GAME18, 31, 39, 62

Game Control Pref.39

Green35, 51

H

HD Wide Mode36

HDMI Input54

HDMI port56

HDMI terminal18, 54

HOME MENU10

I

Input10

Installation12, 80

K

KURO LINK54, 56

KURO LINK Setting58

L

Language24, 56

Long Life Settings28, 76, 82

M

MOVIE10, 27, 31

multi-screen43, 44

O

OPTIMUM10, 31

Orbiter29, 82

P

Picture-in-picture10, 11, 43

Position26

Power21, 29, 45

Power Control62

Power Management45

R

Red35

Remote Control8, 10, 46

Room Light Sensor25

S

SAT10, 49

SCREEN SIZE11, 33

Sharpness32, 35

SHIFT11, 43

Side Mask28, 37

Side Mask Detection36

Sleep Timer30

SPORT10, 31

STANDARD10, 31, 32

SWAP11, 43

T

Text Optimization38

Tint35

U

USER10, 31, 32

USER MENU23

Register Your Product on

<http://www.pioneerelectronics.com> (US)

<http://www.pioneerelectronics.ca> (Canada)

PIONEER CORPORATION

4-1, Meguro 1-Chome, Meguro-ku, Tokyo 153-8654, Japan

PIONEER ELECTRONICS (USA) INC.

P.O. BOX 1540, Long Beach, California 90801-1540, U.S.A. TEL: (800) 421-1404

PIONEER ELECTRONICS OF CANADA, INC.

300 Allstate Parkway, Markham, Ontario L3R 0P2, Canada TEL: 1-877-283-5901, 905-479-4411

PIONEER EUROPE NV

Haven 1087, Keetberglaan 1, B-9120 Melsele, Belgium TEL: 03/570.05.11

PIONEER ELECTRONICS ASIACENTRE PTE. LTD.

253 Alexandra Road, #04-01, Singapore 159936 TEL: 65-6472-7555

PIONEER ELECTRONICS AUSTRALIA PTY. LTD.

178-184 Boundary Road, Braeside, Victoria 3195, Australia, TEL: (03) 9586-6300

PIONEER ELECTRONICS DE MEXICO S.A. DE C.V.

Bldv.Manuel Avila Camacho 138 10 piso Col.Lomas de Chapultepec, Mexico, D.F. 11000 TEL: 55-9178-4270

K002_B_En

Published by Pioneer Corporation.
Copyright © 2008 Pioneer Corporation.
All rights reserved.

Free Manuals Download Website

<http://myh66.com>

<http://usermanuals.us>

<http://www.somanuals.com>

<http://www.4manuals.cc>

<http://www.manual-lib.com>

<http://www.404manual.com>

<http://www.luxmanual.com>

<http://aubethermostatmanual.com>

Golf course search by state

<http://golfingnear.com>

Email search by domain

<http://emailbydomain.com>

Auto manuals search

<http://auto.somanuals.com>

TV manuals search

<http://tv.somanuals.com>