

**Multi-CD control High power CD player  
with FM/AM tuner**

**Syntoniseur FM/AM et lecteur de CD, “Puissance élevée”,  
avec contrôleur pour lecteur de CD à chargeur**

**SUPER  TUNER III**

---

# **Operation Manual**

**DEH-P3300  
DEH-P33**

**Mode d'emploi**

***Pioneer***

ENGLISH

FRANÇAIS

ESPAÑOL

<b>Dear Customer</b> .....	<b>3</b>
<b>Key Finder</b> .....	<b>4</b>
● Head Unit	
● Remote Controller (CD-R600)	
<b>Before Using This Product</b> .....	<b>5</b>
About This Product .....	5
About This Manual .....	5
Important .....	5
Precaution .....	6
After-sales Service for Pioneer Products .....	6
When using the 50-Disc Type	
Multi-CD Player .....	6
About the XM READY Mark .....	7
<b>Basic Operation</b> .....	<b>8</b>
To Listen to Music .....	8
Basic Operation of Tuner .....	10
● Manual and Seek Tuning	
● Preset Tuning	
● Band	
Basic Operation of Built-in CD Player .....	11
● Switching the Display	
● Open	
● Track Search and Fast Forward/Reverse	
● CD Loading Slot	
● Eject	
Basic Operation of Multi-CD Player .....	13
● Track Search and Fast Forward/Reverse	
● Disc Search	
● Disc Number Search	
(for 6-Disc, 12-Disc types)	
Corresponding Display Indications and	
Buttons .....	14
Entering the Function Menu .....	14
Function Menu Functions .....	15
Entering the Detailed Setting Menu .....	16
Detailed Setting Menu Functions .....	17
PGM Button Functions .....	17
<b>Tuner Operation</b> .....	<b>18</b>
● Local Seek Tuning (LOCAL)	
● Best Stations Memory (BSM)	
<b>Using the Built-in CD Player</b> .....	<b>19</b>
● Repeat Play (REPEAT)	
● Random Play (RANDOM)	
● Scan Play (T-SCAN)	
● Pause (PAUSE)	
● Disc Title Input (TITLE IN)	
<b>Using Multi-CD Players</b> .....	<b>21</b>
● Repeat Play (REPEAT)	
● Random Play (RANDOM)	
● Scan Play (SCAN)	
● Pause (PAUSE)	
ITS (Instant Track Selection) .....	23
● ITS Programming (ITS)	
● ITS Play (ITS-P)	
● Erase a Track Program	
● Erase a Disc Program	
Disc Title .....	25
● Disc Title Input (TITLE IN)	
● Selecting Discs by Disc Title List	
(TITLE LIST)	
● Displaying Disc Title	
Compression and DBE (COMP) .....	27
● COMP/DBE ON/OFF Switching	
CD TEXT Function (for CD TEXT	
compatible type) .....	28
● Title Display Switching	
● Title Scroll	

<b>Audio Adjustment</b> .....	<b>29</b>	<b>CD Player and Care</b> .....	<b>42</b>
Setting the Sound Focus Equalizer (SFEQ) ....	29	Precaution .....	42
● About the Sound Focus Equalizer (SFEQ)		Built-in CD Player's Error Message .....	43
Selecting the Equalizer Curve .....	30		
● About the Custom Curves			
Entering the Audio Menu .....	31		
Audio Menu Functions .....	31	<b>Specifications</b> .....	<b>44</b>
● Balance Adjustment (FADER)			
● Equalizer Curve Adjustment (EQ-LOW/EQ-MID/EQ-HIGH)			
● Equalizer Curve Fine Adjustment			
● Bass Adjustment (BASS)			
● Treble Adjustment (TRE)			
● Loudness Adjustment (LOUD)			
● Subwoofer Output (SUB.W)			
● Subwoofer Setting Adjustment (80HZ 0)			
● Source Level Adjustment (SLA)			
<b>Detaching and Replacing the</b>			
<b>Front Panel</b> .....	<b>37</b>		
Theft Protection .....	37		
● Detaching the Front Panel			
● Replacing the Front Panel			
● Warning Tone			
<b>Initial Setting</b> .....	<b>38</b>		
Entering the Initial Setting Menu .....	38		
Initial Setting Menu Functions .....	39		
● Setting the Time			
● Setting the Warning Tone (WARN)			
● Switching the AUX Mode (AUX)			
● Setting the Dimmer (DIMMER)			
● Setting the Rear Output (FRT+REAR)			
<b>Other Functions</b> .....	<b>41</b>		
Displaying the Time .....	41		
Using the AUX Source .....	41		
● Selecting the AUX Source			
● AUX Title Input (TITLE IN)			



## Dear Customer:

Selecting fine audio equipment such as the unit you've just purchased is only the start of your musical enjoyment. Now it's time to consider how you can maximize the fun and excitement your equipment offers. This manufacturer and the Electronic Industries Association's Consumer Electronics Group want you to get the most out of your equipment by playing it at a safe level. One that lets the sound come through loud and clear without annoying blaring or distortion—and, most importantly, without affecting your sensitive hearing.

Sound can be deceiving. Over time your hearing “comfort level” adapts to higher volumes of sound. So what sounds “normal” can actually be loud and harmful to your hearing. Guard against this by setting your equipment at a safe level BEFORE your hearing adapts.

### To establish a safe level:

- Start your volume control at a low setting.
- Slowly increase the sound until you can hear it comfortably and clearly, and without distortion.

### Once you have established a comfortable sound level:

- Set the dial and leave it there.

Taking a minute to do this now will help to prevent hearing damage or loss in the future. After all, we want you listening for a lifetime.

## We Want You Listening For A Lifetime

Used wisely, your new sound equipment will provide a lifetime of fun and enjoyment. Since hearing damage from loud noise is often undetectable until it is too late, this manufacturer and the Electronic Industries Association's Consumer Electronics Group recommend you avoid prolonged exposure to excessive noise. This list of sound levels is included for your protection.

### Decibel

Level	Example
30	Quiet library, soft whispers
40	Living room, refrigerator, bedroom away from traffic
50	Light traffic, normal conversation, quiet office
60	Air conditioner at 20 feet, sewing machine
70	Vacuum cleaner, hair dryer, noisy restaurant
80	Average city traffic, garbage disposals, alarm clock at two feet.

### THE FOLLOWING NOISES CAN BE DANGEROUS UNDER CONSTANT EXPOSURE

90	Subway, motorcycle, truck traffic, lawn mower
100	Garbage truck, chain saw, pneumatic drill
120	Rock band concert in front of speakers, thunderclap
140	Gunshot blast, jet plane
180	Rocket launching pad

Information courtesy of the Deafness Research Foundation.



## Head Unit

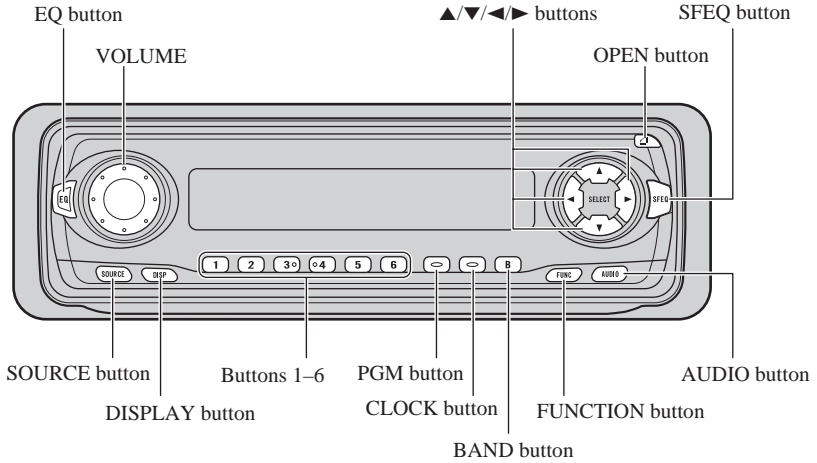

## Remote Controller (CD-R600)

The remote controller (CD-R600) enabling remote control of the head unit is sold separately. Operation is the same as when using buttons on the head unit.

### ATT button

This lets you quickly lower volume level (by about 90%).  
Press once more to return to the original volume level.

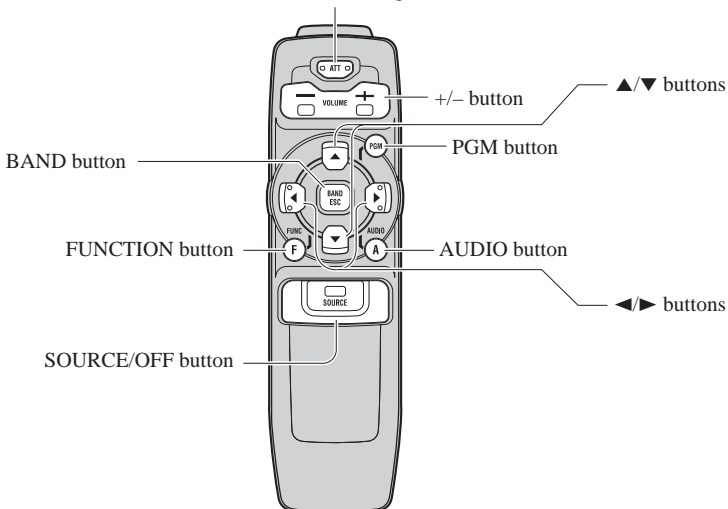

## *Before Using This Product*

### **About This Product**

---

The tuner frequencies on this product are allocated for use in North America. Use in other areas may result in improper reception.

### **About This Manual**

---

This product features a number of sophisticated functions ensuring superior reception and operation. All are designed for the easiest possible use, but many are not self-explanatory. This operation manual is intended to help you benefit fully from their potential and to maximize your listening enjoyment.

We recommend that you familiarize yourself with the functions and their operation by reading through the manual before you use this product. It is especially important that you read and observe the "Precaution" on page 6 and in other sections.

This manual explains head unit operation. You can perform the same operations with the remote controller.

### **Important**

---

The serial number of this device is located on the bottom of this product. For your own security and convenience, be sure to record this number on the enclosed warranty card.

## Precaution

**CAUTION: USE OF CONTROL OR ADJUSTMENT OR PERFORMANCE OF PROCEDURES OTHER THAN THOSE SPECIFIED HEREIN MAY RESULT IN HAZARDOUS RADIATION EXPOSURE.**

**CAUTION: THE USE OF OPTICAL INSTRUMENTS WITH THIS PRODUCT WILL INCREASE EYE HAZARD.**

- Keep this manual handy as a reference for operating procedures and precautions.
- Always keep the volume low enough for outside sounds to be audible.
- Protect the product from moisture.
- If the battery is disconnected, the preset memory will be erased and must be reprogrammed.

## After-sales Service for Pioneer Products

Please contact the dealer or distributor from where you purchased the product for its after-sales service (including warranty conditions) or any other information. In case the necessary information is not available, please contact the companies listed below:

Please do not ship your product to the companies at the addresses listed below for repair without advance contact.

### ■ U.S.A.

Pioneer Electronics Service, Inc.  
CUSTOMER SERVICE  
DEPARTMENT  
P.O. Box 1760  
Long Beach, CA 90801  
800-421-1404

### ■ CANADA

Pioneer Electronics of Canada, Inc.  
CUSTOMER SERVICE DEPARTMENT  
300 Allstate Parkway  
Markham, Ontario L3R OP2  
(905) 479-4411  
1-877-283-5901

For warranty information please see the Limited Warranty sheet included with your product.

## When using the 50-Disc Type Multi-CD Player

The available functions of the 50-Disc Type Multi-CD Player are described in this Operation Manual. Note that other 50-Disc Type Multi-CD Player functions cannot be used with this product.

# Before Using This Product

## About the XM READY Mark



The "XM READY" mark printed on the front panel of this product indicates that the Pioneer XM tuner (sold separately) can be controlled using this product.

Please inquire of your dealer or nearest authorized Pioneer service station regarding the XM tuner that can be connected to this product.

For operation of the XM tuner, refer to the XM tuner owner's manual.

### Note:



- XM Satellite Radio is developing a new band of radio in the U.S.A. The system will use direct satellite-to-receiver broadcasting technology to provide listeners in their cars and at home with crystal-clear sound seamlessly from coast to coast. XM will create and package up to 100 channels of digital-quality music, news, sports, talk and children's programming.
- When this product is connected to the XM tuner, do not connect it to any other external unit. (Refer to page 8.)



## To Listen to Music

The following explains the initial operations required before you can listen to music.

**Note:**

- Loading a disc in this product. (Refer to page 11.)

### 1. Select the desired source. (e.g. Tuner)

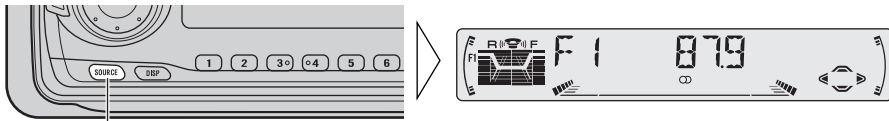

Each press changes the Source ...

Each press of the SOURCE button selects the desired source in the following order:  
Built-in CD player → TV → Tuner → Multi-CD player → External Unit → AUX

**Note:**

- External Unit refers to a Pioneer product (such as one available in the future) that, although incompatible as a source, enables control of basic functions by this product. Only one External Unit can be controlled by this product.
- In the following cases, the sound source will not change:
  - \* When a product corresponding to each source is not connected to this product.
  - \* When no disc is set in this product.
  - \* When no magazine is set in the Multi-CD player.
  - \* When the AUX (external input) is set to OFF. (Refer to page 39.)
- When this product's blue/white lead is connected to the car's Auto-antenna relay control terminal, the car's Auto-antenna extends when this product's source is switched ON. To retract the antenna, switch the source OFF.

Continued overleaf.

## 2. Raise or lower the volume.



Rolling the VOLUME changes the volume level.

### Note:

- Roll clockwise to raise the volume level.
- Roll counterclockwise to lower the volume level.

## 3. Turn the source OFF.

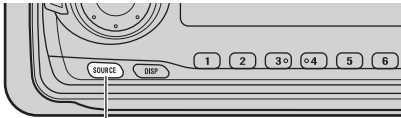

Hold for 1 second

## Basic Operation of Tuner

### Manual and Seek Tuning

- You can select the tuning method by changing the length of time you press the ◀▶ button.

Manual Tuning (step by step)	0.5 seconds or less
Seek Tuning	0.5 seconds or more

#### Note:

- If you continue pressing the button for longer than 0.5 seconds, you can skip broadcasting stations. Seek Tuning starts as soon as you release the button.
- Stereo indicator "◉" lights when a stereo station is selected.

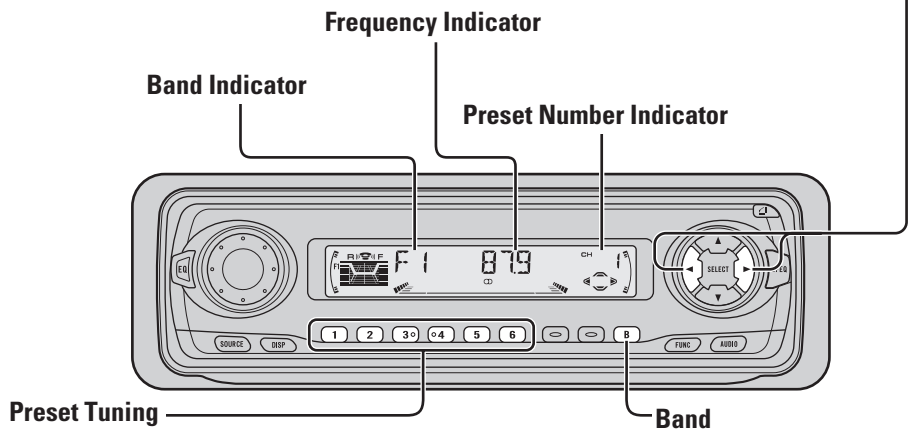

- You can memorize broadcast stations in buttons 1 through 6 for easy, one-touch station recall.

Preset station recall	2 seconds or less
Broadcast station preset memory	2 seconds or more

F1 (FM1) → F2 (FM2)  
→ F3 (FM3) → AM

#### Note:

- Up to 18 FM stations (6 in F1 (FM1), F2 (FM2) and F3 (FM3)) and 6 AM stations can be stored in memory.
- You can also use the ▲ or ▼ buttons to recall broadcast stations memorized in buttons 1 through 6.

## Basic Operation of Built-in CD Player

### Note:

- Be sure to close the front panel after loading or ejecting a disc.

### Switching the Display

Each press of the DISPLAY button changes the display in the following order:

Playback mode (Play time)

→ Disc Title

### Note:

- If you switch displays when disc titles have not been input, "NO TITLE" is displayed.

### Open

### Note:

- Use to open the front panel when loading or ejecting a CD. (The illustration on the right shows the front panel open.)

Track Number Indicator

Play Time Indicator



### Track Search and Fast Forward/Reverse

- You can select between Track Search or Fast Forward/Reverse by pressing the ◀/▶ button for a different length of time.

Track Search	0.5 seconds or less
Fast Forward/Reverse	Continue pressing

### CD Loading Slot

**Note:**

- The Built-in CD player plays one standard 12 cm or 8 cm (single) CD at a time. Do not use an adapter when playing 8 cm CD.
- Do not insert anything other than a CD into the CD Loading Slot.

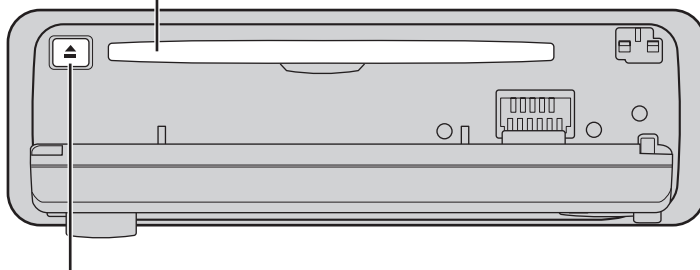

### Eject

**Note:**

- The CD function can be turned ON/OFF with the disc remaining in this product. (Refer to page 8.)
- A disc left partially inserted after ejection may incur damage or fall out.

**Note:**

- If a disc cannot be inserted fully or playback fails, make sure the recorded side is down. Press the EJECT button and check the disc for damage before reinserting it.
- If the Built-in CD player cannot operate properly, an error message (such as "ERROR-14") appears on the display. Refer to "Built-in CD Player's Error Message" on page 43.
- The Built-in CD player is not equipped with CD TEXT function.
- A CD TEXT disc is a CD featuring recorded text information such as Disc Title, Artist Name and Track Title.

## Basic Operation of Multi-CD Player

This product can control a Multi-CD player (sold separately).

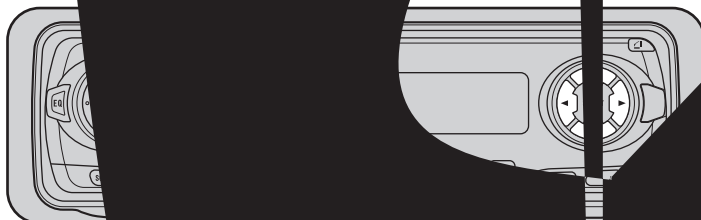

## Corresponding Display Indications and Buttons

This product's display features Key Guidance Indicators. These light to indicate which of the ▲/▼/◀/▶, FUNCTION and AUDIO buttons you can use. When you're in the Function Menu (refer to next section), Detailed Setting Menu (refer to page 16), Initial Setting Menu (refer to page 38) or Audio Menu (refer to page 31), they also make it easy to see which ▲/▼/◀/▶ buttons you can use to switch functions ON/OFF, switch repeat selections and perform other operations.

Indicator and corresponding buttons are shown below.

### ■ Head Unit

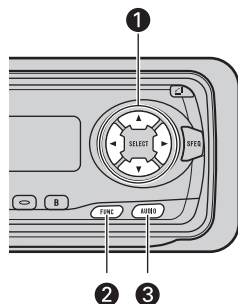

### ■ Remote Controller

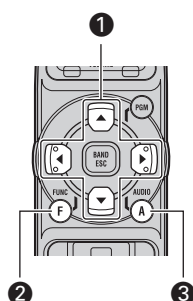

### ■ Display

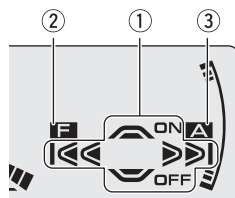

When ① is lit in the display, perform appropriate operations with the ① buttons.

When ② is lit in the display, it indicates that you are in the Function Menu, Detailed Setting Menu or Initial Setting Menu. You can switch between each of these menus and between different modes in the menus using button ② on the head unit or remote controller.

When ③ is lit in the display, it indicates you are in the Audio Menu. You can switch between modes in the Audio Menu using button ③ on the head unit or remote controller.

## Entering the Function Menu

The Function Menu lets you operate simple functions for each source.

### Note:

- After entering the Function Menu, if you do not perform an operation within about 30 seconds, the Function Menu is automatically canceled.

### 1. Select the desired mode in the Function Menu. (Refer to next section, "Function Menu Functions".)



Each press changes the Mode ...

Continued overleaf.

## 2. Operate a mode. (e.g. Repeat Play)

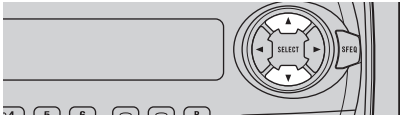

The button used and the operation it performs are indicated by the key guidance indicator. Press the ▲ button to switch the key guidance indicator ON, and the ▼ button to switch it OFF.

## 3. Cancel the Function Menu.

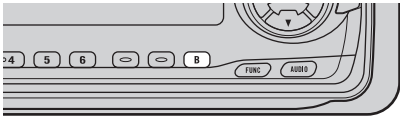

## Function Menu Functions

The following chart shows functions for each source in the Function Menu. The chart also shows indications for each function, operations and buttons used to perform operations. For more details, or when you want to know about an operation, refer to the page number indicated in the chart.

### ■ Tuner

Function name (Display)	Button: Operation	Page
Best Stations Memory (BSM)	▲: ON ▼: OFF	18
Local Seek Tuning (LOCAL)	1 ▲: ON ▼: OFF 2 ◀ or ▶: Select (Sensitivity)	18

### ■ Built-in CD Player

Function name (Display)	Button: Operation	Page
Repeat Play (REPEAT)	▲: ON ▼: OFF	19
Random Play (RANDOM)	▲: ON ▼: OFF	19
Scan Play (T-SCAN)	▲: ON ▼: OFF	20
Pause (PAUSE)	▲: ON ▼: OFF	20



## ■ Multi-CD Player

Function name (Display)	Button: Operation	Page
Repeat Play (REPEAT)	◀ or ▶: Select (Play range)	21
Selecting Discs by Disc Title List (TITLE LIST)	1 ▶ or ▶: Select (Disc Title) 2 ▲: Play	26
Random Play (RANDOM)	▲: ON ▼: OFF	21
Scan Play (SCAN)	▲: ON ▼: OFF	22
ITS Play (ITS-P)	▲: ON ▼: OFF	23
Pause (PAUSE)	▲: ON ▼: OFF	22
Compression and DBE (COMP)	▲ or ▼: Select (Sound Quality Function)	27

## Entering the Detailed Setting Menu

In the Detailed Setting Menu, you can operate convenient, complex functions for each source.

### 1. Enter the Detailed Setting Menu.

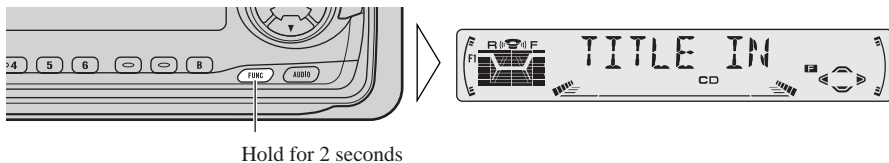

### 2. Select the desired mode. (Refer to next section, “Detailed Setting Menu Functions”.)

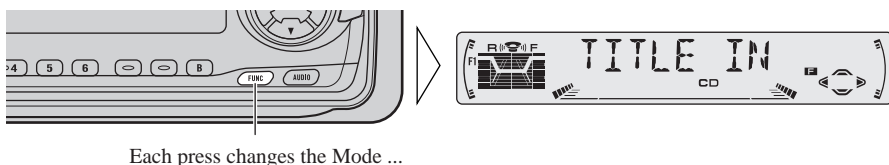

### 3. Operate a mode.

Continued overleaf.

#### 4. Cancel the Detailed Setting Menu.

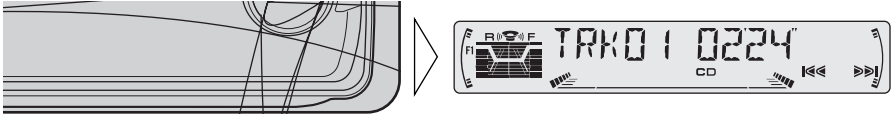

**Note:**

- You can cancel the Detailed Setting Menu by pressing the FUNCTION button again for 2 seconds.

### Detailed Setting Menu Functions

The following chart shows functions for each source in the Detailed Setting Menu. The chart also shows indications for each function, operations and buttons used to perform operations. For more details, or when you want to know about an operation, refer to the page number indicated in the chart.

**Note:**

- Tuner has no Detailed Setting Menu.

#### ■ Built-in CD Player

Function name (Display)	Button: Operation	Page
Disc Title Input (TITLE IN)	1 ▲ or ▼: Select (Letter) 2 ◀ or ▶: Select (Position) 3 ►: Memory	20

#### ■ Multi-CD Player

Function name (Display)	Button: Operation	Page
Disc Title Input (TITLE IN)	1 ▲ or ▼: Select (Letter) 2 ◀ or ▶: Select (Position) 3 ►: Memory	25
ITS Programming (ITS)	▲: Memory	23

### PGM Button Functions

The following chart shows functions for each source by pressing PGM button. For more details, or when you want to know about an operation, refer to the page number indicated in the chart.

#### ■ PGM

Source	Function name	Page
Tuner	Best Stations Memory (OFF)	18
	Best Stations Memory (ON) (Hold for 2 seconds)	18
Built-in CD player	Pause	20
Multi-CD player	Pause	22
TV	Best Station Sequential Memory (OFF)	—
	Best Station Sequential Memory (ON) (Hold for 2 seconds)	—

**Note:**

- For the details of TV functions, refer to the TV's manual.

## Local Seek Tuning (LOCAL)

When Local is ON, you can only select broadcast stations providing strong reception.

1. Press the **FUNCTION** button and select the **Local mode (LOCAL)** in the **Function Menu**.
2. Switch the **Local ON/OFF** with the **▲/▼** buttons.



3. Select the desired **Local Seek sensitivity** with the **◀/▶** buttons.



FM : LOCAL 1 ↔ LOCAL 2 ↔ LOCAL 3 ↔ LOCAL 4

AM : LOCAL 1 ↔ LOCAL 2

### Note:

- The LOCAL 4 setting allows reception of only the strongest stations, while lower settings let you receive progressively weaker stations.

## Best Stations Memory (BSM)

The BSM function stores stations in memory automatically.

1. Press the **FUNCTION** button and select the **BSM mode (BSM)** in the **Function Menu**.
2. Switch the **BSM ON** with the **▲** button.

The stations with the strongest signals will be stored under buttons 1–6 and in order of their signal strength.



### Note:

- You can also switch the BSM function ON by pressing the PGM button for 2 seconds.
- To cancel the process, press the **▼** button in the **Function Menu** before memorization is complete.



### Note:

- You can also switch the BSM function OFF by pressing the PGM button.

## Repeat Play (REPEAT)

Repeat Play plays the same track repeatedly.

1. Press the **FUNCTION** button and select the **Repeat mode (REPEAT)** in the **Function Menu**.
2. Switch the **Repeat Play ON/OFF** with the **▲/▼** buttons.

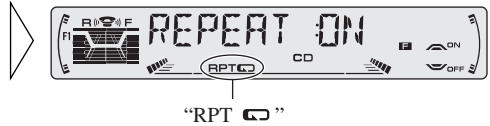

### **Note:**

- If you perform Track Search or Fast Forward/Reverse, Repeat Play is automatically canceled.

## Random Play (RANDOM)

Random Play plays the tracks on a CD in random order for variety.

1. Press the **FUNCTION** button and select the **Random mode (RANDOM)** in the **Function Menu**.
2. Switch the **Random Play ON/OFF** with the **▲/▼** buttons.



## Scan Play (T-SCAN)

Scan Play plays the first 10 seconds or so of each track on a CD in succession.

1. Press the **FUNCTION** button and select the **Scan mode (T-SCAN)** in the **Function Menu**.
2. Switch the **Scan Play ON** with the **▲** button.



3. When you find the desired track, cancel the **Scan Play** with the **▼** button.

If the Function Menu has been canceled automatically, select the Scan mode in the Function Menu again.



### **Note:**

- Scan Play is canceled automatically after all the tracks on a disc have been scanned.

## Pause (PAUSE)

Pause pauses the currently playing track.

1. Press the **FUNCTION** button and select the **Pause mode (PAUSE)** in the **Function Menu**.
2. Switch the **Pause ON/OFF** with the **▲/▼** buttons.



### **Note:**

- You can also switch the Pause function ON/OFF by pressing the PGM button.

## Disc Title Input (TITLE IN)

You can use "TITLE IN" to input up to 48 disc titles for CDs in the Built-in CD player. (Perform the same operation as (described) on page 25 under "Using Multi-CD Players".)

### **Note:**

- After the title for 48 discs have been entered, data for a new disc will overwrite the oldest one.
- If you connect a Multi-CD player, you can input disc titles for up to 100 discs.

## Repeat Play (REPEAT)

There are three repeat play ranges: One-track Repeat, Disc Repeat and Multi-CD player Repeat. Default repeat play range is Multi-CD player Repeat.

1. Press the **FUNCTION** button and select the Repeat mode (REPEAT) in the **Function Menu**.
2. Select the desired repeat play range with the **◀/▶** buttons.  
Multi-CD player Repeat → One-track Repeat → Disc Repeat

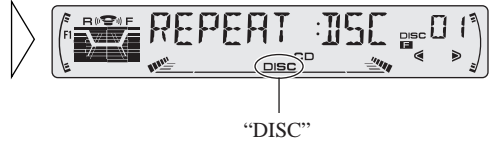

Play range	Display	Indicator
Multi-CD player Repeat	MCD	—
One-track Repeat	TRK	RPT
Disc Repeat	DSC	DISC

### Note:

- If you select other discs during the repeat play, the repeat play range changes to Multi-CD player Repeat.
- If you perform Track Search or Fast Forward/Reverse during One-track Repeat, the repeat play range changes to Disc Repeat.

## Random Play (RANDOM)

Tracks are played at random within the selected repeat play range as explained in “Repeat Play” above.

1. Press the **FUNCTION** button and select the Random mode (RANDOM) in the **Function Menu**.
2. Switch the Random Play **ON/OFF** with the **▲/▼** buttons.



After selecting the desired repeat play range from those referred to in “Repeat Play” above, switch Multi-CD Player Random Play ON.

Display	Play range
DRDM	Disc Repeat
RDM	Multi-CD player Repeat

### Note:

- One-track Repeat changes to the Disc Repeat when you switch the Random Play ON.

## Scan Play (SCAN)

In the Disc Repeat, the beginning of each track on the selected disc is scanned for about 10 seconds. In the Multi-CD player Repeat, the beginning of the first track on each disc is scanned for about 10 seconds.

1. Press the **FUNCTION** button and select the Scan mode (SCAN) in the Function Menu.

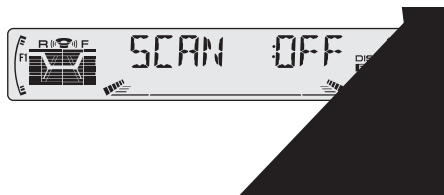

Display	Play range
DSCN	Disc Repeat
SCAN	Multi-CD player Repeat

### Note:

- Scan Play is canceled automatically after all the tracks or discs have been scanned.
- One-track Repeat changes to the Disc Repeat when you switch the Scan Play ON.

## Pause (PAUSE)

Pause pauses the currently playing track.

1. Press the **FUNCTION** button and select the Pause mode (PAUSE) in the Function Menu.
2. Switch the Pause ON/OFF with the **▲/▼** buttons.

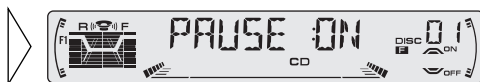

### Note:

- You can also switch the Pause function ON/OFF by pressing the PGM button.

## ITS (Instant Track Selection)

The ITS function allows you to search for the track you wish to play when a Multi-CD player is installed. You can use ITS to program automatic playback of up to 24 tracks per disc from up to 100 discs. (You can store ITS program and Disc Title data for up to 100 discs in memory.)

### ITS Programming (ITS)

Programmed tracks are played within the selected repeat play range in the “Repeat Play” on page 21.

1. Play the track you wish to program.
2. Select the ITS Programming mode (ITS) in the Detailed Setting Menu. (Refer to page 16.)
3. Program the desired track with the ▲ button.



#### Note:

- After 100 discs have been programmed, data for a new disc will overwrite the data for the disc that has not been played back for the longest time.

### ITS Play (ITS-P)

ITS Play of tracks is performed within the play range explained in the “Repeat Play” section.

1. Press the FUNCTION button and select the ITS Play mode (ITS-P) in the Function Menu.
2. Switch the ITS Play ON/OFF with the ▲/▼ buttons.

After selecting the desired repeat play range from those referred to in “Repeat Play” on page 21, switch ITS Play ON.



#### Note:

- If no track in the current range is programmed for ITS Play, “ITS EMPTY” is displayed.



## Erase a Track Program

1. Select the track you wish to erase, during ITS Play.
2. Select the ITS Programming mode (ITS) in the Detailed Setting Menu. (Refer to page 16.)
3. Erase the track program with the ▼ button.

ITS is canceled and playback of the next ITS-programmed track begins. If there are no more programmed tracks in the current range, "ITS EMPTY" is displayed and normal play resumes.



## Erase a Disc Program

1. Select the disc you wish to erase, while the disc is playing.
2. Select the ITS Programming mode (ITS) in the Detailed Setting Menu. (Refer to page 16.)
3. Erase the disc program with the ▼ button.



## Disc Title

### Disc Title Input (TITLE IN)

You can input Titles up to 10 letters long for up to 100 discs. Using this function lets you easily search for and select a desired disc for play. (You can store ITS program and Disc Title data for up to 100 discs in memory.)

1. **Play the disc you wish to input the disc title.**
2. **Select the Disc Title Input mode (TITLE IN) in the Detailed Setting Menu. (Refer to page 16.)**

#### Note:

- When playing a CD TEXT disc on a CD TEXT compatible Multi-CD player, you cannot switch to this mode.
- A CD TEXT disc is a CD featuring recorded text information such as Disc Title, Artist Name and Track Title.

3. **Select letters, numbers and symbols with the ▲/▼ buttons.**

To insert a space, select the flashing cursor “\_”.



4. **Move the box left and right with the ◀/▶ buttons.**



5. **When you have completed title input, make the 10th letter flash, then memorize by pressing the ► button.**



#### Note:

- Titles remain in memory, even after the disc has been removed from the magazine, and are recalled when the disc is reinserted.
- After the titles for 100 discs have been entered, data for a new disc will overwrite the data for the disc that has not been played back for the longest time.
- You can display the disc title of the disc currently playing. For details, refer to “Displaying Disc Title” on page 26.

## Selecting Discs by Disc Title List (TITLE LIST)

Follow the procedures below to play a disc for which you have input the title in a Multi-CD player or a CD TEXT disc on a CD TEXT compatible Multi-CD player.

1. Press the **FUNCTION** button and select the **Disc Title List mode (TITLE LIST)** in the **Function Menu**.

## Displaying Disc Title

You can display the currently playing Disc Title.

### Note:

- You can also display the currently playing Disc Title when playing a CD TEXT disc on a CD TEXT compatible Multi-CD player. (Refer to page 28.)

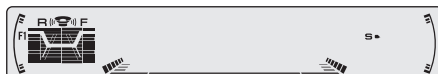

### Note:

- If you switch displays when disc titles have not been input, "NO TITLE" is displayed.

## Compression and DBE (COMP)

Using the COMP (Compression) and DBE (Dynamic Bass Emphasis) functions enables Multi-CD player sound quality adjustment. Each of the functions enables two-step adjustment.

### ■ COMP

The COMP (Compression) function adjusts imbalances between loud and subdued sounds at higher volumes.

### ■ DBE

DBE (Dynamic Bass Emphasis) boosts bass levels to give a fuller sound.

## COMP/DBE ON/OFF Switching

1. Press the **FUNCTION** button and select the **COMP/DBE** switching mode (**COMP**) in the Function Menu.
2. Select the desired mode with the **▲/▼** buttons.

COMP OFF → COMP 1 → COMP 2  
→ COMP OFF → DBE 1 → DBE 2



### Note:

- You can use these functions with a Multi-CD player that has them. If the player does not feature the COMP/DBE functions, “NO COMP” is displayed if you try to use them.

## CD TEXT Function (for CD TEXT compatible type)

You can use these functions when playing a CD TEXT disc on a CD TEXT compatible Multi-CD player.

### Title Display Switching

- **Select the desired title display with the DISPLAY button.**

Each press of the DISPLAY button changes the display in the following order:

Playback mode (Play Time)

→ Disc Title → Disc Artist Name

→ Track Title → Track Artist Name

#### Note:

- If certain text information is not recorded on a CD TEXT disc, "NO ~" (e.g. "NO T-TITLE") is displayed.



### Title Scroll

This product displays the first 10 letters only of Disc Title, Artist Name and Track Title. With text longer than 10 letters, you can see the rest of the text by scrolling.

- **Scroll the title display by pressing the DISPLAY button for 2 seconds.**





## Selecting the Equalizer Curve

You can switch between Equalizer curves.

- **Select the desired Equalizer curve.**

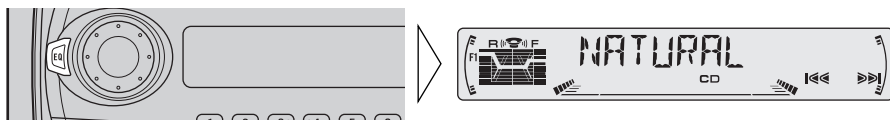

POWERFUL (powerful) → NATURAL (natural) → VOCAL (vocal)  
 → CUSTOM 1 (custom 1) → CUSTOM 2 (custom 2) → EQ FLAT (flat)  
 → SUPER BASS (super bass)

## About the Custom Curves

“CUSTOM 1” and “CUSTOM 2” are adjustable equalizer curves. (Refer to “Equalizer Curve Adjustment” on page 32 and “Equalizer Curve Fine Adjustment” on page 33.)

### ■ CUSTOM 1

A separate “CUSTOM 1” curve can be created for each source. (The Built-in CD player and Multi-CD player are set to the same Equalizer Curve Adjustment setting automatically.)

If you make adjustments when a curve other than “CUSTOM 2” is selected, the equalizer curve settings are memorized in “CUSTOM 1”.

### ■ CUSTOM 2

A “CUSTOM 2” curve can be created common to all sources.

If you make adjustments when the “CUSTOM 2” curve is selected, the “CUSTOM 2” curve is updated.

## Entering the Audio Menu

With this Menu, you can adjust the sound quality.

### Note:

- After entering the Audio Menu, if you do not perform an operation within about 30 seconds, the Audio Menu is automatically canceled.
- Audio Menu functions change depending on the Rear Output setting in the Initial Setting Menu. (Refer to “Setting the Rear Output” on page 40.)

### 1. Select the desired mode in the Audio Menu.



Each press changes the Mode ...

### 2. Operate a mode.

### 3. Cancel the Audio Menu.



## Audio Menu Functions

The Audio Menu features the following functions.

### Balance Adjustment (FADER)

This function allows you to select a Fader/Balance setting that provides ideal listening conditions in all occupied seats.

#### 1. Press the AUDIO button and select the Fader/Balance mode (FADER) in the Audio Menu.

#### 2. Adjust front/rear speaker balance with the ▲/▼ buttons.

“FADER :F 15” – “FADER :R 15” is displayed as it moves from front to rear.





### 3. Adjust left/right speaker balance with the ◀/▶ buttons.

“BAL :L 9” – “BAL :R 9” is displayed as it moves from left to right.



#### Note:

- When the Rear Output setting is “FRT+S/W”, you cannot adjust front/rear speaker balance. (Refer to page 40.)
- “FADER :0” is the proper setting when 2 speakers are in use.

## Equalizer Curve Adjustment (EQ-LOW/EQ-MID/EQ-HIGH)

You can adjust the currently selected equalizer curve settings as desired.

### 1. Press the AUDIO button and select the Equalizer mode (EQ-LOW/EQ-MID/EQ-HIGH) in the Audio Menu.

### 2. Select the band you want to adjust with the ◀/▶ buttons.

EQ-LOW (low) ↔ EQ-MID (mid)  
↔ EQ-HIGH (high)



### 3. Boost or attenuate the selected band with the ▲/▼ buttons.

The display shows “+6” – “-6”.



“CUSTOM”

#### Note:

- If you make adjustments when a curve other than “CUSTOM 2” is selected, “CUSTOM 1” curve is updated.

## Equalizer Curve Fine Adjustment

You can adjust the center frequency and the Q factor (curve characteristics) of each currently selected curve band (EQ-LOW/EQ-MID/EQ-HIGH).

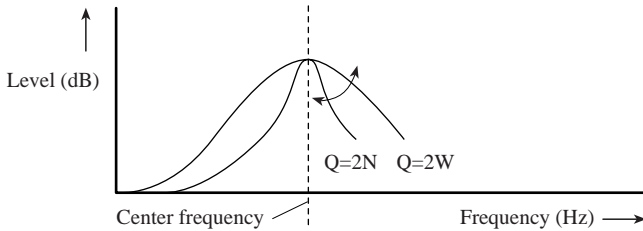

1. Press the **AUDIO** button for 2 seconds to select Equalizer Curve Fine Adjustment.

2. Press the **AUDIO** button to select the desired band for adjustment.



3. Select the desired frequency with the **◀/▶** buttons.

LOW: 40 ↔ 80 ↔ 100 ↔ 160 (Hz)  
MID: 200 ↔ 500 ↔ 1K ↔ 2K (Hz)  
HIGH: 3K ↔ 8K ↔ 10K ↔ 12K (Hz)



4. Select the desired Q factor with the **▲/▼** buttons.

2N ↔ 1N ↔ 1W ↔ 2W



### Note:

- If you make adjustments when a curve other than “CUSTOM 2” is selected, “CUSTOM 1” curve is updated.

## Bass Adjustment (BASS)

You can adjust the cut-off frequency and the Bass level.

In “FRT1” mode, bass adjustment affects only the rear output: front output cannot be adjusted.

1. Press the **AUDIO** button and select the **Bass mode (BASS)** in the Audio Menu.

2. Select the desired frequency with the **◀/▶** buttons.

40 ↔ 63 ↔ 100 ↔ 160 (Hz)



3. Boost or attenuate the bass level with the **▲/▼** buttons.

The display shows “+6” – “-6”.

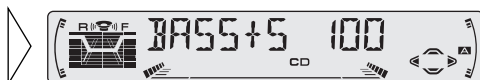

## Treble Adjustment (TRE)

You can adjust the cut-off frequency and the Treble level.

In “FRT1” and “FRT2” modes, treble adjustment affects only the front output: rear output cannot be adjusted.

1. Press the **AUDIO** button and select the **Treble mode (TRE)** in the Audio Menu.

2. Select the desired frequency with the **◀/▶** buttons.

2K ↔ 4K ↔ 6K ↔ 10K (Hz)

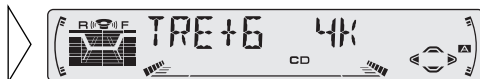

3. Boost or attenuate the treble level with the **▲/▼** buttons.

The display shows “+6” – “-6”.

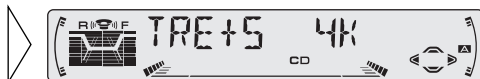

## Loudness Adjustment (LOUD)

The Loudness function compensates for deficiencies in the low and high sound ranges at low volume. You can select a desired Loudness level.

1. Press the **AUDIO** button and select the Loudness mode (**LOUD**) in the Audio Menu.
2. Switch the Loudness function **ON/OFF** with the **▲/▼** buttons.



3. Select the desired level with the **◀/▶** buttons.

LOW (low) ↔ MID (mid) ↔  
HI (high)



## Subwoofer Output (SUB.W)

When a Subwoofer is connected, switch Subwoofer output ON.  
Initially, Subwoofer output is ON.

1. Press the **AUDIO** button and select the Subwoofer ON/OFF mode (**SUB.W**) in the Audio Menu.
2. Switch the Subwoofer output **ON/OFF** with the **▲/▼** buttons.

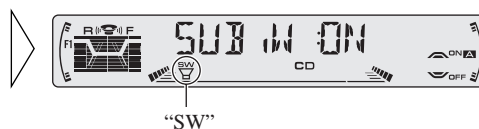

### Note:

- When the Rear Output setting is "FRT+REAR", you cannot switch the Subwoofer ON/OFF mode. (Refer to page 40.)

## Subwoofer Setting Adjustment (80HZ 0)

When the Subwoofer output is ON, you can adjust the cut-off frequency and the output level of Subwoofer.

1. Press the **AUDIO** button and select the **Subwoofer setting mode (80HZ 0)** in the Audio Menu.

2. Select the frequency to **50 Hz, 80 Hz or 125 Hz** with the **◀/▶** buttons.

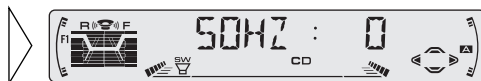

3. Increase or decrease the output level with the **▲/▼** buttons.

The display shows “+6” – “-6”.



### Note:

- You can select the Subwoofer setting mode only when Subwoofer output is switched ON in the Subwoofer ON/OFF mode.

## Source Level Adjustment (SLA)

The SLA (Source Level Adjustment) function prevents radical leaps in volume level when switching between sources. Settings are based on the FM volume level, which remains unchanged.

1. Compare the **FM volume with the volume of the other source.** (e.g. **Built-in CD player.**)
2. Press the **AUDIO** button and select the **SLA mode (SLA)** in the Audio Menu.
3. Increase or decrease the level with the **▲/▼** buttons.

The display shows “+4” – “-4”.



### Note:

- Since the FM volume is the control, SLA is not possible in the FM modes.
- The AM volume level, which is different from the FM base setting volume level, can also be adjusted similar to sources other than tuner.
- The Built-in CD player and Multi-CD player are set to the same volume adjustment setting automatically.

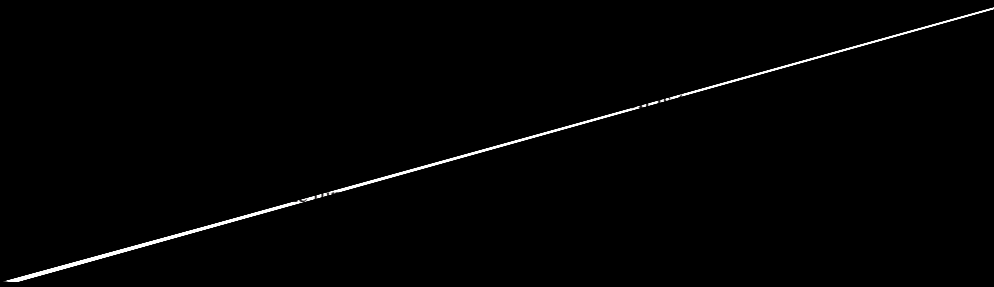

## Entering the Initial Setting Menu

With this menu, you can perform initial settings for this product.

1. Turn the source OFF.
2. Enter the Initial Setting Menu.

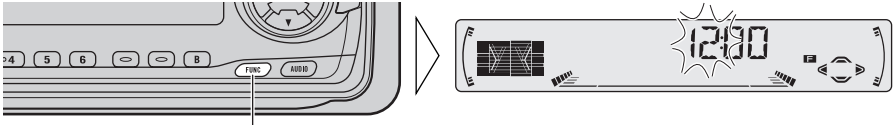

Hold for 2 seconds

3. Select a desired mode.

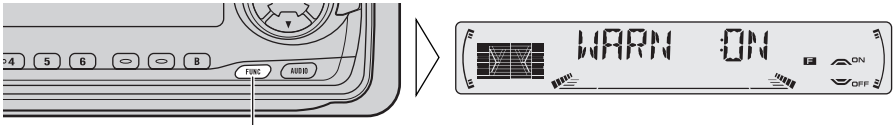

Each press changes the Mode ...

4. Operate a mode.
5. Cancel the Initial Setting Menu.

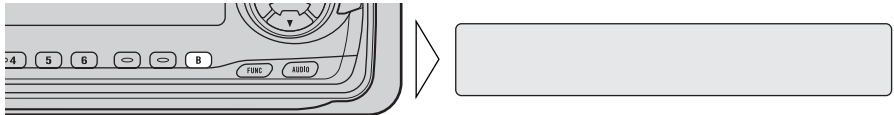

### Note:

- Holding down the FUNCTION button for 2 seconds also cancels the Initial Setting Menu.

## Initial Setting Menu Functions

The Initial Setting Menu features the following functions.

### Setting the Time

This is the mode for setting the time on the unit's clock display. (Refer to page 41 for details concerning the clock display.)

1. Press the **FUNCTION** button and select the **Time setting mode in the Initial Setting Menu.**
2. Select **“Hour”** or **“Minute”** with the **◀/▶** buttons.



3. Set as desired with the **▲/▼** buttons.



As soon as you switch to “Minute”, the seconds start counting from 00.

### Setting the Warning Tone (WARN)

You can switch the Warning Tone function ON/OFF. (Refer to “Warning Tone” on page 37.)

1. Press the **FUNCTION** button and select the **Warning Tone mode (WARN)** in the Initial Setting Menu.
2. Switch the **Warning Tone ON/OFF** with the **▲/▼** buttons.



### Switching the AUX Mode (AUX)

It is possible to use auxiliary (AUX) equipment with this product. Activate the AUX mode when using external equipment with this product.

1. Press the **FUNCTION** button and select the **AUX Setting mode (AUX)** in the Initial Setting Menu.
2. Switch the **AUX Setting ON/OFF** with the **▲/▼** buttons.





## Setting the Dimmer (DIMMER)

To enable this product's display from being too bright at night, when the vehicle's head lights are turned ON the display is dimmed.

You can switch this function ON/OFF.

1. Press the **FUNCTION** button and select the **Dimmer mode (DIMMER)** in the **Initial Setting Menu**.
2. Switch the **Dimmer ON/OFF** with the **▲/▼** buttons.



## Setting the Rear Output (FRT+REAR)

This product's rear output (rear speaker leads output and RCA Rear output) can be used for full-range speaker ("FRT+REAR") or Subwoofer ("FRT+S/W") connection. If you switch Rear Output setting to the "FRT+S/W", you can connect a rear speaker lead directly to a Subwoofer without using an auxiliary amp.

Initially, the unit is set for rear full-range speaker connection ("FRT+REAR").

### Note:

- Even if you change this setting, there is no output unless you switch the Subwoofer Output (refer to page 35) in the Audio Menu ON.
- Both rear speaker leads output and RCA Rear output are switched simultaneously in this setting mode.

1. Press the **FUNCTION** button and select the **Rear Output setting mode (FRT+REAR)** in the **Initial Setting Menu**.
2. Change the **Rear Output setting** with the **▲/▼** buttons.

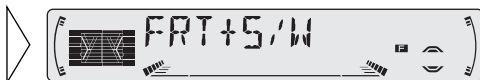

### Note:

- When no Subwoofer is connected to the rear output, select "FRT+REAR".
- When a Subwoofer is connected to the rear output, set for Subwoofer "FRT+S/W".

## Displaying the Time

- To turn the time display ON.

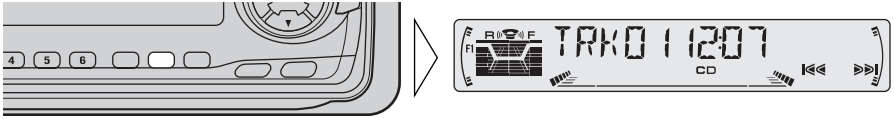

The time display disappears temporarily when you perform another operation, but the time indication returns to the display after 25 seconds.

### Note:

- Even when the sources are OFF, the Time appears on the display. Pressing the CLOCK button switches the Time display ON/OFF.

## Using the AUX Source

An IP-BUS-RCA-Interconnector such as CD-RB20 or CD-RB10 (sold separately) enables you to connect this product to auxiliary equipment featuring an RCA output.

For more details, refer to the IP-BUS-RCA Interconnector's Owner's Manual.

## Selecting the AUX Source

- Select AUX. (Refer to page 8.)

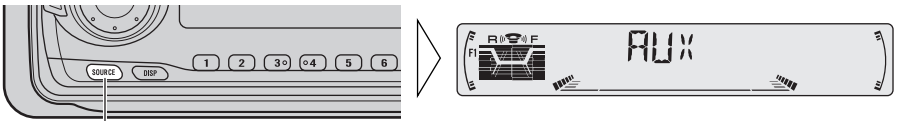

Each press changes the Source ...

## AUX Title Input (TITLE IN)

The display title for AUX source can be changed.

1. Select the AUX Title Input mode (TITLE IN) in the Detailed Setting Menu.

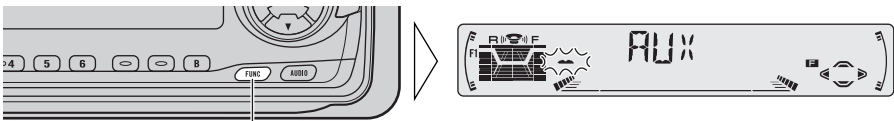

Hold for 2 seconds

2. Input the AUX Title.

Refer to "Disc Title Input" on page 25, and perform procedures 3 to 5 in the same way.

## Precaution

- Play only CDs bearing the Compact Disc Digital Audio mark.



- This product is designed for use with conventional, fully circular CDs only. Use of shaped CDs are not recommended for this product.



- Check all CDs before playing and discard cracked, scratched or warped discs.
- Normal playback of CD-R discs other than those recorded with a music CD recorder may not be possible.
- Playback of music CD-R discs, even those recorded with a music CD recorder, may not be possible with this product due to disc characteristics or scratches or dirt on the disc. Dirt or condensation on the lens inside this product may also prevent playback.
- Titles and other text information recorded on a CD-R disc may not be displayed by this product.
- This product conforms to the track skip function of the CD-R disc. The tracks containing the track skip information are skipped over automatically.
- Read the precautions with the CD-R discs before using.

- Wipe dirty or damp discs outward from the center with a soft cloth.

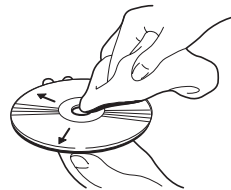

- Avoid touching the recorded (iridescent) surface when handling discs.
- Store discs in their cases when not in use.
- Keep discs out of direct sunlight and high temperatures.
- Do not affix labels or apply chemicals to discs.
- Condensation may collect inside the player when using the heater in cold weather, interfering with playback. Turn it off for an hour or so and wipe damp discs with a soft cloth.
- Road shocks may interrupt CD playback.

## Built-in CD Player's Error Message

When problems occur with CD playback, an error message appears on the display. Refer to the table below to identify the problem, then take the suggested corrective action. If the error persists, contact your dealer or your nearest PIONEER Service Center.

Message	Possible cause	Recommended action
ERROR- 11, 12, 17, 30	Dirty disc.	Clean the disc.
ERROR- 11, 12, 17, 30	Scratched disc.	Replace the disc.
ERROR- 14	Unrecorded CD.	Check the disc.
ERROR- 10, 11, 12, 14, 17, 30, A0	Electrical or mechanical problem.	Turn the ignition ON and OFF, or switch to a different source, then back to the CD player.
ERROR- 44	All tracks are setting track skip.	Replace the disc.
HEAT	CD player overheating.	Discontinue play until the machine temperature drops.

## General

Power source	..... 14.4 V DC (10.8 – 15.1 V allowable)
Grounding system	..... Negative type
Max. current consumption	..... 10.0 A
Dimensions	
(DIN) (chassis)	..... 178 (W) × 50 (H) × 157 (D) mm [7 (W) × 2 (H) × 6-1/8 (D) in]
(nose)	..... 188 (W) × 58 (H) × 19 (D) mm [7-3/8 (W) × 2-1/4 (H) × 3/4 (D) in]
(D) (chassis)	..... 178 (W) × 50 (H) × 162 (D) mm [7 (W) × 2 (H) × 6-3/8 (D) in]
(nose)	..... 170 (W) × 46 (H) × 14 (D) mm [6-3/4 (W) × 1-3/4 (H) × 1/2 (D) in]
Weight	..... 1.5 kg (3.3 lbs)

## Amplifier

Continuous power output is 22 W per channel min. into 4 ohms, both channels driven 50 to 15,000 Hz with no more than 5% THD.

Maximum power output	..... 50 W × 4 50 W × 2 ch/4 Ω + 70 W × 1 ch/2 Ω (for Subwoofer)
Load impedance	..... 4 Ω (4 – 8 Ω [2 Ω for 1 ch] allowable)
Preout maximum output level/ output impedance	..... 2.2 V/1 kΩ
Equalizer (3-Band Parametric Equalizer)	
(Low)	..... Frequency: 40/80/100/160 Hz Q Factor: 0.35/0.59/0.95/1.15 (+6 dB when boosted) Level: ±12 dB
(Mid)	..... Frequency: 200/500/1k/2k Hz Q Factor: 0.35/0.59/0.95/1.15 (+6 dB when boosted) Level: ±12 dB
(High)	..... Frequency: 3.15k/8k/10k/12.5k Hz Q Factor: 0.35/0.59/0.95/1.15 (+6 dB when boosted) Level: ±12 dB
Loudness contour	
(Low)	..... +3.5 dB (100 Hz), +3 dB (10 kHz)
(Mid)	..... +10 dB (100 Hz), +6.5 dB (10 kHz)
(High)	..... +11 dB (100 Hz), +11 dB (10 kHz) (volume: -30 dB)
Tone controls	
(Bass)	..... Frequency: 40/63/100/160 Hz Level: ±12 dB
(Treble)	..... Frequency: 2.5k/4k/6.3k/10k Hz Level: ±12 dB
Subwoofer output	
Frequency	..... 50/80/125 Hz
Slope	..... -12 dB/oct
Gain	..... ±12 dB

## CD player

System	..... Compact disc audio system
Usable discs	..... Compact disc
Signal format	..... Sampling frequency: 44.1 kHz Number of quantization bits: 16; linear
Frequency characteristics	..... 5 – 20,000 Hz (±1 dB)
Signal-to-noise ratio	..... 94 dB (1 kHz) (IHF-A network)
Dynamic range	..... 92 dB (1 kHz)
Number of channels	..... 2 (stereo)

## FM tuner

Frequency range	..... 87.9 – 107.9 MHz
Usable sensitivity	..... 9 dBf (0.8 μV/75 Ω, mono, S/N: 30 dB)
50 dB quieting sensitivity	..... 15 dBf (1.5 μV/75 Ω, mono)
Signal-to-noise ratio	..... 70 dB (IHF-A network)
Distortion	..... 0.3% (at 65 dBf, 1 kHz, stereo)
Frequency response	..... 30 – 15,000 Hz (±3 dB)
Stereo separation	..... 40 dB (at 65 dBf, 1 kHz)
Selectivity	..... 70 dB (2ACA)
Three-signal intermodulation (desired signal level)	..... 30 dBf (two undesired signal level: 100 dBf)

## AM tuner

Frequency range	..... 530 – 1,710 kHz (10 kHz)
Usable sensitivity	..... 18 μV (S/N: 20 dB)
Selectivity	..... 50 dB (±10 kHz)

### Note:

- Specifications and the design are subject to possible modification without notice due to improvements.

**PIONEER CORPORATION**

4-1, MEGURO 1-CHOME, MEGURO-KU, TOKYO 153-8654, JAPAN

**PIONEER ELECTRONICS (USA) INC.**

P.O. Box 1760, Long Beach, California 90801, U.S.A.

TEL: (800) 421-1404

**PIONEER EUROPE NV**

Haven 1087, Keetberglaan 1, B-9120 Melsele, Belgium

TEL: (0) 3/570.05.11

**PIONEER ELECTRONICS AUSTRALIA PTY. LTD.**

178-184 Boundary Road, Braeside, Victoria 3195, Australia

TEL: (03) 9586-6300

**PIONEER ELECTRONICS OF CANADA, INC.**

300 Allstate Parkway, Markham, Ontario L3R OP2, Canada

TEL: (905) 479-4411

**PIONEER ELECTRONICS DE MEXICO, S.A. de C.V.**

San Lorenzo 1009 3er. Piso Desp. 302

Col. Del Valle Mexico, D.F. C.P. 03100

TEL: 5-688-52-90

Published by Pioneer Corporation.

Copyright © 2000 by Pioneer Corporation.

All rights reserved.

Publication de Pioneer Corporation.

Copyright © 2000 Pioneer Corporation.

Tous droits de reproduction et de traduction réservés.

**INSTALLATION MANUAL**

**DEH-P3300**

**DEH-P33**

**MANUEL D'INSTALLATION**

# Connecting the Units

## Note:

- This unit is for vehicles with a 12-volt battery and negative grounding. Before installing it in a recreational vehicle, truck or bus, check the battery voltage.
- To avoid shorts in the electrical system, be sure to disconnect the  $\ominus$  battery cable before beginning installation.
- Refer to the owner's manual for details on connecting the power amp and other units, then make connections correctly.
- Secure the wiring with cable clamps or adhesive tape. To protect the wiring, wrap adhesive tape around them where they lie against metal parts.
- Route and secure all wiring so it cannot touch any moving parts, such as the gear shift, handbrake and seat rails. Do not route wiring in places that get hot, such as near the heater outlet. If the insulation of the wiring melts or gets torn, there is a danger of the wiring short-circuiting to the vehicle body.
- Don't pass the yellow lead through a hole into the engine compartment to connect to the battery. This will damage the lead insulation and cause a very dangerous short.
- Do not shorten any leads. If you do, the protection circuit may fail to work when it should.
- Never feed power to other equipment by cutting the insulation of the power supply lead of the unit and tapping into the lead. The current capacity of the lead will be exceeded, causing overheating.
- When replacing fuse, be sure to use only fuse of the rating prescribed on this unit.
- Since a unique BPTL circuit is employed, never wire so the speaker leads are directly grounded or the left and right  $\ominus$  speaker leads are common.
- Speakers connected to this unit must be high-power types with minimum rating of 50 W and impedance of 4 to 8 ohms. Connecting speakers with output and/or impedance values other than those noted here may result in the speakers catching fire, emitting smoke, or becoming damaged.
- When this product's source is switched ON, a control signal is output through the blue/white lead. Connect to an external power amp's system remote control or the car's Auto-antenna relay control terminal (max. 300 mA 12 V DC). If the car features a glass antenna, connect to the antenna booster power supply terminal.

- When an external power amp is being used with this system, be sure not to connect the blue/white lead to the amp's power terminal. Likewise, do not connect the blue/white lead to the power terminal of the auto-antenna. Such connection could cause excessive current drain and malfunction.
- To avoid short-circuiting, cover the disconnected lead with insulating tape. Especially, insulate the unused speaker leads without fail. There is a possibility of short-circuiting if the leads are not insulated.
- To prevent incorrect connection, the input side of the IP-BUS connector is blue, and the output side is black. Connect the connectors of the same colors correctly.
- If this unit is installed in a vehicle that does not have an ACC (accessory) position on the ignition switch, the red lead of the unit should be connected to a terminal coupled with ignition switch ON/OFF operations. If this is not done, the vehicle battery may be drained when you are away from the vehicle for several hours. (Fig. 1)

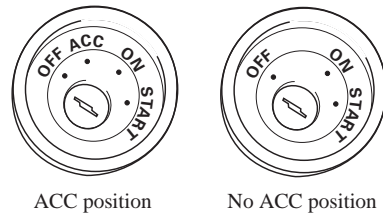

Fig. 1

- The black lead is ground. Please ground this lead separately from the ground of high-current products such as power amps. If you ground the products together and the ground becomes detached, there is a risk of damage to the products or fire.
- Cords for this product and those for other products may be different colors even if they have the same function. When connecting this product to another product, refer to the supplied Installation manuals of both products and connect cords that have the same function.



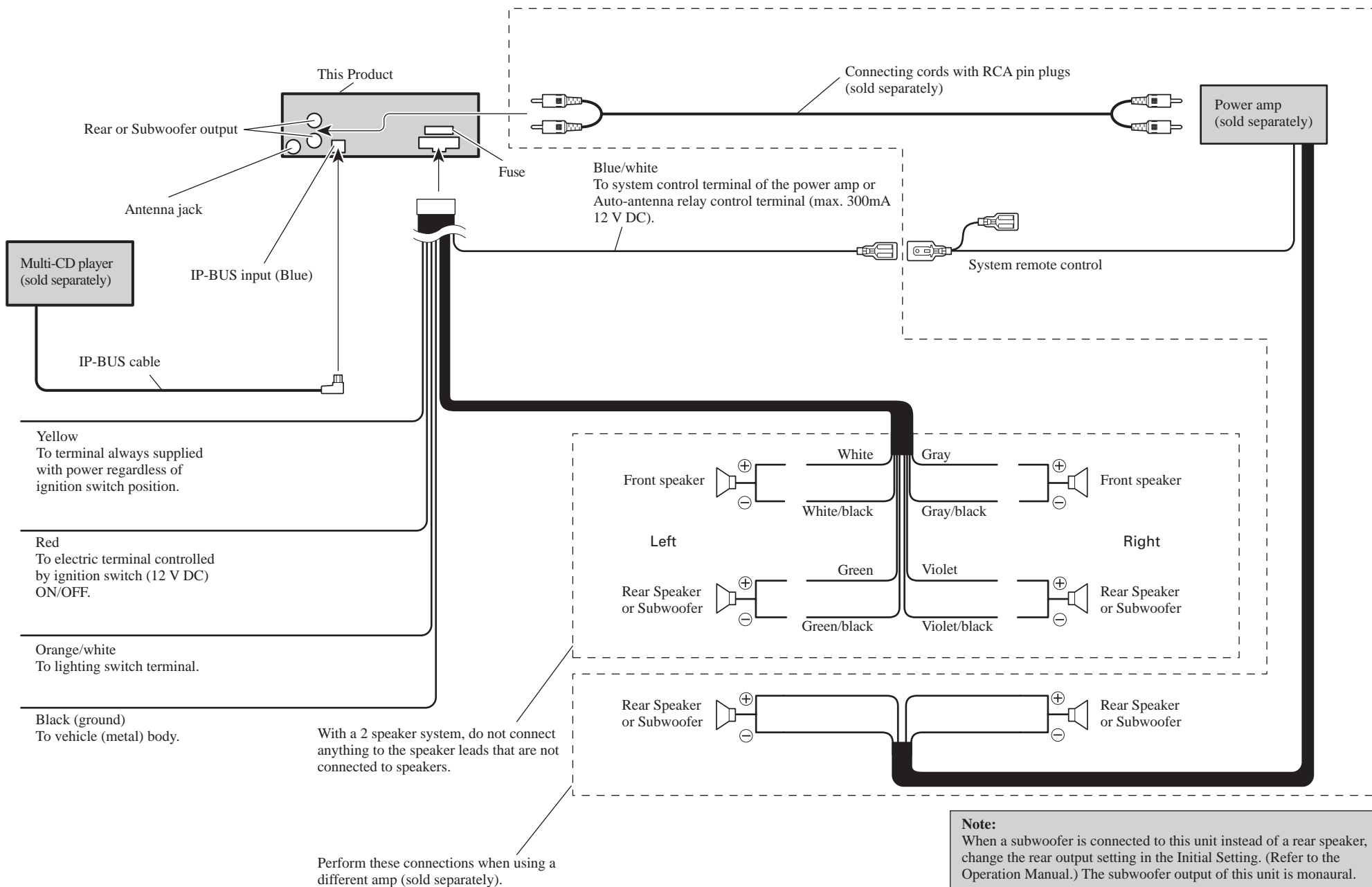

Fig. 2

**Installation with the rubber bush (Fig. 4)**





**Fig. 7**

Mounting the unit to the factory radio mounting bracket.  
(Fig. 8) (Fig. 9)

Select a position where the screw holes of the bracket and the screw holes of the head unit become aligned (are fitted), and tighten the screws at 2 places on each side. Use either truss screws ( $5 \times 8$  mm) or flush surface screws ( $5 \times 9$  mm), depending on the shape of the screw holes in the bracket.



**Fig. 9**

## Screws for the front panel

Not operate the Detaching and Replacing the Front Panel Function, use the supplied fixing screws and fix the front panel to this unit.

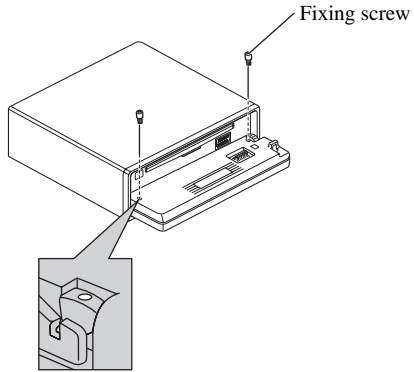
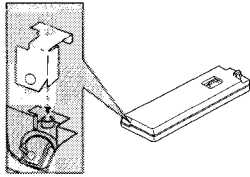

**Fig. 10**

## Fixing the Front Panel

If you do not operate the Detaching and Replacing the Front Panel Function, use the supplied fixing screws and holder to fix the front panel to this unit

### 1. Attach the holder to the front panel.



### 2. Replace the front panel to the unit.

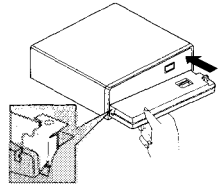

### 3. Fix the front panel to the unit using fixing screws.

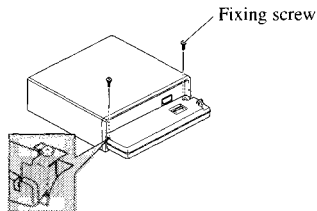

## Fixation de la face avant

Si vous n'utilisez pas la fonction de dépose et pose de la face avant, utilisez la vis de fixation fournie et crochet pour fixer la face avant à l'appareil

### 1. Attachez le crochet sur la face avant.

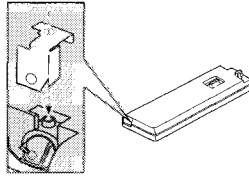

### 2. Remettez la face avant en place sur l'appareil.

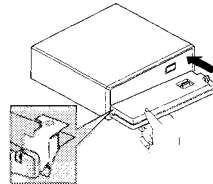

### 3. Fixez la face avant sur l'appareil avec les vis de fixation.

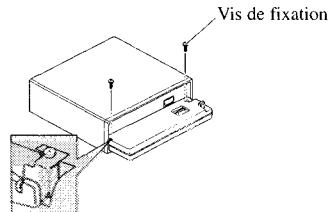

## Colocación del panel delantero

Si no desea utilizar la función de extracción y colocación del panel delantero, utilice los tornillos de fijación suministrados y sujetadore para fijar el panel delantero a esta unidad

### 1. Coloque lo sujetadore en el panel delantero.

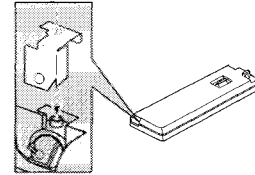

### 2. Reinstale el panel delantero en la unidad.

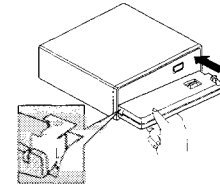

### 3. Fije el panel delantero a la unidad utilizando los tornillos de fijación.

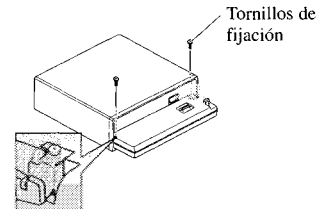

## **Note on detaching the Front Panel**

**Grip the left side of the front panel and pull it gently outward.**

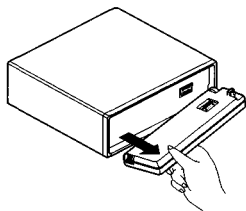

## **Remarque sur la dépose de la face avant**

**Saisissez le côté gauche de la face avant et tirez-la doucement à vous.**

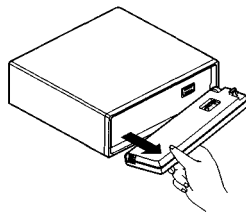

## **Nota sobre la extracción del panel delantero**

**Agarre el lado izquierdo del panel delantero y tire suavemente del mismo hacia afuera.**

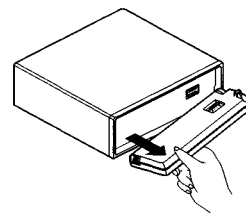



PIONEER ELECTRONICS (USA) INC - PIONEER ELECTRONICS OF CANADA, INC  
(PA) (POC)

**LIMITED WARRANTY**

WARRANTY VALID ONLY IN COUNTRY OF PRODUCT PURCHASE

**WARRANTY PERIOD**

For the period specified below from date of original retail purchase (the warranty period) from an authorized Pioneer dealer, Pioneer Electronics (USA) Inc (PA), and Pioneer Electronics Of Canada, Inc (POC), warrant that products distributed by PA in the U.S.A., and by POC in Canada that fail to function properly under normal use due to a manufacturing defect when installed and operated according to the owner's manual enclosed with the unit will be repaired or replaced with a unit of comparable value, at the option of PA or POC, without charge to you for parts or actual repair work. Parts supplied under this warranty may be new or rebuilt at the option of PA or POC.

The warranty period for retail customers who rent the product commences upon the date product is first put into use (a) during the rental period or (b) retail sale, whichever occurs first.

The warranty does not cover any product which is used in any trade or business, or in an industrial or commercial application.

**PRODUCT**

**WARRANTY PERIOD  
PARTS LABOR**

**Car Stereo Products**

**ONE YEAR ONE YEAR**

This warranty covers the product during the warranty period whether in the possession of the original owner or any subsequent owner. In the event service is required, the product must be delivered within the warranty period, transportation prepaid, from within the country of purchase as explained in this document. You will be responsible for removal and installation of the product. PA or POC, as appropriate, will pay for the cost of returning the repaired or replacement product to you within the country of purchase.

**WHAT'S NOT COVERED**

This warranty does not apply to any speaker that has been subjected to power in excess of its published power rating.

This warranty does not cover the cabinet or any appearance item, user attached antennas, any damage to recordings or recording tapes or discs, any damage to the product resulting from alterations, modifications not authorized in writing by PA or POC, accident, misuse or abuse, damage due to lightning or to power surges, subsequent damage from leaking, damaged or inoperative batteries or the use of batteries not conforming to those specified in the owner's manual.

This warranty does not cover the cost of parts or labor which would be otherwise provided without charge under this warranty, obtained from any source other than a PA or POC Authorized Service Company or other designated location. This warranty does not cover defects or damage caused by the use of unauthorized parts or labor, or from improper maintenance.

**ALTERED, DEFACED OR REMOVED SERIAL NUMBERS VOID THIS WARRANTY**

**YOUR RIGHTS**

PA and POC exclude any obligation on their part for incidental or consequential damages related to the failure of products each distributes to function properly under the conditions set forth above.

**IN THE U.S.A.** - PA LIMITS ITS OBLIGATIONS UNDER ANY IMPLIED WARRANTIES INCLUDING, BUT NOT LIMITED TO, THE IMPLIED WARRANTIES OF MERCHANTABILITY AND FITNESS FOR A PARTICULAR PURPOSE TO A PERIOD NOT TO EXCEED THE WARRANTY PERIOD. NO WARRANTIES SHALL APPLY AFTER THE WARRANTY PERIOD. SOME STATES DO NOT ALLOW LIMITATIONS ON HOW LONG AN IMPLIED WARRANTY LASTS, AND SOME STATES DO NOT ALLOW THE EXCLUSION OR LIMITATION OF INCIDENTAL OR CONSEQUENTIAL DAMAGES, SO THE ABOVE LIMITATIONS OR EXCLUSIONS MAY NOT APPLY TO YOU. THIS WARRANTY GIVES YOU SPECIFIC LEGAL RIGHTS, AND YOU MAY HAVE OTHER RIGHTS WHICH MAY VARY FROM STATE TO STATE.

**IN CANADA** - EXCEPT AS EXPRESSLY PROVIDED HEREIN, THERE ARE NO REPRESENTATIONS, WARRANTIES, OBLIGATIONS OR CONDITIONS, IMPLIED, STATUTORY OR OTHERWISE, APPLICABLE TO THIS PRODUCT.

**TO OBTAIN SERVICE**

**CAR STEREO PRODUCTS (EXCEPT CAR SPEAKERS SOLD IN THE U.S.A. ONLY)**

PA and POC have appointed a number of Authorized Service Companies throughout the U.S.A. and Canada should your product ever require service. To receive warranty service you will need to present your sales receipt or, if rented, your rental contract showing place and date of original owner's transaction.

Should it become necessary to ship the unit you will need to package the product carefully and send it, transportation prepaid by a traceable, pre-insured method, to an Authorized Service Company. Carefully package the product using adequate padding material to prevent damage in transit. The original container is ideal for this purpose. Include in the package your name, address, telephone number where you can be reached during business hours, a copy of your sales receipt and a detailed description of the problem.

**TO OBTAIN SERVICE**

**CAR SPEAKERS SOLD IN THE U.S.A. ONLY**

Should your car speaker require service, return defective car speaker to your retail dealer for exchange. To receive warranty service you will need to present your sales receipt showing place and date of original owner's retail purchase. If, for any reason, you cannot exchange the speakers at the selling dealer, call the Customer Service Department as given below.

**- ADDITIONAL INFORMATION -**

**IN THE U.S.A.**

For additional information on this warranty, please call or write:

CUSTOMER SERVICE DEPARTMENT  
PIONEER ELECTRONICS SERVICE, INC  
P O BOX 1760  
LONG BEACH, CALIFORNIA 90801  
1-800-421-1404

**INCANADA**

Please contact a Pioneer authorized Dealer to find the nearest Pioneer authorized service location. For additional information on this warranty, please call or write:

CUSTOMER SERVICE DEPARTMENT  
PIONEER ELECTRONICS OF CANADA, INC  
300 ALLSTATE PARKWAY  
MARKHAM, ON L3R 0P2  
(905) 479-4411

**IN THE U.S.A. DO NOT RETURN ANY PRODUCT TO THE ABOVE ADDRESS IT IS NOT A SERVICE LOCATION**

**IN THE U.S.A.**

RECORD THE PLACE AND DATE OF PURCHASE FOR FUTURE REFERENCE

**FOR PRODUCT INFORMATION, TO PURCHASE REPLACEMENT PARTS OR TO LOCATE AN AUTHORIZED SERVICE COMPANY  
CALL: 1-800-421-1404**

Model No \_\_\_\_\_ Serial No \_\_\_\_\_ Purchase Date \_\_\_\_\_

Purchased From \_\_\_\_\_

KEEP THIS INFORMATION AND YOUR SALES RECEIPT IN A SAFE PLACE



*Please do not send products or other  
correspondence to this address*



**First-Class  
Postage  
Required**  
Post Office will  
not deliver  
without proper  
postage.

**H M Q 0 1 - 0 1**

**Single CD - 2**

***Pioneer***

**PO BOX 174303**

**DENVER CO 80217-4303**



*Please fold here*

**PRODUCT REGISTRATION**

# Pioneer

**Register your purchase with us  
and automatically enter the  
\$100,000 Give Away III...**

**for a chance to WIN**

**\$5,000, \$25,000 or**

**even \$50,000!!!**

**OFFICIAL RULES: NO PURCHASE NECESSARY TO WIN.** Sweepstakes is sponsored by a number of different companies, will be offered in a number of different presentations and will award the following prizes: one 1st Prize of \$50,000, one 2nd Prize of \$25,000; and five 3rd Prizes of \$5,000. Sweepstakes begins May 20 1999, and ends December 31 2001. Enter by completing this product registration or a 3" x 5" card with your name, address, city, state, ZIP Code and the words "100 000 Give Away III" and mail to P.O. Box 174303, Dept. HMQ, Denver, CO 80217 4303. Entries must be received no later than December 31, 2001 and are limited to one per household. Mechanically reproduced entries not acceptable. Not responsible for late, lost or illegible entries. A random drawing held in January 2002 will select the winners from all entries collectively received by the sponsoring companies. Odds of winning depend on the number of eligible entries received from all sponsors' presentations. Open to U.S. residents at least 18 years old, except employees and their families of the sweepstakes judge, all of the sponsoring companies and their respective subsidiaries. Each winner must submit a signed and notarized affidavit of eligibility within a specified time after being notified of their prospective winner status and if a satisfactory affidavit is not received within the stated time, a new winner will be selected. By submitting an entry, winner agrees to the use of their name, address and photograph for advertising/publicity purposes without compensation. All entries become the property of the sweepstakes judge. No transfer or substitution of prize is allowed. Winner is solely responsible for all taxes. All federal, state and local laws apply. Offer void in Florida and where prohibited by law. For notice of sweepstakes winners, send a self-addressed, stamped envelope to: "100 000 Give Away III", P.O. Box 171313, Denver, CO 80217 3133.

**Register ONLINE at [www.pioneerelectronics.com](http://www.pioneerelectronics.com)**

Please complete and return within the next 10 days or register online at: [www.prodreg.com/pioneer](http://www.prodreg.com/pioneer)

1. 1  Mr    2  Mrs    3  Ms    4  Miss

**H M Q 0 1 - 0 1**

**First Name** \_\_\_\_\_ **Initial** \_\_\_\_\_ **Last Name** \_\_\_\_\_

**Street** \_\_\_\_\_ **Apt. No.** \_\_\_\_\_

**City** \_\_\_\_\_ **State** \_\_\_\_\_ **ZIP Code** \_\_\_\_\_

**E-mail Address:** \_\_\_\_\_

2. **Telephone Number:**  
(\_\_\_\_) \_\_\_\_\_ - \_\_\_\_\_

14. **Your date of birth:** MM/YY/YY

3. **Date of purchase:** MM/YY/YY

15. **Marital status:** 1  Married    2  Single

4. **Price paid (excluding sales tax):** \$ \_\_\_\_\_ .00

16. **Not including yourself, what is the GENDER and AGE (in years) of children and other adults living in your household?**

1  No one else in household    2  Child under 1 year

5. **Model #:** DE - \_\_\_\_\_  
FHP - \_\_\_\_\_

Male	Female	Age	Male	Female	Age
1 <input type="checkbox"/>	2 <input type="checkbox"/>	____ yrs	1 <input type="checkbox"/>	2 <input type="checkbox"/>	____ yrs

**Serial #:** \_\_\_\_\_

1 <input type="checkbox"/>	2 <input type="checkbox"/>	____ yrs	1 <input type="checkbox"/>	2 <input type="checkbox"/>	____ yrs
----------------------------	----------------------------	----------	----------------------------	----------------------------	----------

6. **Where did you purchase your Pioneer product?**

1 <input type="checkbox"/> Received as a Gift	6 <input type="checkbox"/> Walmart
2 <input type="checkbox"/> Car Audio Specialty Store	7 <input type="checkbox"/> Best Buy
3 <input type="checkbox"/> Electronics Only Store	8 <input type="checkbox"/> Circuit City
4 <input type="checkbox"/> Mail Order	9 <input type="checkbox"/> Sears
5 <input type="checkbox"/> Electronic/Appliance Store	

17. **Occupation: (check all that apply)**

	You	Spouse
Professional/Technical	<input type="checkbox"/> 1	<input type="checkbox"/>
Upper Management/Executive	<input type="checkbox"/> 2	<input type="checkbox"/>
Middle Management	<input type="checkbox"/> 3	<input type="checkbox"/>
Sales/Marketing	<input type="checkbox"/> 4	<input type="checkbox"/>
Clerical/Service Worker	<input type="checkbox"/> 5	<input type="checkbox"/>
Tradesman/Machine Operator/Laborer	<input type="checkbox"/> 6	<input type="checkbox"/>

7. **In what vehicle will this Pioneer product be used?**  
(Make: e.g. Ford, Nissan, Model: e.g. Taurus SHO, Maxima SE)

**Make:** \_\_\_\_\_

**Model:** \_\_\_\_\_

**Year:** \_\_\_\_\_

A  Bought new    C  Lease  
B  Bought used

18. **Are you or your spouse:**

	You	Spouse
A Homemaker?	<input type="checkbox"/> 1	<input type="checkbox"/>
Retired?	<input type="checkbox"/> 2	<input type="checkbox"/>
A Student?	<input type="checkbox"/> 3	<input type="checkbox"/>
Self Employed/Business Owner?	<input type="checkbox"/> 4	<input type="checkbox"/>
Working from a Home Office?	<input type="checkbox"/> 5	<input type="checkbox"/>
In the Military?	<input type="checkbox"/> 6	<input type="checkbox"/>
A Federal Employee?	<input type="checkbox"/> 7	<input type="checkbox"/>

8. **Please rate the importance of the following features in your purchase decision:**

	Not Important	Somewhat Important	Very Important
A EEQ (Easy EQ)	1 <input type="checkbox"/>	2 <input type="checkbox"/>	3 <input type="checkbox"/>
B Mosfet 45W X 4 Power	1 <input type="checkbox"/>	2 <input type="checkbox"/>	3 <input type="checkbox"/>
C Can Control			
Multi-Disc Changer	1 <input type="checkbox"/>	2 <input type="checkbox"/>	3 <input type="checkbox"/>
D Multi-Color Display	1 <input type="checkbox"/>	2 <input type="checkbox"/>	3 <input type="checkbox"/>
E DFS Alarm	1 <input type="checkbox"/>	2 <input type="checkbox"/>	3 <input type="checkbox"/>
F Remote Control	1 <input type="checkbox"/>	2 <input type="checkbox"/>	3 <input type="checkbox"/>
G Flap Face Design	1 <input type="checkbox"/>	2 <input type="checkbox"/>	3 <input type="checkbox"/>
H Hi-Volt RCA	1 <input type="checkbox"/>	2 <input type="checkbox"/>	3 <input type="checkbox"/>

19. **Which group describes your annual family income?**

01 <input type="checkbox"/> Under \$15,000	08 <input type="checkbox"/> \$75,000-\$99,999
02 <input type="checkbox"/> \$15,000-\$19,999	09 <input type="checkbox"/> \$100,000-\$124,999
03 <input type="checkbox"/> \$20,000-\$29,999	10 <input type="checkbox"/> \$125,000-\$149,999
04 <input type="checkbox"/> \$30,000-\$39,999	11 <input type="checkbox"/> \$150,000-\$174,999
05 <input type="checkbox"/> \$40,000-\$49,999	12 <input type="checkbox"/> \$175,000-\$199,999
06 <input type="checkbox"/> \$50,000-\$59,999	13 <input type="checkbox"/> \$200,000-\$249,999
07 <input type="checkbox"/> \$60,000-\$74,999	14 <input type="checkbox"/> \$250,000 & over

20. **Level of education: (check highest level completed)**

1 <input type="checkbox"/> Completed High School	3 <input type="checkbox"/> Completed Graduate School
2 <input type="checkbox"/> Completed College	

9. **What three factors MOST influenced your purchase decision? (check only three)**

1 <input type="checkbox"/> Brand Name/Reputation	6 <input type="checkbox"/> Warranty/Guarantee
2 <input type="checkbox"/> Price/Value	7 <input type="checkbox"/> Magazine Test Report
3 <input type="checkbox"/> Dealer/Salesperson Recommendation	8 <input type="checkbox"/> Cosmetics
	9 <input type="checkbox"/> Other: _____
4 <input type="checkbox"/> Store Demonstration	
5 <input type="checkbox"/> Friend/Relative Recommendation	

21. **Which credit cards do you use regularly?**

1 <input type="checkbox"/> American Express, Diners Club
2 <input type="checkbox"/> MasterCard, Visa, Discover
3 <input type="checkbox"/> Department Store, Oil Company, etc
4 <input type="checkbox"/> Do not use credit cards

22. **For your primary residence, do you:**

1 <input type="checkbox"/> Own?	2 <input type="checkbox"/> Rent?
---------------------------------	----------------------------------

- 3  Full Range Speakers  
4  Component Speaker Separates Audio/Video

**12 Which of the following magazines do you subscribe to or read frequently?**

- |   |  |
|---|--|
| 01 <input type="checkbox"/> Super Street          | 13 <input type="checkbox"/> Sound & Vision |
| 02 <input type="checkbox"/> Car & Driver          | 14 <input type="checkbox"/> Racer Magazine |
| 03 <input type="checkbox"/> Car Stereo Review     | 15 <input type="checkbox"/> The Source     |
| 04 <input type="checkbox"/> Auto Sound & Security | 16 <input type="checkbox"/> Maxim          |
| 05 <input type="checkbox"/> Car Sound             | 17 <input type="checkbox"/> Playboy        |
| 06 <input type="checkbox"/> Champ Car Magazine    | 18 <input type="checkbox"/> Gear           |
| 07 <input type="checkbox"/> Details               | 19 <input type="checkbox"/> Men's Health   |
| 08 <input type="checkbox"/> Sport Compact Car     | 20 <input type="checkbox"/> Spin           |
| 09 <input type="checkbox"/> Max Speed             | 21 <input type="checkbox"/> Rolling Stone  |
| 10 <input type="checkbox"/> Road & Track          | 22 <input type="checkbox"/> Blaze          |
| 11 <input type="checkbox"/> Automobile            | 23 <input type="checkbox"/> Vibe           |
| 12 <input type="checkbox"/> Automedia             | 24 <input type="checkbox"/> Other: _____   |

**13 Do you own a Mini-Disc (MD) player?**

- 1  Yes                      2  No

- 1  Car      3  Sport Utility      5  Motorcycle  
2  Truck      4  Minivan

**25 Please check all that apply to your household**

- 01  Shop by Catalog/Mail  
02  Member of Frequent Flyer Program  
03  Donate to Charitable Causes  
04  Wear Women's Large/Tall Sizes  
05  Wear Men's Large/Tall Sizes  
06  Own a Compact Disc Player  
07  Own a Camcorder  
08  Have a Dog  
09  Have a Cat  
10  Own a Cellular Phone  
11  Subscribe to an Online/Internet Service  
12  Own an IBM or Compatible Computer  
13  Own an Apple/Macintosh Computer  
14  Own a CD-ROM  
15  Speak Spanish at Home

PLEASE CONTINUE ON BACK ► ► ►

## Free Manuals Download Website

<http://myh66.com>

<http://usermanuals.us>

<http://www.somanuals.com>

<http://www.4manuals.cc>

<http://www.manual-lib.com>

<http://www.404manual.com>

<http://www.luxmanual.com>

<http://aubethermostatmanual.com>

Golf course search by state

<http://golfingnear.com>

Email search by domain

<http://emailbydomain.com>

Auto manuals search

<http://auto.somanuals.com>

TV manuals search

<http://tv.somanuals.com>