

Pioneer *sound.vision.soul*

DJ MIXER

DJM-909

Operating Instructions

Thank you for buying this Pioneer product. Please read through these operating instructions so you will know how to operate your model properly. After you have finished reading the instructions, put them away in a safe place for future reference.

In some countries or regions, the shape of the power plug and power outlet may sometimes differ from that shown in the explanatory drawings. However the method of connecting and operating the unit is the same.

K015 En

CAUTION:

This product satisfies FCC regulations when shielded cables and connectors are used to connect the unit to other equipment. To prevent electromagnetic interference with electric appliances such as radios and televisions, use shielded cables and connectors for connections.

H012 En

IMPORTANT



The lightning flash with arrowhead symbol, within an equilateral triangle, is intended to alert the user to the presence of uninsulated "dangerous voltage" within the product's enclosure that may be of sufficient magnitude to constitute a risk of electric shock to persons.



CAUTION:
TO PREVENT THE RISK OF ELECTRIC SHOCK, DO NOT REMOVE COVER (OR BACK). NO USER-SERVICEABLE PARTS INSIDE. REFER SERVICING TO QUALIFIED SERVICE PERSONNEL.



The exclamation point within an equilateral triangle is intended to alert the user to the presence of important operating and maintenance (servicing) instructions in the literature accompanying the appliance.

NOTE: THE NO USER-SERVICEABLE PARTS COMPARTMENT WARNING IS LOCATED ON THE APPLIANCE BOTTOM.

IMPORTANT SAFETY INSTRUCTIONS

H003 En

READ INSTRUCTIONS — All the safety and operating instructions should be read before the product is operated.

RETAIN INSTRUCTIONS — The safety and operating instructions should be retained for future reference.

HEED WARNINGS — All warnings on the product and in the operating instructions should be adhered to.

FOLLOW INSTRUCTIONS — All operating and use instructions should be followed.

CLEANING — Unplug this product from the wall outlet before cleaning. The product should be cleaned only with a polishing cloth or a soft dry cloth. Never clean with furniture wax, benzene, insecticides or other volatile liquids since they may corrode the cabinet.

ATTACHMENTS — Do not use attachments not recommended by the product manufacturer as they may cause hazards.

WATER AND MOISTURE — Do not use this product near water — for example, near a bathtub, wash bowl, kitchen sink, or laundry tub; in a wet basement; or near a swimming pool; and the like.

ACCESSORIES — Do not place this product on an unstable cart, stand, tripod, bracket, or table. The product may fall, causing serious injury to a child or adult, and serious damage to the product. Use only with a cart, stand, tripod, bracket, or table recommended by the manufacturer, or sold with the product. Any mounting of the product should follow the manufacturer's instructions, and should use a mounting accessory recommended by the manufacturer.

CART — A product and cart combination should be moved with care. Quick stops, excessive force, and uneven surfaces may cause the product and cart combination to overturn.



VENTILATION — Slots and openings in the cabinet are provided for ventilation and to ensure reliable operation of the product and to protect it from overheating, and these openings must not be blocked or covered. The openings should never be blocked by placing the product on a bed, sofa, rug, or other similar surface. This product should not be placed in a built-in installation such as a bookcase or rack unless proper ventilation is provided or the manufacturer's instructions have been adhered to.

POWER SOURCES — This product should be operated only from the type of power source indicated on the marking label. If you are not sure of the type of power supply to your home, consult your product dealer or local power company.

LOCATION — The appliance should be installed in a stable location.

NONUSE PERIODS — The power cord of the appliance should be unplugged from the outlet when left unused for a long period of time.

GROUNDING OR POLARIZATION

- If this product is equipped with a polarized alternating current line plug (a plug having one blade wider than the other), it will fit into the outlet only one way. This is a safety feature. If you are unable to insert the plug fully into the outlet, try reversing the plug. If the plug should still fail to fit, contact your electrician to replace your obsolete outlet. Do not defeat the safety purpose of the polarized plug.
- If this product is equipped with a three-wire grounding type plug, a plug having a third (grounding) pin, it will only fit into a grounding type power outlet. This is a safety feature. If you are unable to insert the plug into the outlet, contact your electrician to replace your obsolete outlet. Do not defeat the safety purpose of the grounding type plug.

POWER-CORD PROTECTION — Power-supply cords should be routed so that they are not likely to be walked on or pinched by items placed upon or against them, paying particular attention to cords at plugs, convenience receptacles, and the point where they exit from the product.

OUTDOOR ANTENNA GROUNDING — If an outside antenna or cable system is connected to the product, be sure the antenna or cable system is grounded so as to provide some protection against voltage surges and built-up static charges. Article 810 of the National Electrical Code, ANSI/NFPA 70, provides information with regard to proper grounding of the mast and supporting structure, grounding of the lead-in wire to an antenna discharge unit, size of grounding conductors, location of antenna-discharge unit, connection to grounding electrodes, and requirements for the grounding electrode. See Figure A.

LIGHTNING — For added protection for this product during a lightning storm, or when it is left unattended and unused for long periods of time, unplug it from the wall outlet and disconnect the antenna or cable system. This will prevent damage to the product due to lightning and power-line surges.

POWER LINES — An outside antenna system should not be located in the vicinity of overhead power lines or other electric light or power circuits, or where it can fall into such power lines or circuits. When installing an outside antenna system, extreme care should be taken to keep from touching such power lines or circuits as contact with them might be fatal.

OVERLOADING — Do not overload wall outlets, extension cords, or integral convenience receptacles as this can result in a risk of fire or electric shock.

OBJECT AND LIQUID ENTRY — Never push objects of any kind into this product through openings as they may touch dangerous voltage points or short-out parts that could result in a fire or electric shock. Never spill liquid of any kind on the product.

SERVICING — Do not attempt to service this product yourself as opening or removing covers may expose you to dangerous voltage or other hazards. Refer all servicing to qualified service personnel.

DAMAGE REQUIRING SERVICE — Unplug this product from the wall outlet and refer servicing to qualified service personnel under the following conditions:

- When the power-supply cord or plug is damaged.
- If liquid has been spilled, or objects have fallen into the product.
- If the product has been exposed to rain or water.
- If the product does not operate normally by following the operating instructions. Adjust only those controls that are covered by the operating instructions as an improper adjustment of other controls may result in damage and will often require extensive work by a qualified technician to restore the product to its normal operation.
- If the product has been dropped or damaged in any way.
- When the product exhibits a distinct change in performance — this indicates a need for service.

REPLACEMENT PARTS — When replacement parts are required, be sure the service technician has used replacement parts specified by the manufacturer or have the same characteristics as the original part. Unauthorized substitutions may result in fire, electric shock, or other hazards.

SAFETY CHECK — Upon completion of any service or repairs to this product, ask the service technician to perform safety checks to determine that the product is in proper operating condition.

WALL OR CEILING MOUNTING — The product should not be mounted to a wall or ceiling.

HEAT — The product should be situated away from heat sources such as radiators, heat registers, stoves, or other products (including amplifiers) that produce heat.

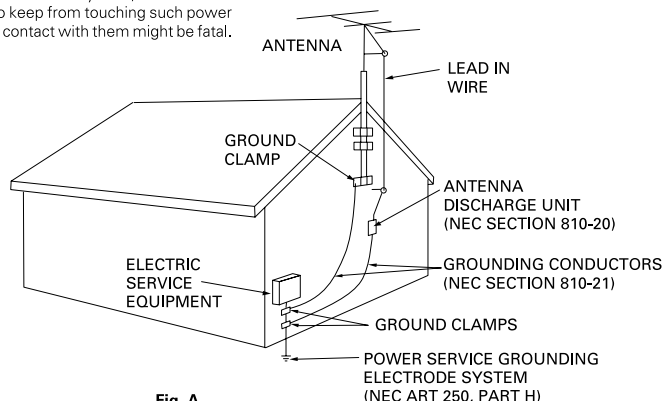

Fig. A

NEC — NATIONAL ELECTRICAL CODE

WARNING: THE APPARATUS IS NOT WATERPROOF, TO PREVENT FIRE OR SHOCK HAZARD, DO NOT EXPOSE THIS APPLIANCE TO RAIN OR MOISTURE AND DO NOT PUT ANY WATER SOURCE NEAR THIS APPARATUS, SUCH AS VASE, FLOWER POT, COSMETICS CONTAINER AND MEDICINE BOTTLE ETC.

H001AEn

[For Canadian model]

CAUTION: TO PREVENT ELECTRIC SHOCK, DO NOT USE THIS (POLARIZED) PLUG WITH AN EXTENSION CORD, RECEPTACLE OR OTHER OUTLET UNLESS THE BLADES CAN BE FULLY INSERTED TO PREVENT BLADE EXPOSURE.

ATTENTION: POUR PREVENIR LES CHOCS ELECTRIQUES NE PAS UTILISER CETTE FICHE POLARISEE AVEC UN PROLONGATEUR UNE PRISE DE COURANT OU UNE AUTRE SORTIE DE COURANT, SAUF SI LES LAMES PEUVENT ETRE INSEREES A FOND SANS EN LAISSER AUCUNE PARTIE A DECOUVERT.

H007A2L

Information to User

Alteration or modifications carried out without appropriate authorization may invalidate the user's right to operate the equipment.

H011 En

NOTE: This equipment has been tested and found to comply with the limits for a Class B digital device, pursuant to Part 15 of the FCC Rules. These limits are designed to provide reasonable protection against harmful interference in a residential installation. This equipment generates, uses, and can radiate radio frequency energy and, if not installed and used in accordance with the instructions, may cause harmful interference to radio communications. However, there is no guarantee that interference will not occur in a particular installation. If this equipment does cause harmful interference to radio or television reception, which can be determined by turning the equipment off and on, the user is encouraged to try to correct the interference by one or more of the following measures:

- Reorient or relocate the receiving antenna.
- Increase the separation between the equipment and receiver.
- Connect the equipment into an outlet on a circuit different from that to which the receiver is connected.
- Consult the dealer or an experienced radio/TV technician for help.

H010 En



Dear Customer:

Selecting fine audio equipment such as the unit you've just purchased is only the start of your musical enjoyment. Now it's time to consider how you can maximize the fun and excitement your equipment offers. This manufacturer and the Electronic Industries Association's Consumer Electronics Group want you to get the most out of your equipment by playing it at a safe level. One that lets the sound come through loud and clear without annoying blaring or distortion-and, most importantly, without affecting your sensitive hearing.

Sound can be deceiving. Over time your hearing "comfort level" adapts to higher volumes of sound. So what sounds "normal" can actually be loud and harmful to your hearing. Guard against this by setting your equipment at a safe level BEFORE your hearing adapts.

To establish a safe level:

- Start your volume control at a low setting.
- Slowly increase the sound until you can hear it comfortably and clearly, and without distortion.

Once you have established a comfortable sound level:

- Set the dial and leave it there.

Taking a minute to do this now will help to prevent hearing damage or loss in the future. After all, we want you listening for a lifetime.

IMPORTANT NOTICE

The serial number for this equipment is located on the bottom plate. Please write this serial number on your enclosed warranty card and keep it in a secure area. This is for your security.

[For Canadian model]

This Class B digital apparatus complies with Canadian ICES-003.

[Pour le modèle Canadien]

Cet appareil numérique de la classe B est conforme à la norme NMB-003 du Canada.

H009 2L

WARNING:

Handling the cord on this product or cords associated with accessories sold with the product will expose you to lead, a chemical known to the State of California and other governmental entities to cause cancer and birth defects or other reproductive harm.

Wash hands after handling.

We Want You Listening For A Lifetime

Used wisely, your new sound equipment will provide a lifetime of fun and enjoyment. Since hearing damage from loud noise is often undetectable until it is too late, this manufacturer and the Electronic Industries Association's Consumer Electronics Group recommend you avoid prolonged exposure to excessive noise. This list of sound levels is included for your protection.

Decibel

<u>Level</u>	<u>Example</u>
30	Quiet library, soft whispers
40	Living room, refrigerator, bedroom away from traffic
50	Light traffic, normal conversation, quiet office
60	Air conditioner at 20 feet, sewing machine
70	Vacuum cleaner, hair dryer, noisy restaurant
80	Average city traffic, garbage disposals, alarm clock at two feet.

THE FOLLOWING NOISES CAN BE DANGEROUS UNDER CONSTANT EXPOSURE

90	Subway, motorcycle, truck traffic, lawn mower
100	Garbage truck, chain saw, pneumatic drill
120	Rock band concert in front of speakers, thunderclap
140	Gunshot blast, jet plane
180	Rocket launching pad

Information courtesy of the Deafness Research Foundation.



S001 En

CONTENTS

CAUTIONS REGARDING HANDLING	4
Location	4
Condensation	4
Cleaning the Unit	4
FEATURES	4
CHECKING ACCESSORIES	5
CONNECTIONS	5
PART NAMES AND FUNCTIONS	7
Top Panel	7
Front Panel	12
Rear Panel	13
Touch Panel Display Contents	14
Touch Panel Display Selection	15
BPM COUNTING	16
FADER OPERATIONS	17
EFFECT FUNCTIONS	19
Types of Effects	19
Using the Effect Functions	22
Presetting Effects	23
Effect Parameters	24
TROUBLESHOOTING	27
SPECIFICATIONS	28

CAUTIONS REGARDING HANDLING

Location

Install the unit in a well-ventilated location where it will not be exposed to high temperatures or humidity.

- Do not install the unit in a location which is exposed to direct rays of the sun, or near stoves or radiators. Excessive heat can adversely affect the cabinet and internal components. Installation of the unit in a damp or dusty environment may also result in a malfunction or accident. (Avoid installation near cookers etc., where the unit may be exposed to oily smoke, steam or heat.)
- When the unit is used inside a carrying case or DJ booth, separate it from the walls or other equipment to improve heat radiation.

Condensation

When this unit is brought into a warm room from previously cold surroundings or when the room temperature rises sharply, condensation may form inside, and the unit may not be able to attain its full performance. In cases like this, allow the unit to stand for about an hour or raise the room temperature gradually.

Cleaning the Unit

- Use a polishing cloth to wipe off dust and dirt.
- When the surfaces are very dirty, wipe with a soft cloth dipped in some neutral cleanser diluted five or six times with water and wrung out well, then wipe again with a dry cloth. Do not use furniture wax or cleaners.
- Never use thinners, benzene, insecticide sprays or other chemicals on or near this unit, since these will corrode the surfaces.

FEATURES

1) Designed for high sound quality

Electronic parts have been carefully selected and internal circuitry redesigned to provide the shortest-possible signal paths, thus realizing true club sound with power to spare.

2) Effects create new performance potential

- ① **50 effects in 2 systems:** Each channel can be preset with three of 50 possible effects. Sequential effects can be called up seamlessly merely by touching the names of the effects on the top panel's LCD touch panel, creating a new level of DJ performances.
- ② **Fader effects:** an industry first, Pioneer's "fader effects" allow the user to change effect parameters by operating the sliders for the cross fader or channel fader, thus providing greater operating facility compared to conventional rotating dials, while also allowing the DJ to apply scratch sounds to effects and create other new remix performances.
- ③ **Beat effects:** linked to track tempo (BPM: beats per minute), "beat effects" allow the user to apply echo, delay and other effects with perfect timing.
- ④ **Effect frequency selection:** effects can be targeted at HI, MID, and LOW frequency ranges as desired; simultaneous multiple frequency ranges can also be specified.

3) Ergonomic, user-customizable cross fader

- ① **Cross-fader "feeling" adjustment:** the specific physical sensation of cross fader operation is all-important to the DJ; the "feeling" adjustment provided in this mixer is an industry first, allowing the user to adjust the physical sensation of the slider to personal preferences, for the smoothest possible cross fader operation.
- ② **Independent cross fader lag cut:** the mechanical play (the lag distance before sound begins) at each end of the cross fader slider can be adjusted using the fader lag cut function, thus allowing adjustment of the sound cut when performing scratch play.
- ③ **Independent cross fader curve:** an industry first, the right-left independently adjustable (33 steps) cross fader curve control goes beyond the symmetrical type of cross fader curve on conventional mixers, thus broadening DJ performance capabilities.
- ④ **"Contactless fader" mechanism:** based on Pioneer's own proprietary technology, this new contactless optical fader assures durable and stable operation under the severest of DJ performance conditions.

4) Touch-panel display provides both wide information and ease of operation

The top panel LCD display includes a fader edit monitor that displays information about user fader settings (curve, reverse, cut lag, etc.) together with other information necessary for remix and DJ play. The use of a touch panel also makes it possible to select effects easily with a single touch.

5) Other features

- ① An industry first for DJ mixers, this unit supports use of an optional foot switch to allow quick ON/OFF control of effects.
- ② When connected via a control cord to a Pioneer DJ CD player (sold separately), operation of the fader can be used for automatic "fader start" play.
- ③ "Fader reverse" function allows reversing of the directions of fader operation movement.
- ④ Delicate 33-step channel fader curve settings.
- ⑤ Can be connected in series to other mixers for "session" output of mixed sounds.

CHECKING ACCESSORIES

- Hexagonal Allen driver (for cross fader operating load adjust screw)
- These operating instructions
- Warranty

CONNECTIONS

When connecting or changing the connection of units, make sure to first turn off the power switch and disconnect the power cord from the outlet.

This mixer is not furnished with any connection cables; when performing connections, use the cables that came provided with your player and other components, or purchase commercially available audio cables.

1. Connecting Input Components

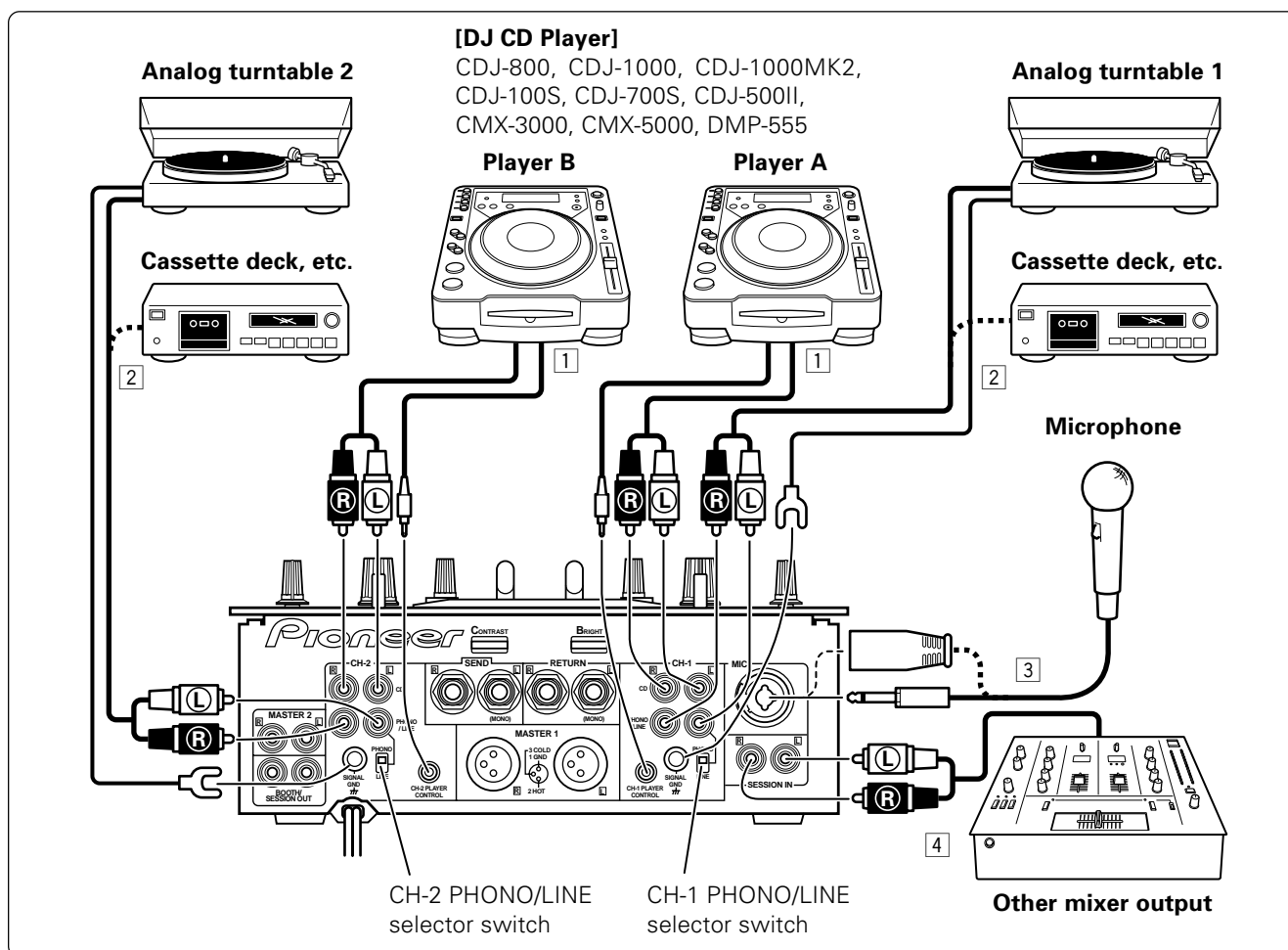

DJ CD Players **1**

Connect the AUDIO OUT connectors from Player A to the CH-1 CD input jacks of the DJ mixer, and connect the AUDIO OUT connectors from Player B to the CH-2 CD input jacks. When using one of the listed DJ CD players, the control cord furnished with the CD player should be connected between the player and the DJ mixer. In this way, the DJ mixer's fader lever can be operated to control operation of the DJ CD player for fader start play and back cue.

Analog turntable / Cassette deck, etc. **2**

Connect the analog turntable 1 output cables to the CH-1 PHONO/LINE jacks of the DJ mixer, and connect the ground wire to the SIGNAL GND terminal. Set the CH-1 PHONO/LINE selector switch to [PHONO]. When connecting a cassette deck or other such component to these jacks, set the CH-1 PHONO/LINE selector switch to [LINE].

Connect the analog turntable 2 output cables to the CH-2 PHONO/LINE jacks of the DJ mixer, and connect the ground wire to the SIGNAL GND terminal. Set the CH-2 PHONO/LINE selector switch to [PHONO]. When connecting a cassette deck or other such component to these jacks, set the CH-2 PHONO/LINE selector switch to [LINE].

* The PHONO input for this DJ mixer supports use of a MM cartridge.

MIC **3**

The MIC jack on this unit supports use of either PHONE type or XLR type plugs.

SESSION IN **4**

When using multiple mixers simultaneously, use the appropriate audio cables to connect the other mixer outputs to these jacks.

CONNECTIONS

2. Connecting Foot Switch and Headphones (front panel)

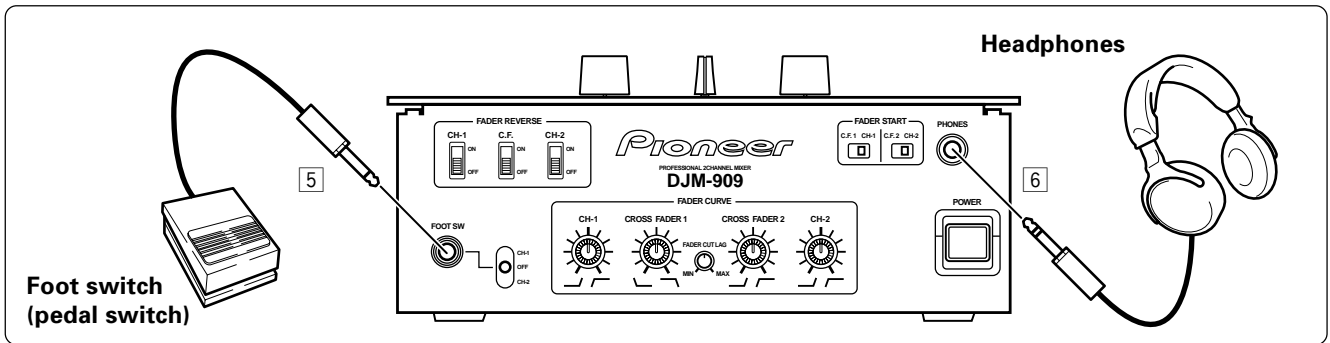

Foot switch **5**

Allows the connection of a foot switch with a 6.3 mm monaural plug. The foot switch control effect ON/OFF.

Headphones **6**

Use to connect headphones with a 6.3 mm diameter stereo plug.

3. Output Connections

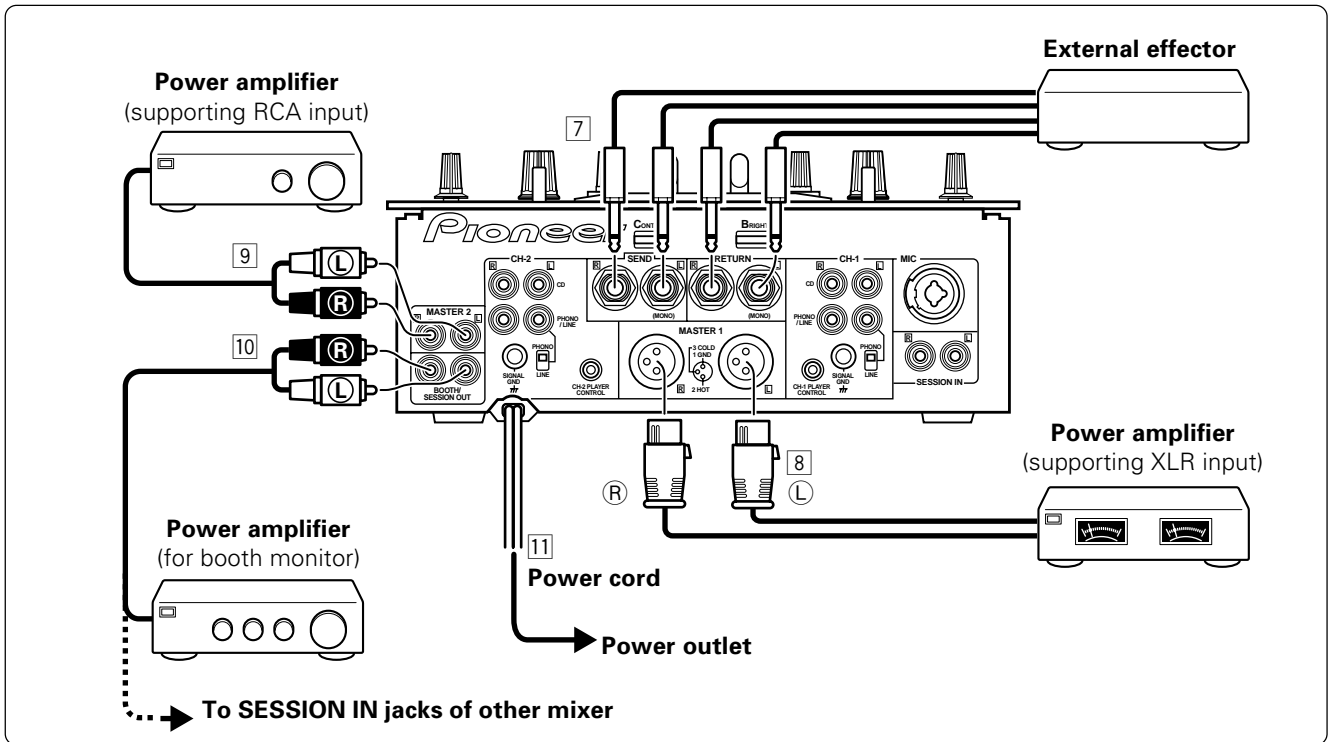

External effector **7**

Use a 6.3 mm monaural plug to connect the external effector's input connectors to the DJ mixer's SEND jacks. When using an effector with a monaural input, connect it to the L channel output only. The signal actually sent to the effector will represent a mix of L and R signals. Use a 6.3 mm monaural plug to connect the external effector's output connectors to the DJ mixer's RETURN jacks. When using an effector with monaural output, connect only the L channel input. The signal received from the effector will be input to both L and R channels.

Master output

MASTER 1 **8**

XLR type balanced output.

MASTER 2 **9**

RCA type unbalanced output.

BOOTH/SESSION OUT **10**

These jacks are provided for both monitor output. The sound volume here is controlled by the booth monitor level dial, regardless of the setting of the MASTER LEVEL dial.

When using this unit in tandem with another mixer, connect these jacks to the other mixer's session input connectors.

Power cord **11**

After completing all other connections, connect the power plug to a standard power outlet or to the auxiliary power outlet of an amplifier.

PART NAMES AND FUNCTIONS

Top Panel (1)

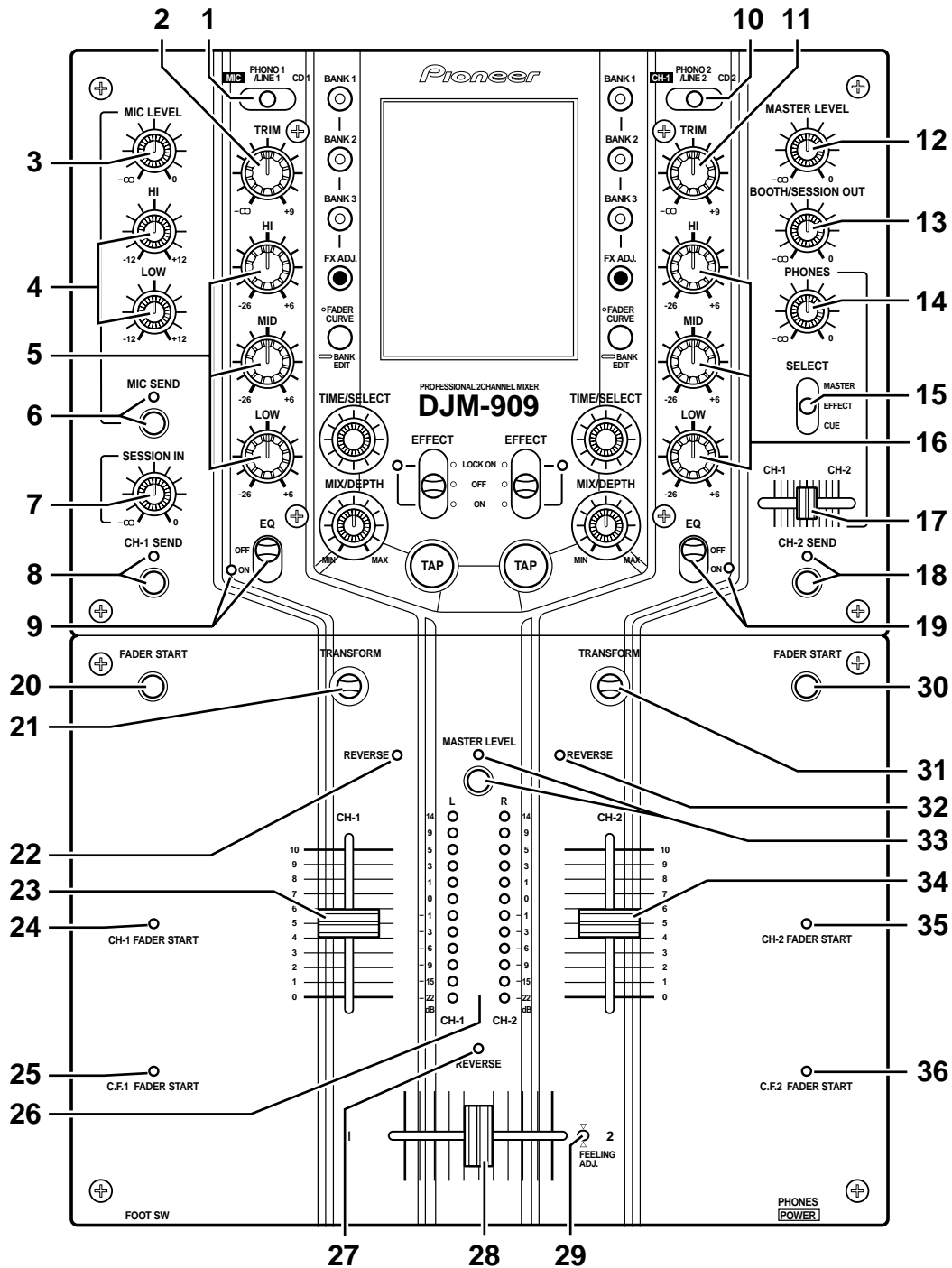

1 CH-1 input selector switch (MIC - PHONO 1/LINE 1 - CD 1)

Use to select input signal from MIC jack, CH-1 PHONO/LINE input jacks, or CH-1 CD input jacks, and send them to the TRIM control.

* When [MIC] is selected, the MIC signals are sent directly to the TRIM section without passing through the microphone level and microphone equalizer circuits.

2 CH-1 TRIM dial

Use to adjust the CH-1 input signal level (range of adjustment: +9 dB to $-\infty$).

3 Microphone level dial (MIC LEVEL)

Use to adjust the microphone level (range of adjustment: 0 dB to $-\infty$).

4 Microphone equalizer dials (HI/LOW)

HI

Use to adjust microphone treble response (range of adjustment: 10 kHz, ± 12 dB).

LOW

Use to adjust microphone bass response (range of adjustment: 100 Hz, ± 12 dB).

PART NAMES AND FUNCTIONS

5 CH-1 equalizer dials (HI/MID/LOW)

HI

Use to adjust CH-1 input treble response (range of adjustment: 13 kHz, +6 dB to -26 dB).

MID

Use to adjust CH-1 input midrange response (range of adjustment: 1 kHz, +6 dB to -26 dB).

LOW

Use to adjust CH-1 input bass response (range of adjustment: 70 Hz, +6 dB to -26 dB).

6 MIC SEND button and indicator

When set to On, the indicator lights, and microphone signals are output at the SEND jacks. This function is disabled when the CH-1 input selector switch is set to [MIC].

7 Session input level dial (SESSION IN)

Use to adjust the session input volume (range of adjustment: 0 dB to $-\infty$).

8 CH-1 SEND button and indicator

When set to On, the indicator lights, and CH-1 signals are output at the SEND jacks.

9 CH-1 EQ ON/OFF switch and indicator

When set to [ON], the indicator lights and CH-1 equalizer is enabled.

When set to [OFF], the indicator goes out and the equalizer circuit is bypassed.

10 CH-2 input selector switch (CH-1 – PHONO 2/LINE 2 – CD 2)

Use to select input signal from CH-1 (component selected with CH-1 input selector switch), CH-2 PHONO/LINE input jacks, or CH-2 CD input jacks, and send them to the TRIM control.

* When [CH-1] is selected, signals are sent to the CH-2 TRIM control without being sent through the CH-1 TRIM control.

11 CH-2 TRIM dial

Use to adjust the CH-2 input signal level (range of adjustment: +9 dB to $-\infty$).

12 MASTER LEVEL dial

User to adjust the master output volume level (range of adjustment: 0 dB to $-\infty$).

13 Booth monitor level dial (BOOTH/SESSION OUT)

Use to adjust the volume level of signals at the BOOTH/SESSION OUT jacks (range of adjustment: 0 dB to $-\infty$).

This level can be set independently of the setting of the MASTER LEVEL dial.

14 Headphones level dial (PHONES)

Use to adjust the volume level of the headphones output (range of adjustment: 0 dB to $-\infty$).

15 Monitor SELECT switch

MASTER position

selects MASTER output. (This setting allows output regardless of the setting of the MASTER LEVEL dial.)

EFFECT position

Regardless of the [ON/OFF] setting of the EFFECT switch, the output is the signal selected with CUE, with effects added.

CUE position

selects the channel adjusted with the headphone mixing lever (17).

16 CH-2 equalizer dials (HI/MID/LOW)

HI

Use to adjust CH-2 input treble response (range of adjustment: 13 kHz, +6 dB to -26 dB).

MID

Use to adjust CH-2 input midrange response (range of adjustment: 1 kHz, +6 dB to -26 dB).

LOW

Use to adjust CH-2 input bass response (range of adjustment: 70 Hz, +6 dB to -26 dB).

17 Headphone mixing lever (CH-1 – CH-2)

This lever does not function when the monitor SELECT switch (15) is set to [MASTER].

When the monitor SELECT switch (15) is set to [EFFECT] or [CUE], moving the lever to the left side produces CH-1 monitor output, while moving it to the right produces CH-2 monitor output. Centering the lever at the center detent position produces balanced output of CH-1 and CH-2 signals.

18 CH-2 SEND button and indicator

When set to On, the indicator lights, and CH-2 signals are output at the SEND jacks.

19 CH-2 EQ ON/OFF switch and indicator

When set to [ON], the indicator lights and the CH-2 equalizer is enabled.

When set to [OFF], the indicator goes out and the equalizer circuit is bypassed.

20 CH-1 FADER START button

When this button is set to On, fader start and back cue can be performed on the CH-1 CD player.

Whether the operation is initiated by operation of the CH-1 fader lever, or by the cross fader lever is determined by the position of the front panel's FADER START selector switch; the selection is indicated by the lighting of the top panel's CH-1 FADER START indicator or C.F.1 FADER START indicator.

* For DJ CD players supporting the fader start/back cue function, see page 5, "1. Connecting Input Components".

21 CH-1 output On/Off lever (TRANSFORM)

Use to set CH-1 output to On or Off (Mute).

The lever's setting angle can be changed in 45° increments (changing of the angle should be performed by an authorized Pioneer service technician).

22 CH-1 REVERSE indicator

When lighted, indicates that the front panel's FADER REVERSE switch has been set so that the CH-1 fader lever operates in the reverse direction (see front panel item 52).

23 CH-1 fader lever

The CH-1 fader lever is used to control the level of signals sent to the cross fader. Signal level is maximum at scale mark "10," and minimum at scale mark "0".

When the front panel CH-1 FADER REVERSE switch is set to [ON], the signal level is maximum at scale mark "0," and minimum at scale mark "10".

* The channel fader curve can be adjusted by means of the front panel FADER CURVE dials.

24 CH-1 FADER START indicator

Lights when the CH-1 fader start/back cue function is enabled (see also top panel item 20 and front panel item 53).

25 C.F.1 FADER START indicator

Lights when CH-1 cross-fader start/back cue function is enabled (see also top panel item 20 and front panel item 53).

26 Level meters

Displays CH-1 and CH-2 peak levels or master output (stereo) peak levels (see also item 33).

27 Cross fader REVERSE indicator

Indicates that the front panel's FADER REVERSE switch has been set so that the cross fader now operates in reverse (left side is CH-2, right side is CH-1) (see also front panel item 52).

28 Cross fader lever

When the lever is moved to the left side, CH-1 is at maximum output and CH-2 is at minimum. When moved to the right side, CH-2 is at maximum output and CH-1 is at minimum.

* The cross fader curve can be adjusted individually for CH-1 and CH-2 by means of the front panel FADER CURVE dials.

29 Operating load adjust screw (FEELING ADJ.)

The hexagonal Allen screw located next to the panel's slider opening can be rotated with a hexagonal Allen driver to adjust the sliding resistance of the cross fader lever. (See page 17, "Operating load adjust screw".)

30 CH-2 FADER START button

When this button is set to On, fader start and back cue can be performed on the CH-2 CD player.

Whether the operation is initiated by operation of the CH-2 fader lever, or by the cross fader lever is determined by the position of the front panel's FADER START selector switch; the selection is indicated by the lighting of the top panel's CH-2 FADER START indicator or C.F.2 FADER START indicator.

* For DJ CD players supporting the fader start/back cue function, see page 5, "1. Connecting Input Components".

31 CH-2 output On/Off lever (TRANSFORM)

Use to set CH-2 output to On or Off (Mute).

This lever's setting angle can be changed in 45° increments (changing of the angle should be performed by an authorized Pioneer service technician).

32 CH-2 REVERSE indicator

When lighted, indicates that the front panel's FADER REVERSE switch has been set so that the CH-2 fader lever operates in the reverse direction (see front panel item 52).

33 MASTER LEVEL display button and indicator

When depressed to the On position, the indicator lights and the level meters display the master output (stereo) peak levels. When turned Off, the level meters display the peak levels for CH-1 (left) and CH-2 (right) (see also item 26).

34 CH-2 fader lever

The CH-2 fader lever is used to control the level of signals sent to the cross fader. Signal level is maximum at scale mark "10," and minimum at scale mark "0".

When the front panel CH-2 FADER REVERSE switch is set to [ON], the signal level is maximum at scale mark "0," and minimum at scale mark "10".

* The channel fader curve can be adjusted by means of the front panel FADER CURVE dials.

35 CH-2 FADER START indicator

Lights when the CH-2 fader start/back cue function is enabled (see also top panel item 30 and front panel item 53).

36 C.F.2 FADER START indicator

Lights when CH-2 cross-fader start/back cue function is enabled (see also top panel item 30 and front panel item 53).

Top Panel (2)

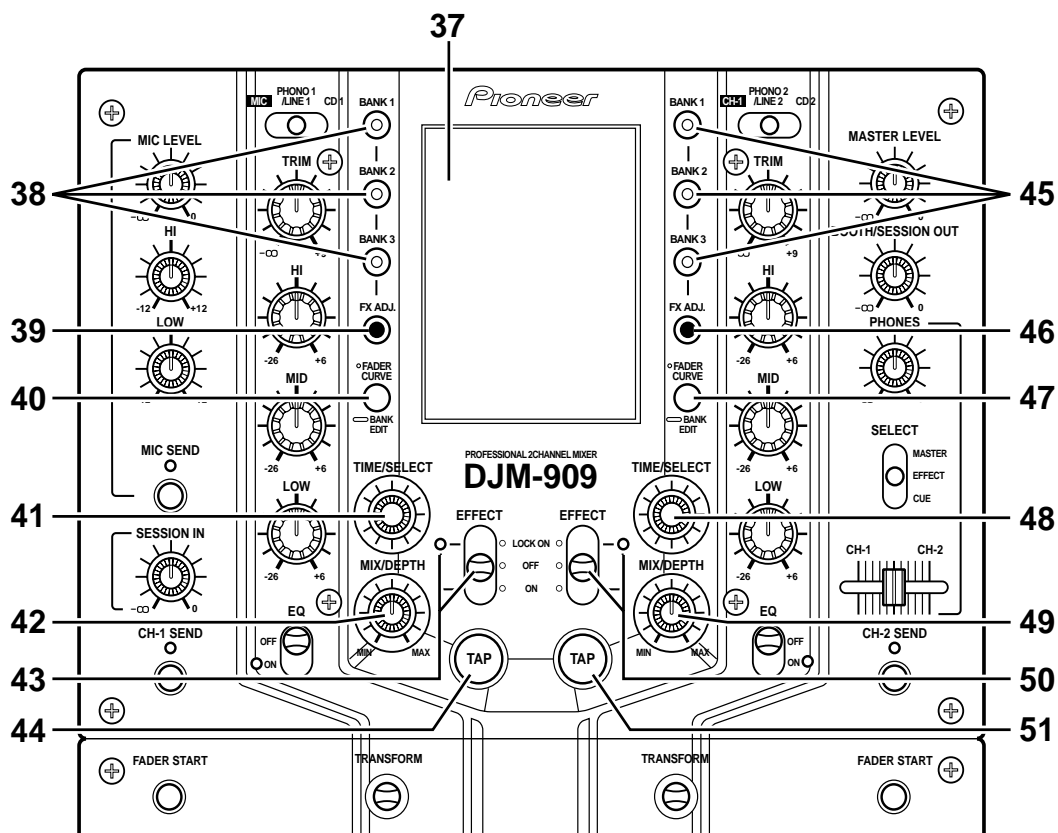

37 Touch Panel

Touch this screen to set effects in accordance with the displayed menus.

* The panel's screen contrast and backlight luminance can be adjusted (see rear panel items 61 and 63).

38 CH-1 effect bank buttons and indicators (BANK 1, 2, 3)

When one of these buttons is pressed, the indicator lights and the corresponding preset effect is enabled. Each BANK button can be recorded with three effects for CH-1 (at time of shipping, the buttons have been factory preset with typically used effects). BANK 1 is selected in the default condition after power is initially turned on.

39 CH-1 effect parameter adjust button (FX ADJ.)

Press to display the touch panel's CH-1 effect parameter adjust menu.

40 Fader curve display and CH-1 effect select button (FADER CURVE/BANK EDIT)

Press to display the fader curve on the touch panel. Holding the button depressed for about one second will cause the touch panel to display the CH-1 effect select menu.

41 CH-1 effect time adjust/select dial (TIME/SELECT)

Use to adjust the time parameters of effects applied to CH-1 (rotate clockwise to lengthen, counterclockwise to shorten). When the effect select menu is displayed, causes the effects list to scroll.

42 CH-1 effect mix ratio/depth adjust dial (MIX/DEPTH)

Use to adjust the volume (amount) of effects applied to CH-1 (rotate clockwise to increase effects, counterclockwise to reduce).

43 CH-1 effect switch and indicator (EFFECT LOCK ON/OFF/ON)

To turn effects [ON], either pull switch forward (switch returns automatically to [OFF] when released) or slide to far side to the [LOCK ON] position. When effects are [ON], the indicator flashes and effects are applied to CH-1.

44 CH-1 TAP button

Under normal conditions, the automatic BPM counter operates to display the track's BPM value on the touch panel. Automatic BPM counting may be difficult with some tracks, however. In such cases, or if you wish to deliberately set a different BPM, use the TAP button.

- The BPM value can be changed by rotating the TIME/SELECT dial while holding the TAP button depressed.
- Tapping the button in time with the beat will cause the function to switch to the manual BPM count mode; the tapped beat will be counted and displayed as the BPM value. Returning to the auto BPM mode is performed from the effect parameter adjust screen (see page 16, "Automatic Mode BPM Counting").

45 CH-2 effect bank buttons and indicators (BANK 1, 2, 3)

When one of these buttons is pressed, the indicator lights and the corresponding preset effect is enabled. Each BANK button can be recorded with three effects for CH-2 (at time of shipping, the buttons have been factory preset with typically used effects). BANK 1 is selected in the default condition after power is initially turned on.

46 CH-2 effect parameter adjust button (FX ADJ.)

Press to display the touch panel's CH-2 effect parameter adjust menu.

47 Fader curve display and CH-2 effect select button (FADER CURVE/BANK EDIT)

Press to display the fader curve on the touch panel. Holding the button depressed for about one second will cause the touch panel to display the CH-2 effect select menu.

48 CH-2 effect time adjust/select dial (TIME/SELECT)

Use to adjust the time parameters of effects applied to CH-2 (rotate clockwise to lengthen, counterclockwise to shorten). When the effect select menu is displayed, causes the effects list to scroll.

49 CH-2 effect mix ratio/depth adjust dial (MIX/DEPTH)

Use to adjust the volume (amount) of effects applied to CH-2 (rotate clockwise to increase effects, counterclockwise to reduce).

50 CH-2 effect switch and indicator (EFFECT LOCK ON/OFF/ON)

To turn effects [ON], either pull switch forward (switch returns automatically to [OFF] when released) or slide to far side to the [LOCK ON] position. When effects are [ON], the indicator flashes and effects are applied to CH-2.

51 CH-2 TAP button

Under normal conditions, the automatic BPM counter operates to display the track's BPM value on the touch panel. Automatic BPM counting may be difficult with some tracks, however. In such cases, or if you wish to deliberately set a different BPM, use the TAP button.

- The BPM value can be changed by rotating the TIME/SELECT dial while holding the TAP button depressed.
- Tapping the button in time with the beat will cause the function to switch to the manual BPM count mode; the tapped beat will be counted and displayed as the BPM value. Returning to the auto BPM mode is performed from the effect parameter adjust screen (see page 16, "Automatic Mode BPM Counting").

Front Panel

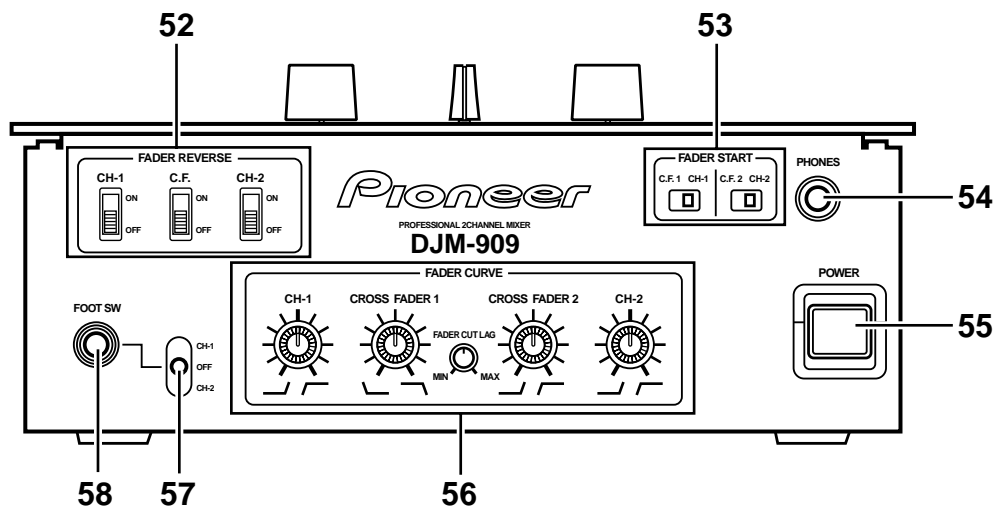

52 FADER REVERSE switches

CH-1 ON/OFF

When set to [ON], the top panel's CH-1 REVERSE indicator lights, and the CH-1 fader lever operates in the reverse direction (scale mark "0" becomes 0 dB attenuation, and "10" becomes minus infinity). The fader start function also operates in reverse.

CH-2 ON/OFF

When set to [ON], the top panel's CH-2 REVERSE indicator lights, and the CH-2 fader lever operates in the reverse direction (scale mark "0" becomes 0 dB attenuation, and "10" becomes minus infinity). The fader start function also operates in reverse.

C.F. ON/OFF

When set to [ON], the top panel's cross fader REVERSE indicator lights, and the cross fader lever operates in the reverse direction (left side becomes CH-2, and right side becomes CH-1). The fader start function also operates in reverse.

53 FADER START selector switches

C.F.1 / CH-1

This switch determines whether the fader start operation for the CD player connected to CH-1 is activated by the cross fader lever, or by the CH-1 fader lever.

When the top panel's CH-1 FADER START button is set to On, selecting [C.F.1] causes the top panel's C.F.1 FADER START indicator to light, and selecting [CH-1] causes the top panel's CH-1 FADER START indicator to light.

C.F.2 / CH-2

This switch determines whether the fader start operation for the CD player connected to CH-2 is activated by the cross fader lever, or by the CH-2 fader lever.

When the top panel's CH-2 FADER START button is set to On, selecting [C.F.2] causes the top panel's C.F.2 FADER START indicator to light, and selecting [CH-2] causes the top panel's CH-2 FADER START indicator to light.

54 Headphone output jack (PHONES)

Accepts a 6.3 mm stereo headphones plug.

55 POWER switch

56 Fader attenuation dials (FADER CURVE)

CH-1

Use to adjust CH-1's fader attenuation curve.

CH-2

Use to adjust CH-2's fader attenuation curve.

CROSS FADER 1

Use to adjust cross fader's CH-1 attenuation curve.

CROSS FADER 2

Use to adjust cross fader's CH-2 attenuation curve.

FADER CUT LAG

Use to adjust mechanical play at both extremes of the cross fader movement (the range in which lever movement produces no effect).

(See page 17, "Fader attenuation curve adjustment".)

57 Foot switch channel select switch (FOOT SW CH-1/OFF/CH-2)

Use to select whether the Effect On/Off foot switch function operates on channel 1 [CH-1], channel 2 [CH-2]. When the switch is in the center position, both CH-1 and CH-2 are [OFF].

58 Foot switch jack (FOOT SW)

This 6.3 mm RCA jack can be used to connect an On/Off type pedal switch used to turn effects On and Off.

Various types of foot switch are available; some turn On when pressed, some turn Off when pressed, and others have locking mechanisms (alternate On/Off with successive presses). Select the type in accordance with your own preferences.

Rear Panel

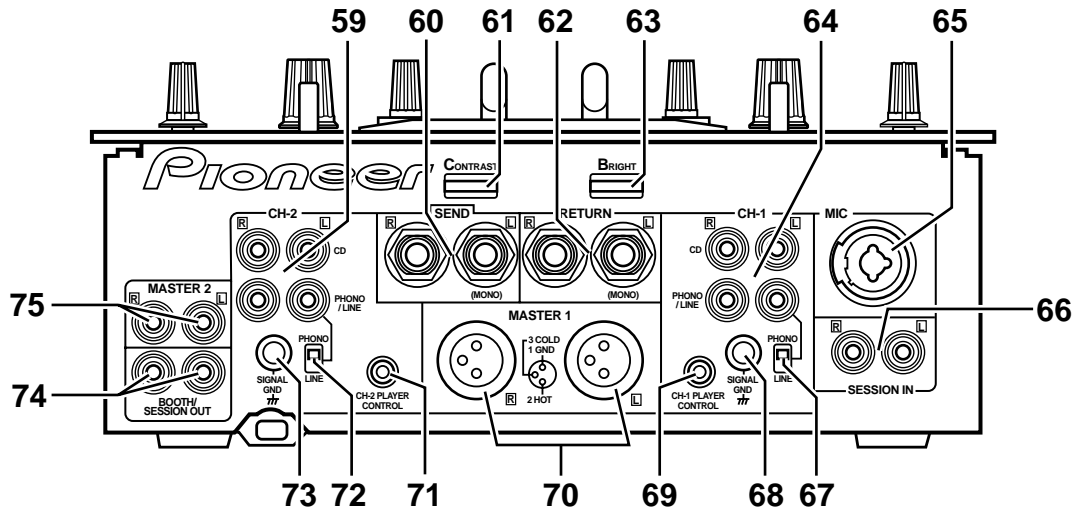
**59 CH-2 input jacks****CD**

Connect to audio output from CH-2 CD player.

PHONO / LINE

Connect to audio output from CH-2 analog turntable, cassette deck or other line signal level component.

60 External effector output jacks (SEND)

Connect to the input connectors of an external effector. When the top panel switches (MIC SEND, CH-1 SEND, and CH-2 SEND) are set to On, these jacks output the MIC, CH-1, and CH-2 signals to the external effector.

When using an effector with a monaural input, connect it to the L channel output only. The signal actually sent to the effector will represent a mix of L and R signals.

61 Touch panel screen contrast control (CONTRAST)

Use to adjust the top panel's touch panel contrast.

62 External effector return jacks (RETURN)

Connect to the output connectors of the external effector. When using an effector with monaural output, connect only to the L channel input. The signal received from the effector will be input to both L and R channels.

63 Touch panel backlight control (BRIGHT)

Use to adjust the top panel's touch panel backlight luminance.

64 CH-1 input jacks**CD**

Connect to the audio output of the CH-1 CD player.

PHONO / LINE

Connect to audio output from CH-1 analog turntable, cassette deck or other line signal level component.

65 Microphone input jack (MIC)

Connect to a microphone with XLR type or PHONE type plug. When applying effects to the microphone sound, set the top panel's CH-1 input selector switch (MIC-PHONO 1/LINE 1-CD1) to the [MIC] position.

66 Session input jacks (SESSION IN)

When using multiple mixers simultaneously, connect the other mixer outputs to these jacks.

67 CH-1 PHONO/LINE selector switch

Use to set the input sensitivity at the CH-1 PHONO/LINE connectors. The [PHONO] position supports an MM type cartridge.

* When no analog turntable is used, set this switch to the [LINE] side.

68 CH-1 signal ground (SIGNAL GND)

Connect to the CH-1 analog turntable's ground wire. Note that this is not meant as a safety ground.

69 CH-1 PLAYER CONTROL jack

When a Pioneer DJ CD player is connected to the CH-1 CD jacks, a special control cord can be used to connect this jack to the player's control jack, thus enabling the fader start function.

70 MASTER 1 jacks

XLR type balanced output. Connect to the power amplifier's balanced input jacks.

71 CH-2 PLAYER CONTROL jack

When a Pioneer DJ CD player is connected to the CH-2 CD jacks, a special control cord used to connect this jack to the player's control jack, thus enabling the fader start function.

72 CH-2 PHONO/LINE selector switch

Use to set the input sensitivity at the CH-2 PHONO/LINE connectors. The [PHONO] position supports an MM type cartridge.

* When no analog turntable is used, set this switch to the [LINE] side.

73 CH-2 signal ground (SIGNAL GND)

Connect to the CH-2 analog turntable's ground wire. Note that this is not meant as a safety ground.

74 BOOTH/SESSION OUT jacks

Connector jacks for booth monitor output. When using this unit in tandem with another mixer, connect these jacks to the other mixer's session input jacks.

75 MASTER 2 jacks

RCA type unbalanced output. Connect to the power amplifier's unbalanced input jacks.

Touch Panel Display Contents

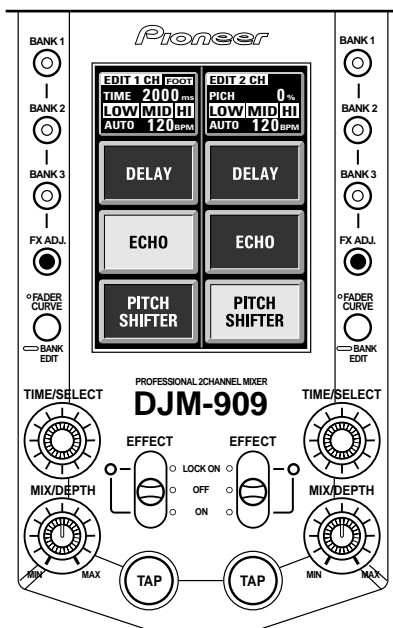

The touch panel display has four basic patterns (A-D). The screen contents shown in the accompanying illustrations depict one example of the basic patterns, while actual displays may differ, depending on the kind of settings and status involved.

A. Effect type display (main page)

This display appears when the power is first turned on, or when one of the BANK (1-3) buttons is pressed. The effects for each channel are displayed as buttons, with the currently selected button displayed in reverse illumination (in this manual, indicated as black characters against white background). Other displays show status of foot switch, selected effect parameters, frequency bands subject to effects, TIME display and BPM display.

CH-1 side EFFECT ← | → CH-2 side EFFECT

When a foot switch is connected, FOOT is displayed.
The frequency band subjected to effects is highlighted (HI, MID, LOW).
BPM count method is displayed (AUTO).
Currently selected effect is highlighted (ECHO, PITCH SHIFTER).



B. Effect select display

Hold the FADER CURVE/BANK EDIT button depressed for about one second to change the screen to the main page effect select menu (settable independently for each channel). Rotate the TIME/SELECT dial to select the effect to be allocated to each button from the list of 50 effects displayed (see page 23, "Presetting effects").

(Example): CH-1 side.

Effect list (ECHO)

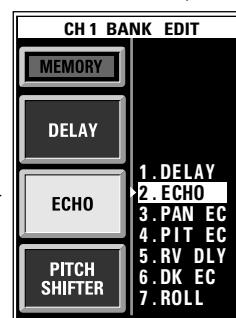

The button being edited (here, ECHO) appears highlighted.

C. Effect parameter adjust display

Press the FX ADJ. button to display the effect parameter adjust menu (settable independently for each channel). From this menu, BPM AUTO can be selected. Also, effect selection (cross fader / channel fader) can be selected for fader type.

Select frequency band for effect (HI, MID, LOW).

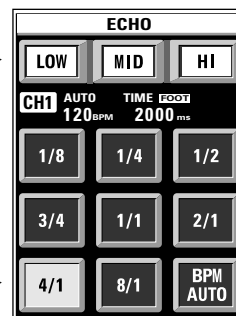

Select effect parameter (4/1).

Select method of BPM count (BPM AUTO).

D. Fader status display

Press the FADER CURVE/BANK EDIT button to view the fader status in a graphic display. By rotating the front panel FADER CURVE dial, the various attenuation responses can be set in 33 steps, and each step number also displayed. The amount of cross fader lag is also given a numerical display.

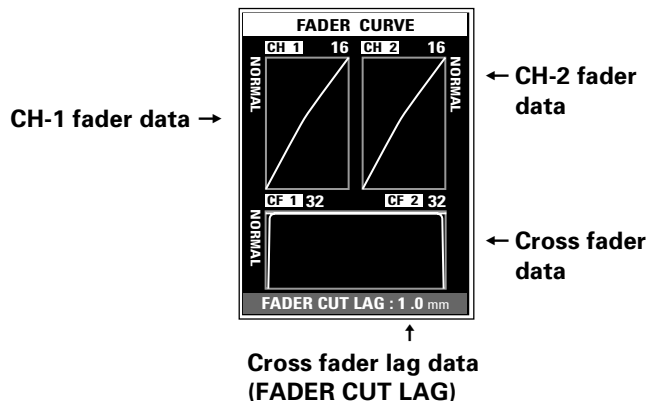

Touch Panel Display Selection

Changing between the touch panel's four basic display patterns (A, B, C, D) is performed by pressing the operating buttons at the panel's sides.

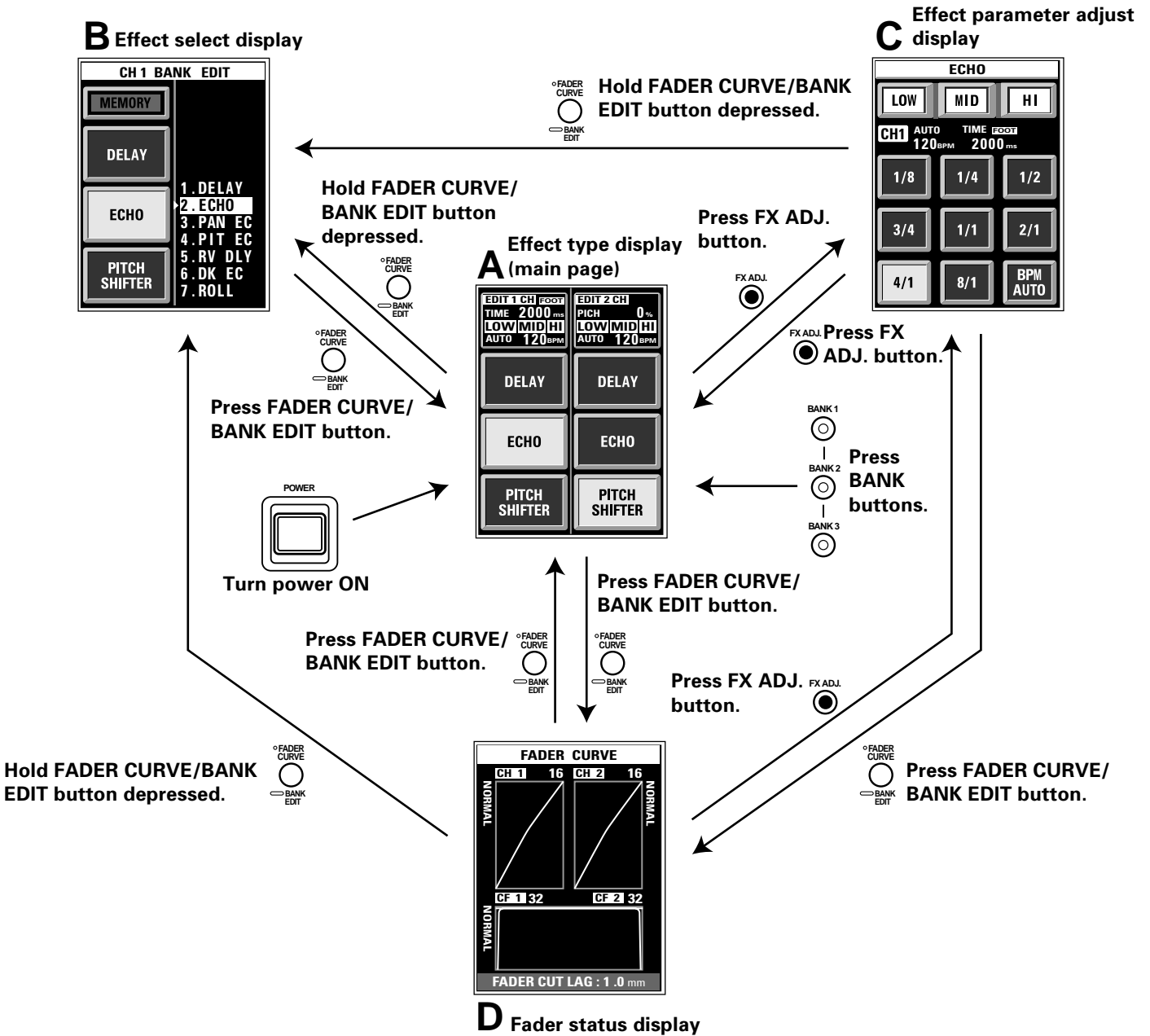

BPM COUNTING

Automatic Mode BPM Counting

This function automatically counts the track's speed in BPM (Beats Per Minute), displaying the results as a numerical value. The function does not merely count the bass beat, but uses a computer to calculate the track's original BPM required by the DJ. The display provides a visual standard in addition to the human ear, thus allowing the DJ to quickly match two tracks possessing differing speeds.

When auto mode is used to count BPM, the calculated BPM value is displayed on the LCD panel, allowing quick matching of tracks with differing speeds. (Counting range: 70.0 to 180.0 BPM)

The display flashes during BPM counting.

* Some tracks may not be counted properly, in which case manual count should be used.

(See page 11, top panel items 44, 51)

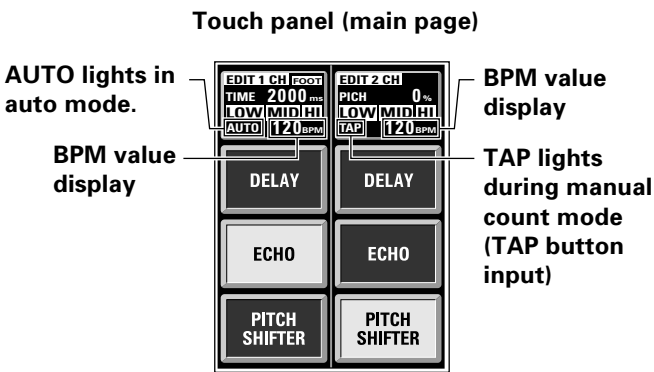

- The BPM value can be input directly by rotating the TIME/SELECT dial while holding the TAP button depressed.

■ Selecting Auto Mode

1. Press the FX ADJ. button to cause the touch panel screen to display the effect parameter adjust menu.

If the CH-1 FX ADJ. button is pressed, the CH-1 display appears; if the CH-2 FX ADJ. button is pressed, the CH-2 display appears.

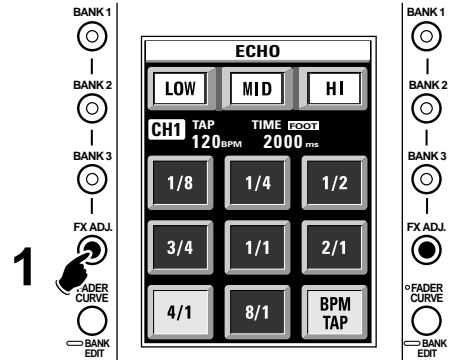

2. Press the BPM TAP button (displayed in manual mode), to display the BPM AUTO button.

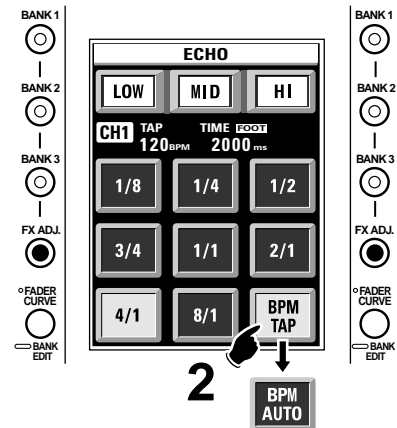

FADER OPERATIONS

Adjusting Fader Lever Operating Sensation Operating load adjust screw (FEELING ADJ.)

The supplied hexagonal Allen driver can be used to adjust the hexagonal Allen screw located next to the top panel's cross fader slider opening, thus modifying the sliding resistance of the lever. Rotate the screw clockwise to increase sliding resistance and counterclockwise to reduce resistance.

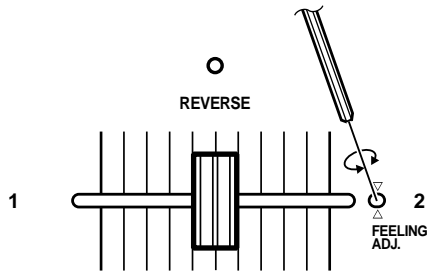

Cross fader lag adjustment

The mechanical play (the lag or range of movement in which no functional effect takes place) at the two extreme ends of the top panel cross fader lever movement can be adjusted by using the front panel's FADER CUT LAG dial, within a range of 1-6 mm.

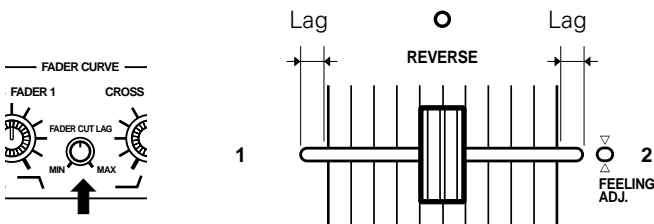

Fader attenuation curve adjustment

The front panel's FADER CURVE dials can be used to adjust the attenuation curve response of the cross fader and channel fader. The cross fader can be adjusted independently for CH-1 and CH-2 sides. By pressing the top panel's FADER CURVE/BANK EDIT button, the adjustment status can be displayed on the touch panel.

■ Channel fader curve adjustment (CH-1, CH-2)

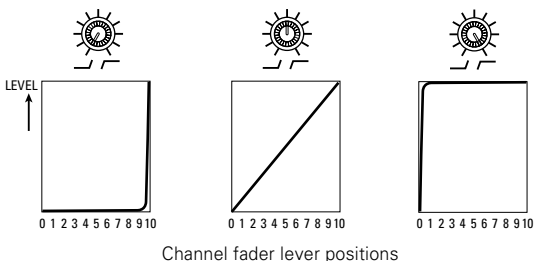

■ Cross fader curve adjustment (CROSS FADER 1, 2)

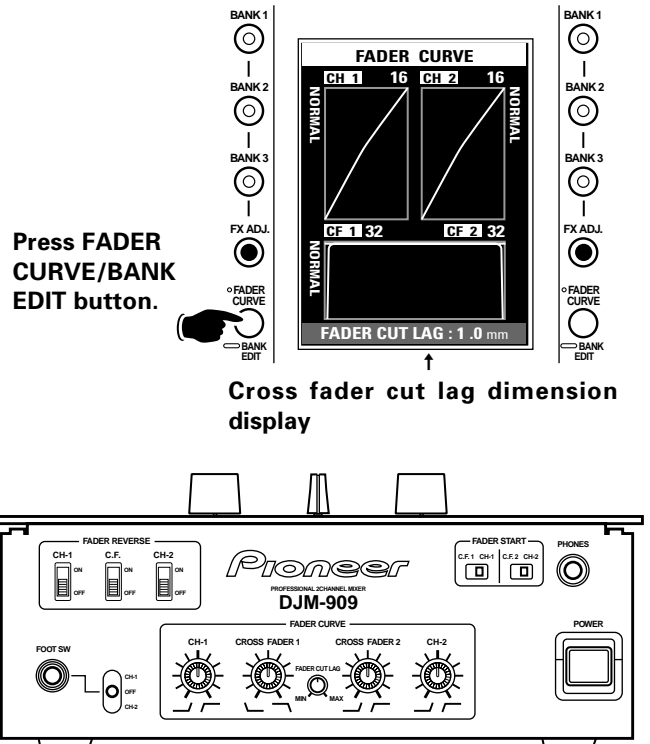
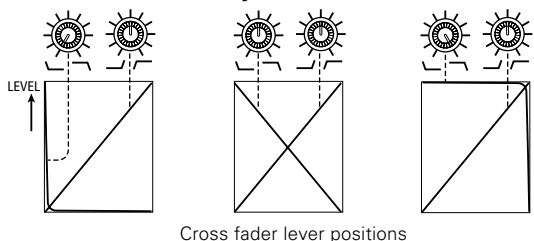

Fader reverse function

The operating directions of the CH-1, CH-2 and cross fader levers can be reversed by setting the front panel's FADER REVERSE switches to their [ON] positions.

When the CH-1 (or CH-2) FADER REVERSE switch is set to [ON], the top panel CH-1 (or CH-2) REVERSE indicator lights, and the corresponding lever's operating direction is reversed (scale mark "0" becomes attenuation 0 dB, while scale mark "10" becomes minus infinity). The fader start function also operates in reverse.

When the C.F. FADER REVERSE switch is set to [ON], the top panel's cross fader REVERSE indicator lights, and the lever operating direction is reversed (left side becomes CH-2 and right side becomes CH-1). The fader start function also operates in reverse.

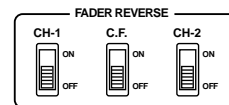

Fader Start Function

When the CH-1 and CH-2 jacks of this unit are connected to a separately sold Pioneer DJ CD player (models CDJ-1000, CDJ-1000MK2, CDJ-800, CDJ-100S, CDJ-700S, CDJ-500II, CMX-3000, CMX-5000 or DMP-555), the channel fader and cross fader functions can be used to automatically start playback of the connected CD player (the applicable control cord must be connected). By moving the mixer's channel fader or cross fader lever, the CD player's pause function is released and play starts instantly. Also, by returning the fader lever to its original position, the CD player can be returned to its cue point (back cue function), thus allowing sampling playback.

FADER OPERATIONS

Cross fader start play and back cue play

When the CH-1 CD player is held in standby at the cue point, merely moving the cross fader lever from the right (CH-2) side to the left (CH-1) side will cause the CH-1 CD player to begin playback.

When the cross fader lever reaches the left (CH-1) side, CH-2 CD player performs back cue (returns to its cue point).

Likewise, when the CH-2 CD player is in standby at its cue point, moving the cross fader lever from the left (CH-1) side to the right (CH-2) side causes CH-2 CD player to begin playback. When the cross fader lever reaches the right (CH-2) side, CH-1 CD player performs back cue.

* Back cue is performed even if the input selector switch is not set to CD.

Start playback with channel fader

- To control a connected CD player, set the front panel FADER START selector switch for the corresponding channel to its [CH-1] or [CH-2] position.**

When using the CH-1 fader lever to start the CH-1 CD player, set the front panel C.F. 1/CH-1 switch to the [CH-1] position; when using the CH-2 fader lever to start the CH-2 CD player, set the front panel C.F.2/CH-2 switch to [CH-2] position.

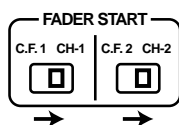

- Press the top panel FADER START button so that the indicator lights.**

When the CH-1 FADER START button is pressed, the CH-1 FADER START indicator lights.

When the CH-2 FADER START button is pressed, the CH-2 FADER START indicator lights.

- Set the channel fader lever to the [0] scale mark.**
- Adjust the CD player to its cue point and set for cue point standby.**
- Begin moving the channel fader lever with the timing you wish, thereby beginning playback on the CD player.**

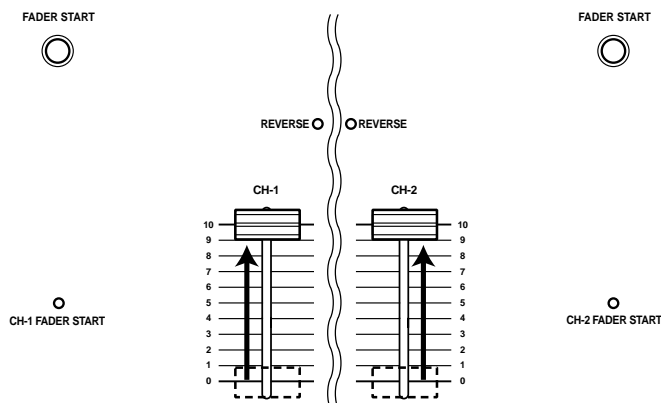

- If the cue point has already been set, there is no need to set the CD player again for standby at the cue point.
- After playback has once begun, moving the channel fader lever back to the "0" scale mark will cause the CD player to return to its cue point and enter the standby mode again (back cue).

Start playback with cross fader

- To control a connected CD player, set the front panel FADER START selector switch for the corresponding channel to its [C.F.1] or [C.F.2] position.**

When using cross fader lever to start the CH-1 CD player, set the front panel C.F.1/CH-1 switch to the [C.F.1] position; when using the cross fader lever to start the CH-2 CD player, set the front panel C.F.2/CH-2 switch to [C.F.2] position.

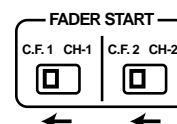

- Press the top panel FADER START button so that the indicator lights.**

When the CH-1 FADER START button is pressed, the C.F.1 FADER START indicator lights.

When the CH-2 FADER START button is pressed, the C.F.2 FADER START indicator lights.

- Move the cross fader lever to the side opposite from the channel you wish to start.**
- Adjust the CD player to its cue point and set for cue point standby.**
- Begin moving the cross fader lever with the timing you wish, thereby beginning playback on the CD player.**

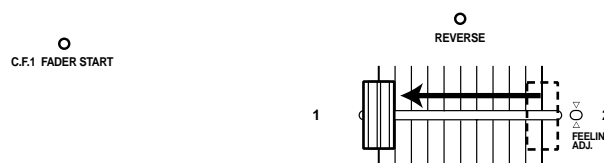
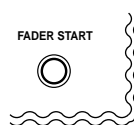

- If the cue point has already been set, there is no need to set the CD player again for standby at the cue point.
- If the cross fader lever is moved fully after the beginning of playback, the opposite channel's CD player will return to its cue point and enter standby there (back cue).

EFFECT FUNCTIONS

Types of Effects

This unit is equipped with a beat effector linked to the BPM, and fader effector linked to the channel or cross fader, producing a total of 50 basic effects, but an even wider variety of effects can be produced by varying the parameters of each effect.

Beat Effector (effects linked to BPM)

Name	Function	FX ADJ. Parameter (touch panel)
1 DELAY (*1)	In time with BPM, outputs repeat sound once.	Set delay time of 1/8 to 8/1 of each beat of BPM.
2 ECHO (*1)	In time with BPM, outputs repeat sound several times, while diminishing.	Set delay time of 1/8 to 8/1 of each beat of BPM.
3 PAN ECHO (*1)	In time with BPM, outputs repeat sound, alternately to left and right.	Set delay time of 1/8 to 8/1 of each beat of BPM.
4 PITCH ECHO (*1)	In time with BPM, outputs repeat sound while changing pitch.	Set delay time of 1/8 to 2/1 of each beat of BPM; and set pitch shifter up or down.
5 REVERSE DELAY (*1)	In time with BPM, outputs repeat sound in reverse of playback direction.	Set delay time of 1/8 to 8/1 of each beat of BPM.
6 DUCKING ECHO (*1)	Outputs repeat sound when input sound level drops below a certain point.	Set delay time of 1/8 to 8/1 of each beat of BPM.
7 ROLL (*2)	With the turning ON of the EFFECT switch as a trigger, the input sound is recorded, and the recorded sound is repeated in units of individual beat.	Set effect time of 1/8 to 8/1 of each beat of BPM.
8 HOLD ECHO (*1) (*2)	In time with BPM, outputs repeat sound several times while diminishing. Repeat sound is preserved even if EFFECT switch is turned OFF.	Set delay time of 1/8 to 8/1 of each beat of BPM.
9 MULTI TAP DELAY (*1)	Output delay sound in time with beat, at intervals of preset delay time.	Set delay time of 1/4 to 1/1 of each beat of BPM; select delay pattern; and set feedback ON/OFF.
10 RAIN (*1)	Outputs sound with feeling of being in water.	Set delay time of 1/8 to 8/1 of each beat of BPM.
11 REVERB1 (*1)	Produces reverberation sound similar to that of a garage-sized room.	8 patterns can be set based on different filters.
12 REVERB2 (*1)	Produces reverberation sound similar to that of a large hall.	8 patterns can be set based on different filters.
13 REVERB3 (*1)	Hall reverberation (echo) is added to sound lag timed to BPM.	Set delay time of 1/8 to 4/1 of each beat of BPM.
14 PITCH SHIFTER1	Allows changing of pitch within range of ± 1 octave.	Set amount of pitch shift.
15 PITCH SHIFTER2	Outputs three types of pitches together with preset pitches.	Set type of changing pitch harmonies.
16 PAN	In time with BPM, outputs sound alternately to left and right.	Set right-left allocation time in units of 1/8 to 8/1 of each beat of BPM.
17 TRANS	In time with BPM, cut sound.	Set cut time in units of 1/8 to 8/1 of each beat of BPM.
18 RHYTHM TRANS	Cut sound in time with BPM and preset pattern.	Set effect time of 1/2 to 2/1 of each beat of BPM; and select cut pattern.
19 TRANS PAN	In time with BPM, cut long-period PAN outputs at set time.	Set cut time in units of 1/16 to 1/1 of each beat of BPM; and set PAN period.
20 TREMOLO	Produces wavering sound by applying tonal modulation.	Set modulation period based on beats calculated from BPM.
21 VIBRATO	Apply modulation to frequency, thus producing tonal variation.	Set modulation period based on beats calculated from BPM.

(*1) When the channel fader or cross fader is used to lowering sound volume, no effect sounds will be heard, even if monitor SELECT switch is set to the [EFFECT] position.

(*2) When EFFECT switch is turned OFF, no effect sounds will be heard even if the monitor SELECT switch is set to the [EFFECT] position.

EFFECT FUNCTIONS

Name	Function	FX ADJ. Parameter (touch panel)
22 CHORUS1	Produces broadened musical effect resembling the production of same pitch sounds from multiple sources.	Set period of chorus wavers based on beats calculated from BPM.
23 CHORUS2	Produces even broader musical effect than CHORUS1.	Set period of chorus wavers based on beats calculated from BPM.
24 CHORUS3	Changes degree of waver in chorus sound.	Set period of chorus waver based on beats calculated from BPM, and set degree of chorus sound waver.
25 FLANGER1	Produce flange effect by adding delayed sound. In time with BPM, change frequency band receiving flange effect.	Set period of flange effect shift based on beats calculated from BPM.
26 FLANGER2	In time with BPM, change frequency band receiving flange effect, thus producing either undulating or rotating effect.	Set period of flange effect shift based on beats calculated from BPM.
27 PHASER1	Phase effect is produced by adding sound with delayed phase. The phase-affected frequency band changes in time with BPM.	Set period of phase effect shift based on beats calculated from BPM.
28 PHASER2	Phase-affected frequency band changes in time with BPM. Phase effect change is inverted between L and R.	Set period of phase effect shift based on beats calculated from BPM.
29 TOUCH PHASER	Phase effect is produced in correspondence to input volume. The higher the input volume, the higher the frequencies producing the effect.	Set the number of filter stages producing the phase effect. Greater numbers of stages produce deeper effects.
30 TOUCH PHASER2	Phase effect is produced in correspondence to input volume. The higher the input volume, the lower the frequencies producing the effect.	Set the number of filter stages producing the phase effect. Greater numbers of stages produce deeper effects.
31 FILTER (LPF)	Change low-pass filter's cutoff frequency in time with BPM.	Set period of cutoff frequency shift based on beats calculated from BPM.
32 FILTER (HPF)	Change high-pass filter's cutoff frequency in time with BPM.	Set period of cutoff frequency shift based on beats calculated from BPM.
33 FILTER (BPF)	Change band pass filter's center frequency in time with BPM.	Set period of center frequency shift based on beat calculated from BPM.
34 FILTER PAN	In time with BPM, bass and treble sounds pan in opposite directions.	Set period of cutoff frequency shift based on beats calculated from BPM.
35 COMPRESSOR	Inputs above the threshold level are compressed before output.	Set degree of compression.

Fader Effector (effects linked to channel or cross fader)

Name	Function	FX ADJ. Parameter (touch panel)
36 FADER ROLL (*2)	EFFECT switch turn ON or fader position is used as trigger to record input sound, and then output the sound repeatedly within range of 1/1 to 1/16 beat.	Select either channel fader or cross fader. Set base ROLL time to 1/2, 1/1, or 2/1.
37 FADER MULTI TAP DELAY (*1)	At preset intervals repeat sound is output at 1/1 to 1/16 beat set with fader.	Select either channel fader or cross fader. Set basic beat time of 1/2 to 2/1 for each BPM beat, and set delay pattern selection.
38 FADER TRANS PAN	In time with the BPM, long-period PAN output is cut at time corresponding to fader position.	Select either channel fader or cross fader. Set PAN operation period and basic effect time to be cut with fader.
39 FADER PITCH SHIFTER	In response to fader position, pitch of input sounds is changed.	Select either channel fader or cross fader. Set type of pitch change.
40 FADER RING	Produces metallic bass sound effect.	Select either channel fader or cross fader. Set frequency of sound effect.
41 FADER VOCODER1	Vocoder effect; modulates internal oscillator sound in response to input sound. Depending on fader position, changes internal oscillator sound's fundamental frequency. 7 code sounds can be added.	Select either channel fader or cross fader. Set code type.
42 FADER VOCODER2		
43 FADER FILTER (LPF)	Changes low-pass filter's cutoff frequency, depending on fader position.	Select either channel fader or cross fader.
44 FADER FILTER (HPF)	Changes high-pass filter's cutoff frequency, depending on fader position.	Select either channel fader or cross fader.
45 FADER FILTER (BPF)	Changes band-pass filter's center frequency depending on fader position.	Select either channel fader or cross fader.
46 FADER FLANGER	Changes frequency band subjected to flanger effect, depending on fader position.	Select either channel fader or cross fader.
47 FADER PHASER	Changes frequency band subjected to phaser effect, depending on fader position.	Select either channel fader or cross fader. Set number of filter stages producing phase effect. Greater numbers of stages produce deeper effects.
48 FADER SYNTH1	Outputs sine wave sound source.	Select either channel fader or cross fader. Select frequency equivalent to note "DO".
49 FADER SYNTH2	Outputs sawtooth wave sound source.	Select either channel fader or cross fader. Select frequency equivalent to note "DO".
50 FADER SYNTH3	Outputs square wave sound source.	Select either channel fader or cross fader. Select frequency equivalent to note "DO".

(*1) When the channel fader or cross fader is used to lowering sound volume, no effect sounds will be heard, even if monitor SELECT switch is set to the [EFFECT] position.

(*2) When EFFECT switch is turned OFF, no effect sounds will be heard even if the monitor SELECT switch is set to the [EFFECT] position.

Using the Effect Functions

The basic procedure is as follows: [Select effect type] → [Set parameters (while monitoring through headphones)] → [Set EFFECT switch to ON].

Below are examples of this basic operation procedure; other effects are produced in much the same way:

[Example 1] Apply delay to CH-1 track:

1. Touch the touch panel's CH-1 (left side) DELAY button (select effect type).

- If the DELAY button is not displayed, select and display the button as follows:

- ① Hold the CH-1 (left side) FADER CURVE/BANK EDIT button depressed for about 1 second to set the touch panel to the effect select menu.
- ② Of the touch panel's three buttons, select (touch) the one in which you wish to record the DELAY.
- ③ Rotate the TIME/SELECT dial to select DELAY.
- ④ Press (touch) the MEMORY button.
- ⑤ Press the FADER CURVE/BANK EDIT button to leave the effect select menu.

- If DELAY is preset in the BANK 1, 2, or 3 buttons, DELAY can be selected by pressing the corresponding button (see page 23 "Presetting Effects.")

2. Press the CH-1 (left side) FX ADJ. button to display the effect parameter adjust menu on the touch panel.

3. Use the touch panel's LOW, MID, and HI buttons to select the frequency ranges for the effect.

- The selected range button will appear highlighted.
- * It may not be possible to select the frequency range, depending on the type of effect.

4. Press the touch panel's 1/8 to 8/1 buttons as desired to select the delay time (parameter value setting).

- Set delay time of 1/8 to 8/1 for each beat of BPM.
- Set monitor SELECT switch to [EFFECT] to confirm the effect sound through the headphones (effects marked with the note *1 on the effects chart cannot be heard unless the EFFECT switch is set to [ON]).
- The TIME/SELECT dial can be rotated to produce even finer delay time settings. Setting delay time of 1/2 per beat of tempo (BPM) will cause the touch panel's 1/2 button to be highlighted, and this can be used as a general reference when adjusting the parameter.

5. Use the MIX/DEPTH dial to set the level balance between sound source and delay sound.

- Rotate to left to reduce, and rotate to right to increase the delay sound.

6. Set EFFECT switch to [ON] or [LOCK ON].

- The EFFECT indicator will begin flashing red, and the effect (delay) will be applied to the master output.
- When the EFFECT switch is set to [ON] by pulling the switch forward, the switch will automatically return to [OFF] when released.

Note:

- Select effects only when the EFFECT switch is in the [OFF] position. If effects are selected when the EFFECT switch is in the [LOCK ON] position, noise may be produced.

[Example 2] Apply fader roll to CH-1 track

1. Touch the touch panel's CH-1 (left side) FADER ROLL button (select effect type).

- If the FADER ROLL button is not displayed, select and display the button as follows:

- ① Hold the CH-1 (left side) FADER CURVE/BANK EDIT button depressed for about 1 second to set the touch panel to the effect select menu.
- ② Of the touch panel's three buttons, select (touch) the one in which you wish to record the FADER ROLL.
- ③ Rotate the TIME/SELECT dial to select FADER ROLL.
- ④ Press (touch) the MEMORY button.
- ⑤ Press the FADER CURVE/BANK EDIT button to leave the effect select menu.

- If FADER ROLL is preset in the BANK 1, 2, or 3 buttons, FADER ROLL can be selected by pressing the corresponding button (see page 23 "Presetting Effects.")

2. Press the CH-1 (left side) FX ADJ. button to display the effect parameter adjust menu on the touch panel.

3. Use the touch panel's LOW, MID, and HI buttons to select the frequency ranges for the effect.

- The selected range button will appear highlighted.
- * It may not be possible to select the frequency range, depending on the type of effect.

4. Press the touch panel's 1/2, 1/1, and 2/1 buttons as desired to select the roll time (parameter value setting).

- Standard roll times can be set as 1/2, 1/1, or 2/1.
- Set monitor SELECT switch to [EFFECT] to confirm the effect sound through the headphones (effects marked with the note *1 on the effects chart cannot be heard unless the EFFECT switch is set to [ON]).
- The TIME/SELECT dial can be rotated to produce even finer roll time settings. Setting roll time to 1/1 per beat of tempo (BPM) will cause the touch panel's 1/1 button to be highlighted, and this can be used as a general reference when adjusting the parameter.

5. Use the MIX/DEPTH dial to set the roll sound level.

- Rotate to left to reduce, and rotate to right to increase the roll sound.

6. Use touch panel's CROSS FADER button to select fader.

- The fader used for fader effects can be set to either channel fader or cross fader.

7. Set EFFECT switch to [ON] or [LOCK ON].

- The EFFECT indicator will begin flashing red, and the effect will be applied to the master output.
- When the EFFECT switch is set to [ON] by pulling the switch forward, the switch will automatically return to [OFF] when released.

Note:

- Make selection of effects and type of fader (channel or cross) only when the EFFECT switch is in the [OFF] position. If effects are selected when the EFFECT switch is in the [LOCK ON] position, noise may be produced.

Presetting Effects

Of the effects displayed on the touch panel's main page (effect type menu), three types can be set for each channel CH-1 and CH-2 in the BANK buttons (1/2/3). The preset effects can then be called up at a single touch.

1. Select the channel (CH-1/CH-2) whose preset value you wish to change.

- Press and hold depressed for about one second the FADER CURVE/BANK EDIT button corresponding to the channel (CH-1/CH-2) in which you wish to change the effect setting. The touch panel will change to show the effect selection menu for the chosen channel.

2. Change the effect

- ① Press the BANK button (1/2/3) whose setting you wish to change.
 - ② Of the three touch panel buttons, press (touch) the one in which you wish to record a new effect.
 - ③ Rotate the TIME/SELECT dial to select effect.
 - ④ Press (touch) the touch panel's MEMORY button.
- If a different BANK button is pressed or EFFECT switch operated without first pressing the MEMORY button, no effect will be recorded.

- Up to three effects can be recorded in a single BANK button. Repeat steps ②–④ to record the presets.

3. Leave the effect selection (BANK EDIT) menu

- Press the FADER CURVE/BANK EDIT button to leave the effect selection menu.

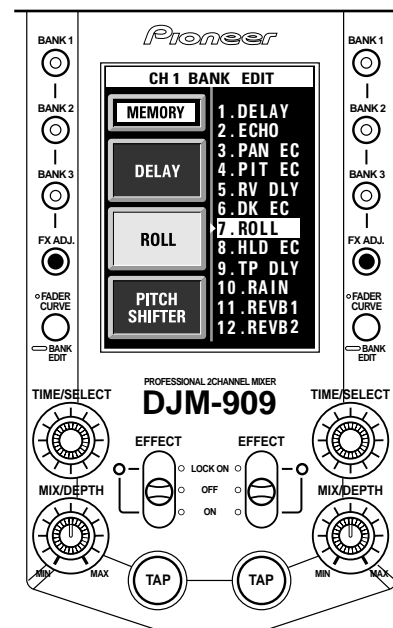
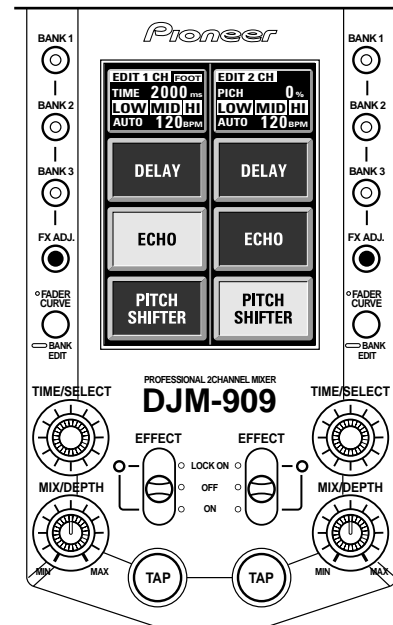

EFFECT FUNCTIONS

Effect Parameters

The 50 built-in effects can be modified by parameters for time and amount to produce a wider variety of effects. Operate the TIME/SELECT dial to adjust time parameters (parameter 1), and use the MIX/DEPTH dial to adjust amount parameters (parameter 2). Also with fader effects, the position of the fader lever can be used to produce changes resulting in an even wider range of effects.

■ Beat effects

No.	Name	Parameter 1 (TIME/SELECT dial)		Parameter 2 (MIX/DEPTH dial)
		Explanation	Setting range (unit)	Explanation
1	DELAY (*1)	Set delay time.	1 – 10000 (msec)	Set balance between source and delay sounds.
2	ECHO (*1)	Set delay time.	1 – 10000 (msec)	Set balance between source and echo sounds.
3	PAN ECHO (*1)	Set delay time.	1 – 10000 (msec)	Set balance between source and echo sounds.
4	PITCH ECHO (*1)	Set delay time.	40 – 10000 (msec)	Set balance between source and echo sounds.
5	REVERSE DELAY (*1)	Set delay time.	10 – 10000 (msec)	Set balance between source and delay sounds.
6	DUCKING ECHO (*1)	Set delay time.	1 – 10000 (msec)	Set balance between source and echo sounds. No effect sounds will be heard if the input sounds are above a certain level even when the dial is rotated fully to the right.
7	ROLL (*2)	Set effect time.	10 – 10000 (msec)	Set balance between source and ROLL sounds.
8	HOLD ECHO (*1) (*2)	Set delay time.	2 – 10000 (msec)	Set balance between source and echo sounds.
9	MULTI TAP DELAY (*1)	Set effect time.	8 – 1200 (msec)	Set balance between source and delay sounds.
10	RAIN (*1)	Set effect time.	40 – 10000 (msec)	Rotate to right to increase effect.
11	REVERB1 (*1)	Reverberation time	10 – 200 (%)	Change amount of reverberation.
12	REVERB2 (*1)	Reverberation time	10 – 200 (%)	Change amount of reverberation.
13	REVERB3 (*1)	Delay time	10 – 5000 (msec)	Change volume of echo sound + reverb sound.
14	PITCH SHIFTER1	Set pitch to be changed.	-100 to +100 (%)	Set balance between source and pitch-shifted sounds.
15	PITCH SHIFTER2	Set type of harmonization.	1 – 5	Set balance between source and pitch-shifted sounds.
16	PAN	Set effect time.	10 – 16000 (msec)	Set balance between source and effect sounds.
17	TRANS	Set effect time.	10 – 16000 (msec)	Set balance between source and effect sounds.
18	RHYTHM TRANS	Set effect time.	10 – 8000 (msec)	Set balance between source and effect sounds.
19	TRANS PAN	Set effect time.	10 – 2000 (msec)	Set balance between source and effect sounds.
20	TREMOLO	Fine setting of modulation period.	10 – 16000 (msec)	Change the sound volume waver.
21	VIBRATO	Fine setting of modulation period.	1 – 16000 (msec)	Change the frequency waver.
22	CHORUS1	Set period of chorus modulation.	10 – 32000 (msec)	Change the chorus sound volume.
23	CHORUS2	Set period of chorus modulation.	10 – 32000 (msec)	Change the chorus sound volume.
24	CHORUS3	Set period of chorus modulation.	10 – 32000 (msec)	Change the chorus sound volume.
25	FLANGER1	Set period of flange effect frequency shift.	10 – 32000 (msec)	Rotate to right for stronger effect.
26	FLANGER2	Set period of flange effect frequency shift.	10 – 32000 (msec)	Rotate to right for stronger effect.

No.	Name	Parameter 1 (TIME/SELECT dial)		Parameter 2 (MIX/DEPTH dial)
		Explanation	Setting range (unit)	Explanation
27	PHASER1	Set period of phase effect frequency shift.	10 – 32000 (msec)	Rotate to right for stronger effect.
28	PHASER2	Set period of phase effect frequency shift.	10 – 32000 (msec)	Rotate to right for stronger effect.
29	TOUCH PHASER1	Set sensitivity corresponding to input volume.	1 – 100 (%)	Rotate to right for stronger effect.
30	TOUCH PHASER2	Set sensitivity corresponding to input volume.	1 – 100 (%)	Rotate to right for stronger effect.
31	FILTER (LPF)	Set period of cutoff frequency shift.	10 – 32000 (msec)	Rotate to right for increased resonance and more unusual sound.
32	FILTER (HPF)	Set period of cutoff frequency shift.	10 – 32000 (msec)	Rotate to right for increased resonance and more unusual sound.
33	FILTER (BPF)	Set period of center frequency shift.	10 – 32000 (msec)	Rotate to right for increased resonance and more unusual sound.
34	FILTER PAN	Set period of cutoff frequency shift.	10 – 32000 (msec)	Rotate to right for increased resonance and more unusual sound.
35	COMPRESSOR	Set time until completely compressed. The time required to return to the original state is simultaneously set at the same value.	1 – 100 (msec)	Change threshold level. Rotate to right for stronger effect.

(*1) When the channel fader or cross fader is used to lowering sound volume, no effect sounds will be heard, even if monitor SELECT switch is set to the [EFFECT] position.

(*2) When EFFECT switch is turned OFF, no effect sounds will be heard even if the monitor SELECT switch is set to the [EFFECT] position.

■ Fader effects

No.	Name	Parameter 1 (TIME/SELECT dial)		Parameter 2 (MIX/DEPTH dial)	Fader lever
		Explanation	Setting range (unit)	Explanation	Explanation
36	FADER ROLL (*2)	Set reference ROLL time	40 – 10000 (msec)	Set balance between source and ROLL sounds.	Change roll time
37	FADER MULTI TAP DELAY (*1)	Set reference effect time	8 – 1200 (msec)	Set balance between source and delay sounds.	Change reference beat time.
38	FADER TRANS PAN	Set reference effect time.	40 – 2000 (msec)	Set balance between source and effect sounds.	Change cut time
39	FADER PITCH SHIFTER	Set type of pitch change.	1 – 3	Set balance between source and pitch-shifted sounds.	Change pitch of input sound.
40	FADER RING	Change fundamental frequency of effect sound.	500 – 8000 (Hz)	Change effect sound level.	Change frequency of effect sound
41	FADER VOCODER1	Set sensitivity corresponding to input volume	1 – 100 (%)	Adjust volume of code selected on panel menu.	Change fundamental frequency of oscillating sound.
42	FADER VOCODER2				
43	FADER FILTER (LPF)	—	—	Rotate to right for increased resonance and more unusual sound.	Changes cutoff frequency of low-pass filter.
44	FADER FILTER (HPF)	—	—	Rotate to right for increased resonance and more unusual sound.	Changes cutoff frequency of high-pass filter.
45	FADER FILTER (BPF)	—	—	Rotate to right for increased resonance and more unusual sound.	Changes band-pass filter's center frequency.

EFFECT FUNCTIONS

No.	Name	Parameter 1 (TIME/SELECT dial)		Parameter 2 (MIX/DEPTH dial)		Fader lever
		Explanation	Setting range (unit)	Explanation	Explanation	
46	FADER FLANGER	—	—	Rotate to right for increased effect.	Changes frequency band subject to flange effect.	
47	FADER PHASER	—	—	Rotate to right for increased effect.	Changes frequency band subject to phase effect.	
48	FADER SYNTH1	Base frequency	40 – 23999 (Hz)	Left half changes volume, right half changes volume of the set frequency.	Changes to stair-stepped sound.	
49	FADER SYNTH2	Base frequency	40 – 23899 (Hz)	Left half changes volume, right half changes volume of neighboring frequency.	Changes to stair-stepped sound.	
50	FADER SYNTH3	Base frequency	40 – 23899 (Hz)	Left half changes volume, right half changes volume of neighboring frequency.	Changes to stair-stepped sound.	

(*1) When the channel fader or cross fader is used to lowering sound volume, no effect sounds will be heard, even if monitor SELECT switch is set to the [EFFECT] position.

(*2) When EFFECT switch is turned OFF, no effect sounds will be heard even if the monitor SELECT switch is set to the [EFFECT] position.

BLOCK DIAGRAM

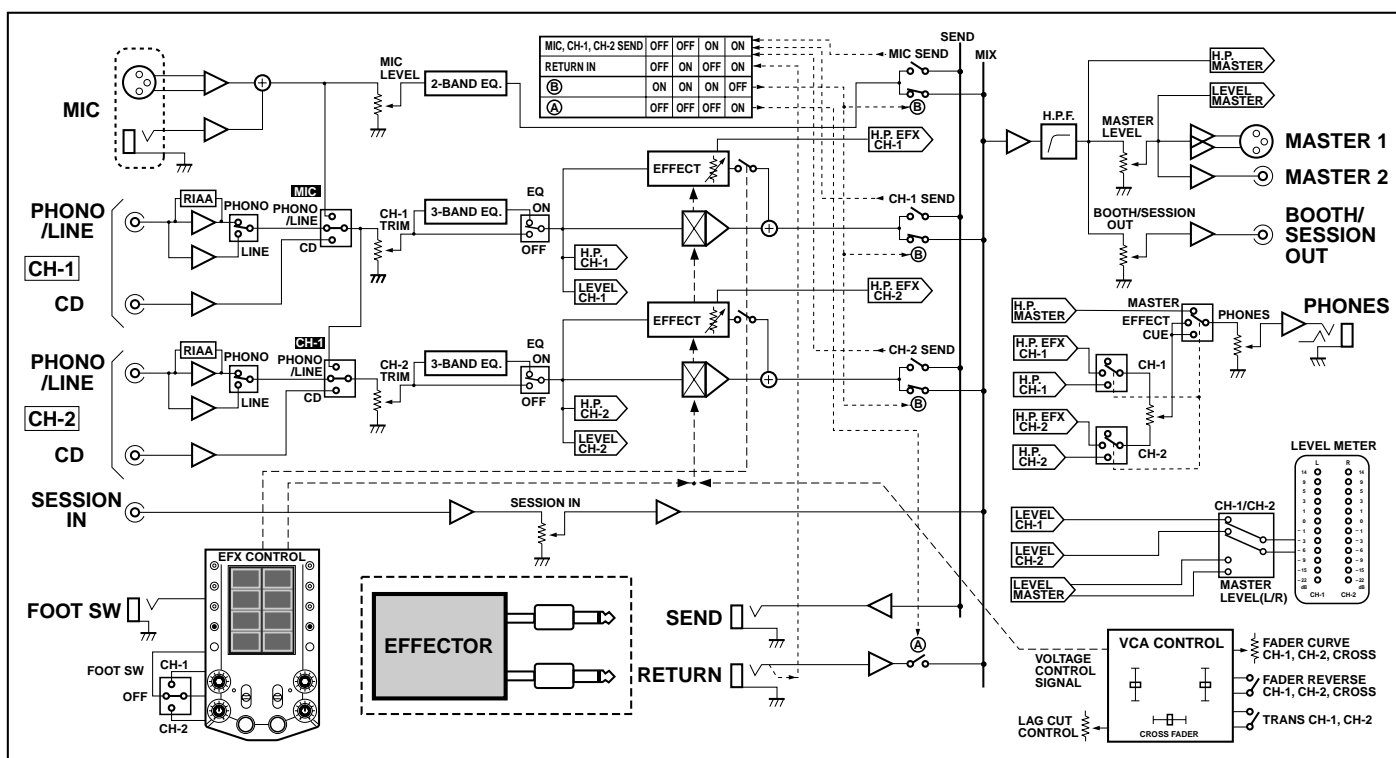

TROUBLESHOOTING

Incorrect operations are often mistaken for trouble and malfunctions. If you think there is something wrong with this component, check the points below. Sometimes the trouble may originate from another component. Thus, also check the other electrical appliances also in use.

If the trouble cannot be rectified even after checking the following items, contact your dealer or nearest PIONEER service center.

Problem	Possible Cause	Countermeasure
The power does not turn on.	<ul style="list-style-type: none"> The power cord has not been connected. 	<ul style="list-style-type: none"> Connect the cord to a power outlet.
There is little or no sound.	<ul style="list-style-type: none"> The Input selector switch is in the wrong position. The rear panel's PHONO/LINE selector switch is set to [LINE] when a analog turntable is connected to the input connectors. The connection cable hasn't been connected properly or has been disconnected. The terminal or plug is dirty. The TRANSFORM lever is tripped. 	<ul style="list-style-type: none"> Set the Input selector switch to the device currently playing. Set the PHONO/LINE selector switch to [PHONO]. Connect it properly. Clean and reconnect. Return the TRANSFORM lever to its upright position.
Sound is distorted.	<ul style="list-style-type: none"> Master output level is too high. Input level is too high. The rear panel's PHONO/LINE selector switch is set to [PHONO] when a cassette deck or other line component is connected to the input connectors. 	<ul style="list-style-type: none"> Adjust MASTER LEVEL dial. Adjust the TRIM dial so that the input level approaches 0 dB on the peak level meter. Set the PHONO/LINE selector switch to [LINE].
CD player's fader won't start.	<ul style="list-style-type: none"> The top panel's FADER START button is set to Off. The rear panel's PLAYER CONTROL jack hasn't been connected. 	<ul style="list-style-type: none"> Set the top panel's FADER START button to On. Use the control cord to connect the unit and CD player.
Effects don't work.	<ul style="list-style-type: none"> EFFECT switch is [OFF]. (If hand is released when switch is in [ON] position, it will return to [OFF].) The effect MIX/DEPTH dial is set to [MIN]. 	<ul style="list-style-type: none"> Either hold EFFECT switch at [ON] position, or set to [LOCK ON]. Adjust effect MIX/DEPTH dial properly.
External effector's sound distorted.	<ul style="list-style-type: none"> The input level from the external effector is too high. 	<ul style="list-style-type: none"> Lower the external effector's output level.
External effector don't work.	<ul style="list-style-type: none"> The top panel's SEND buttons (MIC SEND, CH-1 SEND, CH-2 SEND) are set to Off. An external effector's output coupler is not connected to the RETURN jacks. 	<ul style="list-style-type: none"> Turn on the top panel's SEND button corresponding to the channel you wish to apply external effects to (indicator will light). Connect an external effector's output coupler to the RETURN jacks.
BPM can't be measured, or value is strange.	<ul style="list-style-type: none"> Input level is too high or too low. BPM may not measure properly with some tracks. 	<ul style="list-style-type: none"> Adjust TRIM dial to set input level around 0 dB on the peak level meter. Set other channels so that input level is around 0 dB. Strike TAP switch to count BPM manually.
The counted BPM differs from the CD's published value.	<ul style="list-style-type: none"> Different counting methods are used, resulting in some variation in values. 	<ul style="list-style-type: none"> No response necessary.
Can't see touch panel display.	<ul style="list-style-type: none"> Improper contrast adjustment. Backlight is too dark. 	<ul style="list-style-type: none"> Adjust touch panel CONTRAST control on rear-panel. Adjust the rear panel's touch panel backlight control (BRIGHT).

Static electricity or other external interference may cause the unit to malfunction. To restore normal operation, turn the power off and then on again.

SPECIFICATIONS

Audio Section

Input terminal (input level/impedance)

CD 1, 2	-14 dBV (200 mV) / 22 k Ω
LINE 1, 2	-14 dBV (200 mV) / 22 k Ω
PHONO 1, 2	-54 dBV (2 mV) / 47 k Ω
MIC	-54 dBV (2 mV) / 3 k Ω
SESSION IN	-14 dBV (200 mV) / 22 k Ω
RETURN	-14 dBV (200 mV) / 22 k Ω

Output terminal (output level/impedance)

MASTER OUT 1 (XLR)	0 dBV (1 V) / 600 Ω
MASTER OUT 2 (RCA)	0 dBV (1 V) / 1 k Ω
BOOTH / SESSION OUT	0 dBV (1 V) / 1 k Ω
SEND	-14 dBV (200 mV) / 1 k Ω
PHONES	6 dBV (2 V) / 22 Ω or less (Rated load impedance 32 Ω)

Frequency characteristics

CD, LINE, MIC	20 Hz to 20 kHz
PHONO (RIAA)	20 Hz to 20 kHz

SN ratio

CD, LINE	93 dB or more (EFFECT OFF)
PHONO	78 dB or more
MIC	64 dB or more

Total harmonic distortion rate

CD, LINE	0.02% or less
----------------	---------------

Cross talk (1 kHz) 77 dB or more

Channel equalizer (CD, LINE/PHONO)

HI	+6 dB to -26 dB
MID	+6 dB to -26 dB
LOW	+6 dB to -26 dB

Microphone equalizer (MIC)

HI	+12 dB to -12 dB
LOW	+12 dB to -12 dB

Electrical Section, etc.

Power supply voltage	AC 120 V, 60 Hz
Power consumption	31 W
Operating temperature	+5 °C to +35 °C (41 °F to 95 °F)
Operating humidity	5% to 85%
External dimensions	251 (W) x 381.6 (D) x 107.9 (H) mm 9-7/8 (W) x 15 (D) x 4-1/4 (H) in
Weight	6.5 kg 14 lbs 5 oz

Accessories

- Hexagonal Allen driver 1
- These operating instructions 1
- Warranty 1

For improvement purposes, specifications and design may be subject to modification without notice.

Should this product require service in the U.S.A. and you wish to locate the nearest Pioneer Authorized Independent Service Company, or if you wish to purchase replacement parts, operating instructions, service manuals, or accessories, please call the number shown below.

800 - 782 - 7210

Please do not ship your product to Pioneer without first calling the Customer Support Division at the above listed number for assistance.

**PIONEER ELECTRONICS (USA), INC.
CUSTOMER SUPPORT DIVISION
P.O. BOX 1760, LONG BEACH,
CA 90801-1760, U.S.A.**

For warranty information please see the Limited Warranty sheet included with your product.

Should this product require service in Canada, please contact a Pioneer Canadian Authorized Dealer to locate the nearest Pioneer Authorized Service Company in Canada.

Alternatively, please contact the Customer Service Department at the following address:

Pioneer Electronics of Canada, Inc.

**300 Allstate Parkway
Markham, ON L3R 0P2
(905) 479-4411
1 (877) 283-5901**

For warranty information please see the Limited Warranty sheet included with your product.

Published by Pioneer Corporation.
Copyright © 2003 Pioneer Corporation.
All rights reserved.

PIONEER CORPORATION 4-1, Meguro 1-Chome, Meguro-ku, Tokyo 153-8654, Japan

PIONEER ELECTRONICS (USA) INC.

Multimedia and Mass Storage Division: 2265 East 220th Street, Long Beach, CA 90810, U.S.A. TEL: 800-444-OPTI (6784)

PIONEER ELECTRONICS OF CANADA, INC.

Industrial Products Department: 300 Allstate Parkway, Markham, Ontario L3R 0P2, Canada TEL: 905-479-4411

Free Manuals Download Website

<http://myh66.com>

<http://usermanuals.us>

<http://www.somanuals.com>

<http://www.4manuals.cc>

<http://www.manual-lib.com>

<http://www.404manual.com>

<http://www.luxmanual.com>

<http://aubethermostatmanual.com>

Golf course search by state

<http://golfingnear.com>

Email search by domain

<http://emailbydomain.com>

Auto manuals search

<http://auto.somanuals.com>

TV manuals search

<http://tv.somanuals.com>