

Pioneer

MULTI ENTERTAINMENT PLAYER
MEP-7000



<http://www.prodjnet.com/support/>

The Pioneer website listed above provides answers to frequently asked questions, information about software, and other up-to-date data of assistance to our customers.

Operating Instructions

Thank you for buying this Pioneer product.

Please read through these operating instructions so you will know how to operate your model properly. After you have finished reading the instructions, put them away in a safe place for future reference.

In some countries or regions, the shape of the power plug and power outlet may sometimes differ from that shown in the explanatory drawings. However the method of connecting and operating the unit is the same.

K015 En

IMPORTANT



The lightning flash with arrowhead symbol, within an equilateral triangle, is intended to alert the user to the presence of uninsulated "dangerous voltage" within the product's enclosure that may be of sufficient magnitude to constitute a risk of electric shock to persons.

CAUTION

**RISK OF ELECTRIC SHOCK
DO NOT OPEN**



The exclamation point within an equilateral triangle is intended to alert the user to the presence of important operating and maintenance (servicing) instructions in the literature accompanying the appliance.

CAUTION:
TO PREVENT THE RISK OF ELECTRIC SHOCK, DO NOT REMOVE COVER (OR BACK). NO USER-SERVICEABLE PARTS INSIDE. REFER SERVICING TO QUALIFIED SERVICE PERSONNEL.

D1-4-2-3_En-A

WARNING

This equipment is not waterproof. To prevent a fire or shock hazard, do not place any container filled with liquid near this equipment (such as a vase or flower pot) or expose it to dripping, splashing, rain or moisture.

D3-4-2-1-3_A_En

IMPORTANT NOTICE— THE SERIAL NUMBER FOR THIS EQUIPMENT IS LOCATED IN THE REAR. PLEASE WRITE THIS SERIAL NUMBER ON YOUR ENCLOSED WARRANTY CARD AND KEEP IN A SECURE AREA. THIS IS FOR YOUR SECURITY.

D1-4-2-6-1_En

IMPORTANT SAFETY INSTRUCTIONS

- 1) Read these instructions.
- 2) Keep these instructions.
- 3) Heed all warnings.
- 4) Follow all instructions.
- 5) Do not use this apparatus near water.
- 6) Clean only with dry cloth.
- 7) Do not block any ventilation openings. Install in accordance with the manufacturer's instructions.
- 8) Do not install near any heat sources such as radiators, heat registers, stoves, or other apparatus (including amplifiers) that produce heat.
- 9) Do not defeat the safety purpose of the polarized or grounding-type plug. A polarized plug has two blades with one wider than the other. A grounding type plug has two blades and a third grounding prong. The wide blade or the third prong are provided for your safety. If the provided plug does not fit into your outlet, consult an electrician for replacement of the obsolete outlet.
- 10) Protect the power cord from being walked on or pinched particularly at plugs, convenience receptacles, and the point where they exit from the apparatus.
- 11) Only use attachments/accessories specified by the manufacturer.
- 12) Use only with the cart, stand, tripod, bracket, or table specified by the manufacturer, or sold with the apparatus. When a cart is used, use caution when moving the cart/apparatus combination to avoid injury from tip-over.
- 13) Unplug this apparatus during lightning storms or when unused for long periods of time.
- 14) Refer all servicing to qualified service personnel. Servicing is required when the apparatus has been damaged in any way, such as power-supply cord or plug is damaged, liquid has been spilled or objects have fallen into the apparatus, the apparatus has been exposed to rain or moisture, does not operate normally, or has been dropped.



P1-4-2-2_En

Information to User

Alteration or modifications carried out without appropriate authorization may invalidate the user's right to operate the equipment.

D8-10-2_En

CAUTION: This product satisfies FCC regulations when shielded cables and connectors are used to connect the unit to other equipment. To prevent electromagnetic interference with electric appliances such as radios and televisions, use shielded cables and connectors for connections.

D8-10-3a_En

This Class B digital apparatus complies with Canadian ICES-003.

Cet appareil numérique de la Classe B est conforme à la norme NMB-003 du Canada.

D8-10-1-3_EF

CAUTION – PREVENT ELECTRIC SHOCK DO NOT USE THIS (POLARIZED) PLUG WITH AN EXTENSION CORD, RECEPTACLE OR OTHER OUTLET UNLESS THE BLADES CAN BE FULLY INSERTED TO PREVENT BLADE EXPOSURE.

ATTENTION – POUR PREVENIR LES CHOCS ELECTRIQUES NE PAS UTILISER CETTE FICHE POLARISEE AVEC UN PROLONGATEUR UNE PRISE DE COURANT OU UNE AUTRE SORTIE DE COURANT, SAUF SI LES LAMES PEUVENT ETRE INSEREES A FOND SANS EN LAISSER AUCUNE PARTIE A DECOUVRETT.

D2-4-4-1_EF

WARNING: Handling the cord on this product or cords associated with accessories sold with the product will expose you to chemicals listed on proposition 65 known to the State of California and other governmental entities to cause cancer and birth defect or other reproductive harm.

Wash hands after handling

D36-P4_A_En

NOTE: This equipment has been tested and found to comply with the limits for a Class B digital device, pursuant to Part 15 of the FCC Rules. These limits are designed to provide reasonable protection against harmful interference in a residential installation. This equipment generates, uses, and can radiate radio frequency energy and, if not installed and used in accordance with the instructions, may cause harmful interference to radio communications. However, there is no guarantee that interference will not occur in a particular installation. If this equipment does cause harmful interference to radio or television reception, which can be determined by turning the equipment off and on, the user is encouraged to try to correct the interference by one or more of the following measures:

- Reorient or relocate the receiving antenna.
- Increase the separation between the equipment and receiver.
- Connect the equipment into an outlet on a circuit different from that to which the receiver is connected.
- Consult the dealer or an experienced radio/TV technician for help.

D8-10-1-2_En

CAUTION

This product is a class 1 laser product, but this product contains a laser diode higher than Class 1. To ensure continued safety, do not remove any covers or attempt to gain access to the inside of the product. Refer all servicing to qualified personnel. The following caution label appears on your unit. Location: inside of the unit

**CLASS 1
LASER PRODUCT**

CAUTION	CLASS 3B INVISIBLE LASER RADIATION WHEN OPEN, AVOID EXPOSURE TO BEAM.
ATTENTION	RADIATIONS LASER INVISIBLES DE CLASSE 3B QUAND OUVERT. EVITEZ TOUT EXPOSITION AU FAISCEAU.
ADVARSEL	KLASSE 3B USYNLIG LASERSTRÅLING VED ÅBNING. UNDGÅ UDSÆTTELSE FOR STRÅLING.
WARNING	KLASSE 3B ÖSYNLIG LASERSTRÅLNING NÄR DENNA DEL ÄR ÖPPNAD. UNDVIK ATT UTSÄTTA DIG FÖR STRÅLEN.
VORSICHT	BEI GEÖFFNETER ABDECKUNG IST UNSICHTBARE LASERSTRAHLUNG DER KLASSE 3B IM GERÄTEINNEREN VORHANDEN. NICHT DEM LASERSTRAHLAUSSETZEN!
PRECAUCIÓN	CUANDO SE ABRE HAY RADIACIÓN LASER DE CLASE 3B INVISIBLE. EVITE LA EXPOSICIÓN A LOS RAYOS LASER.
VARO!	AVATTAESSA OLET ALLITINNA NÄKYMÄTTÖMÄLLE LUOKAN 3B LASERSÄTELYLLE. ÄLÄ KATSO SÄTEESEEN.

VRW2257-A

D3-4-2-1-8*_C_En

WARNING

To prevent a fire hazard, do not place any naked flame sources (such as a lighted candle) on the equipment.

D3-4-2-1-7a_A_En

VENTILATION CAUTION

When installing this unit, make sure to leave space around the unit for ventilation to improve heat radiation (at least 5 cm at rear, and 3 cm at each side).

WARNING

Slots and openings in the cabinet are provided for ventilation to ensure reliable operation of the product, and to protect it from overheating. To prevent fire hazard, the openings should never be blocked or covered with items (such as newspapers, table-cloths, curtains) or by operating the equipment on thick carpet or a bed.

D3-4-2-1-7b_A_En

POWER-CORD CAUTION

Handle the power cord by the plug. Do not pull out the plug by tugging the cord and never touch the power cord when your hands are wet as this could cause a short circuit or electric shock. Do not place the unit, a piece of furniture, etc., on the power cord, or pinch the cord. Never make a knot in the cord or tie it with other cords. The power cords should be routed such that they are not likely to be stepped on. A damaged power cord can cause a fire or give you an electrical shock. Check the power cord once in a while. When you find it damaged, ask your nearest PIONEER authorized service center or your dealer for a replacement.

5002*_En



Dear Customer:

Selecting fine audio equipment such as the unit you've just purchased is only the start of your musical enjoyment. Now it's time to consider how you can maximize the fun and excitement your equipment offers. This manufacturer and the Electronic Industries Association's Consumer Electronics Group want you to get the most out of your equipment by playing it at a safe level. One that lets the sound come through loud and clear without annoying blaring or distortion-and, most importantly, without affecting your sensitive hearing.

Sound can be deceiving. Over time your hearing "comfort level" adapts to higher volumes of sound. So what sounds "normal" can actually be loud and harmful to your hearing. Guard against this by setting your equipment at a safe level BEFORE your hearing adapts.

To establish a safe level:

- Start your volume control at a low setting.
- Slowly increase the sound until you can hear it comfortably and clearly, and without distortion.

Once you have established a comfortable sound level:

- Set the dial and leave it there.

Taking a minute to do this now will help to prevent hearing damage or loss in the future. After all, we want you listening for a lifetime.

We Want You Listening For A Lifetime

Used wisely, your new sound equipment will provide a lifetime of fun and enjoyment. Since hearing damage from loud noise is often undetectable until it is too late, this manufacturer and the Electronic Industries Association's Consumer Electronics Group recommend you avoid prolonged exposure to excessive noise. This list of sound levels is included for your protection.

Decibel Level Example

30	Quiet library, soft whispers
40	Living room, refrigerator, bedroom away from traffic
50	Light traffic, normal conversation, quiet office
60	Air conditioner at 20 feet, sewing machine
70	Vacuum cleaner, hair dryer, noisy restaurant
80	Average city traffic, garbage disposals, alarm clock at two feet.

THE FOLLOWING NOISES CAN BE DANGEROUS UNDER CONSTANT EXPOSURE

90	Subway, motorcycle, truck traffic, lawn mower
100	Garbage truck, chain saw, pneumatic drill
120	Rock band concert in front of speakers, thunderclap
140	Gunshot blast, jet plane
180	Rocket launching pad

Information courtesy of the Deafness Research Foundation.



S001_En

Operating Environment

Operating environment temperature and humidity: +5 °C – +35 °C (+41 °F – +95 °F); less than 85 %RH (cooling vents not blocked)

Do not install this unit in a poorly ventilated area, or in locations exposed to high humidity or direct sunlight (or strong artificial light)

D3-4-2-1-7c_A_En

WARNING

Before plugging in for the first time, read the following section carefully.

The voltage of the available power supply differs according to country or region. Be sure that the power supply voltage of the area where this unit will be used meets the required voltage (e.g., 230V or 120V) written on the rear panel.

D3-4-2-1-4_A_En mod

If the AC plug of this unit does not match the AC outlet you want to use, the plug must be removed and appropriate one fitted. Replacement and mounting of an AC plug on the power supply cord of this unit should be performed only by qualified service personnel. If connected to an AC outlet, the cut-off plug can cause severe electrical shock. Make sure it is properly disposed of after removal. The equipment should be disconnected by removing the mains plug from the wall socket when left unused for a long period of time (for example, when on vacation).

D3-4-2-1-4_A_En

FEDERAL COMMUNICATIONS COMMISSION DECLARATION OF CONFORMITY

This device complies with part 15 of the FCC Rules. Operation is subject to the following two conditions: (1) This device may not cause harmful interference, and (2) this device must accept any interference received, including interference that may cause undesired operation.

Product Name: MULTI-ENTERTAINMENT PLAYER
 Model Number: MEP-7000
 Responsible Party Name: PIONEER ELECTRONICS SERVICE, INC.
 Address: 1925 E. DOMINGUEZ ST. LONG BEACH, CA 90801-1760, U.S.A.
 Phone: 1-800-421-1404

CONTENTS

FEATURES	5	ADVANCED OPERATIONS SECTION	38
SPECIFICATIONS	9	LOOP PLAY	38
CONFIRM ACCESSORIES	10	CUE POINT/LOOP POINT MEMORY	38
REGARDING PLAYABLE DISCS AND FILES	11	SCRATCH PLAY	39
TYPES OF DISCS PLAYABLE ON THIS UNIT	11	SPIN PLAY	39
ABOUT MP3/AAC DISC PLAYBACK	12	JOG BREAK PLAY	39
ABOUT PLAYBACK FROM USB STORAGE DEVICE	12	EFFECT SCREEN	39
ABOUT MP3 FILES	13	MIX SCREEN	42
ABOUT AAC FILES	13	ABOUT FADER START PLAY	44
ABOUT WAV FILES	14		
ABOUT AIFF FILES	14		
INSTALLATION GUIDELINES	15	ABOUT DJ SOFTWARE	45
CONNECTIONS	16	SOFTWARE END USER LICENSE AGREEMENT	45
NORMAL STYLE CONNECTIONS	16	COPYRIGHT WARNING	46
MANIPULATOR STYLE CONNECTIONS	19	SYSTEM REQUIREMENTS (Minimum Operating Environment)	46
PARTS AND THEIR FUNCTIONS	20	INSTALLING DJ SOFTWARE	47
FRONT PANEL	20	NOTES REGARDING TRIAL PERIOD AND USER REGISTRATION	48
REAR PANEL	23	REGARDING ONLINE SUPPORT	49
HANDLING DISCS AND OTHER MEDIA	24	DISCLAIMER	49
LOADING AND REMOVING DISCS	24	ABOUT THE DRIVER PROGRAM	50
REGARDING FORCIBLE DISC EJECT	24	SOFTWARE END USER LICENSE AGREEMENT	50
WRITING MANAGEMENT DATA TO A USB STORAGE DEVICE	25	DRIVER INSTALLATION	50
CONNECTING AND DISCONNECTING USB STORAGE DEVICES	25	USING DJ SOFTWARE	53
		PREPARING YOUR DJ SOFTWARE PROGRAM	54
		CONTROLLING YOUR COMPUTER USING THE DEDICATED COMMUNICATIONS PROTOCOL	54
		USING MIDI FOR COMPUTER CONTROL	56
		MIDI MESSAGE TABLE	58
START PLAYBACK		ENJOYING CD-G KARAOKE	60
(Using normal connections)	27	SELECT CD-G PLAY MODE	60
BROWSE SCREEN	27	TO PLAY A CD-G DISC	60
FILE BROWSING AND LIBRARY BROWSING	28	TO CANCEL CD-G PLAY MODE	60
SELECT THE TRACK	29	USING THE UTILITY	61
VIEW PROPERTIES OF THE CURRENTLY PLAYING TRACK	29	SETTING METHOD	61
M3U FILE	30	SETTINGS	61
TRACK SELECTION WITH A USB KEYBOARD	30	CREATING LIBRARIES	63
USING THE PLAYLIST	32	BACKING UP USER DATA	63
BASIC CONTROLLER OPERATIONS	34	TO PERFORM A FACTORY RESET	64
ABOUT THE DISC AUTO PLAY FUNCTION	34	TROUBLESHOOTING	65
TO STOP PLAYBACK AND EJECT DISC	34	ABOUT THE LCD SCREEN	67
TO PAUSE PLAYBACK	34	ABOUT OEL (ORGANIC EL) SCREENS	67
ABOUT THE DISC RESUME FUNCTION	34	ERROR MESSAGE DISPLAY	68
FAST FORWARD/FAST REVERSE	34	MEP-7000 UPDATES	68
TRACK SKIP	35	SOFTWARE LIMITING CONDITIONS	69
SWITCHING THE JOG MODE	35	DISCLAIMER	70
JOG DIAL FUNCTION	35		
CHANGING THE PLAY SPEED	36		
APPLYING A MASTER TEMPO	36		
SETTING CUE POINTS	36		
AUTO CUE FUNCTION	37		

FEATURES

This unit is a multi entertainment player designed with a wide array of performance functions for parties and events, together with superb operation characteristics, making it ideal for professional mobile DJ use. Allowing both normal type and manipulator type playing, it represents optimal support for the next generation of DJ performance.

With the normal playing style, DJ play can be performed not only with conventional music CDs (CD-DA), but also with music files (MP3, AAC, etc.) recorded on USB storage devices such as USB memory and external hard disc drives (HDD), together with CD-ROM and DVD-ROM.

Also, by connecting this player to a computer equipped with the accessory DJS software, this player can be designated by DJS as an audio output device, making possible seamless DJ play using not only music contained on USB storage devices and disc media, but also music tracks stored within the computer.

The player also features excellent media-support characteristics, making it unnecessary to worry about specific media types, and is provided with a high-function GUI in its center display; together, these features facilitate searching for and selecting desired tracks from large music libraries, and eliminate the need to use the mixer to manually switch between different sources.

On the other hand, the control unit continues the tradition of Pioneer's CDJ series of players in its panel layout, functions and operations; by connecting the control unit to your computer (USB bus power), music contained in the accessory DJS software can be played using genuine DJ "manipulator style," without the need for mouse or keyboard operations.

Manipulator style

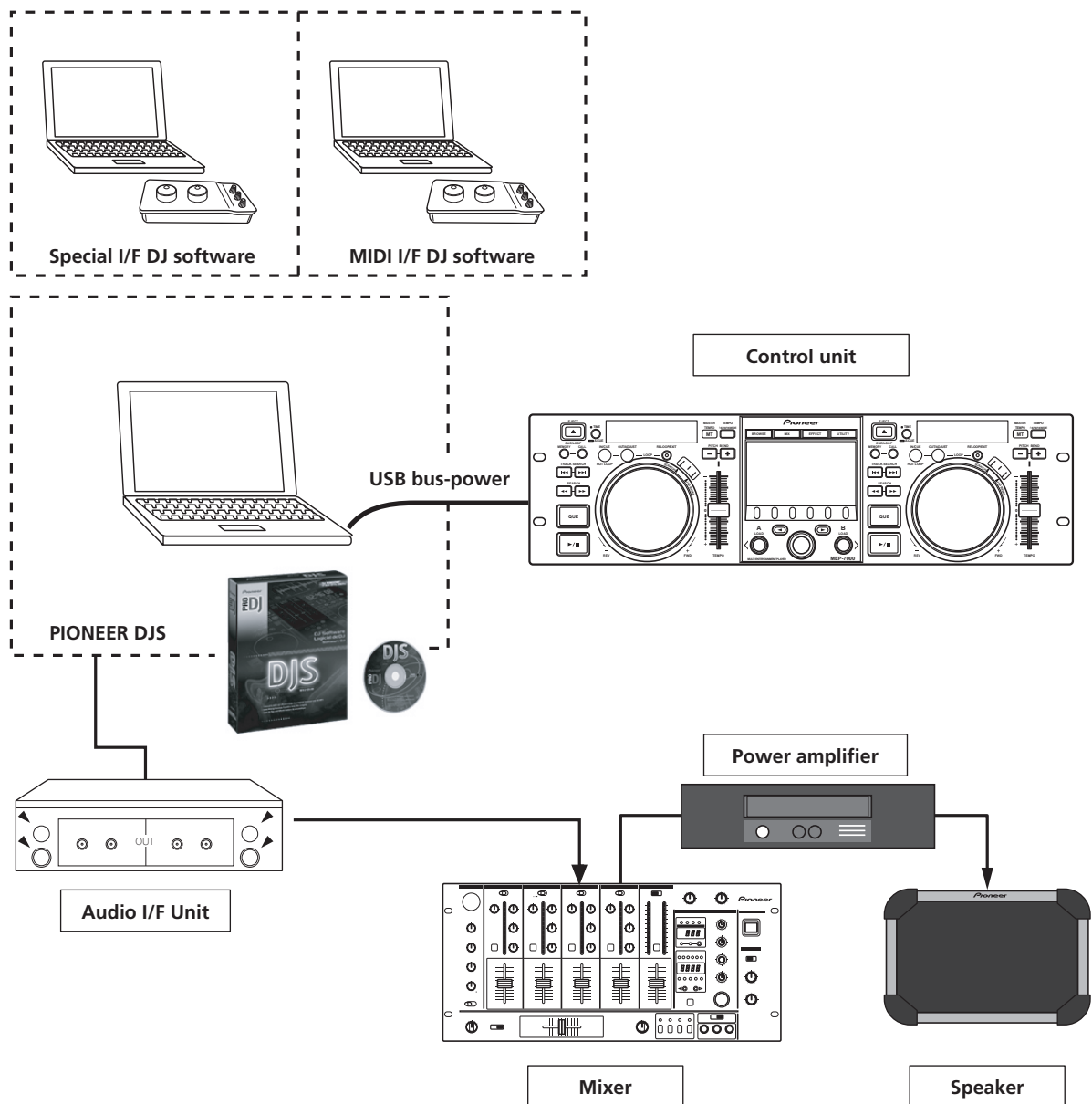

FEATURES

Normal style

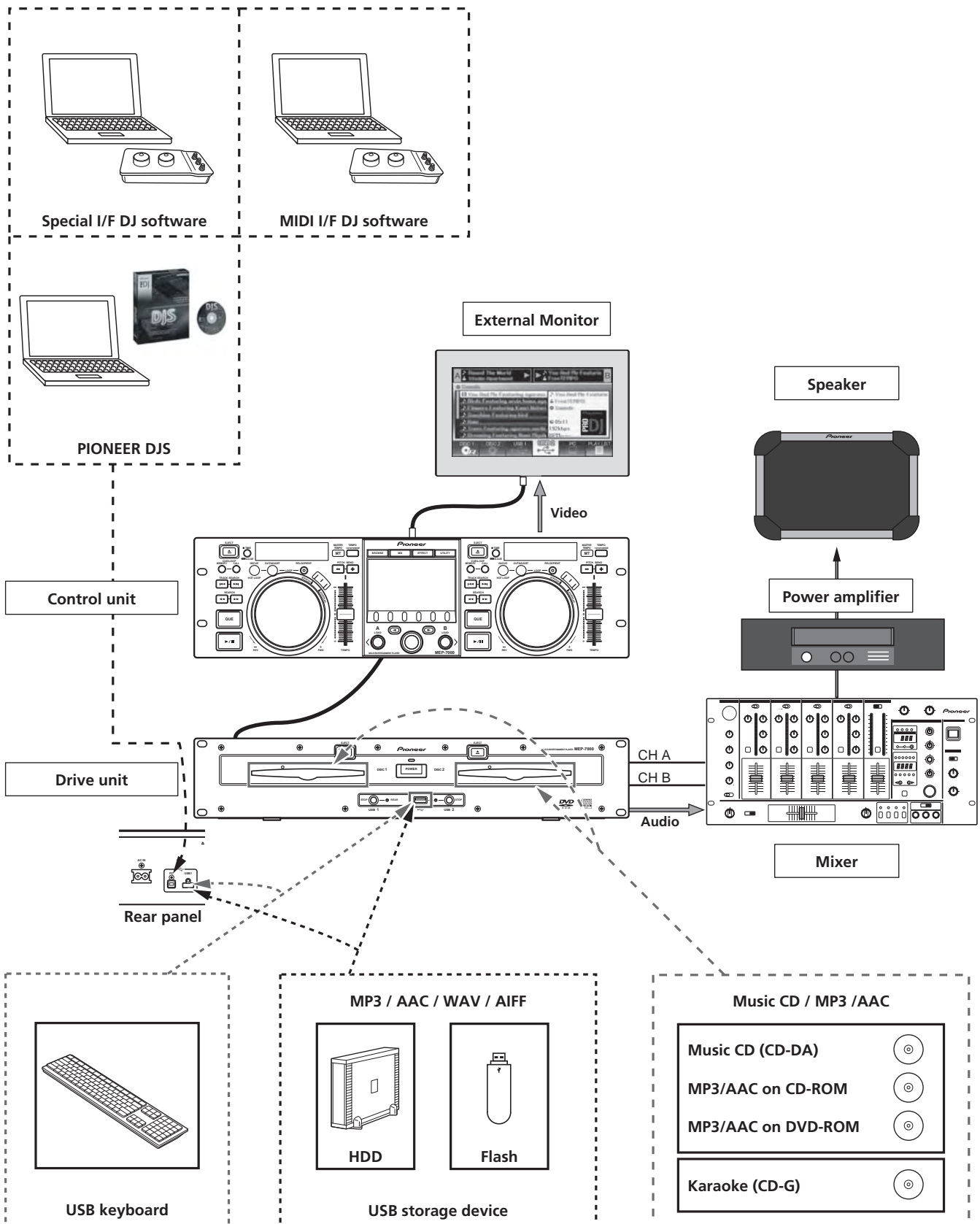

DIVERSE MEDIA PLAYBACK SUPPORT

Supports playback of CD-R/-RW discs formatted for music CD (CD-DA) or CD graphics (CD-G), as well as compressed music files (MP3/AAC) recorded on CD-R/-RW, DVD-R/-RW, DVD+R/+RW, or DVD±R dual layer discs (some discs may not play properly due to unique characteristics of the individual disc, recording characteristics, and disc conditions such as scratches and soiling). Playback is also supported for compressed music files (MP3/AAC/WAV/AIFF) stored on USB storage devices.

DJ SOFTWARE

Sources potentially available on the BROWSE screen include DJ software, including both the accessory DJ program and other DJ software, even without the need for a control disc. The use of MIDI DJ software is also supported. Further, by designating the MEP-7000 as an audio output device, it can be also used for audio output, thus eliminating the necessity of using the mixer to switch between music sources.

MEMO

- Most of the data regarding button and **TEMPO** adjust slider operations on this player can be output to external devices using USB MIDI or dedicated formats. In order to use this unit to control DJ software, it is necessary to install a driver program.
- A dedicated ASIO driver is also available for audio output.
- It may not be possible to designate this player as an audio output device, depending on the type of DJ software used.
- When the control unit is used alone, this player cannot be designated as an audio output device. DJ software only can be operated.

HIGH FUNCTION DISPLAY

Center Display

Features a wide 4.3" color LCD display with high luminance for easy visibility. The intelligent GUI and rotary selector dial allows for no-stress track selection. Music libraries also support the use of jacket photographs.

Controller Display A/B

The elapsed time and tempo display feature top-quality, area-color full-segment OEL displays with high response and terrific visibility. In concert with the center display, these displays and indicators encourage no-stress DJ play in a wide variety of lighting environments.

PLAYLIST

Desired tracks can be selected from music libraries in USB storage devices and disc media and recorded on a "playlist," thus allowing track selection for DJ play without the need to search for the tracks.

SCRATCH EFFECT

Equipped with scratch effects for diverse scratch sound performance

Equipped with three differing scratch sounds, including [SCRATCH], [TRANS], and [BUBBLE]. These new scratch sound performances broaden your DJ play potential.

JOG BREAK EFFECT

Jog break effect provides original sound performance

Equipped with three types of remix assist function, including [JET], [ROLL], and [WAH]. By selecting desired functions, you can freely control effects in response to the rotation of the jog dial, thus creating a new remix world.

AUTO MIX

Performs automatic continuous playback of tracks on the playlist using four types of mix. Even when away from the DJ booth, mixed music can be played automatically just as if a DJ was doing the work.

JOG DIAL

Furnished with large 80 mm jog dial with scratch function, allowing operations with the same sense of touch as an analog turntable.

PITCH BEND

Playback tempo changes in direct relation to the direction and speed of jog dial rotation.

SUPER FAST PITCH BEND

Rotate the jog dial while depressing the **PITCH BEND** button to perform speed changes faster than with normal pitch bend.

FRAME SEARCH

Moves the disc from pause position in frame increments (1/75 sec.) when the jog dial is rotated in pause mode.

SUPER FAST SEARCH

You can search the disc faster than normal search or track search by holding down a **SEARCH** button or **TRACK SEARCH** button as you turn the jog dial.

LIBRARY BROWSE

By making a library of large numbers of tracks recorded on USB storage devices, tracks can be classified into categories by album, artist, and genre, facilitating smooth track selection. For even simpler, more convenient library authoring, library authoring software can be downloaded from the following website:

<http://www.prodjnet.com/support/>

MONITOR OUT

By outputting the center display's BROWSE screen to a larger external monitor, operations can be performed with greater ease. Also outputs CD-G karaoke video.

KEYBOARD SUPPORT

By connecting a keyboard via USB port, you can input the initial (leading) characters of tracks and folders and jump to that point for speedy track selection; a keyboard also makes it possible to edit playlist names.

FEATURES

CD-G KARAOKE

CD-G discs can be played for easy karaoke performances. The karaoke image can also be output to large external monitors.

TEMPO CONTROL

High-performance 60 mm slider allows free modification of track speed.

The digital readout in units of 0.02 % (± 6 % range only) makes possible more accurate and simpler tempo synchronization.

TEMPO CONTROL RANGE

Four greater ease of use, the maximum variable range can be set to four levels, ± 6 %, ± 10 %, ± 16 %, and WIDE (WIDE is limited to music CD (CD-DA) only).

MASTER TEMPO

Changes music tempo without changing pitch.

CUE

BACK CUE

After storing the Cue point in memory, press the **CUE** button while playing the unit to go back to the Cue point and start over.

CUE/LOOP MEMORY

Cue points and loop points can be stored in the internal memory, and called up as required.

AUTO CUE

Auto cue automatically locates the track's start point even if it differs from the track's frame, allowing the player to start instantly at a press of the play/pause (▶/||) button.

CUE POINT SAMPLER

The sound from the memorized cue point can be reproduced by one touch, which can be used as the start point check and the sampler.

REAL TIME SEAMLESS LOOP

This function simplifies setting and releasing loops. This function lets you set a loop while you are playing a track. A loop can also be set at the end of the track so that the track does not stop. In addition, an ADJUST mode has been added to enable one-touch adjustment to the Loop-out point and facilitate loop operation.

HOT LOOP

During loop play, pressing the **IN/CUE/HOT LOOP** button causes playback to instantly return to the loop-in point and once again begin playback from that point. By using this function in sync with the track's rhythm, a variety of new play scenarios becomes possible.

RELOOP

Allows you to replay a loop any number of times.

Press the **RELOOP/EXIT** button after releasing loop play to return to the loop start point. Clever use of on and off in combination with the rhythm make it possible to create new sound effects.

PLAYING ADDRESS

This bar graph provides a visual representation of track playback progress that enables you to see current playback position just like you can on an analog record by checking needle position. The length of the bar shows current position and a flashing bar provides advance notice of track end.

SLOT IN

Discs are loaded directly without opening doors or trays, making track selection that much faster.

FADER START

When connected to a Pioneer DJ Mixer, the mixer's fader control can be used to perform quick start and back cue operations.

CD-TEXT

When a music CD (CD-DA) is played that supports CD-TEXT, the title, artist, and album text information recorded on that disc can be utilized.

LEGATO LINK

Equipped with "Legato Link Conversion" function. When playing music CDs, this function reproduces the 20 kHz+ treble region lost in the CD format, thus producing high-fidelity sound approaching that of analog record turntables.

VIBRATION RESISTANT

Equipped with "shock-proof memory" and the same floating mechanism featured in Pioneer's Carrozzeria car audio series, for superb vibration resistance that withstands sound skips.

SPECIFICATIONS

1 General

Model	MEP-7000
Name	Multi entertainment player
Normal style	
Power voltage	AC 120 V, 60Hz
Power consumption	33 W
Manipulator style	
Power voltage	DC 5 V (USB bus-power)
Current consumption	600 mA
Power consumption	3 W
Operating temperature	+5 °C to +35 °C (+41 °F to +95 °F)
Operating humidity	5 % to 85 % RH (without condensation)
Mass (Weight)	
Control unit	1.7 kg (3.75 lb)
Drive unit	6.1 kg (13.45 lb)
Maximum external dimensions	
Control unit	482.6 mm (W) x 133.0 mm (H) x 83.5 mm (D) 19.0 in (W) x 5.24 in (H) x 3.29 in (D)
Drive unit	482.6 mm (W) x 90.5 mm (H) x 324.6 mm (D) 19.0 in (W) x 3.56 in (H) x 12.78 in (D)

2 USB Upstream Section

Connector USB B-type port (PC connector)

USB Downstream Section

Connector USB A-type ports (USB1/USB2 ports)
Power supply 5 V/500 mA or less (at port)

3 Analog Audio Output Section

Output connector RCA jacks (controller A/B)
Output level 2.0 Vrms (1 kHz)
Frequency response 4 Hz to 20 kHz
S/N ratio 115 dB or more (JEITA)
Distortion 0.006 % or less (JEITA)
* The above specifications refer to values for music CD (CD-DA).

4 Digital Audio Output Section

Output connector RCA jacks (controller A/B)
Output type Coaxial digital (S/PDIF)
Output level 0.5 Vp-p (75 Ω)
Output format 44.1 kHz/16 bit

5 Video Output Section

Output connector RCA jack
Composite output level 1 Vp-p (75 Ω)

6 Center Display Section

Type TFT LCD active matrix display
Size 4.3" (WIDE)
Supported languages
. 9 languages including English, Japanese, and Chinese

7 Controller Display A/B Section

Type OEL (Organic EL) Full segment

8 Other Connectors

Control unit
Remote control connector Mini-DIN 10-pin
5 V connector DC jack
Drive unit
Remote control connector Mini-DIN 10-pin
Control jack Mini-jacks (controller A/B)

Specifications and appearance are subject to change without notice.

CONFIRM ACCESSORIES

Confirm that all furnished accessories are present.

Audio cables (x 2)

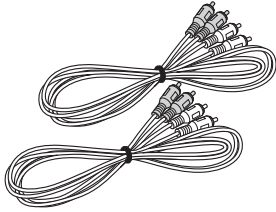

Control cords (x 2)

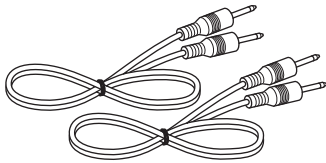

Dedicated remote control cable

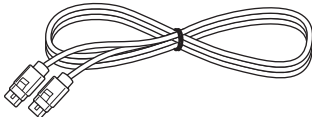

USB cable

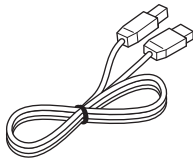

USB auxiliary power cable

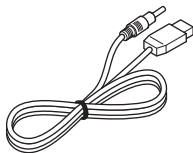

Power cord

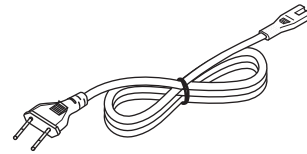

Forced ejection pin

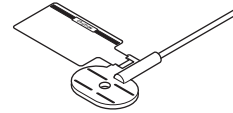

DJS: 1 Set

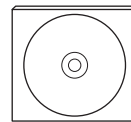

CD-ROM

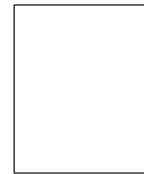

DJS installation key sticker

Operating Instructions (this manual)

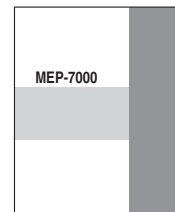

Warranty card









MEMO

- MEP-7000 units marketed in China do not include the DJS software set.
- Three instruction manuals are furnished (including the one you are reading). Please study these manuals in accord with your manner of use:
 - MEP-7000 Operating Instructions (this manual)
Read this first.
 - MEP-7000 DJS Control Guide (PDF file recorded on accessory CD-ROM)
Basic operation instructions when using DJS together with the MEP-7000.
 - DJS User's Manual (PDF file recorded on accessory CD-ROM)
Full functional explanation and operation manual for DJS software.

REGARDING PLAYABLE DISCS AND FILES

TYPES OF DISCS PLAYABLE ON THIS UNIT

- Playable discs will display one of the following logo marks on the disc label, packaging, or jacket:

Playable disc types and logos							
CD	CD-TEXT	CD-R	CD-RW	CD-G	DVD-R	DVD-RW	 is a trademark of DVD Format/Licensing Logo Corporation.
							

■ About disc playback

This unit can play CD-R/CD-RW discs recorded in music CD (CD-DA) or CD graphics (CD-G) format, and CD-R/-RW, DVD-R/-RW, DVD+R/+RW, and DVD±R dual layer discs recorded in MP3/AAC file format.

NOTE

- CD-R/-RW, DVD-R/-RW, DVD+R/+RW, and DVD±R dual layer discs recorded on a standalone recorder or computer may not play properly on this unit for a variety of reasons, including individual characteristics of the disc, scratches or soiling of the disc, or dirt or condensation on the player's laser lens.
- Discs recorded on a computer's disc drive may not play properly due to variations in the recording software settings or computer environment. Be sure to record discs in the proper format (for details, consult the distributor of the recording software application).
- For detailed information regarding the handling and use of your disc media, consult the precautions and instructions furnished with the discs.

■ The following discs cannot be played on this unit

CDs: DTS-CDs, photo-CDs, video-CDs, and unfinalized CDs
 DVDs: DVD video, DVD audio, DVD-RAM, unfinalized DVDs, MPEG moving picture files

■ Backup your discs!

Due to structural characteristics of CD-R/-RW, DVD-R/-RW, DVD+R/+RW, and DVD±R dual layer media, if such discs are left for extended periods in the pause (or cue standby) mode, they become unplayable or difficult to play at that point on the disc. The same symptom may occur if the loop function is used to repeat the same section of a disc for an extremely large number of times.

When using discs holding important files or tracks, always make backups first.

■ About copy-control CDs

This unit is designed to comply with music CD standards. We cannot guarantee operation or performance when using discs that do not comply with these standards.

■ [DualDisc] playback

This unit is designed to comply with music CD standards. We cannot guarantee operation or performance when using discs that do not comply with these standards.

■ About 8 cm single CDs

8 cm single CDs cannot be played on this unit. Also, do not attempt to attach an 8 cm adapter to a disc and play it in this unit, since the adapter may become detached during playback, causing damage to the disc or player.

■ About CD-TEXT on music CDs

This unit supports CD-TEXT, and displays track titles, album titles, and artist names recorded in CD-TEXT. Supported character codes include ASCII, ISO-8859, MS-JIS, and Mandarin Chinese. When multiple text data are recorded, the first text data is displayed.

REGARDING PLAYABLE DISCS AND FILES

ABOUT MP3/AAC DISC PLAYBACK

This unit can play compressed music files (MP3/AAC) recorded on CD-R/-RW, DVD-R/-RW, DVD+R/+RW, and DVD±R dual layer media.

Folder levels	Maximum 8 levels; if more than 8 levels exist, files in the 9th and further levels cannot be played.
Maximum folders	2 000 per disc. If more than 2 000 folders exist, those beyond 2 000 cannot be displayed.
Maximum files	3 000 per disc. If more than 3 000 files exist, those beyond 3 000 cannot be displayed.
Recording format	Supports discs recorded using the ISO9660 file system. When recording is performed using the UDF file system, the disc cannot be played if the ISO9660 file system is not recorded jointly. For details, consult the author of the application.

- Startup time will increase as the number of folders and files increases.

ABOUT PLAYBACK FROM USB STORAGE DEVICE

By connecting a USB storage device to this unit, MP3/AAC/WAV/AIFF files recorded on the device can be played on this unit.

Folder levels	Maximum 8 levels; if more than 8 levels exist, files in the 9th and further levels cannot be played.
Maximum folders	No specific folder limit is made for a device, but folders exceeding 10 000 in a folder cannot be displayed.
Maximum files	No specific file limit is made for a device, but a files exceeding 10 000 in a folder cannot be displayed.
Supported file systems	FAT, FAT32, HFS+

MEMO

- USB storage devices supported by this unit are of the class of USB mass storage devices including external hard discs, portable flash memory devices, and digital audio player. However, optical disc devices such as external DVD/CD drives cannot be used.
- When connecting a USB storage device containing a large number of folders and files, some time may be required to read in the device contents.
- When a connected USB storage device contains multiple partitions, only the initial partition can be used.

CAUTION

 **Depending on the device used, proper playback may not be possible with all USB storage devices. Pioneer assumes no responsibility for any loss of data resulting from connecting any given USB device to this unit.**

- Proper operation may not be possible when a USB storage device is connected through a USB hub.
- Even if a USB hub is used to connect multiple USB storage devices, the second and later devices cannot be used.
- Operation cannot be guaranteed when using a USB storage device with installed flash card reader.
- When connecting a USB storage device utilizing two USB cables, connect both cables to this unit's USB ports.
- If an electrical current stronger than the allowable current is applied to the unit's USB1 port or USB2 port, the unit may stop supplying power to the USB storage device, thus terminating transmission. In this case, a message will be displayed in the center display of the unit, and the stop indicators for USB1 and USB2 will flash red simultaneously. To restore normal operation, disconnect all USB storage devices connected to the unit, then hold either of the USB STOP buttons depressed for two seconds or more. Avoid connecting the USB storage device from which the excess current was detected and other USB storage devices connected through a bus-powered USB hub. If normal operation is not restored through this method, turn the power of this unit off, and then turn it back on.

REGARDING PLAYABLE DISCS AND FILES

ABOUT MP3 FILES

MP3 files may be found in two types, those with Constant Bit Rate (CBR), and those with Variable Bit Rate (VBR). This player supports playback and DJ play of both CBR and VBR type files, but VBR files may exhibit slower performance when using search and super fast search functions, compared to CBR files. When playback performance is preferred, record your files using CBR.

This unit supports MP3 files subject to the following formats:

Supported formats	MPEG-1	Supports Audio Layer-3 sampling frequencies 32 kHz, 44.1 kHz, 48 kHz, with bit rates of 32 Kbps to 320 Kbps.
	MPEG-2	Supports Audio Layer-3 sampling frequencies 16 kHz, 22.05 kHz, 24 kHz, with bit rates of 16 Kbps to 160 Kbps.
Track data		Supports ID3 tag Ver 1.0/1.1/2.2/2.3/2.4. Displays title, album name, artist's name. *1 JPEG images embedded in ID3 tag are displayed as jacket photographs. *2
File extensions		.mp3

*1 In order to display characters written in a local code other than Unicode, the UTILITY function must be used to set the language.

*2 Files with original image size larger than 800 x 800 pixels cannot be displayed.

ABOUT AAC FILES

AAC is an abbreviation for Advance Audio Coding, a basic format relating the audio compression technology used for MPEG-2 and MPEG-4.

AAC data differs in file format and extension depending on the application used to create the data file.

The MEP-7000 is capable of playing iTunes®-encoded AAC files with extension .m4a, as well as .aac and .mp4 files. However, copy-protected files purchased at places like iTunes Music Store cannot be played. Further, some files may not be playable, depending on the version of iTunes in which they were encoded.

Apple and iTunes are trademarks of Apple Inc., registered in the U.S. and other countries.

This unit supports AAC files subject to the following formats:

Supported formats	MPEG-4 AAC LE	Sampling frequency 16 kHz, 22.05 kHz 24 kHz, 32 kHz, 44.1 kHz, 48 kHz, with bit rates of 8 Kbps to 320 Kbps.
Track data	AAC files	Supports ID3 tag Ver 1.0/1.1/2.2/2.3/2.4. Displays title, album name, artist's name. *1 JPEG images embedded in ID3 tag are displayed as jacket photographs. *2
	Non-AAC files	Support metatags (embedded tags). Displays title, album name, artist's name. *1 JPEG images embedded in tag are displayed as jacket photographs. *2
File extensions		.m4a, .aac, .mp4

*1 In order to display characters written in a local code other than Unicode, the UTILITY function must be used to set the language.

*2 Files with original image size larger than 800 x 800 pixels cannot be displayed.

REGARDING PLAYABLE DISCS AND FILES

ABOUT WAV FILES

This unit supports WAV files subject to the following formats:

Supported formats	Supports 16-bit non-compressed PCM, with sampling frequency of 44.1 kHz.
Track data	Supports LST chunk. Displays title, album name, artist's name. *1
File extension	.wav

*1 In order to display characters written in a local code other than Unicode, the UTILITY function must be used to set the language.

MEMO

- WAV files recorded in disc media are not supported.

ABOUT AIFF FILES

This unit supports AIFF files subject to the following formats:

Supported formats	Supports 16-bit non-compressed PCM, with sampling frequency of 44.1 kHz. Displays title, album name, artist's name. *1
File extension	.aif .aiff

*1 In order to display characters written in a local code other than Unicode, the UTILITY function must be used to set the language.

MEMO

- AIFF files recorded in disc media are not supported.

INSTALLATION GUIDELINES

- Placing and using the player for long periods on heat-generating sources such as amplifiers or near spotlights, etc. will affect product performance. Avoid placing the player on heat-generating sources.
- Install this player as far as possible away from tuners and TV sets. A player installed in close proximity to such equipment may cause noise or degradation of the picture. Noise may be noticeable when an indoor antenna is used. In such cases, make use of an outdoor antenna or turn off power to the player.
- When the unit is used in a loud-sound environment, e.g., near a speaker, sound skip may occur. Install the unit away from the speaker or reduce the listening volume.
- Place this unit on a level surface and a stable platform.
- Do not place heavy objects on top of the unit.

Be sure the player, including its audio and power supply cords, does not touch vibrating materials. Any cause of vibration other than the insulators may cause sound skip.

Take special care when using the player while it is installed in a carrying case.

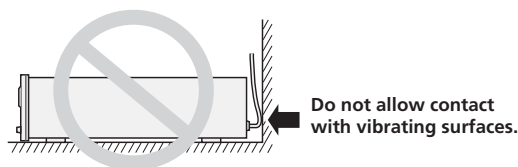

To assure proper heat-dissipation, be sure to maintain this open space.

To assure proper heat-dissipation, be sure to maintain this open space.

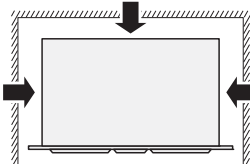

To assure proper heat-dissipation, be sure to maintain this open space.

Installing the MEP-7000 in an EIA rack

The screw holes on the front panel of the MEP-7000 are designed for use in attaching the unit to a 19-inch EIA rack.

Control unit complies with 3U specifications; drive unit complies with 2U. Maximum depth of unit is 324.6 mm.

- Attach the unit to the rack using screws of the appropriate size (screws not provided with the unit).

NOTE

- Do not install the unit immediately above a power amplifier, since damage may occur from the heat produced by the amplifier, or humming or other noise may be caused.
- When transporting the unit, remove the unit from its rack. Attempting to move the rack with the unit installed may result in damage to the unit.
- If the unit must be moved while still in its rack, take precautions to protect the unit from vibration and impact.

Transporting the unit

■ Never move the unit during playback.

During playback, discs rotate at very high speeds; never lift or move the unit during this time to prevent scratches or other damage to discs.

■ Transporting the unit

When moving the unit, always remove any discs that have been loaded, and turn off the power.

Moving the unit with a disc loaded could result in damage to the disc or unit.

About carrying cases

The jog dial is equipped with a delicate switch. If the unit is placed in a carrying case, take precautions to prevent any pressure from being exerted on the surface of the jog dial.

Condensation

When this unit is brought into a warm room from previously cold surroundings or when the room temperature rises sharply, condensation may form inside the unit and impair its performance. In such cases, allow the unit to stand for about an hour or raise the room temperature gradually.

Cleaning the player

To clean the player wipe with a polishing or a soft, dry cloth. For stubborn dirt, moisten a soft cloth with a weak solution of neutral detergent (diluted in five to six parts water), wring the cloth well, and wipe away the dirt. Use a dry cloth to wipe the surface dry. Do not use volatile liquids such as benzene or thinner which will damage to the unit.

CD lens cleaner

If for some reason, the lens becomes soiled and malfunctions, contact your nearest PIONEER authorized service center. Lens cleaners for CD players are commercially available, but special care should be exercised in their use as some may cause damage to the lens.

Cleaning the Jog Dial

To clean the jog dial wipe with a polishing or a soft, dry cloth. For stubborn dirt, moisten a soft cloth with a weak solution of neutral detergent (diluted in five to six parts water), wring the cloth well, and wipe away the dirt. Use a dry cloth to wipe the surface dry.

Applying alcohol, paint thinner, benzene, insecticides, or other stringent substances to the jog dial may cause the markings or finishing of the dial to peel or become discolored, and the use of any such substances should accordingly be avoided.

CONNECTIONS

Whenever connecting or disconnecting components, be sure to first turn off the power and disconnect the power cord from its outlet first. Damage to the unit may result if connections are modified while power is supplied.

NORMAL STYLE CONNECTIONS

1. System connections

Use the provided dedicated remote control cable to connect the control unit to the drive unit. Insert firmly until you hear a click.

Control unit

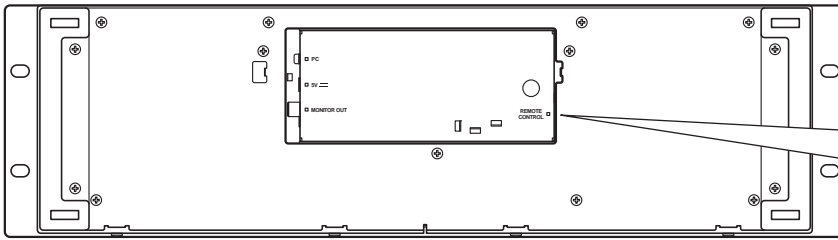

Drive unit

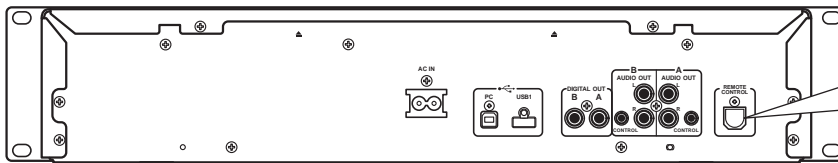

Accessory dedicated remote control cable

2. Connections to DJ mixer (DJM-3000/DJM-800) (audio output and control connections)

Using the accessory audio cable, connect the white plug to the L (left) channel connector and the red plug to the R (right) channel connector. By connecting the accessory control cord, this unit can be controlled from a Pioneer DJ-mixer so as to allow fader start play and back cue operations (except during relay play).

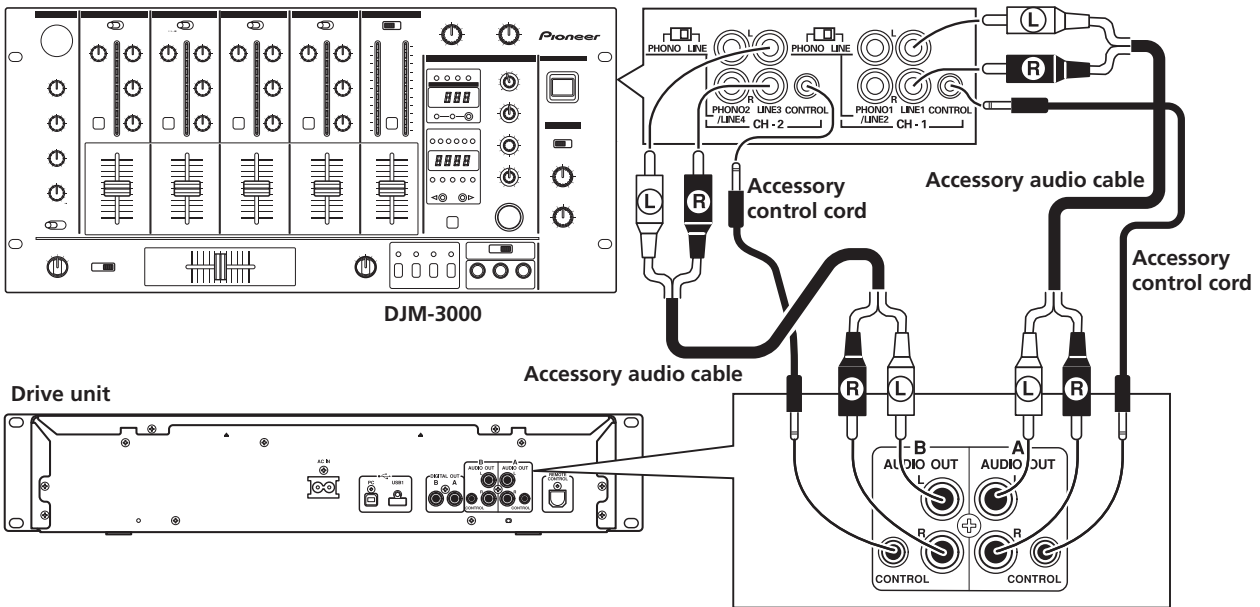

MEMO

- When connecting to the DJM-300, DJM-500 or DJM-600, use the accessory audio cable to connect the CD1 to the drive unit's side A output connectors, and CD2 to the drive unit's side B output connectors as shown in the accompanying illustration.

3. Connection to external monitor (pin-jack connector)

Use these connections when you wish to output the center display images to a large screen, or when using CD-G Karaoke. After connecting this unit to the external monitor, the unit's settings must be changed (see the item "MONITOR OUT" in the topic "[1] DISPLAY" under the section "USING THE UTILITY" on P. 61).

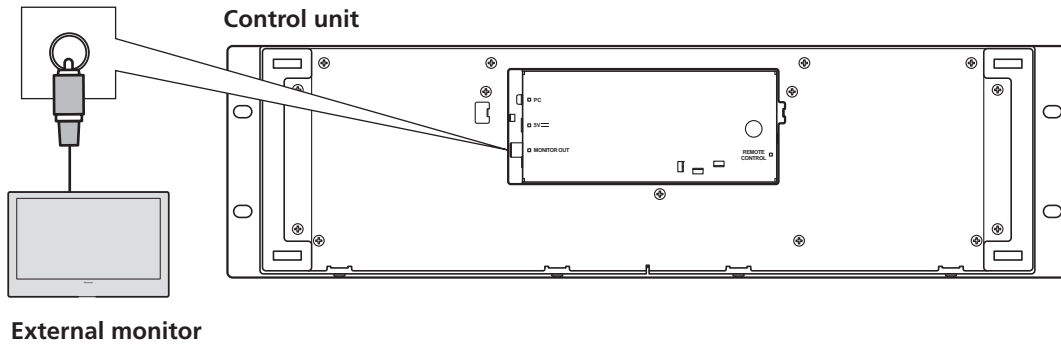

4. Connecting other components

A. Connecting another mixer

Connect this unit's AUDIO OUT connectors to the mixer's LINE IN or AUX connectors. (Do not connect to PHONO connectors, since sound will be distorted and proper playback will not be produced.)

B. Connecting a stereo amplifier (when not using DJ mixer)

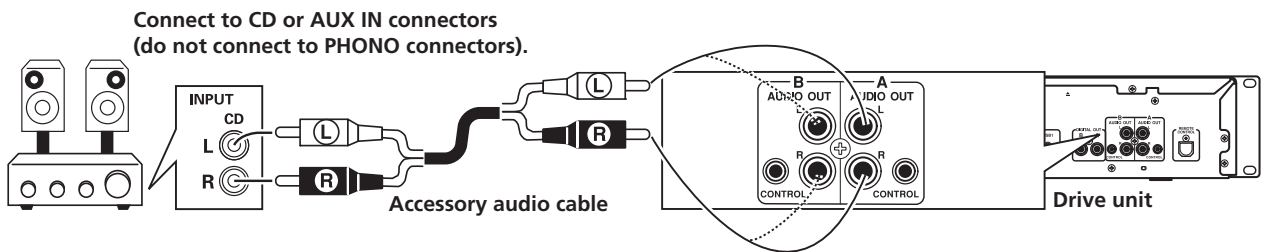

C. Connecting a component with digital input connectors

CD recorder, amplifier with digital inputs, etc.

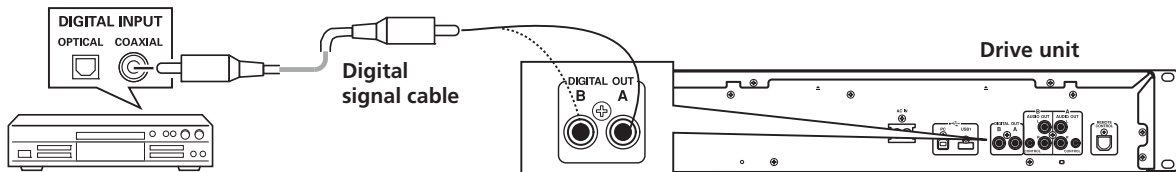

MEMO

- The digital output connectors produce only audio data without the inclusion of subcodes.
- Depending on the CD recorder or other component, certain features, including CD recording, may be restricted. For details, consult the operating instructions for the connected component.

CONNECTIONS

5. Connecting a computer

Make these connections in order to use the accessory DJS or other DJ software program.

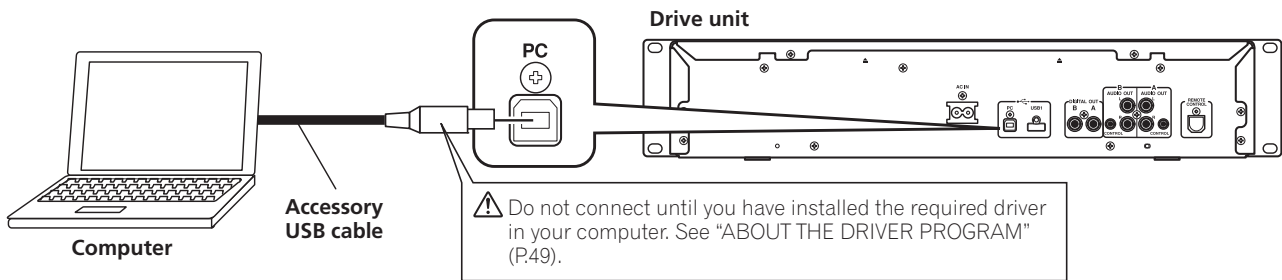

NOTE

- Use only the furnished accessory USB cable.

6. Connecting the power cord

When all other connections have been completed, connect one end of the accessory power cord to the AC IN jack on the rear side of the drive unit, and the other end to a normal AC power outlet, or the auxiliary power outlet of an amplifier.

MANIPULATOR STYLE CONNECTIONS

These connections should be used when you wish to operate the accessory DJ S or other DJ software without connecting the drive unit. Use the accessory USB auxiliary power cable and the normal USB cable to connect the control unit to the computer (connect the USB auxiliary power cable first).

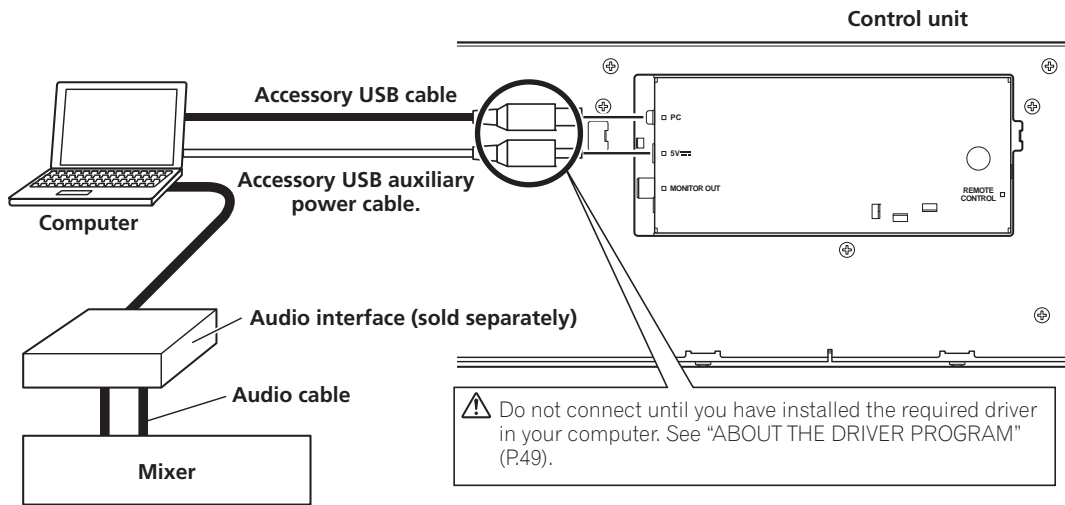

NOTE

- When making manipulator style connections, do not connect the drive unit, since it will not function correctly.
- Do not connect anything to the 5 V connector other than the accessory USB auxiliary power cable.
- Always use the accessory USB auxiliary power cable and USB cable only.
- Always connect the accessory USB auxiliary power cable and USB cable to one and the same computer.
- Do not connect this unit to a computer through a USB hub.
- Do not connect this unit to a computer through a CardBus-supported USB interface card.

PARTS AND THEIR FUNCTIONS

FRONT PANEL

Drive Unit

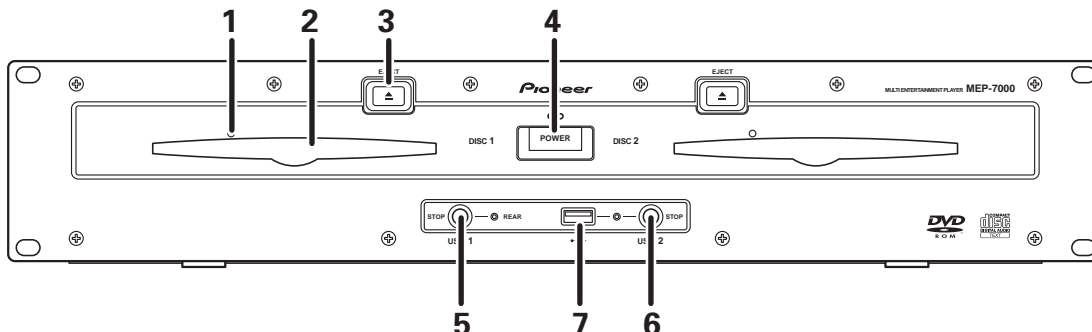

- 1 **Forced eject hole (P. 24)**
- 2 **Disc loading slot (P. 24)**
- 3 **EJECT (▲) button**
To eject a disc from the disc loading slot, press this button during the cue standby or pause mode, or when no tracks are being loaded from the disc.
- 4 **POWER switch and indicator**
Turns unit power ON/OFF.
- 5 **USB1 STOP button and indicator**
Press when removing a USB storage device from USB1 port.
- 6 **USB2 STOP button and indicator**
Press when removing a USB storage device from USB2 port.
- 7 **USB2 port (type A)**
Use to connect a USB storage device or USB keyboard.

Control Unit

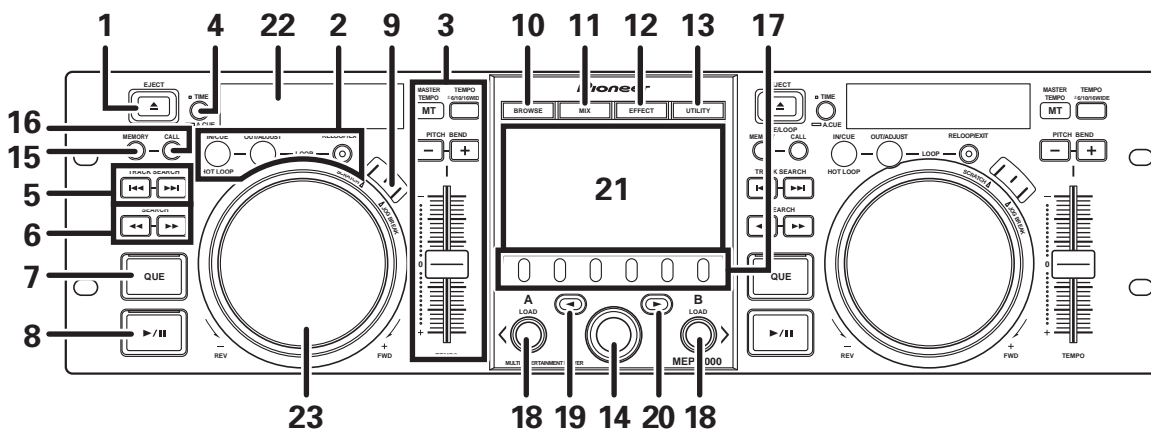

- 1 **EJECT (▲) button**
To eject a disc from the disc loading slot, press this button during the cue standby or pause mode, or when no tracks are being loaded from the disc.
- 2 **LOOP operation buttons (P. 38)**
- 3 **TEMPO control section**
 - TEMPO control range button (±6/10/16/WIDE):**
Each time the button is pressed, the variable range of the TEMPO adjust slider changes.
 - MASTER TEMPO button and indicator (MT):**
Each time the button is pressed, the master tempo function alternates ON/OFF.
 - TEMPO adjust slider:**
From the center detent position, pull the slider towards you (+) to increase the tempo, and push the slider away from you (-) to slow down the tempo.
 - PITCH BEND +/- buttons:**
When pressed during play, the pitch bend function is enabled. Pressing the "+" button accelerates the pitch bend speed, and pressing the "-" button decelerates the pitch bend speed. The speed of the pitch change can be modified by holding the button depressed while rotating the jog dial.

4 Time mode/auto cue button (TIME/A.CUE)

TIME:

Each time the button is pressed, the display's time display alternates between the current track's elapsed playing time, and the remaining time (REMAIN).

A.CUE: (P. 37)

5 TRACK SEARCH (I-◀◀, ▶▶I) buttons (P. 35)

6 SEARCH (◀◀, ▶▶) buttons (P. 34)

7 CUE button and indicator

Setting a cue point (P. 36)

Cue point sampler (P. 36)

Back-cue (P. 36)

Modifying a cue pint (P. 36)

8 Play/pause (▶/II) button and indicator (P. 34)

9 SCRATCH/JOG BREAK buttons and indicators

Use to select jog mode, including SCRATCH, JOG BREAK, or OFF (neither indicator lighted).

10 BROWSE button (P. 27)

Use to select the BROWSE screen.

11 MIX button (P. 42)

Use to select the MIX screen.

12 EFFECT button (P. 39)

Use to select the EFFECT screen.

13 UTILITY button (P. 61)

Use to select the UTILITY screen.

14 Rotary selector dial

Rotate clockwise/counterclockwise for track selection and to move cursor between setting items. Press to confirm selection.

15 CUE/LOOP MEMORY button (P. 38)

Use to store cue points and loop points in memory.

Hold the button depressed to cancel a loop point.

16 CUE/LOOP CALL button (P. 38)

Use to call up cue and loop points stored in memory.

17 Function buttons (F1 to F6, from left)

Switching between the functions allocated to the six function buttons can be performed by using the menu shown on the center display.

On BROWSE screen:

"SELECT THE TRACK" (P. 29)

On MIX screen:

"MIX SCREEN" (P. 42)

On EFFECT screen

"[1] Scratch effect" (P. 39)

"[2] Jog break effect" (P. 41)

On UTILITY screen:

"USING MIDI FOR COMPUTER CONTROL" (P. 56)

"USING THE UTILITY" (P. 61)

18 LOAD A/B buttons

Sets the selected track in the controller A/B.

19 Select up (◀) button

Each time this button is pressed, the display returns to the next higher menu level.

20 Select down (▶) button

Each time this button is pressed, the display advances to the next lower menu level.

21 Center display (P. 22)

22 Display A/Display B (P. 22)

23 Jog dial (+FWD/-REV) (P. 35)

PARTS AND THEIR FUNCTIONS

Center Display



1 Main menu display

The center display's menus are changed by using the **BROWSE** button, **MIX** button, **EFFECT** button, and **UTILITY** button. The function buttons, select up (◀)/down (▶) buttons, **LOAD A/B** buttons, and the rotary selector dial are used to manipulate the contents of each menu.

BROWSE screen

Use to select tracks and construct playlists (P. 27).

MIX screen

Use to perform mixing operations, including auto mix using playlists (P. 42).

EFFECT screen

Use to select scratch play and various effects used in jog break play (P. 39).

UTILITY screen

Use to make unit settings (P. 61).

2 Function tab

Displays items that can be changed using the six function buttons. Items displayed differ depending on the contents shown on the main menu display.

3 A/B track information display

Displays track information and current status for tracks playing on controller A/B.

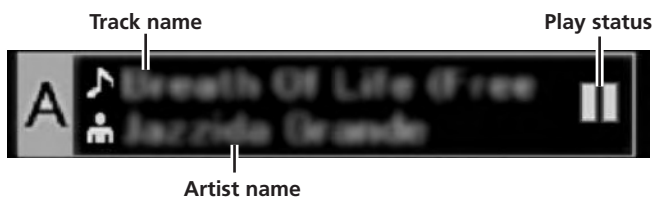

Play status

	Indicates track is currently playing.
	Indicates track is currently paused.
	Indicates track is currently in cue standby condition (see P. 36 "SETTING CUE POINTS").

MEMO

- Track name and artist name can be displayed in Western European languages, Russian, Chinese (simplified Mandarin), and Japanese.

Display A/Display B

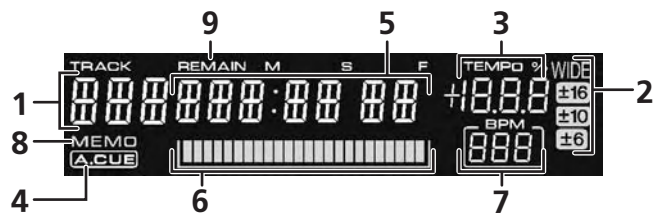

1 Track number display

Displays the number of the track currently playing.

2 TEMPO control range display (±6, ±10, ±16, WIDE)

Displays the selected variable range mode of the **TEMPO** adjust slider.

3 TEMPO change ratio display

Displays the change in tempo produced by the operation of the **TEMPO** adjust slider.

4 A.CUE indicator

Lights when the Auto Cue function is ON.

5 Time display

Displays the current track's elapsed time ([REMAIN] indicator is off), or remaining time ([REMAIN] indicator is lighted), in minutes [M], seconds [S], and frames [F].

6 Playing address display

To provide a quick intuitive grasp of the relative progress of a track's playback (either elapsed time or remaining time), a bar graph is used to represent the full length of the track.

- Elapsed time display: Starts with all segments off, then gradually lights from left to right.
- Remaining time display: Starts with all segments on, then gradually goes off from left to right.
- When 30 seconds of remaining playing time is reached, the graph begins to flash slowly.
- When 15 seconds of remaining playing time is reached, the graph begins to flash quickly.

7 BPM display

Shows the currently playing track's BPM (Beats Per Minute)

8 MEMO indicator

Lights when a cue or loop point has been stored in memory.

9 REMAIN indicator

Lights when the time display is set for remaining time.

REAR PANEL

Drive Unit

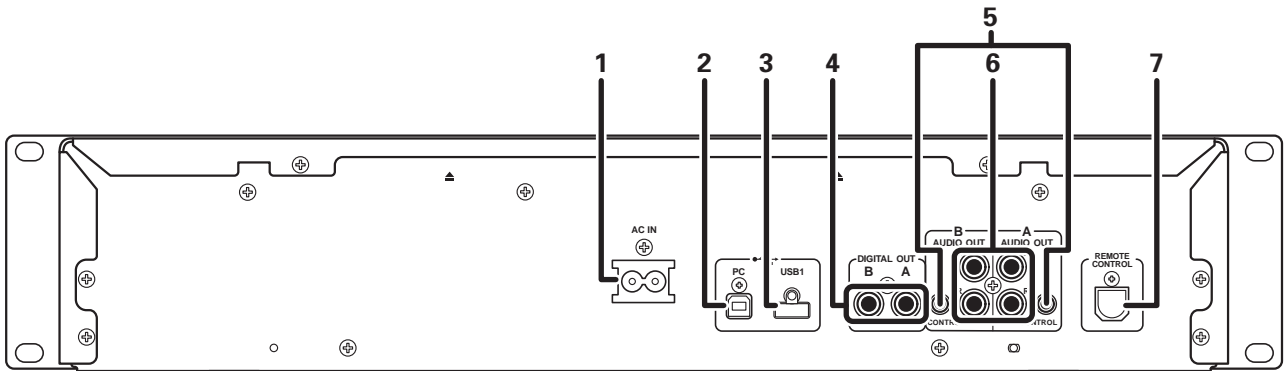

- 1 AC inlet (AC IN)**
Use the supplied power cord to connect this inlet to a household AC outlet.
- 2 PC connector: USB port (type B)**
Use the supplied USB cable to connect this port to a computer.
- 3 USB1 port (type A)**
Use to connect a USB storage device or USB keyboard.
- 4 Digital output connectors (DIGITAL OUT A/B)**
RCA-type coaxial digital output connector for connecting a DJ mixer, AV amplifier, CD recorder or other component supporting digital input.
The output supports all functions including DJ function, but only audio data not including subcodes is output.
- 5 Control jacks (CONTROL A/B)**
When the supplied control cord is used to connect this unit to a Pioneer DJ mixer, the DJ mixer can be used to control this unit so as to perform fader start play and back cue operations. Also, by connecting this jack to another DJ player's control jack, automated relay play can be performed.*
* Relay play is disabled during DJ software track selection.
- 6 Audio output connectors (AUDIO OUT A/B)**
RCA-type analog audio output connectors.
- 7 Remote control connector (REMOTE CONTROL)**
Use the supplied dedicated remote control cable to connect to the control unit.

Control Unit

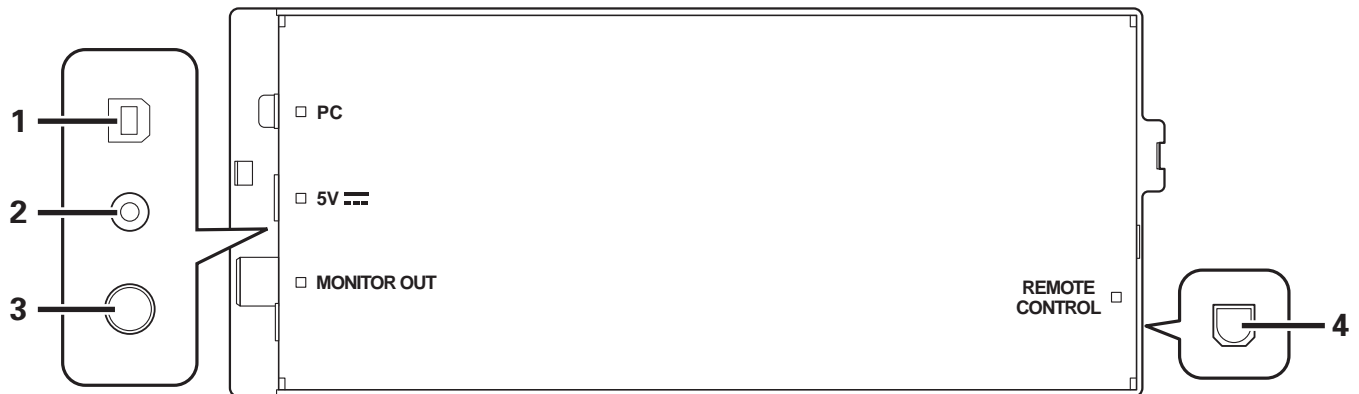

- 1 PC connector: USB port (type B)**
Use the accessory USB cable to connect this port to a computer.
- 2 5 V connector**
Use the accessory USB auxiliary power cable to connect to a computer.
- 3 Video output connector (MONITOR OUT)**
Use a video cable to connect to an external display.
- 4 Remote control connector (REMOTE CONTROL)**
Use the supplied dedicated remote control cable to connect to the drive unit.

HANDLING DISCS AND OTHER MEDIA

LOADING AND REMOVING DISCS

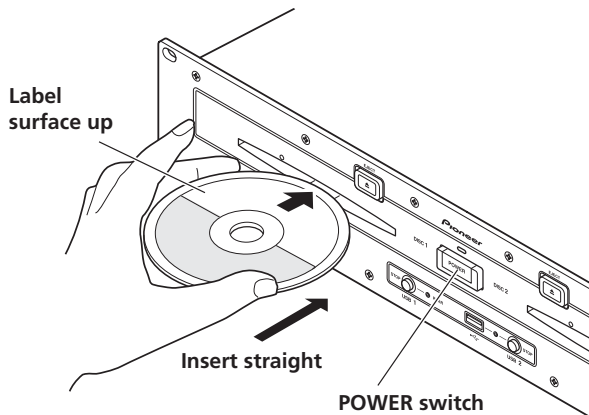

- 1 Set the drive unit's front panel POWER switch to ON.

NOTE

- Do not attempt to forcibly insert a disc when the power is off, since damage may occur to the disc or loading mechanism.

- 2 Insert a disc.

- Insert the disc flat with the label surface upright.
- Only one disc can be loaded at a time. Do not attempt to insert two discs together, or to insert a second disc when one is already playing.
- When inserting a disc, do not apply excessive force, or so much pressure that the disc bends. Also, when the mechanism is pulling in a disc or ejecting a disc, do not apply opposing pressure so as to defeat the mechanism's purpose. Any of these actions may damage the disc or mechanism.

- 3 To remove a currently playing disc, first press the play/pause (▶/⏸) button to stop the playback, then press the EJECT (▲) button. Alternately, when a cue point has been set, during play press the CUE button (to cause "back cue") and then press the EJECT (▲) button.

Disc rotation will stop and the disc will be ejected from the slot.

NOTE

- Do not attempt to reinsert a disc while the eject procedure is still operating and the [EJECT] indicator is lighted. If a disc is pressed back in while it is still being ejected (the [EJECT] indicator is lighted), the mechanism may stop. In this case, press the EJECT (▲) button once again, and wait until the [EJECT] indicator has gone out before reinserting the disc.

REGARDING FORCIBLE DISC EJECT

If the EJECT (▲) button fails to operate and a disc cannot be removed, insert the furnished forcible eject pin into the forcible eject hole on the front panel of the drive unit to allow the disc to be removed.

When performing forcible eject, always abide by the following precautions:

- 1 Turn off the power to the drive unit and wait at least one minute.



Inserting the forcible eject pin before one minute has elapsed may occasion the following dangers:

- The disc may be ejected while it is still rotating at high speed, causing injury to fingers or hands.
- The drive's disc clamp may rotate in an unstable condition, causing damage to the disc.

- 2 Use only the furnished eject pin (do not use other objects)

When the forcible eject pin is inserted fully into the forcible eject hole, the disc will come out of the slot by about 5 mm to 10 mm, where it can be grasped by the fingers and removed.

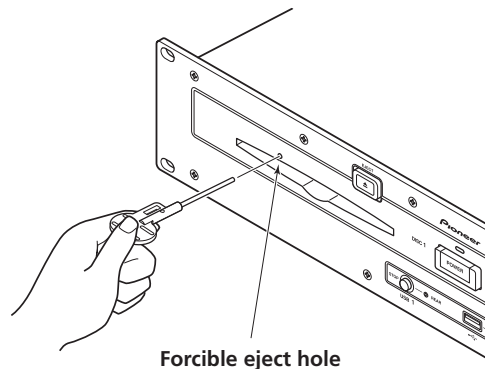

WRITING MANAGEMENT DATA TO A USB STORAGE DEVICE

When this unit is used with a USB storage device to play music, various management data files are created within the storage device. The management data are of the following three types, and stored within the hidden directory named "PIONEER" (in HFS+ format, named ".PIONEER"). Note that if these data folders and their files are deleted, cue and other information created by the unit will be deleted.

■ CUE folder

Cue data files are created whenever cue point memory is used with tracks on the USB storage device. Approximately 200 bytes of space are required for each cue point.

■ PLAYLIST folder

Playlist data files are created whenever a playlist is created for tracks on a USB storage device. Approximately 100 Kbytes are required for each playlist.

■ LIBRARY folder

This folder is created whenever the UTILITY screen is used to make a music library. Storage space required per track ranges from several hundred bytes to about 1 Kbyte.

CONNECTING AND DISCONNECTING USB STORAGE DEVICES

■ Indicator contents

Displays the connection status for the USB storage device.

Not lighted	Device not connected
Lighted steadily	Device is detected
Flashing (two stages)	The STOP button has been pressed and device is being dismantled. If the STOP button is released while the indicator is flashing slowly, the dismantlement will be canceled.

- The communication status between this unit and the USB storage device can be confirmed by viewing the storage device's status lamp.

■ Connecting a USB storage device

By connecting a USB memory or other USB storage device, the music files on the storage device will be read into this unit.

- 1 **Connect the device to the USB1 or USB2 port.**
- 2 **Confirm that the indicator lights red.**

Confirm on the front panel that the indicator for the port used has changed from not lighted to lighted red.

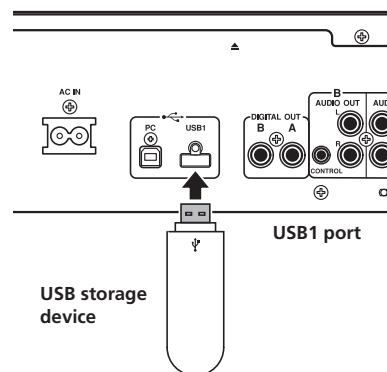
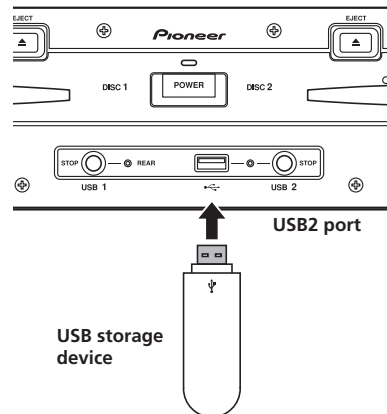

✓ MEMO

- USB storage devices supported by this unit are of the class of USB mass storage devices including external hard discs, portable flash memory devices, and digital audio player. However, optical disc devices such as external DVD/CD drives cannot be used.
- When connecting a USB storage device containing a large number of folders and files, some time may be required to read in the device contents.
- When a connected USB storage device contains multiple partitions, only the initial partition can be used.

HANDLING DISCS AND OTHER MEDIA

✓ CAUTION

⚠ **Depending on the device used, proper playback may not be possible with all USB storage devices. Pioneer assumes no responsibility for any loss of data resulting from connecting any given USB device to this unit.**

- Proper operation may not be possible when a USB storage device is connected through a USB hub.
- Even if a USB hub is used to connect multiple USB storage devices, the second and later devices cannot be used.
- Operation cannot be guaranteed when using a USB storage device with installed flash card reader.
- When connecting a USB storage device utilizing two USB cables, connect both cables to this unit's USB ports.
- If an electrical current stronger than the allowable current is applied to the unit's USB1 port or USB2 port, the unit may stop supplying power to the USB storage device, thus terminating transmission. In this case, a message will be displayed in the center display of the unit, and the stop indicators for USB1 and USB2 will flash red simultaneously. To restore normal operation, disconnect all USB storage devices connected to the unit, then hold either of the USB STOP buttons depressed for two seconds or more. Avoid connecting the USB storage device from which the excess current was detected and other USB storage devices connected through a bus-powered USB hub. If normal operation is not restored through this method, turn the power of this unit off, and then turn it back on.

■ To disconnect a USB storage device

- 1 **Hold the STOP button pressed for two second or more.**
- 2 **Confirm that the indicator goes out.**
Confirm on the front panel that the red indicator for the connected port has change from flashing to off.
- 3 **Disconnect the USB storage device.**

✓ MEMO

- After the indicator goes out, if the **STOP** button is held depressed for two seconds or more, the USB storage device's connection can be reinitiated without the need to physically disconnect and reconnect it.

✓ CAUTION

⚠ **When disconnecting a USB storage device, always be sure to perform the STOP operation first.**

If the STOP operation is not completed before disconnection, cue/loop memory and playlist update may not occur properly, resulting in the loss of data. Also, the USB storage device may becomes unreadable, or other substantial damage may occur.

In the case of a HDD device, do not subject it to impact or vibration during use.

Always disconnect the USB storage device before turning off the power to this unit.

START PLAYBACK (Using normal connections)

START PLAYBACK (Using normal connections)

Using the MEP-7000, track selection can be performed on the center display from up to six kinds of music source, including two discs, two USB storage devices, a personal computer (DJ software), and playlists. The buttons needed for selecting each type of source are illustrated below.

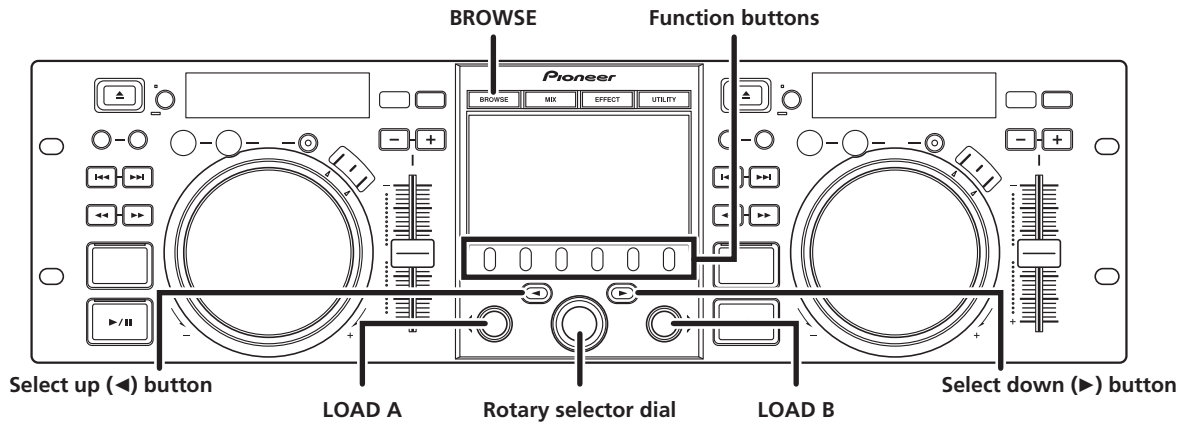

BROWSE SCREEN

When the **BROWSE** button is pressed, the BROWSE screen shown below will be displayed, allowing confirmation of all information necessary for track selection.

MEMO

- Track information, including file/folder names, title, and artist can be displayed in Western European languages, Russian, Chinese (simplified Mandarin) and Japanese.
- If characters are not displayed correctly, use the LANGUAGE item on the UTILITY screen to select the desired language (P. 62).

4 Browse window	Displays the selected source contents. Displays contents in alphabetical order by M3U files, folders, and tracks.
5 Higher level name	Displays the name of the folder or source at the next higher level of the hierarchy relative to the item currently shown in the browse window.
6 Source selection	Use the function button to select the source displayed in the window.
7 Jacket photo display	If a JPEG image is attached to the ID3 tag or present in the folder, when the selection cursor is used to choose a track, the associated image will be displayed in the contents display section.

Source icons

The following icons are displayed in the source selection section.













1 Contents display	Displays the contents of the line selected with the cursor. In the case of a folder, the contents of the folder are displayed; in the case of a track, the track information is displayed.
2 A/B track information display	Displays track name, artist name, and playback status for track currently set in controller.
3 Selection cursor	Use the rotary selector dial to move this cursor up/down and select folders and tracks.

	Music CD (CD-DA) disc. Selecting this icon displays the disc's contents.
	CD-ROM/DVD-ROM disc. Selecting this icon displays the disc's contents.
	Selecting this icon displays the contents of the USB storage device.
	Selecting this icon enables DJ software control (P. 54). When DJS is booted, changes to DJS icon.
	Selecting this icon displays the playlist (P. 32).

START PLAYBACK (Using normal connections)

■ Browse icons

These icons indicate the types of items displayed in the browse window.

	Track
	Track (with memory cue)
	Track (currently playing on Controller A)
	Track (currently playing on Controller B)
	Track (currently playing on both controllers)
	Folder
	M3u file or playlist
	Album
	Artist
	Genre

FILE BROWSING AND LIBRARY BROWSING

This unit can display the as-written structure of file and folder contents for discs and USB storage devices, and allow the user to browse the contents. This manner of display is called "file browsing."

Further, in the case of USB storage devices, by constructing a library within the device based on ID3 tags and other track information, tracks can be classified by album name, artist name, and genre, thus facilitating track selection. This kind of display is called "library browsing" (for instructions regarding making libraries, see P. 63 "CREATING LIBRARIES").

■ File Browsing

Displays as-written structure of folders and files in selected source.



■ Library Browsing

Screen menu is displayed as shown below, allowing track selection based on genre, artist name, album name, or title.

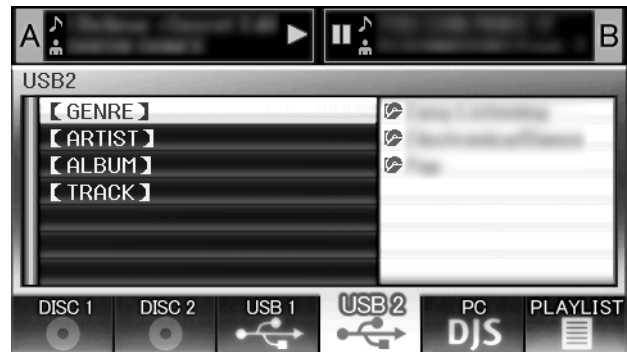

[GENRE]

Allows track selection in order of Genre → Artist name → Album name → Title.

[ARTIST]

Allows track selection in order of Artist name → Album name → Title.

[ALBUM]

Allows track selection in order of Album name → Title.

[TRACK]

Allows track selection from the song title.

[ALL]

In the event that multiple folders exist within the selected category of [GENRE] or [ARTIST], the [ALL] item will appear. By selecting [ALL], all content items existing on the same hierarchy level as that selected will be displayed.

✓ MEMO

- In the case of library browsing, even when a device has a previously created library, the UTILITY setting can be used to switch to file browsing (P. 62).
- Tracks without genre, artist name or album name will be listed together as [Unknown] within the respective categories.
- In the event track numbers are written in the track tags, the tracks within album will be displayed in their track order. In the case of genre, artist, and album, display will be in alphabetical order.

START PLAYBACK (Using normal connections)

SELECT THE TRACK

- 1 Press the **BROWSE** button.
The BROWSE screen will appear.
- 2 Prepare the source you wish to play.

For discs

Load the disc into either Drive 1 or Drive 2.

For USB storage devices

Insert the USB storage device into either port USB1 or USB2.

For DJS

Connect your computer to the drive unit's PC connector, and start the DJS software.

MEMO

- For instructions on operating the DJS software, see the section "USING DJ SOFTWARE" on P. 53.
- 3 Use the function buttons to select the source you wish to play.
The contents of the selected source will be displayed in the window. In the event that a library is present in the USB storage device, track selection can be performed by the name of the album or artist.
 - 4 Turn the rotary selector dial.
The selection cursor in the browse window can be moved up/down. The contents display shows the contents of selected folders and track information.
 - 5 Use the select up (◀)/down (▶) buttons to move up/down the folder hierarchy.
When a folder has been selected, press the button (or press the rotary selector dial) to enter that folder.
Press the select up (◀) button to return one level up the folder hierarchy.
 - 6 Press the **LOAD A** button or **LOAD B** button.
A track will be loaded in the controller A or B, and the loaded track will begin playback.

MEMO

- In the case of music CDs (CD-DA), the disc in Drive 1 is set in Controller A, and the disc in Drive 2 is set in Controller B. The controller cannot be optionally designated.
- If **LOAD LOCK** is ON, loading cannot be performed in the currently playing controller. In this case, press the play/pause (▶/||) button to set the pause mode, or press the **CUE** button to perform back cue, and then press the **LOAD** button.
- The **LOAD LOCK** can be set to ON/OFF by means of the **UTILITY** screen (P. 62).

Track menu

If the rotary selector dial is pressed when a track is selected, the contents display will show the track menu and the rotary selector dial can then be used to execute the menu items:

	Music CD	Other than music CD
[CANCEL]	Leave the track menu.	
[LOAD A]	Sets drive 1 in controller A, drive 2 in controller B.	Set track in Controller A.
[LOAD B]		Set track in Controller B.
[ADD TO PLAYLIST]		Record track to playlist. See "USING THE PLAYLIST" (P. 32).
[DELETE MEMO CUE]	Erase cue/loop point data. See "SETTING CUE POINTS" (P. 36).	

VIEW PROPERTIES OF THE CURRENTLY PLAYING TRACK

- 1 Of the four buttons (**BROWSE**, **MIX**, **EFFECT**, **UTILITY**), once again press the one currently selected to turn it OFF.
The display will show track information, including the source name, track name, artist name, album name, genre, total playing time, bit-rate, and BPM.
Press the select up (◀) button to move the menu to the folder with the currently playing track on controller A; press the select down (▶) button to move the menu to the folder with the currently playing track on controller B.



START PLAYBACK (Using normal connections)

M3U FILE

The MEP-7000 supports files in the m3u format.

Files with the extension m3u are treated the same as folders; when selected with the cursor, the recorded tracks are shown on the contents display in the form of a playlist.



MEMO

- Up to 100 m3u files can be displayed per device.
- Up to 300 tracks can be displayed for each m3u file. However, if a file exceeds 308 000 bytes, tracks loaded past that size cannot be displayed.
- M3U files are not supported using HFS+ file systems on USB storage devices.
- In the case of discs, short file name notation is not supported.

NOTE

- When this unit's library function (P. 63) is used for browsing, m3u files will not be displayed.
- Since a variety of formats can coexist within an m3u playlist, it may not operate properly in all cases.

TRACK SELECTION WITH A USB KEYBOARD

By attaching a keyboard, track selection can be performed by inputting the initial character of the track or folder (track/folder jump), and playlist names can also be edited. Connect the keyboard to the USB1 or USB2 port.

Track/folder jump

- 1 Use the **TAB** key to select the **BROWSE** screen.
- 2 Use one of the **F1 to F4** or **F6** keys to select the source. Accessory DJS or other DJ software cannot be used for selection. Jump is possible if the **PLAYLIST** is at the first hierarchical level (playlist name) or lower in the folder tree.
- 3 **Sequentially input the letters of the track name you wish to select.** The cursor will move to the first track with the matching string of characters. If folders exist at that level, the cursor will likewise jump to matching folder names.
- 4 **When the cursor is on the desired track name, press the ENTER key to confirm the selection.** The track menu will appear.
- 5 **Press the ↓ key to select [LOAD A], and press the ENTER key.** The track will begin playback.

Editing playlist names

- 1 Use the **TAB** key to select the **BROWSE** screen.
- 2 Use the **F6** key to select the **playlist** screen.
- 3 Use the **↓** key to select **playlist** you wish to edit.
- 4 **Press shift + ENTER key to confirm the selection.** The playlist menu will be displayed.
- 5 **Use the ↓ key to select [RENAME], then press ENTER key.** The edit mode will be enabled, allowing you to edit the playlist name.
- 6 **Edit the playlist name.** A playlist name can include up to 32 characters.
- 7 **When editing is completed, press the ENTER key.** The playlist will flash, signaling the completion of editing. For other keyboard operations, see the accompanying table.

Keyboard Input Reference Table

Input	Jump to track name, folder name	Editing playlist
Alphabet	[Char input mode] Character input	[Char input mode] Character input
Numeral	[Char input mode] Character input	[Char input mode] Character input
Symbol	[Char input mode] Character input	[Char input mode] Character input
SPACE	Blank space input	Blank space input
ENTER	Enter lower level of selection cursor.	Confirm edit
	If cursor is on track name, open menu screen.	
Shift+ENTER	If cursor is on track name, record track in PLAYLIST.	If cursor is on PLAYLIST (first level), open menu screen.
	If cursor is on folder, record folder contents in PLAYLIST.	
Home	Cursor jump to top level of list.	—
End	Cursor jump to bottom level of list.	—
Page Up	Turn page of list (7 items above).	—
Page Down	Turn page of list (7 items below).	—
↑	Move cursor up.	Move cursor up.
↓	Move cursor down.	Move cursor down.

START PLAYBACK (Using normal connections)

→	Move cursor to lower level.	Inputs same character as last input, and moves to next input position.
←	Move cursor to higher level.	[Char input mode] Deletes last character (deletes final character but does not leave current mode).
Back Space	[Char input mode] Deletes last character (when initial character is deleted, quits mode).	[Char input mode] Deletes last character (deletes final character but does not leave current mode).
Shift+Back Space	[Char input mode] Deletes last character (when initial character is deleted, quits mode).	[Char input mode] Deletes all characters (deletes final character but does not leave current mode).
Delete	[Char input mode] Deletes last character (when initial character is deleted, quits mode).	<ul style="list-style-type: none"> • [Char input mode] Deletes last character (deletes final character but does not leave current mode). • Normally, delete item (tracks in PLAYLIST).
F1	Selects [DISC 1] icon.	
F2	Selects [DISC 2] icon.	
F3	Selects [USB 1] icon.	
F4	Selects [USB 2] icon.	
F5	Selects [PC] icon.	
F6	Selects [PLAYLIST] icon.	
F7	–	
F8	–	
F9	–	
F10	–	
F11	–	
F12	–	
Esc	[Char input mode] Returns to normal mode.	
TAB	BROWSE/MIX/EFFECT/UTILITY button select (toggles to right direction)	
Shift+TAB	BROWSE/MIX/EFFECT/UTILITY button select (toggles to left direction)	
Ctrl	–	
Alt	–	

MEMO

- Two-byte characters are not supported. Also, character search is disabled in the edit mode.
- In the event character input appears mistaken, use the UTILITY screen to set the KEYBOARD LANGUAGE to an appropriate selection (see P. 62).
- The USB STOP indicator will not light even when a USB keyboard is connected.

NOTE

- Proper operation may not be possible depending on the USB keyboard or USB hub used.

START PLAYBACK (Using normal connections)

USING THE PLAYLIST

This unit allows the user to prerecord desired tracks in a playlist, thus allowing quick track selection even when using large-capacity discs and USB storage devices.

Up to 20 playlists can be constructed, and each playlist can record up to 150 tracks from multiple USB storage devices and CD-ROM/DVD-ROM discs.

MEMO

- Music CD (CD-DA) tracks and DJ software tracks (including DJS) cannot be recorded on a playlist.
- Once recorded, a playlist remains in memory even when the power is turned off, so that it can be reused later.
- When a track is recorded on a playlist from a USB storage device, the playlist information is written to the storage device itself.

Playlist display composition

Playlist listing

When the [PLAYLIST] function button is pressed, a listing of playlists is displayed. By using the rotary selector dial, a desired playlist can be selected. The playlist indicated by an orange icon has been selected for mixing (P. 42).



Also, if a playlist is selected and the rotary selector dial is held depressed for one second or more, the playlist menu will appear in the right window.



When a Playlist is Open

Tracks recorded in a playlist are given consecutive numbers and displayed with title and artist names. When no title is present, the file name is displayed.

When a track's original storage device (USB memory, CD-ROM/DVD-ROM, etc.) is not currently connected, that track's name is grayed out on the display.

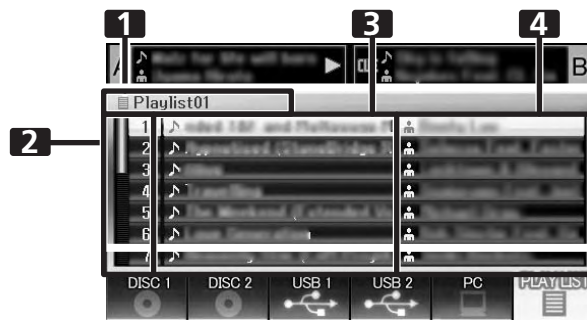

1	Playlist name
2	Consecutive number
3	Title
4	Artist name

Also, if a track is selected and the rotary selector dial is pressed, the track menu will appear in the right window.



To record tracks in a playlist

- 1 Use the cursor to select tracks or folders in a USB storage device or CD-ROM/DVD-ROM disc.
- 2 Hold the rotary selector dial depressed for one second or more.
 - The cursor will flash, and the track will be recorded in the currently open playlist.
 - The maximum number of tracks recordable in a single playlist is 150.
 - When entire folders are recorded additional time may be required.
 - The [PLAYLIST] icon will flash during recording of tracks to the playlist. A playlist cannot be opened when the tab is flashing.

NOTE

- If the connected USB storage device does not have sufficient open space, it may be impossible to record the contents of tracks on the device.

Play a track from the playlist

- 1 Open playlist.
- 2 Use the rotary selector dial to select a track, then press the LOAD A or LOAD B button.
 - Tracks will playback in consecutive numerical order.
 - New tracks can be registered and edited on the playlist even while another track is playing from the list.

START PLAYBACK (Using normal connections)

■ Changing the playlist's track order

- 1 Select the track you wish to move from the playlist.
- 2 Press the rotary selector dial.
 - A menu will appear in the right window.
- 3 Turn the rotary selector dial to select [MOVE TRACK], then press the rotary selector dial.
 - A yellow line will be displayed.
- 4 Turn the rotary selector dial to the place you wish to move the track.
- 5 Press the rotary selector dial.
 - The track selected in step 1 will be moved to before the track selected in step 4, and the display will return to the playlist.

■ To delete tracks from a playlist

- 1 Select the track you wish to delete from the playlist.
- 2 Press the rotary selector dial.
 - A menu will appear in the right window.
- 3 Turn the rotary selector dial to select [DELETE TRACK], then press the rotary selector dial.
 - The track will be deleted from the playlist.
 - A track cannot be deleted when it is set in the controller.

■ To close a playlist

- 1 When a playlist is open, press the select up (◀) button.

■ To delete a playlist

All tracks recorded in the playlist will be deleted from the playlist.

- 1 Select the name of the playlist.
- 2 Hold the rotary selector dial depressed for one second or more.

The [CANCEL], [RENAME], [ALL TRACK CLEAR] menu will appear.
- 3 Turn the rotary selector dial and select [ALL TRACK CLEAR].
- 4 Press the rotary selector dial.

All tracks recorded in the playlist will be deleted from the playlist (the playlist will be empty).

 - A track set in the controller cannot be deleted from the playlist.

■ Saving a playlist

Whenever tracks are recorded, erased, or edited in a playlist, the new playlist is automatically saved (saving occurs about five seconds after an editing operation is performed, assuming no further command input).

NOTE

- If the unit's power is turned off immediately (within five seconds) after editing a playlist, the results of the edit may not be reflected properly.

■ Editing the name of a playlist

- 1 Select the desired playlist
- 2 Hold the rotary selector dial depressed for one second or more.
 - A menu will appear on the right side of the center display.
- 3 Use the rotary selector dial to select [RENAME], then press the rotary selector dial.
- 4 Enters edit mode. Use the rotary selector dial to edit the name of the playlist.
 - A maximum of 32 characters can be input.Select up (◀) button:

Delete previous character to cursor.

Select down (▶) button:

Move cursor to next character.

Press rotary selector dial:

Save edited contents and leave editing mode.

Rotate rotary selector dial:

Select character type: Upper case → lower case → numerals → symbols
- 5 When editing is completed, press the rotary selector dial.
 - The playlist will flash, indicating that editing is completed.

MEMO

- Two-byte characters are not supported.
- For information on using a keyboard for editing, see the section "TRACK SELECTION WITH A USB KEYBOARD" (P. 30).

BASIC CONTROLLER OPERATIONS

When the center display is used to select a track and the **LOAD A** button is pressed to load the track, subsequent play operations are performed with controller A (if **LOAD B** button is pressed, the track will be loaded into controller B). When a disc is inserted, Auto Play will function.

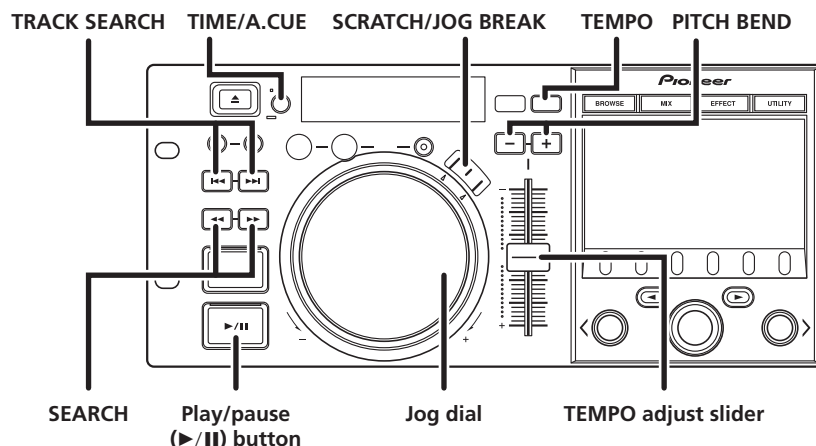

ABOUT THE DISC AUTO PLAY FUNCTION

If a disc is loaded into drive 1, if no track has previously been set in controller A, a disc track will automatically be set in controller A and playback will begin automatically.

In the same way, if a disc is loaded into drive 2 its track will be set in controller B and automatically begin playback. In the case of music CDs (CD-DA), the first track will be set; in the case of CD-ROM/DVD-ROM discs, the first track found by the unit will be set. However, if Auto Cue has been set to ON, the unit will not begin playback, but enter the cue standby mode (P. 37).

- Auto play is not supported when a USB storage device is inserted.

TO STOP PLAYBACK AND EJECT DISC

1 During playback, press the play/pause (▶/||) button, (or, if a cue point has been set, press the CUE button to perform back cue), then press the EJECT (▲) button.

- Disc rotation will stop and the disc will be ejected from the slot.
- The player is not equipped with an ordinary "stop" button.
- The EJECT (▲) button is disabled during disc playback.

TO PAUSE PLAYBACK

1 During playback, press the play/pause (▶/||) button.

- The ▶/|| button indicator and CUE button indicator will flash, and play will stop.
- To resume playback, press the play/pause (▶/||) button once again. The ▶/|| button indicator will light steadily, and playback will continue.
- If the jog mode is set to something besides SCRATCH, even during the pause mode, intermittent sound will be audible (called "audible pause"). If you wish for no sound to be audible, lower the audio mixer's output level.
- If no subsequent operation is performed for a period of 100 minutes from the time the unit is set to the pause mode, it will automatically stop disc rotation. In this event, press the play/pause (▶/||) button to resume playback.

ABOUT THE DISC RESUME FUNCTION

After ejecting a disc, if the same disc is once again inserted into the same drive, the operation condition will return to that in effect immediately before the prior eject, with the exception that jog break effect and scratch effect are not resumed.

If the **TRACK SEARCH** button is pressed before playing the same disc a second time, playback will begin after performing normal track search.

- The resume function does not support play on USB storage devices.
- The resume function is supported only when the EJECT (▲) button is used to remove a disc.
- Although the resume function is meant for disc media, when drive 1 has been ejected only the state of controller A will be resumed. Likewise, when drive 2 has been ejected, only the state of controller B will be resumed. USB storage devices and DJ software without an eject function will not be resumed.

FAST FORWARD/FAST REVERSE

■ Using the SEARCH (◀◀, ▶▶) buttons

During playback, press one of the SEARCH (◀◀, ▶▶) buttons.

- Fast forward is performed while the ▶▶ button is depressed.
- Fast reverse is performed while the ◀◀ button is depressed.

■ Super fast search

While holding one of the SEARCH (◀◀, ▶▶) buttons depressed, rotate the jog dial.

- When the dial is rotated while holding one of the SEARCH (◀◀, ▶▶) buttons depressed, the unit enters the super fast forward or super fast reverse mode.
- In the case of VBR type music files, search will be performed at normal fast-forward and fast-reverse speeds.
- The search direction follows the direction in which the jog dial is rotated. The SEARCH button pressed has no effect on the direction.
- When the jog dial rotation is stopped, playback begins.
- If the SEARCH button is released, the fast forward/fast reverse mode is canceled.
- In cases other than music CD (CD-DA), fast forward and fast reverse can be performed only within the same folder.

TRACK SKIP

■ Using the TRACK SEARCH (◀◀, ▶▶) buttons

Press one of the TRACK SEARCH (◀◀, ▶▶) buttons

- Each time the button is pressed, the player will skip to the beginning of the next track in the direction indicated by the button. (To skip to the beginning of the track preceding the current one, the ◀◀ button must be pressed twice.)
- When the button is held depressed, the player moves continuously in the direction indicated. When the button is held depressed for two seconds or more, track skip is performed at higher speed.
- If an attempt is made to continue the track skip earlier than the first track (track No. 1), the track skip will move to the last track.
- Likewise, if an attempt is made to press the ▶▶ button to continue the track skip later than the last track, the track skip will move to the first track (track No. 1).

■ Super fast track search

While holding one of the TRACK SEARCH (◀◀, ▶▶) buttons depressed, rotate the jog dial.

- While holding the button depressed, rotate the jog dial in the direction you wish to perform the track skip operation, and high-speed track skip will be performed in proportion to the amount the jog dial is turned.
- The skip direction follows the direction in which the jog dial is rotated. The TRACK SEARCH button pressed has no effect on the direction.
- The skip operation is canceled when the TRACK SEARCH button is released.

SWITCHING THE JOG MODE

Press the SCRATCH or JOG BREAK buttons.

The mode will switch to either the SCRATCH, JOG BREAK, or OFF mode. When the side with the flashing LED is pressed, the LED indicator goes out and the Jog mode is turned OFF.

JOG DIAL FUNCTION

- 1 Rotate during playback (pitch bend: when jog mode is OFF).**
 - Disc rotation will be accelerated (FWD+) or decelerated (REV-) in proportion to the degree of jog dial rotation.
 - When jog dial rotation is stopped, the disc rotation returns to its former speed.
- 2 Rotate during playback (scratch play: when jog mode is set to SCRATCH).**
See the section "SCRATCH PLAY" (P. 39).
- 3 Rotate during playback (jog break: when jog mode is set to JOG BREAK).**
See the section "JOG BREAK PLAY" (P. 39).
- 4 Rotate during pause mode (frame search).**
 - Search will be performed in one-frame increments.
 - When the jog dial is turned in the FWD+ direction at a stable speed, the playback sound (1x speed) will be output.
- 5 During cue standby, press one of the SEARCH (◀◀, ▶▶) buttons, then rotate jog dial (cue point search).**
If the button is pressed during cue standby, if the jog mode is set to something besides SCRATCH, the unit will enter "audible pause" mode, and the jog dial can be rotated to search for a cue point candidate. Following movement of the point, pressing the CUE button sets the new cue point.
- 6 During playback, rotate the jog dial while holding one of the SEARCH (◀◀, ▶▶) buttons depressed (super fast search).**
While holding the button depressed, rotate the jog dial in the direction you wish to perform the search. Search will be performed at accelerated speed, in proportion to the direction.
- 7 During playback, rotate the jog dial while holding one of the TRACK SEARCH (◀◀, ▶▶) buttons depressed (super fast track search).**
While holding the button depressed, rotate the jog dial in the direction you wish to perform the track search. Track search will be performed at accelerated speed, in proportion to the direction and amount of dial rotation.
- 8 Rotate while holding the PITCH BEND (+/-) button depressed (super fast pitch bend).**
While holding the button depressed, rotate the jog dial in the direction you wish to modify the speed; the speed will change faster than during normal pitch bend.

CHANGING THE PLAY SPEED

■ Tempo adjustment

Slide the TEMPO adjust slider forward or back.

When moved toward the front (+), the tempo becomes faster, and when moved away from you toward the rear (-), the tempo becomes slower.

- The amount (%) of tempo change is shown in the display.
- The tempo of the piece can be changed even while maintaining the same musical pitch; see "APPLYING A MASTER TEMPO".

■ Pitch bend

Press the **PITCH BEND (+)** button to increase the playback speed, and press the **(-)** button to slow the playback speed.

■ Selecting a tempo adjust range

Press the TEMPO control range button.

Each time the button is pressed, the variable range of the **TEMPO** adjust slider changes ($\pm 6\%$ / $\pm 10\%$ / $\pm 16\%$ /WIDE). When set to a variable range of $\pm 6\%$, the tempo changes in increments of 0.02%. When set to $\pm 10\%$ and $\pm 16\%$, the tempo changes in increments of 0.05%. When set to WIDE, the tempo can be changed in increments of 0.5%.

MEMO

- When playing MP3/AAC/WAV/AIFF files, the variable range is $\pm 6\%$ / $\pm 10\%$ / $\pm 16\%$ only.
- The tempo range setting is preserved in memory even when power is turned OFF.
- The variable range setting value is shown in the display.
- In the case of a track on DJ software, the tempo range will depend on the software's specifications.

APPLYING A MASTER TEMPO

During playback, press the **MASTER TEMPO** button.

- The button indicator (**MT**) will light; when the **TEMPO** adjust slider is used to adjust the speed (tempo), the pitch of the music will remain unchanged.
- The sound quality will change due to the digital processing of the audio.

SETTING CUE POINTS

By setting a cue point in memory, you can set the track to cue standby instantly merely by pressing the **CUE** button.

■ Manual cue

1 **During playback, press the play/pause (▶/||) button and pause playback around the point you wish to set as cue point.**

2 **Find the accurate cue point.**

Set the cue point using the frame number.

The cue point can be set in one-frame units (75 frames = one second).

Use the jog dial or **SEARCH (◀◀, ▶▶)** buttons to adjust the frame position. Rotating the jog dial one rotation moves playback 75 frames, while pressing **SEARCH** button once moves the playback one-frame in the designated direction.

Set the cue point while listening to the playback audio.

Rotate the jog dial slowly and return the play to the point just before the place you wish to begin playback (if the jog mode is something other than SCRATCH, the cue point will be the point immediately after the sound heard in audible pause).

3 **Once the frame number or audible sound is at the desired cue point, press the CUE button.**

- The sound will be muted, and the **CUE** button indicator will light, indicating successful setting of the cue point.
- When a new cue point is set in memory, any previously set cue point will be cleared from memory.

■ Real time cue

During playback, press the IN/CUE button at the point you wish to mark as a cue point.

This point will be recorded as a new cue point.

■ To confirm the cue point (cue point sampler)

After setting the cue point, press and hold the CUE button.

The sound at the cue point will be audible so long as the **CUE** button is held depressed.

■ To return to the cue point (back cue)

1 **During playback, press the CUE button.**

The unit will return to the set cue point and enter cue standby mode.

2 **Press the play/pause (▶/||) button.**

Playback will begin instantly from the cue point.

■ To modify a cue point (cue point modification)

1 **During playback, press the CUE button.**

The unit will return to the set cue point and enter cue standby mode.

2 **Press one of the SEARCH (◀◀, ▶▶) buttons.**

- The cue point will be moved in one-frame increments (the cue point sound will move).
- The cue point can also be moved by pressing one of the **SEARCH (◀◀, ▶▶)** buttons and then rotating the jog dial (the cue point sound will move).

3 **Press the CUE button.**

The point at which the **CUE** button is pressed forms the newly set cue point.

AUTO CUE FUNCTION

When a track is first loaded or track search is performed, this function automatically sets a cue point immediately before the point that music begins, and then sets the player to cue standby at that point.

Turning Auto Cue ON/OFF

- The auto cue function can be turned ON/OFF by holding the **TIME/A.CUE** button depressed for one second or more.
- The auto cue function is ON when the [**A.CUE**] indicator is lighted in the display.
- The status of the A.CUE function remains the same even when power is turned OFF.
- The auto cue level can be changed if desired.

Changing the Auto Cue Level

- 1 **Hold the TIME/A.CUE button depressed for five seconds or more.**

The display will show [**-60db**] (in default condition).

- 2 **Press the PITCH BEND (+, -) buttons to change the value.**

- The level can be set to one of the following values:
-36 dB, -42 dB, -48 dB, -54 dB, -60 dB, -66 dB, -72 dB, -78 dB.
- To cancel the auto cue adjust mode, either press the **TIME/A.CUE** button, or wait 15 seconds, and it will be automatically canceled.
- The selected level is preserved even when power is turned OFF.
- The auto cue level can also be changed from within the UTILITY screen.

ADVANCED OPERATIONS SECTION

LOOP PLAY

■ Create a loop.

- 1 Press the play/pause (▶/||) button to start playback.
- 2 During playback, press the IN/CUE/HOT LOOP button at the point you wish to designate as the “loop-in” point.
This step is unnecessary in the event you have a previously recorded cue point you wish to designate as a loop-in point.
- 3 During playback, press the OUT/ADJUST button at the point you wish to designate as the “loop-out” point.
Loop play will begin and continue between the loop-in and loop-out points.

■ To cancel loop play

During loop play, press the RELOOP/EXIT button.

Even after playback reaches the loop-out point, play will continue without returning to the loop-in point.

■ To change the loop-out point

- 1 During loop play, press the OUT/ADJUST button.
The time of the out point will show on the display; the OUT/ADJUST button indicator will flash rapidly, and the IN/CUE/HOT LOOP button indicator will turn off.
- 2 Press one of the SEARCH (◀◀, ▶▶) buttons or rotate the jog dial.
 - The loop-out point will move in one-frame increments.
 - Either press the OUT/ADJUST button, or wait for 30 seconds without doing anything and the adjust mode will be canceled and loop play will return.

■ During loop play, to return to the loop-in point and begin loop play again (hot loop)

During loop play, press the IN/CUE/HOT LOOP button.

Playback will return to the loop-in point and loop play will begin again.

■ To return again to a loop

During playback after canceling loop play, press the RELOOP/EXIT button.

Playback will return to the previously set loop-in point and loop play will begin again from that point (reloop play).

■ To store loop play information

During loop play, press the CUE/LOOP MEMORY button, and the current loop information will be stored in memory.

CUE POINT/LOOP POINT MEMORY

This unit can store cue points and loop points for future use. When the tracks are on discs, the cue/loop points are stored in the unit's internal memory; when the tracks are on external USB storage devices, the cue/loop points are stored in the external storage device itself.

One cue point or loop point can be stored for each track.

☑ MEMO

- This unit's internal memory is capable of storing a maximum of 2 000 discs' worth of cue/loop points (when each disc has no more than 10 cue/loop points each). When the internal memory becomes full, previously stored disc information is overwritten, beginning from disc information with the lowest usage frequency.
- If the external USB storage device has insufficient storage capacity, the cue/loop point information for the tracks on that device cannot be saved.
- Tracks in DJ software and other DJ software cannot be stored in memory.

■ Storing a cue point

- 1 Use the auto cue function or CUE button to input a cue point.
- 2 Press the CUE/LOOP MEMORY button.
The [MEMO] indicator will light, indicating that the cue point has been stored.

■ Storing a loop

- 1 Input a loop-in and loop-out point, and begin loop play.
- 2 During loop play, press the CUE/LOOP MEMORY button.
The [MEMO] indicator will light, indicating that the loop-in and loop-out points have been stored.
In the case of tracks for which cue or loop points are recorded, the [🎧] icon will change to [🎧] on the BROWSE screen.

☑ NOTE

- If a cue point differs from the loaded track, it cannot be stored.
- If the external USB storage device has insufficient storage capacity, the cue/loop point information for the tracks on that device cannot be saved.

■ To call up a stored cue point or loop

When a cue point or loop has been stored, the [MEMO] indicator will light.

- 1 Press the CUE/LOOP CALL button.
When the CUE/LOOP CALL button is pressed, the cue point or loop is called from memory, and the unit enters the standby mode at the cue or loop-in point.
- 2 Press the play/pause (▶/||) button.
Play or loop play begins.

ADVANCED OPERATIONS SECTION

■ To delete a cue point or loop information from memory

1 Press the CUE/LOOP CALL button.

When the **CUE/LOOP CALL** button is pressed, the cue point or loop information is called up, and the unit enters the standby mode at the cue or loop-in point.

2 At the cue or loop point you wish to delete, hold the CUE/LOOP MEMORY button depressed for one second or more.

The **[MEMO]** indicator will go out and the designated cue point or loop point information will be deleted.

- The information can be deleted from the BROWSE screen as well (P. 29).

SCRATCH PLAY

When the jog mode is set to **[SCRATCH]**, pressing and rotating the top surface of the jog dial will cause playback to be performed in proportion to the direction and speed of jog dial rotation.

1 Press the SCRATCH button.

The **SCRATCH** indicator will flash blue.

2 During playback, press the surface of the jog dial.

Playback will stop.

3 Rotate the jog dial in the direction and at the speed you wish for playback to occur.

Playback will begin in the direction and at the speed corresponding to the jog dial input.

4 Release hand from surface of jog dial.

Playback will return to its original speed.

SPIN PLAY

During playback with the jog mode set to **[SCRATCH]**, either press the surface of the jog dial or the play/pause (▶/⏸) button to set the pause mode, then rotate the jog dial quickly; playback will proceed in response to the direction and speed of jog dial rotation, even if you remove your hand from the dial.

JOG BREAK PLAY

When the jog mode is set to **[JOG BREAK]**, the pressing and rotating the surface of the jog dial causes effects to be applied to the sound in proportion to the direction of rotation and rotation speed.

1 Press the JOG BREAK button.

The **JOG BREAK** indicator will flash red.

2 During playback, touch and press the surface of the jog dial.

3 Rotate the jog dial.

4 Release hand from surface of jog dial.

The effect will stop and sound will return to its original condition.

- Jog break play is not enabled when DJS or other DJ software tracks are loaded.

EFFECT SCREEN

When the **EFFECT** button is pressed, the center display will show the EFFECT screen, providing graphic expression to assist with scratch play and jog break play.



[1] Scratch effect

When the jog mode is set to **[SCRATCH]**, the screen on the controller side switches to scratch effect mode.

A blue ball will rotate in response to the track playback.

- The ball normally rotates to the right. When playback direction changes, the ball reverses direction, and when playback stops, the ball's rotation also stops.

1 During playback, press one of the function buttons [SCRATCH/TRANS/BUBBLE].

ADVANCED OPERATIONS SECTION

About SCRATCH

For more information, refer to the item "SCRATCH PLAY".



MEMO

- When DJS or other DJ software tracks are set, only SCRATCH is supported as a scratch effect. The display in that case will appear as shown below. (Depending on the DJ software used, SCRATCH may not be supported as well. For details, consult the author of your DJ software.)



About TRANS

This produces an effect like temporarily muting the sound with the mixer's cross fader. In linkage with the effect, the ball on the screen flashes while rotating.



About BUBBLE

This effect simulates the bubble scratch technique. In linkage with the effect, the ball on the screen undulates to right and left while rotating.



[2] Jog break effect

When jog mode is set to [JOG BREAK], the screen on the controller side switches to jog break effect mode.

MEMO

- The jog break effect mode is not supported when DJS or other DJ software tracks are loaded.

1 During playback, press one of the function buttons [JET/ROLL/WAH].

- The selected effect is shown in the center display, and the respective effect is changed in response to the rotation of the jog dial.

2 Effect HOLD

- Normally, when you remove your hand from the jog dial the current effect stops and the also returns to its original status. By pressing the select up (◀) button is pressed on controller A, or the select down (▶) button on controller B, even if the hand is removed from the jog dial, the effect responding to the current position of the jog dial is maintained (HOLD function). When the button is pressed again, the function returns to normal.
- During HOLD, the **JOG BREAK** indicator will light red, and the screen's [HOLD ON] indicator will light.

About JET

Delay time is changed in response to the jog dial rotation and a short delay is mixed with the playback sound, thus producing interference between the two sounds and resulting in a jet-like "SCHWA—" sound effect.

In linkage to the effect the JET image animation is displayed (WAVE display)

MEMO

- When you remove your hand from the jog dial, sound will gradually return to the original sound.



About ROLL

In response to the rotation of the jog dial, the pitch and playback time are changed, and effect applied to the playback sound.

MEMO

- The sound playing at the time the jog dial is touched is continuously looped and roll is applied.
- When you remove your hand from the jog dial, the playback returns to the original sound.
- In linkage to the effect, the ROLL image animation will be displayed (a ball in orbit will appear; the orbit of the ball and its speed will change in response to the rotation position and direction of the jog dial.)



ADVANCED OPERATIONS SECTION

About WAH

This function applies a filter that changes the cutoff frequency in response to the rotation of the jog dial.

In linkage to the effect, the WAH image animation is displayed (the line slides right-left in response to the rotation direction of the jog dial).

MEMO

- When the dial is rotated clockwise, a high-pass filter is applied; when rotated counter-clockwise, a low-pass filter is applied.
- When you remove your hand from the jog dial, sound will gradually return to the original sound.



[3] Effect off

When jog mode is set to OFF (neither of the **SCRATCH/JOG BREAK** button indicators is lighted), the effect off mode is enabled. This mode supports pitch bend (P. 35) and audible pause function.



MIX SCREEN

When the **MIX** button is pressed, the MIX screen appears in the center display, allowing easy mixing and playback of tracks.

MEMO

- The MIX function is disabled when a DJ software track is set in the controller.



1 Playlist display	The playlist menu is displayed. When a playlist is selected for mixing, it appears as an orange icon.
2 MIX mode select	Use function buttons to select MIX mode.
3 BPM SYNC	Automatic BPM synchronization when performing MIX. Use function button to alternate ON/OFF.
4 AUTO MIX	Automatic playback for the selected playlist. Use function button to alternate ON/OFF.

AUTO MIX

Sets the AUTO MIX function ON/OFF.

When AUTO MIX is set to ON, playback of the selected playlist continues automatically.

MEMO

- When AUTO MIX is turned ON, the auto cue function will also turn on automatically. While in this state, the auto cue function cannot be turned off.

■ BPM SYNC

Sets the BPM SYNC ON/OFF.

When BPM SYNC is set to ON, the tempo of the next track is automatically adjusted to match the BPM of the currently playing track.

MEMO

- The tempo will not change if the tempo variable range is exceeded (music CD [CD-DA] $\pm 100\%$, MP3/AAC/WAV/AIFF: $\pm 16\%$).

■ MIX mode select

CUT-IN

Playback of the currently playing track stops and switches instantly to the next track.

ZIP

The pitch of the currently playing track gradually decreases until it can no longer be heard, at which point playback of the next track begins.

ECHO

One beat of sound continues repetitively and fades until it can no longer be heard, at which point playback of the next track begins.

CROSS FADE

The currently playing track fades out as playback of the next track fades in; when the fade out / fade in is completed, the track changes.

MEMO

- If none of the MIX modes is selected, one of the four (CUT-IN, ZIP, ECHO, CROSS FADE) will be selected at random.

■ Instant Change Function

Using the instant change function, you can switch from the currently playing track to another desired track at the timing of your choice.

1 While one track is playing, setup the next track.

Load a track on the controller opposite the one currently playing, and set to cue standby.

MEMO

- Tracks can be set not only from the BROWSE screen, but from the MIX screen as well. With a playlist opened on the MIX screen, rotate the rotary selector dial; the cursor will appear and both **LOAD** buttons will flash. In this condition, press the **LOAD** button and the track selected by the cursor will be set in either controller A or B.

2 Press the MIX button.

The MIX screen will appear in the center display.

The **LOAD** button for the controller on cue standby will flash.

3 Select the desired MIX mode.

Press the function button to select the MIX mode.

If none of the MIX modes is selected, one of the four modes will be selected at random.

4 Press the flashing LOAD button.

The playback will switch by the selected MIX mode.

MEMO

- If the flashing **LOAD** button is pressed again while the tracks are still changing, the track mixing will be canceled.

■ Automatic Playlist Playback

This function allows previously selected playlist to be selected and automatic playback to commence in the order by which the tracks are recorded, alternating between controllers A and B.

- 1 Press the MIX button.**
The MIX screen appears in the center display.
- 2 Rotate the rotary selector dial to select a playlist, then press the select down (▶) button to open the playlist.**
The opened playlist will be selected for MIX.
- 3 Select the desired MIX mode**
Use the function buttons to select the MIX mode.
If none of the mix modes is selected, one of the four modes will be automatically selected at random.
- 4 Rotate the rotary selector dial, and load the first track of the playlist to controller A, the second track to controller B, and set to cue standby.**
The tracks will be loaded in controllers A/B, and the unit will enter the cue standby mode.

✓ MEMO

- If no tracks are set in controllers A/B, they will be set automatically in step 5.

- 5 Press the [AUTO MIX] function button to set to ON.**
If no track is loaded, the playlist's first track will be set on controller A, the second track on controller B, and both set to cue standby.
- 6 Press the play/pause (▶/II) button for controller A.**
The track loaded on controller A will begin playback, and AUTO MIX will begin.
Thirty seconds before the end of playback, playback will switch to the track set in controller B, using the selected MIX mode.

✓ MEMO

- The instant change function can be used if desired to switch playback even while a track is still playing.

- 7 Press the [BPM SYNC] function button to set to ON.**
Set BPM SYNC to ON if you wish to synchronize the tempos of successive tracks.

✓ MEMO

- During auto play, you can interrupt the playback order by using the BROWSE screen to load a track into the standby controller.

ABOUT FADER START PLAY

When the accessory control cord is used to connect this unit's CONTROL jack to the CONTROL jack of a Pioneer DJ mixer, when the DJ mixer's channel fader lever is raised, the player's CUE standby mode is released and playback begins immediately. The player's fader start can also be performed by operating the cross fader lever.

Also, the player can be returned to the cue point (back cue operation) by returning the fader lever to its original position (except during auto play).

ABOUT DJS SOFTWARE

Pioneer DJS is a software program that allows the use of MP3 files to control DJ play from a computer. Load the program into your computer from the supplied CD-ROM disc.

 **MEMO**

- DJS is not equipped with functions for recording DJ play.

SOFTWARE END USER LICENSE AGREEMENT

This Software End User License Agreement ("Agreement") is between you (both the individual installing the Program and any single legal entity for which the individual is acting) ("You" or "Your") and PIONEER CORPORATION ("Pioneer").

TAKING ANY STEP TO SET UP OR INSTALL THE PROGRAM MEANS THAT YOU ACCEPT ALL OF THE TERMS OF THIS LICENSE AGREEMENT. PERMISSION TO DOWNLOAD AND/OR USE THE PROGRAM IS EXPRESSLY CONDITIONED ON YOUR FOLLOWING THESE TERMS. WRITTEN OR ELECTRONIC APPROVAL IS NOT REQUIRED TO MAKE THIS AGREEMENT VALID AND ENFORCEABLE. IF YOU DO NOT AGREE TO ALL OF THE TERMS OF THIS AGREEMENT, YOU ARE NOT AUTHORIZED TO USE THE PROGRAM AND MUST STOP INSTALLING IT OR UNINSTALL IT, AS APPLICABLE.

1 DEFINITIONS

- 1.1 "Documentation" means written documentation, specifications and help content made generally available by Pioneer to aid in installing and using the Program.
- 1.2 "Program" means all or any part of Pioneer's software licensed to You by Pioneer under this Agreement.

2 PROGRAM LICENSE

- 2.1 Limited License. Subject to this Agreement's restrictions, Pioneer grants to You a limited, non-exclusive, non-transferable, license (without the right to sublicense):
 - (a) To install a single copy of the Program on the hard disk drive of Your computer, to use the Program only for Your personal purpose complying with this Agreement and the Documentation ("Authorized Use");
 - (b) To use the Documentation in support of Your Authorized Use; and
 - (c) To make one copy of the Program solely for backup purposes, provided that all titles and trademark, copyright and restricted rights notices are reproduced on the copy.
- 2.2 Restrictions. You will not copy or use the Program or Documentation except as expressly permitted by this Agreement. You will not transfer, sublicense, rent, lease or lend the Program, or use it for third-party training, commercial time-sharing or service bureau use. You will not Yourself or through any third party modify, reverse engineer, disassemble or decompile the Program, except to the extent expressly permitted by applicable law, and then only after You have notified Pioneer in writing of Your intended activities. You will not use the Program on multiple processors without Pioneer's prior written consent.
- 2.3 Ownership. Pioneer or its licensor retains all right, title and interest in and to all patent, copyright, trademark, trade secret and other intellectual property rights in the Program and Documentation, and any derivative works thereof. You do not acquire any other rights, express or implied, beyond the limited license set forth in this Agreement.
- 2.4 No Support. Pioneer has no obligation to provide support, maintenance, upgrades, modifications or new releases for the Program or Documentation under this Agreement.

3 WARRANTY DISCLAIMER

THE PROGRAM AND DOCUMENTATION ARE PROVIDED "AS IS" WITHOUT ANY REPRESENTATIONS OR WARRANTIES, AND YOU AGREE TO USE THEM AT YOUR SOLE RISK. TO THE FULLEST EXTENT PERMISSIBLE BY LAW, PIONEER EXPRESSLY DISCLAIMS ALL WARRANTIES OF ANY KIND WITH RESPECT TO THE PROGRAM AND DOCUMENTATION, WHETHER EXPRESS, IMPLIED, STATUTORY, OR ARISING OUT OF COURSE OF PERFORMANCE, COURSE OF DEALING OR USAGE OF TRADE, INCLUDING ANY WARRANTIES OF MERCHANTABILITY, FITNESS FOR A PARTICULAR PURPOSE, SATISFACTORY QUALITY, ACCURACY, TITLE OR NON-INFRINGEMENT.

4 DAMAGES AND REMEDIES FOR BREACH

You agree that any breach of this Agreement's restrictions would cause Pioneer irreparable harm for which money damages alone would be inadequate. In addition to damages and any other remedies to which Pioneer may be entitled, You agree that Pioneer may seek injunctive relief to prevent the actual, threatened or continued breach of this Agreement.

5 TERMINATION

Pioneer may terminate this Agreement at any time upon Your breach of any provision. If this Agreement is terminated, You will stop using the Program, permanently delete it from the computer where it resides, and destroy all copies of the Program and Documentation in Your possession, confirming to Pioneer in writing that You have done so. Sections 2.2, 2.3, 2.4, 3, 4, 5 and 6 will continue in effect after this Agreement's termination.

6 GENERAL TERMS

- 6.1 Limitation of Liability. In no event will Pioneer or its subsidiaries be liable in connection with this Agreement or its subject matter, under any theory of liability, for any indirect, incidental, special, consequential or punitive damages, or damages for lost profits, revenue, business, savings, data, use, or cost of substitute procurement, even if advised of the possibility of such damages or if such damages are foreseeable. In no event will Pioneer's liability for all damages exceed the amounts actually paid by You to Pioneer or its subsidiaries for the Program. The parties acknowledge that the liability limits and risk allocation in this Agreement are reflected in the Program price and are essential elements of the bargain between the parties, without which Pioneer would not have provided the Program or entered into this Agreement.
- 6.2 The limitations or exclusions of warranties and liability contained in this Agreement do not affect or prejudice Your statutory rights as consumer and shall apply to You only to the extent such limitations or exclusions are permitted under the laws of the jurisdiction where You are located.
- 6.3 Severability and Waiver. If any provision of this Agreement is held to be illegal, invalid or otherwise unenforceable, that provision will be enforced to the extent possible or, if incapable of enforcement, deemed to be severed and deleted from this Agreement, and the remainder will continue in full force and effect. The waiver by either party of any default or breach of this Agreement will not waive any other or subsequent default or breach.

- 6.4 No Assignment. You may not assign, sell, transfer, delegate or otherwise dispose of this Agreement or any rights or obligations under it, whether voluntarily or involuntarily, by operation of law or otherwise, without Pioneer's prior written consent. Any purported assignment, transfer or delegation by You will be null and void. Subject to the foregoing, this Agreement will be binding upon and will inure to the benefit of the parties and their respective successors and assigns.
- 6.5 Entire Agreement. This Agreement constitutes the entire agreement between the parties and supersedes all prior or contemporaneous agreements or representations, whether written or oral, concerning its subject matter. This Agreement may not be modified or amended without Pioneer's prior and express written consent, and no other act, document, usage or custom will be deemed to amend or modify this Agreement.
- 6.6 You agree that this Agreement shall be governed and construed by and under the laws of Japan.

COPYRIGHT WARNING

- The use of DJS is restricted with regard to the playing and copying of copy-protected music contents.
- The program may not operate properly if copy-protect encryption data is embedded in recorded media.
- Ripping, playback, and other operations may stop if copy-protect encryption data is detected to be embedded in recorded media.
- The materials you record are for your own listening enjoyment, and cannot be used for other purposes without permission from the copyright owner.
- Music recorded from CDs and other media may be protected by the copyright laws of individual countries as well as by international convention. You are solely responsible for the lawful use of the recordings you make.

SYSTEM REQUIREMENTS (Minimum Operating Environment)

Running DJS requires a PC/AT computer with the following operating environment:

CPU: 1.5 GHz or more Intel® Pentium M® (or compatible) processor.

However, in the case of Windows Vista®, the processor must be a 1.5 GHz or above Intel Core™2 Duo (or compatible).

Memory:

512 MB or more RAM

However, when running Windows Vista®, 1 GB or more RAM

Hard disc:

250 MB of free HD space (excluding space necessary for storing MP3 and other music files)

Optical drive:

Disc drive capable of reading CD-ROM, and playing music CD (CD-DA)

Display:

XGA (1024x768) or above, with HighColor (16-bit) or greater video adapter and monitor.

Sound:

2-channel or more audio output (internal or external sound card or audio unit).

Input device:

Keyboard, mouse (or equivalent pointing device)

Internet connection:

Connection speed 56 kbps or above recommended. Microsoft® Internet Explorer 5.5 or above, or other web browser supporting 128-bit SSL.

- When this unit (MEP-7000) is connected to a computer and used in conjunction with the DJS software, the computer must be equipped with a USB port complying with USB 1.1 or later. For details, consult the section "CONNECTIONS" (P. 16).

 **NOTE**

- Full functionality is not guaranteed with all computers even when the above operating environment conditions are fulfilled.
- Even if your computer is equipped with the memory capacity specified in the operating environment noted above, other software and services running in the computer at the time may cause insufficient memory that can result in degradation of the program's functions or performance. In this case, close any other services or programs running so as to free up more of your computer's memory, or increase the amount of memory installed in your computer.
- Depending on your computer's power saving settings and other factors, it may not be possible for your computer to achieve its optimum CPU and/or hard-disk processing capacity. Especially when using a laptop computer, make sure to utilize external AC power sources to ensure high-performance settings of the computer while using the DJS.
- DJS operation may not function properly when combined with other software programs installed on your computer.
- The DJS software program is not supported by Macintosh computers (including those equipped with Intel CPUs).

INSTALLING DJS SOFTWARE

■ Precautions regarding installation

- Before installing DJS, please read the "SOFTWARE END USER LICENSE AGREEMENT" and "SYSTEM REQUIREMENTS (Minimum Operating Environment)".
- DJS is supported by the following Microsoft® Windows® versions:
 - Windows Vista® Home Basic
 - Windows Vista® Home Premium
 - Windows Vista® Ultimate
 - Windows Vista® Business
 - Windows® XP Home Edition (SP2 or later)
 - Windows® XP Professional (SP2 or later)
 - Windows® 2000 Professional (SP4)
- DJS is not supported by Microsoft's 64-bit operating systems (Windows®XP Professional x64 edition and Windows Vista® 64-bit editions).
- The accessory CD-ROM includes installation programs and user's manuals in the following eight languages: English, French, German, Italian, Dutch, Spanish, Chinese (simplified Mandarin), Japanese.
- When using DJS on a computer whose Windows® display language is other than one of those listed above, follow the menu instructions to select **[English]**.
- Installation and uninstallation of DJS require administrator's rights on the computer concerned. You must log on as administrator before installing the software.

■ Installation Procedure

- 1 When the accessory CD-ROM installation disc is loaded in your computer's DVD/CD drive, the installation menu will automatically appear. Follow the menu instructions to install the DJS software.
 - If the installation menu does not automatically appear, click on **[START]** → **[My Computer (or Computer)]** and select the optical disc drive, and double click on the **[Install]** icon.
- 2 When the installation menu appears, click on the **[Install DJS]** button.



- If a trial version of DJS is currently installed on the computer, in place of the **[Install DJS]** button, the **[Uninstall DJS trial version of DJS]** button will appear. Click on that button to uninstall the trial version, then once again click on the **[Install DJS]** button.
- To display the user's manual, click on the **[Display DJS User's Manual]** button. Adobe Reader® is required to display the user's manual.
- To install Adobe Reader®, click on the **[Install Adobe Reader]** button. If your computer already has an older version of Adobe Reader® installed, uninstall the older version of Adobe Reader® before clicking on the **[Install Adobe Reader]** button.
- To close the installation menu, click on the **[Exit]** button.

- 3 When the screen for selecting the language appears, select [English], then click on [OK].



- Depending on your computer operating environment, more than one language may be available.
- When you click on the [OK] button, the [Preparing to install DJS...] message will appear.

When preparations are completed, the [Commencing installation of DJS...] message will appear. Follow the instructions in the message to complete DJS installation.

- To cancel installation, click on the [Cancel] button.
- 4 When DJS installation is completed, reboot the computer in accord with the instructions that appear on the screen.

MEMO

- When using this unit (MEP-7000) in conjunction with the DJS software program, the software driver must be installed in the computer before connecting the computer to the MEP-7000. For details, see P. 50

■ DJS User's Manual (PDF)

When installation of DJS is completed, the user's manual can be viewed from the Windows [START] menu if desired. Click on [START] → [View All Programs] → [DJS] → [User's Manual].

It is recommended to read the user's manual in order to gain a basic understanding of DJS features before actually starting the program.

NOTES REGARDING TRIAL PERIOD AND USER REGISTRATION

DJS can be used without registration for a 60-day trial period after installation.

This period represents the time you can use DJS without officially registering it. When the trial period is over, DJS can no longer be used, so be sure to complete user registration before that period has elapsed.

- Online registration can be completed for users connected to the Internet. For details regarding user registration procedures, consult the DJS user's manual contained on the accessory CD-ROM disc.
- The Pioneer Group collects personal user information for the following purposes:
 1. To provide after service for the product.
 2. To inform users via email of important information and events regarding the product.
 3. To collect survey data from customers and reflect those results into product development.
- Personal information collected from customers is handled and managed in accordance with our personal information privacy policy.
- For more information regarding Pioneer's personal information privacy policy, see the following Pioneer website:
<http://www.prodjnet.com/privacy.html>
- Users without Internet connections should enter the necessary information on the "User registration card" and return it via mail to Pioneer. After the completed "User registration card" is received, we will send the "Registration ID" (installation key) necessary for unlocking the software beyond the trial period. For

detailed instructions regarding the user registration procedure, please consult the DJS user's manual included in the accessory CD-ROM.

NOTE

- An installation key (Registration ID) can be used on the DJS software installed on a single computer. In the event you replace your computer or otherwise need to reinstall the DJS software, a new user's registration and "Registration ID" must be issued to unlock the software beyond the trial period. Also, the initial "Registration ID" issued by Pioneer will be needed in the event of reregistration or after-service enquiries, so be sure to store the registration information in a safe place even after completion of the registration procedure.

- The address on the "User registration card" is as follows. The address may differ depending on your location of residence, however, so please be careful to send the card to the correct location:

<User Registration Card Address>

North America
PIONEER ELECTRONICS (USA) INC.
BUSINESS SOLUTIONS DIVISION, PRO AUDIO GROUP
2265 East 220th Street, Long Beach, CA 90810, U.S.A

REGARDING ONLINE SUPPORT

Before making direct enquiries regarding DJS operating procedures and other technical matters, please read the DJS user's manual furnished on the accessory CD-ROM, together with the FAQ section on the DJS support website.

- See the DJS user's manual for information regarding how to access the DJS support website. To access the support site, you will need the "Login name" and "Password" which you specified at the time of user registration.
- When making an enquiry to the DJS support website regarding malfunctions, please furnish your name, product name, registration ID (install key), computer type and specifications (CPU, installed memory, other connected peripherals, etc.), the operating system and version used, and concrete information regarding the symptoms observed.
- Support is furnished only to customers who have completed the user registration process. Please take care to safely preserve the "Login name" and "Password" you specified during registration, as well as your "Registration ID."
- If you experience problems with installation or user registration, please consult the following website:
<Enquiries regarding installation and user registration>
<http://www.prodjnet.com/djs/support/>

NOTE

- For technical information regarding use of this unit with your computer, peripheral components, or other non-Pioneer products, please consult your sales dealer or the manufacturers of the respective components.
- Further version updates are anticipated to improve the functionality and performance of DJS.
Officially registering this product allows you to access Pioneer's support website, as well as to download updated versions of the program. We encourage users to take advantage of this update service to constantly utilize the latest version of the program.

DISCLAIMER

- Pioneer shall not be held responsible for reissuing license keys or registration IDs in the event of loss. Be sure to store your registration information and passwords safely in a separate location for future access.
- The music CD ripping function of this software program is not supported for music CD that do not display one of these logo marks.



ABOUT THE DRIVER PROGRAM

This unit is designed to control Pioneer DJ software when connected to a computer. When connecting this unit to a Windows computer for use with DJ software, the software driver program must first be loaded into the computer.

MEMO

- When using a computer with Mac OS installed, download and install the special driver software provided at Pioneer's website (listed below).
- Pioneer's website (listed below) provides up-to-date information on the driver software.
<http://www.prodjnet.com/support/>

SOFTWARE END USER LICENSE AGREEMENT

When installing or using the driver software, be sure to first read the "SOFTWARE END USER LICENSE AGREEMENT" (P. 45). By installing and using the software, you agree to be bound by the terms of the Agreement.

DRIVER INSTALLATION

Before installing (IMPORTANT)

- Before installing this driver, be sure to read the "SOFTWARE END USER LICENSE AGREEMENT".
- This unit can be connected to a computer running one of the following operating system environments:
Windows Vista® Home Basic, Windows Vista® Home Premium, Windows Vista® Ultimate, Windows Vista® Business, Windows® XP Home Edition, Windows® XP Professional, or Windows® 2000 Professional.
It may be necessary to use the Windows update facility in order to install the most recent Service Pack.
- The driver installation program is provided in 10 languages (English, French, German, Italian, Dutch, Spanish, Russian, Chinese (simplified), Chinese (traditional), and Japanese). If using a version of Windows in another language, follow the onscreen instructions to select **[English]** as the language.
- You must have administrator privileges on your computer in order to install the driver software. Log on as the user set as the computer's administrator before attempting driver installation.
- If any other Windows programs are running, close them before beginning driver installation.

NOTE

- Before installing the driver software, turn off this unit's **POWER** switch and disconnect any USB cables connecting this unit to the computer.
- If this unit is connected to a computer without first installing the driver, errors may occur on the computer, depending on the computer environment involved.
- In the event the driver installation is interrupted midway through, follow the procedures below to reinstall the driver from the beginning.

Using the accessory CD-ROM to install the application

- 1 Boot the computer and log in with administrator's privileges.
- 2 Load the accessory CD-ROM in the computer's CD/DVD drive.
- 3 Open the computer's [START] → [My Computer (or Computer)] menu, then access the CD-ROM and double-click on the folder [MEP-7000].
- 4 After opening the [MEP-7000] folder, double click on the driver installation program [MEP-7000[SEP-C1]_#.###.exe]. (#.### indicates the driver version.)
- 5 When the [Language Selections] menu appears, select [English], then click on [OK].



- To interrupt the installation process, click on the **[Cancel]** button.

- 6 When the [License] screen appears, read the "Software End User License Agreement", click on the [I agree.] box, then click on [OK].

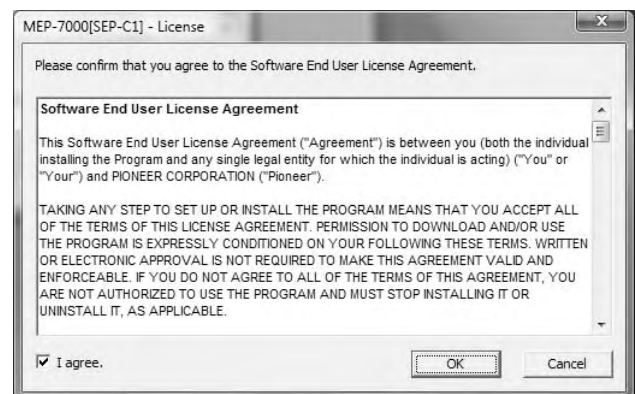

- If you do not agree with the terms of the "Software End User License Agreement", click on the **[Cancel]** button to terminate the installation.

ABOUT THE DRIVER PROGRAM

7 Follow the instructions that appear on the screen.

- If the [Windows Security] screen appears during installation, click on [Install this driver software anyway] to continue the installation process.

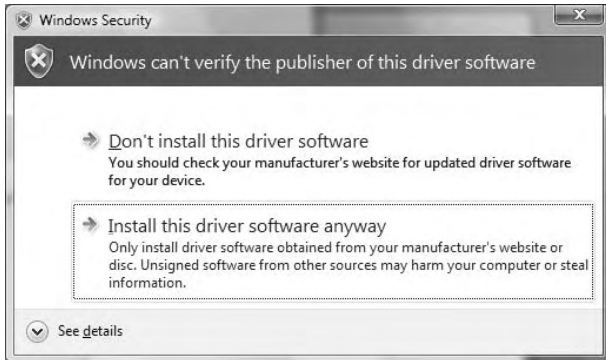

<For Windows XP>

- If the [Hardware Installation] screen appears during installation, click on [Continue Anyway] to continue the installation process.



<For Windows 2000>

- If the [Digital Signature Not Found] screen appears during installation, click on the [Yes] button to continue the installation process.



- ## 8 When installation is completed, the [Installation is now complete.] message will appear. Click on the [Finish] button to complete the process.

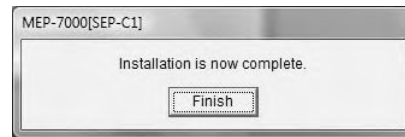

■ Connecting this unit to the computer

- ### 1 Use the accessory dedicated remote control cables to connect the drive unit to the control unit.



NOTE

- Insert firmly until you hear a click.

- ### 2 Use USB cable to connect the drive unit to the computer, then turn the drive unit's power ON.

When first connecting this unit to the computer, and when disconnecting and reconnecting the computer USB port, the computer may display the message [Installing device driver software]. In this case, wait until the computer displays the message [Your devices are ready to use].

<For Windows XP>

- During the installation process, if the computer displays the message [Can Windows connect to Windows Update to search for software?] select [No, not this time], then click on the [Next] button to continue the installation process.



- During installation, if the computer displays the message [What do you want the wizard to do?] select [Install the software automatically (Recommended)], then click on the [Next] button to continue the installation process.



ABOUT THE DRIVER PROGRAM

- If the [Hardware Installation] screen appears during installation, click on [Continue Anyway] to continue the installation process.



<For Windows 2000>

- If the [Digital Signature Not Found] screen appears during installation, click on the [Yes] button to continue the installation process.

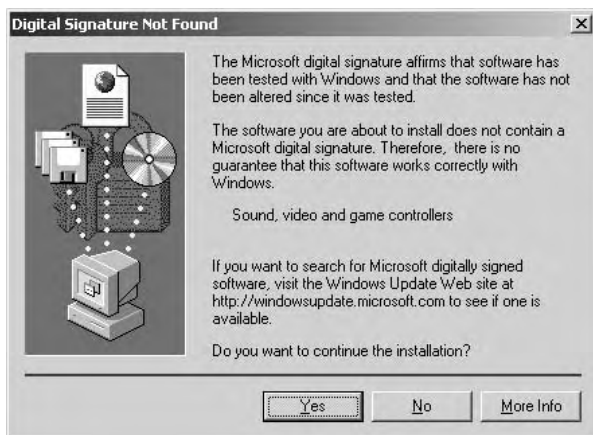

■ Setting the buffer size

The MEP-7000's drive unit has been designed as an audio device compliant with ASIO (Audio Stream Input Output) standards.

To adjust the buffer size of the device, click on Windows [START] → [View All Programs] → [Pioneer] → [MEP-7000[SEP-C1]] → [MEP-7000 ASIO Settings Utility].

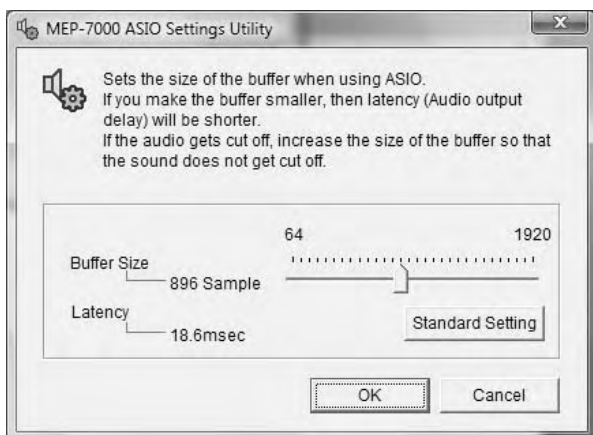

☑ NOTE

- Setting the buffer size to a higher value will help prevent audio dropouts (interrupted sound), but the resulting audio data latency may result in increased time lags.
- If the computer is currently running a program (DJ software, etc.) that uses this unit as a default audio device, close the program and then adjust the buffer size.

■ Confirming the driver version

To confirm the version of the loaded driver, click on Windows [START] → [View All Programs] → [Pioneer] → [MEP-7000[SEP-C1]] → [MEP-7000[SEP-C1] Version Display Utility].

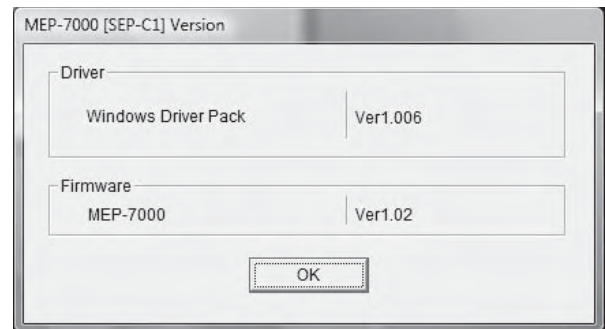

☑ MEMO

- This screen also allows you to confirm the version of the firmware currently installed in this unit. However, the firmware version will not be displayed if the unit is not connected to a computer, or if the computer is not communicating properly with the unit.
- The firmware version displayed on this screen as the unit's firmware will be either the control unit's firmware or the drive unit's firmware, whichever is older.

■ Most recent version of driver

Consult the following website regarding the latest driver versions.
<http://www.prodjnet.com/support/>

■ When using this unit to control DJS software

Please read the sections "USING DJ SOFTWARE" (P. 53) and the "DJS Control Guide" (PDF file) before attempting to actually use this unit to operate DJS. The "DJS Control Guide" can be found under the name [manual_MEP-7000_control_en.pdf] in the [MEP-7000\English] folder of the accessory CD-ROM.

USING DJ SOFTWARE

By loading the accessory DJS software or another DJ software to a computer connected to this player via USB cable, the player can be used to operate the DJ software program.

Supported DJ softwares

DJS	Included as an accessory with the MEP-7000, the all-in-one DJ software program "DJS" allows immediate use of DJ software.
Communication-supported DJ software	Commercially available DJ softwares supporting the MEP-7000's dedicated communications protocol can be operated even without the use of a control disc. For latest information regarding supported DJ software, please consult the following Pioneer website: http://www.prodjnet.com/support/
MIDI-supported DJ software	The MEP-7000 outputs data regarding button and TEMPO adjust slider status in universal MIDI format, so DJ softwares with MIDI support can be used to assign the unit's MIDI messages, thus using the MIDI communication for control.

Two Styles of Play

This player can be connected to a computer using either of the methods shown below.

Normal Style

The playing setup whereby the MEP-7000 operates with the control unit and drive unit as a set is called "normal style." In normal style play, when using a DJ software program, the MEP-7000's drive unit is connected to a computer via a USB cable. The DJ software program is allocated as a source on the BROWSE screen the same as discs and USB storage devices, and switching between these sources is performed on the unit's center display. By designating the MEP-7000 as an audio output device, it becomes unnecessary to use a mixer to switch between two sound sources, allowing seamless DJ play impossible until now. (Designation of the MEP-7000 as an audio output device is supported only by DJS and certain other DJ software programs.)

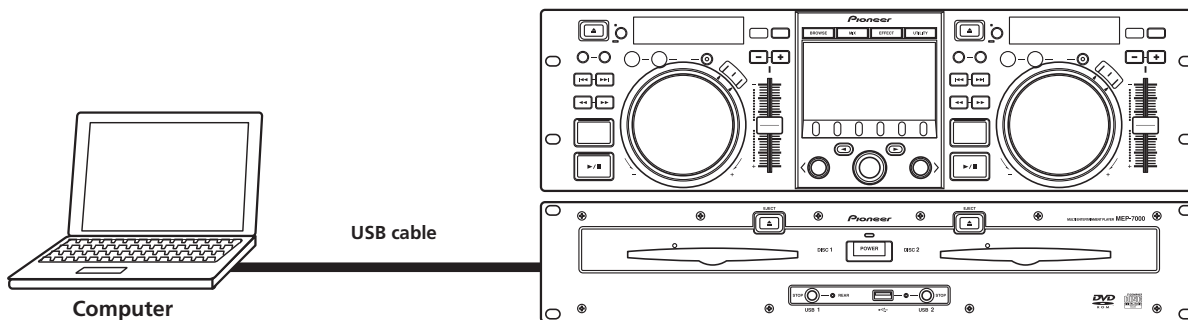

Manipulator Style

The playing setup whereby the MEP-7000's control unit is made to operate as the DJ software program's manipulator is called "manipulator style." When the MEP-7000 is used as a manipulator, you can control your DJ software without need for either mouse or keyboard, using the same layout, functions, and ease of operation transmitted from the Pioneer CDJ series.

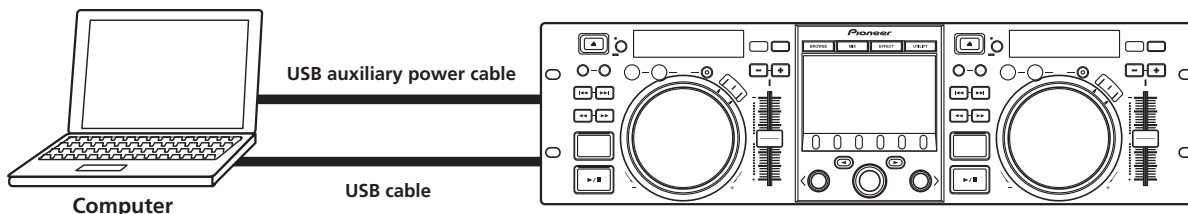

PREPARING YOUR DJ SOFTWARE PROGRAM

Before using your DJ software program, you must prepare your computer and the DJ software. Do not connect the MEP-7000 to your computer until you have loaded the software driver!

Step	Normal Style	Manipulator Style	DJS	Dedicated communication-supported DJ software	MIDI-supported DJ software
Confirm computer's setup and operating environment.	●	●	See P.44 of this manual ("ABOUT DJS SOFTWARE"). Computer operating system support is limited to Windows Vista, Windows XP or Windows 2000. DJS supports only the Microsoft Windows OS.	Consult the instruction manual for your DJ software. Computer operating system support is limited to Windows Vista, Windows XP or Windows 2000 (For those using a Mac OS, 10.3.9 or later).	
Turn on computer power.	●	●		Consult the instruction manual for your DJ software.	
Install the driver.	●	●	See P.49 of this manual ("ABOUT THE DRIVER PROGRAM").		
Connect the MEP-7000 to your computer.	●	●	See P.15 of this manual ("CONNECTIONS"). See P.17 for Normal Style connections and P.18 for Manipulator Style connections.		
Turn on power to the MEP-7000.	●	●			
Adjust the buffer size (ASIO).	●	●	See P.51 of this manual ("ABOUT THE DRIVER PROGRAM, ■ Setting the buffer size")		
Confirm "Correct USB connection to computer?".	●	●	See P.51 of this manual ("ABOUT THE DRIVER PROGRAM, ■ Confirming the driver version").		
Install the DJ software program.	●	●	See P.44 of this manual ("ABOUT DJS SOFTWARE")	Consult the instruction manual for your DJ software.	
Startup the DJ software.	●	●	See the DJS User's Manual (PDF file on accessory CD-ROM).		
Set audio output device.	●	●	See the DJS Control Guide (PDF file on accessory CD-ROM).		
Operate for DJ play.	●	●	See the DJS Control Guide for basic operating techniques. * For information regarding center display screen's status and combined play with other music sources (Normal Style), see this manual.		

MEMO

- Special driver software must be installed on your computer when using the DJ software. When using a computer with Windows installed, install the special driver software found on the supplied CD-ROM (When using a computer with Mac OS installed, download and install the special driver software provided at Pioneer's website (listed below)).
- Pioneer's website (listed below) provides up-to-date information on the driver software.

<http://www.prodjnet.com/support/>

CONTROLLING YOUR COMPUTER USING THE DEDICATED COMMUNICATIONS PROTOCOL

The MEP-7000 can be used to control not only the accessory DJS software, but other DJ software programs supporting the MEP-7000's dedicated communications protocol.

Control in "Normal Style"

1 Connect to the computer.

When the USB connection with the computer is properly established, the BROWSE screen's [PC] icon will change to active display.



2 Start the DJ software program.

The icon will not change.

For DJS:

When communication with DJS begins, the icon will change to the [PC DJS] icon.



3 Designate the MEP-7000 as an audio output device in the DJ software.

In "Normal style," designating the MEP-7000 as an audio output device will enable it to output tracks played from the DJ software. Consult your supported DJ software's instruction manual for details regarding how to designate the MEP-7000 as an audio output device.

For DJS:

DJS can be used to designate the MEP-7000 as an audio output device. Consult the "Normal Style" chapter of the DJS Control Guide (PDF file on accessory CD-ROM) for details regarding how to designate the MEP-7000 as an audio output device.

USING DJ SOFTWARE

4 Select [PC] on the BROWSE screen.

Once the DJ software starts, the center display's BROWSE screen will show the computer control status, allowing the rotary selector dial, select up (◀) and down (▶) buttons to be used to operate the DJ software.

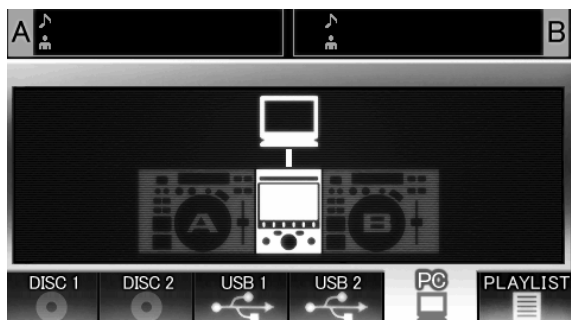

For DJs:

The center display will show the DJS BROWSE screen. For details of actual operation, consult the section "Selecting DJS Music Tracks" in the chapter on "Normal Style" operation of the MEP-7000 DJS Control Guide (PDF file on accessory CD-ROM).



5 Press LOAD A (or B) button.

When the **LOAD A** (or **LOAD B**) button is pressed while **[PC]** is selected on the BROWSE screen's source selector, the DJ software's track will be set in the controller corresponding to the **LOAD** button pressed (A or B). During DJ software operation, the controller appears highlighted in the BROWSE screen.



At the same time, the display A/B displays "PC".

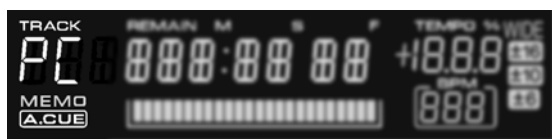

For DJs:

The display A/B displays "DJS".

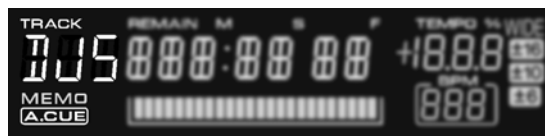

6 Use the controller to operate the DJ software.

Use the various buttons, jog dial, and **TEMPO** adjust slider to operate the DJ software.

MEMO

- When using the accessory DJS software and certain other DJ software programs, the MEP-7000's center display, and displays A/B will show the currently playing track's time data and title, together with the name of artist.
- By designating the MEP-7000 as an audio output device in the DJ software, tracks played with the DJ software can be output from the drive unit.

7 To switch to playback of disc or tracks on USB storage device

While controller A (or B) is controlling the computer, if a track on disc or USB storage device is selected on the BROWSE screen and the **LOAD A** (or **LOAD B**) button is pressed, playback and control will switch to the selected track on disc or USB storage device.

Control using "Manipulator Style"

1 Connect to the computer.

The center display will show the **[PRO DJ]** logo.



2 Start the DJ software program.

When communication is established with the DJ software, the buttons, jog dial, and **TEMPO** adjust slider can be used to control operation, and the MEP-7000's center display, and displays A/B will show the currently playing track's time data and title, together with the name of artist.



MEMO

- Some DJ software programs do not support the aforementioned track information displays.

USING DJ SOFTWARE

For DJs:

Control can be performed while viewing the center display's BROWSE, MIX, and EFFECT screens. For details of actual operation, consult the chapter on "Manipulator Style" operation of the MEP-7000 DJS Control Guide (PDF file on accessory CD-ROM).



MEMO

- While the UTILITY screen is being displayed on the center display, the center display's buttons and rotary selector dial cannot be used to control DJ software.

USING MIDI FOR COMPUTER CONTROL

MIDI (Musical Instrument Digital Interface) is a standardized protocol used to govern data transmission between electronic musical instruments and computers.

The MEP-7000 uses the MIDI message format to output its operating data and status to a computer connected by USB cable. By using a DJ software program with USB MIDI support to assign the MIDI messages output by the MEP-7000, the MEP-7000 can be used to control the DJ software.

For more information regarding messages output by the MEP-7000, consult the section "MIDI MESSAGE TABLE" (P. 58).

Control in "Normal Style"

1 Connect to the computer.

When the USB connection with the computer is properly established, the BROWSE screen's [PC] icon will change to active display.



2 Start the DJ software program.

The icon will not change.

3 Designate the MEP-7000 as an audio output device in the DJ software.

In "Normal style", designating the MEP-7000 as an audio output device will enable it to output tracks played from the DJ software. Consult your supported DJ software's instruction manual for details regarding how to designate the MEP-7000 as an audio output device.

4 Select [PC] on the BROWSE screen.

When communication is established with the DJ software, the center display's BROWSE screen will indicate the computer control status. While the BROWSE screen is displayed, the center display outputs MIDI messages that enable operation of the DJ software by using the rotary selector dial and select up (▲) and down (▼) buttons.

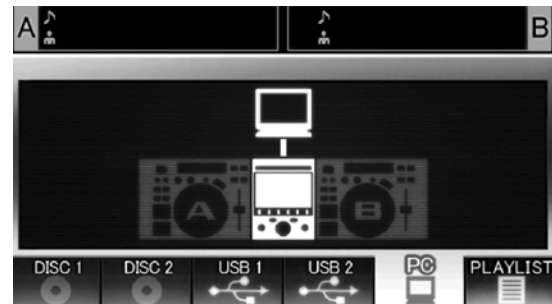

5 Press LOAD A (or B) button.

When the **LOAD A** (or **LOAD B**) button is pressed, controller A (or B) MIDI messages are output, allowing use of the controller to operate the DJ software. During DJ software operation, the controller appears highlighted in the BROWSE screen.



At the same time, the display A/B displays "PC".



6 Use the controller to operate the DJ software.

Use the various buttons, jog dial, and **TEMPO** adjust slider to operate the DJ software.

MEMO

- By designating the MEP-7000 as an audio output device in the DJ software, tracks played with the DJ program can be output from the drive unit.

7 To switch to playback of disc or tracks on USB storage device

While controller A (or B) is controlling the computer, if a track on disc or USB storage device is selected on the BROWSE screen and the **LOAD A** (or **LOAD B**) button is pressed, playback and control will switch to the selected track on disc or USB storage device.

Control using "Manipulator Style"

1 Connect to the computer.

The center display will show the [PRO DJ] logo.



2 Start the DJ software program.

When communication is established with the DJ program, the MEP-7000 operates as a MIDI controller, and the status of controller A/B and center display section's buttons and controls are output as MIDI messages.

MEMO

- While the UTILITY screen is being displayed on the center display, the center display's MIDI messages are not output.

Setting a MIDI channel

MIDI channel setting can be performed from the UTILITY screen.

1 Press the UTILITY button.

2 Press the [PC] function button.

The center display will show the MIDI channel setting menu.

- Controller A uses the same channel as the center display, while controller B uses a different channel. (Factory defaults are for Controller A and center display to be set to Channel 1, and Controller B set to Channel 2).



3 Either press the rotary selector dial, or press the select down (▶) button.

The ▶ icon will move to the right.

4 Turn the rotary selector dial to change the value.

Values between 1 and 16 can be set.

5 Press the rotary selector dial to confirm the value selected.

- Press the select up (◀) button to cancel the selection and return to the UTILITY screen.

MIDI MESSAGE TABLE

	Interface Name	Interface Type	Message			Comments
				MSB		
Controller A	JOG DIAL	General Purpose Controller	Bn	10	dd	Linear value with respect to speeds from stop to 4x, 64 at stop; FWD direction: 65 (0.06x) to 127 (x4); REV direction: 63 (0.06x) to 0 (4x).
	TEMPO ADJUST SLIDER	VR	Bn	1D	dd	0 to 127 0 at – side, 127 at + side
	PLAY/PAUSE	SW	9n	00	dd	OFF=0, ON=127
	CUE	SW	9n	01	dd	OFF=0, ON=127
	SEARCH FWD	SW	9n	02	dd	OFF=0, ON=127
	SEARCH REV	SW	9n	03	dd	OFF=0, ON=127
	TRACK SEARCH Next	SW	9n	04	dd	OFF=0, ON=127
	TRACK SEARCH Prev	SW	9n	05	dd	OFF=0, ON=127
	IN/CUE	SW	9n	06	dd	OFF=0, ON=127
	OUT/ADJUST	SW	9n	07	dd	OFF=0, ON=127
	RELOOP	SW	9n	08	dd	OFF=0, ON=127
	MEMORY	SW	9n	0A	dd	OFF=0, ON=127
	CALL	SW	9n	0B	dd	OFF=0, ON=127
	TIME/A.CUE	SW	9n	0E	dd	OFF=0, ON=127
	TEMPO RANGE	SW	9n	10	dd	OFF=0, ON=127
	MT	SW	9n	11	dd	OFF=0, ON=127
	SCRATCH	SW	9n	12	dd	OFF=0, ON=127
	JOG BREAK	SW	9n	13	dd	OFF=0, ON=127
	PITCH BEND +	SW	9n	14	dd	OFF=0, ON=127
	PITCH BEND –	SW	9n	15	dd	OFF=0, ON=127
JOG TOUCH	SW	9n	20	dd	OFF=0, ON=127	
Controller B	JOG DIAL	General Purpose Controller	Bn+1	10	dd	Linear value with respect to speeds from stop to 4x, 64 at stop; FWD direction: 65 (0.06x) to 127 (x4); REV direction: 63 (0.06x) to 0 (4x).
	TEMPO ADJUST SLIDER	VR	Bn+1	1D	dd	0 to 127 0 at – side, 127 at + side
	PLAY/PAUSE	SW	9n+1	00	dd	OFF=0, ON=127
	CUE	SW	9n+1	01	dd	OFF=0, ON=127
	SEARCH FWD	SW	9n+1	02	dd	OFF=0, ON=127
	SEARCH REV	SW	9n+1	03	dd	OFF=0, ON=127
	TRACK SEARCH Next	SW	9n+1	04	dd	OFF=0, ON=127
	TRACK SEARCH Prev	SW	9n+1	05	dd	OFF=0, ON=127
	IN/CUE	SW	9n+1	06	dd	OFF=0, ON=127
	OUT/ADJUST	SW	9n+1	07	dd	OFF=0, ON=127
	RELOOP	SW	9n+1	08	dd	OFF=0, ON=127
	MEMORY	SW	9n+1	0A	dd	OFF=0, ON=127
	CALL	SW	9n+1	0B	dd	OFF=0, ON=127
	TIME/A.CUE	SW	9n+1	0E	dd	OFF=0, ON=127
	TEMPO RANGE	SW	9n+1	10	dd	OFF=0, ON=127
	MT	SW	9n+1	11	dd	OFF=0, ON=127
	SCRATCH	SW	9n+1	12	dd	OFF=0, ON=127
	JOG BREAK	SW	9n+1	13	dd	OFF=0, ON=127
	PITCH BEND +	SW	9n+1	14	dd	OFF=0, ON=127
	PITCH BEND –	SW	9n+1	15	dd	OFF=0, ON=127
JOG TOUCH	SW	9n+1	20	dd	OFF=0, ON=127	

	Interface Name	Interface Type	Message			Comments
			Bn	4F	dd	
Center display section	ROTARY SELECTOR DIAL	General Purpose Controller	Bn	4F	dd	98 to 127, 1 to 30 (± 1 to ± 30), transmits count value difference from previous time. When ± 30 or more, becomes ± 30 .
	SELECT DOWN (>)	SW	9n	31	dd	OFF=0, ON=127
	SELECT UP (<)	SW	9n	32	dd	OFF=0, ON=127
	ROTARY SELECTOR DIAL PUSH	SW	9n	33	dd	OFF=0, ON=127
	LOAD A	SW	9n	34	dd	OFF=0, ON=127
	LOAD B	SW	9n	35	dd	OFF=0, ON=127
	BROWSE	SW	9n	36	dd	OFF=0, ON=127
	MIX	SW	9n	37	dd	OFF=0, ON=127
	EFFECT	SW	9n	38	dd	OFF=0, ON=127
	F1	SW	9n	39	dd	OFF=0, ON=127
	F2	SW	9n	3A	dd	OFF=0, ON=127
	F3	SW	9n	3B	dd	OFF=0, ON=127
	F4	SW	9n	3C	dd	OFF=0, ON=127
	F5	SW	9n	3D	dd	OFF=0, ON=127
	F6	SW	9n	3E	dd	OFF=0, ON=127

- n = channel number
- Messages with gray overlay are output only when unit is connected to computer in manipulator style, with the exception that they are not output when the UTILITY screen is displayed.

ENJOYING CD-G KARAOKE

The MEP-7000 can playback CD-G discs and output images to an external monitor (MONITOR OUT) for Karaoke play.

SELECT CD-G PLAY MODE

To play a CD-G disc, it is necessary to use the UTILITY screen to set the CD-G play mode.

- 1 Press the **UTILITY** button.
- 2 Press the **[CD-G]** function button.
The CD-G setting menu will appear.

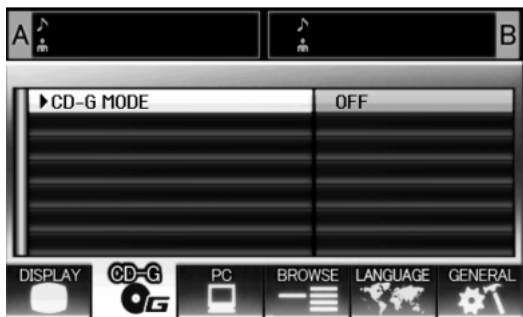

- 3 Select **[CD-G MODE]**, and press the select (▶) down button.
- 4 Use the rotary selector dial to select **[ON]**, then press the rotary selector dial.
The **LOAD A/B** buttons will flash blue, and the center display will show the **[CD-G MODE]** indicator.



MEMO

- During CD-G play mode, the **UTILITY** button's LED will flash red, and it will not be possible to change to the **BROWSE**, **MIX**, or **EFFECT** screens. To change to one of those screens you must first cancel the CD-G play mode.

TO PLAY A CD-G DISC

- 1 Press the **LOAD A** or **LOAD B** button.
The selected controller's **LOAD** button will change to lighted blue.
- 2 Insert a CD-G disc into the drive corresponding to the lighted **LOAD** button, and use the **TRACK SEARCH** button to select the desired track.
CD-G disc play will begin, and the image will be output to the display.

MEMO

- The CD-G images from the controller being played corresponding to the lighted **LOAD** button will be visible on the display. If a flashing **LOAD** button is pressed, the controller on the corresponding side will switch to the CD-G images being played back.
- If Auto Cue is set to ON when track search is performed, playback will enter the pause (standby) mode at the beginning of the searched track.
- If control cords are connected to a Pioneer DJ mixer, the fader start operation can also be used to switch playback between controller A and controller B.

Key control

When the **PITCH BEND** button is pressed, the key (pitch) can be adjusted. Each half-step can be adjusted in six stages.

Vocal cancel

Vocal audio can be canceled by pressing the **MASTER TEMPO** button, thus allowing ordinary music CDs (CD-DA) to be used for karaoke play.

Audio switching

Each time the **TEMPO** range button is pressed, the audio output switches as follows:

L-R: Stereo → L: monaural → R: monaural

MEMO

- The disc loaded into drive 1 is set for controller A, and the disc loaded into drive 2 for controller B. Other designation of the controllers is not supported.
- In the CD-G play mode, playback is disabled from CD-ROM/DVD-ROM and USB storage device.
- In the CD-G play mode, Scratch and other DJ play operations are disabled.
- Images can be output to an external monitor during disc play. No external output is performed when the UTILITY screen is displayed, however.
- The vocal cancel mode is designed to cancel vocal sounds coming equally both right and left speakers. The unit may be unable to cancel vocals that are output from only right or left speaker alone.

TO CANCEL CD-G PLAY MODE

- 1 Press the **UTILITY** button.
- 2 Press the **[CD-G]** function button.
The UTILITY CD-G setting menu will be displayed.
- 3 Select **[CD-G MODE]** and press the select down (▶) button.
- 4 Use the rotary selector dial to select **[OFF]**, then press the rotary selector dial.
The CD-G play mode will be canceled. If a disc is currently being played, play will simultaneously stop.

USING THE UTILITY

When the **UTILITY** button is pressed, the UTILITY screen appears, allowing setting of various device parameters, creation of libraries, and backup of user data.

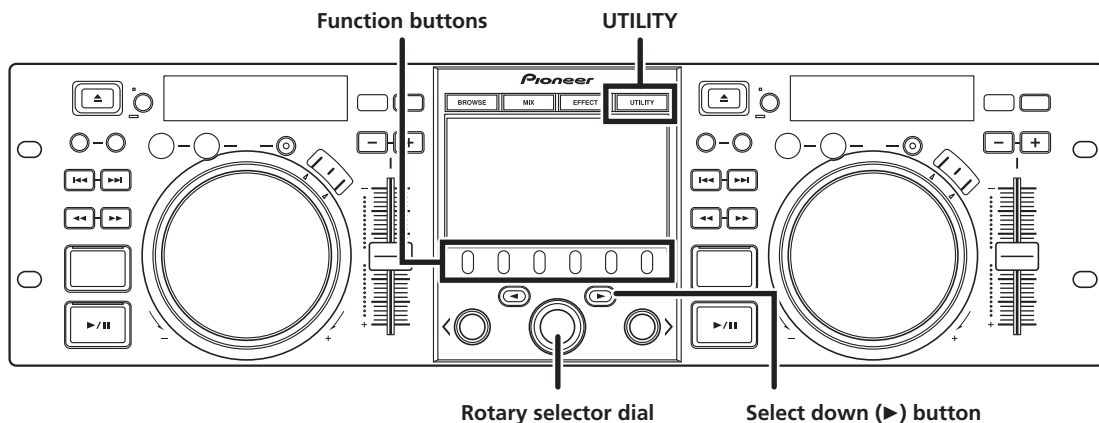

SETTINGS

[1] DISPLAY

Brightness, external output settings, etc.

		Factory default setting
LCD BRIGHTNESS	Sets brightness of center display (5 steps)	5
OEL BRIGHTNESS	Sets brightness of displays A/B (5 steps)	5
LED BRIGHTNESS	Sets brightness of LED (5 steps)	5
SCREEN SAVE *1	After the set time without user operation, the LCD and OEL screens are dimmed in order to preserve the displays.	ON
TV STANDARD	Sets signal format for monitor output (PAL, NTSC (7.5 IRE), NTSC (0 IRE)).	NTSC (7.5 IRE)
MONITOR OUT	Sets center display aspect ratio to LETTER BOX, FULL SCALE, or OFF.	OFF

*1 Screen saver operation

- The screensaver operates when five minutes have passed without a track being loaded in either controller.
- The screensaver also operates after 100 minutes passes without any button input when either one or both of the controllers is in pause mode (including cue standby or END display).
- Screensaver operation can be set for either normal style or manipulator style connection.
- The screen saver is disabled when a track is set with DJ software other than DJS.
- During operation of the screensaver, pressing a button, inserting a disc, or performing any other command operation will cancel the screensaver.

SETTING METHOD

- 1 Use the function buttons to select the item you wish to set [DISPLAY/CD-G/PC/BROWSE/LANGUAGE/GENERAL].
- 2 Rotate the rotary selector dial to align the cursor with the desired setting item.
- 3 Press either the select down (▶) button or the rotary selector dial to move the ▶ icon to the right side.
- 4 Turn the rotary selector dial to select the desired setting value.
- 5 Press the rotary selector dial to confirm the new setting value.

To cancel before confirming, press the select up (◀) button.

[2] CD-G

The CD-G karaoke mode can be selected (P. 60).

[3] PC

The MIDI channel can be set (P. 57).

USING THE UTILITY

[4] BROWSE

Allows setting of the browse type and creation of libraries.

		Factory default setting
BROWSE TYPE (USB1)	Sets the browse type for the rear-panel USB storage device.	LIBRARY
BROWSE TYPE (USB2)	Sets the browse type for the front-panel USB storage device.	LIBRARY
LIBRARY (USB1)	Creates a library on the rear-panel USB storage device. (*2)	
LIBRARY (USB2)	Creates a library on the front-panel USB storage device. (*2)	

*2 See P. 63 "CREATING LIBRARIES".

■ Setting the browse type

The browse type can be selected, and each USB storage device set regarding whether to use created libraries.

LIBRARY	If a library is found on a USB storage device, library browsing is set.
NORMAL	File browsing is used as the browse mode, without using any libraries.

MEMO

- The browse type setting is applied to any USB device connected after the setting has been made. To change the browse mode of a USB storage device already connected, disconnect and reconnect the USB device after changing the setting.

[5] LANGUAGE

Set the language to be used.

		Factory default setting
LANGUAGE	Select display language from nine available (English, French, German, Italian, Spanish, Dutch, Russian, Simplified Chinese, Japanese).	English

[6] GENERAL

Allows making LOAD LOCK and other settings, and backup of user data.

		Factory default setting
LOAD LOCK *3	Locks the LOAD button so that it is disabled during playback.	OFF
<A>AUTO CUE LEVEL	Sets the auto cue level for controller A (8 steps).	-60 dB
AUTO CUE LEVEL	Sets the auto cue level for controller B (8 steps).	-60 dB
KEYBOARD LANGUAGE	Select keyboard input language from ten available (English (US), English (UK), French, German, Italian, Spanish, Dutch, Russian, Simplified Chinese, Japanese).	English (US)
BACKUP MODE *4	Backup cue points and playlists.	
VERSION INFO	Displays MEP-7000 version information.	

*3 The LOAD LOCK function is disabled when a track is set with DJ software other than DJS.

*4 See P. 63 "BACKING UP USER DATA".

CREATING LIBRARIES

This unit supports the creation of libraries for large-capacity USB storage devices, thus allowing categorizing numerous tracks by album name, artist name, and genre, and facilitating smooth track selection.

Library creation, updating, and deletion are performed with the UTILITY screen.

MEMO

- Library creation and updating requires increasing amounts of time in correspondence to the number of files. (As a general estimate, creation of a library for 5000 files may take about 30 minutes. Additional time may be required when creating libraries for a folder containing a large number of sub-folders and files.)
- By using a computer, you can create libraries even faster. Library creation programs can be downloaded from the following website: <http://www.prodjnet.com/support/>

- Connect the USB storage device on which you wish to create a library.
- On the UTILITY screen, select [BROWSE], then select [LIBRARY (USB1)] or [LIBRARY (USB2)] in accordance with the device on which you wish to create the library; finally, press either the down (▶) button or rotary selector dial.

MEMO

- Library creation/updating/deletion cannot be performed when a track is currently playing.

- Rotate the rotary selector dial and select the desired operation [CREATE/UPDATE/DELETE/CANCEL], then press the rotary selector dial.

CREATE	Create a library
UPDATE	Perform comparison with library existing on USB storage device, and if a difference is found, update the library.
DELETE	Delete a library on the USB storage device.
CANCEL	Return to UTILITY screen.

- The screen will change as the selected operation begins; when the operation is finished, the [Done] message will appear.

When the database management operation is completed, disconnect and reconnect all USB storage devices.

MEMO

- To interrupt the management operation midway, hold the UTILITY button depressed for one second or more.
- A library can be created with up to 150 000 tracks.
- Libraries are created on the USB storage device in folders named PIONEER (or .PIONEER in the case of HFS+).
- When updating a library, information on deleted or added tracks is updated. Revised (changed) track information is not updated. To update (change) track information, use of a library creation program is required.

NOTE

- Creation of a library requires from about several-hundred bytes to 1 Kbyte of storage space per track.
- Updating a library requires approximately 2 KB of open space on the device per track.

BACKING UP USER DATA

Information stored in this unit regarding playlists and disc cue/loop points can be copied to a USB storage device, allowing the information to be transferred to another MEP-7000.

Begin this operation with no discs loaded or USB storage devices connected.

Writing data to USB storage device

- Press the UTILITY button.
- Press the function [GENERAL] button.
- Turn the rotary selector dial to select [BACKUP MODE], and then press the select down (▶) button or the rotary selector dial.
- Turn the rotary selector dial and select [Write to USB], then press the rotary selector dial.
- When [Connect a USB storage device to the USB port.] is displayed, insert the USB storage device to the USB port.
- The data will begin writing to the USB storage device. When writing is completed, [Done] will be displayed, and the screen will change to the UTILITY screen.

MEMO

- A backup file named BACKUP.BIN with size of around 1.5 Mbyte will be created in the root directory of the USB storage device.

Reading data from a USB storage device

- Press the UTILITY button.
- Press the function [GENERAL] button.
- Turn the rotary selector dial to select [BACKUP MODE], and then press the select down (▶) button or the rotary selector dial.
- Turn the rotary selector dial and select [Read from USB], then press the rotary selector dial.
- When [Connect a USB storage device to the USB port.] is displayed, insert the USB storage device to the USB port.
- Data reading begins. When writing is completed, [Done] will be displayed, and the screen will change to the UTILITY screen.

MEMO

- Backing up cue point and loop points is supported for disc media stored in this unit.

NOTE

- Any data stored in this unit will be overwritten, so any previously stored information will be lost.

TO PERFORM A FACTORY RESET

All unit settings can be restored to their factory default values by using the UTILITY screen (P. 61). The settings on TIME/REMAIN, A.CUE, and TEMPO range will also be restored to their factory default values (REMAIN, OFF, 10%).

- 1 With the power turned OFF, hold the UTILITY button depressed while setting power to ON.**
The button must be depressed for five seconds or more.
- 2 Confirm message.**
After the boot-up screen appears, a message will be displayed: **[The settings have been reset to factory defaults]**.
- 3 Turn power OFF and ON again.**

MEMO

- Recorded playlists and cue and loop point data are not deleted during a factory reset.

TROUBLESHOOTING

If you believe your player is failing to work properly, check the following troubleshooting table for tips. Sometimes simple mistakes in setup or operation may appear like serious problems. There are also times when the problem in question may be caused by something else other than your player, and at times like these you should check any other electronic devices being used at the same time.

If the problem in question continues to persist even after checking the troubleshooting table below and taking whatever corrective action is recommended, contact your nearest Pioneer Service Station or contact the store from which you purchased your player for further assistance.

Description of problem	Possible cause of problem	Recommended action
A disc fails to be ejected even after the EJECT (▲) button has been pressed.	• Power cord has not been plugged in.	• Plug in power cord.
	• A track is being played back.	• Set the player to pause or cue standby mode before pressing the EJECT (▲) button.
	• EJECT (▲) button is broken.	• See P. 24.
Playback doesn't begin even when a disc is inserted.	• Auto Cue function is turned ON.	• Press the play/pause (▶/) button to begin play. • Hold the TIME/A.CUE button depressed for one second or more to set the Auto Cue mode to OFF.
	• CD-R/RW, DVD ±R/RW or other media are of poor quality.	• Replace with other media, or media recorded on a different recording machine.
	• Format not supported.	• See P. 11 "REGARDING PLAYABLE DISCS AND FILES" regarding supported formats.
Playback comes to a halt almost immediately after it begins.	• Disc has been inserted upside down.	• Reinsert with label side facing upward.
	• Disc is dirty or covered with condensation.	• Wipe disc to remove dust or condensation.
USB storage device not detected.	• Device does not comply with USB mass storage class.	• Use a device complying with USB mass storage class (some portable audio players included in the class of image devices are not supported. Also, some flash card readers cannot be detected).
	• USB hub in use.	• Some USB hubs will not operate properly. Try a different USB hub, or connect the storage device directly to the USB port. Also, if multiple USB storage devices are connected through a USB hub, only one of the devices will be recognized.
	• Format not supported.	• Use only FAT, FAT32, or HFS+ formats.
A caution message to the effect that "an excess current has been detected" will appear in the center display.	• The connection with this unit has been terminated because an electrical current stronger than that allowable was applied to this unit's USB1 port or USB2 port.	• Restore normal operation by following the directions listed in "Connecting a USB storage device" (P. 26). The rating (allowable current) for this unit is 500 mA or less per port. Use USB storage devices that meet these standards. If you have a USB storage device connected through a bus-powered USB hub, connect the USB storage device directly to this unit.
Can't play MP3 or AAC tracks.	• Format not supported.	• See P. 11 "REGARDING PLAYABLE DISCS AND FILES" regarding supported formats.
	• Files are copy-protected.	• Cannot be used on this unit.
No sound is output.	• Audio cable has come loose or has not been properly plugged in.	• Plug in audio cable properly.
	• DJ mixer is not working properly.	• Check switch and volume settings on DJ mixer.
	• Jacks or jack plugs are dirty.	• Wipe away dust or dirt and reinsert plugs.
	• Controller is currently in pause mode.	• Press the play/pause (▶/) button to begin play.
Sound is distorted or full of noise.	• Audio cable has not been properly plugged in.	• Connect audio cable to line input jack of DJ mixer. Do not connect to microphone jack.
	• Jacks or jack plugs are dirty.	• Wipe away dust or dirt and reinsert plugs.
	• Player is subject to noise from a nearby television set.	• Turn off power to television set or move television set further away from player.

TROUBLESHOOTING

Description of problem	Possible cause of problem	Recommended action
A large amount of noise is generated when playing back a certain disc or discs. Playback halts unexpectedly.	• Disc is seriously warped or scratched.	• Replace with new disc.
	• Disc is unusually dusty or dirty.	• Wipe away dust or dirt from disc.
Track won't load during playback.	• LOAD LOCK is set to ON.	• Use UTILITY screen to set LOAD LOCK to OFF.
Track searching fails to halt with Auto Cue function turned ON.	<ul style="list-style-type: none"> • Track searching sometimes takes longer than expected when the length of silent portions between tracks is unusually long. • If the length of a silent portion between two tracks is longer than 10 seconds in duration, the second track cannot be played back unless Auto Cue function is turned OFF. 	• Hold the TIME/A.CUE button depressed for one second or more to set the Auto Cue mode to OFF.
The jog dial performs a different function from that desired.	• The jog mode is incorrect.	• Press the SCRATCH/JOG BREAK button to select the desired function.
Back cueing fails to work when the CUE button is pressed during playback.	• No cueing point has been defined.	• Specify the desired cueing point. (P. 36)
Unable to produce loop playback by pressing the OUT/ADJUST button.	• No cueing point (i.e., starting point) has been defined.	• Specify the desired cueing point. (P. 36)
Auto cue and other setting are not stored.	• The power was turned off right after a setting was made.	• Wait 10 seconds before turning off the power after a change.
Can't store cue/loop point data for tracks on USB storage device.	• Insufficient space on USB storage device.	• Delete unnecessary files or other make sufficient space on USB storage device.
Recorded USB storage device cue and loop points aren't displayed.	• USB storage device was disconnected before performing proper dismount procedure, or power was turned off.	• Always perform proper dismount procedure before disconnecting USB storage device or turning off power.
Playlist tracks appear grayed out.	• The disc or USB storage device for the recorded tracks is not loaded/connected.	• Load or connect the disc or USB storage device for the recorded tracks.
	<ul style="list-style-type: none"> • The recorded tracks have been deleted from the USB storage device. • The file names for the recorded tracks have been changed, or the files moved. 	• Once again record the changed file names or changed locations in the playlist.
	• USB storage device was disconnected before performing proper dismount procedure, or power was turned off.	• Always perform proper dismount procedure before disconnecting USB storage device or turning off power.
Can't record tracks located on USB storage device on playlist.	• Insufficient space on USB storage device.	• Delete unnecessary files or other make sufficient space on USB storage device.
Keyboard input isn't correct.	• KEYBOARD LANGUAGE setting is incorrect.	• Use UTILITY screen's KEYBOARD LANGUAGE setting to select the proper input language.
	• You are using a keyboard for a language other than the ten supported by this unit.	• Use a keyboard for one of the supported languages.
Character data for MP3, AAC format tracks appears garbled.	• LANGUAGE setting is incorrect	• Go to the UTILITY screen and set LANGUAGE to the language of your choice.
	• The track information for the music file created in the DJ software is in a language not supported by this unit.	• Input the file information in a language supported by this unit. This unit is able to display European languages, Russian, simplified Chinese and Japanese.
	• The track information for this unit is in a language not supported by the DJ software.	• For information on the languages supported by your DJ software, check the instruction manual for the software you are using.
Tracks contained in m3u files won't load.	• m3u file is not recorded correctly.	• Confirm correct recording format for m3u file.

TROUBLESHOOTING

Description of problem	Possible cause of problem	Recommended action
MEP-7000 isn't detected when connected to computer (normal style connections).	<ul style="list-style-type: none"> Driver software hasn't been correctly installed in computer. If the MEP-7000 is not connected properly and communicating with the computer, the version information utility will not display the firmware version. To check this, see P. 52 of this manual ("ABOUT THE DRIVER PROGRAM, ■ Confirming the driver version"). 	<ul style="list-style-type: none"> Install the driver correctly. If already installed, try uninstalling and reinstalling it.
	<ul style="list-style-type: none"> Control unit is connected to computer. 	<ul style="list-style-type: none"> In Normal Style, connect drive unit to computer.
MEP-7000 isn't detected when connected to computer (manipulator style connections).	<ul style="list-style-type: none"> Driver software hasn't been correctly installed in computer. If the MEP-7000 is not connected properly and communicating with the computer, the version information utility will not display the firmware version. To check this, see P. 52 of this manual ("ABOUT THE DRIVER PROGRAM, ■ Confirming the driver version"). 	<ul style="list-style-type: none"> Install the driver correctly. If already installed, try uninstalling and reinstalling it.
	<ul style="list-style-type: none"> USB auxiliary power cable not connected. 	<ul style="list-style-type: none"> Connect to computer in the order (1) USB auxiliary power cable, and (2) USB cable.
Television pictures are distorted or noise appears in FM broadcasts.	<ul style="list-style-type: none"> Interference caused by player. 	<ul style="list-style-type: none"> Turn off the power to the player or move the player further away from the radio or television set.
Disc is not rotating even though power has been turned on.	<ul style="list-style-type: none"> Disc rotation is automatically halted when no operation is performed for 100 minutes or longer when in pause mode. When the last track on the disc is over the disc stops rotating. 	<ul style="list-style-type: none"> Press the play/pause (▶/) button to begin playback. Alternatively, press the EJECT (▲) button to eject the disc.

- There may be times when MEP-7000 fails to operate properly as a result of static electricity or some other form of interference from an outside source. If any such problem occurs, turn off the power to the MEP-7000, wait for the currently inserted disc to come to a full stop, and then turn on the power again to see if that fixes the problem in question.
- This unit cannot play "partial" (unfinalized) CD-R/-RW, DVD-R/-RW, DVD+R/+RW, and DVD±R dual layer media.
- Do not attempt to play irregularly shaped or other discs besides normal 12 cm round discs, since malfunction or damage may result.
- The BPM value measured by MEP-7000 may differ from the BPM value recorded on a CD or from our DJ mixer, but this difference is a result of differences in the BPM value measurement method; not a result of a fault with the player.

ABOUT THE LCD SCREEN

- Some LCD monitors may display so-called "hot pixels" or "dead pixels" (constantly bright pixels or pixels that are permanently off). This is a phenomenon characteristic of LCD displays and is not considered a malfunction.
- When used in cold regions, the screen may appear dark for a while after the power is first turned on. As the unit warms up with time, the screen will return to normal brightness.
- Avoid viewing the LCD screen in direct sunlight, since the light reflected off the screen may make the image difficult to view.

ABOUT OEL (ORGANIC EL) SCREENS

- The two screens (displays A/B) may display slightly different color characteristics, but this is not a malfunction.

ERROR MESSAGE DISPLAY

When MEP-7000 is unable to operate properly, an error code is displayed on the display panel. Check the error code displayed against the following table and take the recommended action to correct the error. If an error code other than any of the error codes listed in the table below is displayed or if the same error code is displayed even after corrective action has been taken, contact your nearest Pioneer Service Station or contact the store from which you purchased your player for assistance.

Error Code	Error Type	Media	Description	Possible cause and recommended action
E-6002	AUDIO DSP DOWNLOAD ERROR		Programs cannot be written to the audio DPS when the power is turned on.	Consult your dealer or the nearest Pioneer Service Station.
E-7201	TOC READ ERROR	DVD/CD	TOC data is not being read from the disc.	<ul style="list-style-type: none"> If there are cracks in the disc, replace the disc. If the disc is dirty, clean the disc. If the unit operates normally with other discs, there is a problem with the disc.
E-8301	STOP ERROR	DVD/CD	Cannot stop disc properly.	Consult your dealer or the nearest Pioneer Service Station.
E-8302	PLAYBACK ERROR	DVD/CD	Desired address cannot be searched.	<ul style="list-style-type: none"> If there are cracks in the disc, replace the disc. If the disc is dirty, clean the disc. If the unit operates normally with other discs, there is a problem with the disc.
			Address cannot be read.	
			Focus servo cannot be closed.	
			Pickup cannot be moved.	Consult your dealer or the nearest Pioneer Service Station.
E-8303	BUFFER WRITE ERROR	DVD/CD/USB	Failed to write to music data buffer.	Consult your dealer or the nearest Pioneer Service Station.
E-8304	DECODE ERROR	DVD/CD/USB	Although the compressed music file (MP3/AAC) is in the format supported by this unit, a data error or decode error occurred.	Consult your dealer or the nearest Pioneer Service Station.
E-8305	FORMAT ERROR	DVD/CD/USB	Although the extension of the music file (MP3/AAC/WAV/AIFF) is correct, the description within the file is not in the supported format.	Exchange the disc or file to one that meets format specifications.
E-8306	MUSIC FILE NONE	USB	Although tracks were entered in libraries (database)/playlists etc., at time of playback the tracks had been deleted from the USB storage device.	Do not delete music files from USB storage devices.
E-9101	LOADING TIMEOUT	DVD/CD	A mechanical error (timeout) occurred during the loading or unloading of a disc.	If a foreign object is in the disc loading slot, remove the object.

MEP-7000 UPDATES

Software for this unit may be updated to improve operation or functionality. For details consult the following support website:
<http://www.prodjnet.com/support/>

SOFTWARE LIMITING CONDITIONS

Supported devices	Disc media	Discs must be recorded in compatibility with ISO9660 file system. When recorded in UDF file system, the ISO9660 file system must be jointly recorded or the disc will not be playable. (For details consult the manufacturer of the applicable software.)
		On a single disc, no more than 2 000 folders and no more than 3 000 files can be displayed.
		Up to 8 levels of folder hierarchy are supported. Any files in folders beyond the eighth level will not be displayed.
	USB storage devices	WAV/AIFF files on discs are not supported.
		No more than 10 000 folders and no more than 10 000 files can be displayed within a single folder.
		Up to 8 levels of folder hierarchy are supported. Any files in folders beyond the eighth level will not be displayed.
Jacket Photograph	Does not support GUID partition-mapped Mac OS standard format.	
	USB storage devices which have been formatted with the Mac extension format set to "discriminate upper case and lower case" may not be recognized properly.	
	Photographs to be displayed as jacket art must be saved in JPEG format. Photographs larger than 800 x 800 pixels cannot be displayed.	
m3u file	When an image is imbedded in an ID3 tag, or an image file is found within a folder, the image will be displayed as a jacket photograph together with the ID3 data. In the event that images are found in both places, the image imbedded in the ID3 tag will be given precedence.	
	Up to 100 m3u files can be displayed per device.	
	Up to 300 tracks can be displayed for each m3u file. However, if the file size exceeds 308 000 bytes, those tracks in the portion exceeding 308 000 bytes cannot be displayed.	
MIX	When browsing using a database you have constructed, m3u files will not be displayed.	
	In the case of discs, those recorded with short file names are not supported.	
	In "normal style" operation, DJ software tracks cannot be mixed. In "manipulator style" operation, whether mixing is possible depends on the DJ software used (the accessory DJS software supports mixing).	
EFFECT	In "normal style" operation, effects cannot be applied to DJ software tracks. In "manipulator style" operation, whether applying effect is possible depends on the DJ software used (the accessory DJS software supports effect functions).	
	Music (CD-DA) tracks and DJS tracks cannot be added to playlists.	
	A maximum of 150 tracks can be recorded in a single playlist. When a playlist becomes full, no further tracks can be added.	
Playlists	If a USB storage device has insufficient capacity remaining, its tracks cannot be added to a playlist.	
	When adding tracks to a playlist by designating an entire folder, if no database for the tracks exists, the tracks will be added by file name, not by the name of artist and album title.	
	When adding tracks to a playlist by designating an entire folder, if no database for the tracks exists, the tracks will be added by file name, not by the name of artist and album title.	
Maximum displayable characters	Library browsing	Title: 63 characters; album name: 47 characters; artist name: 47 characters; genre name: 29 characters
	File browsing	Folder names, file names: 63 characters
	CD-TEXT	1 byte ASCII characters, etc.: 92 characters; 2-byte characters, MS-JIS, etc.: 80 characters
	Playlists	[During recording] Titles: 63 characters; artist names: 47 characters; [During playback] Titles: 49 characters; artists names: 29 characters
	ID3 data	Titles: 92 characters; album names: 47 characters; artists names: 47 characters; genre: 29 characters
Cue/loop point memory	Disc memory data, max, 2 000 discs (with 10 cue points or less per disc) can be stored in the built-in flash memory. When the built-in flash memory becomes full, information is overwritten, beginning from that for least-frequently used discs.	
	If the USB storage device has insufficient capacity remaining, the cue/loop point information for tracks on that device cannot be saved.	
Library	A library can be created with up to 150 000 tracks.	
	Up to 1 000 genres can be displayed. Genres for tracks exceeding this limitation will be displayed as [Unknown] .	

DISCLAIMER

- Pioneer and DJS are trademarks or registered trademarks of the Pioneer Corporation.
- Microsoft and Windows are registered trademarks of Microsoft Corporation, registered in the U.S. and other countries. Windows' official name is "Microsoft Windows Operating System".
- Pentium is a registered trademark of Intel Corporation, U.S.A.
- Adobe and Reader are registered trademarks or trademarks of Adobe Systems Incorporated, registered in the United States of America and other countries.
- Apple, Macintosh and Mac OS are trademarks of Apple Inc., registered in the U.S. and other countries.
- ASIO is a registered trademark of Steinberg Media Technologies GmbH.
- All other brand, product and company names are the trademarks or registered trademarks of their respective owners.

Supply of this product only conveys a license for private, non-commercial use and does not convey a license nor imply any right to use this product in any commercial (i.e. revenue-generating) real time broadcasting (terrestrial, satellite, cable and/or any other media), broadcasting/streaming via internet, intranets and/or other networks or in other electronic content distribution systems, such as pay-audio or audio-on-demand applications. An independent license for such use is required. For details, please visit <http://www.mp3licensing.com>.



Fraunhofer Institut
Integrierte Schaltungen

MPEG Layer-3 audio coding technology licensed from Fraunhofer IIS and Thomson multimedia.

Should this product require service in the U.S.A. and you wish to locate the nearest Pioneer Authorized Independent Service Company, or if you wish to purchase replacement parts, operating instructions, service manuals, or accessories, please call the number shown below.

800 – 782 – 7210

Please do not ship your product to Pioneer without first calling the Customer Support Division at the above listed number for assistance.

**PIONEER ELECTRONICS (USA), INC.
CUSTOMER SUPPORT DIVISION
P.O. BOX 1760, LONG BEACH,
CA 90801-1760, U.S.A.**

For warranty information please see the Limited Warranty sheet included with your product.

Should this product require service in Canada, please contact a Pioneer Canadian Authorized Dealer to locate the nearest Pioneer Authorized Service Company in Canada. Alternatively, please contact the Customer Service Department at the following address:

Pioneer Electronics of Canada, Inc.

**300 Allstate Parkway
Markham, ON L3R OP2
(905) 479-4411
1 (877) 283-5901**

For warranty information please see the Limited Warranty sheet included with your product.

 **NOTE**

- When bringing the unit to your dealer or a Pioneer Service Center, bring all components of the system (drive unit, control unit, cables).
- The DJ software program "DJS" not covered by the terms of free repair on the unit Warranty. When installing or using the DJS program, be sure to read and understand the terms of the End User License Agreement (P. 45).

Published by Pioneer Corporation.
Copyright © 2008 Pioneer Corporation.
All rights reserved.

PIONEER CORPORATION

4-1, Meguro 1-Chome, Meguro-ku, Tokyo 153-8654, Japan

PIONEER ELECTRONICS (USA) INC.

Multimedia and Mass Storage Division: 2265 East 220th Street, Long Beach, CA 90810, U.S.A. TEL: 800-444-OPTI (6784)

PIONEER ELECTRONICS OF CANADA, INC.

Industrial Products Department: 300 Allstate Parkway, Markham, Ontario L3R OP2, Canada TEL: 905-479-4411

Free Manuals Download Website

<http://myh66.com>

<http://usermanuals.us>

<http://www.somanuals.com>

<http://www.4manuals.cc>

<http://www.manual-lib.com>

<http://www.404manual.com>

<http://www.luxmanual.com>

<http://aubethermostatmanual.com>

Golf course search by state

<http://golfingnear.com>

Email search by domain

<http://emailbydomain.com>

Auto manuals search

<http://auto.somanuals.com>

TV manuals search

<http://tv.somanuals.com>