

Pioneer *sound.vision.soul*

DIGITAL SOUND PROJECTOR

PDSP-1

Operating Instructions

Thank you for buying this Pioneer product. Please read through these operating instructions so you will know how to operate your model properly. After you have finished reading the instructions, put them away in a safe place for future reference.

Replacement and mounting of an AC plug on the power supply cord of this unit should be performed only by qualified service personnel.

IMPORTANT

FOR USE IN THE UNITED KINGDOM.

The wires in this mains lead are coloured in accordance with the following code :

Green and Yellow : Earth
Blue : Neutral
Brown : Live

If the plug provided is unsuitable for your socket outlets, the plug must be cut off and a suitable plug fitted.

The cut-off plug should be disposed of and must not be inserted into any 13 amp socket as this can result in electric shock. The plug or adaptor or the distribution panel should be provided with 5 A fuse. As the colours of the wires in the mains lead of this appliance may not correspond with coloured markings identifying the terminals in your plug, proceed as follows :

The wire which is coloured green and yellow must be connected to the terminal in the plug which is marked with the letter E or by the earth symbol (⊕), or coloured green or green and yellow.

The wire which is coloured blue must be connected to the terminal which is marked with the letter N or coloured black.

The wire which is coloured brown must be connected to the terminal which is marked with the letter L or coloured red.

NOTE

After replacing or changing a fuse, the fuse cover in the plug must be replaced with a fuse cover which corresponds to the colour of the insert in the base of the plug or the word that is embossed on the base of the plug, and the appliance must not be used without a fuse cover. If lost replacement fuse covers can be obtained from: your dealer.

Only 5 A fuses approved by B.S.I. or A.S.T.A to B.S. 1362 should be used.

H001BEn

H004BEn

This product complies with the Low Voltage Directive (73/23/EEC, amended by 93/68/EEC), EMC Directives (89/336/EEC, amended by 92/31/EEC and 93/68/EEC).

H015AEn

WARNING: BEFORE PLUGGING IN THE UNIT FOR THE FIRST TIME, READ THE FOLLOWING SECTION CAREFULLY. THE VOLTAGE OF THE AVAILABLE POWER SUPPLY DIFFERS ACCORDING TO COUNTRY OR REGION. BE SURE THAT THE POWER SUPPLY VOLTAGE OF THE AREA WHERE THIS UNIT WILL BE USED MEETS THE REQUIRED VOLTAGE (E.G., 230V OR 120V) WRITTEN ON THE REAR PANEL.

H041A En

INSTALLATION

Note: Reference is made to ISO/IEC Guide 37 [12].

VENTILATION:

- When placing this unit with using optional stand or wall-mount kit, make sure to leave space around the unit for ventilation to improve heat dispersal at least 3 cm at the rear. If not enough space is provided between the unit and walls or other furniture, heat will build up inside, interfering with performance and/or causing malfunctions.
- Do not cover the unit with fabric or other covering. Anything that blocks ventilation will cause the internal temperature to rise, which may lead to breakdown or fire hazard.
- The rear of unit may become hot while in use, please take care around it.

WARNING: Slot and openings in the cabinet are provided for ventilation and to ensure reliable operation of the product and to protect it from overheating, to prevent fire hazard, the openings should never be blocked and covered with items, such as newspapers, table-cloths, curtains, etc. Also do not put the apparatus on the thick carpet, bed, sofa, or fabric having a thick pile.

WARNING: NO NAKED FLAME SOURCES, SUCH AS LIGHTED CANDLE, SHOULD BE PLACED ON THE APPARATUS. IF NAKED FLAME SOURCES ACCIDENTALLY FALL DOWN, FIRE SPREAD OVER THE APPARATUS THEN MAY CAUSE FIRE.

H044 En

WARNING: THE APPARATUS IS NOT WATERPROOF, TO PREVENT FIRE OR SHOCK HAZARD, DO NOT EXPOSE THIS APPARATUS TO RAIN OR MOISTURE AND DO NOT PUT ANY WATER SOURCE NEAR THIS APPARATUS, SUCH AS VASE, FLOWER POT, COSMETICS CONTAINER AND MEDICINE BOTTLE ETC.

Operating Environment

H045 En

Operating environment temperature and humidity:
+5°C – +35°C (+41°F – +95°F); less than 85%RH (cooling vents not blocked)

Do not install in locations exposed to strong sunlight, strong artificial light, high humidity or locations that have poor ventilation.

Note: The unit must be installed in such a way that it is possible to easily disconnect the mains plug.

CAUTION: To prevent injury, this apparatus must be securely attached to the appropriate Pioneer stands (model numbers B-PDSP-H, B-PDSP-L or BPDSP-W) in accordance with the installation instructions. Use with other apparatus is capable of resulting in instability causing possible injury.

WARNING: THIS PRODUCT EQUIPPED WITH A THREE-WIRE GROUNDING TYPE PLUG, A PLUG HAVING A THIRD (GROUNDING) PIN, IT WILL ONLY FIT INTO A GROUNDING TYPE POWER OUTLET. THIS IS A SAFETY FEATURE. IF YOU ARE UNABLE TO INSERT THE PLUG INTO THE OUTLET, CONTACT YOUR ELECTRICIAN TO REPLACE YOUR OBSOLETE OUTLET. DO NOT DEFEAT THE SAFETY PURPOSE OF THE GROUNDING TYPE PLUG.

H043 En

CAUTION: To disconnect the unit from the mains supply unplug the mains plug. Install the unit in such a way that it is easy to disconnect the mains plug in case of an accident. The mains plug of the unit should be unplugged from the wall socket when left unused for a long period of time.

This product is for general household purposes. Any failure due to use for other than household purposes (such as long-term use for business purposes in a restaurant or use in a car or ship) and which requires repair will be charged for even during the warranty period.

K041_En

IMPORTANT

The lightning flash with arrowhead symbol, within an equilateral triangle, is intended to alert the user to the presence of uninsulated "dangerous voltage" within the product's enclosure that may be of sufficient magnitude to constitute a risk of electric shock to persons.

CAUTION

**RISK OF ELECTRIC SHOCK
DO NOT OPEN**

CAUTION:
TO PREVENT THE RISK OF ELECTRIC SHOCK, DO NOT REMOVE COVER (OR BACK). NO USER-SERVICEABLE PARTS INSIDE. REFER SERVICING TO QUALIFIED SERVICE PERSONNEL.



The exclamation point within an equilateral triangle is intended to alert the user to the presence of important operating and maintenance (servicing) instructions in the literature accompanying the appliance.

IMPORTANT SAFETY INSTRUCTIONS

H003 En

- 1) Read these instructions.
- 2) Keep these instructions.
- 3) Heed all warnings.
- 4) Follow all instructions.
- 5) Do not use this apparatus near water.
- 6) Clean only with dry cloth.
- 7) Do not block any ventilation openings. Install in accordance with the manufacturer's instructions.
- 8) Do not install near any heat sources such as radiators, heat registers, stoves, or other apparatus (including amplifiers) that produce heat.
- 9) Do not defeat the safety purpose of the polarized or grounding-type plug. A polarized plug has two blades with one wider than the other. A grounding type plug has two blades and a third grounding prong. The wide blade or the third prong are provided for your safety. If the provided plug does not fit into your outlet, consult an electrician for replacement of the obsolete outlet.
- 10) Protect the power cord from being walked on or pinched particularly at plugs, convenience receptacles, and the point where they exit from the apparatus.
- 11) Only use attachments/accessories specified by the manufacturer.
- 12) Use only with the cart, stand, tripod, bracket, or table specified by the manufacturer, or sold with the apparatus. When a cart is used, use caution when moving the cart/apparatus combination to avoid injury from tip-over.



- 13) Unplug this apparatus during lightning storms or when unused for long periods of time.
- 14) Refer all servicing to qualified service personnel. Servicing is required when the apparatus has been damaged in any way, such as power-supply cord or plug is damaged, liquid has been spilled or objects have fallen into the apparatus, the apparatus has been exposed to rain or moisture, does not operate normally, or has been dropped.

[For U.S. model]**IMPORTANT NOTICE**

The serial number for this equipment is located in the rear panel. Please write this serial number on your enclosed warranty card and keep it in a secure area. This is for your security.

H006AEn

WARNING: Handling the cord on this product or cords associated with accessories sold with the product will expose you to lead, a chemical known to the State of California and other governmental entities to cause cancer and birth defects or other reproductive harm.

Wash hands after handling.

POWER-CORD CAUTION

S002 En

Handle the power cord by the plug. Do not pull out the plug by tugging the cord and never touch the power cord when your hands are wet as this could cause a short circuit or electric shock. Do not place the unit, a piece of furniture, etc., on the power cord, or pinch the cord. Never make a knot in the cord or tie it with other cords. The power cords should be routed such that they are not likely to be stepped on. A damaged power cord can cause a fire or give you an electrical shock. Check the power cord once in a while. When you find it damaged, ask your nearest PIONEER authorized service center or your dealer for a replacement.



NOTE: This equipment has been tested and found to comply with the limits for a Class B digital device, pursuant to Part 15 of the FCC Rules. These limits are designed to provide reasonable protection against harmful interference in a residential installation. This equipment generates, uses, and can radiate radio frequency energy and, if not installed and used in accordance with the instructions, may cause harmful interference to radio communications. However, there is no guarantee that interference will not occur in a particular installation. If this equipment does cause harmful interference to radio or television reception, which can be determined by turning the equipment off and on, the user is encouraged to try to correct the interference by one or more of the following measures:

- Reorient or relocate the receiving antenna.
- Increase the separation between the equipment and receiver.
- Connect the equipment into an outlet on a circuit different from that to which the receiver is connected.
- Consult the dealer or an experienced radio/TV technician for help.

H010 En

Information to User

Alteration or modifications carried out without appropriate authorization may invalidate the user's right to operate the equipment.

H011 En

CAUTION:

This product satisfies FCC regulations when shielded cables and connectors are used to connect the unit to other equipment. To prevent electromagnetic interference with electric appliances such as radios and televisions, use shielded cables and connectors for connections.

H012 En

Maintenance of External Surfaces

- Use a polishing cloth or dry cloth to wipe off dust and dirt.
- When the surfaces are dirty, wipe with a soft cloth dipped in some neutral cleanser diluted five or six times with water, and wrung out well, and then wipe again with a dry cloth. Do not use furniture wax or cleaners.
- Never use thinners, benzine, insecticide sprays or other chemicals on or near this unit, since these will corrode the surfaces.

K023En

Regarding Installation

This product is sold with the understanding that it will be installed and calibrated only by a trained service professional with specialized technical skills. When installing this unit, be sure to consult a professional installer or your dealer. Pioneer disclaims all responsibility for any losses resulting from improper installation, misuse of, modifications or damage to this unit.



Dear Customer:

Selecting fine audio equipment such as the unit you've just purchased is only the start of your musical enjoyment. Now it's time to consider how you can maximize the fun and excitement our equipment offers. This manufacturer and the Electronic Industries Association's Consumer Electronics Group want you to get the most out of your equipment by playing it at a safe level. One that lets the sound come through loud and clear without annoying blaring or distortion-and, most importantly, without affecting your sensitive hearing.

Sound can be deceiving. Over time your hearing "comfort level" adapts to higher volumes of sound. So what sounds "normal" can actually be loud and harmful to your hearing. Guard against this by setting your equipment at a safe level BEFORE your hearing adapts.

To establish a safe level:

- Start your volume control at a low setting.
- Slowly increase the sound until you can hear it comfortably and clearly, and without distortion.

Once you have established a comfortable sound level:

- Set the dial and leave it there.

Taking a minute to do this now will help to prevent hearing damage or loss in the future. After all, we want you listening for a lifetime.

We Want You Listening For A Lifetime

Used wisely, your new sound equipment will provide a lifetime of fun and enjoyment. Since hearing damage from loud noise is often undetectable until it is too late, this manufacturer and the Electronic Industries Association's Consumer Electronics Group recommend you avoid prolonged exposure to excessive noise. This list of sound levels is included for your protection.

Decibel

Level	Example
30	Quiet library, soft whispers
40	Living room, refrigerator, bedroom away from traffic
50	Light traffic, normal conversation, quiet office
60	Air conditioner at 20 feet, sewing machine
70	Vacuum cleaner, hair dryer, noisy restaurant
80	Average city traffic, garbage disposals, alarm clock at two feet.

THE FOLLOWING NOISES CAN BE DANGEROUS UNDER CONSTANT EXPOSURE

90	Subway, motorcycle, truck traffic, lawn mower
100	Garbage truck, chain saw, pneumatic drill
120	Rock band concert in front of speakers, thunderclap
140	Gunshot blast, jet plane
180	Rocket launching pad

Information courtesy of the Deafness Research Foundation.



S001 En

Contents

Preface

Safety Precautions	2
Features	6
Confirm All Accessories	8
Specifications	9

Parts and their Functions

Front Panel	10
Attaching the Front Grill	11
Range of the Remote Control Unit	11
Rear Panel	12
Turning the Main Power ON/OFF	12
About the Input/Output Connectors	13
Remote Control Unit	14
Setting the Basic Information on the Remote Control Unit	15
Recharging the Remote Control Unit	16

Using the Digital Sound Projector

Using the Remote Control Unit	17
Watching Television	21
Watching a DVD	22
Using a Pioneer DVD Recorder	23
Recording	23
Playback/Editing	24
Selecting the Audio Mode	25
Listening to Stereo Sound in Surround Mode	25
Enhancing Monaural Sources	26

Adjusting the Sound

Changing Surround Sound	27
Adjusting the Tone	31
Calling Up a Room Sound Setting	32
Video and Audio Timing Compensations (Lipsync delay)	33
Adjusting Surround Effects	34
Displaying the Data Screen	37

Additional Information

Troubleshooting	38
Table of Remote Control Unit Menu Displays	40
Index	42



Regarding Installation and Initial Settings

All aspects of installation, connection, and initial surround calibration and setup of the Pioneer Digital Sound Projector PDSP-1 are to be performed by trained service personnel. Please consult your dealer if you want to change the installation location, or if major modifications are required to the initial calibration settings.

Features

This digital sound projector is a totally new product unlike conventional home theater systems. It produces multi-channel surround sound from a single speaker array, without the need for numerous speaker settings and wiring hassles.

The following section introduces the features that enable the PDSP-1 to produce its remarkable new sound.

1. Beam control technology BEAM CONTROL TECHNOLOGY

254 individually driven speaker units are arranged in an array on a single panel, and the directionally controlled audio from this array is radiated in a beam. The sound of each channel radiated in this beam utilizes the reflectivity of ceiling and walls to produce multi-channel sound.

Audio beam image

The accompanying illustration depicts the way in which the sound beam radiated from the PDSP-1 arrives at the listening position. In this way, surround sound is produced that totally envelops the listener.

Front left-right channel

Rear left-right channel

Center channel

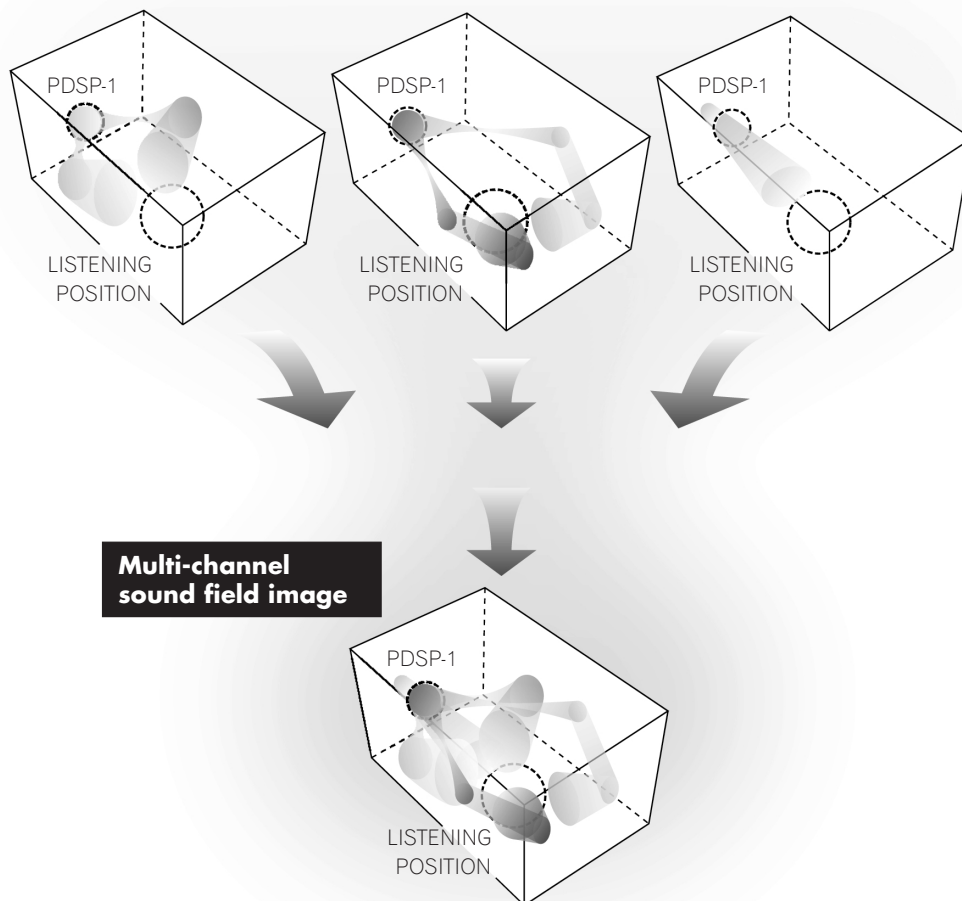

2. Sound settings to match your room's characteristics

The professional installation technician uses a special metering microphone and computer to set up the unit with the optimum sound response and characteristics for your room. Since multiple sound settings are possible for any room, this unit makes it possible for you to call up preset sound environments to change the sound field in accordance with listening conditions.

3. Equipped with Dolby Digital and Pro Logic II, Digital Theater System (DTS) Decoder

In addition to Dolby Digital – the DVD video standard audio format – this unit also supports Dolby Pro Logic II, which allows you to play 2-channel sources with multi-channel ambience, and DTS, which produces high sound quality with low compression ratios and high transmission rates. These features allow you to enjoy multi-channel movie-theater ambience inside your own home.

Manufactured under license from Dolby Laboratories. "Dolby", "Pro Logic", and the double-D symbol are trademarks of Dolby Laboratories.

"DTS" and "DTS Digital Surround" are registered trademarks of Digital Theater Systems, Inc.

Manufactured under license from 1 Ltd. World-wide patents applied for. The "Ⓢ" logo and "Digital Sound Projector" are trademarks of 1 Ltd.



"Calling Up a Room Sound Setting" → P32



"Selecting the Audio Mode"
(Dolby Pro Logic II) → P25

Confirm All Accessories

The digital sound projector is provided with the following accessories:

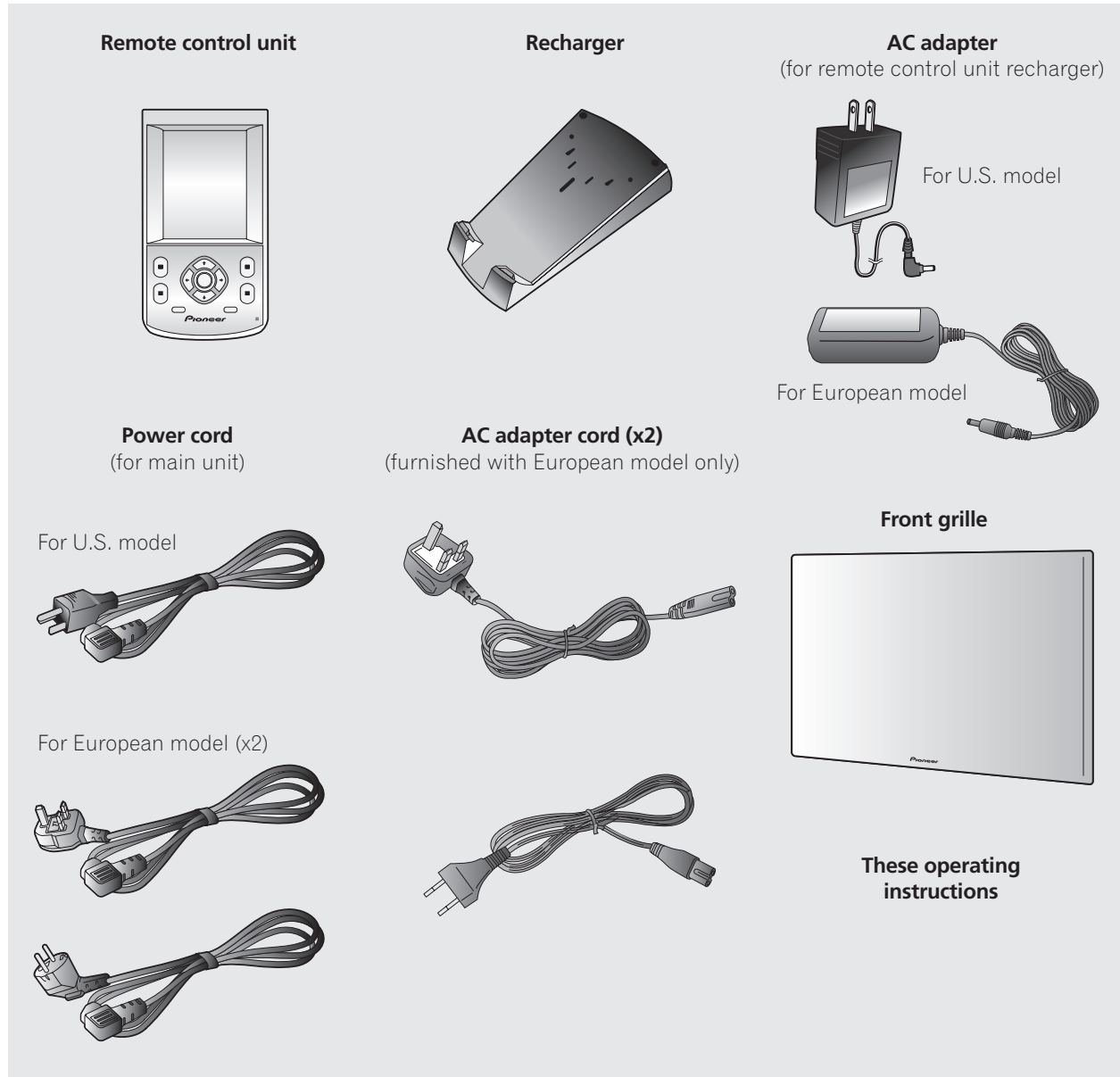

Note:

- ☑ When disposing of used batteries, please comply with governmental regulations or environmental public instruction's rules that apply in your country or area.

H048 En

Caution:

- ⚠ Danger of explosion if battery is incorrectly replaced.
Replaced only with the same or equivalent type recommended by the manufacturer.
Discard used batteries according to the manufacturer's instructions.

H027A En

Specifications

Audio Section	Rated output (RMS, 80 Hz – 20 kHz)	2 W x 254 units
	Maximum output (80 Hz – 20 kHz, 1 m)	115 dBspl
	Tone control: BASS (40 Hz – 320 Hz)	± 12 dB
	TREBLE (6.3 kHz – 16 kHz)	± 12 dB
	Sub-woofer crossover frequency	40 Hz – 200 Hz
	Output level / impedance	1.0 Vp-p / 100 Ω
	Input sensitivity / impedance	150 mVp-p / 47 k Ω
Video Section	Speaker response	80 Hz – 20 kHz, ± 3dB
	Video connectors (level / impedance)	1.0 Vp-p / 75 Ω
	S/N ratio	55 dB
	Frequency response (output connectors)	5 Hz – 10 MHz, –3 dB
Power Section	Power source	AC 120 V, 60 Hz (U.S. model) AC 100 – 240 V, 50/60 Hz (European model)
	Power consumption	750 W
	Power consumption in standby mode	3 W
External Dimensions	963 (W) x 640 (H) x 146 (D) mm (37 ⁻¹⁵ / ₁₆ (W) x 25 ⁻⁴ / ₁₆ (H) x 5 ⁻¹² / ₁₆ (D) in.)	
Weight of Main Unit	50 kg (110 lb 4 oz) (including front grille)	
Accessories	Remote control unit	
	Recharger	
	AC Adapter (AC 120 V, 50/60 Hz, rated voltage 6 V) (U.S. model)	
	(AC 100 – 240 V, 50/60 Hz, rated voltage 6 V) (European model)	
	AC adapter cord (furnished with European model only)	
	Power cord	
	Front grille	
Operating Instructions		

Note:

 Specifications and the design are subject to possible modifications without notice, due to improvements.



Front Panel

Indicators for power and volume level, and the remote control unit sensor are located on the lower part of the panel.

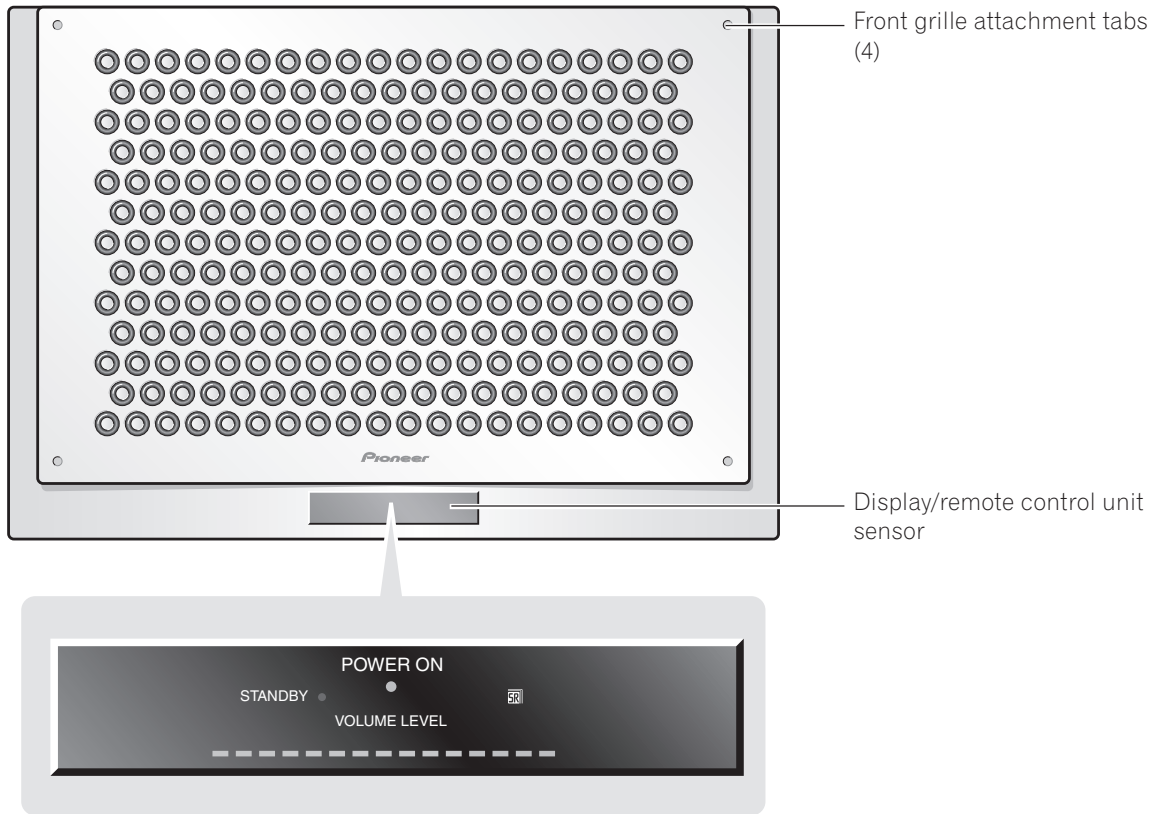

Display	Meaning/Operation
POWER ON (Blue)	Lights when power is turned ON
STANDBY (Red)	Lights in power standby mode
VOLUME LEVEL	Indicates sound volume

Attaching the Front Grille

Align the grille with the four attachment tabs on the front panel, then push into place.

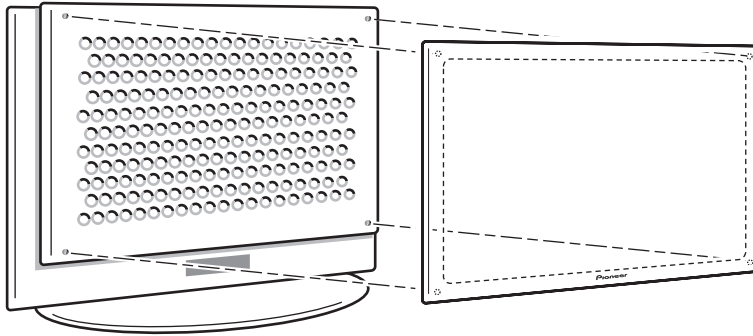

Range of the Remote Control Unit

Operate the remote control unit while pointing it toward the Digital Sound Projector's remote control sensor within the range shown.

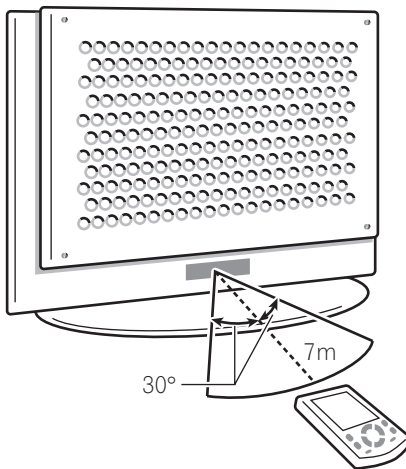

Caution:

⚠ Do not expose the remote control sensor to direct sunlight or other strong light sources.



■ Rear Panel ■

The main power switch, power cord socket, and input/output connectors are located on the rear panel.

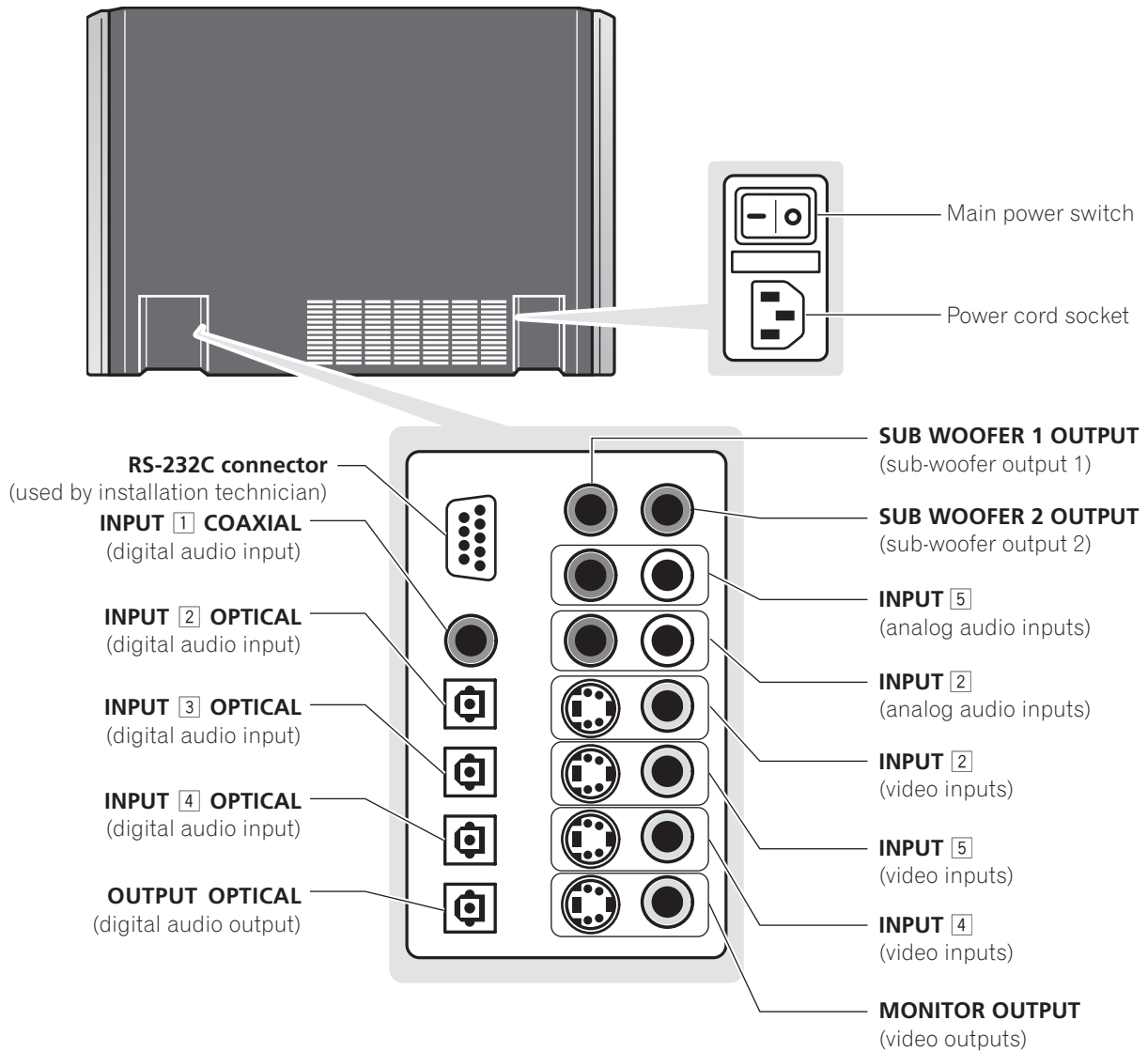

■ Turning the Main Power ON/OFF ■

- 1** Connect the supplied power cord to the rear panel power cord socket, and then insert the plug in a household power outlet.
- 2** Turn the main power ON/OFF by setting the main power switch to the [-] (ON) or [o] (OFF) sides.

Caution:

- 1** Do not use any power cord other than the one supplied.

■ About the Input/Output Connectors ■

Caution:

- ⚠ **Before making or changing the connections, switch off the power and disconnect the power cord from the AC outlet.**

Audio output (OUTPUT OPTICAL connector)

Use to connect MD recorders, CD recorders and other digital recording components. These connectors output the digital signals from inputs **1** to **4**.

Video outputs (MONITOR OUTPUT connectors)

Use to connect a television monitor or other video component.

Note:

- ☑ The selection of S or composite connectors should match the selection on the signal input side. (If an S2 video input is used, use the S output connector; if the input is composite, use the composite output connector as well).

SUB WOOFER OUTPUT connectors

Up to two sub-woofers can be connected.

Note:

- ☑ Sub-woofers reproduce very low-frequency sound; coupled with the LFE (Low-Frequency Effect) channels encoded in Dolby digital and DTS audio sources, these speakers produce sounds effects which heighten the impact and realism of motion picture sound tracks and other sources.

INPUT **1** – **5** connectors

The digital sound projector is equipped with 5 input connector systems which can be combined in the ways shown below. The various inputs can be selected by using the **INPUT 1** to **INPUT 5** or **INPUT** buttons on the remote control unit.

INPUT	Audio Connector	Video Connector
1	Coaxial digital	– (no video)
2	Optical digital/analog	S / Composite
3	Optical digital	– (no video)
4	Optical digital	S / Composite
5	Analog	S / Composite

Note:

- ☑ Input **2** provides for automatic sensing of digital and analog sources. In the event that both digital and analog signals are simultaneously input to the digital sound projector, the digital signal is given priority.

Remote Control Unit

The touch panel appears when the LCD touch panel is touched or a remote control unit button (hard key) is pressed.

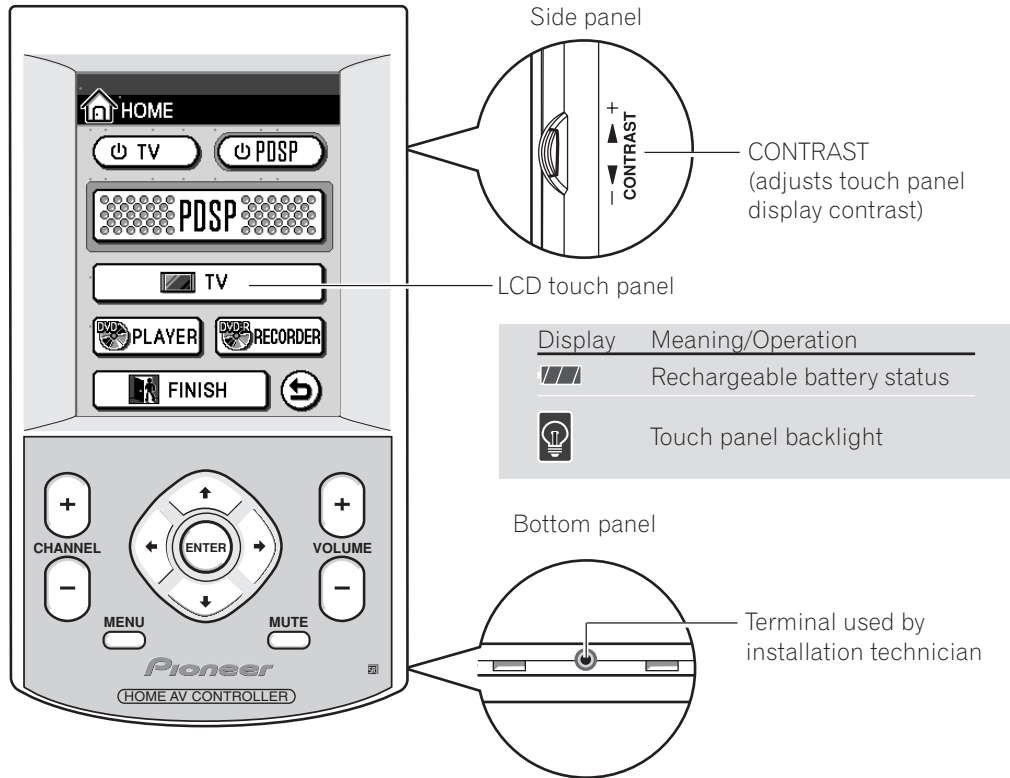

About the Remote Control Unit Buttons (hard keys)

Button	Meaning/Operation
CHANNEL	Use to select channels
MENU	Use to turn the menu display ON/OFF
ENTER	Use to select and input menu display operations
VOLUME	Use to adjust sound volume level
MUTE	Use to temporarily turn off sound

Note:

- The remote control unit buttons (hard keys) differ in function depending on which component has been selected on the touch panel. For details, see the section "Table of Remote Control Unit Menu Displays" (P40).



"Using the Remote Control Unit"
"Component Operation Menu Display" → P17



"Touch panel menus don't change"
"Resetting the Remote Control Unit" → P39

Setting the Basic Information on the Remote Control Unit

Seven items, including current time display and beep volume can be set on the remote control unit.

1 Set the touch panel to the HOME menu.

If the touch panel shows any display other than the HOME menu, press the  mark at the bottom.

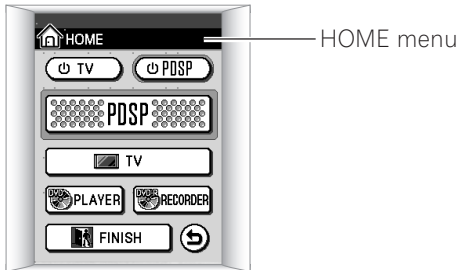



2 Press the "" mark at the top left.

The setting menu will be displayed.

Use the arrows   on the touch panel to switch between the two menu screens.



3 Follow the instructions on the screen to change the items you want.

Item	Select	Setting Contents
CLOCK DISPLAY	12-hour or 24-hour display	Type of clock display
CLOCK SETTING	Year/Month/Day/Hour/Minute	Date and Time
BEEP	 /  / OFF	Sound volume of beep when touch panel is pressed
LCD TIMEOUT	20-120 seconds	Touch panel OFF time (if no remote control unit operation is performed during the set time, the display will automatically turn off to conserve power).
BACKLIGHT TIMEOUT	20-120 seconds	How long the display illumination remains on when  is pressed.
CALIBRATE		Fine adjustment of display screen position

4 Once the settings are completed, press or .

The screen returns to the HOME menu.

Recharging the Remote Control Unit

- 1 Connect the accessory AC adapter to the recharger and a household AC outlet.

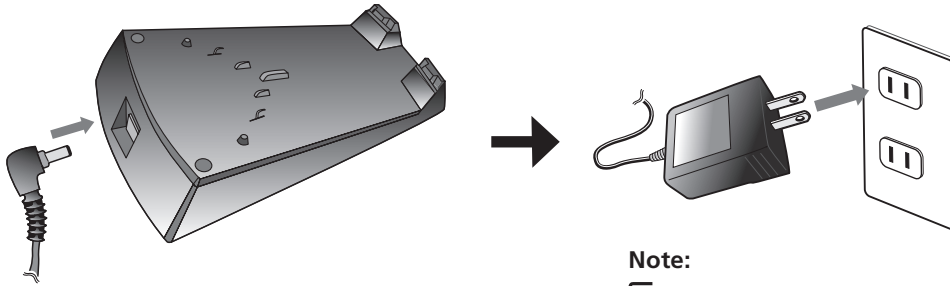

Note:

 Illustration depicts U.S. model.

- 2 Place the remote control unit on the recharger, aligning the indents on the remote control unit with the tabs on the recharger.

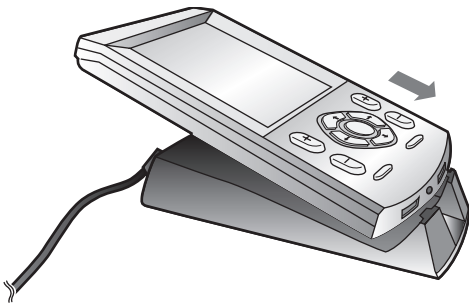

Note:

 During recharging, the indicator shown below will appear on the upper right corner of the display.

Recharging indicator



Caution:

 Do not use AC adapters other than the one supplied.









"Can't recharge remote control unit" → P39

Using the Remote Control Unit

The remote control unit's buttons and touch panel can be used to control components connected to the digital sound projector.

Component Operation Menu Display

When using the remote control unit to control the digital sound projector and video components, menu displays are provided for the current component being used. The remote control unit has the following component menu displays:

Operation Menu	Meaning/Contents
 HOME	HOME menu
 PDSP	Operate Digital Sound Projector
 TV	Operate television monitor
 DVD PLAYER	Operate DVD player
 DVD RECORDER	Playback/edit on Pioneer DVD recorder
 DVD RECORDER	Record on Pioneer DVD recorder

Note:

 The currently selected menu screen can be confirmed by looking in the upper left corner of the touch panel.



"About the Remote Control Unit Buttons (hard keys)" → P14



"Table of Remote Control Unit Menu Displays" → P40

▮ About the HOME Menu ▮

This is the basic touch panel menu. From this menu screen, the operating menus for various connected components can be selected.



Display	Meaning/Operation
	Turns television power ON/OFF
	Turns digital sound projector power ON/OFF
	Selects the digital sound projector operating menu (→ P19)
	Selects the TV operating menu (→ P21)
	Selects the DVD player operating menu (→ P22)
	Selects the DVD recorder operating menu (→ P24)
	Turns off power to all connected components
	Returns to previous menu



"Setting the Basic Information on the Remote Control Unit" → P15

▮ About the PDSP (digital sound projector) menu ▮

When using the digital sound projector with other components, this menu screen is used to select operation of other components. This menu is also used to select signal inputs (input **1** to **5**).

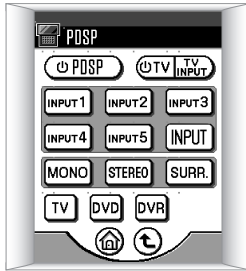

Display	Meaning/Operation
	Turns digital sound projector power ON/OFF
	Turns television power ON/OFF
	Selects input 1 to 5
	Alternates between inputs 1 to 5
	Selects the TV operating menu (➔ P21)
	Selects the DVD player operating menu (➔ P22)
	Selects the DVD recorder operating menu (➔ P24)
	Returns to previous menu
	Returns to HOME menu



"INPUT **1** - **5** connectors" ➔ P13

Operating Menus for Other Components

Use the operating menus for connected components (DVD player, television, etc.) according to the typical functions and operations of the respective component. Other operating menu items appear as follows:

Example:
Television Operating Menu

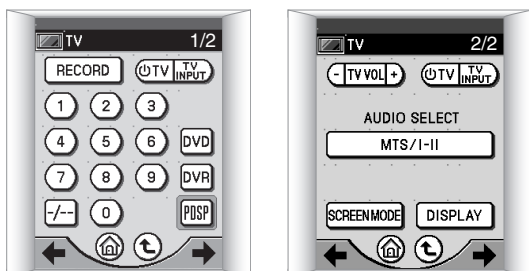

Display	Meaning/Operation
	Selects the PDSP menu (→ P19)
	Selects the recording menu for DVD recorder (→ P23)
	Returns to HOME menu
	Returns to previous menu
	Changes between the menu screens (1/2, 2/2)

Watching Television

Use this menu to operate a connected television.



1



Turn on power to digital sound projector.

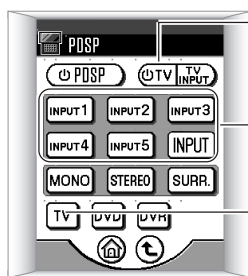

2



Turn on power to television.

3



Select input connected to television sound.

4



Change to television operating menu.



5

TV VOLUME

Reduce television's built-in speakers so as not to affect sound from digital sound projector.

6

To next operation.

7

The lower two menu screens are used to operate the television.

Use the arrows on the touch panel to alternate between the two menus.

Television Operating Menus (2 screens)

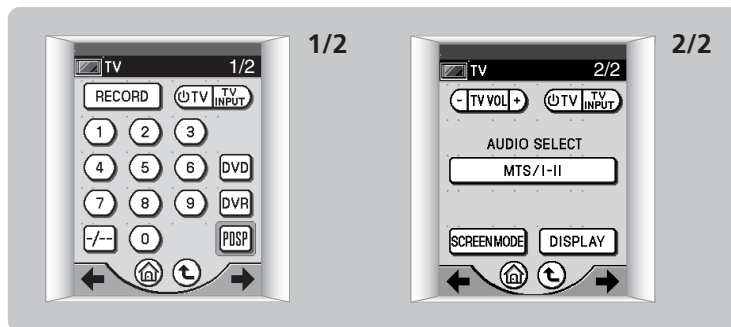

Note:

- When is pressed in step 1, the television operating screen shown in 7 appears, and the television can be operated without using the digital sound projector. Note that in this case, the item does not appear on the 2/2 menu, with the result that the remote control unit's volume button (hard key) must be used to adjust the television sound volume.



"About the Remote Control Unit Buttons (hard keys)" → P14



"Table of Remote Control Unit Menu Displays" → P40

Watching a DVD

Use this menu to operate a connected DVD player.

- 1** Turn on the power to the digital sound projector.
- 2** Turn on the power to the television monitor.
- 3** Set television input to digital sound projector.
- 4** Select the input connected to the DVD player.
- 5** Change to DVD player operating menu.
- 6** **The accompanying three menus are used to operate the DVD player.**
Use the arrows on the touch panel to change between the menu screens.

DVD Player Operating Menus (3 screens)

Notes:

- If a Pioneer DVD player is connected, the DVD player's power will turn on in step **5**.
- If is pressed in step **1**, the DVD player operating menus shown in step **6** will appear, and it will be possible to operate the DVD player without using the digital sound projector.



"INPUT 1 - 5 connectors" → P13

Using a Pioneer DVD Recorder

Use this menu to operate a connected Pioneer DVD Recorder.

Recording

To record the program currently playing on the television, follow the steps listed below.



Steps **1** – **6** are the same as steps **1** – **6** on P21 "Watching Television".

- 7** **RECORD**
Change to recording menu on DVD recorder.

DVD Recorder: Recording Menu (2 screens)



- 8** Perform recording operations on menu 1/2 at left.

HDD/DVD:	Selects type of disk for recording (HDD/DVD)
DISPLAY:	Displays disc information
REC MODE:	Selects recording mode FINE/SP/LP/EP
AUDIO:	Selects audio channel for recording (main/sub)
REC:	Starts recording
STOP REC:	Stops recording

Note:

- Press **→** on the first screen to change to menu screen 2/2; this menu allows playback and confirmation of recorded contents.



"Watching Television" → P21



Playback/Editing



1



Change to digital sound projector menu.



2



Turn on TV power.

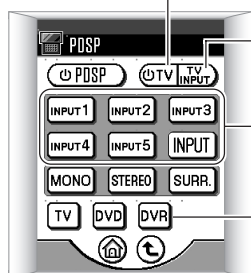

3



Set television video input to digital surround projector.

4



Select input connected to DVD recorder.

5



Change to DVD recorder operation menu.

6

The following four menus are used to operate the DVD recorder.

Use the arrows ← → on the touch panel to change between the menu screens.

DVD Recorder Operating Menus (4 screens)

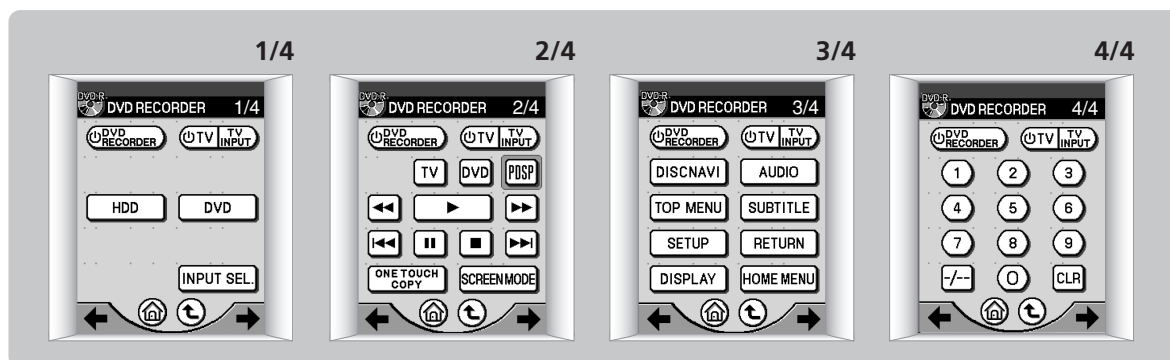

Note:

When is pressed in step 1, the DVD recorder operating menu shown in 6 appears, and the DVD recorder can be operated without using the digital sound projector.

Caution:

Some operations may not be possible, depending on the specific model of Pioneer DVD Recorder connected.

Selecting the Audio Mode

Listening to Stereo Sound in Surround Mode

Stereo broadcasts, CD playback and other 2-channel sounds can be enjoyed in surround sound mode.

1 Set the touch panel to the PDSP menu.

From the HOME menu, press ; from other menus, press .

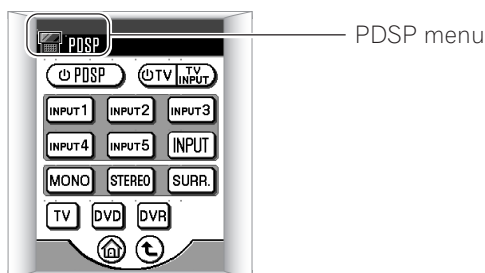

2 Press .

The television screen will display the audio mode.

Each time the button is pressed, the audio mode will change in the following order.

PLII Movie

PLII Movie: Pro Logic II Movie

This mode is designed for use with film soundtracks, and allows actors' dialogue to be heard from the most natural direction.

PLII Music

PLII Music: Pro Logic II Music

This mode is designed for use with music sources. The surround effect recreates the ambience experienced in live performances.

Pro Logic

Pro Logic:

The Pro Logic Mode is generally designed for general use with movie soundtracks. The rear channel track is heard in monaural surround.

Stereo

Stereo:

The stereo mode is a two-channel mode; when this mode is selected, even multi-channel sources are played back in two channels, and heard from the front right and left.

Notes:

- If  is pressed during playback of Dolby Digital and other surround sources, the following message will be displayed:

Dolby Digital

- If  is pressed in step 2, the unit will change to stereo mode.



"Fine Tuning the PLII Music Mode" → P35

Enhancing Monaural Sources

When listening to older movies and CDs, and other sources recorded in monaural sound, the sound will seem more natural when heard from the center channel alone, rather from the front two channels (right and left).

1 Set the touch panel to the PDSP menu.

From the HOME menu, press ; from other operation menus, press .

2 Press .

The "Mono" indicator will appear on the television screen.

Each time the button is pressed, the monaural mode alternates between ON and OFF.



Mono

Caution:

 When adjusting the digital sound projector's sound, the menu screen is displayed on the connected television monitor. To see the display, turn on the television's power and set the television's video input to the digital sound projector.

Note:

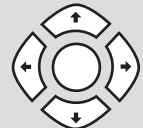
 When adjusting the digital sound projector's sound, use the following buttons (hard keys) of the remote control unit:

Button	Name	Function
	MENU	Open/Close the menu screen
		Move cursor / select items and numbers
	ENTER	Finalize settings



Changing Surround Sound

You can adjust each channel's volume/balance while listening to the actual sound, as well as adjusting the sub-woofer and other options.

Test Signal

A test signal can be used to adjust the output level of each channel.

- 1 Use the touch panel to select the  PDSP menu.**
From the HOME menu, press ; from other menus, press .
- 2 Press the MENU button.**
The following "System Setup" menu appears.

System Setup
 → 1 Surround Setup
 2 All Ch Tone Control
 3 Recall Memory
 4 Lipsync delay
 5 Stereo Mode



"Digital sound projector menu screens don't appear" → P38



"Changing Each Channel's Output Level" → P29

3 Using the ↑↓←→ buttons, select "Surround Setup", and press the ENTER button.

The following screen appears:

Surround Setup		
→ 1 Left	0.0dB	Front left channel
2 Right	0.0dB	Front right channel
3 Surround L	0.0dB	Rear left channel
4 Surround R	0.0dB	Rear right channel
5 Center	0.0dB	Center channel
6 Aux Center	Mute	
7 Bass Management		
8 Noise Source	off	

Note:

☰ "Aux Center" is an additional center channel. To use the "Aux Center" channel, a special dedicated setting is required; consult your installation service personnel.

4 Using the ↑↓←→ buttons, select "Noise Source", and press the ENTER button.

The following screen appears:

Noise Source	
→ 1 Off	
2 Left	
3 Right	
4 Surround L	
5 Surround R	
6 Center	
7 Aux Center	
8 LFE	

5 Using the ↑↓←→ buttons, select the channel, and press the ENTER button.

The test signal will be produced from the selected channel.



Changing Each Channel's Output Level

1 - 3 (Same as steps 1 - 3 on P27, "Test Signal")

The following screen appears:

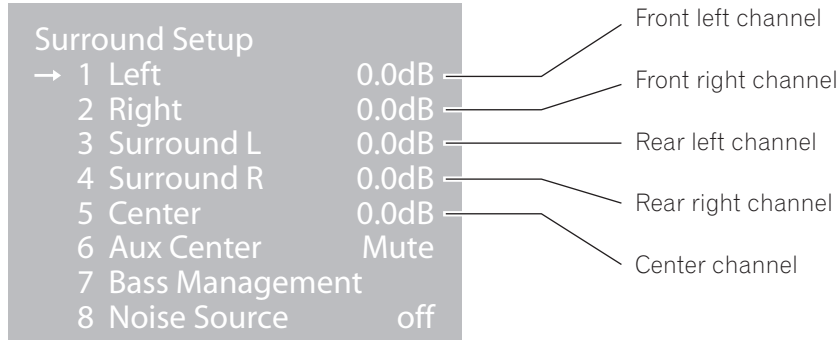

4 Using the ↑↓←→ buttons, select the desired channel, then press the ENTER button.

The following screen appears:

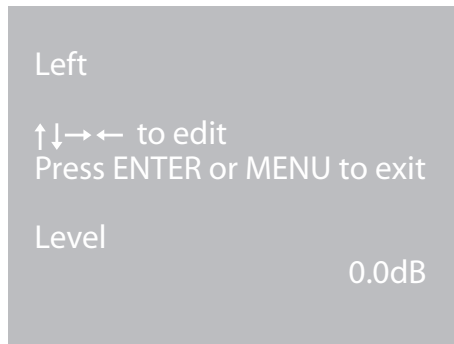

5 Using the ↑↓←→ buttons, adjust the output level as desired, then press the ENTER button. Adjust the output level while listening to the test signal.

Setting range: 0.0 dB – 12.0 dB

Note:

When you're finished, you can press the MENU button repeatedly to return to previous screens.



Sub Woofer / Bass Management

This menu allows you to set the unit for a sub-woofer, and LFE channel ON/OFF.

1 - 3 (Same as steps 1 - 3 on P27, "Test Signal")

4 Using the **↑↓←→** buttons, select "Bass Management", and press the ENTER button.

The following screen appears:

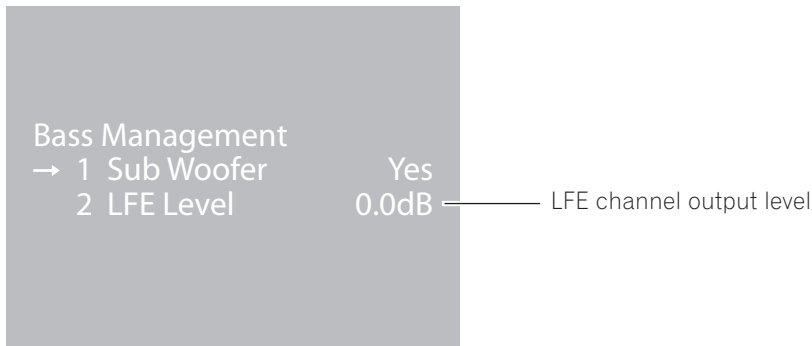

Notes:

LFE means "Low Frequency Effect".

If "Sub Woofer" is set to "Yes", use the **↑↓** buttons to select "LFE level", then use the **←→** buttons to adjust the output level.

Setting range: 0.0 dB – 12.0 dB

5 Using the **↑↓←→** buttons, select "Sub Woofer", then press the ENTER button.

The following screen appears:

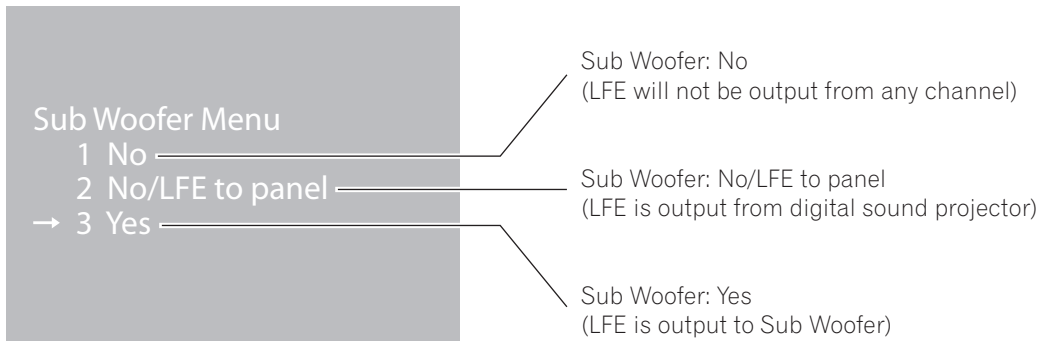

6 Using the **↑↓←→** buttons, select either "No," "No/LFE to panel," or "Yes," then press the ENTER button.

Note:







When you're finished, you can press the MENU button repeatedly to return to previous screens.





"SUB WOOFER OUTPUT connectors" → P13

Adjusting the Tone

You can adjust the overall tone for all audio channels.

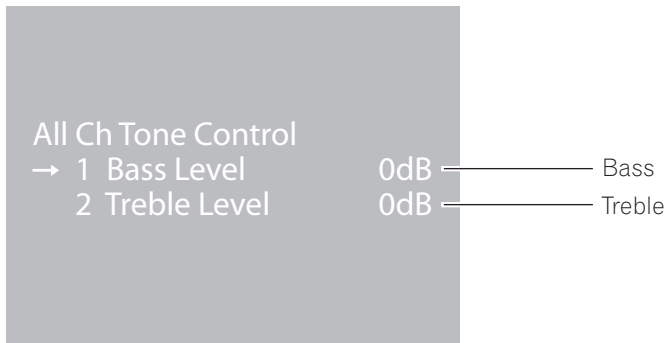
- 1 Use the touch panel to select the  PDSP menu.**
From the HOME menu press ; from other menus, press .
- 2 Press the MENU button.**
The "System Setup" menu screen appears.
- 3 Using the     buttons, select "All Ch Tone Control", and press the ENTER button.**
The following screen appears:



- 4 Using the     buttons, select either "Bass Level" or "Treble Level", then press the ENTER button.**
The following screen appears:

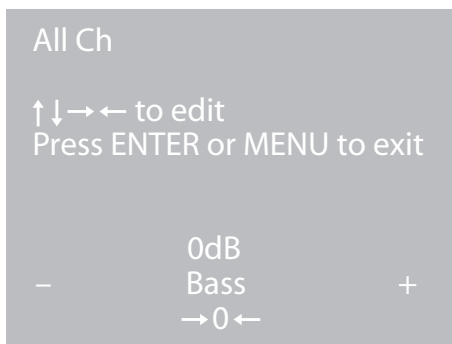

- 5 Using the     buttons, adjust the tone level as desired, then press the ENTER button.**







Setting range: -12 dB – +12 dB

Note:

 When you're finished, you can press the MENU button repeatedly to return to previous screens.

Calling Up a Room Sound Setting

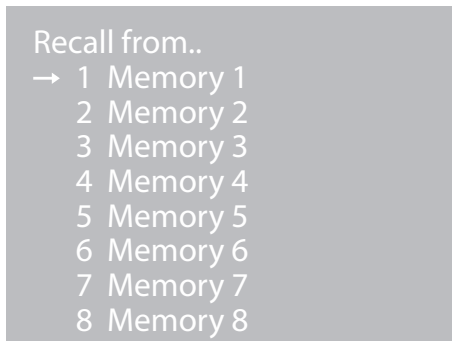

Multiple sound settings can be recorded in accordance with measured room characteristics. Select the setting that produces the optimum listening environment.

- 1 Use the touch panel to select the  PDSP menu.**
From the HOME menu press ; from other menus, press .
- 2 Press the MENU button.**
The "System Setup" menu display appears.
- 3 Using the     buttons, select "Recall Memory", then press the ENTER button.**
The following screen appears.









- 4 Using the     buttons, select the desired sound setting, then press the ENTER button.**

Notes:





-  When you're finished, you can press the MENU button repeatedly to return to previous screens.
-  A maximum of eight room sound settings can be stored in memory. Consult your installation service personnel regarding the settings that will work best with your room.

Video and Audio Timing Compensations (Lipsync delay)

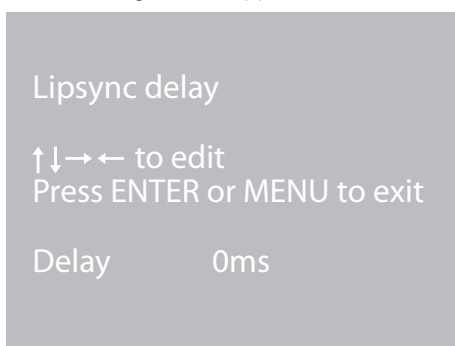

The video playback from some components may appear somewhat delayed from the audio channel. If actors' mouth movements appear to be out of sync with the audible soundtrack, use this adjustment to delay (compensate) the audio timing.

- 1 Use the touch panel to select the  PDSF menu.**
From the HOME menu press ; from other menus, press .
- 2 Press the MENU button.**
The "System Setup" menu appears.
- 3 Using the     buttons, select "Lipsync delay", then press the ENTER button.**
The following screen appears:



- 4 Using the     buttons, adjust the amount of delay as desired, then press the ENTER button.**
Perform this adjustment while confirming the actual video-audio timing.

Notes:

-  The maximum adjustment value will be less than 106 ms, as a result of the initial room setting made by the service personnel.
-  When you're finished, you can press the MENU button repeatedly to return to previous screens.









Adjusting Surround Effects







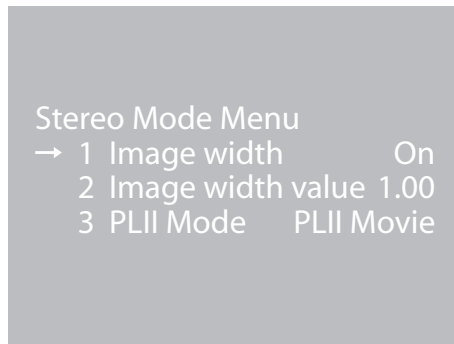

Narrowing the audio width of the front right-left channels (Image width)

As a characteristic of the digital sound projector, when the room's right and left walls are far apart, some playback sources may sound overly separated.

This function allows you to adjust the width of the sound image to a narrow perspective, thus producing a more natural sound image.



- 1 Use the touch panel to select the  PDSP menu.**
From the HOME menu press ; from other menus, press .
- 2 Press the MENU button.**
The "System Setup" menu screen appears.
- 3 Using the     buttons, select "Stereo Mode", then press the ENTER button.**
The following screen appears:



- 4 Using the   buttons, select "Image width", then use the   buttons to select "On".**
- 5 Using the   buttons, select "Image width value", then use the   buttons to adjust the value as desired; when done, press the ENTER button.**

Setting range: 0.00 – 1.00 (1.00 when setting is OFF)







Notes:

-  Setting value 1.00 is for stereo sound (sound width spread to front right-left).
Setting value 0.00 is monaural (sound spread is narrowed and produced only from the center channel).
-  When you're finished, you can press the MENU button repeatedly to return to previous screens.



▮ Fine Tuning the PLII Music Mode ▮

When listening to a two-channel source in surround sound using the PLII Music mode, you can fine tune the effect from the "Stereo Mode Menu".

- 1 Use the touch panel to select the  PDSP menu.**
From the HOME menu press ; from other menus, press .
- 2 Press the MENU button.**
The "System Setup" menu screen appears.
- 3 Using the  buttons, select "Stereo Mode", then press the ENTER button.**
The following screen appears:

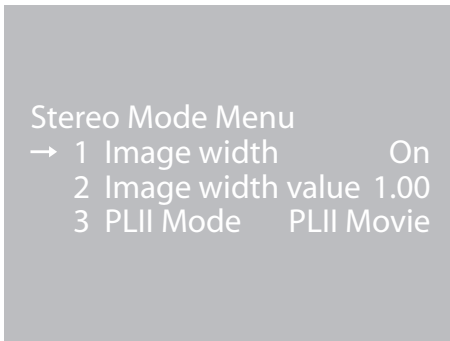

- 4 Using the  buttons, select "PLII Mode", then press the ENTER button.**
The following screen appears:



"Selecting the Audio Mode"
(Dolby Pro Logic II) → P25

5 Using the **↑↓←→** buttons, select “Music”, then press the **ENTER** button.

6 Using the **↑↓** buttons, select “Panorama”, “Center width”, or “Dimension”, then use the **←→** buttons to set the effect as desired.

```

Stereo Mode Menu
  1 Image width           On
  2 Image width value 1.00
→ 3 PLII Mode           PLII Music
  4 Panorama              Off
  5 Center width         0
  6 Dimension            3
  
```

Display	Setting	Effect
Panorama	On/Off	The front sound image expands toward the rear as well, enveloping the listener in surround sound.
Center width	0-7	Adjusts the audible width of the center channel (0 means sound is produced from the center channel; as the numerical value rises, the sound width expands, until at 7 the sound is produced from the front right-left channels).
Dimension	0-6	Shifts the surround effect balance between front and back (0 means sound is toward the front; as the numerical value increases, the balance shifts toward the back, until at 6 it is produced from the rear channel).

Note:

 When you're finished, you can press the **MENU** button repeatedly to return to previous screens.

Displaying the Data Screen

Use this function to confirm information about the currently playing audio and video source, and room sound settings.

- 1 Use the touch panel to select the PDSP menu.**
From the HOME menu press ; from other menus, press .
- 2 Press the ENTER button.**
The "Status" menu screen appears as shown below.

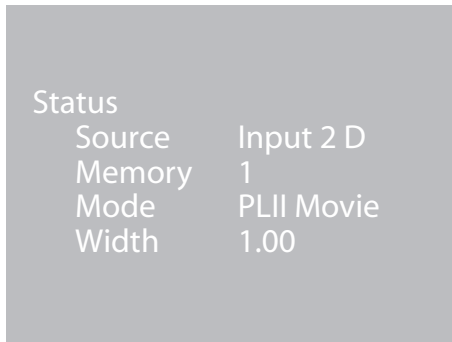

Item	Contents	Display Example
Source	Input/Signal type	Input 1-5, 2D (digital), 2A (analog)
Memory	Preset sound setting	1-8, * (when a change has occurred to the called-up sound setting)
Mode	Audio mode type	PLII Movie, PLII Music, Pro Logic, Stereo, Mono
Width	Image width setting	0.00-1.00 (image width setting value), Off

- 3 After confirming the data, press the ENTER button.**
The "Status" menu screen disappears.



"INPUT [1] - [5] connectors" → P13



"Calling Up a Room Sound Setting"
(Memory 1-8) → P32



"Selecting the Audio Mode"
(Dolby Pro Logic II) → P25



"Adjusting Surround Effects"
(Image width) → P34

Troubleshooting

Many malfunctions can be the result of operating errors. If you experience trouble with the digital sound projector, use this troubleshooting guide together with thorough checks of the other components in your system. If the problem is not corrected after doing so, consult your authorized service center.

Sound Problems?



No sound

- Use the remote control unit's PDSP menu to check INPUTs 1-5, and confirm you have selected the correct input. **P19**
- Check the front panel VOLUME LEVEL indicator to confirm whether the MUTE button has been pressed, or if the sound volume has been set to its minimum setting. **P10**
- Confirm that the digital sound projector's main power is turned ON and that the front panel's POWER ON indicator (Blue) is lighted. **P10**

Sound has a poor surround effect

- Confirm whether the audio mode has been set to "Mono" for monaural sound. **P26**
- Confirm whether the audio mode has been set to "Stereo" for stereo sound. **P25**
- Check the playback source to confirm that it is a multi-channel source.

Sound has poor balance

- Confirm that the proper room sound setting has been chosen. **P32**
- If the digital sound projector has been physically moved, or if the furniture in the room been significantly rearranged or changed, consult your installation technician to have the digital sound projector recalibrated for the new room environment.

No sound from the connected sub-woofer, or sound volume is too low

- Confirm whether the sub-woofer's output level has been set low. **P30**

Recording isn't possible on the connected components

- If the playback source is a digital signal, it may be protected with a copyguard function, in which case it cannot be recorded. In this case, use an analog connection between the playback component and recording component, and record the source in analog mode.

Video Problems?



Digital sound projector menu screens don't appear

- Confirm that the proper video input has been selected on the television monitor.

No image is visible on the connected TV monitor.

- Confirm that the proper video input has been selected on the television monitor.

Problems with Use or Operation?



Can't recharge remote control unit

P16

- Check the recharge indicator in the upper right corner of the remote control unit's touch panel to confirm whether the remote control unit is sitting on the recharger and recharging correctly.
- If the remote control unit's battery won't hold a sufficient charge to allow use of the remote control unit even after proper recharging, the unit's Lithium-ion battery may require replacing. In this event, consult your authorized Pioneer service center. The remote control unit's Lithium-ion battery cannot be purchased at any location other than an authorized Pioneer service center.

Remote control unit doesn't work

P10

- Check that the main power switch is turned on, the power cord is connected securely, and the front panel's POWER ON (Blue) or STANDBY (Red) indicator is lighted.
- Check the remote control unit's remaining charge indicator to confirm that the remote control unit's battery is properly recharged.
- You may be using the remote control too far from the sensor (Try moving closer to the digital sound projector).
- Remote operation may become unreliable if direct sunlight, a fluorescent lamp, or other strong light source is striking the remote control sensor on the front panel.

P14

P11

Remote control unit doesn't operate connected Pioneer DVD recorder

- Depending on the model, some functions may not be supported.

Touch panel menus don't change

- If the remote control menu screens do not change, try using the following procedure to reset the remote control unit. Resetting the remote control unit will not erase recorded settings.

If the unit does not operate normally due to external effects (such as static electricity)

- Disconnect the power plug from the outlet and insert again to return to normal operating conditions.



Additional Information

Resetting the Remote Control Unit

1 Use a Phillips screwdriver to remove the screw on the back panel of the remote control unit.

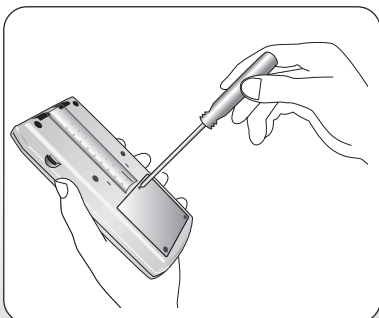

2 Remove the panel.

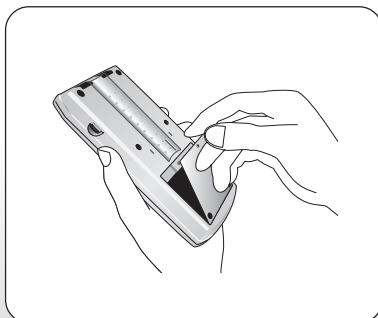

3 Use a narrow pointed object to press the RESET button.

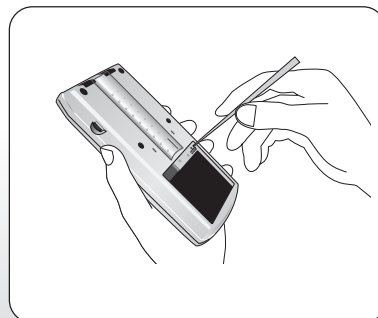
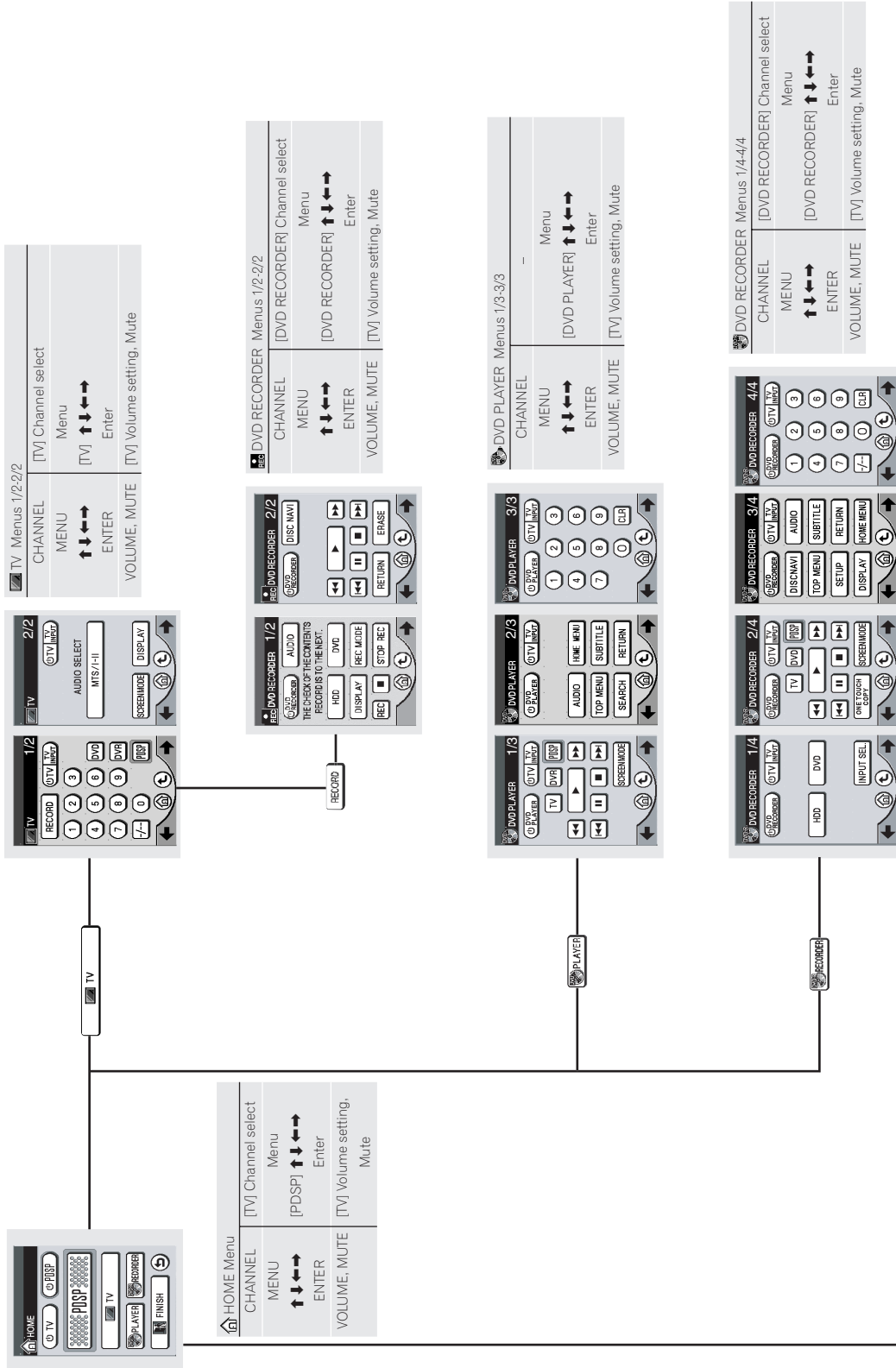
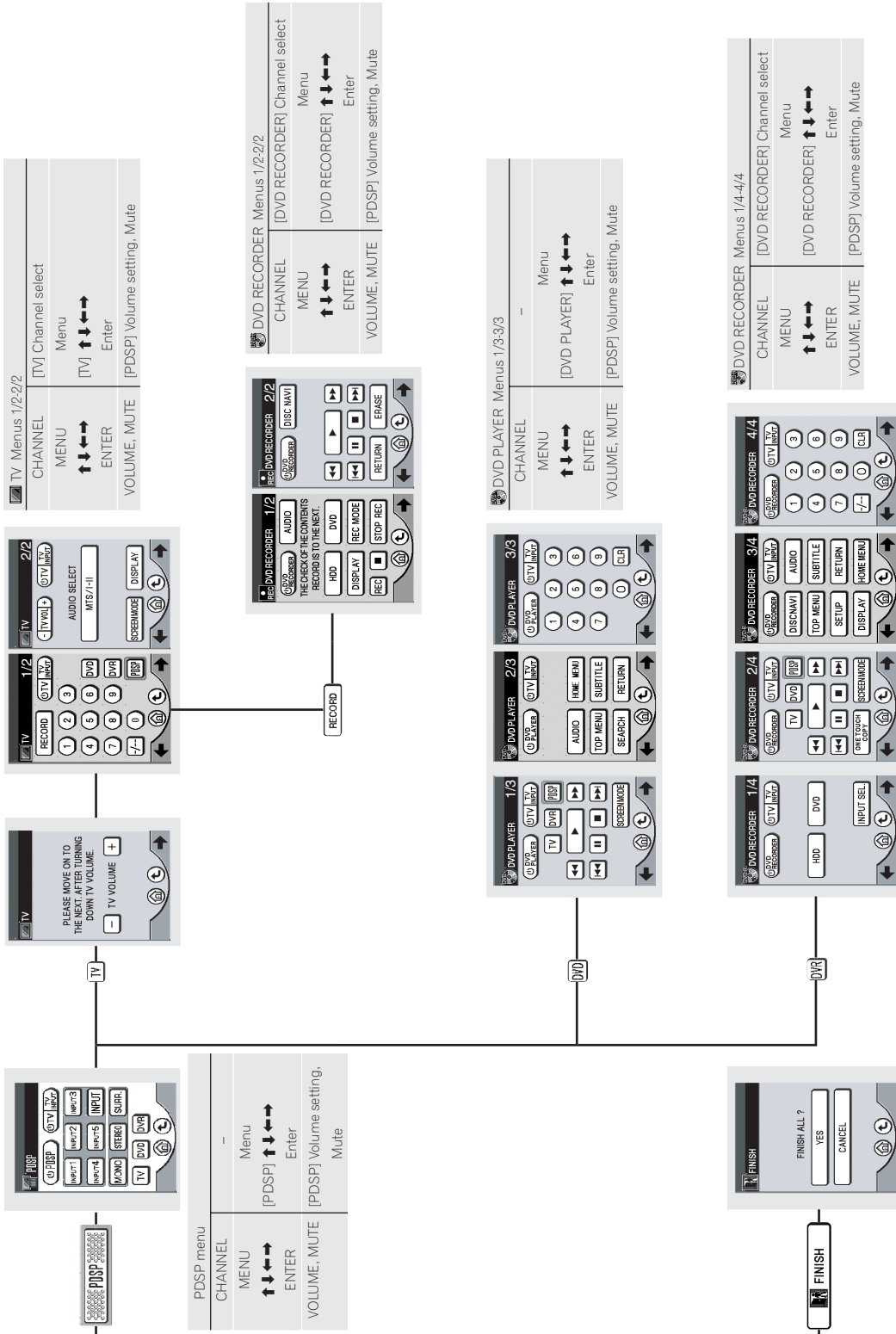

Table of Remote Control Unit Menu Displays

The following table shows all operating menu displays on the remote control unit's touch panel display. Depending on the way you navigate through the operating menus, the component corresponding to the remote control unit's buttons (hard keys) will change. To confirm what component and functions are supported, consult the remote control unit's function table for each operating menu display.





Additional Information

Index

The following index of keywords has been collected based on the four following item categories:

1. Terms displayed in menus
2. Terms on front panel / rear panel
3. Symbols and terms on remote control unit / touch panel
4. Terminology in these operating instructions







Terms displayed in menus

	page
All Ch Tone Control	31
Aux Center	28
Bass	31
Bass Management	30
Center width	36
Delay	33
Dimension	36
Dolby Digital	25
Image width	34
LFE	30
Lipsync delay	33
Memory	32
Mono	26
Noise Source	27
Panorama	36
Pro Logic	25
PLII Mode	35
PLII Movie	25
PLII Music	25
Recall from... ..	32
Recall Memory	32
Status	37
Stereo	25
Stereo Mode	34, 35
Sub Woofer	30
Surround Setup	28
System Setup	27
Treble	31

Terms on front panel / rear panel

	page
COAXIAL	12
INPUT 1 – 5	12
MONITOR OUTPUT	12
OPTICAL	12
OUTPUT OPTICAL	12
POWER ON	10
RS-232C	12
STANDBY	10
SUB WOOFER 1 OUTPUT	12
SUB WOOFER 2 OUTPUT	12
VOLUME LEVEL	10

Symbols and terms on remote control unit / touch panel

	page
CHANNEL	14
CONTRAST	14
DVD PLAYER	22
DVD RECORDER	23, 24
ENTER	14
FINISH	18
HOME	18
INPUT	19
MENU	14
MONO	26
MUTE	14
PDSP	19
RECORD	23
RESET	39
SETUP	15
STEREO	25
SURR.	25
TV	21
VOLUME	14
	14
	14
	16
	18
	20
	19, 20
	19, 20

Terminology in these operating instructions

	page
Beam control technology	6
Composite connector (video input)	13
Dolby Digital	7
DTS	7
Front Grille	11
Lithium-ion battery	8, 39
Main power switch	12
Power cord	12
Pro Logic II	7, 25, 35
Recharger	16
Remote control signal sensor	10
Reset	39
S connector (video input)	13



Additional Information

AFTER-SALES SERVICE FOR PIONEER PRODUCTS

Please contact the dealer or distributor from where you purchased the product for its after-sales service (including warranty conditions) or any other information. In case the necessary information is not available, please contact the Pioneer's subsidiaries (regional service headquarters) listed below:

PLEASE DO NOT SHIP YOUR PRODUCT TO THE COMPANIES at the addresses listed below for repair without advance contact, for these companies are not repair locations.

AMERICA

PIONEER ELECTRONICS (USA) INC.
CUSTOMER SUPPORT DIVISION
P.O. BOX 1760, LONG BEACH, CA 90801-1760, U.S.A.
CUSTOMER SERVICE HOTLINE : (800) 421-1404

EUROPE

PIONEER EUROPE NV
EUROPEAN SERVICE DIVISION
HAVEN 1087, KEETBERGLAAN 1, B-9120 MELSELE, BELGIUM

ASEAN

PIONEER ELECTRONICS ASIACENTRE PTE. LTD.
SERVICE DEPARTMENT
253, ALEXANDRA ROAD #04-01 SINGAPORE 159936

JAPAN AND OTHERS

PIONEER CORPORATION (HEAD OFFICE)
CUSTOMER SUPPORT CENTER
4-1, MEGURO 1-CHOME, MEGURO-KU, TOKYO 153-8654 JAPAN

S016D_en

Published by Pioneer Corporation.
Copyright © 2003 Pioneer Corporation.
All rights reserved.

PIONEER CORPORATION 4-1, Meguro 1-Chome, Meguro-ku, Tokyo 153-8654, Japan
PIONEER ELECTRONICS (USA) INC. P.O. BOX 1540, Long Beach, California 90810-1540, U.S.A. TEL: (800) 421-1404
PIONEER ELECTRONICS OF CANADA, INC. 300 Allstate Parkway, Markham, Ontario L3R OP2, Canada TEL: (905) 479-4411
PIONEER EUROPE NV Haven 1087, Keetberglaan 1, B-9120 Melsele, Belgium TEL: 03/570.05.11
PIONEER ELECTRONICS ASIACENTRE PTE. LTD. 253 Alexandra Road, #04-01, Singapore 159936 TEL: 656-472-1111
PIONEER ELECTRONICS AUSTRALIA PTY. LTD. 178-184 Boundary Road, Braeside, Victoria 3195, Australia, TEL: (03) 9586-6300
PIONEER ELECTRONICS DE MEXICO S.A. DE C.V. Blvd.Manuel Avila Camacho 138 10 piso Col.Lomas de Chapultepec, Mexico,D.F. 11000
TEL: 55-9178-4270

K002E

Free Manuals Download Website

<http://myh66.com>

<http://usermanuals.us>

<http://www.somanuals.com>

<http://www.4manuals.cc>

<http://www.manual-lib.com>

<http://www.404manual.com>

<http://www.luxmanual.com>

<http://aubethermostatmanual.com>

Golf course search by state

<http://golfingnear.com>

Email search by domain

<http://emailbydomain.com>

Auto manuals search

<http://auto.somanuals.com>

TV manuals search

<http://tv.somanuals.com>