

Pioneer

DVD/CD TUNER

DVD/CD調諧器

XV-DV77

POWERED SUBWOOFER

有源副低音揚聲器

S-DV77SW

SATELLITE SPEAKER

衛星揚聲器

S-DV77ST

Operating Instructions

使用說明書



These labels can be found on the DVD/CD tuner rear panel (US model)/bottom panel (European model), and on the powered subwoofer rear panel.



CAUTION
RISK OF ELECTRIC SHOCK
DO NOT OPEN

IMPORTANT



The lightning flash with arrowhead symbol, within an equilateral triangle, is intended to alert the user to the presence of uninsulated 'dangerous voltage' within the product's enclosure that may be of sufficient magnitude to constitute a risk of electric shock to persons.

CAUTION
RISK OF ELECTRIC SHOCK
DO NOT OPEN

CAUTION:
TO PREVENT THE RISK OF ELECTRIC SHOCK, DO NOT REMOVE COVER (OR BACK). NO USER-SERVICEABLE PARTS INSIDE. REFER SERVICING TO QUALIFIED SERVICE PERSONNEL.



The exclamation point within an equilateral triangle is intended to alert the user to the presence of important operating and maintenance (servicing) instructions in the literature accompanying the appliance. **H002_En**

WARNING: THE APPARATUS IS NOT WATERPROOFS, TO PREVENT FIRE OR SHOCK HAZARD, DO NOT EXPOSE THIS APPLIANCE TO RAIN OR MOISTURE AND DO NOT PUT ANY WATER SOURCE NEAR THIS APPARATUS, SUCH AS VASE, FLOWER POT, COSMETICS CONTAINER AND MEDICINE BOTTLE ETC.

H001AEn

CAUTION:

THE STANDBY/ON BUTTON IS SECONDARY CONNECTED AND THEREFORE DOES NOT SEPARATE THE UNIT FROM MAINS POWER IN STANDBY POSITION. THEREFORE INSTALL THE UNIT SUITABLE PLACES EASY TO DISCONNECT THE MAINS PLUG IN CASE OF THE ACCIDENT. THE MAINS PLUG OF UNIT SHOULD BE UNPLUGGED FROM THE WALL SOCKET WHEN LEFT UNUSED FOR A LONG PERIOD OF TIME. **H017BEEn**

Thank you for buying this PIONEER product. Please read through these operating instructions so you will know how to operate your model properly. After you have finished reading the instructions, put them away in a safe place for future reference.

When using this product, follow the instructions written on the underside of the unit, which concern the XV-DV77.

CAUTION

This product contains a laser diode of higher class than 1. To ensure continued safety, do not remove any covers or attempt to gain access to the inside of the product.

Refer all servicing to qualified personnel.

The following caution label appear on your player.

Location: On the bottom panel of XV-DV77

CLASS 1
LASER PRODUCT

WARNING: BEFORE PLUGGING IN THE UNIT FOR THE FIRST TIME, READ THE FOLLOWING SECTION CAREFULLY. THE VOLTAGE OF THE AVAILABLE POWER SUPPLY DIFFERS ACCORDING TO COUNTRY OR REGION, BE SURE THAT THE POWER SUPPLY VOLTAGE OF THE AREA WHERE THIS UNIT WILL BE USED MEETS THE REQUIRED VOLTAGE (E.G., 230V OR 120V) WRITTEN ON THE REAR PANEL. **H041 En**

WARNING: NO NAKED FLAME SOURCES, SUCH AS LIGHTED CANDLE, SHOULD BE PLACED ON THE APPARATUS. IF NAKED FLAME SOURCES ACCIDENTALLY FALL DOWN, FIRE SPREAD OVER THE APPARATUS THEN MAY CAUSE FIRE. **H044 En**

CAUTION: These speaker terminals can be under HAZARDOUS VOLTAGE. When you connect or disconnect the speaker cables, to prevent the risk of electric shock, do not touch uninsulated parts before disconnecting the power cord. **H047 En**

CAUTION:

This product satisfies FCC regulations when shielded cables and connectors are used to connect the unit to other equipment. To prevent electromagnetic interference with electric appliances such as radios and televisions, use shielded cables and connectors for connections. **H012 En**

Inside the bonnet of XV-DV77

CAUTION	: VISIBLE AND INVISIBLE LASER RADIATION WHEN OPEN. AVOID EXPOSURE TO BEAM.
VORSICHT	: SICHTBARE UND UNSICHTBARE LASERSTRAHLUNG, WENN ABDECKUNG GEÖFFNET : NICHT DEM STRAHLE AUSSETZEN!
ADVARSEL	: SYNLIG OG USYNLIG LASERSTRÅLING VED ÅBNING UINDGÅ UDSÆTTELSE FOR STRÅLING.
VARNING	: SYNLIG OCH OSYNLIG LASERSTRÅLNING NÄR DENNA DEL ÄR ÖPPNAD BETRÄKTA EJ STRÅLEN.
VARO!	: AVATTAESSA ALTISTUT NÄKYVÄ JA NÄKYMÄTTÖMÄLLE LASERSATEIL YLLE. ÄLÄ KATSO SÄTEISEN.
CUIDADO	: RADIAACION LASER VISIBLE E INVISIBLE AL ESTAR ABIERTO. EVITAR EXPOSICIÓN AL RAYO.

VRW1872

WARNING: Slot and openings in the cabinet are provided for ventilation and to ensure reliable operation of the product and to protect it from overheating, to prevent fire hazard, the openings should never be blocked and covered with items, such as newspapers, table-cloths, curtains, etc. Also do not put the apparatus on the thick carpet, bed, sofa, or fabric having a thick pile. **H040 En**

Operating Environment **H045 En**

Operating environment temperature and humidity:

+5°C – +35°C (+41°F – +95°F); less than 85%RH (cooling vents not blocked)

Do not install in the following locations

- Location exposed to direct sunlight or strong artificial light
- Location exposed to high humidity, or poorly ventilated location

NOTE: This equipment has been tested and found to comply with the limits for a Class B digital device, pursuant to Part 15 of the FCC Rules. These limits are designed to provide reasonable protection against harmful interference in a residential installation. This equipment generates, uses, and can radiate radio frequency energy and, if not installed and used in accordance with the instructions, may cause harmful interference to radio communications. However, there is no guarantee that interference will not occur in a particular installation. If this equipment does cause harmful interference to radio or television reception, which can be determined by turning the equipment off and on, the user is encouraged to try to correct the interference by one or more of the following measures:

- Reorient or relocate the receiving antenna.
- Increase the separation between the equipment and receiver.
- Connect the equipment into an outlet on a circuit different from that to which the receiver is connected.
- Consult the dealer or an experienced radio/TV technician for help.

H010 En

Information to User

H011 En

Alteration or modifications carried out without appropriate authorization may invalidate the user's right to operate the equipment.

CAUTION : USE OF CONTROLS OR ADJUSTMENTS OR PERFORMANCE OF PROCEDURES OTHER THAN THOSE SPECIFIED HEREIN MAY RESULT IN HAZARDOUS RADIATION EXPOSURE.

CAUTION : THE USE OF OPTICAL INSTRUMENTS WITH THIS PRODUCT WILL INCREASE EYE HAZARD.

H013 En

Installation Precautions

- Install components so that there are no obstructions above or either side of them, or by ventilation holes. Also install 5cm away from the wall as shown in the figures. Components feature ventilation holes on the bottom so do not install on thick pile carpets or other surfaces that may block them.
- Use a vacuum cleaner periodically to clean the port of the subwoofer to keep it free of dust.

LINE VOLTAGE SELECTOR SWITCH (Multi voltage model only)

The line voltage selector switch is located on the rear panel. Check that it is set properly before plugging the power cord into the outlet. If the voltage is not properly set or if you move to an area where the voltage requirements differ, adjust the selector switch as follows:

- Be sure to disconnect the power cord from its outlet before making this adjustment.
- Use a medium-sized (flat blade) screwdriver. Insert the tip of the screwdriver into the groove of the selector switch and turn it so that the power voltage marking of your area points to the arrow.

Powered subwoofer unit (S-DV77SW)

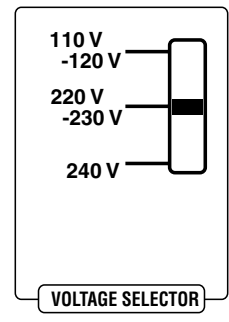
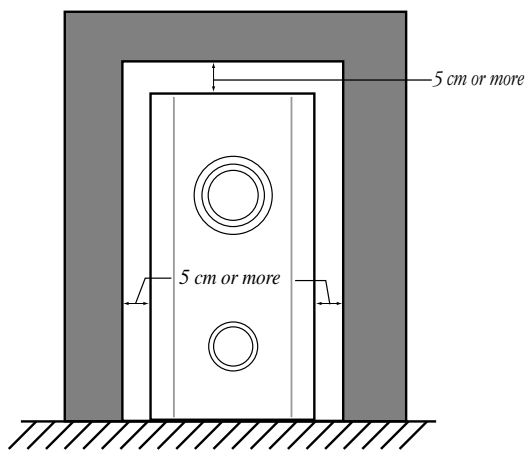

CAUTION 220 - 230 V

Power source voltage is factory adjusted 220 - 230 volts. If your area is different, change voltage selectors settings.

H038 En

DVD/CD Tuner (XV-DV77)

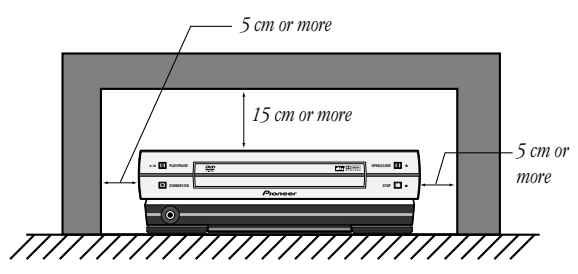

POWER-CORD CAUTION

Handle the power cord by the plug. Do not pull out the plug by tugging the cord and never touch the power cord when your hands are wet as this could cause a short circuit or electric shock. Do not place the unit, a piece of furniture, etc., on the power cord, or pinch the cord. Never make a knot in the cord or tie it with other cords. The power cords should be routed such that they are not likely to be stepped on. A damaged power cord can cause a fire or give you an electrical shock. Check the power cord once in a while. When you find it damaged, ask your nearest PIONEER authorized service center or your dealer for a replacement.

下列標記可在DVD/CD調諧器的後面板及有源副低音揚聲器的後面板上找到。



CAUTION
RISK OF ELECTRIC SHOCK
DO NOT OPEN

重要



這個放在等邊三角形內並帶有箭頭的閃電符號旨在引起用戶警惕。因本產品內有無絕緣“危險電壓”，會有觸電的危險。

CAUTION
RISK OF ELECTRIC SHOCK
DO NOT OPEN

注意：
為避免觸電，請勿擅自打開機殼（或背面）或自行維修內部部件。請將維修事宜交由專業人員進行。



這個放在等邊三角形內的感嘆號旨在提醒用戶注意本機附帶的資料中有關於操作和維護（修理）的重要說明。 H002AChH

警告：本機不具備防水功能。為防止起火或觸電事故，請勿將其暴露在雨中或潮濕的環境裡，也不要靠近花瓶、花盆、化妝盒、藥瓶等有水的地方。 H001AChH

感謝惠購本PIONEER產品。
請通讀本使用說明書，以便了解如何正確操作本機。通讀完畢後，請妥善保存，以備日後參考。

注意：

因此請將本機安裝在發生事故時便於拔下電源插頭的合適的場所。如果長期不用，應將電源插頭從插座拔下。 H017BChH

使用本產品時，請遵照本機下方關於XV-DV77的指示進行操作。

小心

本產品含有大於1級的鐳射二極管。為確保安全，請勿拆卸任何蓋板或試圖對機器內部進行操作。所有維修工作均應交由專業人員進行。
本播放機具有下列注意標籤。
位置：XV-DV77底部

警告：剛開始將本機插入電源前，請仔細閱讀下一節的說明。電源電壓因國家和地區而異。切記在使用本機時使當地電源電壓與寫在本機後面板上的所需電壓〔如230V或120V〕保持一致。 H041ChH

CLASS 1
LASER PRODUCT

警告：切勿將點燃的蠟燭等明火源放在本機上。萬一明火源倒下，火苗將蔓延到本機，從而引發火災。 H044ChH

XV-DV77機罩內

注意：這些揚聲器端子可能帶有HAZARDOUS VOLTAGE（危險電壓）。連接或拔下揚聲器電纜時，為了防止發生觸電事故，請勿在拔下電源電纜前觸摸未絕緣部分。 H047ChH

CAUTION : VISIBLE AND INVISIBLE LASER RADIATION WHEN OPEN. AVOID EXPOSURE TO BEAM.
VORSICHT : SICHTBARE UND UNSICHTBARE LASERSTRAHLUNG, WENNABDECKUNG GEÖFFNET NICHT DEM STRAHL AUSSETZEN!
ADVARSEL : SYNLIG OG USYNLIG LASERSTRÅLING VED ÅBNING UNDGÅ UDSÆTTELSE FOR STRÅLING.
VARNING : SYNLIG OCH OSYNLIG LASERSTRÅLING NÄR DENNA DEL ÄR ÖPPNAD BETRÄKTA EJ STRÅLEN.
VARO! : AVATTAESSA ALISTUT NÄKYVÄ JA NÄKYMÄTTÖMÄLLE LASERSATEIL YLLÄ. ÄLÄ KATSO SÄTEESÄEN.
CUIDADO : RADIACION LASER VISIBLE E INVISIBLE AL ESTAR ABIERTO. EVITAR EXPOSICION AL RAYO. VRW1872

工作環境

工作環境的溫度和濕度：
+5°C - +35°C (+41°F - +95°F)；小於 85% RH（冷卻口未堵塞）
請勿安裝在下列場所

- 太陽直射或強烈的人造光源下的場所
- 濕度很高或通風不良的場所

安裝注意事項

- 安裝各設備組件時，請注意在其上方或左右兩側及通風孔附近不得放置物品。並且如圖所示應放置於距離牆壁5厘米處。各設備下部均有通風孔，因此請勿將它們安裝在厚絨地毯或其他可能引起堵塞的表面上。
- 請定期使用真空吸塵器清理副低音揚聲器端口，以免積塵。

有源副低音揚聲器 (S-DV77SW)

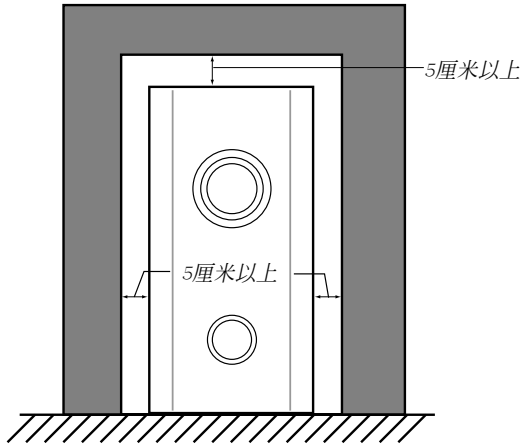

DVD/CD調諧器 (XV-DV77)

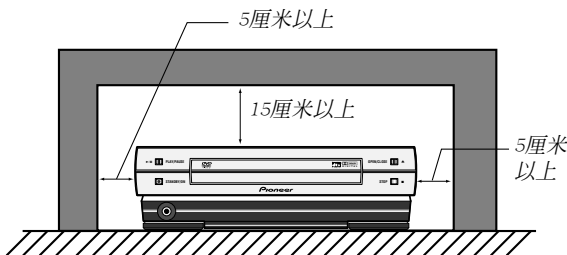

通風：在安裝機器時，一定要在其四周留下足夠的空隙，以便通風散熱。(上方的空隙不得小於10厘米；背面空隙，10厘米；左右側面，10厘米。)

警告：機殼上帶有縫孔和開口，用於通風、防止過熱和確保本產品能夠正常工作。為了防止火災，切勿用報紙、桌布、幕簾等物件堵住或蓋住這些開口，也不要將本機放在鋪有厚毯子的床上、沙發上或很厚的織物上。

線路電壓選擇開關(僅限多電壓機型)

線路電壓選擇開關位於本機的背面板上。在將電源線插頭插入電源插座之前，請確認設定是否正確。如果電壓沒有正確設定，或搬遷到電壓需求不同的地方，請按如下要領調整本選擇開關：

- 進行本調整之前，必須從電源插座拔除電源線。
- 使用中型(扁頭)螺絲刀。將螺絲刀的尖頭插入選擇開關的槽中並轉動以使貴地電源電壓標記指向箭頭。

H038 ChH

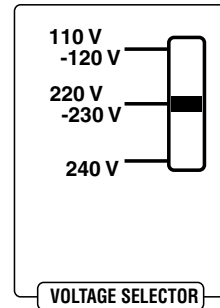

注意220~230V

電源電壓的工廠初期設定為220~230 V。如果貴地電壓不同，請改變電壓選擇開關的設定。

H038 ChH

電源線注意事項

處理電源線時請手持插頭。插拔插頭時請勿拉扯電線。雙手潮濕時切勿接觸電源線以免引起短路或觸電。請勿將本機或家具等物置於電源線上，或使電源線受壓。請勿將電源線打結或用其他繩索將其捆住。電源線應安置在不會被人踩踏的地方。若電源線受損，可能會引發火災或觸電事故。請定期檢查電源線。如發現有任何損壞，請就近聯繫PIONEER特約服務中心或經銷商予以更換。

Contents

1 Before You Start

Features	9
Using this manual	9
Hints on installation	10
Avoiding problems with condensation	10
Moving the system	10
Discs compatible with this system	11
DVD Video regions	11

2 Controls and Displays

Front panel	12
Display	12
Remote control	14

3 Setting Up

Introduction	16
Switching on and setting the clock	16
Changing the clock display format	17
Setting up for surround sound	18
Setting the speaker distances	18
Balancing the surround sound	20
Setting the TV System	21
Using the setup navigator	22
Setting up the remote to control your TV	24
Using this remote with your TV	25

4 Getting Started

Playing DVDs, CDs and Video CDs	27
Basic playback controls	28
Navigating DVD disc menus	29
Navigating Video CD PBC menus	30
Listening to the radio	31
Improving FM stereo sound	32
Saving station presets	32
Listening to station presets	33
Naming station presets	34
Tuner system displays	35
Playing other connected components	35
Reducing the auxiliary input level	36

5 Using Sound modes and Effects

Using the Sound menu	37
Using sound modes	38
Playing Dolby/DTS sources	38
Playing other stereo sources with DSP effects	40

6 Playing Discs

Introduction	41
Finding what you want on a disc	41
Switching camera angles	42
Switching subtitles	42
Switching audio language	42
Switching audio channels	43
Making a program list	43
Using random play	45
Using repeat play	46

目錄

1 開始使用之前

特點	9
使用本說明書	9
安裝提示	10
避免因結露而引發問題	10
搬移本系統	10
與本系統相容的碟片	11
DVD影碟的地區	11

2 控制按鈕和顯示屏

前面板	13
顯示屏	13
遙控器	15

3 設置

簡介	16
打開電源和設置時鐘	16
更改時鐘顯示格式	17
設置環繞聲	18
設置揚聲器距離	18
環繞聲的平衡	20
設置電視制式	21
使用設置嚮導	22
設置遙控器，使其可控制電視機	24
使用遙控器控制電視機	25

4 開始使用

播放DVD，CD和VCD	27
基本播放控制	28
DVD碟片選單導向	29
VCD PBC選單導向	30
收聽收音機	31
改善FM立體聲收音效果	32
保存預設電台	32
收聽預設電台	33
命名預設電台	34
調諧器系統顯示	35
播放所連接的其他設備	35
降低輔助輸入電平	36

5 使用音場模式和效果

使用Sound選單	37
使用音場模式	38
播放杜比/DTS音源	38
使用DSP效果播放其他立體聲音源	40

6 播放碟片

簡介	41
在碟片中尋找所需內容	41
轉換攝影角度	42
轉換字幕	42
轉換對白語言	42
轉換聲道	43
製作編序列表	43
使用隨機播放	45
使用重複播放	46

Looping a section of a disc	46	重複播放碟片中的某一片段	46
Bookmarking a place in a disc	47	在碟片某處製作書籤	47
Memorizing disc settings	47	記憶碟片設置	47
Displaying disc information	48	顯示碟片資訊	48
Displays when playing	49	播放中的顯示	49
Displays when stopped	51	停止時的顯示	51
DVD and CD system displays	51	DVD和CD系統顯示	51
Displays when playing	51	播放時的顯示	51
Displays when stopped	51	停止時的顯示	51
7 Playing MP3s		7 播放MP3	
Playing MP3s	52	播放MP3	52
Searching for folders and tracks	53	搜索檔案夾和曲目	53
Using random play	53	使用隨機播放	53
Using repeat play	54	使用重複播放	54
Displaying MP3 information	54	顯示MP3資訊	54
Using the MP3 Navigator	55	使用MP3嚮導	55
Making a program list of MP3 tracks	56	製作MP3曲目的編序列表	56
MP3 compatibility information	57	MP3相容資訊	57
8 Using the Timer		8 使用定時器	
Using the wake up timer	58	使用喚醒定時器	58
Activating/deactivating the wake up timer	59	啟動/關閉喚醒定時器	59
Checking the timer settings	60	檢查定時器設置	60
Using the sleep timer	60	使用睡眠定時器	60
9 Advanced Sound Setup		9 高級音聲設置	
Dynamic Range Control	62	動態範圍控制	62
LFE Attenuator	62	LFE衰減器	62
Dual-mono setting	63	雙重單聲道設置	63
Adjusting channel volume levels	64	調整聲道的音量級	64
10 DVD Setup Menu		10 DVD設置選單	
Using the DVD Setup menu	65	使用DVD設置選單	65
Audio settings	66	音頻設置	66
Dolby Digital Out	66	Dolby Digital Out (杜比數碼輸出)	66
96kHz PCM Out	66	96kHz PCM Out (96kHz PCM輸出)	66
Video settings	67	視頻設置	67
TV Screen	67	TV Screen (電視機螢幕)	67
S-Video Out	67	S-Video Out (S-Video輸出)	67
Screen Saver	68	Screen Saver (螢幕保護程式)	68
Background	68	Background (背景)	68
Video Adjust	68	Video Adjust (視頻調整)	68
Selecting a preset	69	選擇預設置	69
Creating your own setting(1)	69	創建自己的設置(1)	69
Creating your own setting(2)	70	創建自己的設置(2)	70
Still Picture	71	Still Picture (定格影像)	71
On Screen Display	71	On Screen Display (螢幕顯示)	71
Angle Indicator	72	Angle Indicator (角度指示符)	72
Language settings	72	語言設置	72
OSD language	72	OSD language (OSD語言)	72
Audio Language	72	Audio Language (對白語言)	72
Subtitle Language	73	Subtitle Language (字幕語言)	73
Auto Language	74	Auto Language (自動語言)	74
DVD Language	75	DVD Language (DVD語言)	75
Subtitle Display	76	Subtitle Display (字幕顯示)	76
Subtitle Off	76	Subtitle Off (字幕關閉)	76
General settings	77	一般設置	77
Setup Menu Mode	77	Setup Menu Mode (設置選單模式)	77

Parental Lock	77
Registering a new password	78
Changing your password	78
Setting/changing the Parental Lock level	79
Setting/changing the Country Code	79
Country code list	80

11 Connecting Up

For instructions on connecting up the speakers and the powered subwoofer, see the separate instruction sheet, Setting Up the System.

Connecting other components	81
Connecting external antennas	83
External AM antenna	83
External FM antenna	83

12 Additional Information

Child lock	84
Beep mode	84
Tuner frequency step	84
Dimming the display	85
Taking care of your system	85
Disc lens cleaner	85
Taking care of your discs	85
Storing discs	86
Discs to avoid	86
Glossary	87
Language code list	88
Screen sizes and disc formats	89
Troubleshooting	90
Amplifier fault finding	90
Optional component fault finding	90
DVD fault finding	90
Troubleshooting tips	91
Resetting the system	92
Specifications	95
Demo display	100

Parental Lock (家長鎖定)	77
登錄新密碼	78
更改密碼	78
設置/更改Parental Lock等級	79
設置/更改Country Code	79
國家代碼列表	80

11 連接

關於連接揚聲器和有源副低音揚聲器的說明，請參見另外的說明書：系統安裝。

連接其他設備	81
連接外接天線	83
外接AM天線	83
外接FM天線	83

12 附加資訊

兒童鎖定	84
蜂鳴音模式	84
調諧器頻率幅度	84
調整顯示屏亮度	85
系統保養	85
碟片鏡頭清潔器	85
碟片保養	85
碟片保存	86
不能使用的碟片	86
詞彙表	87
語言代碼列表	88
螢幕尺寸和碟片格式	89
故障排除	90
放大器故障的判斷	90
選購設備故障的判斷	90
DVD故障的判斷	90
故障排除提示	91
系統復位	92
規格	95
演示	100

Features

● Superlative audio performance with Dolby Digital* and DTS** software

The XV-DV77 delivers breathtaking sound quality with Dolby Digital and DTS discs, and is also compatible with 96kHz/24-bit PCM sources.

● Super Fine Focus Digital Filter technology

This high-quality digital video filter gives you great picture quality with DVD discs. The filter is effective all the way up the video frequency range, and also reduces noise outside the video frequency range.

- This product incorporates copyright protection technology that is protected by method claims of certain U. S. patents and other intellectual property rights owned by Macrovision Corporation and other rights owners. Use of this copyright protection technology must be authorized by Macrovision Corporation, and is intended for home and other limited viewing uses only unless otherwise authorized by Macrovision Corporation. Reverse engineering or disassembly is prohibited.
- * Manufactured under license from Dolby Laboratories. “Dolby”, “Pro Logic” and the double-D symbol are trademarks of Dolby Laboratories. Confidential unpublished works. © 1992-1997 Dolby Laboratories. All rights reserved.
- ** “DTS” and “DTS Digital Surround” are trademarks of Digital Theater Systems, Inc. Manufactured under license from Digital Theater Systems, Inc.

Using this manual

This manual is for the XV-DV77 DVD Surround System. It is divided into several sections: information for before you start using the system (chapters 1–2); getting started using the system (chapters 3–4); more advanced features (chapters 5–9); system settings and preferences (chapter 10); connecting up the system and using this system with external components (chapter 11). Chapter 12 provides additional information, including a glossary of terms used in this manual, and a troubleshooting section.

特點

● 採用杜比數碼 Dolby Digital *和 DTS**軟體，音質超群

XV-DV77充分發揮了杜比數碼和DTS碟片音質的優勢，並與96kHz/24位元PCM音源相容。

● 超精細聚焦數碼過濾技術

高品質的數碼視頻過濾器使DVD碟片擁有十分出色的畫質。該過濾器對所有視頻範圍均有效，還可降低視頻範圍以外的噪音。

- 本產品含有版權保護技術，該技術受到 Macrovision公司及其他技術所有者的美國專利聲明及相關知識產權的法規保護。使用該版權保護技術須經Macrovision公司授權，且在未經 Macrovision公司任何授權的情況下僅限於家庭使用及其他有限制的觀看使用場合。嚴禁對本產品實行逆向設計或拆解。
- * 經杜比實驗室授權製造。“Dolby”、“Pro Logic”和雙D標誌均為杜比實驗室的商標。未公開出版的內部作品。1992–1997杜比實驗室。版權所有。
- ** “DTS”和“DTS Digital Surround”系杜比影院系統公司的商標。經杜比影院系統公司授權製造。

使用本說明書

本說明書適於XV-DV77 DVD環繞聲系統，由若干部份組成：開始使用本系統之前的有關資訊（第1–2章）；開始使用本系統（第3–4章）；更高級的功能（第5–9章）；系統設置和參數（第10章）；連接本系統及將本系統與外接設備配合使用（第11章）。第12章提供附加資訊，包括本說明書中使用的術語詞彙表及故障排除內容。

■ Hints on installation

We want you to enjoy using this unit for years to come, so please bear in mind the following points when choosing a suitable location for it:

Do...

- ✓ Use in a well-ventilated room.
- ✓ Place on a solid, flat, level surface, such as a table, shelf or stereo rack.

Don't...

- ✗ Use in a place exposed to high temperatures or humidity, including near radiators and other heat-generating appliances.
- ✗ Place on a window sill or other place where the system will be exposed to direct sunlight.
- ✗ Use in an excessively dusty or damp environment.
- ✗ Place directly on top of an amplifier, or other component in your stereo system that becomes hot in use.
- ✗ Use near a television or monitor as you may experience interference—especially if the television uses an indoor antenna.
- ✗ Use in a kitchen or other room where the system may be exposed to smoke or steam.
- ✗ Use on a thick rug or carpet, or cover with cloth—this may prevent proper cooling of the unit.
- ✗ Place on an unstable surface, or one that is not large enough to support all four of the unit's feet.

■ Avoiding problems with condensation

Condensation may form inside the system if it is brought into a warm room from outside, or if the temperature of the room rises quickly. Although the condensation won't damage the system, it may temporarily impair its performance. For this reason you should leave it to adjust to the warmer temperature for about an hour before switching on and using.

■ Moving the system

If you need to move the system, first switch it off and unplug from the wall outlet. Never lift or move the unit during playback—discs rotate at a high speed and may be damaged.

■ 安裝提示

我們希望您能長久地使用本機，因此在選擇適當的安裝場所之前請記住下列幾點：

應當...

- ✓ 安置在通風良好的房間。
- ✓ 安置於堅固，平坦，水平的表面上，如桌面，擱板或音響架上。

請勿...

- ✗ 安置於高溫或高濕的場所，如暖氣等發熱裝置的附近。
- ✗ 安置於窗檯等會使本系統暴露於直射陽光之下的場所。
- ✗ 安置於多塵潮濕環境中。
- ✗ 直接放置於在使用中會發熱的音響系統設備（如放大器）的上方。
- ✗ 在電視機或顯示器附近使用，以免引起干擾，尤其是使用室內天線的電視機附近。
- ✗ 在廚房等有煙霧或蒸氣的房間內使用。
- ✗ 安置於厚毛毯或地毯上，或用布蓋住，否則會引起本機散熱不良。
- ✗ 安置於不穩或大小不足以安放本機的表面上。

■ 避免因結露而引發的問題

如果將本機從室外帶入溫暖的室內，或者房間的溫度陡然上昇，則本機內部可能會出現結露現象。盡管結露不會損壞本系統，但可能會暫時影響其性能。因此，在上述情況下，應將本機擱置一小時左右讓其適應較高溫度後再打開使用。

■ 搬移本系統

如果需要搬移本系統，應先關閉電源，然後從牆壁插座上拔下電源插頭。切勿在播放時抬起或搬移本機，因為碟片正處於高速旋轉狀態中，這樣做可能會使其受損。

Discs compatible with this system

Any disc that displays one of the following logos should play in this system. Other formats, including DVD-RAM, DVD-ROM, DVD-Audio, SACD Photo CD and CD-ROM (except those containing MP3 files) will not play.

DVD Video compatibility:

- Logo: 
- Single-sided or double-sided discs
- Single layer or dual layer discs
- Dolby Digital, DTS, MPEG or Linear PCM digital audio
- MPEG-2 digital video

DVD discs are generally divided into one or more *titles*. Titles may be further subdivided into *chapters*.

Audio CD and MP3 compatibility:

- Logos:   
- 12cm or 8cm discs
- Linear PCM digital audio or MP3 (MPEG-1 Audio Layer 3)
- CD, CD-R* and CD-RW* formats

CDs are divided into *tracks*.

* This system can play CD-R and CD-RW discs recorded with audio. However, depending on the condition of the player and the disc, you may find that not all discs will play successfully. (For example, if the disc is scratched or dirty, or if the player's pickup lens is dirty.) Note that this unit cannot record onto recordable discs.

Video CD compatibility:

- Logo:  
- 12cm or 8cm discs
- MPEG-1 digital audio
- MPEG-1 digital video

Video CDs are divided into *tracks*.

DVD Video regions



All DVD Video discs carry a region mark on the case somewhere that indicates which region(s) of the world the disc is compatible with. Your DVD system also has a region mark, which you can find on the rear panel. Discs from incompatible regions will not play in this system. Discs marked **ALL** will play in any player.

與本系統相容的碟片

具有下列任何一種標誌的碟片均可在本系統播放。其他格式，包括DVD-RAM，DVD-ROM，DVD-Audio，SACD Photo CD和CD-ROM（含MP3文件的除外），則不能播放。

相容的DVD 影碟：

- 標誌：
- 單面或雙面碟片
- 單層或雙層碟片
- 杜比數碼，DTS，MPEG或線性PCM數碼音頻
- MPEG-2數碼視頻

DVD碟片一般分為一個或若干個標題。標題又可進一步分為章。

相容的CD唱碟和MP3：

- 標誌：  
- 12厘米或8厘米
- 線性PCM數碼音頻或MP3（第3階層MPEG-1音頻）
- CD，CD-R*和CD-RW*格式

CD分為若干軌跡。

* 本系統可播放CD-R和CD-RW唱碟。但是，限於播放機或碟片的條件，可能無法成功播放所有的碟片。（例如，碟片被划傷或污損，或者播放機拾音器變髒。）請注意本機無法對可錄碟片進行刻錄。

相容的VCD：

- 標誌： 
- 12厘米或8厘米碟片
- MPEG-1數碼音頻
- MPEG-1數碼視頻

VCD分為若干軌跡。

DVD 影碟的地區



所有DVD影碟的封套上都標有地區標記，表示該碟片在世界上哪些區域可以播放。您的DVD系統也擁有地區標記，它位於後面板上。來自不相容地區的碟片不能在本系統中播放。標有**ALL**的碟片可在任何播放機中播放。

Front panel

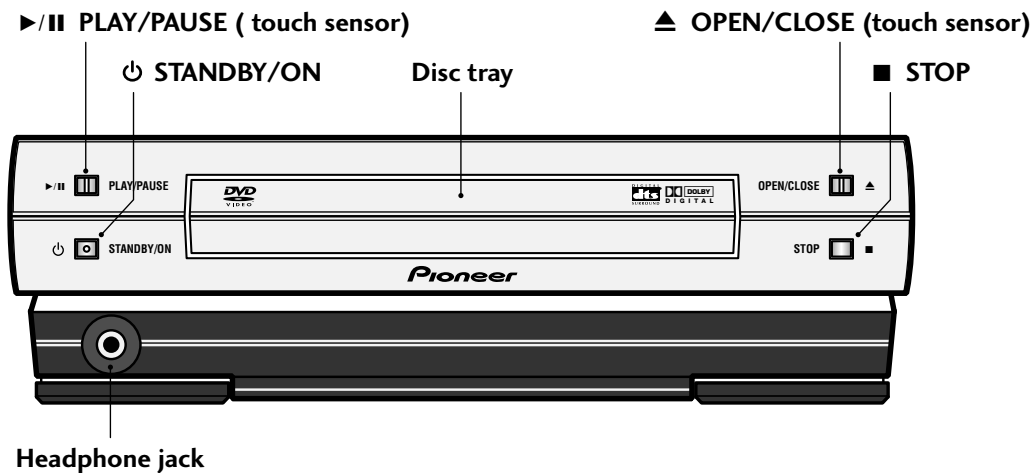

Display

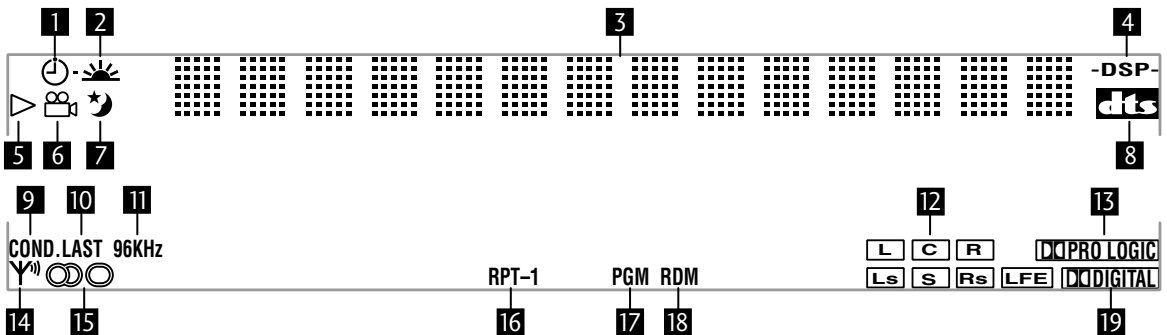

- 1 ⏻ Timer – pages 58-61
- 2 ☀ Wake up timer page 58
- 3 Character display
- 4 - DSP - – page 40
- 5 ▷ Lights when a disc is playing
- 6 🎬 Multi-angle scene – page 42
- 7 ⌚ Sleep timer – page 60
- 8 **DTS** Lights when playing a DVD with DTS sound
- 9 **COND.** Condition memory – page 47
- 10 **LAST** Last memory – page 47
- 11 **96kHz** Lights when playing a disc with 96kHz audio
- 12 Active channel indicators
- 13 **PRO LOGIC** Lights when playing a Dolby Pro Logic source
- 14 **Y^m** Indicates strength of broadcast signal
- 15 **⊕** Auto stereo/mono mode – page 32
- 16 **RPT, RPT-1** Repeat play mode – pages 46, 54
- 17 **PGM** Program play – pages 43, 56
- 18 **RDM** Random play – pages 45, 53
- 19 **DIGITAL** Lights when playing a Dolby Digital source

■ 前面板

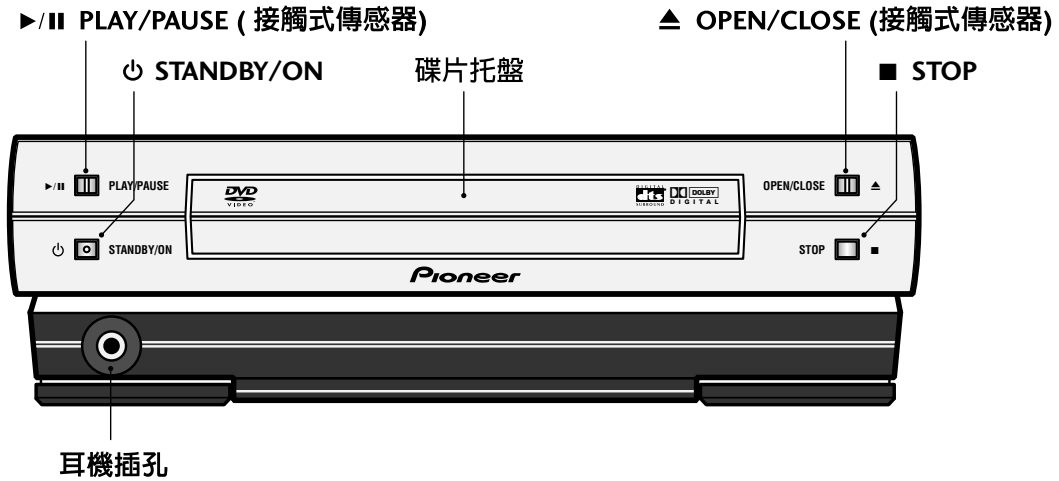

■ 顯示屏

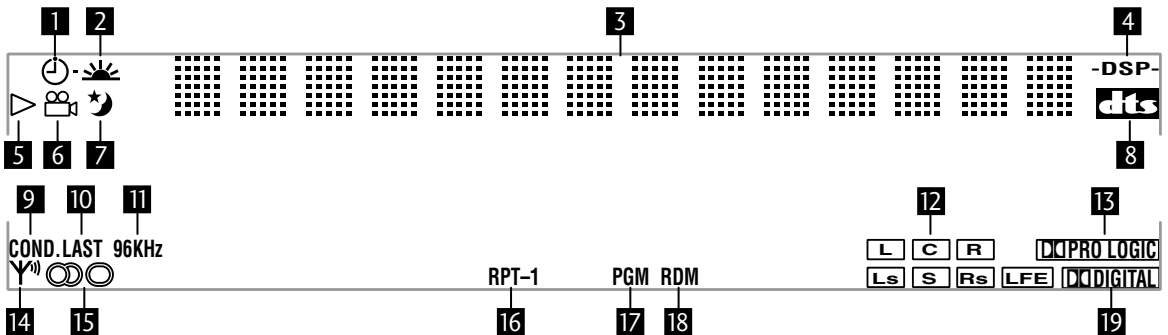

- 1 ⌚ 定時器—參見第58–61頁
- 2 🌞 喚醒定時器—參見第58頁
- 3 字符顯示區
- 4 -DSP—參見第40頁
- 5 ▷ 碟片播放時亮起
- 6 🎥 多角度場景—參見第42頁
- 7 🌙 睡眠定時器—參見第60頁
- 8 dtb 播放DTS音響類DVD時亮起
- 9 COND. 條件記憶—參見第47頁
- 10 LAST 最後記憶—參見第47頁
- 11 96kHz 播放96kHz音頻的碟片時亮起

- 12 當前聲道指示燈
- 13 dtb PRO LOGIC 播放杜比Pro Logic音響時亮起
- 14 📶 表示廣播信號的強度
- 15 🎧 自動立體聲/單聲道模式—參見第32頁
- 16 RPT, RPT-1 重複播放模式—參見第46, 54頁
- 17 PGM 編序播放—參見第43, 56頁
- 18 RDM 隨機播放—參見第45, 53頁
- 19 dtb DIGITAL 播放杜比數碼音響時亮起

Remote control

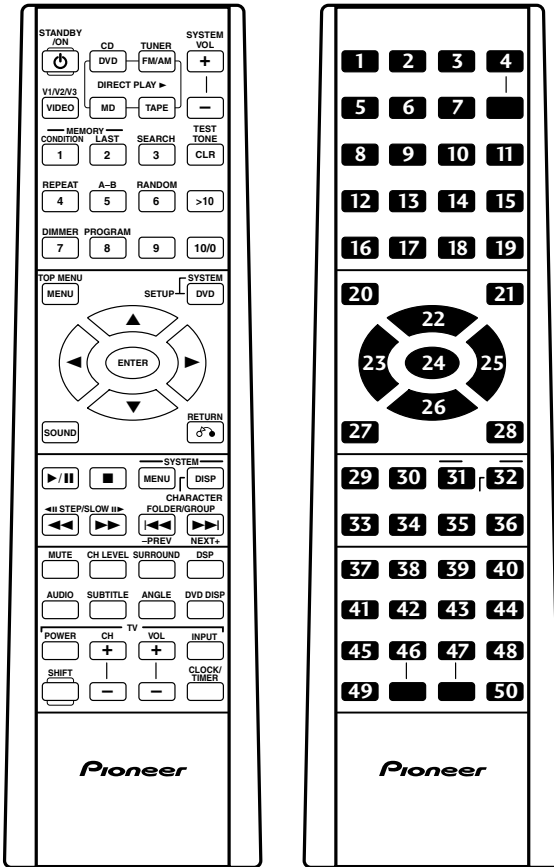

- 1 **STANDBY/ON** page 16
- 2 **DVD/CD (DIRECT PLAY**) page 27
- 3 **TUNER FM/AM (DIRECT PLAY**) page 31
- 4 **SYSTEM VOL +/-**
- 5 **VIDEO V1/V2/V3** page 35
- 6 **MD (DIRECT PLAY**)
- 7 **TAPE (DIRECT PLAY**)
- 8 **1 | CONDITION** page 48
- 9 **2 | LAST** page 47
- 10 **3 | SEARCH** page 41, 53
- 11 **CLR | TEST TONE** page 20
- 12 **4 | REPEAT** pages 46, 54
- 13 **5 | A-B** page 46
- 14 **6 | RANDOM** pages 45, 53
- 15 **>10** Use to select numbers over 10

- 16 **7 | DIMMER** page 85
- 17 **8 | PROGRAM** pages 43, 56
- 18 **9**
- 19 **10/0** Use as 10 or 0
- 20 **MENU | TOP MENU** page 29
- 21 **DVD SETUP | SYSTEM SETUP** pages 18, 65
- 22 **▲** Cursor up
- 23 **◀** Cursor left
- 24 **ENTER**
- 25 **▶** Cursor right
- 26 **▼** Cursor down
- 27 **SOUND** page 37
- 28 **RETURN** pages 29–30
- 29 **▶/||** pages 27–28, 52
- 30 **■** pages 28, 52
- 31 **SYSTEM MENU**
- 32 **SYSTEM DISP | CHARACTER** pages 34, 35, 51
- 33 **◀◀ | ◀◀ STEP/SLOW** pages 28–29
- 34 **▶▶ | ||▶ STEP/SLOW** pages 28–29
- 35 **◀◀ | -PREV | FOLDER/GROUP** pages 28–29, 53
- 36 **▶▶ | +PREV | FOLDER/GROUP** pages 28–29, 53
- 37 **MUTE** Press to mute/restore the sound
- 38 **CH LEVEL** page 64
- 39 **SURROUND** page 38
- 40 **DSP** page 40
- 41 **AUDIO** page 42
- 42 **SUBTITLE** page 42
- 43 **ANGLE** page 42
- 44 **DVD DISP** pages 48–49, 54
- 45 **POWER** page 25
- 46 **CH+/-** page 25
- 47 **VOL+/-** page 25
- 48 **INPUT** page 25
- 49 **SHIFT** Press to access alternative button functions
- 50 **CLOCK/TIMER** pages 16, 58–60

遙控器

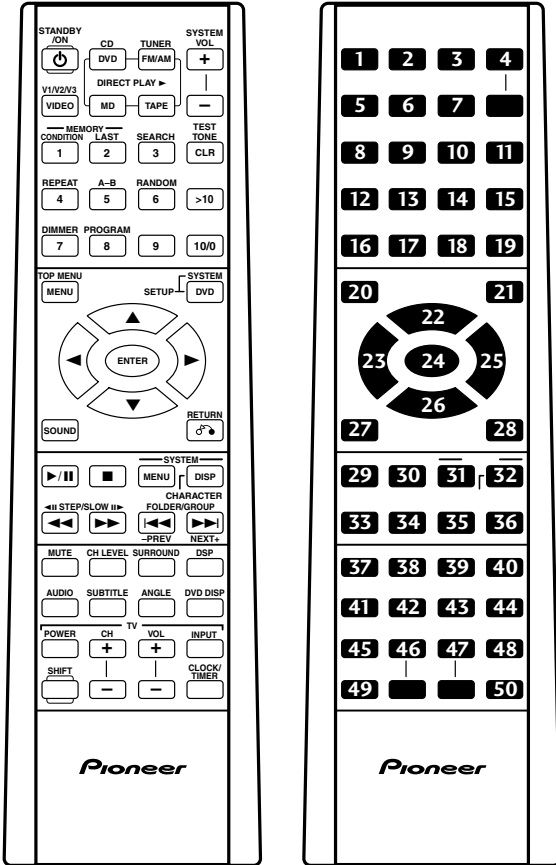

- 1 **STANDBY/ON** 參見第16頁
- 2 **DVD/CD (DIRECT PLAY ▶)** 參見第27頁
- 3 **TUNER FM/AM (DIRECT PLAY ▶)** 參見第31頁
- 4 **SYSTEM VOL +/-**
- 5 **VIDEO V1/V2/V3** 參見第35頁
- 6 **MD (DIRECT PLAY ▶)**
- 7 **TAPE (DIRECT PLAY ▶)**
- 8 **1 | CONDITION** 參見第48頁
- 9 **2 | LAST** 參見第47頁
- 10 **3 | SEARCH** 參見第41, 53頁
- 11 **CLR | TEST TONE** 參見第20頁
- 12 **4 | REPEAT** 參見第46, 54頁
- 13 **5 | A-B** 參見第46頁
- 14 **6 | RANDOM** 參見第45, 53頁
- 15 **>10** 用於選擇大於10的號碼

- 16 **7 | DIMMER** 參見第85頁
- 17 **8 | PROGRAM** 參見第43, 56頁
- 18 **9**
- 19 **10/0** 用作10或0
- 20 **MENU | TOP MENU** 參見第29頁
- 21 **DVD SETUP | SYSTEM SETUP** 參見第18, 65頁
- 22 **▲** 光標上移
- 23 **◀** 光標左移
- 24 **ENTER**
- 25 **▶** 光標右移
- 26 **▼** 光標下移
- 27 **SOUND** 參見第37頁
- 28 **RETURN** 參見第29-30頁
- 29 **▶/||** 參見第27-28, 52頁
- 30 **■** 參見第28, 52頁
- 31 **SYSTEM MENU**
- 32 **SYSTEM DISP | CHARACTER** 參見第34, 35, 51頁
- 33 **◀◀ | ◀◀|| STEP/SLOW** 參見第28-29頁
- 34 **▶▶ | ▶▶|| STEP/SLOW** 參見第28-29頁
- 35 **◀◀◀ | -PREV | FOLDER/GROUP** 參見第28-29, 53頁
- 36 **▶▶▶ | +PREV | FOLDER/GROUP** 參見第28-29, 53頁
- 37 **MUTE** 按該鈕取消/恢復聲音播放
- 38 **CH LEVEL** 參見第64頁
- 39 **SURROUND** 參見第38頁
- 40 **DSP** 參見第40頁
- 41 **AUDIO** 參見第42頁
- 42 **SUBTITLE** 參見第42頁
- 43 **ANGLE** 參見第42頁
- 44 **DVD DISP** 參見第48-49, 54頁
- 45 **POWER** 參見第25頁
- 46 **CH+/-** 參見第25頁
- 47 **VOL+/-** 參見第25頁
- 48 **INPUT** 參見第25頁
- 49 **SHIFT** 按該鈕啓用備用按鈕功能
- 50 **CLOCK/TIMER** 參見第16, 58-60頁

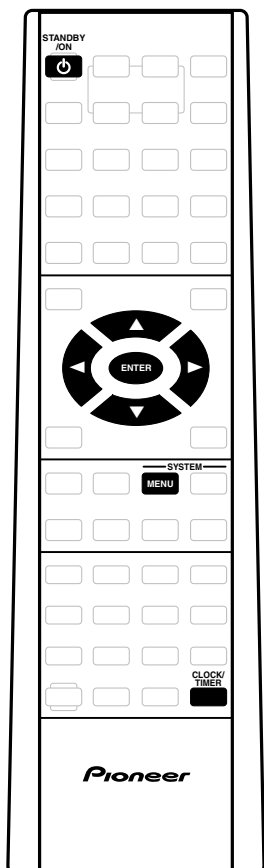

Introduction

Before starting, make sure that your system is installed and set up according to the *Setting up the system* guide, and plugged into a power outlet.

This chapter covers switching on and setting the clock, using the Setup Navigator to set some basic preferences, using all the basic controls for playing discs, using the tuner and playing external sources.

Switching on and setting the clock

This system has a built in clock, which needs to be set to be able to use the timer features.

- 1 Press **STANDBY/ON** to switch on.
- 2 Press **CLOCK/TIMER** then use the **◀** or **▶** buttons to select **CLOCK ADJUST**.

CLOCK ADJUST

- 3 Press **ENTER**.

You should see a time displayed, with the hour part blinking.

9:00 am

簡介

在開始使用之前，請確認您的系統已按照設置系統的指導進行了設置並完成了安裝，然後再將電源插頭插入電源插座。

本章內容包括打開電源和設置時鐘，使用設置嚮導設置一些基本參數，使用基本控制功能播放碟片，使用調諧器及播放外接設備。

打開電源和設置時鐘

本系統含有內置時鐘，經設置後方可使用定時器功能。

- 1 按 **STANDBY/ON** 打開電源。
- 2 按 **CLOCK/TIMER**，然後用 **◀** 或 **▶** 按鈕選擇 **CLOCK ADJUST**。

CLOCK ADJUST

- 3 按 **ENTER**。

出現時間顯示，小時部份正在閃爍。

9:00 am

4 Use the ▲ and ▼ buttons to set the hour, then press ENTER.

- The default clock display format is 12-hour.

5 Use the ▲ and ▼ buttons to set the minute, then press ENTER.

The display blinks for 2 seconds to indicate that the time has been set.



Tip

Press **SYSTEM DISP** anytime to see the clock when the system is on or in standby.

■ Changing the clock display format

You can choose to display the clock and timer settings in 12-hour (default setting) or 24-hour format.

1 If the system is on, press ⏻ STANDBY/ON to put it into standby.

2 Press SYSTEM MENU and select HOUR FORMAT.

- Use the ◀ and ▶ buttons to change the currently displayed option. Press **ENTER** to select.

3 Select 12-HOUR or 24-HOUR format.

- Use the ▲ and ▼ buttons to change the currently displayed option. Press **ENTER** to select.

The system returns to standby after pressing **ENTER**.

4 用 ▲ 和 ▼ 按鈕設置小時，然後按 ENTER。

- 默認的時鐘顯示格式為12小時制。

5 用 ▲ 和 ▼ 按鈕設置分鐘，然後按 ENTER。

顯示部分閃爍2秒鐘，表示時間已設定。



提示

當系統處於開機或待機狀態時，任何時候按 **SYSTEM DISP** 都可顯示時鐘。

■ 更改時鐘顯示格式

您可以將時鐘和定時器顯示格式設置為12小時制（默認設置）或24小時制。

1 如果系統處於開機狀態，則按 ⏻ STANDBY/ON 使其進入待機狀態。

2 按 SYSTEM MENU，選擇 HOUR FORMAT。

- 用 ◀ 和 ▶ 按鈕變更當前顯示的選項。按 **ENTER** 選定。

3 選擇 12-HOUR 或 24-HOUR 格式。

- 用 ▲ 和 ▼ 按鈕變更當前顯示的選項。按 **ENTER** 選定。

按 **ENTER** 後本系統將返回待機狀態。

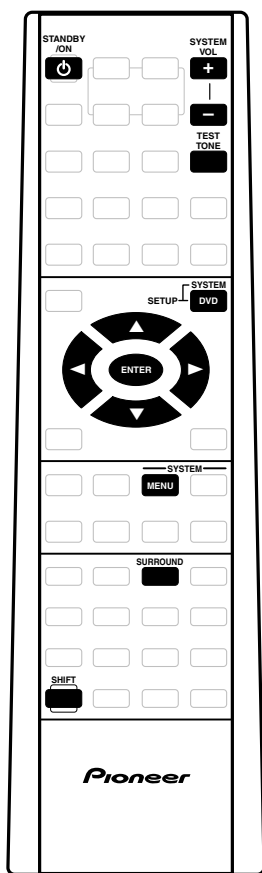

Setting up for surround sound

You can use this system right out of the box for surround sound with just the default settings. However, for really great surround sound, we recommend that you spend a few minutes making some settings that match this system to your listening room. These include setting the distances from your listening position to your speakers, and balancing the speaker volumes. Unless you change the layout of your speakers or main listening position, you only need to make these settings once.

Setting the speaker distances

1 Press **SYSTEM SETUP**.

- To access this function, hold down **SHIFT**, then press **SYSTEM SETUP**.

2 Press **◀** or **▶** until you see **FRONT** in the display.

FRONT SP 3.0m

3 Use the **▲** and **▼** buttons to set the distance from your main listening position to the front left/right speakers.

Ideally, your listening position should be equidistant from the two front speakers.

The default setting is 3m. You can adjust the range from 0.3m to 9.0m in steps of 0.3m.

設置環繞聲

本系統在拆箱後，運用其默認設置即可直接欣賞環繞聲效果。但是，倘若您想獲得最佳的環繞聲效果，我們建議您花費幾分鐘時間進行一些設置，使本系統與您的視聽室相匹配。這些設置包括聽音位置與揚聲器之間的距離設置及揚聲器音量的平衡。除非您要更改揚聲器的佈局或主聽音位置，否則您祇需設置一次即可。

設置揚聲器距離

1 按 **SYSTEM SETUP**。

- 若要啓用該功能，請按住 **SHIFT**，然後按動 **SYSTEM SETUP**。

2 按 **◀** 或 **▶** 直到顯示屏中出現 **FRONT**。

FRONT SP 3.0m

3 用 **▲** 和 **▼** 按鈕設置主聽音位置與前置左/右揚聲器之間的距離。

在理想情況下，您的聽音位置與兩個前置揚聲器之間的距離應相等。默認設置是3米。您可以在0.3米至9.0米的範圍內進行調整，調整幅度為0.3米。

- 4 Press ► to move on to the **CENTER speaker setting**.

CENTER SP 3.0m

- 5 Use the ▲ and ▼ buttons to set the distance from your main listening position to the center speaker.

The default setting is 3m. You can adjust the range from 0.3m to 9.0m in steps of 0.3m.

- 6 Press ► to move on to the **SURROUND speakers setting**.

SURR. SP 3.0m

- 7 Use the ▲ and ▼ buttons to set the distance from your main listening position to the surround speakers.

Ideally, your listening position should be equidistant from the surround speakers.

The default setting is 3m. You can adjust the range from 0.3m to 9.0m in steps of 0.3m.

- 8 Press **ENTER** to make the last setting and exit.

- The setting mode is automatically exited if no operation is performed within 20 seconds.



Note

- There are several other settings that you can make from the System Setup menu to further enhance the surround sound. See chapter 10 for more on this.
- The speaker distance settings have no effect when the surround mode is set to **VIRTUAL SURR.1** or **VIRTUAL SURR.2**. See chapter 5 for more on surround modes.

- 4 按 ►，轉換至到 **CENTER 揚聲器設置**。

CENTER SP 3.0m

- 5 用 ▲ 和 ▼ 按鈕設置主聽音位置至中置揚聲器之間的距離。

默認設置是3米。您可以在0.3米至9.0米的範圍內進行調整，調整幅度為0.3米。

- 6 按 ►，轉換至 **SURROUND 揚聲器設置**。

SURR. SP 3.0m

- 7 用 ▲ 和 ▼ 按鈕設置主聽音位置至環繞聲揚聲器之間的距離。

在理想情況下，您的聽音位置與環繞聲揚聲器之間的距離應相等。

默認設置是3米。您可以在0.3米至9.0米的範圍內進行調整，調整幅度為0.3米。

- 8 按 **ENTER** 確定最終設置並退出。

- 如果在20秒鐘內沒作任何操作，將自動退出設置模式。



注意

- System Setup 選單中還有其他設置可供選擇，可進一步增強環繞聲效果。詳情請參見第10章。
- 如果環繞聲模式設置為 **VIRTUAL SURR.1** 或 **VIRTUAL SURR.2**，則揚聲器距離設置無效。關於環繞聲模式的詳情請參見第5章。

■ Balancing the surround sound

You can further improve surround sound performance by balancing the levels from the subwoofer, center and surround speakers relative to the front left/right speakers. To help you judge the sound level of each speaker a test tone is played through each speaker in turn (make sure that there are no headphones connected). Adjust the levels until they all sound equal. The levels you set here will apply to all surround modes. However, you can set levels independently for each DSP mode (see page 64 for more on this).



Note

It may not be possible to accurately adjust the subwoofer level using this method. You may prefer to leave it on its default setting and adjust it to your liking later when playing surround-sound sources.

1 Press SURROUND.

STANDARD

The surround mode can be set to anything except **SURROUND OFF** or **AUTO** (No test tone is output if the surround mode is set to either of these settings.)

2 Set the volume to a moderate level.

3 Press TEST TONE (SHIFT and CLR) to start the test tone then adjust the master volume to a suitable level.

The test tone plays through each speaker in turn:

- Front left
- Center
- Front right
- Surround right
- Surround left
- Subwoofer

■ 環繞聲的平衡

您可以對副低音揚聲器，相應的中置揚聲器和環繞聲揚聲器以及前置左/右揚聲器的音平進行平衡，以便進一步提高環繞聲性能。為幫助您判斷各揚聲器的音平，各揚聲器將按順序發出一個測試音（請確認系統沒有插接耳機）。調整各揚聲器的音平，直到它們均衡。

您在此步驟中設置的音平將適用於所有環繞聲模式。不過，您可以為各個DSP模式分別設置音平（詳情請參見第64頁）。



注意

利用上述方法可能無法精確調整副低音揚聲器的音平。您可以先讓其保留默認設置，以後播放環繞聲音源時再行調整。

1 按 SURROUND。

STANDARD

環繞聲可設置為 **SURROUND OFF** 或 **AUTO** 以外的任何模式（如果環繞聲設置為這兩種模式，則不會輸出測試音）。

2 將音量設置為適中的音平。

3 按 TEST TONE (SHIFT 和 CLR) 啓動測試音，然後將主音量調整至合適的音平。

各揚聲器將按下列順序播放測試音：

- 前置左
- 中置
- 前置右
- 環繞聲右
- 環繞聲左
- 副低音

- 4 Use the ▲ and ▼ buttons to adjust the level of a speaker as the test tone plays.

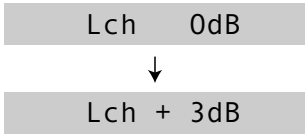

For best results, sit in your main listening position when doing this. You can adjust each speaker in the range of +/-10dB.

- 5 When you're done, press TEST TONE to turn off the test tone.

Setting the TV System

The default setting of this player is **AUTO**, and unless you notice that the picture is distorted when playing some discs, you should leave it set to **AUTO**.

If you experience picture distortion with some discs, set the TV system to match your country or region.



Note

When set to **NTSC**, PAL encoded DVD discs are output as is.

- 1 Make sure that the system is in standby.
- 2 Press **SYSTEM MENU**.
- 3 Press ◀ or ▶ repeatedly until you see **VIDEO SELECT** appear in the display.
- 4 Press **ENTER**.
- 5 Use ▲ or ▼ to select the video system. Switch between **AUTO**, **PAL** and **NTSC**.
- 6 Press **ENTER**.

- 4 播放測試音時用 ▲ 和 ▼ 按鈕調整揚聲器音平。

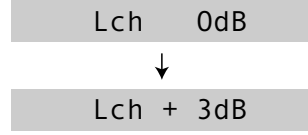

為獲得最佳效果，進行上述操作時請坐在主聽音位置上。各揚聲器的調整範圍為+/-10dB。

- 5 操作完成後，按 **TEST TONE** 關閉測試音。

設置電視制式

本機的默認設置為 **AUTO**，除非在播放某些碟片時發現有影像失真現象，否則無需改變此設置。如果在播放某些碟片時發現影像失真，則根據您所在國家或地區的電視制式進行設置。



注意

設置為 **NTSC** 時，PAL編碼的DVD碟片將按原樣輸出。

- 1 請確認本系統處於待機狀態。
- 2 按 **SYSTEM MENU**。
- 3 反復按 ◀ 或 ▶，直到顯示屏中出現 **VIDEO SELECT**。
- 4 按 **ENTER**。
- 5 用 ▲ 和 ▼ 按鈕選擇電視制式。在 **AUTO**，**PAL** 和 **NTSC** 之間選擇。
- 6 按 **ENTER**。

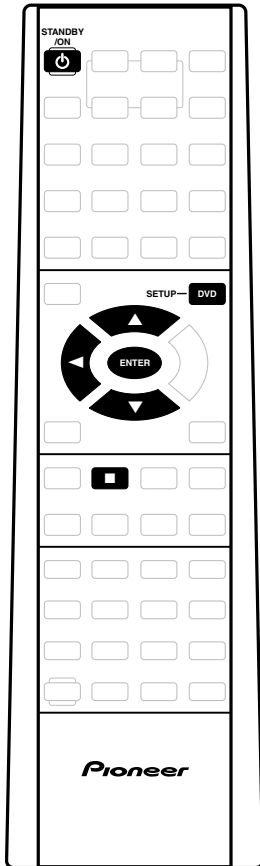

Using the setup navigator

Before playing any discs, we strongly recommend using the Setup Navigator. This makes some basic DVD system settings for you.

1 Press **STANDBY/ON** to switch on.

Also turn on your TV and make sure that it is set to the correct video input.

- If a disc already loaded starts playing, press **STOP** to stop it.

2 Press **DVD SETUP**.

The Setup Navigator on-screen display (OSD) appears:



Navigate all of the following OSDs using these controls:

▲, ▼ – cursor up/down

ENTER – select the highlighted menu option

◀ – go back to the previous question

The control possibilities for the current OSD are shown at the bottom of each screen.

使用設置嚮導

在播放碟片之前，我們強烈建議您使用設置嚮導。該功能可幫助您進行一些基本的DVD系統設置。

1 按 **STANDBY/ON**，打開電源。

同樣也請打開電視機，確認電視機設置了正確的視頻輸入模式。

- 如果裝入的碟片開始播放，請按 **STOP** 停止播放。

2 按 **DVD SETUP**。

螢幕上顯示 (OSD) 設置嚮導：

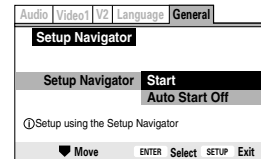

使用下列控制按鈕即可導向所有的 OSD：

▲, ▼ – 光標上移/下移

ENTER – 選擇高亮的選單選項

◀ – 返回前一選項

當前OSD中可執行的控制已顯示於各畫面的底部。

3 Select 'Start'.

- Press **ENTER** to select the highlighted option.
- If you decide you don't want to use the Setup Navigator, select **Auto Start Off** here instead.

4 Choose an OSD menu language.

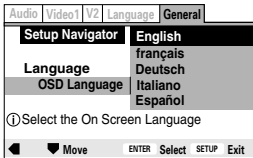

Note

- The language options shown in the on-screen display illustrations on the following pages may not correspond to those available in your country or region.

5 Select the type of TV you have.

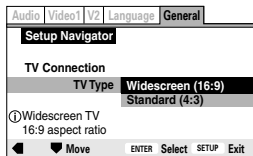

- See *Aspect ratio* in the glossary on page 87 if you're unsure of the difference between widescreen and standard TVs.

6 Confirm all the settings.

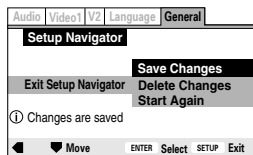

Congratulations, you've set up your system!

If you want to use the Setup Navigator again at any time, it is available from the **General** menu. Also, each individual setting can be changed using the appropriate menu option—chapter 10 explains all menu options in detail.

3 選擇 “Start” 。

- 按 **ENTER** 選擇高亮顯示的選項。
- 如果您已決定不使用設置嚮導，則選擇**Auto Start Off**。

4 選擇 OSD 選單語言。

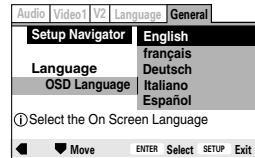

注意

- 後文所示的螢幕畫面中的語言選項可能與您所在國家或地區不附。

5 選擇電視機的類型。

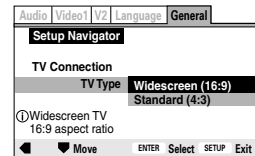

如果您不確定寬螢幕和標準電視機之間的區別，請查閱第87頁詞彙表中的縱橫比 (Aspect ratio) 。

6 確認所有設置。

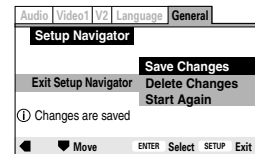

祝賀您，您已經完成系統設置！

如果您以後還要使用設置嚮導，請從 **General** 選單進行選擇。當然，各設置也可通過適當的選單選項進行更改—關於各選單選項的詳情，請參見第10章。

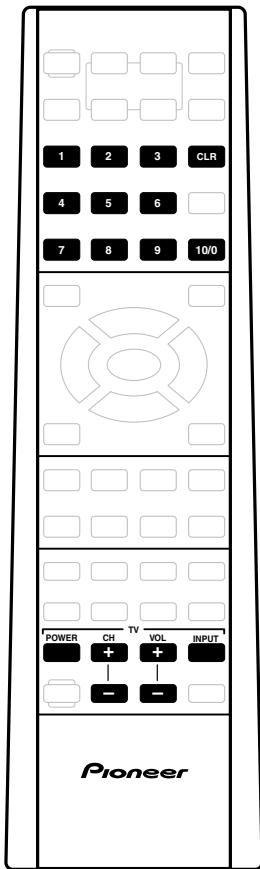

■ Setting up the remote to control your TV

You can set up the supplied remote to control your TV.

- 1 **Switch on your TV.**
- 2 **Find the name of the manufacturer of your TV in the table on the following pages.**

See the code list on the following page.

Next to each manufacturer is one or more three-digit codes. These tell the remote what kind of TV you have.

- If the name of the manufacturer of your TV does not appear in the table, you won't be able to set up this remote to control your TV.

- 3 **Point the remote at your TV, hold down the CLR button, then enter the three digit code for your TV.**

The remote transmits an on/off signal to the TV. If you've entered the correct code, your TV should switch off.

If your TV doesn't turn off, repeat the procedure using the next code in the list until your TV switches off.

■ 設置遙控器，使其可控制電視機

您可以設置隨機提供的遙控器來控制您的電視機。

- 1 打開電視機。
- 2 請在下一頁的表格中查詢電視機製造商的名稱。
請查詢下一頁中的代碼列表。

與各製造商相對應的是一個或多個三位數代碼。遙控器根據這些代碼獲知電視機的類型。

- 如果您的電視機的製造商沒有出現在列表中，那麼就無法使用該遙控器來控制電視機。

- 3 將遙控器對準電視機，按住 CLR 按鈕，然後輸入電視機的三位數代碼。

遙控器將向電視機發送一個開/關信號。如果您輸入了正確的代碼，電視機將關閉。

如果電視機沒有關閉，則輸入列表中的下一個代碼重複該步驟，直到電視機關閉為止。

Using this remote with your TV

The table below shows the TV controls available from this remote for Europe.

Button	What it does
POWER	Press to switch your TV on or into standby
CH +/-	Press to change the TV channel
VOL +/-	Press to turn up the TV volume
INPUT	Press to switch the TV's input between the

Manufacturer 製造商	Code(s) 編碼
AIWA	138 142 143
AKAI	504 505 515 548 550 562 563
ALBA	512 515 568 569
AMSTRAD	561 567 568 569 570 571
BAUR	562 563
BLAUPUNKT	548 550 556
BRANDT	544 545 564 565
BUSH	508 512 513 514 515 559 568 569
CONTINENTAL EDISO	545 564 565
DAEWOO	515 558 106 135 196
DUAL	559
EMERSON	561 562 563
FERGUSON	515
FINLUX	515 535 536 537 538 539 542 543
FISHER	507 504 505 111
FUJITSU	139 156 157 160
FUNAI	508 141 136 137 140 146 147 155
GOLDSTAR	515 104
GOODMANS	515 542 543 558 569
GRAETZ	560 562 563 566
GRUNDIG	548 550
HITACHI	507 100 530 544 545 566 104 113 183
ICE	141 569
INNO HIT	515
ITT	562 563 566 104 113 183
ITT-NOKIA	504 505 512 566
JVC	527 114 158 159 167 184
KENDO	536
LOEWE	519 520 556
LOEWE OPTA	556
LUXOR	507 562 563 566
MARANTZ	117
MATSUI	503 504 505 508 512 513 514 542 543 515 561 566 567
MITSUBISHI	519 520 525 526 548 550 567 104 105 117 172 198 124

使用遙控器控制電視機

下表顯示了適用歐洲的用遙控器控制電視機的方法。

按鈕	功能
POWER	按該鈕打開電視機或進入待機狀態
CH +/-	按該鈕更換電視頻道
VOL +/-	按該鈕調節電視機的音量
INPUT	按該鈕選擇電視機的輸入模式為內置電視調諧器還是外接視頻源。

Manufacturer Fabricant	Code(s) 編碼
NATIONAL	100 101 102 151
NEC	104 105
NOKIA	504 505 512 562 563 566
NORDMENDE	544 545 566
OCEANIC	546 547
ONWA	571
ORION	508 510 512 513 514 515 561 128
PANASONIC	100 530 551 552 553 101 566 102 151 193 194 200
PHILIPS	515 518 521
PHONOLA	515
PIONEER	566 107 562 572 101 118
PRISM	101
QUASAR	101 103
RADIOLA	515
SABA	544 545 564 566
SALORA	504 505 562 563 566
SAMSUNG	515 521 141 542 543 104 105 123 170
SANYO	504 505 523 542 543 111 149 152 153 154 197
SCHNEIDER	515 566
SEG	536
SELECO	515 539 566
SHARP	523 124 120 150 187
SIEMENS	515 523 548 550 566
SINUDYNE	508 512 515 535 536 539
SONY	125 188 192
TANDBERG	545
TANDY	566
TECHNICS	100
THOMSON	512 544 545 564 565
THORN	503 107 515 519 520 125 542 543 558 562 563
TOSHIBA	500 503 107 510 124 189
WHITE WESTINGHOUS	515 535 536

Manufacturer 製造商	Code(s) 編碼
ADMIRAL	112 124 126
AIWA	138 142 143
AKAI	104
AOC	105
BELL&HOWEL	124 126 178
BROKSONIC	104 105 180 144
CENTURION	105
CIS HOTEL	199
CORONAD	164
CRAIG	109 110 108
CROSLEY	115
CURTIS MAT	104 107 110
DAEWOO	106 104 135 196
EMERSON	109 108 110 104 120 133 134 180
FISHER	111
FUJITSU	139 156 157 160
FUNAI	136 137 140 141 155 146 147
GE	112 101 104 132
GOLDSTAR	104 105 165
HITACHI	113 104 183
INTEQ	126 127
JC PENNY	104 112
JVC	114 158 159 167 184
KTV	104 110 166
LXI	112 104 115 111 107 105
MAGNASONIC	178
MAGNAVOX	115 105 104 116 129 168
MARANTZ	117
MEMOREX 178	
MGA	104 105

Manufacturer 製造商	Code(s) 編碼
MITSUBISHI	117 104 105 124 172
MTC	101 103
NATIONAL	100 101 102 151
NEC	104 105
ORION	128
PANASONIC	100 101 102 151 193
PHILCO	115 104
PHILIPS	115
PIONEER	118 101 107
PORTLAND	104
PRISM	101
PROSCAN	112 104 121 119 122 185
QUASAR	101 103
RADIOSHACK	112 105 117 110
RCA	112 104 121 119 122 130 131 161 162 163 132 169 186
SAMSUNG	123 105 104 170
SANYO	111 149 152 153 154 197
SCOTT	110 105
SEARS	107 112 104 115 111 105
SHARP	124 120 150 187
SIGNATURE	124 126
SONY	125 192 188
SYLVANIA	115 105 104
SYMPHONIC	110 171
TECHNICS	100
TOSHIBA	107 124 189
VIDTECH	113 104 105
WARDS	104 120 105
ZENITH	126 127 190 144

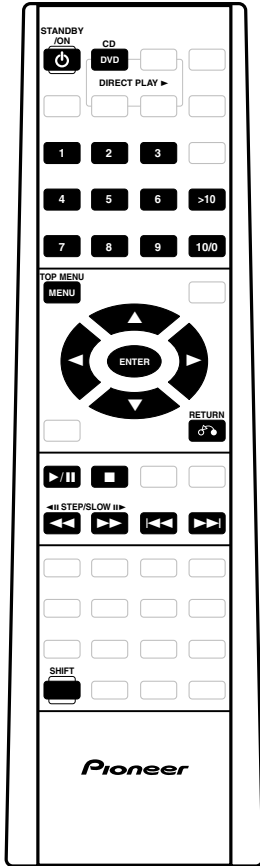

■ Playing DVDs, CDs and Video CDs

The basic controls for playing discs are covered here. Further functions are detailed in the next chapter.

- 1 Press **STANDBY/ON** (remote or front panel) to turn on the system.
- 2 Press **DVD/CD**.
- 3 Touch the **OPEN/CLOSE** sensor (front panel only) to open the disc tray.
- 4 Load a disc.
- 5 Press **▶/||** to start playback of the disc just loaded.

On the front panel, touch the **▶/||** touch-sensor to start playback.

- If you're playing a DVD or Video CD, a menu may appear. See page 29-30 for how to navigate these.

■ 播放DVD，CD和VCD

下文將說明播放碟片的基本控制方法。各功能詳情將在下一章作進一步介紹。

- 1 按 **STANDBY/ON** (位於遙控器或面板上)，打開本系統。
- 2 按 **DVD/CD**。
- 3 觸摸 **OPEN/CLOSE** 傳感器 (僅位於前面板)，打開碟片托盤。
- 4 裝入碟片。
- 5 按 **▶/||** 開始播放剛才裝入的碟片。

將碟片帶標籤一面朝上裝入，利用碟片托盤導軌調整碟片安放位置 (如果您裝入的是雙面DVD碟片，則將要播放的一面朝下裝入)。

- 5 按 **▶/||** 開始播放剛才裝入的碟片。

觸摸前面板上的 **▶/||** 接觸式傳感器，開始播放。

- 如果您播放的是 DVD 或 VCD，則可能會出現一個選單。如何操作請參見第29-30頁。

Basic playback controls

Button	What it does
▶/	Starts playback or pauses a disc that's playing (press again to restart playback). DVD and Video CD only: Resumes playback of a stopped disc.
■	Stops playback. DVD and Video CD only: Display shows RESUME (press ▶/ to start playback again from the last place stopped).
◀◀	1. Press & hold for fast reverse scanning. Release to resume normal playback. 2. Press once to start reverse scanning. Press again to increase the scan speed. (CD and Video CD have two scan speeds; DVD has three.) Press ▶/ to resume normal playback.
▶▶	1. Press & hold for fast forward scanning. Release to resume normal playback. 2. Press once to start forward scanning. Press again to increase the scan speed. (CD and Video CD have two scan speeds; DVD has three.) Press ▶/ to resume normal playback.
◀◀	Skips to the start of the current track or chapter, then to previous tracks/chapters.
▶▶	Skips to the next track or chapter.
Numbers	If the disc is stopped, playback starts from the selected track or title number. If the disc is playing, playback jumps to the start of the selected track or chapter number.
>10	Selects tracks/titles/chapters 11 and over. (For example, for 24, press >10 , 2 , 4.)

基本播放控制

按鈕	功能
▶/	開始播放碟片或暫停播放碟片（再按可重新開始播放）。僅用於DVD和VCD：使已停止播放的碟片恢復播放。
■	停止播放。僅用於DVD和VCD：顯示屏顯示 RESUME （按 ▶/ 將從上次停止處重新開始播放）。
◀◀	1. 按住該鈕不放，可快速向後掃描。釋放後可恢復正常播放。 2. 按一次開始向後掃描。再按一次可加快掃描速度。（CD和VCD有兩種掃描速度；DVD有三種。）按 ▶/ 恢復正常播放。
▶▶	1. 按住該鈕不放，可快速向前掃描。釋放後可恢復正常播放。 2. 按一次開始向前掃描。再按一次可加快掃描速度。（CD和VCD有兩種掃描速度；DVD有三種。）按 ▶/ 恢復正常播放。
◀◀	跳至當前軌跡或章的開始處，再按則依次向前跳躍。
▶▶	跳至下一軌跡或章。
數字鈕	如果碟片已停止播放，則從選定的軌跡或標題號開始播放。如果碟片正在播放，則跳至選定的軌跡或章號的開始處開始播放。
>10	選擇11以上的軌跡/標題/章。（例如，要選擇24，則按 >10 , 2 , 4。）



DVD and Video CD only:

- II▶ (SHIFT ▶▶)** 1. Press to start slow-motion forward scanning. Press again to change the scanning speed ($1/16 \rightarrow 1/8 \rightarrow 1/4 \rightarrow 1/2$).
2. When playing, press once to pause; advance a single frame with each subsequent press.

DVD only:

- ◀II (SHIFT ◀◀)** 1. Press to start slow-motion reverse scanning. Press again to switch between **SLOW 1** and **SLOW 2** scanning speed.
2. When playing, press once to pause; reverse a single frame with each subsequent press.

**Important**

While using the DVD playback controls, you may see the  or  mark displayed on-screen.

 means that the operation is not allowed by the system.

 means that the operation is not allowed by the disc.

■ Navigating DVD disc menus

Many DVD discs contain menus. Sometimes these are displayed automatically when you start playback; others only appear when you press **MENU** or **TOP MENU**.

Button	What it does
TOP MENU	Displays the 'top menu' of a DVD disc—this varies with the disc.
MENU	Displays a DVD disc menu—this varies with the disc and may be the same as the 'top menu'.
RETURN 	Returns to the previously displayed menu screen.
▲ ▼ ◀ ▶	Moves the cursor around the screen
ENTER	Selects the current menu option
Numbers	Selects a numbered menu option (some discs only)

僅用於DVD和VCD：

- II▶ (SHIFT ▶▶)** 1. 按該鈕開始慢動作向前掃描。再按一次可更改掃描速度 ($1/16 \rightarrow 1/8 \rightarrow 1/4 \rightarrow 1/2$)。
2. 播放時，按一次該鈕則暫停；以後每按一次前進一幀畫面。

僅用於DVD：

- ◀II (SHIFT ◀◀)** 1. 按該鈕開始慢動作向後掃描。再按一次則在 **SLOW 1** 和 **SLOW 2** 之間轉換掃描速度。
2. 播放時，按一次該鈕則暫停；以後每按一次後退一幀畫面。

**重要**

使用DVD播放控制按鈕時，螢幕上可能會顯示 

或  標誌。

 表示對本系統無效的操作。

 表示對碟片無效的操作。

■ DVD碟片選單導向

許多DVD碟片含有選單。有時碟片開始播放時會自動出現選單；有時僅在按 **MENU** 或 **TOP MENU** 時出現。

按鈕	功能
TOP MENU	顯示DVD碟片的“頂層選單”——根據碟片各不相同。
MENU	顯示DVD碟片選單——根據碟片各不相同，但可能與“頂層選單”相同。
RETURN 	返回前一選單畫面。
▲ ▼ ◀ ▶	使光標在畫面中移動。
ENTER	選擇當前選單選項。
數字鈕	選擇編號的選單選項（僅用於某些碟片）。

■ Navigating Video CD PBC menus

Some Video CDs have menus from which you can choose what you want to watch. These are called PBC (Playback control) menus.

You can play a PBC Video CD without having to navigate the PBC menu by starting playback using a number button to select a track, rather than the ►/|| button.

Button	What it does
RETURN 	Displays the PBC menu.
Numbers	Selects a numbered menu option.
◀◀	Displays the previous menu page (if there is one).
▶▶	Displays the next menu page (if there is one).
►/	Press to select an item from a PBC menu.

■ VCD PBC 選單導向

某些VCD含有選單，用以選擇要觀看的內容。這種選單稱為PBC（播放控制）選單。

播放PBC VCD時，祇需按數字鈕選定軌跡即可開始播放，無需按 ►/|| 按鈕來導向PBC選單。

按鈕	功能
RETURN 	顯示PBC選單。
數字鈕	選擇編號的選單選項。
◀◀	顯示前一選單畫面（若有）。
▶▶	顯示後一選單畫面（若有）。
►/	按該鈕從PBC選單中選擇選項。

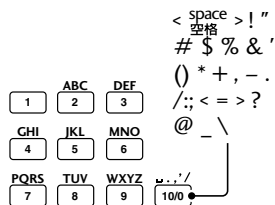
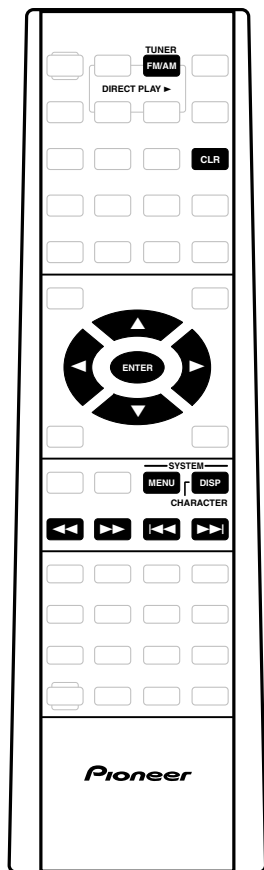

Station naming buttons
電台命名按鈕

■ Listening to the radio

The following steps show you how to tune in to FM and AM radio broadcasts using the automatic, manual and high-speed tuning functions. Once you are tuned to a station you can memorize the frequency for recall later—see *Saving station presets* on the following page for how to do this.

1 Press TUNER FM/AM to select the tuner.

Press repeatedly to switch between FM and AM bands.

FM 87.50MHz

AM 531kHz

2 Tune to a station.

There are three ways to do this:

• Automatic tuning

To search for stations in the currently selected band, press and hold either the ◀◀ or ▶▶ button for about a second. The system will start searching for the next station, stopping when it has found one. Repeat this step to search for other stations.

• Manual tuning

To change the frequency one step at a time, press the ◀◀ or ▶▶ buttons.

• High-speed tuning

Press and hold the ◀◀ or ▶▶ button for high speed tuning, releasing the button once you reach the frequency you want.

• It's also possible to use the ▲ and ▼ buttons for tuning.

■ 收聽收音機

下列步驟將介紹如何使用自動，手動和快速調諧功能來調諧FM和AM無線電廣播。調諧至某一電台時，您可以記憶該電台頻率以便日後調用—關於操作詳情請參見下一頁保存預設電台。

1 按 TUNER FM/AM，選定調諧器。

反復按該鈕在FM和AM波段之間進行轉換。

FM 87.50MHz

AM 531kHz

2 調諧至某一電台。

有三種操作方法：

• 自動調諧

若要在當前選定的波段搜索電台，請按住 ◀◀ 或 ▶▶ 按鈕約一秒鐘。系統將開始搜索下一電台，發現電台時將停止搜索。重複該步驟可搜索其他電台。

• 手動調諧

若一次祇要改變一檔頻率，請按 ◀◀ 或 ▶▶ 按鈕。

• 快速調諧

按住 ◀◀ 或 ▶▶ 按鈕可進行快速調諧，一旦找到所需的頻率則釋放該按鈕。

• 也可使用 ▲ 和 ▼ 按鈕進行調諧。

■ Improving FM stereo sound

If you're listening to a stereo FM broadcast, but find that there is a lot of noise because of a weak signal, try switching to mono.

1 Press SYSTEM MENU and select TUNER MENU.

TUNER MENU

- Change menu options using the ◀ and ▶ buttons. Press **ENTER** to select the currently displayed option.

2 Select FM AUTO/MONO from the tuner menu.

FM AUTO/MONO

- Change menu options using the ◀ and ▶ buttons. Press **ENTER** to select the currently displayed option.

3 Select FM AUTO or FM MONO.

- Change menu options using the ▲ and ▼ buttons. Press **ENTER** to select the currently displayed option.

When listening in mono, the ● indicator lights in the display.

■ Saving station presets

If you often listen to a particular radio station, it's convenient to have the receiver store the frequency for easy recall whenever you want to listen to that station. This saves the effort of manually tuning in each time. This system can save up to 30 station presets. When saving FM frequencies, the receiver also saves the mono setting (see above).

1 Tune to a station you want to memorize.

See *Listening to the radio* on the previous page for more on how to do this.

■ 改善FM立體聲收音效果

如果您收聽的是立體聲FM廣播，但發現因訊號太弱至使噪音過大時，請轉換至單聲道進行嘗試。

1 按SYSTEM MENU，選擇 TUNER MENU。

TUNER MENU

- 用 ◀ 和 ▶ 按鈕變更選單選項。

按 **ENTER** 選擇當前顯示的選項。

2 從調諧器選單中選擇 FM AUTO/MONO。

FM AUTO/MONO

- 用 ◀ 和 ▶ 按鈕變更選單選項。

按 **ENTER** 選擇當前顯示的選項。

3 選擇 FM AUTO 或 FM MONO。

- 用 ▲ 和 ▼ 按鈕變更選單選項。

按 **ENTER** 選擇當前顯示的選項。

以單聲道方式收聽時，● 指示燈將在顯示屏中亮起。

■ 保存預設電台

如果您經常收聽某個電台，則可用本系統將該電台頻率保存下來，以便日後收聽時調用。該功能可保存每次手動調諧的電台，最多可保存30個預設電台。在保存FM頻率時，本系統也可保存單聲道設置（請參見上文）。

1 調諧至需要記憶的電台。

關於操作詳情請參見前一頁的收聽收音機。

2 Press SYSTEM MENU and select TUNER MENU.

TUNER MENU

- Change menu options using the ◀ and ▶ buttons. Press ENTER to select the currently displayed option.

3 Select STATION MEMORY from the tuner menu.

STATION MEMORY

- Change menu options using the ◀ and ▶ buttons. Press ENTER to select the currently displayed option.

4 Press ▲ or ▼ to select a station preset number.

ST 1 FM 87.50



ST 3 FM 87.50

5 Press ENTER to save the station preset.

Repeat these steps to save up to 30 station presets.

Listening to station presets

Having saved up to 30 station presets (see above), you can be listening to a station with a couple of button presses.

1 Press TUNER FM/AM to switch to the tuner.

2 Use the |◀◀ / ▶▶| or the ◀ / ▶ buttons to select the station preset you want to listen to.

Alternatively, use the number buttons (use the >10 button for numbers over 10).

- If the system is left disconnected from the AC power outlet for a lengthy period, the station presets will be lost and will have to be reprogrammed.

2 按 SYSTEM MENU，選擇 TUNER MENU。

TUNER MENU

- 用 ◀ 和 ▶ 按鈕變更選單選項。
按 ENTER 選擇當前顯示的選項。

3 從調諧器選單中選擇 STATION MEMORY。

STATION MEMORY

- 用 ◀ 和 ▶ 按鈕變更選單選項。
按 ENTER 選擇當前顯示的選項。

4 按 ▲ 或 ▼ 選擇預設電台的號碼。

ST 1 FM 87.50



ST 3 FM 87.50

5 按 ENTER 保存預設電台。

重複上述步驟進行其他保存，最多可保存30個預設電台。

收聽預設電台

保存預設電台（請參見上文）之後（最多30個），您祇需按幾個按鈕即可以收聽其中的電台。

1 按 TUNER FM/AM，轉換至調諧器。

2 用 |◀◀ / ▶▶| 或 ◀ / ▶ 按鈕選擇要收聽的預設電台。

也可用數字鈕進行選擇（大於10的號碼可用>10按鈕選擇）。

- 如果本系統長期未接至交流電源，預設電台可能會丟失，需要重新設置。

■ Naming station presets

For easier identification, you can name your station presets.

1 Recall the station preset you want to name.

See *Listening to station presets* on the previous page for how to do this.

2 Press **SYSTEM MENU** and select **TUNER MENU**.

TUNER MENU

- Change menu options using the ◀ and ▶ buttons. Press **ENTER** to select the currently displayed option.

3 Select **STATION NAME** from the tuner menu.

STATION NAME

- Change menu options using the ◀ and ▶ buttons. Press **ENTER** to select the currently displayed option.

4 Press **DISP/CHARACTER** to change the character set.

You can switch between alphabet (upper case), alphabet (lower case), numbers and symbols.

5 Use the ▲ and ▼ buttons to change the displayed character; press **ENTER** to select it.

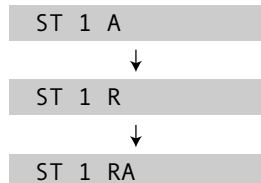

- Press **CLR** to clear a character.
- Use the ◀ and ▶ buttons to move the cursor in the display.
- You can also use the number buttons to select characters. See the diagram on page 31 for which buttons correspond to which characters.

6 Enter the rest of the station name in the same way.

7 When you're done, press **SYSTEM MENU** to exit.

■ 命名預設電台

為便於識別，您可以為預設電台命名。

1 調出要命名的預設電台。

關於操作詳情請參見前一頁的*收聽預設電台*。

2 按 **SYSTEM MENU**，選擇**TUNER MENU**。

TUNER MENU

- 用 ◀ 和 ▶ 按鈕變更選單選項。

按 **ENTER** 選擇當前顯示的選項。

3 從調諧器選單中選擇 **STATION NAME**。

STATION NAME

- 用 ◀ 和 ▶ 按鈕變更選單選項。

按 **ENTER** 選擇當前顯示的選項。

4 按 **DISP/CHARACTER** 變更字符設置。

您可以在字母（大寫），字母（小寫），數字和符號之間轉換。

5 用 ▲ 和 ▼ 按鈕更改顯示的字符；按 **ENTER** 選定。

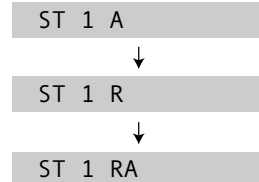

- 按 **CLR** 清除字符。
- 用 ◀ 和 ▶ 按鈕在顯示屏中移動光標。
- 您也可以使用數字鈕來選擇字符。按鈕與字符的對應情況請參見第31頁的圖表。

6 用同樣方法輸入電台名稱的其余字符。

7 完成後按 **SYSTEM MENU** 退出。

■ Tuner system displays

- Press **SYSTEM DISP** to change the information shown in the display.

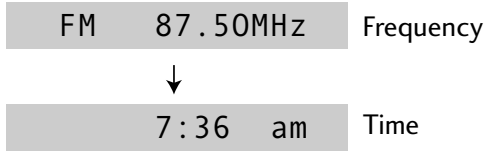

■ Playing other connected components

You may have connected various other components to your system using the analog or digital auxiliary inputs.

- 1 Press **VIDEO V1/V2/V3** to select an auxiliary input.
- 2 For inputs **V1** only: Press **SYSTEM MENU** and select **VIDEO1 INPUT**.
 - Change menu options using the ◀ and ▶ buttons. Press **ENTER** to select the currently displayed option.
- 3 Use the ▲ or ▼ button to select an auxiliary input.
 - INPUT ANALOG ?
 - INPUT OPTICAL ?
- 4 Press **ENTER**.

■ 調諧器系統顯示

- 按 **SYSTEM DISP** 變更顯示屏中顯示的資訊。

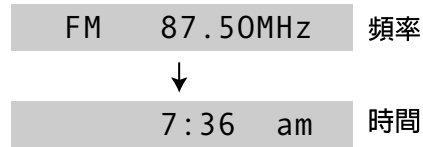

■ 播放所連接的其他設備

您也許已利用了類比或數碼輔助輸入將本系統與其他設備相連。

- 1 按 **VIDEO V1/V2/V3** 選擇一個輔助輸入。
- 2 僅用於 **V1** 輸入：按 **SYSTEM MENU** 並選擇 **VIDEO1 INPUT**。
 - 用 ◀ 和 ▶ 按鈕變更選單選項。
 - 按 **ENTER** 選擇當前顯示的選項。
- 3 用 ▲ 或 ▼ 按鈕選擇輔助輸入。
 - INPUT ANALOG ?
 - INPUT OPTICAL ?
- 4 按 **ENTER**。

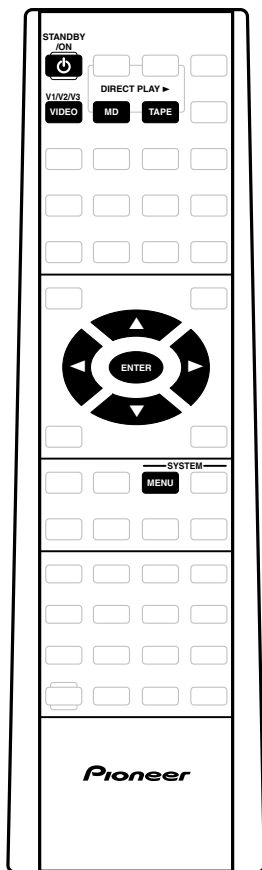

Note

- For detailed instructions on using the optional MD or tape deck, see the included operating instructions.
- For more on controlling your TV using this remote control, see page 25.

Reducing the auxiliary input level

If a component you connected to an analog input causes the sound to distort, the input level is probably too high. You can reduce it by turning on the video input attenuator.

1 Switch the system into standby.

2 Press SYSTEM MENU and select VIDEO ATT.

- Change menu options using the ◀ and ▶ buttons. Press ENTER to select the currently displayed option.

3 Use the ◀ or ▶ button to select VIDEO 1, 2 or 3 ATT, then press ENTER.

4 Select ATT ON or ATT OFF as required.

- Change menu options using the ▲ and ▼ buttons. Press ENTER to select the currently displayed option.

注意

- 關於選購的MD或磁帶卡座的詳細使用說明，請參見相應的使用說明書。
- 關於用遙控器控制電視機的詳細使用說明，請參見第25頁。

降低輔助輸入電平

如果與類比輸入相連的設備造成了聲音失真，則可能是因為輸入電平太高而引起的。您可以打開視頻輸入衰減器來降低該電平。

1 將系統轉換至待機狀態。

2 按 SYSTEM MENU 並選擇 VIDEO ATT。

- 用 ◀ 和 ▶ 按鈕變更選單選項。按 ENTER 選擇當前顯示的選項。

3 用 ◀ 或 ▶ 按鈕選擇 VIDEO 1,2 或 3 ATT，然後按 ENTER。

4 根據需要選擇 ATT ON 或 ATT OFF。

- 用 ▲ 和 ▼ 按鈕變更選單選項。按 ENTER 選擇當前顯示的選項。

Using the Sound menu

This menu gives you access to various amplifier sound settings:



Note

The bass and treble settings have no effect when using the DSP modes, or when the Surround mode is set to anything other than **STANDARD** or **SURROUND OFF**.

1 Press **SOUND**.

2 Use the ◀ or ▶ buttons to select an option from the **Sound** menu.

- **BASS 0**

Adjusts the level of bass.

- **TREBLE 0**

Adjusts the amount of treble.

- **EFFECT 70**

Adjusts the amount of Advanced Theater or DSP effect (not available on all effects).

- **P. BASS ON**

Switches extra bass boost on or off.

- **MIDNIGHT ON**

Switches the low-level listening mode on or off.

3 Use the ▲ and ▼ buttons to adjust the currently selected option.

You can see the current setting in the display.

4 Press **ENTER** to set the level and exit the **Sound** menu.

- If you don't press **ENTER**, the Sound menu is exited anyway after about 5 seconds.

使用 **Sound** 選單

利用該選單可進行多種放大器音響設置：



注意

使用DSP模式時，或者當環繞聲模式設置為 **STANDARD** 或 **SURROUND OFF** 以外的模式時，低音和高音設置都無效。

1 按 **SOUND**。

2 用 ◀ 或 ▶ 按鈕從 **Sound** 選單中選擇一個選項。

- **BASS 0**

調節低音音平。

- **TREBLE 0**

調節高音音平。

- **EFFECT 70**

調節高級影院或DSP效果（並非對所有效果都有效）。

- **P. BASS ON**

打開或關閉重低音增強。

- **MIDNIGHT ON**

打開或關閉低音平收聽模式。

3 用 ▲ 和 ▼ 按鈕調整當前選擇的選項。 您可以在顯示屏上看見當前的設置。

4 按 **ENTER** 設定音平並退出 **Sound** 選單。

- 如果不按 **ENTER**，系統將在5秒左右退出 **Sound** 選單。

■ Using sound modes

This system offers several ways to enjoy surround sound and stereo sources. When playing Dolby Digital, Dolby Surround, Dolby Pro-Logic or DTS sources, we recommend using the surround mode to ensure proper surround sound. From the surround mode you can choose one of the Advanced Theater effects to add room-type effects to the source.

If you want to add room-type effects to stereo sources, we recommend using the DSP effects. Like the Advanced Theater effects, these add ambience to the source to simulate different spaces, such as a concert hall or a club.

■ Playing Dolby/DTS sources

Switch on the surround mode when you play a Dolby Surround, Dolby Digital or DTS source. Use the Advanced Theater effects to add room effects to the surround sound.



Note

The surround mode cannot be used with 96kHz/24-bit sources, or in combination with DSP effects.

1 Press **SURROUND** repeatedly to select a surround mode.

The display shows the current surround mode.

- **AUTO**

For digital sources, decoding is automatically selected according to the source: Dolby Digital, DTS, Dolby Pro Logic, 2-channel stereo, etc. No extra effects are added to the source. Analog sources are played in the same way as the **Surround Off** setting.

■ 使用音場模式

本系統提供多種方式欣賞環繞聲和立體聲音源。在播放杜比數碼，杜比環繞聲，杜比Pro-Logic或DTS音源時，我們建議您使用環繞聲模式以確保適當的環繞聲效果。您可自環繞聲模式選擇高級影院效果，以增加音源的室內效果。

如果您要增加立體聲音源的室內效果，我們建議您採用DSP效果。如同高級影院效果，該功能也可為音源增添環境效果以模擬不同的音場空間，如音樂廳或俱樂部。

■ 播放杜比/DTS音源

當播放杜比環繞聲，杜比數碼或DTS音源時打開環繞聲模式。採用高級影院效果，可為環繞聲增添室內效果。



注意

環繞聲模式不能用於96kHz/24位元音源或與DSP效果結合使用。

1 反復按 **SURROUND**，選擇一種環繞聲模式。 顯示屏顯示當前環繞聲模式。

- **AUTO**

對於數碼音源，將自動根據音源選擇解碼方式：杜比數碼，DTS，杜比Pro Logic，雙聲道立體聲等。但不會為音源增添額外的效果。類比音源的播放方式與 **Surround Off** 設置時的情況相同。

- **STANDARD**

As **AUTO**, except that 2-channel (analog or digital) sources are processed using Dolby Pro Logic for surround-sound effects.

- **MUSICAL**

Concert hall sound.

- **DRAMA**

Classic, mid-size movie theater sound.

- **ACTION**

Large, modern movie theater sound.

- **VIRTUAL SURR. 1**

Virtual surround sound from just the main front stereo speakers and the subwoofer. Use this mode if you can't use the surround speakers.

- **VIRTUAL SURR. 2**

Virtual surround sound if you have connected the surround speakers, but are using them in front of your listening position.

- **REAR WIDE**

Widens the rear channel soundstage.

- **SURROUND OFF**

All sources are played through only the front left and right speakers, and the subwoofer. No effects are added.

2 If necessary, adjust the effect level.

- Select **EFFECT** from the Sound menu and adjust using the ▲ and ▼ buttons. Press **ENTER** to set the level.

EFFECT 70

You can adjust the effect level in the range of 10 to 90 in steps of 10.

- **STANDARD**

與 **AUTO** 基本相同，祇是雙聲道（類比或數碼）音源將使用杜比Pro Logic模式處理，以獲得環繞聲效果。

- **MUSICAL**

音樂廳音場。

- **DRAMA**

古典中型影院音場。

- **ACTION**

大型現代影院音場。

- **VIRTUAL SURR. 1**

僅從主前置立體聲揚聲器和副低音揚聲器產生虛擬環繞聲。在不能使用環繞聲揚聲器的情況下可使用該模式。

- **VIRTUAL SURR. 2**

如果您已連接環繞聲揚聲器，但將它們安置在聽音位置的前方，則使用此虛擬環繞聲。

- **REAR WIDE**

拓寬後方聲道的音域。

- **SURROUND OFF**

所有音源祇能通過前置左右揚聲器和副低音揚聲器播放，且無額外的音場效果。

2 根據需要，調節音場效果的音平。

- 從 Sound 選單選擇 **EFFECT**，用 ▲ 和 ▼ 按鈕進行調節。按 **ENTER** 設定音平。

EFFECT 70

您可以在10至90的範圍內調整音場效果的音平，調整幅度為10。

■ Playing other stereo sources with DSP effects

You can add room effects to audio CDs and other stereo sources using the DSP modes. Different effects work better with different kinds of music, so don't be afraid to experiment a little.

📌 Note

- The DSP effects cannot be used with 96kHz/24-bit sources, or in combination with a surround mode.
- When playing stereo sources with DSP effects switched off, there is no sound from the surround and center speakers.

1 Press DSP repeatedly to select a sound mode.

The display shows the current DSP mode.

- **HALL 1**
Large, wood-paneled concert hall sound.
- **HALL 2**
Large, stone-walled concert hall sound.
- **JAZZ**
Live jazz club sound.
- **DANCE**
Nightclub sound.
- **THEATER 1**
Classic, mid-size movie theater sound.
- **THEATER 2**
Large, modern movie theater sound.
- **SIMUL . STEREO**
Virtual stereo for mono sources.

2 If necessary, adjust the effect level.

- Select **EFFECT** from the Sound menu and adjust using the ▲ and ▼ buttons. Press **ENTER** to set the level.

EFFECT 70

You can adjust the effect level in the range of 10 to 90 in steps of 10.

■ 使用DSP效果播放其他立體聲音源

您可以使用DSP模式為CD等立體聲音源添加室內效果。不同類型的音樂理應採用不同類型的效果，因此請不要怕麻煩，略作一些嘗試。

📌 注意

- DSP效果不能用於96kHz/24位元音源或與環繞聲模式結合使用。
- 在DSP效果關閉的情況下播放立體聲音源時，環繞聲和中置揚聲器將不會發出聲音。

1 反復按 DSP，選擇聲音模式。

顯示屏顯示當前的DSP模式。

- **HALL 1**
大型木板牆音樂廳音場。
- **HALL 2**
大型石牆音樂廳音場。
- **JAZZ**
爵士樂俱樂部現場音場。
- **DANCE**
夜總會音場。
- **THEATER 1**
古典中型影院音場。
- **THEATER 2**
大型現代影院音場。
- **SIMUL . STEREO**
單聲道音源虛擬立體聲。



2 根據需要，調節音場效果音平。

- 從 Sound 選單選擇**EFFECT**，用 ▲ 和 ▼ 按鈕進行調節。按 **ENTER** 設定音平。

EFFECT 70

您可以在10至90的範圍內調節音場效果的音平，調節幅度為10。

Introduction

- Most of the functions covered in this chapter apply to DVD discs, Video CDs and CDs, although the exact operation of some varies slightly with the kind of disc loaded.
- When playing DVD discs, if the  or  icon appears on-screen when you try and use a particular function, either the player or the disc doesn't allow the use of that function.
- When playing Video CDs, some of the functions are not available in PBC mode. If you want to use them, start the disc playing using a number button to select a track.

Finding what you want on a disc

DVD

Video CD

CD

MP3

You can directly access any point on a disc using one of the search modes. Use these search modes while a disc is playing, or when it's stopped—playback immediately starts from the point specified.

1 Press SEARCH to choose between:

- Title search (DVD only)
- Chapter/Track search
- Time search (DVD and Video CD only)
- Folder search (MP3 only)
- Off

2 Enter the title/chapter/track number or time (minutes & seconds).



For example, for title 4, press **4**.

For chapter/track 12, press **1**, **2**.

For 45 minutes into the disc, press **4**, **5**, **0**, **0**.

3 Press ►/II to start/restart playback.

簡介

- 本章大多數功能適用於DVD，VCD和CD，但某些具體的操作方式根據裝入的碟片而略有差異。
- 播放DVD時，如果您嘗試某一項功能時，螢幕顯示  或  圖符，則說明播放機或碟片不能使用該功能。
- 播放VCD時，某些功能在PBC模式下不能使用。如果您要使用這些功能，請使用數字鈕選擇某一軌跡開始播放。

在碟片中尋找所需內容

DVD

Video CD

CD

MP3

您可以使用某搜索模式直接指定碟片中的某個位置，本機將立即從指定位置開始播放。當碟片正在播放或停止播放時均可使用這些搜索模式。

1 按 SEARCH 選擇下列選項：

- Title search 標題搜索（僅用於DVD）
- Chapter/Track search 章/軌跡搜索
- Time search 時間搜索（僅用於DVD和VCD）
- Folder search 搜索（MP3 only）
- Off 關閉

2 輸入標題/章/軌跡號碼或時間（分和秒）。

例如，對於標題 4，則按 **4**。

對於章/軌跡 12，則按 **1**, **2**。

對於碟片中的第45分鐘，則按 **4**, **5**, **0**, **0**。

3 按 ►/II 開始/重新開始播放。

■ Switching camera angles DVD

Some DVD discs feature scenes shot from two or more angles—check the disc box for details: it should be marked with a  icon if it contains multi-angle scenes.

- **To switch the camera angle, press ANGLE.**
If the disc was paused, playback starts again with the new angle.
 - To hide the TV angle indicator, choose **Angle Indicator > Off** from the **Video 2** menu (see page 72).

■ Switching subtitles DVD

Many DVD discs have subtitles in one or more languages—the disc box will usually tell you which subtitle languages are available. You can switch subtitle language anytime during playback.

- **To display/switch the subtitle language, press SUBTITLE repeatedly.**
- **To switch off subtitles, press SUBTITLE then CLR.**
 - To set subtitle preferences, see page 73.

■ Switching audio language DVD

When playing a DVD disc recorded with dialog in two or more languages, you can switch audio language anytime during playback.

- **To display/switch the audio language, press AUDIO repeatedly.**
 - To set audio language preferences, see page 72.

■ 轉換攝影角度 DVD

某些DVD碟片的場景具有兩個以上的攝影角度—詳情請參見碟片包裝說明：如果碟片含有多角度場景，應標有  圖符。

- **若要轉換攝影角度，請按 ANGLE。**
如果碟片暫停播放，則將以新的角度重新開始播放。
 - 若要隱藏電視角度指示燈，則從 **Video 2** 選單中選擇 **Angle Indicator > Off**（參見第72頁）。

■ 轉換字幕

許多DVD碟片含有一種或多種語言的字幕—影碟包裝上通常會說明含有哪些字幕語言。您可以在播放過程中的任何時候轉換字幕語言。

- **若要顯示/轉換字幕語言，請反復按 SUBTITLE。**
- **若要取消字幕，請按 SUBTITLE，然後按 CLR。**
 - 關於設置字幕參數的內容，請參見第73頁。

■ 轉換對白語言 DVD

當播放用兩種以上語言錄製的DVD影碟時，您可以在播放中的任何時候轉換對白語言。

- **若要顯示/轉換對白語言，請反復按 AUDIO。**
 - 關於設置對白語言參數的內容，請參見第72頁。

Switching audio channels

Video CD CD MP3

For karaoke or similar format CDs and Video CDs, it's possible to select stereo, left channel only, or right channel only.

To change the playback channel, press **AUDIO**.

Press repeatedly to switch between:

- **L CH** – Left channel only
- **R CH** – Right channel only
- **STEREO**

Making a program list

DVD Video CD CD

Making a program list means telling the player which titles/chapters/tracks you want played, and the order to play them in. You make a program list via an on-screen display, using the cursor buttons to navigate and the number buttons to enter titles/chapters/tracks.

DVD

- 1 Press **PROGRAM (SHIFT and 8)**.
- 2 Use the **◀** or **▶** button to select 'Program Chapter' or 'Program Title'.
- 3 Move the cursor down (**▼**) to the program list window.

If you selected **Program Chapter**, move the cursor up (**▲**) and enter a title number (all the programmed chapters will come from this title).

轉換聲道

Video CD CD MP3

對於卡拉OK或類似格式的CD和VCD，一般可以選擇立體聲、僅左聲道或僅右聲道。

- 若要改變播放聲道，請按 **AUDIO**。
- 反復按該鈕可在下列選項之間進行轉換：
- **L CH** – 僅左聲道
 - **R CH** – 僅右聲道
 - **STEREO**

製作編序列表

DVD Video CD CD

製作編序列表即指告訴播放機您所要播放的標題/章/軌跡及播放的順序。您可以在螢幕顯示狀態下製作編序列表，可以使用光標按鈕導向標題/章/軌跡，也可以使用數字鈕來輸入標題/章/軌跡。

DVD

- 1 按 **PROGRAM (SHIFT 及 8)**。
 - 2 用 **◀** 或 **▶** 按鈕選擇 "Program Chapter" 或 Program Title。
 - 3 將光標下移 (**▼**) 至編序列表視窗。
- 如果選擇 **Program Chapter**，則上移光標 (**▲**) 並輸入標題號碼 (所有編序章都在此標題下)。

4 Enter the title/chapter numbers for your program list.

For titles/chapters 1–10, use the corresponding number buttons. For 11 and over, use the >10 button (>10, 2, 4 for 24, etc.)

- A program list can contain up to 24 steps.

5 If you want to save the program list, move the cursor down (▼) to 'Program Memory' and set it to 'On'.

If you do this, the program list is automatically recalled when you next load the disc.

- You can save program lists for up to 24 discs.

6 Press ENTER or ►/II to start playback immediately, or PROGRAM to exit if you want to start playback later.**Note**

During program play, you may occasionally see the start of a chapter that was not programmed when the chapter number changes. This is not a malfunction.

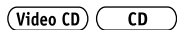

For Video CDs that feature PBC, make sure that the disc is stopped before you start.

1 Press PROGRAM (SHIFT and 8).**2 Enter the track numbers for your program list.**

For tracks 1–10, use the corresponding number buttons. For 11 and over, use the >10 button (>10, 2, 4 for 24, etc.)

- A program list can contain up to 24 steps.

4 輸入編序列表的標題/章號碼。

對於1–10的標題/章，可使用相應的數字按鈕。對於11以上的標題/章，則使用>10按鈕（輸入 24：>10, 2, 4，以此類推）。

- 一個編序列表最多可包含24級。

5 如果您要保存編序列表，則將光標下移 (▼) 至 “Program Memory”，然後設置為 “On”。
按此步驟操作後，下次裝入碟片時編序列表將自動調出。

- 您最多可以保存24張碟片的編序列表。

6 按 ENTER 或 ►/II 立即開始播放。如果想在以後播放，則按 PROGRAM 退出。**注意**

在編序播放過程中，當章號改變時，偶爾會看到某一未編序章的開始部份。這並非故障現象。



對於含有PBC功能的VCD，在開始編序前請確認碟片已停止播放。

1 按 PROGRAM (SHIFT 及 8)。**2 為編序列表輸入軌跡號碼。**

對於1–10的軌跡，可使用相應的數字按鈕輸入。對於11以上的軌跡，則使用>10按鈕（輸入24：>10, 2, 4，以此類推）。

- 編序列表最多可包含24級。

3 Press ENTER or ►/|| to start playback immediately, or PROGRAM to exit if you want to start playback later.

- You can't start playback later with a PBC Video CD; press ENTER or ►/|| to start.

■ Using random play

Use the random play function to play titles/chapters (on a DVD) or tracks (on a CD or Video CD) in a random order.

DVD

1 Press RANDOM (SHIFT and 6) repeatedly to select a random play mode.

The mode is displayed on-screen and in the front panel display:

- **Random Chapter** (from within the current title)
- **Random Title**

2 Press ENTER or ►/|| to start random play.

- To stop the disc and cancel random playback, press ■.
- To cancel random playback without stopping playback, press CLR. The rest of the disc plays out.

Video CD CD

1 Press RANDOM (SHIFT and 6) to start random play.

- To stop the disc and cancel random playback, press ■.
- To cancel random playback without stopping playback, press CLR. The rest of the disc plays out.



Tip

During random play, the ◀◀ and ▶▶ buttons function a little differently to normal: ◀◀ returns to the beginning of the current track/chapter. You can't go back further than this. ▶▶ selects another track/chapter at random from those remaining.

3 按 ENTER 或 ►/|| 立即開始播放。如果想在以後播放，則按 PROGRAM 退出。

- 對於含有PBC功能的VCD，則不能在以後播放；請按ENTER或 ►/|| 開始播放。

■ 使用隨機播放

使用隨機播放功能可以隨機順序播放標題/章 (DVD) 或軌跡 (CD或VCD)。

DVD

1 反復按 RANDOM (SHIFT 及 6) 選擇一種隨機播放模式。

模式顯示在螢幕及前面板的顯示屏上：

- **Random Chapter** 按章隨機播放 (在當前標題下)
- **Random Title** 按標題隨機播放

2 按 ENTER 或 ►/|| 開始隨機播放。

- 若要停止播放並取消隨機播放，請按 ■。
- 若要不停止播放的情況下取消隨機播放，請按CLR。本機將繼續播放碟片剩餘內容。

Video CD CD

1 按 RANDOM (SHIFT 及 6) 開始隨機播放。

- 若要停止播放並取消隨機播放，請按 ■。
- 若要不停止播放的情況下取消隨機播放，請按 CLR。本機將繼續播放碟片剩餘內容。



提示

在隨機播放中，◀◀ 和 ▶▶ 按鈕的功能與正常情況下略有區別：◀◀ 為返回當前軌跡/章的開始處。並且無法繼續後退。▶▶ 為以隨機方式在剩餘部份中選擇其他軌跡/章。

■ Using repeat play

You can set the player to repeat individual tracks on CDs or Video-CDs, chapters or titles on DVD discs, or the whole disc. It's also possible to loop a section of a disc.

You can use the repeat together with the programming mode to repeat the tracks/chapters in the program list (see page 43 for how to make a program list).

1 Press REPEAT (SHIFT and 4) during playback to select a repeat mode.

Each press switches the repeat mode:

DVD

- Repeat Chapter
- Repeat Title
- Repeat Off

Video CD

CD

- Repeat Track
- Repeat Disc
- Repeat off

2 To resume normal playback, press CLR.



Tip

You can use repeat play with program play. During program play, press REPEAT.

■ Looping a section of a disc

1 Press A-B (SHIFT and 5) once at the start of the section you want to repeat, then again at the end.

Playback immediately jumps back to the start point and plays the loop round and round.

- On a DVD disc, the start and end points of the loop must be in the same title.

2 To resume normal playback, press CLR.

- You can also repeat a section of a disc just once by pressing ►/|| to mark the end point (instead of A-B).

■ 使用重複播放

您可以設置播放機，使其重複播放CD或VCD中的某一軌跡、DVD中的某一章或標題或者重複播放整個碟片。也可重複播放碟片中的某一片段。

您可以將重複播放與編序模式配合使用，重複播放編序列表中的軌跡/章（關於製作編序列表的詳情請參見第43頁）。

1 在播放過程中按 REPEAT (SHIFT 及 4)，選擇一種重複模式。

每按一次該鈕，重複模式如下轉換：

DVD

- Repeat Chapter 按章重複播放
- Repeat Title 按標題重複播放
- Repeat Off 停止重複播放

Video CD

CD

- Repeat Track 按軌跡重複播放
- Repeat Disc 重複播放碟片
- Repeat off 停止重複播放

2 若要恢復正常播放，請按 CLR。



提示

您可以在編序播放時使用重複播放。在編序播放過程中，按 REPEAT。

■ 重複播放碟片中的某一片段

1 在需要重複播放片段的開始處按一次 A-B (SHIFT 及 5)，然後在結束處再按一次該鈕。

本機立即跳至開始處播放，並且反復播放這一片段。

- 在DVD碟片中，重複播放片段的開始和結束位置應位於同一標題下。

2 若要恢復正常播放，請按 CLR。

- 如果碟片的某一片段只需重複播放一次，則在其結束處按 ►/||（而不是 A-B）。

■ Bookmarking a place in a disc

DVD Video CD

If you watch only part of a DVD disc with the intention of picking up later where you left off, you can bookmark the place then resume playback at a later date without having to manually search for the right place.

You can use this feature for up to five discs (after that the oldest bookmark is deleted to make space for a new one).

- **At the point from which you want to resume playback next time, press LAST (SHIFT and 2).**

Press ■ if you want to stop playback here.

- **To resume playback, load the disc and press LAST (SHIFT and 2).**

If the disc starts auto playback, stop it first.

- To clear the bookmark for the disc loaded, press **LAST** then **CLR** while **'LAST_MEMORY'** is displayed on-screen.



Note

- Bookmarking also works with Video CDs, but for one disc only, and you must leave the disc in the player—opening the disc tray erases the memory. Last Memory may not work reliably with some PBC Video CDs.

■ Memorizing disc settings

DVD

If you have a particular set of preferences for a disc, you can memorize them using the Condition Memory function. Once memorized, your settings will be recalled automatically whenever you load that disc. The player can store settings for 15 discs; after this, memorizing

■ 在碟片某處製作書籤

DVD Video CD

如果您祇觀看了一部份DVD碟片，並準備日後從此次停止處繼續觀看，則可在該處製作一個書籤，以便日後繼續播放，而無需進行手動搜索。

您最多可為五張碟片製作書籤（此後最早的書籤將被刪除，讓位給新的書籤）。

- **當碟片播放到下次要繼續播放的位置時，按 LAST (SHIFT 及 2)。**

如果要在此處停止播放，則按 ■。

- **若要繼續上次的播放，請裝入碟片，然後按 LAST (SHIFT 及 2)。**

如果碟片自動開始播放，則先停止播放。

- 若要刪除裝入碟片的書籤，請按 **LAST**，然後在螢幕顯示“Last Memory”時按 **CLR**。



注意

- 書籤功能對VCD也有效，但祇能用於一張碟片，而且不能將該碟片取出本機—如果打開碟片托盤，記憶即被刪除。對於某些PCB VCD，Last Memory（最後記憶）功能的運作可能不可靠。

■ 記憶碟片設置

DVD

如果您為碟片設置了一系列特別參數，則可以使用Condition Memory（條件記憶）功能將它們記憶下來。記憶完成後，無論何時裝入該碟片，設置都會被自動調出。本機最多可保存15張碟片的設置，此後，新記憶的設置將會替換掉最早的設置。

another replaces the oldest one stored.

The settings memorized are:

- **OSD Position** (page 72)
 - **Subtitle Language** (page 73)
 - **Audio Language** (page 72)
 - **Angle Indicator** (page 72)
 - **Parental Lock level** (page 77)
- **To memorize settings for the current disc, press CONDITION (SHIFT and 1) during playback.**

- **To recall memorized settings, just load the disc.**

The display shows **COND_MEMORY** and ‘**Condition Memory**’ appears on-screen.

- To clear memorized settings, load the disc and press **CLR** while ‘**Condition Memory**’ is displayed on-screen.

■ Displaying disc information

DVD **Video CD** **CD**

Various track, chapter and title information, as well as the video transmission rate for DVD discs, can be displayed on-screen while a disc is playing, or while it's stopped.

You can find detailed explanations of all the displays on the following pages (depending on the disc, you may not see all the screens shown).

- **To show/switch the information displayed, press DVD DISP.**
 - When a disc is playing, the information appears at the top of the screen. Keep pressing **DVD DISP** to change the displayed information.
 - When a disc is stopped, all title/chapter, or track information for the disc loaded appears on-screen. Press **DVD DISP** again to exit the screen.

可記憶的設置有：

- **OSD Position** OSD語言（參見第72頁）
 - **Subtitle Language** 字幕語言（參見第73頁）
 - **Audio Language** 對白語言（參見第72頁）
 - **Angle Indicator** 角度指示符（參見第72頁）
 - **Parental Lock Level** 家長鎖定（參見第77頁）
- 若要記憶當前碟片的設置，請在播放過程中按 **CONDITION (SHIFT 及 1)**。
 - 若要調用已記憶的設置，祇需裝入碟片。顯示屏顯示 **COND_MEM**，螢幕上顯示“**Condition Memory**”。
 - 若要清除記憶的設置，請裝入碟片，當螢幕顯示“**Last Memory**”時按 **CLR**。

■ 顯示碟片資訊

DVD **Video CD** **CD**

當碟片播放或停止播放時，螢幕上會顯示軌跡、章和標題的資訊以及DVD的視頻傳輸率等資訊。

以下几頁將對所有顯示作詳細說明（根據碟片的情況，您可能無法看到所示的全部畫面）。

- 若要顯示/轉換資訊，請按 **DVD DISP**。
 - 當碟片播放時，資訊顯示在畫面頂部。按住 **DVD DISP** 可變更所顯示的資訊。
 - 當碟片停止時，其所有標題/章或軌跡的資訊都將顯示在螢幕上。再按一次 **DVD DISP** 可退出該畫面。

Displays when playing

DVD

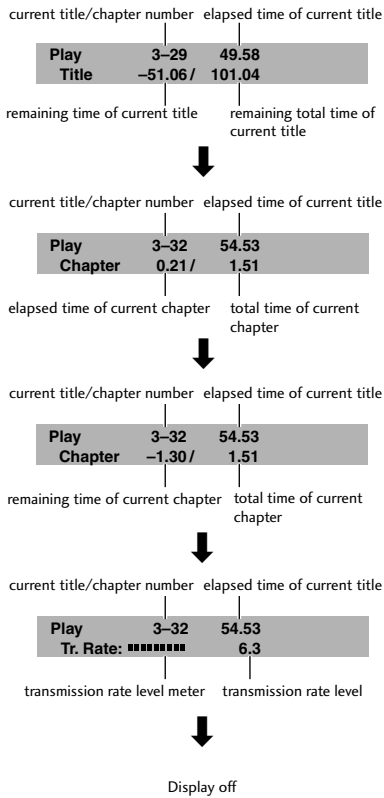

- To display the time remaining on a DVD disc, press and hold **DVD DISP**.

The display shows the disc time remaining for as long as you hold the button. Release the button to revert to the previous display.

播放中的顯示

DVD

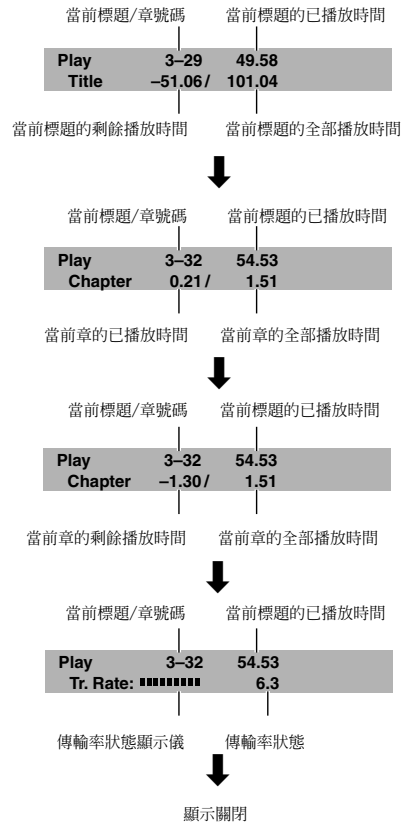

- 若要顯示DVD碟片的剩餘時間，請按住 **DVD DISP**。

在按住該鈕的狀態下，顯示屏顯示碟片剩餘時間。鬆開該按鈕將返回先前的顯示。

Video CD

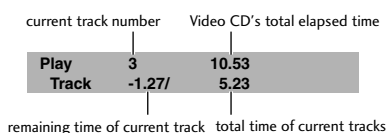
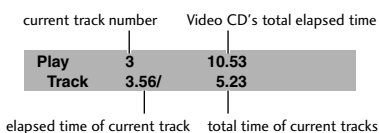
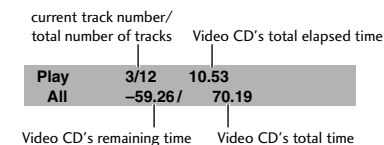

Display off

Video CD

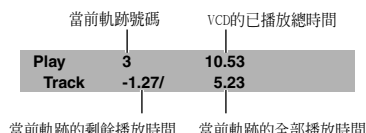
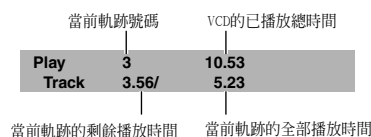
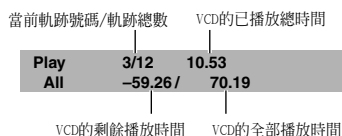

顯示關閉



Note

When playing a Video CD using PBC, the above displays do not appear (except for a **PLAY** indicator).



注意

當利用PBC功能播放VCD時，以上顯示不會出現（除**PLAY**指示燈以外）。

CD

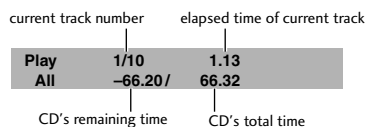
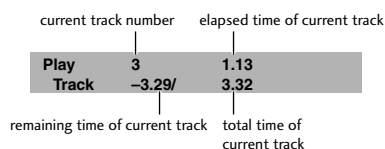

Display off

CD

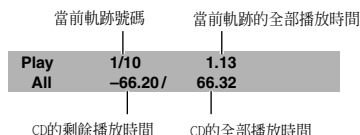
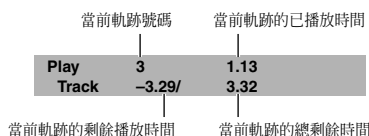

顯示關閉

Displays when stopped

DVD

Information: DVD			
Title	Chapter	Title	Chapter
01	1-1	06	1-1
02	1-1	07	1-1
03	1-1	08	1-1
04	1-1	09	1-4
05	1-1		

1/1 DISPLAY Exit

DVD-Video

Video CD CD

Information: Compact Disc		
Total Time	6.30	
Track	Time	
01	3.32	
02	2.58	

1/1 DISPLAY Exit

CD/Video CD

停止時的顯示

DVD

Information: DVD			
Title	Chapter	Title	Chapter
01	1-1	06	1-1
02	1-1	07	1-1
03	1-1	08	1-1
04	1-1	09	1-4
05	1-1		

1/1 DISPLAY Exit

DVD-Video

Video CD CD

Information: Compact Disc		
Total Time	6.30	
Track	Time	
01	3.32	
02	2.58	

1/1 DISPLAY Exit

CD/Video CD

DVD and CD system displays

DVD Video CD CD MP3

- Press **SYSTEM DISP** to change the information shown in the display.

Displays when playing

CD	1	0:24	Elapsed track time
	↓		
	4:12	am	Time

Displays when stopped

CD	CD mode
↓	
4:12 am	Time

DVD和CD系統顯示

DVD Video CD CD MP3

- 按 **SYSTEM DISP** 變更顯示屏上的資訊。

播放時的顯示

CD	1	0:24	軌跡已播放的時間
	↓		
	4:12	am	時間

停止時的顯示

CD	CD模式
↓	
4:12 am	時間

■ Playing MP3s

This system can play MP3 files on a CD-ROM disc. MP3 is a popular audio format on computers and the Internet. Even with file sizes one-tenth the size of CD audio, the sound quality remains reasonable.

1 Load the MP3 disc into the player.

- It may take upwards of 20 seconds for the system to read the contents of the disc.

2 Press ►/|| to start playing the first MP3 track on the disc.

It may take a few seconds for the system to locate the track on the disc, depending on the complexity of the file structure.

After the selected track has played out, the next track recorded on the disc starts playing.

- Press ►/|| while a track is playing to pause. Press again to restart playback.
- Press |◀◀/▶▶| to skip to the previous/next track on the disc.
- Press and hold ◀◀/▶▶ to scan backward/forward.
- Press ■ to stop playback. Except in program or random play, the system remembers the current folder as long as the disc remains in the player. Press ►/|| to restart playback from the first track of that folder.



Note

When playing Variable Bit Rate (VBR) encoded MP3 files, the track time information shown in the display may not be accurate.

■ 播放MP3

本系統可播放CD-ROM光碟上的MP3檔案。在電腦和互聯網上，MP3是廣受歡迎的音頻格式。其檔案大小僅為CD的十分之一，但仍保留較高的音質。

1 將MP3碟片裝入播放機。

- 本系統讀取碟片內容的時間最長為20秒鐘。

2 按 ►/|| 開始播放碟片上的第一首MP3曲目。

本系統可能要花費數秒鐘來尋找碟片上的曲目，所花時間因檔案結構的複雜程度而有所不同。

選定的曲目播放完畢後，記錄在碟片上的下一曲目即開始播放。

- 曲目正在播放時按►/||可暫停。再按一次可重新開始播放。
- 按|◀◀/▶▶|跳至前一/後一曲目。
- 按住◀◀/▶▶向後/向前掃描
- 按■停止播放。除編序或隨機播放的情況外，祇要碟片未取出，本系統就會記住當前檔案夾。按►/||從檔案夾的第一首曲目重新開始播放。



注意

當播放以可變位元傳輸速率（VBR）編碼的MP3檔案時，顯示屏上顯示的有關曲目時間的資訊可能不準確。

■ Searching for folders and tracks

- 1 Use the **FOLDER/GROUP (SHIFT and |◀◀/▶▶|)** buttons to select a folder.
The folder number is shown in the display.
- 2 Use the **number buttons or the |◀◀/▶▶| buttons** to select a track within the current folder.
For numbers 1-9, press the corresponding number button. For numbers 10-99, press **>10**, then enter the number. For numbers 100 and over, press **>10** twice, then enter the number.
For example, for track 46, press **>10, 4, 6**.
For track 120, press **>10, >10, 1, 2, 10/0**.
Playback jumps to the selected folder or track.
- 3 Press **▶/||** to start playback of the selected track.

■ Using random play

- Files can be mono or stereo. Use the random play feature to play tracks on a disc in a random order. Playback stops when all the tracks have played.
- 1 Press **RANDOM (SHIFT and 6)** to start random play.
 - 2 To cancel random play, press **■**.
Random play is also canceled if the disc tray is opened, you press **PROGRAM**, or you use the number buttons to jump to another track.

■ 搜索檔案夾和曲目

- 1 使用**FOLDER/GROUP (SHIFT和|◀◀/▶▶|)** 按鈕選擇檔案夾。
顯示屏顯示檔案夾號碼。
- 2 使用數字鈕或**|◀◀/▶▶|**按鈕在當前檔案夾內選擇曲目。
對於號碼1-9，按相應的數字鈕。對於號碼10-99，按**>10**，然後輸入號碼。對於100以上的號碼，按兩次**>10**，然後輸入號碼。
例如，對於曲目46，按**>10, 4, 6**。
對於曲目120，按**>10, >10, 1, 2, 10/0**。
系統將跳至所選檔案夾或曲目播放。
- 3 按**▶/||**開始播放所選曲目。

■ 使用隨機播放

- 檔案可以是單聲道，也可以是立體聲。使用隨機播放功能可以按隨機順序播放碟片中的曲目。當所有曲目播放完畢後播放即停止。
- 1 按**RANDOM (SHIFT和6)** 開始隨機播放。
 - 2 若要取消隨機播放，按**■**。
如果打開碟片托盤，按**PROGRAM**按鈕或者使用數字按跳至下一曲目，隨機播放就會被取消。

■ Using repeat play

Use the repeat play feature to repeat the current track, or all the tracks on the disc.

1 During playback, press REPEAT to select a repeat play mode.

Each press changes the repeat play mode:

- Repeat track (the **RPT-1** indicator lights)
- Repeat folder (the **RPT** indicator lights)
- Repeat disc (the **RPT** indicator lights)
- Repeat off

If you stop playback or open the disc tray, repeat play is also canceled.

■ Displaying MP3 information**• Press DVD DISP repeatedly during playback to display various MP3 information on-screen.**

There are four information screens:

```
PLAY 16/20 0:05
Track ONLY_YOU
```

- **Track name** (also shows track number and elapsed playback time)

```
PLAY 2/10 0:05
Folder ELVIS
```

- **Folder name** (also shows folder number and elapsed playback time)

```
PLAY 2-16 0:05
Track -2:25/ 2:30
```

- **Track remain / total time** (also shows folder number and elapsed playback time)

```
PLAY 2-16 0:05
Tr. Rate: 128kbps
```

- **Encoding bit-rate** (also shows folder number and elapsed playback time)

• Press DVD/DISP when the disc is stopped to display disc information.

Information: MP3			
Folder	Track	Folder	Track
001	1-9	001	1-10
002	1-11	002	1-13
003	1-3	003	1-5
004	1-22	004	1-4
005	1-15	005	1-8

1/2 ▶ DISPLAY Exit

MP3

■ 使用重複播放

使用重複播放功能可重複播放當前曲目或碟片上的所有曲目。

1 在播放中，按REPEAT選擇重複播放模式。

每按一次該按鈕，重複播放模式如下變更：

- Repeat track (**RPT-1**指示燈亮起)
- Repeat folder (**RPT**指示燈亮起)
- Repeat disc (**RPT**指示燈亮起)
- Repeat off

如果停止播放或打開碟片托盤，則重複播放被取消。

■ 顯示MP3資訊

- 在播放中反復按**SYSTEM DISP**，可使螢幕上顯示各種的MP3資訊。

螢幕上將顯示四種資訊：

```
PLAY 16/20 0:05
Track ONLY_YOU
```

- **曲目名稱**（同時顯示曲目號碼和已播放時間）

```
PLAY 2/10 0:05
Folder ELVIS
```

- **檔案夾名稱**（同時顯示檔案夾號碼和已播放時間）

```
PLAY 2-16 0:05
Track -2:25/ 2:30
```

- **曲目剩餘/全部播放時間**（同時顯示檔案夾號碼和已播放時間）

```
PLAY 2-16 0:05
Tr. Rate: 128kbps
```

- **編碼位元率**（同時顯示檔案夾號碼和已播放時間）

- 當碟片停止時按**DVD/DISP**，顯示碟片資訊。

Information: MP3			
Folder	Track	Folder	Track
001	1-9	001	1-10
002	1-11	002	1-13
003	1-3	003	1-5
004	1-22	004	1-4
005	1-15	005	1-8

1/2 ▶ DISPLAY Exit

MP3

■ Using the MP3 Navigator

Use the MP3 Navigator to make searching for the track (s) you want to play easier. You can also use it to add or clear tracks from the program list.

- 1 Load a CD-ROM containing MP3 tracks.
- 2 Press MENU to enter the MP3 Navigator screen.

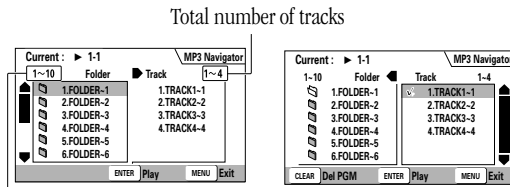

Total number of folders

The left side of the screen shows a list of folders containing MP3 tracks. On the right side is a list of MP3 tracks from the first folder in the list.

Navigate using the following controls:

▲/▼/◀/▶ – Select folders and tracks from the current screen.

ENTER – Play the currently selected folder or track. MP3 tracks that are unplayable on this player are automatically skipped and the display shows ‘UNPLAYABLE MP3 FORMAT’.

MENU – Exit the MP3 Navigator.

PROGRAM – Add the currently selected track to the program list. (Tracks in the program list are marked ✓P)

CLR – Clear the currently selected track from the program list.

■ 使用MP3嚮導

使用MP3嚮導可更方便地搜索要播放的曲目。該功能還可以用來在編序列表中增添或刪除曲目。

- 1 裝入含有MP3曲目的CD-ROM。
- 2 按MENU進入MP3嚮導畫面。

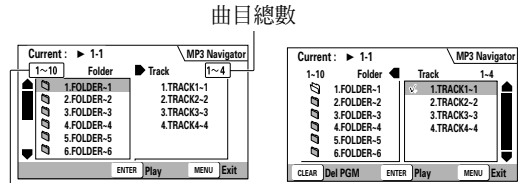

檔案夾總數

畫面左側顯示含有MP3曲目的檔案夾列表。右側是列表中第一個檔案夾內所含的MP3曲目。

使用下列控制按鈕進行嚮導：

▲/▼/◀/▶ – 從當前畫面中選擇檔案夾和曲目。

ENTER – 播放當前選定的檔案夾或曲目。本系統不能播放的MP3曲目將被自動跳過，同時顯示屏會顯示 “UNPLAYABLE MP3 FORMAT”

MENU – 退出MP3嚮導

PROGRAM – 將當前選定的曲目添加至編序列表。（加入編序列表的曲目標有✓P）

CLR – 從編序列表中清除當前選定的曲目。

■ Making a program list of MP3 tracks

- 1 Load a CD-ROM containing MP3 files.
- 2 Press **PROGRAM** to enter the Program MP3 screen.

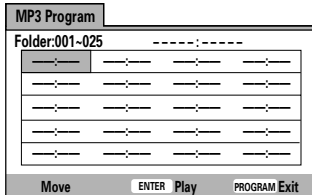

From this screen you can enter folder and track numbers directly to build up a program list.

3 Use the number buttons to enter a folder number.

See page 53 (step 2) for how to use the number buttons. The number of folders on the disc is displayed in the top-left of the screen.

Once you've entered a valid folder number, the title of the folder appears.

4 Use the number buttons to enter a track number.

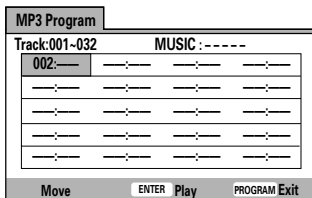

- See page 53 (step 2) for how to enter track numbers. The number of tracks in the current folder is displayed in the top-left of the screen.

Once you've entered a valid track number, the name of the track appears.

Navigate using the following controls:

▲/▼/◀/▶ – Navigate the program list.

CLR – Clear the currently selected item in the program list.

ENTER (or ▶/||) – Start playing the program list.

PROGRAM – Exit the Program MP3 screen.

■ 製作MP3曲目的編序列表

- 1 裝入含MP3檔案的CD-ROM。
- 2 按**PROGRAM**進入Program MP3畫面。

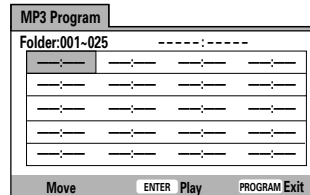

在上面的畫面中，您可以直接輸入檔案夾和曲目號碼以建立編序列表。

3 使用數字按鈕輸入檔案夾號碼。

使用數字按鈕的方法請參見第53頁（第2步）。碟片中檔案夾的號碼顯示於畫面的左上角。

祇要輸入有效的檔案夾號碼，檔案夾的標題就會顯示。

4 使用數字按鈕輸入三位數曲目號碼。

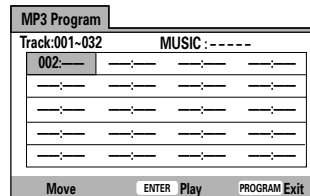

- 關於輸入軌跡號碼的方法，請參見第53頁（第2步）。

當前檔案夾的曲目號碼顯示在畫面的左上角。

祇要輸入有效的曲目號碼，曲目名稱就會顯示。

使用下列控制按鈕進行導向：

▲/▼/◀/▶ – 在編序列表中導向。

CLR – 從編序列表中清除當前選定的項目。

ENTER (或 ▶/||) – 開始播放編序列表。

PROGRAM – 退出Program MP3畫面。

■ MP3 compatibility information

- Mono or stereo MPEG-1 Audio Layer 3 format compatible.
- The CD-ROM must be ISO 9660 compatible.
- MP3 tracks on mixed CD audio/MP3 discs can't be played. Only the audio section is playable.
- This system is not compatible with multi-session discs. If you try to play a multi-session disc, only the first session will be played.
- This system can recognize a maximum of 250 folders and 250 tracks. Discs containing more than 250 folders or tracks will not play.
- Only the first 8 characters of folder and track names (excluding the ".mp3" extension) are displayed.
- This system only plays tracks that are named with the file extension ".mp3".
- This system plays MP3 tracks according to the order in which they were recorded.
- Audio encoded at 128Kbps should sound close to regular audio CD quality. Although this system will play lower bit-rate MP3 tracks, the sound quality becomes noticeably worse at lower bit-rates.
- MP3 tracks that are unplayable on this system are automatically skipped.

■ MP3相容資訊

- 與單聲道或立體聲MPEG-1音頻層3格式相容。
- CD-ROM必須相容於ISO9660。
- CD音頻/MP3的混合碟片上的MP3曲目無法播放。此類碟片祇能播放CD音頻部份。
- 本系統與多段碟片不相容。如果試圖播放此類碟片，則祇能播放第一段。
- 本系統最多可識別250個檔案夾和250個曲目。含有250個以上的檔案夾或曲目的碟片不能播放。
- 祇能顯示檔案夾和曲目名稱的開頭8個字符（“.mp3”擴展名除外）。
- 本系統祇能播放帶有檔案擴展名“.mp3”的曲目。
- 本系統根據錄製的順序播放MP3曲目。
- 以128Kbps方式編碼的曲目聽上去與普通CD音質相似。儘管本系統也可播放低位元率的MP3曲目，但音質明顯不佳。
- 本系統無法播放的MP3曲目將被自動跳過。

Using the wake up timer

You can use the timer as an alarm clock to wake up to the sound of a disc loaded, the radio, or the optional tape or MD deck. If you have an external component operated by a separate timer, you can also set the source function to that.

Once the timer is active, it will switch the system on everyday at the set time.

Unlike an ordinary alarm clock, you need to set a system switch off time as well as a switch on time.

Important

You can only use the timer features if the clock is set.

1 Select the source that you want to wake up to.

For a disc, press **DVD/CD**; for the radio press **TUNER FM/AM**. For another component, press the corresponding button.

2 Prepare the source.

Load a disc, tape, or MD, or tune to a radio station.

3 Press **CLOCK/TIMER** and select **WAKE-UP**.

WAKE - UP

- Press ◀ or ▶ to change the displayed option. Press **ENTER** to select it.

4 Select **TIMER EDIT**.

TIMER EDIT

- Change menu options using the ◀ and ▶ buttons. Press **ENTER** to select the currently displayed option.

5 Set the switch on time.

ON 9:30 am

Use ▲ and ▼ to set the hour then press **ENTER**. Set the minute in the same way, pressing **ENTER** to finish.

使用喚醒定時器

您可以將定時器當作鬧鐘來喚醒機內碟片，收音機或者選購的磁帶或MD卡座的聲音。如果本系統的外接設備帶有獨立的定時器，您也可以對其設置這種功能。

定時器啟動時，將在每天的設定時間打開本系統。與普通鬧鐘不同的是，你需要設置系統的關閉時間，方法如設置打開時間。

重要

僅在已設置時鐘的前提下方可使用定時器功能。

1 選擇需要喚醒的音源。

若選擇碟片，則按**DVD/CD**；若選擇收音機，則按**TUNER FM/AM**。對於其他設備，則按相應的按鈕。

2 準備音源。

裝入碟片，磁帶或MD，或者調諧至某一電台。

3 按**CLOCK/TIMER**選擇**WAKE-UP**。

WAKE - UP

- 按◀或▶變更顯示的選項。按**ENTER**選定。

4 選擇**TIMER EDIT**。

TIMER EDIT

- 用▲和▼按鈕變更選單的選項。按**ENTER**選定當前顯示的項目。

5 設置打開時間。

ON 9:30 am

用▲和▼設置小時，然後按**ENTER**。以同樣方法設置分鐘，按**ENTER**結束操作。

6 Set the switch off time.

OFF 10:30 am

Set in the same way as the switch on time, pressing **ENTER** to finish.

7 Check the settings you just made.

The display shows the timer settings:

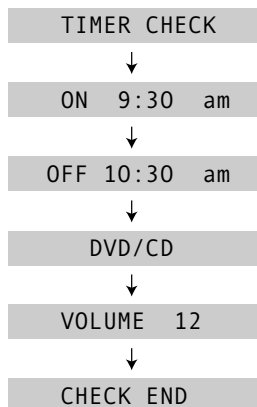
**8 Switch the system into standby.**

The timer will not work if the system is left on!

The standby light on the front panel lights green to indicate that the timer has been set.

■ Activating/deactivating the wake up timer

To activate the wake up timer, set the timer to **ON**. To deactivate it, set the timer to **OFF**.

1 Press CLOCK/TIMER and select WAKE-UP.

WAKE-UP

- Press ◀ or ▶ to change the displayed option. Press **ENTER** to select an option.

2 Select TIMER ON or TIMER OFF.

- Change menu options using the ◀ and ▶ buttons. Press **ENTER** to select the currently displayed option.

6 設置關閉時間。

OFF 10:30 am

與設置打開時間的方法相同，按**ENTER**結束操作。

7 檢查剛才完成的設置。

顯示屏將顯示定時器設置：

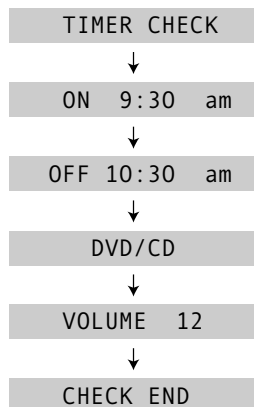
**8 將本系統轉換至待機狀態。**

如果本系統仍處於打開狀態，則定時器無法工作！前面板上的待機指示燈呈綠色亮起，表示定時器已設置。

■ 啟動/關閉喚醒定時器

若要啟動喚醒定時器，請將定時器設置為**ON**。若要關閉喚醒定時器，則應將其設置為**OFF**。

1 按CLOCK/TIMER 然後選擇WAKE-UP。

- 按◀和▶變更所顯示的選項。按**ENTER**選擇一個選項。

2 選擇TIMER ON或TIMER OFF。

- 用◀和▶按鈕變更選單的選項。按**ENTER**選擇當前顯示的項目。

■ Checking the timer settings

If you've set the wake-up timer, you can check the settings while the system is in standby.

1 With the system in standby, press **CLOCK/TIMER**.

The display shows the timer settings:

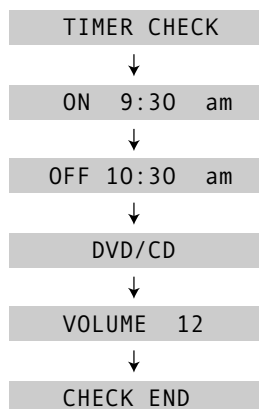

■ 檢查定時器設置

如果已設置喚醒定時器，您可以在本系統處於待機狀態時檢查該設置。

1 當本系統處於待機狀態時，按**CLOCK/TIMER**。

顯示屏顯示定時器設置：

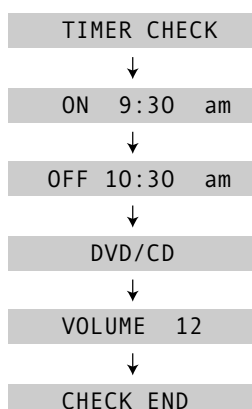

■ Using the sleep timer

The sleep timer switches the system into standby after a specified amount of time so that you can fall asleep without worrying about the stereo being left on all night. If you've also set the wake up timer this is important since the wake up timer will only work if the system is in standby.

1 Press **CLOCK/TIMER** and select **SLEEP TIMER**.

SLEEP TIMER

- Press ◀ or ▶ to change the displayed option. Press **ENTER** to select an option.

■ 使用睡眠定時器

睡眠定時器的功能是，使本系統經過一段指定的時間之後使其轉換為待機狀態，這樣您就可以安心睡覺，不必擔心音響系統會整夜處於打開狀態。如果您已設置了喚醒定時器，那麼設置睡眠定時器就更為重要了，因為喚醒定時器祇能在系統處於待機狀態時工作。

1 按**CLOCK/TIMER**，並選擇**SLEEP TIMER**。

SLEEP TIMER

- 按◀和▶變更所示選項。按**ENTER**進行選擇。

2 Use the ▲ or ▼ button to select a sleep timer setting.

- **SLEEP AUTO**

Switch off after the CD has played out *

- **SLEEP 90**

Switch off after 90 minutes

- **SLEEP 60**

Switch off after 60 minutes

- **SLEEP 30**

Switch off after 30 minutes

- **SLEEP OFF**

Cancels the sleep timer

The sleep timer indicator (☾) lights when the sleep timer is active.

* Not available when playing a DVD, or a Video CD in PBC mode, or if you're playing a CD, Video CD or MP3 disc in repeat mode. If you set a disc playing in repeat mode after setting the sleep timer to **SLEEP AUTO**, it automatically switches to the 90 minute setting.

- To cancel the sleep timer, switch the system into standby, or select **SLEEP OFF** (as described above).
- If you switch to a different source when **SLEEP AUTO** is set, the system will automatically go into standby a minute later.

2 用▲或▼按鈕選擇睡眠定時器設置。

- **SLEEP AUTO**

在CD播放完畢後關閉*

- **SLEEP 90**

90分鐘後關閉

- **SLEEP 60**

60分鐘後關閉

- **SLEEP 30**

30分鐘後關閉

- **SLEEP OFF**

取消睡眠定時器

當睡眠定時器啟動時，睡眠定時器指示燈 (☾) 亮起。

* 在PBC模式下播放DVD或VCD時，或在重複模式下播放CD、VCD或MP3碟片時，該功能無效。如果您將睡眠定時器設置為**SLEEP AUTO**後，又設置了以重複模式播放一張碟片，則睡眠定時器自動轉換為90分鐘設置。

- 若要取消睡眠定時器，請將本系統轉換為待機狀態，或選擇**SLEEP OFF**（如上所述）。
- 如果您在設置了**SLEEP AUTO**時轉換了音源，則本系統將在一分鐘後自動進入待機狀態。

Dynamic Range Control

The dynamic range of a source is the difference between the quietest and the loudest sounds. The dynamic range of Dolby Digital soundtracks can be very great. This makes them exciting, but it also means that when you turn the volume down you can easily lose quiet dialog. Switch on Dynamic Range Control to even out the soundtrack volume.

1 Press SYSTEM SETUP.

- Access this function together with the **SHIFT** button.

2 Press the ◀ or ▶ button until you see D.R.C. in the display.

3 Use the ▲ and ▼ buttons to select a dynamic range setting.

- **D.R.C. OFF** Default setting (no change to the dynamics)
- **D.R.C. LOW** Dynamic range is reduced by a small amount.
- **D.R.C. MEDIUM** Mid setting
- **D.R.C. HIGH** Dynamic range is reduced by a large amount (good for listening at very low volume).

4 Press ENTER to make the setting.

LFE Attenuator

Use the LFE (Low Frequency Effects) attenuator to reduce the subwoofer level if it is distorting.

1 Press SYSTEM SETUP.

- Access this function together with the **SHIFT** button.

2 Press the ◀ or ▶ button until you see LFE ATT in the display.

3 Use the ▲ and ▼ buttons to select a dynamic range setting.

- **LFE ATT 0** Default setting (no attenuation)
- **LFE ATT 10** The LFE channel is attenuated (reduced) by 10dB.
- **ATT OFF** The LFE channel is switched off.

4 Press ENTER to make the setting.

動態範圍控制

音源的動態範圍是指其最輕音至其最響音之間的範圍。杜比數碼電影原聲的動態範圍十分寬廣，因此音響效果非常激動人心，但是如此一來就會產生問題：若將音量調低，較輕的對白容易聽不清。打開動態範圍控制功能即可平衡電影原聲的音量。

1 按 SYSTEM SETUP。

- 同時按**SHIFT**按鈕啓用該功能。

2 按◀或▶按鈕，直到在顯示屏中看見D.R.C.。

3 用▲和▼按鈕選擇動態範圍設置。

- **D.R.C. OFF** 默認設置（不改變動態範圍）
- **D.R.C. LOW** 少量減小動態範圍
- **D.R.C. MEDIUM** 中等設置
- **D.R.C. HIGH** 大量減小動態範圍（低音量欣賞時較佳）

4 按ENTER設定。

LFE衰減器

如果副低音揚聲器失真，則利用LFE（Low Frequency Effects低頻效果）衰減器降低其音平。

1 按SYSTEM SETUP。

- 同時按**SHIFT**按鈕啓用該功能。

2 按◀或▶按鈕，直到在顯示屏中看見LFE ATT。

3 用▲和▼按鈕選擇衰減設置。

- **LFE ATT 0** 默認設置（無衰減）
- **LFE ATT 10** 聲道衰減（減弱）10dB
- **ATT OFF** 聲道關閉

4 按ENTER設定。

■ Dual-mono setting

The dual-mono setting applies only to Dolby Digital discs that feature dual-mono material—see the disc box for details.

Dual-mono discs are recorded with two independent channels that may be played together or separately depending on the situation. For example, a guitar tuition disc might have the guitar recorded on one channel and all the other instruments on the other. Use the dual-mono setting to play just the guitar part on its own; just the backing, or everything together (through separate speakers, or mixed).

1 Press SYSTEM SETUP.

- Access this function together with the **SHIFT** button.

2 Press the ◀ or ▶ button until you see one of the displays shown below.

3 Use the ▲ and ▼ buttons to change the dual-mono setting.

- **L-ch1 R-ch2**

default setting (the left channel is played through the left speaker; the right through the right)

- **ch1**

The left channel is played through the center speaker (or through the left and right speakers if **Surround Off** is selected); the right channel is muted.

- **ch2**

The right channel is played through the center speaker (or through the left and right speakers if **Surround Off** is selected); the left channel is muted.

- **MIX**

The left and right channels are mixed together and played through the center speaker (or through both left and right speakers if **Surround Off** is selected).

4 Press ENTER to make the setting.

■ 雙重單聲道設置

雙重單聲道設置僅適用於具雙重單聲道資料的杜比數碼碟片—詳情請參見碟片封套。

雙重單聲道碟片用兩條獨立的聲道錄製，根據情況，可同時播放，也可分開播放。例如，在一張吉他教程碟片中，可能是用一條聲道錄製吉他的聲音，另一條聲道錄製其他樂器的聲音。利用雙重單聲道設置可以單獨播放吉他部份；也可以祇播放背景音樂，或者二者一起播放（可用分立的揚聲器播放，也可混合播放）。

1 按SYSTEM SETUP。

- 同時按**SHIFT**按鈕啓用該功能。

2 按◀或▶按鈕，直到在顯示屏中顯示下列內容。

3 用▲和▼按鈕變更雙重單聲道設置。

- **L-ch1 R-ch2**

默認設置（左聲道通過左側揚聲器播放；右聲道通過右側揚聲器播放）。

- **ch1**

左聲道通過中置揚聲器播放（或者如果已選擇**Surround Off**，則通過左右揚聲器播放）；右聲道靜音。

- **ch2**

右聲道通過中置揚聲器播放（或者如果已選擇**Surround Off**，則通過左右揚聲器播放）；左聲道靜音。

- **MIX**

左右聲道通過中置揚聲器混合播放（或者如果已選擇**Surround Off**，則通過左右揚聲器播放）

4 按ENTER設定。

Adjusting channel volume levels

Depending on your room and where you're sitting, you may want to adjust the relative volumes of one or more speakers for a more balanced sound. You can do this in any mode, including the surround, DSP, and stereo modes.



Note

- Each DSP effect has its own set of channel level settings.
- The channel levels you set for the surround mode apply to all Advanced Theater effects.
- The headphone level is not affected by the channel level settings.

1 Press CH LEVEL.

Adjustments to the channel volume levels will affect only the current sound mode.

2 Use the ◀ and ▶ buttons to select a channel to adjust.

Lch 0dB

The display shows the channel and its current setting.

- Remember that not all channels are available in all sound modes.

3 Use the ▲ and ▼ buttons to adjust the volume of the current channel.

Lch 0dB



Lch + 3dB

For best results, sit in your main listening position when doing this. You can adjust each speaker in the range of +/-10dB.

4 When you're done, press ENTER.

- If you don't press **ENTER**, channel level setting is exited anyway after about 20 seconds.

調整聲道的音量級

您也許希望根據室內環境和聽音位置來調整一個或多個揚聲器的相對音量，以獲得更加平衡的聲音。您可以在任何模式下（包括環繞聲，DSP和立體聲模式）進行此項操作。



注意

- 各種DSP效果對聲道都有各自的音量級設置。
- 您為環繞聲模式設置的聲道音量適用於所有高級影院效果。
- 耳機的音量不受聲道音量級設置的影響。

1 按CH LEVEL。

對聲道音量進行的調整僅對當前的音聲模式有效。

2 用◀和▶按鈕選擇要調整的聲道。

Lch 0dB

顯示屏顯示該聲道及其當前設置。

- 請記住並非所有聲道在所有的音聲模式下均有效。

3 用▲和▼按鈕調整當前聲道的音量。

Lch 0dB



Lch + 3dB

為獲得最佳效果，作此調整時請坐在主聽音位置。您可以在+/-10dB的範圍之內調整各揚聲器。

4 操作完成後，按ENTER。

- 如果沒有按**ENTER**，則聲道音量級設置約在20秒鐘後退出。

■ Using the DVD Setup menu

The DVD Setup menu gives you access to all the system's DVD settings. Press **DVD SETUP** to display/leave the menu and the cursor (◀▲▼▶) and **ENTER** buttons on the remote to navigate and select options. In some screens you can press **RETURN** to leave the screen without making any changes. The controls for each menu are shown at the bottom of the screen.

If an option is grayed out it means that it cannot be changed at the current time. This is usually because a disc is playing. Stop the disc, then change the setting.

The current setting for any option is marked with a colored box. The color of the box indicates what kind of disc the setting is applicable to: blue for DVD only; green for any type of disc.



Note

- The language options shown in the on-screen display illustrations on the following pages may not correspond to those available in your country or region.

■ 使用DVD設置選單

DVD設置選單可讓您進行系統所有的DVD設置。按**DVD SETUP**顯示/退出該選單，按遙控器上的光標鈕(◀▲▼▶)和**ENTER**按鈕進行導向及選項的選擇。在某些畫面中，您可以按**RETURN**離開該畫面，不作任何變更。各選單的控制按鈕顯示在畫面底部。

如果某一選項呈灰色顯示，則說明該選項此時不能更改，通常是因為碟片正在播放。停止碟片的播放，然後再更改設置。

任何選項的當前設置都以帶顏色的方框標明。方框的顏色表明該設置對何種碟片有效：藍色表示僅對DVD有效，綠色表示對所有類型碟片都有效。



注意

- 後文所示的螢幕顯示畫面內的語言選項可能與您所在國家或地區的不符。

Audio settings

Dolby Digital Out

- Default: **Dolby Digital**

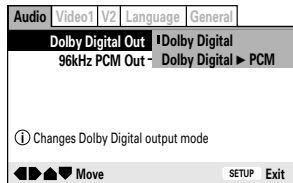

You only need to make this setting if you connected this system to another component (AV amplifier, etc.) using the optical digital out.

If your AV amplifier (or other connected component) is Dolby Digital compatible, set to **Dolby Digital**, otherwise set to **Dolby Digital ► PCM**.

96kHz PCM Out

- Default: **96kHz**

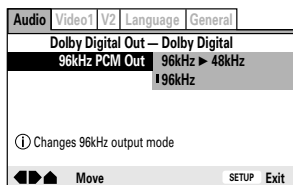

You only need to make this setting if you connected this system to another component (MD recorder, etc.) using the digital out.

If your AV amplifier (or other connected component) is 96kHz audio compatible, set to **96kHz**, otherwise set to **96kHz ► 48kHz**.

音頻設置

Dolby Digital Out (杜比數碼輸出)

- 默認設置：Dolby Digital

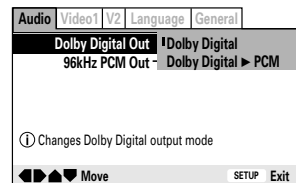

僅當本系統通過光籤數碼輸出端與其他設備（AV放大器等）相連時才需要進行此項設置。

如果所連接的AV放大器（或其他設備）與杜比數碼相容，則設置為**Dolby Digital**，否則設置為**Dolby Digital ► PCM**。

96kHz PCM Out (96kHz PCM 輸出)

- 默認設置：96kHz

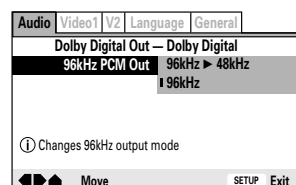

僅當本系統通過數碼輸出端與其他設備（MD錄音機等）相連時才需要進行此項設置。

如果所連接的AV放大器（或其他設備）與96kHz音頻相容，則設置為**96kHz**，否則設置為**96kHz ► 48kHz**。

Video settings

TV Screen

- Set in Setup Navigator (Default: **16:9 (Wide)**)

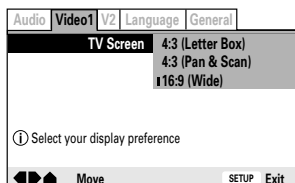

If you have a widescreen TV, select the **16:9 (Wide)** setting—widescreen DVD software is then shown using the full screen area. When playing software recorded in conventional (4:3) format, the settings on your TV will determine how the material is presented—see the manual that came with your TV for details on what options are available.

If you have a conventional TV, choose either **4:3 (Letter Box)** or **4:3 (Pan & Scan)**. In Letter Box mode, widescreen software is shown with black bars at the top and bottom of the screen. Pan & Scan chops the sides off widescreen material to make it fit the 4:3 screen (so even though the picture looks larger on the screen, you're actually seeing less of the movie). See page 95 for more information.

S-Video Out Expert

- Default setting: **S2**

You only need to make this setting if you connected this player to your TV using an S-Video cord.

If you find that the picture is stretched or distorted on the default **S2** setting, try changing it to **S1**.

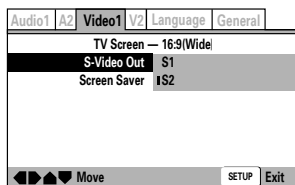

視頻設置

TV Screen (電視機螢幕)

- 在設置嚮導中進行設置 (默認設置：**16:9 (Wide)**)

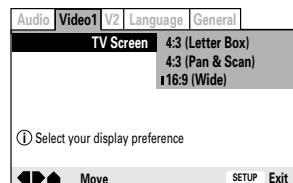

如果您的電視機是寬螢幕電視機，則選擇**16:9 (Wide)**設置—寬螢幕DVD軟體將以全螢幕方式顯示。當播放以傳統(4:3)格式錄製的軟體時，其顯示方式將取決於電視機的設置—關於相關的選項請參見電視機的使用說明書。

如果您的電視機為傳統型，則選擇**4:3 (Letter Box)**或**4:3 (Pan & Scan)**。在Letter Box模式下，顯示寬螢幕軟體時畫面頂部與底部會有一條黑色條紋。而Pan & Scan則將寬螢幕的兩邊截去，使其適合4:3的螢幕（因此畫管影像在螢幕中看上去較大，但實際上已不是完整畫面）。詳情請參見第96頁。

S-Video Out (S-Video輸出) Expert

- 默認設置：**S2**

僅當本機通過S-Video電纜與電視機相連時才需要進行此項設置。

如果發現選擇默認設置**S2**時影像有拉伸或變形現象，則將設置更改為**S1**。

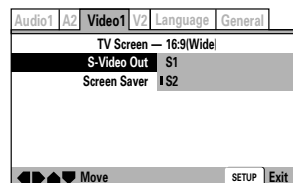

Screen Saver (Expert)

- Default setting: **On**

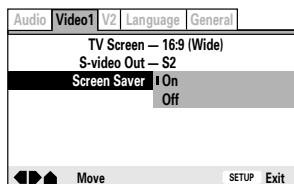

If a constant image is displayed on a conventional CRT-type TV, it can “burn in” leaving a ghost image on the screen. Switch **On** the screen saver to make sure that a constant image is not displayed for a dangerously long time.

Background

- Default setting: **Pioneer Logo**

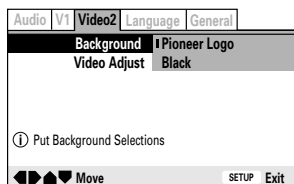

This specifies what the screen shows when the player is stopped.

Video Adjust



There are several preset picture quality settings that suit various program types. Alternatively, set up your own and save them in the player's memory.

Screen Saver (螢幕保護程式) (Expert)

- 默認設置： **On**

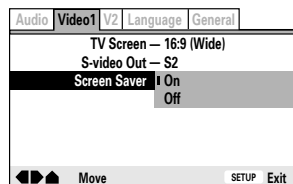

如果普通的CRT型電視機持久地顯示某個固定影像，螢幕可能會被“灼傷”，使其留下該影像的陰影。將screen saver (螢幕保護程式)設置為**On**，可確保固定影像的顯示時間不至於超出使螢幕受損的限度。

Background Color (背景)

- 默認設置： **Pioneer Logo**

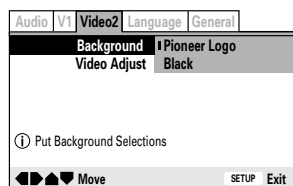

該設置決定本機停播時螢幕顯示的影像。

Video Adjust (視頻調整)

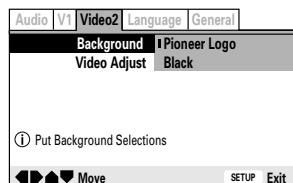

本系統備有若干種預設畫質設置，配合不同節目類型。您可以選擇性地進行設置，然後將其保存在本機的記憶體中。

■ Selecting a preset

- 1 Select 'Start'.
- 2 Select 'Video Memory Select'.
- 3 Select a preset.
 - **Standard** – Default setting; no effect added
 - **Cinema** – High contrast picture
 - **Animation** – Picture with rich color
 - **Memory 1, 2, 3** – User presets (see below for more on these)

You can highlight a preset while a disc is playing (before you press **ENTER** to select it) to see the effect on the picture immediately. Note that depending on the disc and your TV/monitor, the effect of these settings may not be clear.

■ Creating your own setting (1)

- 1 Select 'Start'.
- 2 Select 'Video Setup'

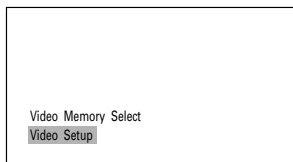

- 3 Use the ▲ and ▼ buttons to select a picture quality parameter, then use the ◀ and ▶ buttons to adjust that parameter.

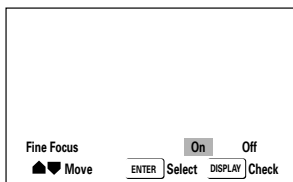

- **Fine Focus** – Switch on to reveal greater detail (higher resolution) in the picture.
- **Contrast** – Adjusts the contrast of the elements in the picture.

■ 選擇預設值

- 1 選擇 “ Start ”。
- 2 選擇 “ Video Memory Select ”。
- 3 選擇預設值。
 - **Standard** – 默認設置，無附加效果。
 - **Cinema** – 高對比度影像。
 - **Animation** – 更富色彩的影像。
 - **Memory 1, 2, 3** – 用戶預設值（詳情請參見下文）

您可以在碟片播放時預選某個預設值（選定後按 **ENTER**），以便即時觀看影像效果。請注意，根據碟片和電視機/監察器的情況，這些設置的效果有時可能不明顯。

■ 創建自己的設置(1)

- 1 選擇 “ Start ”。
- 2 選擇 “ Video Setup ”。

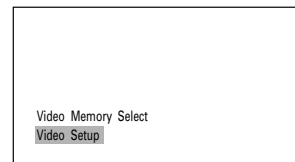

- 3 用▲和▼按鈕選擇一個畫質參數，然後用◀和▶按鈕調整該參數。

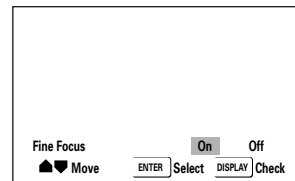

- **Fine Focus** – 打開該設置可加強影像的細節顯示（提高解析度）。
- **Contrast** – 調整影像的對比度。

- **Sharpness** – Adjusts the sharpness of the mid-frequency (less detailed) elements in the picture. (This setting is only effective when **Fine Focus** is **On**.)
- **Chroma Level** – Adjusts how saturated colours appear.
- **Hue** – Adjusts the overall colour balance between red and green.

4 Press **ENTER** to make the changes you've made effective.

■ Creating your own setting (2)

1 Select 'Start'.

2 Select 'Video Setup'

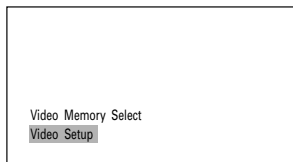

3 Press **DVD DISP**.

4 Use the **▲** and **▼** buttons to select a picture quality parameter, then use the **◀** and **▶** buttons to adjust that parameter.

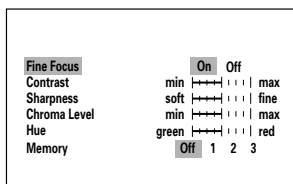

- The parameters you can adjust are the same as above.
- To save your changes in one of the user presets, highlight **Memory 1, 2 or 3** and press **ENTER**.

- **Sharpness**—調整影像中頻部份（顯示較弱）的清晰度。（該設置僅當**Fine Focus**設置為**On**時有效）。
- **Chroma Level**—調整顏色的飽合度。
- **Hue**—調整紅色和綠色之間的整體顏色平衡度。

4 按**ENTER**使您作出的變生效。

■ 創建自己的設置 (2)

1 選擇“Start”。

2 選擇“Video Setup”。

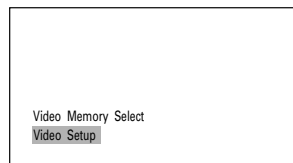

3 按 **DVD DISP**。

4 用**▲**和**▼**按鈕選擇某個畫質參數，然後用**◀**和**▶**按鈕調整該參數。

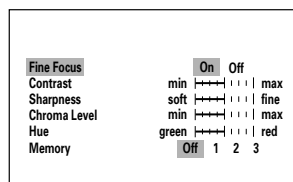

- 您可以調整的參數與前述相同。
- 若要將變更保存為用戶預設值，則選擇**Memory 1、2或3**，然後按**ENTER**。

Still Picture (Expert)

- Default setting: **Auto**

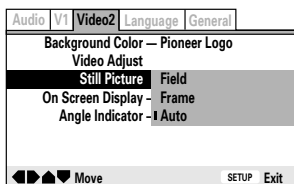

The player uses one of two processes when displaying a still frame from a DVD disc. The default Auto setting lets the system decide which to use.

Field – produces a stable, generally shake-free image.

Frame – produces a sharper image, but more prone to shake than field stills.

On Screen Display (Expert)

- Default setting: **Position – Normal**

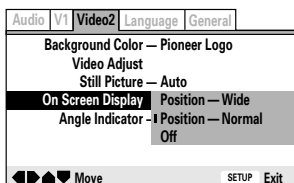

When watching DVD discs recorded in 4:3 format ('regular' TV size) on a widescreen TV, it can be difficult to see the operation displays (**Play, Stop, Resume**, etc.) at the top of the screen. If you find them hard to read, select **Position – Wide**.

If you prefer not to have the operation displays shown on-screen, change the setting to **Off**.

Still Picture (定格影像) (Expert)

- 默認設置： **Auto**

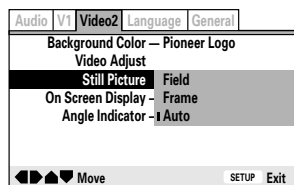

本機以下述兩種方式之一顯示DVD碟片的定格影像。默認的**Auto**設置將由本系統來決定顯示方式。

Field –產生穩定的、通常無抖動的影像。

Frame –產生更清晰的影像，但與上一個設置比較容易產生抖動。

On Screen Display (螢幕顯示) (Expert)

- 默認設置： **Position – Normal**

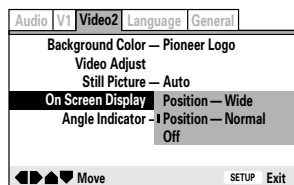

當用寬螢幕電視觀看以4:3格式（“普通”電視尺寸）錄製的DVD影碟時，難看清螢幕頂部的操作顯示（**Play**、**Stop**、**Resume**等）。如果出現這種情況，請選擇**Position - Wide**。

如果您不希望螢幕上具有操作顯示，則將該設置更改為**Off**。

Angle Indicator Expert

- Default setting: **On**

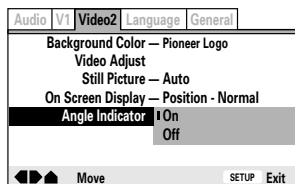

If you prefer not to see the camera icon on-screen during multi-angle scenes on DVD discs, change the Angle Indicator setting to **Off**.

Language settings

OSD language

- Set in Setup Navigator (default: **English**)



Choose the language you want the OSDs in.

Audio Language

- Default Setting: **English**



Angle Indicator (角度指示符) Expert

- 默認設置： **On**

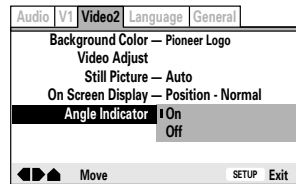

在播放DVD影碟的多角度場景時，如果您不希望在螢幕中看到攝影機圖符，請將**Angle Indicator**設置更改為**Off**。

語言設置

OSD language (OSD語言)

- 設置嚮導語言（默認設置：**English**）



選擇您所要的OSD語言。

Audio Language (對白語言)

- 默認設置：**English**



This setting is your preferred audio language for DVD discs. If the language you specify here is recorded on a disc, the system automatically plays the disc in that language (although this depends on the *Auto Language* setting—see *Auto Language* on page 74).

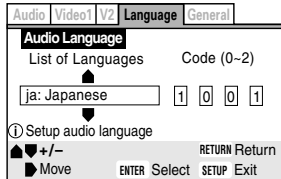

The DVD format recognizes 136 different languages. Choose **Other** if you want to specify a language other than those listed, then follow the on-screen display to select a language. You may also want to refer to the *Language code list* on page 89.



Remember

You can switch between the languages recorded on a DVD disc any time during playback using the **AUDIO** button. (This does not affect this setting.)

該設置用以選擇所需的DVD影碟對白語言。如果影碟中已錄有您在此所指定的語言，則本系統會自動以該語言播放影碟（但這取決於**Auto Language**設置—請參見第74頁**Auto Language**）。

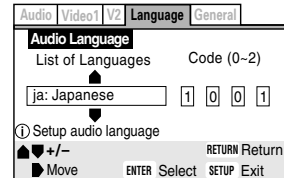

DVD格式可識別136種語言。如果您要指定的語言不存在於列表中，則選擇**Other**，然後遵照螢幕顯示選擇語言。您也可以參照第89頁的**語言代碼列表**進行操作。



須知

您在播放中的任何時候都可以用**AUDIO**按鈕轉換DVD影碟中錄製的語言。（此操作不影響上述設置。）

Subtitle Language

- Default Setting: **English**



This setting is your preferred subtitle language for DVD discs. If the language you specify here is recorded on a disc, the system automatically plays the disc with those subtitles (although this depends on the *Auto Language* setting—see *Auto Language* on page 74).

Subtitle Language (字幕語言)

- 默認設置：**English**

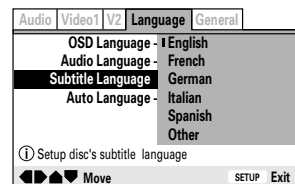

該設置可用以選擇所需的DVD字幕語言。如果影碟中已錄有您在此所指定的語言，則本系統會自動以該語言播放影碟（但這取決於**Auto Language**設置—請參見第74頁**Auto Language**）。

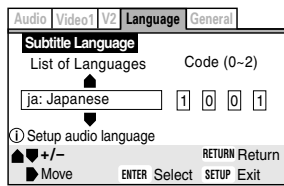

The DVD format recognizes 136 different languages. Choose **Other** if you want to specify a language other than those listed, then follow the on-screen display to select a language. You may also want to refer to the *Language code list* on page 89.

Remember

You can change or switch off the subtitles on a DVD disc any time during playback using the **SUBTITLE** button. (This does not affect this setting.)

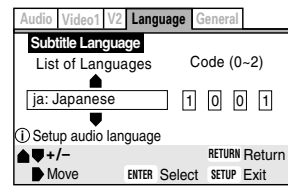

DVD格式可識別136種語言。如果您要指定的語言不存在於列表中，則選擇**Other**，然後遵照螢幕顯示選擇語言。您也可以參照第89頁的*語言代碼列表*進行操作。

須知

您在播放中的任何時候都可以用**SUBTITLE**按鈕來更改或取消DVD影碟的字幕。（此操作不影響上述設置。）

Auto Language

- Default Setting: **On**

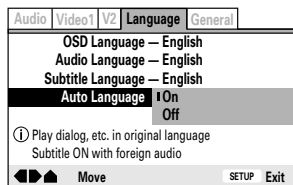

When set to **On**, the system always selects the default audio language on a DVD disc (French dialog for a French movie, for example), and displays subtitles in your preferred subtitle language only if that is set to something different. In other words, movies in your native language won't have any subtitles, while foreign language movies will be shown with subtitles.

Set to **Off** to have the system play discs strictly according to your *Audio Language* and *Subtitle Language* settings.

For Auto Language to work, the *Audio Language* and *Subtitle Language* settings must be the same—see pages 72–74.

Auto Language (自動語言)

- 默認設置：**On**

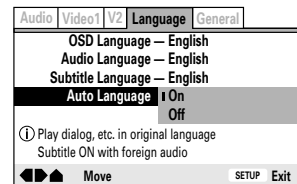

設置為**On**時，本系統將一直選擇DVD影碟中的默認對白語言（例如法國影片選用法語對白），並以您所選的字幕語言顯示字幕（僅當您設置了與默認對白不同的語言時）。換句話說，以您的母語錄製的影片不會顯示字幕，而以外國語言錄製的影片將顯示字幕。

設置為**Off**，本系統將嚴格根據**Audio Language**和**Subtitle Language**的設置播放影碟。

為使**Auto Language**有效，**Audio Language**和**Subtitle Language**的設置必須相同—請參見第72–74頁。

**Tip**

You can still switch audio and subtitle languages on playback using the **AUDIO** and **SUBTITLE** buttons.

DVD Language Expert

- Default Setting: w/Subtitle Language



Some multilingual discs have disc menus in several languages. This setting specifies in which language the disc menus should appear. Leave on the default setting for menus to appear in the same language as your *Subtitle Language*—see page 73.

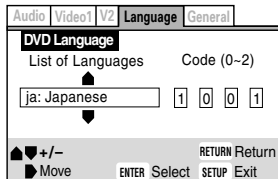

The DVD format recognizes 136 different languages. Choose **Other** if you want to specify a language other than those listed, then follow the on-screen display to select a language. You may also want to refer to the *Language code list* on page 89.

**提示**

您也仍可以在播放中用**AUDIO**和**SUBTITLE**按鈕轉換對白和字幕語言。

DVD Language (DVD語言) Expert

- 默認設置：w/Subtitle Language



某些多語種影碟的選單備有多種語言供選擇。利用該設置可指定影碟選單的語言。若保留默認設置，則選單語言與**Subtitle Language**所設置的語言相同—請參見第73頁。



DVD格式可識別136種語言。如果您要指定的語言不存在於列表中，則選擇**Other**，然後遵照螢幕顯示選擇語言。您也可以參照第89頁的**語言代碼列表**進行操作。

Subtitle Display Expert

- Default Setting: **On**

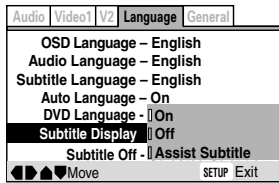

Set to **On**, the player displays subtitles according to the *Subtitle Language* and *Auto Language* settings above. Set to **Off** to switch subtitles off altogether (although see *Subtitle Off* on this page for special cases). Set to **Assist Subtitle** to have the player display the extra assistive subtitles recorded on to some DVD discs.

Subtitle Off Expert

- Default Setting: **Selected Subtitle**

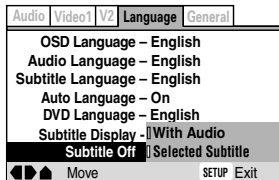

Some discs display subtitles even if the *Subtitle Display* setting (this page) is set to off. In this case, you can either have the subtitles displayed in the same language as your preferred audio language (**With Audio**), or in your preferred subtitle language (**Selected Subtitle**). If the *Audio Language* and *Subtitle Language* settings are the same then both of these choices will give the same result.

Subtitle Display (字幕顯示) Expert

- 默認設置：**On**

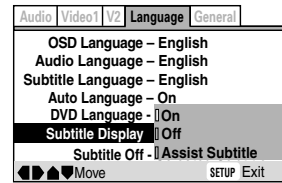

若設置為**On**，本機根據上述**Subtitle Language**和**Auto Language**的設置顯示字幕。若設置為**Off**，則取消字幕顯示（特殊情況請參見下頁的**Subtitle Off**）。若設置為**Assist Subtitle**，則本機會顯示某些DVD影碟上錄製的附加輔助字幕。

Subtitle Off (字幕關閉) Expert

- 默認設置：**Selected Subtitle**



即使**Subtitle Display**設置（上頁）為**Off**，某些影碟還是會顯示字幕。在這種情況下，您既可以將字幕設置為與指定的對白語言（**With Audio**）相同的語言，也可以設置為您已指定的字幕語言（**Selected Subtitle**）。如果**Audio Language**和**Subtitle Language**設置相同，則上述兩種設置的結果相同。

General settings

Setup Menu Mode

- Default setting: **Basic**

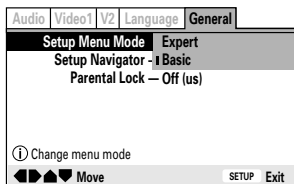

The **Basic** setup menu gives you access to the more commonly used settings. It also features an information bar which tells you more about what the currently highlighted option means.

Set to **Expert** for access to all settings.

Parental Lock

- Default level: **Off**
- Default password: *none*
- Default country code: **2119 us**

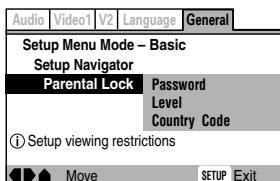

Some DVD Video discs feature a Parental Lock level. If your player is set to a lower level than the disc, it will require you to enter a password before the disc will play. This gives you some control about what your children watch on your DVD player.

Some discs also support the Country Code feature. The player does not play certain scenes on these discs, depending on the country code you set.

一般設置

Setup Menu Mode (設定選單模式)

- 默認設置：**Basic**

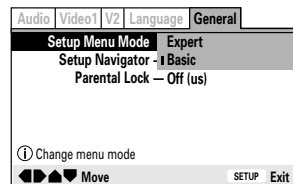

Basic設置選單可用以進行較常用的設置。同時畫面中還有一個資訊欄，向您詳細解釋當前高亮顯示的選項的含義。

若設置為**Expert**，則可進行所有設置。

Parental Lock (家長鎖定)

- 默認等級：**Off**
- 默認密碼：無
- 默認國家代碼：**2119 us**

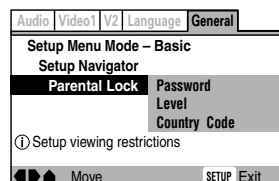

某些DVD影碟具有**Parental Lock**等級功能。如果將本機等級設置為低於影碟的等級，則在播放影碟之前需要輸入密碼。這樣可以對孩子觀看DVD的情況有所控制。

某些影碟還支持**Country Code**功能。根據您設定的國家代碼，本機將不播放影碟中的某些鏡頭。

Before you can set the Parental Lock level or the Country Code you must register a password. As the password owner, you can change the Parental Lock level or Country Code whenever you like. You can also change the password.



Note

Not all discs that you may consider inappropriate for your children are rated. Unrated discs will always play without requiring the password first.

■ Registering a new password

You must register a password before you can change the Parental Lock level or enter a Country Code.

1 Select 'Password'.

2 Use the number buttons to enter a 4-digit password.

It's also possible to use the cursor buttons to set the password (up and down to set the number; left and right to change the cursor position).

3 Press ENTER to register the password.

If you forget your password, you can reset the system then register a new one. See page 93 for how to reset the player.

■ Changing your password

To change your password, confirm your existing password then enter a new one.

1 Select 'Password Change'.

2 Use the number buttons to enter your existing password.

- The numbers appear as asterisks as you enter them.
- It's also possible to use the cursor buttons to set the password (up and down to set the number; left and right to change the cursor position).

3 Press ENTER.

4 Enter a new password.

5 Press ENTER.

在設置**Parental Lock**等級或**Country Code**之前，您必須先登錄密碼。作為密碼所有人，您可以隨時更改**Parental Lock**等級或**Country Code**。當然，您也可以更改密碼。



注意

並非所有您認為不適合兒童觀看的影碟都含有等級資訊。而播放未分等級的影碟則無需首先輸入密碼。

■ 登錄新密碼

更改**Parental Lock**等級或**Country Code**之前必須登錄密碼。

1 選擇“ Password ”。

2 用數字按鈕輸入4位數密碼。

也可利用光標按鈕設置密碼（向上和向下按鈕設置數碼，向左和向右按鈕更改游標位置）。

3 按ENTER登錄密碼。

如果忘記了密碼，可以使本系統復位，然後登錄新密碼。如何使本系統復位請參見第95頁。

■ 更改密碼

要更改密碼，首先確認現有的密碼，然後輸入新密碼。

1 選擇“ Password Change ”。

2 用數字按鈕輸入現有的密碼。

- 輸入的數字以星號顯示。
- 也可利用光標按鈕設置密碼（向上和向下按鈕設置數碼，向左和向右按鈕更改光標位置）。

3 按ENTER。

4 輸入新密碼。

5 按ENTER。

Setting/changing the Parental Lock level

- 1 Select 'Level'.
- 2 Use number buttons to enter your password, then press ENTER.
- 3 Select a new level.
Move leftward to lock more levels (more discs will require the password); rightward to unlock levels. You can't lock level 1.
- 4 Press ENTER to set the new level.



Tip

Use the Condition Memory feature (page 48) to save the Parental Lock level for individual discs.

Setting/changing the Country Code

You may also want to refer to the Country code list on page 85.

- 1 Select 'Country Code'.
- 2 Use number buttons to enter your password, then press ENTER.
- 3 Select a country code.
You can select the country code by letter or number.

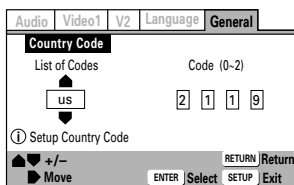

- 4 Press ENTER to set the new Country Code.

設置/更改Parental Lock等級

- 1 選擇“Level”。
- 2 用數字按鈕輸入密碼，然後按ENTER。
- 3 選擇新等級。
向左移動可鎖定更多的等級(需要輸入密碼的影碟也更多)；向右移動則可解除等級鎖定。不能鎖定等級1。
- 4 按ENTER設置新等級。



提示

利用Condition Memory功能(第47頁)可將各影碟的Parental Lock等級保存下來。

設置/更改Country Code

您可以參照第80頁上的國家代碼列表。

- 1 選擇“Country Code”。
- 2 用數字按鈕輸入密碼，然後按ENTER。
- 3 選擇國家代碼。
您可以用字母或數字按鈕選擇國家代碼。

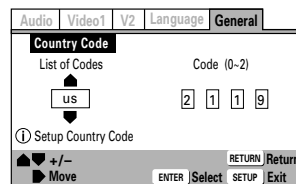

- 4 按ENTER設定新的國家代碼。

Country code list

Country	Input code	Country code
ARGENTINA	0118	ar
AUSTRALIA	0121	au
AUSTRIA	0120	at
BELGIUM	0205	be
BRAZIL	0218	br
CANADA	0301	ca
CHILE	0312	cl
CHINA	0314	cn
DENMARK	0411	dk
FINLAND	0609	fi
FRANCE	0618	fr
GERMANY	0405	de
HONG KONG	0811	hk
INDIA	0914	in
INDONESIA	0904	id
ITALY	0920	it
JAPAN	1016	jp
KOREA, REPUBLIC OF	1118	kr
MALAYSIA	1325	my
MEXICO	1324	mx
NETHERLANDS	1412	nl
NEW ZEALAND	1426	nz
NORWAY	1415	no
PAKISTAN	1611	pk
PHILIPPINES	1608	ph
PORTUGAL	1620	pt
RUSSIAN FEDERATION	1821	ru
SINGAPORE	1907	sg
SPAIN	0519	es
SWEDEN	1905	se
SWITZERLAND	0308	ch
TAIWAN, PROVINCE OF CHINA	2023	tw
THAILAND	2008	th
UNITED KINGDOM	0702	gb
UNITED STATES OF AMERICA	2119	us

國家代碼列表

國家	輸入代碼	國家代碼
阿根廷	0118	ar
澳大利亞	0121	au
奧地利	0120	at
比利時	0205	be
巴西	0218	br
加拿大	0301	ca
智利	0312	cl
中國	0314	cn
丹麥	0411	dk
芬蘭	0609	fi
法國	0618	fr
德國	0405	de
香港	0811	hk
印度	0914	in
印尼	0904	id
義大利	0920	it
日本	1016	jp
韓國	1118	kr
馬來西亞	1325	my
墨西哥	1324	mx
荷蘭	1412	nl
紐西蘭	1426	nz
挪威	1415	no
巴基斯坦	1611	pk
菲律賓	1608	ph
葡萄牙	1620	pt
俄羅斯	1821	ru
新加坡	1907	sg
西班牙	0519	es
瑞典	1905	se
瑞士	0308	ch
中國臺灣	2023	tw
泰國	2008	th
英國	0702	gb
美國	2119	us

**Important**

Before making or changing any rear panel connections, make sure that all the components are switched off and unplugged from the power supply.

**重要**

在進行或改變後面板連接之前，請確保所有設備均已關閉，並且插頭均已拔離電源。

■ Connecting other components

1 Use a stereo audio cable to connect the analog outputs of an external component to the AUDIO IN jacks of this unit.

This will allow you to play the component through this system.

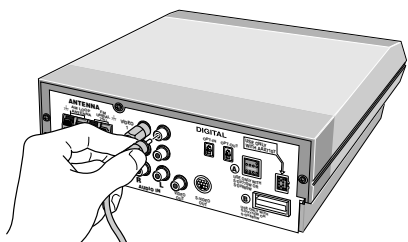

2 Use a digital optical cable to connect the optical digital output of an external component to the OPTICAL IN jack of this system.

This will allow you to play a digital audio component fitted with an optical digital output (MD player, etc.) through this system.

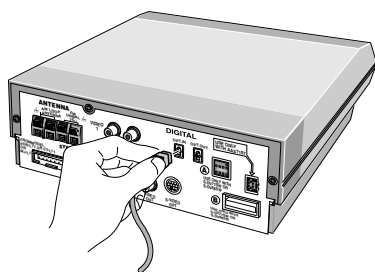

■ 連接其他設備

1 使用立體聲音頻電纜將外接設備的類比輸出插口與本機的AUDIO IN插口相連。

這樣您就可以通過本系統播放該設備。

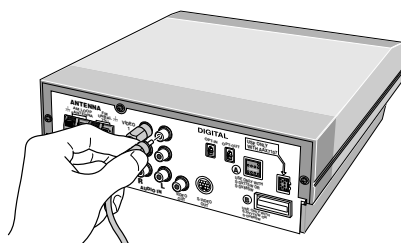

2 使用數碼光纜電纜將外接設備的光纖數碼輸出端與本系統的OPTICAL IN插口相連。

這樣您就可以通過本系統播放配備同軸數碼輸出的數碼音頻設備（MD播放機等）。

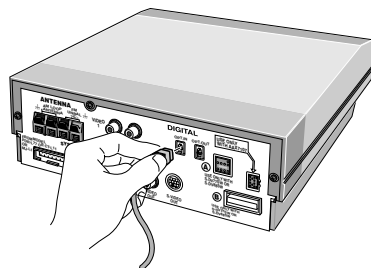

- 3 Use a digital optical cable to connect the OPT. OUT jack of this system to the optical digital input of an external component.

This will allow you to record from this system to an external digital recorder.

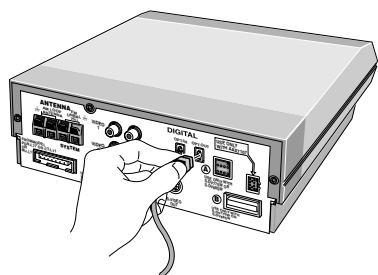

Note

The **OPTICAL IN** jack should only be connected to a PCM audio output (32kHz, 44.1kHz or 48kHz for the coaxial input; 32kHz, 44.1kHz, 48kHz or 96kHz for the optical input). These include CD, MD and DAT players and satellite receivers. Check the instructions that came with your other component for more details.

- 3 使用數碼光纜將本系統的OPT.OUT插口與外接設備的光纖數碼輸入端相連。這樣您就可以在外接數碼錄音機上錄製本系統的內容。

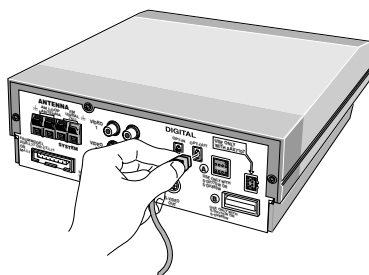

注意

OPTICAL IN插口祇能與PCM音頻輸出端相連（同軸輸入端為32kHz，44.1kHz或48kHz；光纖輸入端為32kHz，44.1kHz，48kHz或96kHz），所適用的設備包括CD，MD，DAT播放機和衛星接收器。詳情請查閱其他設備附帶的說明書。

■ Connecting external antennas

■ External AM antenna

Use 5–6 meters (15–18 ft.) of vinyl-insulated wire and set up either indoors (**B**) or outdoors (**A**). Leave the supplied AM loop antenna connected.

■ External FM antenna

Use 75Ω coaxial cable to hook up an external FM antenna (**C**).

■ 連接外接天線

■ 外接AM天線

用5–6米（15–18英尺）聚乙烯絕緣電線架設室內（**B**）或室外（**A**）天線。使附帶的AM環狀天線保持連接。

■ 外接FM天線

用75Ω同軸電纜連接外接FM天線（**C**）。

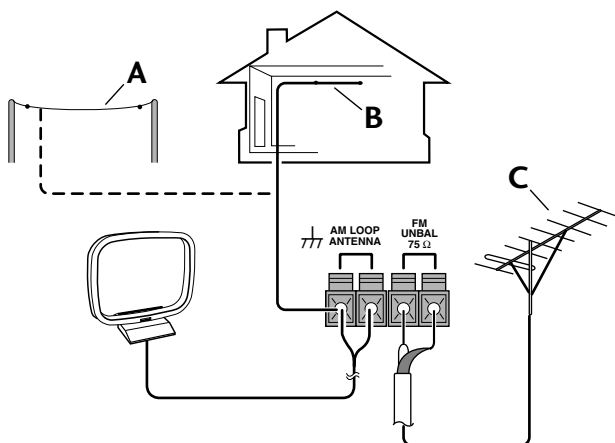

Child lock

When set to on, the remote control functions normally, but all front panel controls are inoperative.

- 1 **Switch the system into standby.**
- 2 **Press SYSTEM MENU and select CHILD LOCK.**
 - Change menu options using the ◀ and ▶ buttons. Press **ENTER** to select the currently displayed option.
- 3 **Use the ▲ or ▼ button to select LOCK ON or LOCK OFF as required, then press ENTER.**
The system returns to standby.

Beep mode

When set to on, the system beeps when you touch ▶/|| or ▲ OPEN/CLOSE on the front panel.

- 1 **Switch the system into standby.**
- 2 **Press SYSTEM MENU and select BEEP MODE.**
 - Change menu options using the ◀ and ▶ buttons. Press **ENTER** to select the currently displayed option.
- 3 **Use the ▲ or ▼ button to select BEEP ON or BEEP OFF as required.**
The system returns to standby.

Tuner frequency step

As its default setting, the tuner jumps in steps of 10kHz when tuning in AM stations. If you find that this is unsuitable in your area (if you can't tune into stations successfully), you can change the tuning interval to 9kHz for AM.

- 1 **Switch the system into standby.**
- 2 **Press SYSTEM MENU and select TUNER F. STEP.**
 - Change menu options using the ◀ and ▶ buttons. Press **ENTER** to select the currently displayed option.

兒童鎖定

該模式啟動時，遙控器可正常工作，但前面板上所有控制按鈕均不起作用。

- 1 將系統轉換至待機狀態。
- 2 按SYSTEM MENU，選擇CHILD LOCK。
 - 用◀和▶按鈕變更選單選項。按ENTER選擇當前顯示的項目。
- 3 用▲或▼按鈕根據需要選擇LOCK ON或LOCK OFF，然後按ENTER。
系統將返回待機狀態。

蜂鳴音模式

該模式啟動時，當您觸按前面板上的▶/||或▲OPEN/CLOSE時，系統將發出蜂鳴音。

- 1 將系統轉換至待機狀態。
- 2 按SYSTEM MENU，選擇BEEP MODE。
 - 用◀和▶按鈕變更選單選項。按ENTER選擇當前顯示的項目。
- 3 用▲或▼按鈕根據需要選擇BEEP ON或BEEP OFF。
系統將返回待機狀態。

調諧器頻率幅度

在默認設置下，進行AM電台調諧時，調諧器以10kHz的幅度跳躍。如果您發現上述調諧幅度不適合您所在地區（調諧電台不成功），則可將AM調諧間隔幅度更改為9kHz。

- 1 將系統轉換至待機狀態。
- 2 按SYSTEM MENU，選擇TUNER F.STEP。
 - 用◀和▶按鈕變更選單選項。按ENTER選擇當前顯示的項目。

3 Use the ▲ or ▼ button to select AM 9k/ FM 50k or AM 10k/FM100k as required.

The system returns to standby.

■ Dimming the display

- Press DIMMER to change the brightness of the display.

There are 5 levels of brightness.

■ Taking care of your system

To clean this unit, wipe with a soft, dry cloth. For stubborn dirt, wet a soft cloth with a mild detergent solution made by diluting one part detergent to 5 or 6 parts water, wring well, then wipe off the dirt. Use a dry cloth to wipe the surface dry. Do not use volatile liquids such as benzene and thinner which may damage the surfaces.

■ Disc lens cleaner

The disc pickup lens should not become dirty in normal use, but if for some reason it should malfunction due to dirt or dust, consult your nearest Pioneer authorized service center. Although lens cleaners for CD players are commercially available, we do not recommend using them since some may damage the lens.

■ Taking care of your discs

When holding discs, take care not to leave fingerprints, dirt or scratches on the disc surface. Hold the disc by its edge or by the center hole and edge. Damaged or dirty discs can affect playback performance. Take care also not to scratch the label side of the disc. Although not as

3 用▲或▼按鈕根據需要選擇AM 9k/FM 50k或AM 10k/FM 100k。

系統將返回待機狀態。

■ 調整顯示屏亮度

- 按DIMMER更改顯示屏的亮度。

共有5級亮度。

■ 系統保養

用乾燥柔軟的布清理本機。若遇頑垢，則用軟布蘸中性洗滌劑溶液（與水的比例為1比5或6），絞乾後擦拭污垢。然後用乾布將擦拭處擦乾。請勿使用汽油，稀釋劑等揮發性溶液擦拭，否則會使本機表面受損。

■ 碟片鏡頭清潔器

在一般使用狀態下碟片拾波鏡頭不會變髒，但倘若由於某種原因而被塵土污染，則會發生故障，請就近諮詢Pioneer特約服務中心。儘管市面上有供鐳射唱機使用的鏡頭清潔器，但我們不建議使用它，因為有些清潔器可能會使鏡頭受損。

■ 碟片保養

手持碟片時，請注意不要在碟片表面留下指紋，灰塵或划痕。應以如下方式手持碟片。搭住其邊緣部份或搭住中央孔和邊緣部份。碟片受損或變髒會影響其播放性能。同樣還應注意不要划傷碟片帶標籤的一面。儘管這一面沒有記錄面那樣容易受損，但若留下划痕同樣也會導致碟片無法使用。

fragile as the recorded side, scratches can still result in a disc becoming unusable.

Should a disc become marked with fingerprints, dust, etc., clean using a soft, dry cloth, wiping the disc lightly from the center to the outside edge as shown on the next page. If necessary, use a cloth soaked in alcohol, or a commercially available CD or DVD cleaning kit to clean a disc more thoroughly. Never use benzine, thinner or other cleaning agents, including products designed for cleaning vinyl records.

- Wipe lightly from the center of the disc using straight strokes.
- Don't wipe the disc surface using circular strokes.



Storing discs

Although CDs and DVDs are more durable than vinyl records, you should still take care to handle and store discs correctly. When you're not using a disc, return it to its case and store upright. Avoid leaving discs in excessively cold, humid, or hot environments (including under direct sunlight).

Don't glue paper or put stickers on discs, or write on them using a pencil, ball-point pen or other sharp-tipped writing instrument.

Discs to avoid

Discs spin at high speed during playback. If you can see that a disc is cracked, chipped, warped, or otherwise damaged, don't risk using it—you could end up damaging the system.

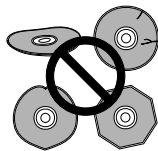

This system is designed for use with conventional, fully circular discs only. Use of shaped discs is not recommended. Pioneer disclaims all liability arising in connection with the use of shaped CDs and DVDs.

如果碟片留有指紋、灰塵等，請用軟乾布輕輕擦拭，擦拭時應如下所示從中央向外緣擦拭。若有必要，可用蘸有酒精的布，或用市售的CD或DVD清潔工具徹底清理碟片。切勿使用汽油、稀釋劑等清潔劑進行清理，包括乙烯樹脂唱片專用的清潔劑。

- 從碟片中央向外輕輕擦拭，擦拭軌跡盡量筆直。
- 從碟片中央向外輕輕擦拭，擦拭軌跡盡量筆直。



碟片保存

盡管CD和DVD比乙烯樹脂唱片更持久耐用，但仍需對其進行正確的處理和保存。在不使用碟片時，請將其放回盒內並豎直存放。請勿使碟片遭受極冷、極濕，極熱條件的影響（包括陽光直晒）。

請勿在碟片上粘貼紙張或貼紙，或用鉛筆，原子筆等尖頭書寫工具在其上書寫。

不能使用的碟片

碟片在播放時是處於高速旋轉狀態的。如果碟片出現開裂，碎裂，翹曲等損壞現象，請勿再冒險使用—否則可能會使系統受損。

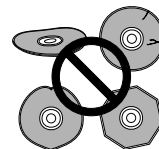

本系統僅適用於普通的圓形碟片。不建議使用異形碟片。對於因使用異形CD或DVD碟片而導致的後果，Pioneer概不負責。

■ Glossary

Aspect ratio

The width of a TV screen relative to its height. Conventional TVs are 4:3 (in other words, the screen is almost square); widescreen models are 16:9 (the screen is almost twice as wide as it is high).

Chapter

Just as a book is split up into several chapters, a title on a DVD disc is usually divided into chapters. See also Title.

Dolby Digital

A surround sound system developed by Dolby Laboratories containing up to six channels of digital audio (front left and right, surround left and right, center and low-frequency channels). See also DTS.

DTS

A surround sound system developed by Digital Theater Systems as an alternative to Dolby Digital. DTS discs contain up to eight channels of digital audio. See also Dolby Digital.

MPEG video

The video format used for Video CDs and DVDs. Video CD uses the older MPEG-1 standard, while DVD uses the newer and much better quality MPEG-2 standard.

PBC (PlayBack Control) (Video CD only)

A system of navigating a Video CD through on-screen menus recorded onto the disc. Especially good for discs that you would normally not watch from beginning to end all at once—karaoke discs, for example.

Regions (DVD only)

These associate discs and players with particular areas of the world. This unit will only play discs that have compatible region codes. You can find the region code of your unit by looking on the rear panel. Some discs are compatible with more than one region (or all regions).

Title (DVD only)

A collection of chapters on a DVD disc. See also Chapter.

■ 詞彙表

縱橫比

電視螢幕的寬度與其高度之比。普通電視機為4:3 (也就是說，螢幕幾近正方形)；寬螢幕電視機為16:9 (螢幕寬度差不多是高度的兩倍)。

章

正如一本書分為若干章一樣，DVD影碟中的標題通常也分為若干章。請參見“標題”。

Dolby Digital

由杜比實驗室開發的環繞聲系統，最多包含六條數碼音頻聲道（左前，右前，左環繞聲，右環繞聲，中央和低頻）。請參見“DTS”。

DTS

由數碼影院系統開發的環繞聲系統，類似杜比數碼系統。DTS影碟最多包含八條數碼音頻聲道。請參見“杜比數碼”。

MPEG video

該視頻格式應用於VCD和DVD。VCD使用較早的MPEG-1標準，而DVD採用較新的、質量更高的MPEG-2標準。

PBC（播放控制）（僅用於VCD）

一種通過VCD影碟中錄製的螢幕顯示的選單進行導向的系統。該系統尤其適於播放一般無需一次性從頭看到尾的影碟（如卡拉OK影碟等）。

Regions（地區）（僅用於DVD）

表示與影碟和播放機有關聯的世界地區。本機祇能播放具有相容地區代碼的影碟。您可以在本機的後面板上找到其地區代碼。某些影碟與多個地區（或者所有地區）相容。

Title（標題）（僅用於DVD）

DVD影碟中若干章的集合。請參見“章”。

Language code list

語言代碼列表

Language/語言	Code/編碼
Japanese (ja)	1001
English (en)	0514
French (fr)	0618
German (de)	0405
Italian (it)	0920
Spanish (es)	0519
Dutch (nl)	1412
Russian (ru)	1821
Chinese (zh)	2608
Korean (ko)	1115
Greek (el)	0512
Afar (aa)	0101
Abkhazian (ab)	0102
Afrikaans (af)	0106
Amharic (am)	0113
Arabic (ar)	0118
Assamese (as)	0119
Aymara (ay)	0125
Azerbaijani (az)	0126
Bashkir (ba)	0201
Byelorussian (be)	0205
Bulgarian (bg)	0207
Bihari (bh)	0208
Bislama (bi)	0209
Bengali (bn)	0214
Tibetan (bo)	0215
Breton (br)	0218
Catalan (ca)	0301
Corsican (co)	0315
Czech (cs)	0319
Welsh (cy)	0325
Danish (da)	0401
Bhutani (dz)	0426
Esperanto (eo)	0515
Estonian (et)	0520
Basque (eu)	0521
Persian (fa)	0601
Finnish (fi)	0609
Fiji (fj)	0610
Faroese (fo)	0615
Frisian (fy)	0625
Irish (ga)	0701
Scots-Gaelic (gd)	0704
Galician (gl)	0712
Guarani (gn)	0714
Gujarati (gu)	0721

Language/語言	Code/編碼
Hausa (ha)	0801
Hindi (hi)	0809
Croatian (hr)	0818
Hungarian (hu)	0821
Armenian (hy)	0825
Interlingua (ia)	0901
Interlingue (ie)	0905
Inupiak (ik)	0911
Indonesian (in)	0914
Icelandic (is)	0919
Hebrew (iw)	0923
Yiddish (ji)	1009
Javanese (jw)	1023
Georgian (ka)	1101
Kazakh (kk)	1111
Greenlandic (kl)	1112
Cambodian (km)	1113
Kannada (kn)	1114
Kashmiri (ks)	1119
Kurdish (ku)	1121
Kirghiz (ky)	1125
Latin (la)	1201
Lingala (ln)	1214
Laothian (lo)	1215
Lithuanian (lt)	1220
Latvian (lv)	1222
Malagasy (mg)	1307
Maori (mi)	1309
Macedonian (mk)	1311
Malayalam (ml)	1312
Mongolian (mn)	1314
Moldavian (mo)	1315
Marathi (mr)	1318
Malay (ms)	1319
Maltese (mt)	1320
Burmese (my)	1325
Nauru (na)	1401
Nepali (ne)	1405
Norwegian (no)	1415
Occitan (oc)	1503
Oromo (om)	1513
Oriya (or)	1518
Panjabi (pa)	1601
Polish (pl)	1612
Pashto, Pushto (ps)	1619
Portuguese (pt)	1620

Language/語言	Code/編碼
Quechua (qu)	1721
Rhaeto-Romance (rm)	1813
Kirundi (rn)	1814
Romanian (ro)	1815
Kinyarwanda (rw)	1823
Sanskrit (sa)	1901
Sindhi (sd)	1904
Sangho (sg)	1907
Serbo-Croatian (sh)	1908
Singhalese (si)	1909
Slovak (sk)	1911
Slovenian (sl)	1912
Samoan (sm)	1913
Shona (sn)	1914
Somali (so)	1915
Albanian (sq)	1917
Serbian (sr)	1918
Siswati (ss)	1919
Sesotho (st)	1920
Sundanese (su)	1921
Swedish (sv)	1922
Swahili (sw)	1923
Tamil (ta)	2001
Telugu (te)	2005
Tajik (tg)	2007
Thai (th)	2008
Tigrinya (ti)	2009
Turkmen (tk)	2011
Tagalog (tl)	2012
Setswana (tn)	2014
Tonga (to)	2015
Turkish (tr)	2018
Tsonga (ts)	2019
Tatar (tt)	2020
Twi (tw)	2023
Ukrainian (uk)	2111
Urdu (ur)	2118
Uzbek (uz)	2126
Vietnamese (vi)	2209
Volapük (vo)	2215
Wolof (wo)	2315
Xhosa (xh)	2408
Yoruba (yo)	2515
Zulu (zu)	2621







Screen sizes and disc formats

The table below shows the effect of various TV Screen settings on the different kinds of disc available.





螢幕尺寸和碟片格式

下表顯示了在不同電視螢幕設置下播放不同類型碟片的效果。

When viewing on a standard TV or monitor 在標準電視機或監察器上觀看

碟片的螢幕格式 Screen format of disc	設置 Setting	Appearance	效果
16:9 	4:3 (Letter Box) 	The program is shown in widescreen with black bars at the top and bottom of the screen.	影片以寬螢幕顯示，頂部和底部具有黑色條紋。
	4:3 (Pan & Scan) 	The sides of the program are cropped so that the picture fills the whole screen.	影片的兩邊被削去，影像充滿整個螢幕。
4:3 	16:9 (Wide) 	The program appears squashed. Set to either 4:3 (Letter Box) or 4:3 (Pan & Scan) .	影片看上去有受擠壓的感覺。可設置為 4:3 (Letter Box) 或 4:3 (Pan & Scan) 。
	4:3 (Letter Box) 4:3 (Pan & Scan) 	The program is presented correctly on either setting.	在兩種設置下影片都正確顯示。

When viewing on a widescreen TV or monitor 在寬螢幕電視機或監察器上觀看

碟片的螢幕格式 Screen format of disc	設置 Setting	Appearance	效果
16:9 	16:9 (Wide) 	The program is presented in widescreen.	影片以寬螢幕顯示。
4:3 	16:9 (Wide) 	The program is shown in widescreen with black bars at the either side of the screen.	所顯示影片畫面的兩側有黑色條紋。
	16:9 (Wide) 	The program appears stretched. Your TV will determine how the picture is presented—check the manual that came with the TV for details.	影片看上去有拉伸的現象。畫面的呈現效果取決於電視機的類型—詳情請參見電視機的使用說明書。

■ Troubleshooting

Incorrect operation is often mistaken for trouble or malfunction. If you think that there is something wrong with this component, check the points below. Sometimes the trouble may lie in another component. Inspect the other components and electrical appliances being used. If the trouble cannot be rectified after checking the items below, ask your nearest Pioneer authorized service center or your dealer to carry out repair work.

■ Amplifier fault finding

If there is an internal fault in the amplifier, the power is automatically shut off without the display showing the usual “**Goodbye**” message. The standby indicator blinks and none of the controls work, including the power button.

Please contact your nearest Pioneer Service Center.

■ Fan fault finding

If there is a fault with the fan, the display shows **FAN ERROR** then the power is automatically shut off. If when you switch the unit back on, everything works normally then you can continue to use it. If the error persists, please contact your nearest Pioneer service Center.

■ DVD fault finding

If there is an internal fault in the DVD player, the display shows **DVD 3.3 ERROR** then the power is automatically shut off. If, when you switch the unit back on, everything works normally then you can continue to use it. If the error persists, please contact your nearest Pioneer Service Center.

■ 故障排除

不正確的操作往往被誤認為是故障或失靈。如果您認為本機存在問題，請檢查下列幾點。有時可能是其他設備存在故障。請檢查其他正在使用的設備和電器。如果檢查完下列幾項之後仍無法排除故障，則就近聯繫**Pioneer**特約服務中心或經銷商進行報修。

■ 放大器故障的判斷

如果放大器存在內部故障，電源將自動關閉，而顯示屏不會顯示通常的“**Goodbye**”訊息。此時待機指示燈閃爍，控制按鈕（包括電源按鈕在內）全部失效。

請就近聯繫**Pioneer**服務中心。



■ 風扇故障判斷：

如果風扇出現故障，顯示屏會顯示**FAN ERROR**，隨後電源將自動關閉。如果您重新打開機器後所有運作都正常，則可繼續使用。如果故障仍然存在，則請聯絡您就近的先鋒維修中心。

■ DVD故障的判斷

如果DVD播放機存在內部故障，則顯示屏顯示**DVD 3.3 ERROR**，然後電源會自動關閉。當您重新打開本機時，如果一切正常，則可繼續使用本機。如果故障依然存在，則請就近聯繫**Pioneer**服務中心。

■ Troubleshooting tips

Problem	Remedy
CDs, DVDs and Video CDs	
The disc is ejected automatically after loading.	<ul style="list-style-type: none"> • Check that the disc is clean and undamaged (page 92). • Make sure that the disc is seated properly in the disc guide. • Check that the disc has a compatible region number (page 12). • There may be condensation inside the unit. Allow time for condensation to evaporate. Avoid using the player near an air-conditioning unit.
Playback is not possible.	<ul style="list-style-type: none"> • Check that the disc is loaded correctly (label side face up).
 mark appears on screen.	<ul style="list-style-type: none"> • The operation is prohibited by the system.
 mark appears on screen.	<ul style="list-style-type: none"> • The selected function does not operate for that disc.
When making changes in the Setup OSD menus,  is displayed.	<ul style="list-style-type: none"> • There is a CD or Video CD loaded and the setting that was changed applies only to DVD discs. The settings will take effect next time a DVD is loaded.
Picture playback stops and the operation buttons cannot be used.	<ul style="list-style-type: none"> • Switch the power off once, then on again using the front panel standby/on switch.
New settings made in the Setup screen menus while a disc is playing are ineffective.	<ul style="list-style-type: none"> • Some settings can be changed while a disc is playing, but are not effective until the disc is stopped then restarted. This is not a malfunction. Note that making settings in the Setup screen menus may cancel the resume function.
Settings are canceled.	<ul style="list-style-type: none"> • If the power was cut due to power failure or by unplugging the power cord, settings will be canceled.
No picture/No color.	<ul style="list-style-type: none"> • Check that the video connections are correct and that plugs are inserted fully. • Check that the TV/monitor settings are correct.
Screen is stretched or aspect does not change.	<ul style="list-style-type: none"> • Make sure that the TV Screen option in the Setup menu matches the TV/monitor you're using.
Picture disturbance during playback or screen is dark.	<ul style="list-style-type: none"> • This player is compatible with Macro-Vision System copy guard. Some discs include a copy prevention signal, and when this type of disc is played back, stripes etc., may appear on some sections of the picture depending on the TV. This is not a malfunction. • Problems with some discs may result in the screen becoming black for a brief instant or shaking slightly when certain functions are executed. • Due to copy protection, connection of this system through a VCR or an AV selector may prevent recording or cause picture problems. This is not a malfunction.
Noticeable difference in DVD and CD volume.	<ul style="list-style-type: none"> • DVDs and CDs use different recording methods. This is not a malfunction.

Problem	Remedy
---------	--------

Tuner	
-------	--

- | | |
|---|---|
| <p>Noisy radio reception</p> | <ul style="list-style-type: none"> • Check that the frequency is correct. • Check that the antennas are connected properly. For FM, make sure that the antenna is fully extended and positioned to give the best reception. For AM, make sure that the loop antenna is pointing in the best direction. • If the radio signal is weak, an outdoor antenna will usually give better results than the supplied indoor types. • Other electrical equipment, such as TVs, fluorescent lamps and motors can cause interference. Try switching off or moving the equipment, or moving the antenna(s). • The tuning interval may be incorrect for your country or region. Try switching the tuning interval (page 90). |
| <p>Auto tuning does not pick up some stations.</p> | <ul style="list-style-type: none"> • Auto tuning will only detect radio stations with a good signal. For more sensitive tuning, connect an outdoor antenna. |

MP3 playback	
--------------	--

- | | |
|---|---|
| <p>The disc containing the MP3 tracks won't play.</p> | <ul style="list-style-type: none"> • If the disc is a recordable CD, make sure that the disc is finalized. • Check that the disc is ISO 9660 compatible. |
| <p>The message UNPLAYABLE MP3 FORMAT appears when you try to start playback.</p> | <ul style="list-style-type: none"> • Check that the track(s) are in the MPEG1 Audio Layer 3 format. • Check that the sampling rate of the track(s) are 44.1 or 48kHz. |
| <p>Some tracks seem to be missing from the disc.</p> | <ul style="list-style-type: none"> • If a track name does not end in ".mp3" or ".MP3", this system will not recognize it as an MP3 track. • This system only recognizes the first 250 folders and tracks on a disc. If there are more folders/tracks than this, you will not be able to play them. • This system is not compatible with multi-session discs. If the disc is multi-session, you will only be able to play tracks recorded onto the first session. |

General	
---------	--

- | | |
|--|--|
| <p>The remote control doesn't seem to work.</p> | <ul style="list-style-type: none"> • Make sure that you're using the remote within its operating range and that there are no obstacles between the remote and the sensor on the main unit. • Check that the batteries are not exhausted. |
| <p>No audio, or audio is distorted.</p> | <ul style="list-style-type: none"> • Check that the correct function is selected (DVD/CD, etc.), the volume turned up. • Check that the MUTE function is not on and that the disc is not paused. • Check that the disc is clean and undamaged (page 92) • Check that all rear panel connections are correct. • If you find dirty or oxidized plugs/terminals, clean them. |



Note

Static electricity or other external influences may cause malfunctioning of this unit. In this case, unplug the power cord and then plug back in. This will usually reset the unit for proper operation. If this does not correct the problem, please consult your nearest Pioneer service center.

Resetting the system

Resetting the system returns all menu, picture and password settings to their factory defaults.

- 1 Switch the system into standby using the front panel standby/on switch.**
- 2 Hold down the front panel  button and switch back on.**

All DVD and audio settings are cleared.

故障排除提示

問題	措施
CD、DVD和VCD	
碟片裝入後自動彈出。	<ul style="list-style-type: none"> 請檢查碟片是否清潔及完好無損（第92頁）。 請確認碟片已正確安置於導軌中。 請檢查碟片是否含有相容的地區號碼（第12頁）。 本機內部可能結露。請等待一段時間使水汽蒸發。請勿在空調附近使用本機。
無法播放。	<ul style="list-style-type: none"> 請檢查碟片已正確裝入（帶標籤一面朝上）。
標記  出現在螢幕上。	<ul style="list-style-type: none"> 本系統禁止該操作。
標記  出現在螢幕上。	<ul style="list-style-type: none"> 所選功能不適用該碟片。
在設置OSD選單中進行更改時，顯示  。	<ul style="list-style-type: none"> 裝入的碟片是CD或VCD，而所更改的設置僅適用於DVD影碟。該設置在下次裝入DVD時有效。
影像播放停止，操作按鈕無法使用。	<ul style="list-style-type: none"> 關閉電源，然後再用前面板上的STANDBY/ON(待機/啓動)開關打開電源。
在設置畫面選單中所作的新設置對於正在播放的碟片無效。	<ul style="list-style-type: none"> 某些設置可以在播放碟片時進行，但祇有當碟片停止再重新開始播放時設置才會生效。這並非故障。請注意，在設置畫面選單中進行的設置可能會取消恢復功能。
設置被取消。	<ul style="list-style-type: none"> 如果因停電或拔離電源插頭而導致電源被切斷，則設置會被取消。
無影像/無顏色。	<ul style="list-style-type: none"> 請檢查視頻連接是否正確，插頭是否插牢。 請檢查電視機/監看器的設置是否正確。
畫面被拉伸或者縱橫比未改變。	<ul style="list-style-type: none"> 請確認Setup(設置)選單中的TV Screen(電視螢幕)選項的設置與您使用的電視機/監看器相符。
在播放中影像受到干擾或螢幕變黑。	<ul style="list-style-type: none"> 本機與Macro-Vision系統版權保護技術相容。某些碟片含有版權保護訊號，播放此類碟片時，影像的某些區域會出現條紋等干擾，具體情況因電視機而異。這並非故障。 某些碟片本身存在問題，當執行特定的功能時，可能會使螢幕出現短暫的變黑或輕微晃動現象。 出於版權保護的原因，若將本系統與錄影機或AV選擇器相連接可能會無法進行錄製或產生影像問題。這並非故障。
DVD和CD的音量之間有明顯的區別。	<ul style="list-style-type: none"> DVD和CD採用不同的錄音方式。這並非故障。

問題	措施
----	----

調諧器	
-----	--

收音機接收有噪音

- 請檢查頻率是否正確。
- 請檢查天線的連接是否正確。對於FM，請確認天線已完全拉出，並定位於最佳的接收位置。對於AM，確保環型天線指向最佳方位。
- 如果無線電訊號太弱，那麼使用室外天線一般比附帶的室內天線效果更佳。
- 其他諸如電視機、日光燈和馬達等電氣設備會引發干擾。請關閉或移開這些設備，或者移動天線試一下。
- 調諧間隔的幅度可能不適用您所在的國家或地區。請轉換調諧間隔幅度試一下（參見第90頁）。

自動調諧不能搜索某些電台。

- 自動調諧祇能檢測到訊號良好的電台。若要使調諧更靈敏，請連接室外天線。

MP3播放	
-------	--

含有MP3曲目的碟片不能播放。

- 如果碟片是可錄製CD，請確認該碟片已完成錄製。
- 請確認碟片是否與ISO 9660相容。

試圖開始播放時，顯示UNPLAYABLE MP3 FORMAT訊息。

- 請確認曲目是否是MPEG1音頻層3格式。
- 請確認曲目的取樣率是否是44.1或48kHz。

碟片中的某些曲目似乎被遺漏。

- 如果曲目名稱沒有以“.mp3”或“.MP3”結尾，則本系統識別不出它是MP3曲目。
- 本系統祇能識別一張碟片上的前250個檔案夾和曲目。如果檔案夾/曲目多於這個數字，則無法播放。
- 本系統與多段碟片不相容。如果播放此類碟片，則祇能播放第一段中錄製的曲目。

一般	
----	--

遙控器似乎不工作。

- 請確認遙控器在使用時處於其有效範圍之內，並且遙控器與主機感應器之間沒有障礙物。
- 請確認電池是否用完。

無聲音或聲音失真。

- 請確認已選擇正確的功能（DVD/CD等），音量已調高。
- 請確認MUTE功能沒有啟動，碟片沒有暫停播放。
- 請確認碟片是否清潔及完好無損（參見第93頁）。
- 請確認後面板所有的連接都正確無誤。
- 如果您發現插頭/端子已變髒或氧化，請予以清理。



注意

靜電等外界影響可能會使本機失靈。在此情況下，拔出電源線插頭，然後重新插上。如果問題仍然沒有解決，請就近諮詢Pioneer服務中心。

■ 系統復位

本系統復位後，可使所有選單、畫面和密碼設置均回復出廠時的默認設置。

- 1 用前面板上的**STANDBY/ON**開關將系統轉換至待機狀態。
- 2 按住前面板上的**■**按鈕，然後再打開本機。所有設置均被清除。

Specifications

Powered subwoofer (S-DV77SW)

Amplifier Section

Surround

Front, Center, Rear	30 W, per channel (1 kHz, 1% T.H.D., 8 Ω)
Subwoofer	50W (100Hz, 1% T.H.D., 4Ω)
Continuous power output (RMS)	
Front, Center, Rear	40W, per channel (1kHz, 10% T.H.D., 8Ω)
Subwoofer	65W (100Hz 10% T.H.D., 4Ω)

Power supply section

Power requirements

Multi voltage model ... AC 110-120 V/220-230V/240V
(Switchable), 50/60 Hz

Australian and New Zealand model
..... AC 240V, 50/60 Hz

Power consumption

Australian and New Zealand model 175 W

Round 2-pin AC plug model 165 W

Flat blade 2-pin AC plug model 410 W

Power consumption in standby mode 0.9 W

Subwoofer section

Powered subwoofer (S-DV77SW)

Type	Bass reflex floor type, antimagnetic (EIAJ)
Speaker	16 cm (6-5/16 in.) (cone type)
Nominal impedance	4 Ω
Frequency range	31 Hz to 300 Hz
Max. input	65 W (EIAJ)
Dimensions	190 (W) x 418 (D) x 420 (H) mm
Weight	13.9 kg

規格

有源副低音揚聲器(S-DV77SW)放大器部份

環繞聲

前、中、後	30W, 每聲道 (1kHz, 1% T.H.D., 8Ω)
副低音揚聲器	50W (100Hz, 1% T.H.D., 4Ω)
連續輸出功率 (RMS)	
前、中、後	40W, 每聲道 (1kHz, 10% T.H.D., 8Ω)
副低音揚聲器	65W (100Hz, 10% T.H.D., 4Ω)

電源部份

電源要求

多電壓機型 AC 110-120 V/220-230V/240V
(可開關電源), 50/60 Hz

澳大利亞和新西蘭的型號 240V, 50/60 Hz

功耗

澳大利亞和新西蘭的型號 175W

圓形2插頭 AC 插頭機型 165W

平刀口2插頭 AC 插頭機型 410W

待機模式下功耗 0.9W

副低音揚聲器部份

有源副低音揚聲器(S-DV77SW)

類型	低音反射底板型, 防磁 (EIAJ)
揚聲器	16cm (錐型)
額定阻抗	4 Ω
頻率範圍	31 Hz至300Hz
最大輸入	65W (EIAJ)
尺寸	190 (寬) × 418 (深) × 420 (高) mm
重量	13.9kg

Satellite speakers

Satellite speaker system (S-DV77ST)

Type	Sealed, antimagnetic (EIAJ)
Speaker	8.7cm (cone type)
Nominal impedance	8 Ω
Frequency range	100 to 20,000 Hz
Max. input	40 W (EIAJ)
Front, Rear speakers	
Dimensions	112 (W) x 77 (D) x 144 (H) mm
Weight	0.77 kg
Center speaker	
Dimensions	196 (W) x 76 (D) x 105 (H) mm
Weight	0.82 kg

DVD/CD Tuner (XV-DV77)

DVD Player (Audio) Section

S/N ratio	100 dB (EIAJ)
Dynamic range	97 dB (EIAJ)
Distortion	0.004%
Frequency response	
48 kHz sampling	4 Hz to 22 kHz
96 kHz sampling	4 Hz to 44 kHz
Wow & flutter	Below measurable levels (±0.001% W.PEAK)

DVD Player (Video) Section

Output level	1 Vp-p (75 Ω)
Video Y output level	1 Vp-p (75 Ω)
Video C output level	286 mVp-p (75 Ω)

DVD (Other jacks) Section

Digital optical output (PCM/Dolby/DTS) ...	Optical connector
Digital optical input (PCM/Dolby/DTS)	Optical connector

衛星揚聲器

衛星揚聲器(S-DV77ST)

類型	密封型, 防磁 (EIAJ)
揚聲器	8.7cm (錐型)
額定阻抗	8 Ω
頻率範圍	100至20,000Hz
最大輸入	40W(EIAJ)
前、後置揚聲器	
尺寸	112 (寬) × 77 (深) × 144 (高) mm
重量	0.77kg
中置揚聲器	
尺寸	196 (寬) × 76 (深) × 105 (高) mm
重量	0.82kg

DVD/CD播放機 (XV-DV77)

DVD播放機 (音頻) 部份

訊噪比	100dB (EIAJ)
動態範圍	97dB (EIAJ)
失真	0.004%
頻率響應	
48kHz取樣	4Hz至22kHz
96kHz取樣	4Hz至44kHz
抖晃度	低於可測限度 (±0.001%峰值)

DVD播放機 (視頻) 部份

輸出電平	1Vp-p (75 Ω)
視頻Y輸出電平	1Vp-p (75 Ω)
視頻C輸出電平	286mVp-p (75 Ω)

DVD (其他插口) 部份

數碼光纖輸出 (PCM/Dolby/DTS)	光纖連接器
數碼光纖輸入 (PCM/Dolby/DTS)	光纖連接器

Tuner Section

FM tuner	
Frequency range	87.5 MHz to 108.0 MHz
Antenna	75 Ω unbalanced
AM tuner	
Frequency range	530 kHz to 1,700 kHz (10 kHz step)
	522 kHz to 1,602 kHz (9 kHz step)
Antenna	loop antenna (supplied)

Miscellaneous

DVD/CD Tuner	
Dimensions	220 (W) x 317 (D) x 65 (H) mm
Weight	2.5 kg
Display unit	
Dimensions	206 (W) x 50 (D) x 65 (H) mm
Weight	0.2 kg
Operating conditions:	
Temperature	+5°C to +35°C
Humidity	5% to 85% (without condensation)

Supplied Items

Display unit	1
Remote control unit	1
AA/R6P dry cell batteries	2
AM loop antenna	1
FM antenna	1
Video cord	1
Power cord	1
Speaker cords (5m)	3
Speaker cords (10m)	2
Non-skid pads (Satellite)	19
Non-skid pads (subwoofer)	4
Control cable A	1
Control cable B	1
Display cable	1
Operating instructions (Setting up)	1
Operating instructions (Basic)	1

Note:

- Specifications and design subject to possible modification without notice, due improvements.

調諧器部份

FM調諧器	
頻率範圍	87.5MHz至108.0MHz
天線	75Ω不平衡
AM調諧器	
頻率範圍	530 kHz至1,700 kHz (10 kHz幅度)
	522 kHz至1,602 kHz (9 kHz幅度)
天線	環狀天線 (附帶)

其他

DVD/CD調諧器	
尺寸	220 (寬) × 317 (深) × 65 (高) mm
重量	2.5kg
顯示屏裝置	
尺寸	206 (寬) × 50 (深) × 65 (高) mm
重量	0.2kg
工作條件:	
溫度	+5°C至+35°C
濕度	5%至85% (無結露)

附件

顯示屏裝置	1
遙控器裝置	1
AA/R6乾電池	2
AM環狀天線	1
FM天線	1
視頻電纜	1
電源電纜	1
揚聲器電纜 (5m)	3
揚聲器電纜 (10m)	2
防滑墊 (衛星揚聲器)	19
防滑墊 (副低音揚聲器)	4
控制電纜A	1
控制電纜B	1
顯示屏電纜	1
使用說明書 (安裝)	1
使用說明書 (基本)	1

注意:

- 如若規格和設計因改進而發生變更，恕不另行通知。

■ Demo display

This system features a demonstration display. When the demo mode is on, the demo display automatically starts after the system is plugged in, or if it's inactive for more than five minutes in the DVD/CD function.

- 1 Switch the system into standby.**
- 2 Press SYSTEM MENU and select DEMO MODE.**
 - Change menu options using the ◀ and ▶ buttons. Press ENTER to select the currently displayed option.
- 3 Use the ▲ or ▼ button to select DEMO ON or DEMO OFF as required. Press ENTER.**

The system returns to standby.

■ 演示

本系統具有演示功能。如果演示模式已啓動，則在系統的插頭插入電源插座之後，或當系統處於DVD或CD播放模式下的閒置時間超過5分鐘時，演示將會自動開始進行。

- 1 將系統轉換至待機狀態。**
- 2 按SYSTEM MENU并選定DEMO MODE。**
 - 用◀和▶按鈕變更選單選項。按ENTER選定當前顯示的項目。
- 3 根據需要，用▲或▼按鈕選定DEMO ON 或 DEMO OFF。按 ENTER。**

系統返回待機狀態。

Published by Pioneer Corporation.
Copyright © 2001 Pioneer Corporation.
All rights reserved.

PIONEER CORPORATION 4-1, Meguro 1-Chome, Meguro-ku, Tokyo 153-8654, Japan
PIONEER ELECTRONICS [USA] INC. P.O. BOX 1540, Long Beach, California 90801-1540, U.S.A.
PIONEER ELECTRONICS OF CANADA, INC. 300 Allstate Parkway, Markham, Ontario L3R OP2, Canada
PIONEER EUROPE NV Haven 1087, Keetberglaan 1, B-9120 Melsele, Belgium TEL: 03/570.05.11
PIONEER ELECTRONICS AUSTRALIA PTY. LTD. 178-184 Boundary Road, Braeside, Victoria 3195, Australia, TEL: [03] 9586-6300
PIONEER ELECTRONICS DE MEXICO S.A. DE C.V. San Lorenzo 1009 3er Piso Desp. 302 Col. Del Valle Mexico D.F. C.P. 03100
TEL: 5-688-52-90

Free Manuals Download Website

<http://myh66.com>

<http://usermanuals.us>

<http://www.somanuals.com>

<http://www.4manuals.cc>

<http://www.manual-lib.com>

<http://www.404manual.com>

<http://www.luxmanual.com>

<http://aubethermostatmanual.com>

Golf course search by state

<http://golfingnear.com>

Email search by domain

<http://emailbydomain.com>

Auto manuals search

<http://auto.somanuals.com>

TV manuals search

<http://tv.somanuals.com>